

777

Flight Crew Training Manual

This document has EAR data with Export Control Classification Numbers (ECCN) of: 9E991

Export of this technology is controlled under the United States Export Administration Regulations (EAR) (15 CFR 730-774). An export license may be required before it is used for development, production or use by foreign persons from specific countries.

The controller of this data has the individual responsibility to abide by all export laws.

BOEING PROPRIETARY

Copyright © 1994 - 2010 The Boeing Company
All Rights Reserved

Boeing claims copyright in each page of this document only to the extent that the page contains copyrightable subject matter. Boeing also claims copyright in this document as a compilation and/or collective work.

This document includes proprietary information owned by The Boeing Company and/or one or more third parties. Treatment of the document and the information it contains is governed by contract with Boeing. For more information, contact The Boeing Company, P.O. Box 3707, Seattle Washington 98124.

APPROVED BY: _____ (Original signed by)

G. G. Botch
Chief Technical Pilot - 777

Continued on next page

Document Number FCT 777 (TM)
October 31, 2001

Revision Number: 8
Revision Date: June 30, 2010

Continued from previous page

APPROVED BY: (Original signed by)

M. F. Coker
Chief Pilot - Flight Training-Airplane

APPROVED BY: (Original signed by)

R. R. Roberts
Chief Pilot - Flight Standards

APPROVED BY: (Original signed by)

D. C. Carbaugh
Chief Pilot - Flight Technical

APPROVED BY: (Original signed by)

K. T. Otsuka
Chief Pilot - 777

APPROVED BY: (Original signed by)

J. M. Eitel
FAA Principal Operations Inspector

Copyright Information

The right to reproduce, distribute, display, and make derivative works from this document, or any portion thereof, requires a license from Boeing. For more information, contact The Boeing Company, P.O. Box 3707, Seattle, Washington 98124.



Title Page

Preface	0
Model Identification	0.1
Introduction	0.2
Abbreviations	0.3
Revision Record	0.4
List of Effective Pages	0.5
General Information	1
Ground Operations	2
Takeoff and Initial Climb	3
Climb, Cruise, Descent and Holding	4
Approach and Missed Approach	5
Landing	6
Maneuvers	7
Non-Normal Operations	8
Appendices	A
Operational Information	A.1
Supplemental Information	A.2
Index	Index



Intentionally
Blank



General

The airplane models listed in the table below are covered in this Flight Crew Training Manual.

Model
777-200
777-200LR
777-300
777-300ER

Model numbers are used to distinguish information peculiar to one or more, but not all of the airplanes. Where information applies to all models, no reference is made to individual model numbers.

If information is applicable to consecutively numbered models, a dash (–) is used in the model designator. For example, if information is applicable to 777-200 and 777-200LR and 777-300 models, but not the 777-300ER, the model designator will show 777-200 – 777-300.

If information is applicable to models that are not consecutively numbered, a comma (,) is used in the model designator. For example, if information is applicable to only 777-200 and 777-300ER models, the model designator will show 777-200, 777-300ER.

At this time there is no need for a unique model designator for the 777-200ER or the 777 Freighter. All information that is applicable for the 777-200 also applies to the 777-200ER. All information that is applicable for the 777-200LR also applies to the 777 Freighter, except as noted in the text. If in the future, a need for a 777-200ER or a 777 Freighter designator becomes necessary, it will be added.



Intentionally
Blank



General

The Flight Crew Training Manual provides information and recommendations on maneuvers and techniques. The manual is divided into eight chapters: General Information; Ground Operations; Takeoff and Initial Climb; Climb, Cruise, Descent and Holding; Approach and Missed Approach; Landing; Maneuvers; and Non-Normal Operations.

General Information covers procedures and techniques not associated with a particular maneuver or phase of flight. Ground Operations covers information associated with airplane preflight, engine starting and taxi operations including taxi operations in adverse weather conditions. Chapters 3 through 6 are titled by phase-of-flight and contain information about airplane operations in each phase. The Maneuvers chapter covers maneuvers associated with climb, cruise, and descent, i.e., stall recovery and emergency descent. The Non-Normal Procedures chapter covers non-normal situations that may occur during any phase of flight. Each of the chapters has a preface which describes the chapter in more detail. This manual also contains two appendices. Appendix A - Section 1, Operational Information is available for the operator to use as desired. It provides a convenient location to supplement the FCTM with operator specific information. Appendix A - Section 2, Supplemental Information contains information for the operations staff of organizations rather than individual pilots. These are considerations for each operator to evaluate and use as they see fit for their operations. The operator may wish to remove this appendix before distributing the manual to their pilots.

Note: In the event of a conflict, the procedures and restrictions published in the FCOM, QRH, ECL, MMEL/MEL, or DDG take precedence over the information, techniques, and recommendations in the FCTM.

Note: Figures in this manual are to be used for training purposes only. This data is not suitable as a basis for performance calculations or other engineering purposes.

Note: It is the responsibility of the individual airline to determine applicability of this manual to its operation.

Any questions about the content or use of this manual can be directed to:

Chief Pilot - Flight Technical
Flight Crew Operations
Boeing Commercial Airplane Group
P. O. Box 3707, M/C 14-HA
Seattle, Washington 98124-2207 USA

Regulatory Agencies

Regulatory information in this manual is based upon FAA regulations and requirements unless otherwise indicated. Other regulatory agencies may have different regulations and requirements that need to be addressed by non-FAA operators. Examples of regulations and requirements include, but are not limited to, FAR takeoff field requirements, airplane approach categories, and low visibility approach criteria.

Airplane Configuration

The Flight Crew Training Manual (FCTM) is intended to provide information in support of procedures listed in the Flight Crew Operations Manual (FCOM) and techniques to help the pilot accomplish these procedures safely and efficiently. The FCTM is written in a format that is more general than the FCOM. It does not account for airplane configuration differences, unless these differences have an impact on the procedure or technique being discussed. For example, the FCTM states, "When the flaps are retracted and the airspeed approaches maneuvering speed, ensure CLB thrust is set." This statement is not intended to tell the crew how to set climb thrust, only to emphasize that the flight crew must ensure that CLB thrust is set. It is recognized that crew actions required to set climb thrust are different in different models. Reference to the applicable FCOM is required for information on how to set climb thrust.

In cases where a procedure or technique is applicable only to an airplane with a specific configuration, the annotation "as installed" is used. Airplane configuration differences are found in the FCOM.

**General**

The following abbreviations may be found throughout the manual. Some abbreviations may also appear in lowercase letters. Abbreviations having very limited use are explained in the chapter where they are used.

A	
AC	Alternating Current
ACT	Active
ADF	Automatic Direction Finder
ADI	Attitude Director Indicator
ADIRU	Air Data Inertial Reference Unit
AFDS	Autopilot Flight Director System
AFE	Above Field Elevation
AFM	Airplane Flight Manual (FAA approved)
AFM - DPI	Airplane Flight Manual - Digital Performance Information
AGL	Above Ground Level
AH	Alert Height
ALT ACQ	Altitude Acquire
ALT HOLD	Altitude Hold
AMM	Aircraft Maintenance Manual
ANP	Actual Navigation Performance
AOA	Angle of Attack

A/P	Autopilot
APU	Auxiliary Power Unit
AR	Authorization Required
ASA	Autoland Status Annunciator
ASI	Airspeed Indicator
ASR	Airport Surveillance Radar
A/T	Autothrottle
ATC	Air Traffic Control
ATM	Assumed Temperature Method
B	
BARO	Barometric
B/CRS B/C	Back Course
C	
C	Captain Celsius Center
CAA	Civil Aviation Authority
CDFA	Continuous Descent Final Approach
CDU	Control Display Unit
CFIT	Controlled Flight Into Terrain

777 Flight Crew Training Manual

CFP	Computer Flight Plan
CG	Center of Gravity
CLB	Climb
CMD	Command
CON	Continuous
CRM	Crew Resource Management
CRT	Cathode Ray Tube
CRZ	Cruise
CWS	Control Wheel Steering
D	
DA	Decision Altitude
DA(H)	Decision Altitude (Height)
D/D	Direct Descent
DDG	Dispatch Deviations Guide
DES	Descent
DIR	Direct
DME	Distance Measuring Equipment
E	
EADI	Electronic Attitude Director Indicator
EASA	European Aviation Safety Agency
ECL	Electronic Checklist
ECON	Economy
EEC	Electronic Engine Control
EFB	Electronic Flight Bag
EFIS	Electronic Flight Instrument System

EGT	Exhaust Gas Temperature
EHSI	Electronic Horizontal Situation Indicator
EICAS	Engine Indication and Crew Alerting System
ENG OUT	Engine Out
EOT	Engine Out Taxi
EPR	Engine Pressure Ratio
ETOPS	Extended Operations
EXT	Extend
F	
F	Fahrenheit
FAC	Final Approach Course
FCOM	Flight Crew Operations Manual
F/D	Flight Director
FAA	Federal Aviation Administration
FAF	Final Approach Fix
FAR	Federal Aviation Regulation
FCC	Flight Control Computer
FLCH	Flight Level Change
FMA	Flight Mode Annunciations
FMC	Flight Management Computer
FMS	Flight Management System
F/O	First Officer
FPA	Flight Path Angle
FPM	Feet Per Minute
FPV	Flight Path Vector

777 Flight Crew Training Manual

ft	Foot or Feet
G	
GA	Go-Around
GBAS	Ground-Based Augmentation System
GLS	GBAS Landing System
GNSS	Global Navigation Satellite System
GP	Glide Path
GPS	Global Positioning System
GPWS	Ground Proximity Warning System
G/S	Glide Slope
GS	Ground Speed
H	
HAA	Height Above Airport
HAT	Height Above Touchdown
HDG SEL	Heading Select
HSI	Horizontal Situation Indicator
HUD	Head Up Display
I	
IAF	Initial Approach Fix
IAN	Integrated Approach Navigation
IAS	Indicated Airspeed
ICAO	International Civil Aviation Organization
IFR	Instrument Flight Rules
IGS	Instrument Guidance System

ILS	Instrument Landing System
IM	Inner Marker
IMC	Instrument Meteorological Conditions
IP	Instructor Pilot
IRS	Inertial Reference System
IRU	Inertial Reference Unit
ISA	International Standard Atmosphere
ISFD	Integrated Standby Flight Display
J	
JAA	Joint Aviation Authority
K	
K	Knots
KCAS	Knots Calibrated Airspeed
KGS	Kilograms
KIAS	Knots Indicated Airspeed
L	
LBS	Pounds
LDA	Localizer-type Directional Aid
LNAV	Lateral Navigation
LOC	Localizer
LRC	Long Range Cruise
LVL CHG	Level Change
M	
M	Mach
m	Meters
MAP	Missed Approach Point

MASI	Mach/Airspeed Indicator
MAX	Maximum
MCP	Mode Control Panel
MCT	Maximum Continuous Thrust
MDA(H)	Minimum Descent Altitude (Height)
MEA	Minimum Enroute Altitude
MEL	Minimum Equipment List
MFD	Multifunction Display
MM	Middle Marker
MMO	Maximum Mach Operating Speed
MOCA	Minimum Obstruction Clearance Altitude
MOD	Modify
MORA	Minimum Off Route Altitude
MSL	Mean Sea Level
N	
NAV	Navigation
NAV RAD	Navigation Radio
ND	Navigation Display
NM	Nautical Mile(s)
NNC	Non-Normal Checklist
NNM	Non-Normal Maneuver
NPS	Navigation Performance Scales
N1	Low Pressure Rotor Speed
N2	High Pressure Rotor Speed

O	
OAT	Outside Air Temperature
OM	Outer Marker
OPT	Onboard Performance Tool
P	
PAPI	Precision Approach Path Indicator
PAR	Precision Approach Radar
PF	Pilot Flying
PFD	Primary Flight Display
PI	Performance Inflight
PIP	Product Improvement Package
PLI	Pitch Limit Indicator
PMC	Power Management Control
PM	Pilot Monitoring
PWS	Predictive Windshear System
Q	
QRH	Quick Reference Handbook
R	
RA	Radio Altitude Resolution Advisory
RAIM	Receiver Autonomous Integrity Monitoring
RAT	Ram Air Turbine
RDMI	Radio Distance Magnetic Indicator
RMI	Radio Magnetic Indicator
RNAV	Area Navigation

777 Flight Crew Training Manual

RNP	Required Navigation Performance
RSEP	Rudder System Enhancement Program
RTO	Rejected Takeoff
RVR	Runway Visual Range
RVSM	Reduced Vertical Separation Minimum
S	
SAAAR	Special Aircraft and Aircrew Authorization Required
SAT	Static Air Temperature
SDF	Simplified Directional Facility
SFP	Short Field Performance
SPD	Speed
STAR	Standard Terminal Arrival Route
T	
T	True
TA	Traffic Advisory or Tailored Arrival
TAC	Thrust Asymmetry Compensation
TACAN	Tactical Air Navigation
TAS	True Airspeed
TAT	Total Air Temperature
TCAS	Traffic Alert and Collision Avoidance System
TE	Trailing Edge
TFC	Traffic

TO	Takeoff
T/D	Top of Descent
TO/GA	Takeoff /Go-Around
TPR	Turbofan Power Ratio
TR	Traffic Resolution
TRK	Track
U	
U.S.	United States
V	
VASI	Visual Approach Slope Indicator
VDP	Visual Descent Point
VEF	Speed at Engine Failure
VFR	Visual Flight Rules
VHF	Very High Frequency
VLOF	Lift Off Speed
VMC	Visual Meteorological Conditions
VMCA	Minimum Control Speed Air
VMCG	Minimum Control Speed Ground
VMO	Maximum Operating Speed
VNAV	Vertical Navigation
VOR	VHF Omnidirectional Range
VR	Rotation Speed
VREF	Reference Speed
V/S	Vertical Speed
VSD	Vertical Situation Display
VSI	Vertical Speed Indicator



777 Flight Crew Training Manual

VTK	Vertical Track
V1	Takeoff Decision Speed
V2	Takeoff Safety Speed
W	
WGS-84	World Geodetic system of 1984
WPT	Waypoint
X	
XTK	Cross Track



Revision Transmittal Letter

To: All holders of the 777 Flight Crew Training Manual, Boeing Document Number FCT 777 (TM).

Subject: Flight Crew Training Manual Revision.

This revision reflects the most current information available to The Boeing Company 45 days before the subject revision date. The following revision highlights explain changes in this revision. General information below explains the use of revision bars to identify new or revised information.

Revision Record

No.	Revision Date	Date Filed	No.	Revision Date	Date Filed
Initial	October 31, 2001		1	October 31, 2002	
2	October 31, 2003		3	October 31, 2004	
4	October 31, 2005		5	October 31, 2006	
6	October 31, 2007		7	October 31, 2008	
8	June 30, 2010				

General

The Boeing Company issues flight crew training manual revisions to provide new or revised recommendations on maneuvers and techniques, or information supporting changes to FCOM procedures. Revisions may also incorporate appropriate information from previously issued flight operations technical bulletins.

Formal revisions include a new Revision Record, Revision Highlights, and a current List of Effective Pages. Use the information on the new Revision Record and List of Effective Pages to verify the Flight Crew Training Manual content.

Pages containing revised technical material have revision bars associated with the changed text or illustration. Editorial revisions (for example, spelling corrections) may have revision bars with no associated highlight.

This revised Flight Crew Training Manual is provided in quantities as specified in each operator's contract.

Additional copies of this manual are available through the Boeing Data and Services Management (DSM) Catalog. This manual is also available in FRAME© format for use in airline modification. Advise if information about FRAME© format is required.

Filing Instructions

This revision is a complete reprint of the FCTM as indicated on the List of Effective Pages (0.5). Remove all old pages and replace all new pages. However, retain all tabs. There are no replacement tabs included with this revision.

Revision Highlights

This section (0.4) replaces the existing section 0.4 in your manual.

This manual is published from a database; the text and illustrations are marked with configuration information. Occasionally, because database markers are rearranged, or because items are marked with configuration information due to the additions of new database content, some pages may contain revision bars when content appears to be unchanged. Pages may also be republished without revision bars due to slight changes in the flow of the document.

Chapter 0 - Preface

Section 1 - Model Identification

0.1.1 - Added clarification of when model numbers are used.

0.1.1 - Added reference to the 777 Freighter.

Section 2 - Introduction

General

0.2.1 - Added clarification that if a conflict exists, the procedures and restrictions published in the FCOM, QRH, ECL, MMEL/MEL, or DDG take precedence over what is published in the FCTM.

Section 3 - Abbreviations

0.3.3 - Modified definition of GLS to align with the ICAO standard.

Section 4 - Revision Record

0.4.1 - New section added similar to that published in the FCOM.

Chapter 1 - General Information

Maneuver Speeds and Margins

- 1.4 - Moved information about flap settings during takeoff to chapter 3. Moved information about flap usage while maneuvering for an approach to chapter 5. Moved information about flap usage for normal landings to chapter 6. Changed section title to more accurately reflect section contents.

Minimum Maneuver Speed

- 1.5 - Relocated note.
- 1.5 - Replaced the table that described the Amber Band with graphics.
- 1.6 - Clarified text concerning the amber band above 20,000 feet for clarity and to match FCOM text.

Maneuver Margins to Stick Shaker

- 1.7 - Removed term "transition" speed and replaced it with "retraction" or "extension" speed as appropriate.
- 1.8 - Added that when the speedbrakes are extended, the maneuver margin to stick shaker is reduced.
- 1.10 - Removed section titled Flap Operation. This section discussed acceleration height after takeoff for all engines and engine out conditions. Moved information from this section to chapter 3.

Landing

- 1.11 - Added a technique pilots should consider when a manual landing is planned with the autothrottle connected in gusty or high wind conditions.
- 1.11 - Moved the sentence explaining that the minimum command speed setting with the autothrottle disconnected is VREF + 5 knots from later in the section.
- 1.12 - Moved paragraph to other locations. The sentence on minimum command speed setting moved to a location earlier in this section. The sentence on maintaining the gust correction until touchdown was moved to chapter 6.
- 1.12 - Changed "wind corrections" to "wind additives" in several places to make text consistent.

Non-Normal Conditions

- 1.12 - Removed the term "adjusted" VREF. The FCTM used this term to describe a VREF that has been modified by a NNC, but this term is causing some confusion since it is not found in other Flight Operations publications. A VREF that has been adjusted by a NNC is simply called VREF.

1.12 - Added a paragraph to clarify how the command speed is set for non-normal conditions when using the autothrottle.

Reference Speed Setting

1.13 - Changed "gross weight" to "zero fuel weight" to avoid any implication that gross weight is entered by the pilot. Placed FMC entries in the order that they are done in Normal Procedures.

Thrust Management

1.14 - Added a section to define some of the terms used in conjunction with thrust management in the FCTM and FCOM.

Standard Callouts

1.16 - Corrected Climb and Descent callouts to match the FCOM.

Terminal Charts

1.21 - Changed sentence to reflect that enroute charts may be available in the EFB.

Flight Path Vector

1.22 - Added a technique for using the FPV during visual traffic patterns to maintain level flight.

1.22 - Added a technique for using the FPV on final approach to help detect a downburst or to provide an indication of wind direction.

Basic RNP Concept

1.29 - Referring flight crews go to the RNAV(RNP) SAAAR/AR section of the FCTM for this type of operation.

1.30-31 - Expanded this section to incorporate the use of Navigation Performance Scales (NPS) and how to fly RNP operation for airplanes with and without NPS.

1.31 - Clarified discussion on ANP alerts.

MCP Altitude Setting Techniques Using VNAV

1.36 - Removed unnecessary text and reformatted section for clarity.

1.36 - Removed information about climbs and descents in pitch modes other than VNAV PTH or VNAV SPD. This section only provides techniques to be used when using VNAV. Information about pitch modes other than VNAV is contained in the sections titled Climb Constraints in chapter 4.

1.36 - Added reference to VNAV in the title for the normal altitude setting technique.

1.36 - Replaced the text with a diagram to help clarify the normal MCP altitude setting technique.

777 Flight Crew Training Manual

1.36 - Added reference to VNAV in the title for the alternate altitude setting technique.

1.37 - Added Tailored Arrivals (TA) as a situation where the use of the alternate MCP altitude setting technique may be appropriate.

1.37 - Added a diagram to help clarify the alternate MCP altitude setting technique.

1.37 - Added a note to emphasize that each altitude constraint should be checked against the VNAV path even though the altitude constraint is not always entered in the MCP.

Chapter 2 - Ground Operations**Tiller/Rudder Pedal Steering**

2.7 - Removed systems information describing when body gear steering is automatically activated. This information is found in the FCOM. Added considerations if main gear aft axle steering is inoperative.

Turning Radius and Gear Tracking

2.7 - Modified diagram to more accurately show the nose and main gear track.

Taxi - Adverse Weather

2.14 - Deleted paragraph about exercising the nose gear steering during taxi. This was deleted from the Cold Weather Operations Supplementary Procedure because engineering confirmed it was not required.

Chapter 3 - Takeoff and Initial Climb**Takeoff Flap Setting**

3.3 - Added new section. Information in this section was previously located in chapter 1. This information is more appropriately located in the takeoff phase of flight, chapter 3.

Initiating Takeoff Roll

3.6 - Moved information about how to obtain Full Rated Thrust to the Reduced Thrust Takeoff section.

Rotation and Liftoff - All Engines

3.7 - Relocated the note to a position more in sequence with the takeoff.

3.7 - Modified the note by replacing "rotation rates" with "control forces". As stated in the preceding paragraph, the rotation rates may differ slightly depending upon airplane body length.

3.8 - Moved information about minimum tail clearance for takeoff flap settings to a new section titled "Takeoff Flap Setting" earlier in this chapter.

Reduced and Derated Takeoff Thrust

3.14 - Changed "potential" to "suspected" to match the text in the Windshear Supplementary Procedure of the FCOM.

Reduced Takeoff Thrust (ATM)

3.15 - Added a note to inform the crew that the ATM may permit a lower takeoff weight when airplane controllability is limited by the Minimum Takeoff Weight requirement.

Adverse Runway Conditions

3.17 - Modified the metric unit from "12.7 mm" to "13" mm. This matches the text in chapter SP.16 of the FCOM.

Initial Climb - All Engines

3.26 - Simplified the text about automatic wheel braking during gear retraction. Reference the FCOM for more detailed information if desired.

Flap Retraction Schedule

3.28 - Added information about acceleration height removed from chapter 1. This information is more appropriately located in the takeoff phase of flight, chapter 3.

3.28 - Modified Flap Retraction Speed Schedule to match the table in the FCOM.

Flap Retraction - One Engine Inoperative

3.34 - Added information about acceleration height removed from chapter 1. This information is more appropriately located in the takeoff phase of flight, chapter 3.

3.34 - Changed text to takeoff flap retraction speed schedule to match the title of this schedule in the FCOM and FCTM.

Chapter 4 - Climb, Cruise, Descent and Holding

Climb Constraints

4.1-2 - Modified text to remove conflicts with the "MCP Altitude Setting Techniques using VNAV" section in chapter 1.

Engine Inoperative Climb

4.4 - Changed the definition of the recommended engine inoperative climb speed from "maximum angle climb speed" to "maximum climb gradient". The recommended engine inoperative climb speed is not the same as the displayed FMC/CDU Max Angle Climb Speed.

777 Flight Crew Training Manual

Cruise Speed Determination

4.8 - Added reference to tailwind component because the FMC calculates ECON speeds using both headwind and tailwind components.

Cruise Performance Economy

4.11 - Clarified that the cruise fuel penalties provided in the FCTM are intended to be generic estimates for crew knowledge only. Actual flight planning figures should be obtained from Flight Planning and Performance Manual for the specific airplane.

High Altitude High Speed Flight

4.13 - Modified section to identify specific conditions where over controlling has been a problem.

ETOPS

4.14 - Corrected definition of ETOPS.

Polar Operations

4.16 - Added reference to loss of GPS updating which occurs automatically at some latitudes.

Descent Constraints

4.18-19 - Modified text to remove conflicts with the "MCP Altitude Setting Techniques using VNAV" section in chapter 1.

Chapter 5 - Approach and Missed Approach**Stabilized Approach Recommendations**

5.4 - Modified the airspeed recommendation on final approach to use approach speed as the baseline instead of VREF. This allows a more reasonable tolerance if wind conditions required an approach speed of VREF plus significant additives for wind.

Mandatory Missed Approach

5.5 - Clarified when a missed approach is required for airplanes with NPS.

Flap Configurations for Approach and Landing

5.6 - Added new section containing information from earlier in this chapter and information removed from chapter 6.

Flap Setting for Lading

5.6 - Modified section to include information removed from chapter 1. This information is more appropriately located in the Approach phase of flight, chapter 5. Removed text that stated flaps 30 provides additional aft body clearance (over flaps 25). This is not always true. Touchdown body clearance can be seen in the Touchdown Body Attitude figures.

Flap Extension

5.7 - Removed reference to VREF speeds.

Approach

5.15 - Added guidance to provide the crew a method for safely intercepting the glide slope from above.

Instrument Approach - RNAV (RNP) SAAAR/AR

5.47 - Removed the recommended flap settings for maneuvering before the airplane is established on final approach. Flap positions may need to be adjusted to comply with published speed restrictions. Added instructions for the pilot to position flaps as needed to comply with published speed restrictions. Changed title of the last block from MDA(H) to DA(H).

5.48 - Modified text for airplanes with and without FMC Block Point 14. Airplanes with BP14 are now able to inhibit DME-DME updating.

5.50 - Removed unnecessary text.

Circling Approach

5.52 - Added "HDG HOLD" and "TRK HOLD" to the recommended lateral modes for the maneuvering portion of the circling approach.

Circling Approach - General

5.53 - Section reorganized to more clearly identify what phase of the approach (instrument approach procedure or maneuvering portion of the circling approach) is being discussed.

5.53 - Added "VNAV ALT" to the modes that may be active when setting the missed approach altitude.

Engine Failure During Go-Around and Missed Approach

5.66 - Modified text to incorporate information from Boeing Flight Operations Review 777-09, dated November 21, 2007. This Flight Operations Review message emphasized that if an engine fails during a go-around, it is important that airspeed loss be recovered to prevent a high asymmetric thrust condition at lower than recommended airspeed.

Chapter 6 - Landing

Preface

6.1 - Moved information on flap configurations for approach and landing to chapter 5. Moved information on non-normal landing configuration distance to the Factors Affecting Landing Distance section later in this chapter.

Flare and Touchdown

6.8 - Added a technique pilots should consider when planning a manual landing from an automatic approach. This recommendation is taken from a presentation on industry best practices about techniques to help prevent hard landing.

Airspeed Control

6.9 - Added a section to clarify how wind additives are managed during the flare and touchdown.

Landing Flare Profile

6.9 - Changed VREF 30 + 0 (landing) to VREF 30 + 0 (touchdown) for clarity.

Normal Touchdown Attitude

6.10 - Added tail clearance for flaps 25. Moved section discussing proper airspeed control and thrust management to section titled Airspeed Control.

6.11-14 - Modified graphics to provide kilograms only figures for each model variant. Added touchdown attitude plots for flaps 25 landing.

6.15-18 - Modified graphics to provide pounds only figures for each model variant. Added touchdown attitude plots for flaps 25 landing.

6.19 - Removed section titled Body Clearance at Touchdown and the associated figures. Body clearance at various pitch angles is of little value and a survey of instructors found that these figures were rarely used. Body or tail skid contact (as applicable) is found in the preceding figure titled Touchdown Body Attitudes. This figure also relates pitch attitude to airspeed as a function of gross weight. Additionally, the Pitch and Roll Limit Conditions figures show ground contact angles of airplane structure during various pitch and roll combinations.

Bounced Landing Recovery

6.24 - Section moved to follow normal touchdown sections.

6.24 - Modified text for clarity.

6.24 - Added an explanation of speedbrake operation on a bounce.

Rejected Landing

6.25 - Section moved to follow normal touchdown sections.

Speedbrakes

6.26 - Removed the first paragraph in the section that described how the speedbrake system operates. How the speedbrake system operates is more accurately described in the FCOM.

Factors Affecting Landing Distance

6.28 - Section moved here from earlier in the chapter.

6.28 - Added reference to possible degraded capability of deceleration devices.

Reverse Thrust Operation

6.36 - Added an explanation of why a reduction to reverse idle is recommended between 60 knots and taxi speed.

6.36 - Moved the recommendation to select reverse idle quickly if an engine surges during reverse thrust operation to a note for emphasis.

Overweight Landing

6.42 - Modified section to reflect the change made to the 777 Overweight Landing NNC. The text for the 777-200 and -300 is now the same as that previously published for the 777-200LR and 777-300ER.

Chapter 7 - Maneuvers

Resolution Advisory

7.15 - Removed the text indicating that RA commands do not need to be followed if visual contact indicates other action. In accordance with PANS-OPS, visual acquisition is not longer an acceptable reason not to follow an RA.

Chapter 8 - Non-Normal Operations

Preface

8.1 - Modified title of QRH section CI.2 to match the recently changed title in the QRH.

Troubleshooting

8.2 - Expanded the definition of troubleshooting and clarified the examples.

8.2 - Modified text to clarify that troubleshooting is in reference to steps beyond those contained in the NNC.

777 Flight Crew Training Manual

Initiate Evacuation

8.5 - Modified order of events to match the EVACUATION NNC.

Electrical

8.5 - Deleted section titled Approach and Landing on Standby Power. System design makes the probability of an approach and landing on standby power very remote.

Loss of Engine Thrust Control

8.6 - Moved the NNC title to the first paragraph of the section.

8.6 - Modified the description of the condition to match the condition statement in the QRH.

Recommended Technique for an In-Flight Engine Shutdown

8.8 - Added reference to a "coordinated confirmation" step for clarity.

Bird Strikes

8.8 - Added new section to provide recommendations and considerations for bird strikes that might affect the engines.

Leading Edge or Trailing Edge Device Malfunctions

8.12 - Removed the term "adjusted" VREF. The FCTM used this term to describe a VREF that has been modified by a NNC, but this term is causing some confusion since it is not found in other Flight Operations publications. A VREF that has been adjusted by a NNC is simply called VREF.

Jammed Flight Controls

8.13 - Changed title to match title of the NNC.

8.13 - Removed reference to flight controls jammed due to ice accumulation. This is unlikely to occur in airplanes with fly by wire flight control systems.

8.14 - Changed "Jammed Control Surface" to "Jammed Control". This is more generic and covers anything from controls though the surface.

8.14 - Modified the stabilizer input for clarity.

Hydraulic System(s) Inoperative - Landing

8.19 - Removed the term "adjusted" VREF. The FCTM used this term to describe a VREF that has been modified by a NNC, but this term is causing some confusion since it is not found in other Flight Operations publications. A VREF that has been adjusted by a NNC is simply called VREF.

Overspeed

8.23 - Deleted reference to windshear encounters as a cause for overspeed during cruise at high altitude to prevent association and possible confusion with microburst activity at lower altitude.

8.24 - Expanded the details of how the speedbrake may be used to reduce speed.

8.24 - Removed section titled Passenger Oxygen On. Managing and equipping an airplane for gaseous oxygen use for routes requiring supplemental oxygen is a dispatch and airline SOP operational requirement.

Warning Systems

8.28 - Added new section to address pilot response to unexpected configuration or GPWS alerts.

Chapter A - Appendices

Section 2 - Supplemental Information

MCP Altitude Setting Techniques Using VNAV

A.2.2 - Added Tailored Arrivals (TA) as a situation where operators may approve the use of the alternate MCP altitude setting technique.

Polar Operations

A.2.5 - Modified text to indicate that the list of equipment and document needs is not necessarily all inclusive.

A.2.5 - Modified text to comply with Advisory Circular 120-42B.

Recommended Technique for an In-Flight Engine Shutdown

A.2.8 - Removed the section titled Passenger Oxygen On.

**Preface****Chapter 0****List of Effective Pages****Section 5**

Page	Date
FCTM	
* Title Page	June 30, 2010
* Copyright	June 30, 2010
* 0.TOC.TOC.1-2	June 30, 2010
* 0.1.1-2	June 30, 2010
* 0.2.1-2	June 30, 2010
* 0.3.1-6	June 30, 2010
Revision Record (tab)	
* 0.4.1-12	June 30, 2010
List of Effective Pages	
* 0.5.1-2	June 30, 2010
General Information (tab)	
* 1.TOC.1-4	June 30, 2010
* 1.1-42	June 30, 2010
Ground Operations (tab)	
* 2.TOC.1-2	June 30, 2010
* 2.1-16	June 30, 2010
Takeoff, Initial Climb (tab)	
* 3.TOC.1-2	June 30, 2010
* 3.1-36	June 30, 2010
Climb, Cruise, Descent, Holding (tab)	
* 4.TOC.1-2	June 30, 2010
* 4.1-24	June 30, 2010
Approach, Missed Approach (tab)	
* 5.TOC.1-4	June 30, 2010
* 5.1-66	June 30, 2010

Page	Date
Landing (tab)	
* 6.TOC.1-2	June 30, 2010
* 6.1-44	June 30, 2010
Maneuvers (tab)	
* 7.TOC.1-2	June 30, 2010
* 7.1-22	June 30, 2010
Non-Normal Operations (tab)	
* 8.TOC.1-4	June 30, 2010
* 8.1-34	June 30, 2010
Appendices (tab)	
* A.1.1-2	June 30, 2010
* A.2.1-8	June 30, 2010
Index (tab)	
* Index.1-10	June 30, 2010

* = Revised, Added, or Deleted

Copyright © The Boeing Company. See title page for details.



Intentionally
Blank

* = Revised, Added, or Deleted



Preface 1.1

Operational Philosophy 1.1

 Events Requiring Maintenance Inspection 1.1

Training Objectives 1.2

Qualification Requirements (Checkride) 1.2

 Evaluation 1.2

Crew Resource Management 1.2

Headphone and Flight Deck Speaker Use 1.3

Synoptic Display 1.3

Maneuver Speeds and Margins 1.4

 Flap Maneuver Speeds 1.4

 Minimum Maneuver Speed 1.4

 Maneuver Margins to Stick Shaker 1.7

Command Speed 1.11

 Takeoff 1.11

 Climb, Cruise and Descent 1.11

 Approach 1.11

 Landing 1.11

 Non-Normal Conditions 1.12

Reference Speeds 1.13

 Reference Speed Setting 1.13

Thrust Management 1.14

 Setting Thrust 1.14

 Maximum Thrust 1.14

Callouts	1.15
Standard Callouts	1.16
Standard Phraseology	1.19
Electronic Flight Bag	1.20
Airport Moving Map	1.20
Terminal Charts	1.21
Airplane Performance	1.21
Video Surveillance	1.21
Electronic Logbook and Other Documents	1.21
Flight Path Vector	1.21
Cold Temperature Altitude Corrections	1.22
Operation in Icing Conditions	1.23
Training Flights	1.23
Recommended Rudder Trim Technique	1.24
Drag Factors Due to Trim Technique	1.24
Primary Rudder Trim Technique	1.24
Alternate Rudder Trim Technique	1.25
Flight Management Computer(s)/CDUs	1.26
FMC Route Verification Techniques	1.26
FMC Performance Predictions - Non-Normal Configuration	1.26
RNAV Operations	1.27
RNP and ANP Definitions	1.28
Basic RNP Concept	1.29
GPS Use in Non-WGS-84 Reference Datum Airspace	1.33
Weather Radar and Terrain Display Policy	1.33
AFDS Guidelines	1.33
Autothrottle Use	1.34



777 Flight Crew Training Manual

Manual Flight	1.34
Automatic Flight	1.34
MCP Altitude Setting Techniques Using VNAV	1.35
AFDS Mode Control Panel Faults	1.37
Pilot Incapacitation	1.38
Crew Action Upon Confirming Pilot Incapacitation.	1.39
Turbulent Air Penetration.....	1.39
Electronic Flight Control System	1.39
Handling Characteristics	1.41



Intentionally
Blank



Preface

This chapter outlines Boeing operational policies used during training. Recommended procedures for Crew Coordination, Flap/Speed Schedule, Thrust Management, Turbulent Air Penetration, and Crew Resource Management are covered. This provides a basis for standardization. Conditions beyond the control of the flight crew may preclude following a maneuver exactly. The maneuvers are not intended to replace good judgment and logic.

Operational Philosophy

The normal procedures are designed for use by trained flight crewmembers. The procedure sequence follows a definitive panel scan pattern. Each crewmember is assigned a flight deck area to initiate action in accordance with Normal and Supplementary Procedures. Non-normal procedural actions and actions outside the crewmembers' area of responsibility are initiated at the direction of the captain.

Non-normal checklists are provided to cope with or resolve non-normal situations on the ground or in flight.

Supplementary Procedures are accomplished as required rather than on each flight sector. They are not included in the Quick Reference Handbook (QRH).

Status messages are checked during preflight to assess acceptability of the airplane for dispatch. After engine start it is not necessary to check the Status page as any message having adverse effect on safe continuation of the flight, requiring crew attention appears as an EICAS alert message. Status messages are checked after engine shutdown to determine if maintenance action should be initiated prior to the next flight.

Events Requiring Maintenance Inspection

[Appendix A.2.1](#)

During ground or flight operations, events may occur which require a maintenance inspection after flight. Many operators have procedures or policies providing guidance to help the crew determine what events should be documented.

In the absence of operator specific procedures or policies, use the following guidance to determine what events require a maintenance inspection:

- hard landing
- severe turbulence
- overspeed - flap/slat, MMO/VMO, landing gear, landing gear tires
- high-energy stop (refer to the AMM for guidance)



- lightning strike
- extreme dust
- tail strike
- overweight landing
- any event that the pilot feels a maintenance inspection could be needed. An example of such an event is an overly aggressive pitch up during a TCAS event or a Terrain Avoidance maneuver that could cause structural damage.

Note: If in doubt, the best course of action is to report it.

Training Objectives

The flight-training program prepares the student for airplane qualification and/or the FAA rating checkride (or equivalent). Flight safety, passenger comfort and operational efficiency are emphasized.

Qualification Requirements (Checkride)

Following satisfactory completion of transition training and when recommended by an authorized instructor, each pilot must satisfactorily demonstrate the ability to perform maneuvers and procedures prescribed in FAA or other applicable governing regulations. Throughout the prescribed maneuvers, command ability and good judgment commensurate with a high level of safety must be demonstrated. In determining whether such judgment has been shown, the evaluator considers adherence to approved procedures, actions based on the analysis of situations, and care and prudence in selecting the course of action.

Evaluation

An evaluation may be given at the end of simulator training. The content of the evaluation varies with the capabilities of the simulator used and the requirements of the governing regulatory agency.

An evaluation in the airplane may be required if the training has not been accomplished under the prescribed requirements of FAA or other applicable governing regulations.

Crew Resource Management

Crew resource management is the application of team management concepts and the effective use of all available resources to operate a flight safely. In addition to the aircrew, it includes all other groups routinely working with the aircrew who are involved in decisions required to operate a flight. These groups include, but are not limited to, airplane dispatchers, flight attendants, maintenance personnel, and air traffic controllers.

777 Flight Crew Training Manual

Throughout this manual, techniques that help build good CRM habit patterns on the flight deck are discussed. For example, situational awareness and communications are stressed. Situational awareness, or the ability to accurately perceive what is going on in the flight deck and outside the airplane, requires on going questioning, crosschecking, communication, and refinement of perception.

It is important that all flight deck crewmembers identify and communicate any situation that appears unsafe or out of the ordinary. Experience has proven that the most effective way to maintain safety of flight and resolve these situations is to combine the skills and experience of all crewmembers in the decision making process to determine the safest course of action.

Headphone and Flight Deck Speaker Use

In the airplane, headphones or boom microphones/headsets are worn during takeoff until the top of climb and from the start of descent throughout approach and landing. During cruise, flight deck speakers may be used. Speaker volume should be kept at the minimum usable level adequate to avoid interference with normal crew flight deck conversation, but still ensure reception of relevant communications.

Synoptic Display

Synoptic displays are provided as a means of assisting the flight crew in rapidly understanding the status of the airplane systems. However, crews should not rely solely on the displays for determining airplane status. The flight crew is encouraged to select a display at any time they feel it is the most efficient way to get desired information. Synoptic displays should only be used as necessary to get the desired information and then turned off. The clarity and simplicity of displayed information enable the flight crew to obtain necessary information from a brief scan.

Note: Reference to synoptic displays or maintenance information is not a requirement during the accomplishment of crew procedures.

If the flight crew elects to use synoptic displays in conjunction with accomplishment of procedures, they must assure no distraction from the intended task results. This is particularly true when accomplishing non-normal procedures. Under certain conditions, system faults can result in missing synoptic information. Therefore, decisions regarding non-normal situations should be based on EICAS messages and other flight deck effects and indications. In every case where a non-normal procedure results in a need for memory items, they should be completed before selecting a synoptic display. Accomplishment of necessary procedures should take priority over use of synoptic displays.

Maneuver Speeds and Margins

This section explains the difference between flap maneuver speeds and minimum maneuver speeds. It also describes maneuver margin or bank capability to stick shaker as a function of airspeed during both a flap extension and flap retraction scenario.

Flap Maneuver Speeds

The following tables contain flap maneuver speeds for various flap settings. The flap maneuver speed is the recommended operating speed during takeoff or landing operations. These speeds guarantee full maneuver capability or at least 40° of bank (25° of bank and 15° overshoot) to stick shaker within a few thousand feet of the airport altitude. While the flaps may be extended up to 20,000 feet, less maneuver margin to stick shaker exists for a fixed speed as altitude increases.

Flap Position	All Weights
Flaps UP	VREF 30 + 80
Flaps 1	VREF 30 + 60
Flaps 5	VREF 30 + 40
Flaps 15	VREF 30 + 20
Flaps 20	VREF 30 + 20
Flaps 25	VREF 25
Flaps 30	VREF 30

Minimum Maneuver Speed

The top of the lower amber band on the airspeed display indicates the minimum maneuver speed. The functionality of the lower amber band is slightly different for flaps-down versus flaps-up operation, however, in both cases it alerts the crew that when operating at an airspeed within the amber band less than full maneuver capability exists.

Note: During normal conditions, the target speed is always equal to or faster than the minimum maneuver speed (top of the amber band). During non-normal conditions, the target speed may be below the minimum maneuver speed.

Flaps Down Amber Band

For all flaps-down operations (any time the flaps are not full-up) the minimum maneuver speed is the slowest speed that provides full maneuver capability, 1.3 g's or 40° of bank (25° angle of bank and 15° overshoot) to stick shaker. The top of the amber band does not vary with g load.

777 Flight Crew Training Manual

As airspeed is decreased below the top of the amber band, maneuver capability decreases. In 1G flight, the speed in the middle of the amber band provides adequate maneuver capability or 30° of bank (15° angle of bank and 15° overshoot). The speed at the bottom of the amber band (top of the red and black tape) corresponds to stick shaker onset for the current G load. If the G load is increased during maneuvering, the stick shaker onset speed increases also.

Note: Stick shaker is set to activate before the actual stall. There is sufficient margin to recover from stick shaker without stalling.

The following diagram is a representative sample showing airspeed relative to the amber band.

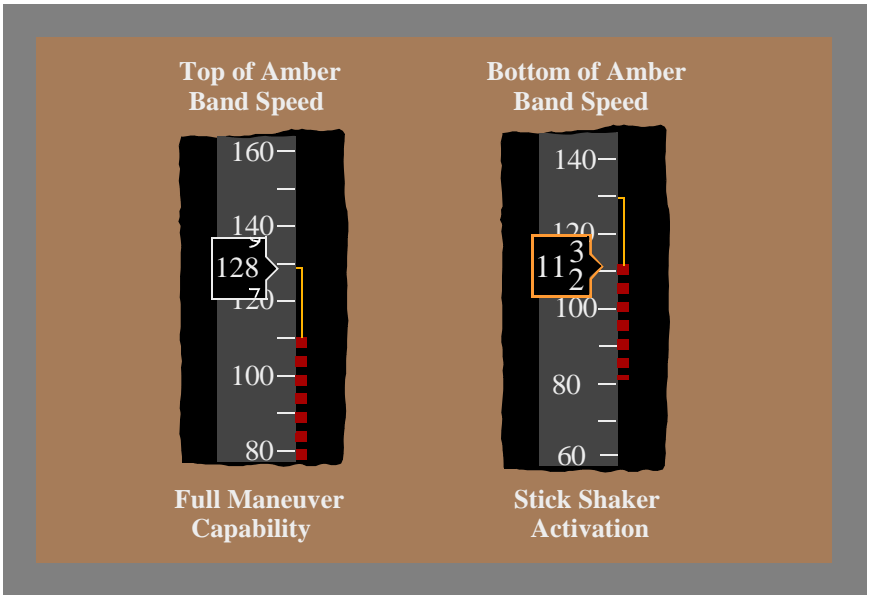

Minimum maneuver speeds (displayed as the top of the lower amber band) should not be confused with flap maneuver speeds. Flap maneuver speeds are based on airplane weight, while the minimum maneuver speed is based on airplane angle of attack and current airspeed. These speeds provide independent means to ensure that the current airspeed provides at least full maneuver capability for terminal-area maneuvering.

Note: During normal conditions, the flap maneuver speed for the current flap detent should always be equal to or faster than the minimum maneuver speed. During some non-normal conditions, the flap maneuver speed for the current flap position may be less than the minimum maneuver speed.



Flaps Up Amber Band

For altitudes up to approximately 10,000 feet, the flaps-up amber band functions just like the flaps-down amber band described above, with the top of the amber band representing full maneuver capability. Due to increasing Mach effects between 10,000 and 20,000 feet, the maneuver capability at the top of the amber band decreases as altitude increases, but still provides at least adequate maneuver capability. Above approximately 20,000 feet, the top of the amber band shows the speed that provides 1.3g maneuver capability to low speed buffet (or an alternative approved maneuver capability as preset by maintenance).

777 Flight Crew Training Manual

Maneuver Margins to Stick Shaker

The following figures are representative illustrations of airplane maneuver margin or bank capability to stick shaker as a function of airspeed. This includes both a flap extension and flap retraction scenario.

When reviewing the maneuver margin illustrations, note that:

- there is a direct correlation between bank angle and load factor (Gs) in level, constant speed flight. For example, 1.1G corresponds to 25° of bank, 1.3G ~ 40°, 2.0Gs ~ 60°
- the illustrated maneuver margin assumes a constant speed, level flight condition
- stick shaker activates prior to actual stall speed
- flap retraction or extension speed is that speed where the flaps are moved to the next flap position in accordance with the flap retraction or extension schedule
- flap retraction and extension schedules provide speeds that are close to minimum drag, and in a climb are close to maximum angle of climb speed. In level flight they provide a relatively constant pitch attitude and require little change in thrust at different flap settings.
- the bold line designates flap configuration changes at the scheduled flap retraction or extension speeds
- the black dots on the bold lines indicate:
 - maneuver speed for the existing flap setting
 - flap retraction or extension speed for the next flap setting
- maneuver margins are based on basic stick shaker schedules and do not include adjustments for the use of anti-ice.

The distance between the bold line representing the flap extension or retraction schedule and a given bank angle represents the maneuver margin to stick shaker at the given bank angle for level constant speed flight. Where the flap extension or retraction schedule extends below a depicted bank angle, stick shaker activation can be expected prior to reaching that bank angle.

Conditions Affecting Maneuver Margins

For a fixed weight and altitude, maneuver margin to stick shaker increases when airspeed increases. Other factors may or may not affect maneuver margin:

- Gross weight: generally maneuver margin decreases as gross weight increases. The base speed (V₂ or V_{REF}) increases with increasing weight. The speed additive is a smaller percent increase for heavier weights
- Altitude: generally maneuver margin decreases with increasing altitude for a fixed airspeed
- Temperature: the effect of a temperature change on maneuver margin is negligible



777 Flight Crew Training Manual

- Landing gear: a small decrease in maneuver margin may occur when the landing gear is extended. This loss is equivalent to 2 knots of airspeed or less
- Speedbrakes: maneuver margin decreases at any flap setting when speedbrakes are extended
- Engine failure during flap retraction: a small decrease in maneuver margin occurs due to the reduced lift experienced with the loss of thrust. The loss is equivalent to 4 knots of airspeed or less
- Anti-ice: the use of engine or wing anti-ice reduces flaps-up and flaps-down maneuver margin. This effect remains until the airplane lands.

777-200LR, 777-300ER

Note: The flaps-up TAI effect becomes zero or negligible at higher Mach numbers (heavy GW and higher altitudes).

777 Flight Crew Training Manual

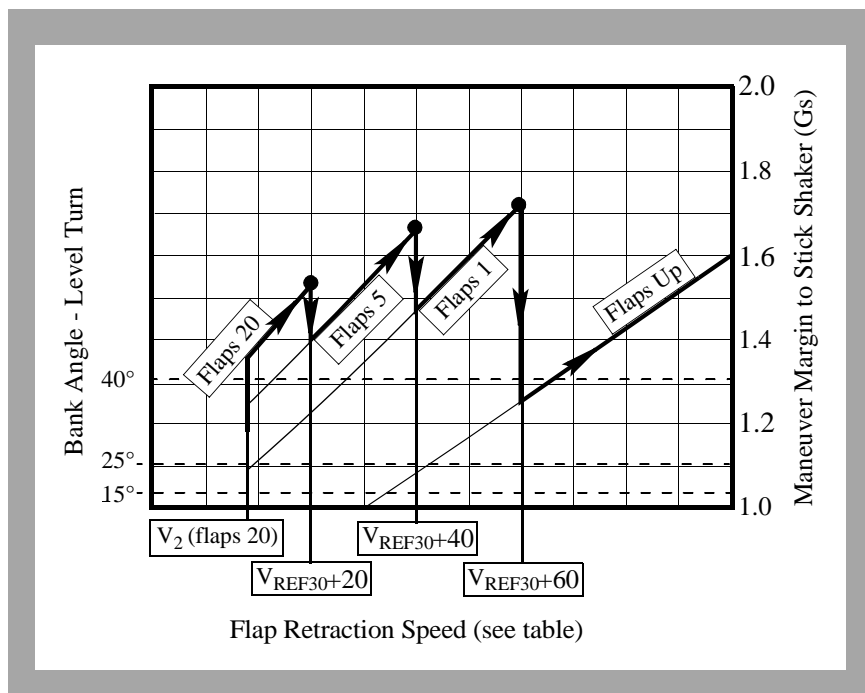
Maneuver Margins to Stick Shaker- Flap Retraction

Takeoff Flaps	At "Display"	Flap Retraction Speed	Select Flaps
20 or 15	"20" or "15"	Vref 30 + 20	5
	"5"	Vref 30 + 40	1
	"1"	Vref 30 + 60	UP
5	"5"	Vref 30 + 40	1
	"1"	Vref 30 + 60	UP



Maneuver Margins to Stick Shaker - Flap Extension

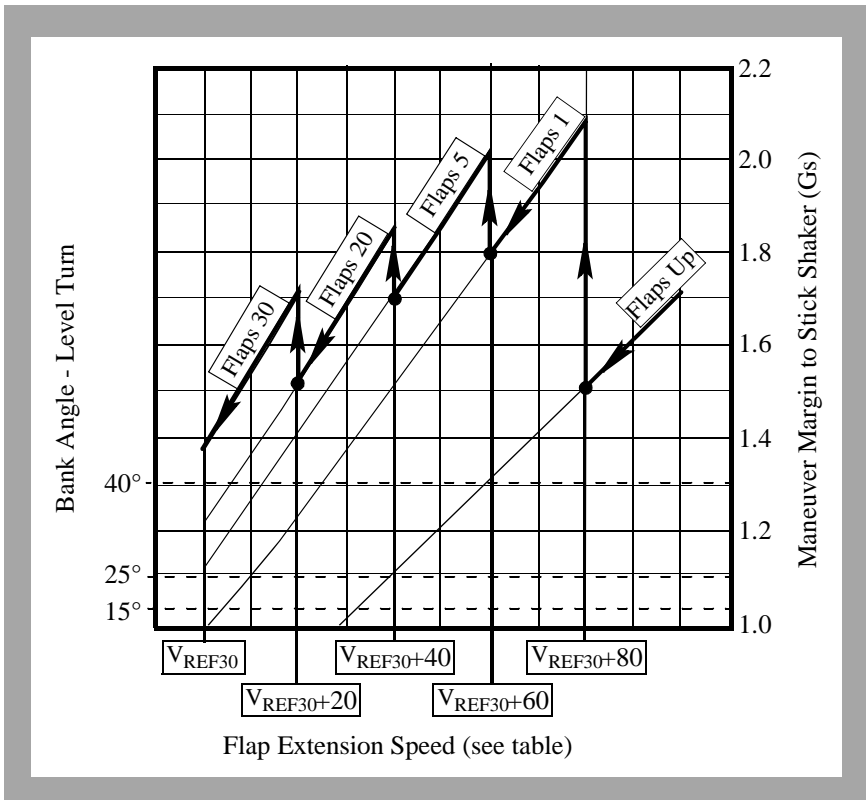

Current Flap Position	At Speedtape "Display"	Flap Extension Speed	Select Flaps	Command Speed for Selected Flaps
UP	"UP"	Vref 30 + 80	1	"1"
1	"1"	Vref 30 + 60	5	"5"
5	"5"	Vref 30 + 40	20	"20"
20	"20"	Vref 30 + 20	25 or 30	(Vref 25 or Vref 30) plus wind additives

777 Flight Crew Training Manual

Command Speed

Command speed may be set by the pilot through the MCP or FMC and is displayed by a speed bug on the airspeed indication.

Takeoff

Command speed remains set at V_2 until changed by the pilot for acceleration or until Vertical Navigation (VNAV), Flight Level Change (FLCH), or altitude hold is engaged. When using FLCH or when altitude hold engages, increase command speed to the desired speed to initiate acceleration for flap retraction.

Climb, Cruise and Descent

Command speed is set to the appropriate speed by the FMC during VNAV operation or manually using the MCP.

Approach

Command speed is set to the maneuver speed for the selected flap position manually using the MCP.

Landing

When using the autothrottle, position command speed to $V_{REF} + 5$ knots. Sufficient wind and gust protection is available with the autothrottle connected because the autothrottle is designed to adjust thrust rapidly when the airspeed drops below command speed while reducing thrust slowly when the airspeed exceeds command speed. In turbulence, the result is that average thrust is higher than necessary to maintain command speed. This results in an average speed exceeding command speed.

If a manual landing is planned with the autothrottle connected in gusty or high wind conditions, consider positioning the command speed to $V_{REF} + 10$ knots. This helps protect against a sudden loss of airspeed during the flare.

If the autothrottle is disconnected, or is planned to be disconnected prior to landing, the recommended method for approach speed correction is to add one half of the reported steady headwind component plus the full gust increment above the steady wind to the reference speed. The minimum command speed setting is $V_{REF} + 5$ knots. One half of the reported steady headwind component can be estimated by using 50% for a direct headwind, 35% for a 45° crosswind, zero for a direct crosswind and interpolation in between.

When making adjustments for winds, the maximum approach speed should not exceed $V_{REF} + 20$ knots. The following table shows examples of wind additives with a runway heading of 360° .



777 Flight Crew Training Manual

Reported Winds	Wind Additive	Approach Speed
360 at 16	8	VREF + 8 knots
Calm	0	VREF + 5 knots
360 at 20 Gust 30	10 + 10	VREF + 20 knots
060 at 24	6	VREF + 6 knots
090 at 15	0	VREF + 5 knots
090 at 15 Gust 25	0 + 10	VREF + 10 knots

Note: Do not apply wind additives for tailwinds. Set command speed at VREF + 5 knots (autothrottle engaged or disconnected).

Non-Normal Conditions

Occasionally, a non-normal checklist instructs the flight crew to use a VREF speed that also includes a speed additive such as VREF 30 + 20. When VREF has been adjusted by a NNC this becomes the VREF used for landing. This VREF does not include wind additives. For example, if a non-normal checklist specifies “Use flaps 20 and VREF 30 + 20 for landing”, the flight crew would select flaps 20 as the landing flaps and look up the VREF 30 speed in the FMC or QRH and add 20 knots to that speed.

When using the autothrottle, position command speed to VREF + 5 knots. Sufficient wind and gust protection is available with the autothrottle engaged that no further wind additives are needed.

If the autothrottle is disconnected, or is planned to be disconnected prior to landing, appropriate wind additives must be added to the VREF to arrive at command speed, the speed used to fly the approach. For example, if the checklist states “use VREF 30 + 20 knots”, command speed should be positioned to VREF (VREF 30 + 20) plus wind additive (5 knots minimum, 20 knots maximum).

Reference Speeds

The following figure shows the positioning of the reference speeds on the airspeed indicator for takeoff and approach.

Reference Speed Setting

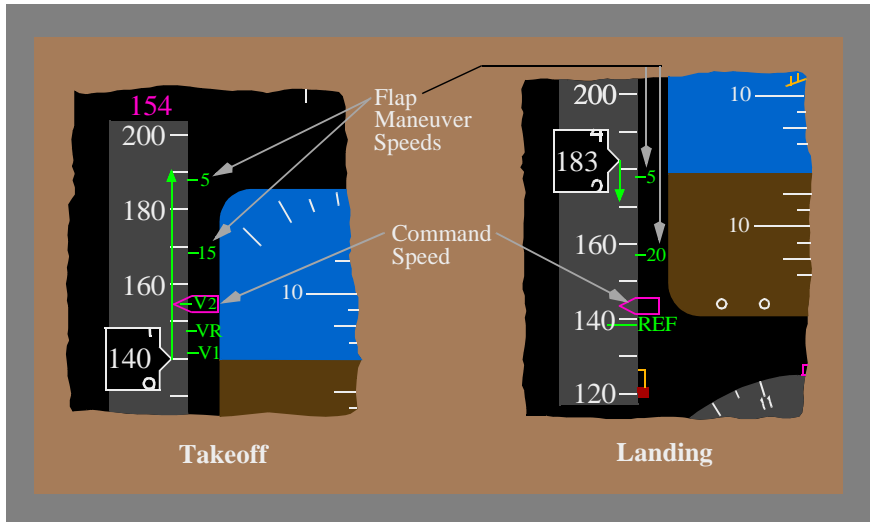

Takeoff

After zero fuel weight, V1, V2, and VR are entered into the FMC, airspeed bugs are automatically displayed at V1, VR, V2 and the minimum flap retraction speed for the next normal flap retraction position. Command speed is set at V2 using the MCP. V2 is the minimum takeoff safety speed and provides at least 30° bank capability (15° + 15° overshoot) for all takeoff flaps.

777-300

Note: During a flaps 15 takeoff, the “15” (flap maneuver speed symbol) may not be visible at low gross weights. This is because the V2 speed is very close to the “15” symbol and display of the “V2” symbol takes precedence over the “15” symbol until the flap handle is moved out of the 15 detent.

Approach - Landing

VREF is displayed upon entry of landing flaps/speed in the FMC. The maneuver speed for the current flap position and the next flap position are automatically displayed on the airspeed display.



Thrust Management

Setting Thrust

The term "set thrust" or "verify that thrust is set" is used in various places in the FCTM and the FCOM. The proper thrust setting is determined by the N1 or EPR (as installed) indication. However, when setting or verifying that the proper thrust is set, the flight crew's attention should not be focused on setting the exact indication at the expense of crosschecking that other engine indications are consistent with the N1 or EPR (as installed) indication and maintaining situational awareness.

Maximum Thrust

The term "maximum thrust" is used in various places in the FCTM and the FCOM. Maximum thrust is obtained:

- for airplanes with engine EECs operating in the normal mode, by advancing the thrust levers full forward
- for airplanes with engine EECs operating in the alternate mode, by advancing the thrust levers to the full rated takeoff or go-around limit only. Advancing the thrust levers to the full forward stop should only be considered if terrain contact is imminent.

Note: This definition of maximum thrust applies to all situations except when a fixed derate takeoff is accomplished. The fixed derate is considered a limitation for takeoff. Further explanation of thrust limitations during a fixed derate takeoff are found in the Reduced Thrust Takeoff section of chapter 3.

777 Flight Crew Training Manual

Callouts

Both crewmembers should be aware of altitude, airplane position and situation.

Avoid nonessential conversation during critical phases of flight, particularly during taxi, takeoff, approach and landing. Unnecessary conversation reduces crew efficiency and alertness and is not recommended when below 10,000 feet MSL / FL100. At high altitude airports, adjust this altitude upward, as required.

The Pilot Monitoring (PM) makes callouts based on instrument indications or observations for the appropriate condition. The Pilot Flying (PF) should verify the condition/location from the flight instruments and acknowledge. If the PM does not make the required callout, the PF should make it.

The PM calls out significant deviations from command airspeed or flight path. Either pilot should call out any abnormal indications of the flight instruments (flags, loss of deviation pointers, etc.).

One of the basic fundamentals of Crew Resource Management is that each crewmember must be able to supplement or act as a back-up for the other crewmember. Proper adherence to standard callouts is an essential element of a well-managed flight deck. These callouts provide both crewmembers required information about airplane systems and about the participation of the other crewmember. The absence of a standard callout at the appropriate time may indicate a malfunction of an airplane system or indication, or indicate the possibility of incapacitation of the other pilot.

The PF should acknowledge all GPWS voice callouts during approach except altitude callouts while below 500 feet AFE. The standard callout of "CONTINUE" or "GO-AROUND" at minimums is not considered an altitude callout and should always be made. If the automatic electronic voice callout is not heard by the flight crew, the PM should make the callout.

Note: If automatic callouts are not available, the PM may call out radio altitude at 100 feet, 50 feet and 30 feet (or other values as required) to aid in developing an awareness of eye height at touchdown.



Standard Callouts

	CONDITION / LOCATION	CALLOUT (Pilot Monitoring, unless noted)
Climb And Descent	Approaching Transition Altitude	“TRANSITION ALTITUDE, SET STANDARD”
	Approaching Transition Level	“TRANSITION LEVEL, ALTIMETERS RESET _____” (in. or mb)
	1000 ft. above/below assigned altitude/Flight Level (IFR)	“1000 FT TO LEVEL OFF”
Descent	10,000 ft. MSL / FL100 (Reduce airspeed if required) (IFR and VFR)	“10,000 / FL100”

777 Flight Crew Training Manual
Standard Callouts - ILS or GLS Approach

CONDITION / LOCATION	CALLOUT (Pilot Monitoring, unless noted)
First positive inward motion of localizer pointer	"LOCALIZER ALIVE"
First positive motion of Glide Slope pointer	"GLIDE SLOPE ALIVE"
Final approach fix inbound	"OUTER MARKER/FIX, ____FT"
500 ft. AFE (Check autoland status annunciator, if applicable)	"500 FEET" (F/D approach) Autoland status "LAND 2 or LAND 3 or NO AUTOLAND"
100 ft. above DA(H) (fail passive airplanes)	"APPROACHING MINIMUMS"
Individual sequence flasher lights visible	"STROBE LIGHTS"
At AH (fail operational airplanes) - check autoland status annunciator	"ALERT HEIGHT"
At DA(H) with individual approach light bars visible	"MINIMUMS - APPROACH LIGHTS / RED BARS" (if installed)
At DA(H) - Suitable visual reference established, i.e., PM calls visual cues	PF: "CONTINUE"
At DA(H) - Suitable visual reference not established, i.e., PM does not call any visual cues or only strobe lights	PF: "GO AROUND"
At minimums callout - If no response from PF	"I HAVE CONTROL ____" (state intentions)
Below DA(H) - Suitable visual reference established	"THRESHOLD/RUNWAY TOUCHDOWN ZONE"
Below DA(H) - Suitable visual reference established	PF: "LANDING"
Below DA(H) - Suitable visual reference not established, i.e., PM does not call any visual cues	PF: "GO AROUND"



777 Flight Crew Training Manual

Standard Callouts - Non-ILS or Non-GLS Approach

CONDITION / LOCATION	CALLOUT (Pilot Monitoring, unless noted)
First positive inward motion of VOR or LOC course deviation indication	"COURSE/LOCALIZER ALIVE"
Final approach fix inbound	"VOR/NDB/FIX"
500 ft. AFE	"500 FEET"
100 ft. above DA(H) or MDA(H)	"APPROACHING MINIMUMS"
Individual sequence flasher lights visible	"STROBE LIGHTS"
At DA(H) or MDA(H) with individual approach light bars visible	"MINIMUMS - APPROACH LIGHTS / RED BARS" (if installed)
At DA(H) or MDA(H) - Suitable visual reference established, i.e., PM calls visual cues	PF: "CONTINUE"
At DA(H) or MDA(H)- Suitable visual reference not established, i.e., PM does not call any visual cues or only strobe lights	PF: "GO AROUND"
At minimums callout - If no response from PF	"I HAVE CONTROL _____" (state intentions)
Below DA(H) or MDA(H)- Suitable visual reference established	"THRESHOLD/RUNWAY TOUCHDOWN ZONE"
Below DA(H) or MDA(H)- Suitable visual reference established	PF: "LANDING"
Below DA (H) or MDA(H)- Suitable visual reference not established, i.e., PM does not call any visual cues	PF: "GO AROUND"

777 Flight Crew Training Manual

Standard Phraseology

A partial list of recommended words and phrases follows:

Thrust:

- “SET TAKEOFF THRUST”
- “SET GO-AROUND THRUST”
- “SET MAXIMUM CONTINUOUS THRUST”
- “SET CLIMB THRUST”
- “SET CRUISE THRUST”

Flap Settings:

- “FLAPS UP”
- “FLAPS ONE”
- “FLAPS FIVE”
- “FLAPS FIFTEEN”
- “FLAPS TWENTY”
- “FLAPS TWENTY-FIVE”
- “FLAPS THIRTY”

Airspeed:

- “80 KNOTS”
- “V1”
- “ROTATE”
- “SET _____ KNOTS”
- “SET VREF PLUS (additive)”
- “SET FLAPS _____ SPEED”



Electronic Flight Bag

This section provides guidance on the use of the optional Electronic Flight Bag (EFB). The EFB may contain some or all of the following options.

Note: Crews must avoid fixation on the display or distraction from primary crew duties while using any EFB application.

Airport Moving Map

The airport map display is intended to enhance crew positional awareness while planning taxi routes and while taxiing. The system is not intended to replace normal taxi methods including the use of direct visual observation of the taxiways, runways, airport signs and markings and other airport traffic. Prior to taxi, NOTAMS and airport charts (using EFB terminal charts or paper) should be consulted for the latest airport status to include closed taxiways, runways, construction, etc., since these temporary conditions are not shown on the airport map.

Crews must use direct visual observation out flight deck windows as the primary taxi navigation reference. Use the airport Heading-Up or North-Up map to provide enhanced positional awareness by:

- verifying taxi clearance and assisting in determining taxi plan (both pilots)
- monitoring taxi progress and direction (both pilots)
- alerting and updating the pilot taxiing with present position and upcoming turns and required stops (pilot not taxiing).

In flight, the airport North-Up (fixed) fixed map may be used to aid in runway exit planning and anticipating the taxi route to the gate or parking spot.

If one airport map display is inoperative at dispatch, the crewmember with the inoperative display may wish to keep a paper copy of the airport diagram readily available. During taxi in this situation, one pilot should continue to use the airport map display for positional awareness while the other pilot monitors progress on the paper chart. If an airport map display fails after dispatch and no paper backup airport diagrams are available, the crew should consider having the pilot not taxiing provide progressive taxi and positional updates to the pilot taxiing or request progressive taxi instruction from ground control. In any case, the pilot taxiing should always devote primary attention to taxiing the airplane by external visual observation. If the airport map display is inoperative on both sides, use normal taxi procedures.

Note: GPS position must be available to use the Heading-Up map.

777 Flight Crew Training Manual

Terminal Charts

Electronic terminal charts may be used in place of paper charts. Enroute charts may be available in the EFB. Should the airplane dispatch with one or both displays inoperative, the crew should comply with the provisions of the MEL regarding the use of backup charts.

Airplane Performance

When all appropriate entries are made, the airplane performance application provides runway specific performance information equivalent to AFM-DPI data or airline airport analysis. During approach preparation, the system can provide advisory landing distance information.

Video Surveillance

The video surveillance display may be used at the discretion of the crew to identify individuals requesting flight deck entry or for other airline-specific purposes such as passenger cabin or cargo compartment observation.

Electronic Logbook and Other Documents

The electronic logbook and other electronic documents should be used as defined by operator policy and procedures.

Flight Path Vector

The Flight Path Vector (FPV) displays Flight Path Angle (FPA) relative to the horizon line and drift angle relative to the center of the pitch scale on the attitude display. This indication uses inertial and barometric altitude inputs. The vertical flight path angle displayed by the FPV should be considered unreliable with unreliable primary altitude displays. The FPV can be used by the pilot in several ways:

- as a reference for establishing and maintaining level flight when the F/D is not in use or not available. When maneuvering the airplane, adjust pitch to place the FPV on the horizon. This results in zero vertical velocity
- as a crosscheck of the vertical flight path angle when established in a climb, descent, or on a visual final approach segment

Note: When the AFDS FPA mode is selected, the FPV automatically appears to aid in establishing and monitoring the selected FPA.

Note: When on final approach, the FPV does not indicate airplane glide path relative to the runway. ILS glide slope, VASI/PAPI or other means must be used for a proper glide path indication.



777 Flight Crew Training Manual

- in climbs or descents, radar tilt can be adjusted to an appropriate elevation based on the displayed FPA. Radar tilt, like the FPV, is referenced to the horizon. Example: Adjusting the radar tilt to the same angle relative to the horizon as the FPV during climb results in the radar beam centered on the existing flight path
- as a qualitative indication of airplane lateral drift direction if the map is not available. The FPV moves left or right of the pitch scale to indicate the relative position of the ground track to the present heading. The amount of drift cannot be determined from this display. Example: FPV displaced to the left indicates wind component from the right and corresponding drift to the left
- as a cross-reference, when flying visual traffic patterns. On the downwind leg, the flight crew should position the FPV on the horizon line, in order to maintain level flight
- on final approach it provides a trajectory that quickly indicates a downburst. In addition, the position of the FPV in relation to the aircraft symbol provides an indication of the wind direction.
- as a reference by the pilot in maintaining proper flight path control with unreliable airspeed indications. Adjust pitch to establish desired flight path by placing the FPV just above, below or on the horizon line.

Note: The FPV should not be used in reference to the PLI, which is a pitch attitude referenced display.

Cold Temperature Altitude Corrections

[Appendix A.2.1](#)

If the outside air temperature (OAT) is different from standard atmospheric temperature (ISA), barometric altimeter errors result due to non-standard air density. Larger temperature differences from standard result in larger altimeter errors. When the temperature is warmer than ISA, true altitude is higher than indicated altitude. When the temperature is colder than ISA, true altitude is lower than indicated altitude. Extremely low temperatures create significant altimeter errors and greater potential for reduced terrain clearance. These errors increase with higher airplane altitudes above the altimeter source.

Consider doing the Cold Temperature Altitude Corrections Supplementary Procedure in the FCOM when altimeter errors become appreciable, especially where high terrain and/or obstacles exist near airports in combination with very cold temperatures (-30°C/ -22°F or colder). Also consider correcting en route minimum altitudes and/or flight levels where terrain clearance is a factor. In some cases corrections may be appropriate for temperatures between 0°C and -30°C.

777 Flight Crew Training Manual

Aircrews should note that for very cold temperatures, when flying published minimum altitudes significantly above the airport, altimeter errors can exceed 1000 feet, resulting in potentially unsafe terrain clearance if no corrections are made.

Operation in Icing Conditions

Boeing airplanes are certified to all applicable airworthiness regulations regarding flight in icing conditions. Operators are required to observe all operational procedures concerning flight in these conditions.

Although the process of certifying jet transport airplanes for operation in icing conditions involves many conservative practices, these practices have never been intended to validate operations of unlimited duration in severe icing conditions. The safest course of action is to avoid prolonged operation in moderate to severe icing conditions.

Training Flights

Multiple approaches and/or touch and go landings in icing conditions may result in significant ice accumulations beyond those experienced during typical revenue flights. This may result in fan blade damage as a result of ice accumulation on unheated surfaces shedding into the engines.

Recommended Rudder Trim Technique

This section describes two techniques for properly trimming the rudder. It is assumed that the airplane is properly rigged and in normal cruise. The primary technique uses rudder trim only to level the control wheel and is an acceptable and effective method for trimming the airplane. It is approximately equal to a minimum drag condition. This technique is usable for normal as well as many non-normal conditions. For some non-normal conditions, such as engine failure with TAC inoperative, this technique is the preferred method and provides near minimum drag.

The alternate technique may provide a more accurate trim condition when the roll is caused by a roll imbalance. In addition, this technique outlines the steps to be taken if the primary trim technique results in an unacceptable bank angle or excessive rudder trim. The alternate technique uses both rudder and aileron trim to neutralize a rolling condition using the bank pointer as reference.

Note: Large trim requirements may indicate the need for maintenance and should be noted in the airplane log.

Drag Factors Due to Trim Technique

If the control wheel is displaced to the point of spoiler deflection a significant increase in aerodynamic drag results. Additionally, any rigging deviation that results in early spoiler actuation causes a significant increase in drag per unit of trim. These conditions result in increased fuel consumption. Small out of trim conditions affect fuel flow by less than 1%, if no spoilers are deflected.

Note: Aileron trim may be required for significant fuel imbalance, airplane damage, or flight control system malfunctions.

Primary Rudder Trim Technique

It is recommended that the autopilot remain engaged while accomplishing the primary rudder trim technique (using rudder trim only). After completing this technique, if the autopilot is disengaged, the airplane should maintain a constant heading.

The following steps define the primary rudder trim technique:

- set symmetrical thrust
- balance fuel if required

777 Flight Crew Training Manual

- ensure the autopilot is engaged in HDG SEL or HDG HOLD and stabilized for at least 30 seconds
- trim the rudder in the direction corresponding to the down (low) side of the control wheel until the control wheel indicates level. The indices on top of the control wheel should be used to ensure a level wheel condition. The airplane is properly trimmed when the control wheel is level, (zero index). As speed, gross weight, or altitude change, trim requirements may also change. In a proper trim condition, there may be a slight forward slip (slight bank angle indicated on the bank pointer) and a slight deflection of the slip/skid indicator, which is acceptable.

Alternate Rudder Trim Technique

The alternate rudder trim technique is used if the primary trim technique results in an unacceptable bank angle, excessive rudder trim, or if a more accurate dual axis trim is required.

The following steps define the alternate rudder trim technique:

- set symmetrical thrust
- balance fuel if required
- verify rudder trim is zero
- ensure the autopilot is engaged in HDG SEL or HDG HOLD and stabilized for at least 30 seconds
- trim the rudder in the direction corresponding to the down (low) side of the control wheel until the bank indicates level (no bank angle indicated on the bank pointer). Apply rudder trim incrementally, allowing the bank to stabilize after each trim input. Large trim inputs are more difficult to coordinate. The airplane is properly trimmed when the bank angle on the bank pointer indicates zero. If the airplane is properly rigged, the control wheel should indicate approximately level. The resultant control wheel condition indicates the true aileron (roll) trim of the airplane being used by the autopilot.

After completing the alternate rudder trim technique, if the autopilot is disengaged the airplane may have a rolling tendency. Hold the wings level using the bank pointer as reference. Trim out any control wheel forces using the aileron trim switches. If properly trimmed, the airplane holds a constant heading and the aileron trim reading on the wheel/column agrees with what was seen while the autopilot was engaged. Aileron trim inputs require additional time and should be accomplished prior to final approach.



Flight Management Computer(s)/CDUs

The Flight Management System provides the crew with navigation and performance information that can result in a significant crew workload reduction. This workload reduction is fully realized when the system is operated as intended, including proper preflight and timely changes in flight. FMC guidance must always be monitored after any in flight changes. If flight plan changes occur during periods of high workload or in areas of high traffic density, the crew should not hesitate to revert to modes other than LNAV/VNAV.

During preflight, all flight plan or performance related FMC CDU entries made by one pilot must be verified by the other pilot. In flight FMC CDU changes should be made by the PM and executed only after confirmation by the PF.

FMC Route Verification Techniques

After entering the route into the FMC, the crew should verify that the entered route is correct. There are several techniques that may be used to accomplish this. The crew should always compare:

- the filed flight plan with the airways and waypoints entered on the ROUTE pages
- the computer flight plan total distance and estimated fuel remaining with the FMC-calculated distance to destination and the calculated fuel remaining at destination on the progress page.

For longer flights and flights that are planned to transit oceanic airspace, the crew should crosscheck the LEGS page with the computer flight plan to ensure that the waypoints, magnetic or true tracks, and distances between waypoints match.

If there is a discrepancy noted in any of the above, correct the LEGS page to match the filed flight plan legs. A crosscheck of the map display using the plan mode may also assist in verification of the flight plan.

FMC Performance Predictions - Non-Normal Configuration

FMC performance predictions are based on the airplane being in a normal configuration. These predictions include:

- climb and descent path predictions including top of climb and top of descent
- ECON, LRC, holding, and engine out speeds
- altitude capability
- step climb points
- fuel remaining at waypoints and destination or alternate
- estimated time of arrival at waypoints and destination or alternate
- holding time available.

777 Flight Crew Training Manual

If operating in a non-normal configuration, such as gear down, flaps extended, spoilers extended, gear doors open, etc., these performance predictions are inaccurate. FMC predictions for the climb and descent path are not usable.

Do not use FMC fuel predictions. Cruise fuel predictions are based on a clean configuration. Fuel consumption may be significantly higher than predicted in other configurations.

Note: VNAV PTH operation for approaches is usable for non-normal configurations.

An accurate estimated time of arrival is available if current speed or Mach is entered into the VNAV cruise page. Estimates of fuel remaining at waypoints or the destination may be computed by the crew based on current fuel flow indications, but should be updated frequently. Performance information for gear down altitude capability and gear down cruise performance is available in the PI chapter of the QRH.

Holding time available is accurate in the clean and flaps one configuration provided the FMC holding speed is maintained.

RNAV Operations

This section provides definitions of terms associated with RNAV and describes basic concepts to include phase of flight navigation for radius-to-fix (RF) legs, terminal (SIDs and STARs), en-route, and approach operations.

RNAV or area navigation is a method of navigation that allows aircraft to fly on any desired flight path within the coverage of referenced NAVAIDS or within the limits of the capability of self-contained systems, or a combination of these capabilities.

All Boeing FMCs are capable of performing RNAV operations. Regarding navigation accuracy, these FMCs differ only by demonstrated RNP capabilities and the ability to use GPS updating.

En-route operations can be defined as oceanic and domestic. Oceanic RNAV requirements are described in detail in the applicable MNPS guidance material such as the Pacific or North Atlantic manuals. Specific routes or areas of operation are given RNPs based on route separation requirements. RNP 10 routes are suitable for all FMCs that are capable of GPS updating and those FMCs that cannot update from GPS but have received the last radio update within the previous six hours.

In general, oceanic operations require dual navigation systems (dual FMC or single FMC in combination with alternate navigation capability).

RNP and ANP Definitions

RNP (Required Navigation Performance) is a specified navigation performance for route, terminal, or approach procedures. It is a measure of the navigation performance accuracy necessary for operations within a defined airspace where the airplane must be at least 95% of the time. It is shown in nautical miles. All RNP based procedures have an associated RNP level that is published on the procedure chart.

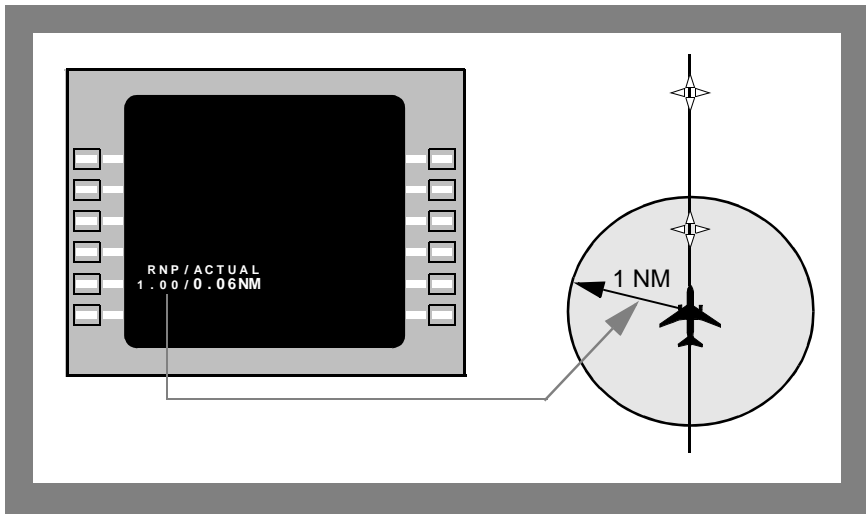

Oceanic RNP levels are generally 4.0 or higher. Domestic en-route RNAV operations depend on the availability of radio updating (DME-DME) sources to support domestic RNP levels. The following domestic RNP operations are fully supported by any Boeing FMC with DME-DME or GPS updating active:

- USA and Canada - RNP 2.0 or higher, RNAV-1, and RNAV-2
- Europe - B-RNAV (RNP 5.0)
- Asia - As specified for the route or area (e.g. RNP 4 or RNP 10 routes)
- Africa - As specified for the route or area

Terminal RNAV operations (SIDs, STARs and Transitions) are fully compatible with all FMCs with DME-DME or GPS updating active and are defined as:

- USA and Canada - RNP 1.0 SIDs and STARs
- Europe - P-RNAV (RNP 1.0).

RNAV approaches are compatible with all FMCs provided DME-DME or GPS updating is active at the beginning of the approach and the approach RNP is equal to or greater than the minimum demonstrated RNP in the AFM. Restrictions published on some RNAV approaches may preclude their use without GPS updating active. Approach RNP levels can be as low as 0.10 NM.

777 Flight Crew Training Manual

For approaches, all Boeing FMCs have RNP 0.5 capability with DME-DME updating active without GPS updating. See the Approach section of this manual for further details regarding the techniques for flying RNAV approaches.

ANP (Actual Navigation Performance) is the FMC calculated certainty of the airplane's position in nautical miles. It is situation information for the flight crew representing a system estimate of the radius of the area in which the actual position of the airplane lies. The system uses the best available sensor(s) to minimize positioning error. The flight crew or autoflight system must track the RNAV path using LNAV. There is a 95% probability that the airplane is within the displayed ANP.

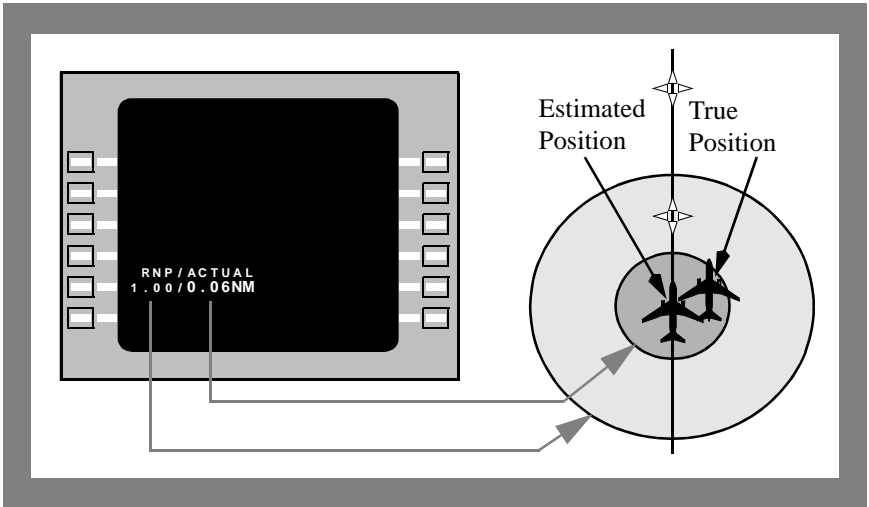

Basic RNP Concept

[Appendix A.2.1](#)

RNP is RNAV operations with on-board navigation performance monitoring and alerting. RNP was developed as a method for certifying the navigation capability for RNAV systems that can use multiple sensors for position updating. Navigation performance within the RNP level assures traffic and terrain separation. RNAV (RNP) procedures must be flown as published in the navigation database. Pilot defined routes and lateral or vertical route modifications are not allowed.

RNAV (RNP) SAAAR (Special Aircraft and Aircrew Authorization Required) or AR (Authorization Required) procedures are RNP approaches that require special aircraft and aircrew authorization. For specific instructions refer to Chapter 5, Instrument Approach - RNAV (RNP) SAAAR/AR

The FMC uses one of the following as the displayed RNP:

- default RNP - FMC default values are set by the FMC and are displayed if no RNP is available from the navigation database or one has not been manually entered
- navigation database RNP values (if available) are displayed based on values associated with the procedure. These values may be unique for certain segments or terminal procedures
- manually entered RNP - remains until changed or deleted.

The crew may need to make a manual RNP entry if the displayed RNP for the route or procedure is incorrect. Setting an RNP smaller than what is specified for the procedure, airspace, or route, may cause nuisance crew alerts. If the RNP is set larger than that specified for a procedure or segment, crew alerting may occur at the incorrect RNP (if the specified RNP is exceeded). The RNP is depicted on the published procedure being flown.

Although today's airspace design has already established certain lateral limits (RNP), no Vertical Required Navigation Performance limits are published. Vertical Required Navigation Performance is available on some FMC's and maybe used for certain descent profiles such as Continuous Descent Approach (CDA), Optimized Profile Descent (OPD) or Tailored Arrivals (TAs).

The FMC calculates, monitors and displays ANP as described in the FCOM. Crews should note that ANP is only related to the accuracy of FMC position.

Airplanes with Navigation Performance Scales (NPS)

For airplanes with Navigation Performance Scales (NPS) the flight crew can monitor the dynamic relationship between ANP, RNP, and current flight path deviations. The lateral and vertical deviation scales are based on the familiar concepts of a centerline indication, scale limits, and a deviation pointer and provide the flight crew with a clear indication of current position in relation to desired position and the total allowable error. Full scale lateral and vertical deviation for NPS is equal to the FMC RNP value. If the deviation approaches the limit, a correction back to the path is needed. Reference the FCOM for specific NPS system indications and description.

During RNP operations other than approach, anytime the deviation exceeds the limit or an amber deviation alert occurs, the crew may have to select a different autopilot roll or pitch mode or manually fly airplane back on course. If unable to comply the flight crew has to revert to other means of navigation such as conventional ground based or radar navigation.

777 Flight Crew Training Manual

During RNP approach operation, anytime the deviation exceeds the limit or an amber deviation alert occurs the crew may change to a non-RNP procedure. If unable the crew should execute a missed approach unless suitable visual reference is already established. In the event of a missed approach, the crew may consider requesting an alternate clearance

Airplanes without Navigation Performance Scales (NPS)

For airplanes without NPS, the crew must refer to the FMC progress page for XTK and VTK information during the approach.

If a deviation occurs, and the correction back to course is not immediate, then the PM should refer to the FMC progress page and notify the PF if the maximum allowable deviations are reached. Normally XTK should not exceed $1.0 \times \text{RNP}$ during RNP operations.

Note: An excessive cross-track error does not result in a crew alert.

During RNP operations other than approach, anytime the deviation exceeds the limit, the crew may have to select a different autopilot roll or pitch mode or manually fly airplane back on course. If unable to comply the flight crew has to revert to other means of navigation such as conventional ground based or radar navigation.

During RNP approach operation, anytime the deviation exceeds the limit the crew may change to a non-RNP procedure. If unable the crew should execute a missed approach unless suitable visual reference is already established. In the event of a missed approach, the crew may consider requesting an alternate clearance.

ANP Alerts

When ANP exceeds RNP, an EICAS alert is displayed. If this occurs during RNP operations other than approach, the crew should verify position, confirm updating is enabled, and consider requesting an alternate clearance. This may mean changing to a non-RNP procedure or route or changing to a procedure or route with a RNP higher than the displayed ANP value.

If the alert occurs during RNP approach operation, the crew may change to a non-RNP procedure. If unable, the crew should execute a missed approach unless suitable visual reference is already established. In the event of a missed approach, the crew may consider requesting an alternate clearance.



Autoflight Use During RNP

Normally, a route segment or procedural leg is defined by its required width. For RNP operations, route width is normally equal to at least $2.0 \times \text{RNP}$ from either side of the LNAV course. Required width is determined by minimum terrain or traffic clearance requirements. The probability of exceeding this maximum deviation while in LNAV with the autopilot engaged is very small. For each airplane type, minimum demonstrated RNP values are given in the AFM. These minimum values vary depending on LNAV, flight director and autopilot use, and whether GPS is the active source of position updating.

RNP operations require appropriate path tracking consistent with the RNP level. LNAV together with the flight director and the autopilot may be required for certain low RNP operations. Use of the autopilot and LNAV normally provide the required path tracking accuracy. For RNAV (RNP) approach procedures, VNAV PTH is normally required for vertical guidance beyond the VIP (VNAV Intercept Point) or FAF. These procedures show only LNAV/VNAV approach minima and do not allow use of LNAV only. Use of the flight director alone may not provide sufficient guidance to maintain the path accurately.

Note: If the autopilot is not available, flight crews should use the flight director and the additional cues displayed on the navigation display (position trend vector, airplane symbol, and digital cross track deviation) with at least one map set at the 10 NM range.

Radius-to-Fix (RF) Legs

RF legs are waypoints connected by a constant radius course similar to a DME arc. These are shown on terminal procedures as a curved track between two or more waypoints. Some considerations regarding use of RF legs:

- there may be a maximum speed shown on some straight legs or some RF legs of smaller radius. This limitation is critical for the crew to observe since the ability of the AFDS to track the RF leg is determined by ground speed and maximum available bank angle. In high tailwinds, the resulting ground speed may cause the maximum bank angle to be reached. In this situation, excessive course deviation may occur if the maximum RF speed is exceeded
- do not begin a procedure by proceeding direct to an RF leg. This may cause excessive deviation when the airplane maneuvers to join the RF leg. Normally there is a track-to-fix leg prior to an RF leg to ensure proper RF leg tracking
- intercept course to or direct to route modifications delete an RF leg if done to the second waypoint on an RF leg

777 Flight Crew Training Manual

- if a go-around is executed while on an RF leg, it is important to immediately re-select LNAV (or verify that LNAV has re-engaged for airplanes equipped with the TO/GA to LNAV feature) to avoid excessive course deviation. GA roll mode is a track hold mode and is not compatible with low RNP operations if left engaged. The pilot flying must continue to track the LNAV course using the map display as a reference until LNAV is re-engaged.

If a temporary loss of the FMC occurs, RF legs will appear as part of the inactive route when the FMC returns to normal operation. Once the route is activated and the EXEC key is pressed, a normal LNAV capture of an RF leg is possible if the situation permits.

GPS Use in Non-WGS-84 Reference Datum Airspace

Appendix A.2.1

In non-WGS-84 airspace, the local datum (position basis) used to survey the navigation database position information may result in significant position errors from a survey done using the WGS-84 datum. To the pilot, this means that the position of runways, airports, waypoints, nav aids, etc., may not be as accurate as depicted on the map display and may not agree with the GPS position.

A worldwide survey has been conducted which determined that using the FMC while receiving GPS position updating during SIDS, STARS and enroute navigation meets the required navigation accuracy in non-WGS-84 airspace. This navigation position accuracy may not be adequate for approaches, therefore the AFM requires the crew to inhibit GPS position updating while flying approaches in non-WGS-84 airspace “unless other appropriate procedures are used.”

Weather Radar and Terrain Display Policy

Whenever the possibility exists for adverse weather and terrain/obstacles near the intended flight path, one pilot should monitor the weather radar display and the other pilot should monitor the terrain display. The use of the terrain display during night or IMC operations, on departure and approach when in proximity to terrain/obstacles, and at all times in non-radar environments is recommended.

Note: It may be useful to show the terrain display at other times to enhance terrain/situational awareness.

AFDS Guidelines

Crewmembers must coordinate their actions so that the airplane is operated safely and efficiently.



777 Flight Crew Training Manual

Autopilot engagement should only be attempted when the airplane is in trim, F/D commands (if the F/D is on) are essentially satisfied and the airplane flight path is under control. The autopilot is not certified or designed to correct a significant out of trim condition or to recover the airplane from an abnormal flight condition and/or unusual attitude.

Autothrottle Use

Autothrottle use is recommended during all phases of flight. When in manual flight, autothrottle use is also recommended, however manual thrust control may be used to maintain pilot proficiency.

Manual Flight

The PM should make AFDS mode selections at the request of the PF. Heading and altitude changes from air traffic clearances and speed selections associated with flap position changes may be made without specific directions. However, these selections should be announced, such as, "HEADING 170 SET". The PF must be aware such changes are being made. This enhances overall safety by requiring that both pilots are aware of all selections, while still allowing one pilot to concentrate on flight path control.

Ensure the proper flight director modes are selected for the desired maneuver. If the flight director commands are not to be followed, the flight director should be turned off.

Automatic Flight

Autoflight systems can enhance operational capability, improve safety, and reduce workload. Automatic approach and landing, Category III operations, and fuel-efficient flight profiles are examples of some of the enhanced operational capabilities provided by autoflight systems. Maximum and minimum speed protection are among the features that can improve safety while LNAV, VNAV, and instrument approaches using VNAV are some of the reduced workload features. Varied levels of automation are available. The pilot decides what level of automation to use to achieve these goals by selecting the level that provides the best increase in safety and reduced workload.

Note: When the autopilot is in use, the PF makes AFDS mode selections. The PM may select new altitudes, but must ensure the PF is aware of any changes. Both pilots must monitor AFDS mode annunciations and the current FMC flight plan.

777 Flight Crew Training Manual

Automatic systems give excellent results in the vast majority of situations. Deviations from expected performance are normally due to an incomplete understanding of their operations by the flight crew. When the automatic systems do not perform as expected, the pilot should reduce the level of automation until proper control of path and performance is achieved. For example, if the pilot failed to select the exit holding feature when cleared for the approach, the airplane will turn outbound in the holding pattern instead of initiating the approach. At this point, the pilot may select **HEADING SELECT** and continue the approach while using other automated features. A second example, if the airplane levels off unexpectedly during climb or descent with **VNAV** engaged, **FLCH** may be selected to continue the climb or descent until the **FMC** can be programmed.

Early intervention prevents unsatisfactory airplane performance or a degraded flight path. Reducing the level of automation as far as manual flight may be necessary to ensure proper control of the airplane is maintained. The pilot should attempt to restore higher levels of automation only after airplane control is assured. For example, if an immediate level-off in climb or descent is required, it may not be possible to comply quickly enough using the **AFDS**. The **PF** should disengage the autopilot and level off the airplane manually at the desired altitude. After level off, set the desired altitude in the **MCP**, select an appropriate pitch mode and re-engage the autopilot.

Recommended Pitch and Roll Modes

If the **LEGS** page and map display reflect the proper sequence and altitudes, **LNAV** and **VNAV** are recommended. If **LNAV** is not used, use an appropriate roll mode. When **VNAV** is not used, the following modes are recommended:

FLCH has logic to allow shallow climbs and descents for small altitude changes. There is no need to use **V/S** mode for passenger comfort.

If unplanned speed or altitude restrictions are imposed during the arrival, the continued use of **VNAV** may induce an excessive workload. If this occurs, use **FLCH** or **V/S** as appropriate.

MCP Altitude Setting Techniques Using VNAV

When using **VNAV** for published instrument departures, arrivals, and approaches, the following recommendations should avoid unnecessary level-offs while ensuring minimum altitudes are met.

If waypoints with altitude constraints are not closely spaced, the normal **MCP** altitude setting technique is recommended.

If waypoints with altitude constraints are closely spaced to the extent that crew workload is adversely affected and unwanted level-offs are a concern, an alternate MCP altitude setting technique can be used with operator approval.

Note: When the alternate MCP altitude setting technique is used, the selection of a pitch mode other than VNAV PTH or VNAV SPD will result in risk of violating altitude constraints.

Normal MCP Altitude Setting Technique using VNAV

The following MCP altitude setting technique is normally used during published instrument departures, arrivals, and approaches when waypoints with altitude constraints are not closely spaced:

- during climbs, maximum or hard altitude constraints should be set in the MCP. Minimum crossing altitudes need not be set in the MCP. The FMC alerts the crew if minimum altitude constraints will not be satisfied
- during descent, set the MCP altitude to the next constraint or clearance altitude, whichever will be reached first
- just prior to reaching the constraint, when compliance with the constraint is assured, and cleared to the next constraint, reset the MCP to the next constraint.

In the following example, the airplane has been cleared from cruise level to “Descend Via” a STAR with published altitude constraints at or above FL 190 and at 13,200 feet. During descent, when the crew confirms the airplane will be at or above FL 190 for the corresponding waypoint, set the MCP to 13,200 feet.

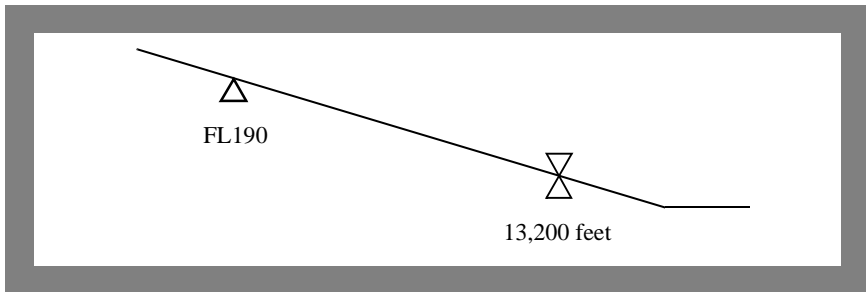

Alternate MCP Altitude Setting Technique using VNAV

[Appendix A.2.2](#)

777 Flight Crew Training Manual

When approved by the operator, the following MCP altitude setting technique may be used during published instrument departures, arrivals, and approaches where altitude constraints are closely spaced to the extent that crew workload is adversely affected and unwanted level-offs are a concern:

- for departures, set the highest of the closely-spaced constraints
- for arrivals, initially set the lowest of the closely spaced altitude constraints or the FAF altitude, whichever is higher

Note: When approved by the operator, this technique may also be used for Tailored Arrivals (TA) regardless of how closely the altitude constraints are spaced.

In the following example, the airplane has been cleared from cruise level to “Descend Via” a STAR with published altitude constraints at or above FL 190, followed by three additional descent constraints, the lowest being at 13,200 feet. In this case, when the crew confirms the airplane will be at or above FL 190 for the corresponding waypoint, set the MCP to 13,200 feet, even though there are two altitude constraints before 13,200 feet.

Note: When using the alternate technique, the FMC generated path should be checked against each altitude constraint to ensure that the path complies with all constraints.

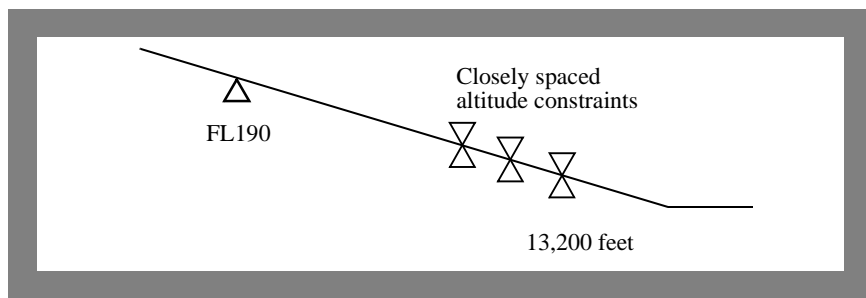

AFDS Mode Control Panel Faults

In-flight events have occurred where various AFDS pitch or roll modes, such as LNAV, VNAV or HDG SEL became un-selectable or ceased to function normally. Typically, these types of faults do not generate a failure annunciation. These faults may be caused by an MCP hardware (switch) problem.

If an AFDS anomaly is observed where individual pilot-selected AFDS modes are not responding normally to MCP switch selections, attempt to correct the problem by disengaging the autopilot and selecting both flight director switches to OFF. This clears all engaged AFDS modes. When an autopilot is re-engaged or a flight director switch is selected ON, the AFDS default pitch and roll modes should engage. The desired AFDS pitch and roll modes may then be selectable.



777 Flight Crew Training Manual

If this action does not correct the fault condition, the desired flight path can be maintained by selecting an alternate pitch or roll mode. Examples are included in the following table:

Inoperative or Faulty Autopilot Mode	Suggested Alternate Autopilot Mode or Crew Technique
HDG SEL or HDG HOLD	Set desired heading, disengage AFDS and manually roll wings level on the desired heading, and re-engage the AFDS. The AFDS will hold the established heading.
LNAV	Use HDG SEL or TRK SEL to maintain the airplane track on the magenta FMC course.
VNAV SPD or VNAV PTH (climb or descent)	Use FLCH, V/S or FPA. V/S or FPA should be selected for descent on final approach.
VNAV PTH (cruise)	Use altitude hold. If altitude hold is not directly selectable, use FLCH to automatically transition to altitude hold.
LOC	Use LNAV. Monitor and fly the approach referencing localizer raw data.
G/S	Use V/S, FPA or VNAV PTH to descend on an ILS approach. Monitor and fly the approach referencing glide slope raw data.

Pilot Incapacitation

Pilot incapacitation occurs frequently compared with other routinely trained non-normal conditions. It has occurred in all age groups and during all phases of flight. Incapacitation occurs in many forms ranging from sudden death to subtle, partial loss of mental or physical performance. Subtle incapacitations are the most dangerous and they occur the most frequently. Incapacitation effects can range from loss of function to unconsciousness or death.

The key to early recognition of pilot incapacitation is the regular use of crew resource management concepts during flight deck operation. Proper crew coordination involves checks and crosschecks using verbal communications. Routine adherence to standard operating procedures and standard profiles can aid in detecting a problem. Suspicion of some degree of gross or subtle incapacitation should also be considered when a crewmember does not respond to any verbal communication associated with a significant deviation from a standard procedure or standard flight profile. Failure of any crewmember to respond to a second request or a checklist response is cause for investigation.

777 Flight Crew Training Manual

If you do not feel well, let the other pilot know and let that pilot fly the airplane. During flight, crewmembers should also be alert for incapacitation of the other crewmember.

Crew Action Upon Confirming Pilot Incapacitation

If a pilot is confirmed to be incapacitated, the other pilot should take over the controls and check the position of essential controls and switches.

- after ensuring the airplane is under control, engage the autopilot to reduce workload
- declare an emergency
- use the cabin crew (if available). When practical, try to restrain the incapacitated pilot and slide the seat to the full-aft position. The shoulder harness lock may be used to restrain the incapacitated pilot
- flight deck duties should be organized to prepare for landing
- consider using help from other pilots or crewmembers aboard the airplane.

Turbulent Air Penetration

Severe turbulence should be avoided if at all possible. However, if severe turbulence is encountered, use the turbulent air penetration procedure listed in the Supplementary Procedures chapter of the FCOM. Turbulent air penetration speeds provide high/low speed margins in severe turbulent air.

During manual flight, maintain wings level and smoothly control attitude. Use the attitude indicator as the primary instrument. In extreme updrafts or downdrafts, large altitude changes may occur. Do not use sudden or large control inputs. After establishing the trim setting for penetration speed, do not change pitch trim. Allow altitude and airspeed to vary and maintain attitude. However, do not allow the airspeed to decrease and remain below the turbulent air penetration speed because stall/buffet margin is reduced. Maneuver at bank angles below those normally used. Set thrust for penetration speed and avoid large thrust changes. Flap extension in an area of known turbulence should be delayed as long as possible because the airplane can withstand higher gust loads with the flaps up.

Normally, no changes to cruise altitude or airspeed are required when encountering moderate turbulence. If operating at cruise thrust limits, it may be difficult to maintain cruise speed. If this occurs, select a higher thrust limit (if available) or descend to a lower altitude.

Electronic Flight Control System

The electronic flight control system generates control surface commands for airplane control in all three axes. The system tailors the control surface commands to provide exceptional handling qualities and a smoother ride for the passengers.

**777 Flight Crew Training Manual**

The primary difference from a conventional airplane is in the pitch axis. A control column input commands a pitch maneuver instead of commanding a surface to move, so anything else that tries to change the pitch attitude or flight path will be countered by the flight control system. Therefore, the system minimizes the airplane pitch response to thrust changes, configuration changes, turbulence and turns.

Thrust changes no longer need to be countered with a column input. This minimizes pilot work load during accelerations and decelerations. However, for a climb, as thrust is applied, the pitch attitude must be increased to begin the climb. For a descent, as thrust is reduced to idle, the pitch attitude must be decreased to begin the descent.

Speedbrake or flap changes no longer need to be countered with a column input. The flight control system automatically counters the change in lift. A small pitch change may be noticed as the flight control system changes the pitch attitude to keep the flight path relatively constant

For turns up to 30° of bank, the pilot does not need to add column back pressure to maintain level flight. For turns of more than 30° of bank, additional column back pressure is required.

For a roll or yaw asymmetry such as an out of rig or failed control surface that is not in the commanded position, the pilot must make a control input and trim as needed. The system does not automatically counter the asymmetry.

The pilot still needs to trim for speed changes. Column forces increase when out of trim to provide the conventional speed error cue.

777 Flight Crew Training Manual
Handling Characteristics

Condition	Conventional	777
Airplane pitch response due to: <ul style="list-style-type: none"> • thrust changes • turbulence • configuration changes • turns (up to 30° bank) 	Pilot counters with column and trim	Flight control system counters with elevator and stabilizer.
Airspeed changes	Pilot counters with column and trim (speed stability)	
Thrust asymmetry on the ground	Pilot counters with pedal	TAC partially counters with rudder and moves pedals for awareness. Pilot pedal input required.
Thrust asymmetry in the air	Pilot counters with wheel and/or pedal. Manual rudder trim for long term	TAC counters with rudder and moves pedals for awareness.
Thrust asymmetry with an engine in reverse thrust	Pilot counters with pedal	
Crosswind on takeoff	Pilot counters with pedal and wheel	
Roll or yaw asymmetry in the air. (e.g., out of rig)	Pilot counters the roll with wheel. Manual rudder trim for long term	



Intentionally
Blank



Ground Operations

Chapter 2

Table of Contents

Section TOC

Preface **2.1**

Preflight **2.1**
 Static Port Obstructions 2.1

Takeoff Briefing **2.1**

Push Back or Towing **2.2**

Taxi **2.2**
 Taxi General 2.2
 Flight Deck Perspective 2.4
 Thrust Use 2.5
 Backing with Reverse Thrust 2.5
 Taxi Speed and Braking 2.5
 Antiskid Inoperative 2.6
 Tiller/Rudder Pedal Steering 2.6
 Turning Radius and Gear Tracking 2.7
 Visual Cues and Techniques for Turning while Taxiing 2.8
 Turns of 180 Degrees 2.8
 180 Degree (Pivot) Turns in Less than 147.6 feet / 45 m 2.12
 Taxi - Adverse Weather 2.14
 Engine Out Taxi 2.15



Intentionally
Blank

Preface

This chapter outlines the recommended operating practices and techniques during ground operations, including pushback, engine start and taxi. Taxi operations during adverse weather are also addressed. The recommended operating practices and techniques discussed in this chapter improve crew coordination, enhance safety and provide a basis for standardization.

Preflight

Static Port Obstructions

Fluctuating and inaccurate airspeed and altimeter indications after takeoff have been attributed to static ports obstructed by ice formed while the airplane was on the ground. Precipitation or water rundown after snow removal may freeze on or near the static ports. This may cause an ice buildup which disturbs airflow over the static ports resulting in erroneous airspeed and altimeter readings, even when static ports appear to be clear. Since static ports and the surrounding surfaces are not heated when probe heat is activated, a thorough preflight inspection and clearing of all contaminants around the static ports are critical.

The aircrew should pay particular attention to the static ports during the exterior inspection when the airplane has been subjected to freezing precipitation. Clear ice on the static ports can be difficult to detect. If in doubt, contact maintenance for assistance.

Takeoff Briefing

The takeoff briefing should be accomplished as soon as practical so it does not interfere with the final takeoff preparations.

The takeoff briefing is a description of the departure flight path with emphasis on anticipated track and altitude restrictions. It assumes normal operating procedures are used. Therefore, it is not necessary to brief normal or standard takeoff procedures. Additional briefing items may be required when any elements of the takeoff and/or departure are different from those routinely used. These may include:

- adverse weather
- adverse runway conditions
- unique noise abatement requirements
- dispatch using the minimum equipment list

- special engine out departure procedures (if applicable)
 - any other situation where it is necessary to review or define crew responsibilities.
-

Push Back or Towing

Appendix A.2.2

Pushback and towing present serious hazards to ground personnel. There have been many accidents where personnel were run over by the airplane wheels during the pushback or towing process. Good communication between the flight deck and ground personnel are essential for a safe operation.

Pushback or towing involves three phases:

- positioning and connecting the tug and tow bar
- moving the airplane
- disconnecting the tow bar.

The headset operator, who is walking in the vicinity of the nose wheels, is usually the person injured or killed in the majority of the accidents. Procedures that do not have personnel in the vicinity of the nose wheels help to reduce the possibility of these type accidents.

Note: Pushback or tow out is normally accomplished with all hydraulic systems pressurized and the nose wheel steering locked out.

The captain should ensure that all appropriate checklists are completed prior to airplane movement. All passengers should be in their seats, all doors closed and all equipment away from the airplane. After the tow tractor and tow bar have been connected, obtain a pushback or towing clearance from ground control. Engine start may be accomplished during pushback or towing, or delayed until pushback or towing is completed. Ground personnel should be on headset to observe and communicate any possible safety hazards to the flight crew.

Note: The airplane should not be taxied away from a gate, or pushback position, unless the marshaller indicates the airplane is clear to taxi.

Taxi

Taxi General

An airport diagram should be readily available to each crewmember during taxi. The following guidelines aid in conducting safe and efficient taxi operations:

Prior to Taxi

- both pilots verify that the correct airplane position is in the FMC
- brief applicable items from airport diagrams and related charts

777 Flight Crew Training Manual

- ensure both crewmembers understand the expected taxi route
- write down the taxi clearance when received.

During Taxi

- progressively follow taxi position on the airport diagram
- during low visibility conditions, call out all pertinent signs to verify position
- if unfamiliar with the airport consider requesting a FOLLOW ME vehicle or progressive taxi instructions
- use standard radio phraseology
- read back all clearances. If any crewmember is in doubt regarding the clearance, verify taxi routing with the assigned clearance or request clarification. Stop the airplane if the clearance is in doubt
- if ground/obstruction clearance is in doubt, stop the airplane and verify clearance or obtain a wing-walker
- avoid distractions during critical taxi phases; plan ahead for checklist accomplishment and company communications
- consider delaying checklist accomplishment until stopped during low visibility operations
- do not allow ATC or anyone else to rush you
- verify the runway is clear (both directions) and clearance is received prior to entering a runway
- be constantly aware of the equipment, structures, and airplanes behind you when the engines are above idle thrust
- consider using the taxi light to visually indicate movement
- at night use all appropriate airplane lighting
- when entering any active runway ensure the exterior lights specified in the FCOM are illuminated.

Prior to Landing

- plan/brief the expected taxiway exit and route to parking.

After Landing

- ensure taxi instructions are clearly understood, especially when crossing closely spaced parallel runways
- delay non-essential radio or cabin communications until clear of all runways.

Flight Deck Perspective

There is a large area near the airplane where personnel, obstacles or guidelines on the ground cannot be seen, particularly in the oblique view across the flight deck. Special care must be exercised in the parking area and while taxiing. When parked, the pilot should rely on ground crew communications to a greater extent to ensure a safe, coordinated operation.

The pilot's seat should be adjusted for optimum eye position. The rudder pedals should be adjusted so that it is possible to apply maximum braking with full rudder deflection.

During taxiing, the pilot's heels should be on the floor, sliding the feet up on the rudder pedals only when required to apply brakes to slow the taxi speed, or when maneuvering in close quarters on the parking ramp.

Use of the Ground Maneuver Camera System (GMCS)

777-300

The GMCS, if available, can be useful in observing areas beneath the airplane. The GMCS is designed to aid the flight crew in determining the location of the nose and main gear wheels prior to or during turns while taxiing and its use should be limited to this function.

Direct visual observation out the flight deck windows remains the primary means of determining when to initiate turns and verifying airplane position relative to the intended taxi path. The Ground Maneuver Taxi display may be used sparingly to determine the proximity of the nose wheels and main gear to the taxi surface edge and when the main gear have cleared the inside corner of a turn.

Note: Use caution not to fixate on or be distracted by the video display at the expense of airplane control. Ensure at least one pilot is always looking outside the airplane.

Due to the position of the tail-mounted cameras, the following normal conditions may be observed:

- the formation of contrails just behind the engines
- venting of oil from the engines
- large displacement rapid flap/aileron movement.

No crew procedures or actions, except use as a reference during taxi operations, are predicated on the use of the GMCS. EICAS alert messages remain the primary means to direct the crew to the appropriate non-normal procedures. GMCS use during takeoff, approach and landing is prohibited.

777 Flight Crew Training Manual

Thrust Use

Thrust use during ground operation demands sound judgment and technique. Even at relatively low thrust the air blast effects from the large, high bypass engines can be destructive and cause injury. Airplane response to thrust lever movement is slow, particularly at high gross weights. Engine noise level in the flight deck is low and not indicative of thrust output. Idle thrust is adequate for taxiing under most conditions. A slightly higher thrust setting is required to begin taxiing. Allow time for airplane response before increasing thrust further.

Excess thrust while taxiing may cause foreign objects to deflect into the lower aft fuselage, stabilizer, or elevators, especially when the engines are over an unimproved surface. Run-ups and taxi operations should only be conducted over well maintained paved surfaces and runways.

Backing with Reverse Thrust

Backing with reverse thrust is prohibited.

Taxi Speed and Braking

To begin taxi, release brakes, smoothly increase thrust to minimum required for the airplane to roll forward, and then reduce thrust as required to maintain normal taxi speed. A turn should normally not be started until sufficient forward speed has been attained to carry the airplane through the turn at idle thrust.

The airplane may appear to be moving slower than it actually is due to the flight deck height above the ground. Consequently, the tendency may be to taxi faster than desired. This is especially true during runway turnoff after landing. The ground speed display on the flight instruments may be used to determine actual taxi speed. The appropriate taxi speed depends on turn radius and surface condition.

Taxi speed should be closely monitored during taxi out, particularly when the active runway is some distance from the departure gate. Normal taxi speed is approximately 20 knots, adjusted for conditions. On long straight taxi routes, speeds up to 30 knots are acceptable, however at speeds greater than 20 knots use caution when using the nose wheel steering tiller to avoid overcontrolling the nose wheels. When approaching a turn, speed should be slowed to an appropriate speed for conditions. On a dry surface, use approximately 10 knots for turn angles greater than those typically required for high speed runway turnoffs.

Note: High taxi speed combined with heavy gross weight and a long taxi distance can result in tire sidewall overheating.

Under normal conditions, differential braking and braking while turning should be avoided. Allow for decreased braking effectiveness on slippery surfaces.

Avoid following other airplanes too closely. Jet blast is a major cause of foreign object damage.

During taxi, the momentary use of idle reverse thrust may be needed on slippery surfaces for airplane control. The use of reverse thrust above reverse idle is not recommended due to the possibility of foreign object damage and engine surge. Consider having the airplane towed rather than relying on the extended use of reverse thrust for airplane control.

Note: If reverse thrust is selected after V speeds have been entered, the V speeds are removed from the airspeed display, and full TO thrust becomes the thrust limit for takeoff.

Carbon Brake Life

Brake wear is primarily dependent upon the number of brake applications. For example, one firm brake application causes less wear than several light applications. Continuous light applications of the brakes to keep the airplane from accelerating over a long period of time (riding the brakes) to maintain a constant taxi speed produces more wear than proper brake application.

During taxi, proper braking should involve a steady application of the brakes to decelerate the airplane. Release the brakes as lower speed is achieved. After the airplane accelerates, repeat the braking sequence.

Antiskid Inoperative

With antiskid inoperative, tire damage or blowouts can occur if moderate to heavy braking is used. With this condition, it is recommended that taxi speed be adjusted to allow for very light braking.

Tiller/Rudder Pedal Steering

The captain's and first officer's positions are equipped with a tiller steering control. The tiller is used to turn the nose wheels through the full range of travel at low taxi speeds. Maintain positive pressure on the tiller at all times during a turn to prevent the nose wheels from abruptly returning to center. Rudder pedal steering turns the nose wheels through a limited range of travel. Straight ahead steering and large radius turns may be accomplished with rudder pedal steering.

If nose wheel "scrubbing" occurs while turning, reduce steering angle and/or taxi speed. Avoid stopping the airplane in a turn as excessive thrust is required to start taxiing again.

Differential thrust may be required at high weights during tight turns. This should only be used as required to maintain the desired speed in the turn. After completing a turn, center the nose wheels and allow the airplane to roll straight ahead. This relieves stresses in the main and nose gear structure prior to stopping.

777 Flight Crew Training Manual
Main Gear Aft Axle Steering

Main gear aft axle steering provides shorter turn radius, reduces thrust requirements for tight turns, and minimizes tire scrubbing. Main gear aft axle steering operation is especially important at heavy weights where stress may be applied to wheels and tires. Excessive tire scrubbing and tire slippage can result from taxiing under these conditions with main gear aft axle steering inoperative.

Turning Radius and Gear Tracking

During all turning maneuvers, crews should be aware of their position relative to the nose and main landing gear. The pilot seat position is forward of the nose wheels and main gear as indicated in the tables in this chapter.

As the following diagram illustrates, while the airplane is turning, the main gear tracks inside the nose gear. The smaller the radius of the turn, the greater the distance that the main gear tracks inside the nose gear and the greater the need to steer the nose gear outside of the taxi path (oversteer).

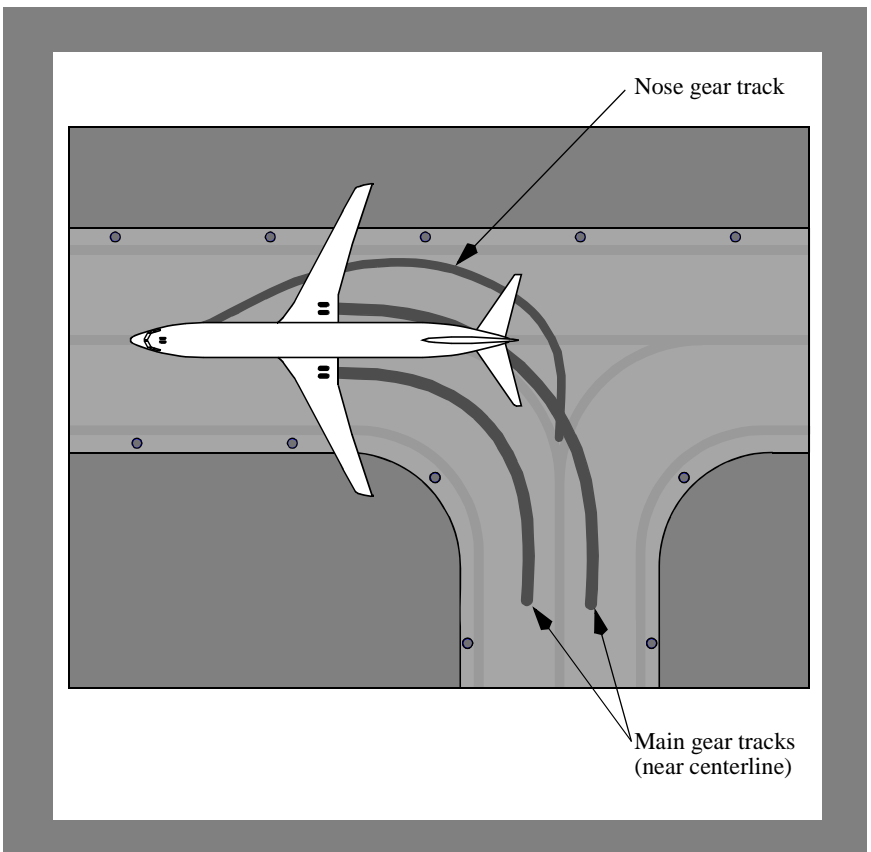

Visual Cues and Techniques for Turning while Taxiing

The following visual cues assume the pilot's seat is adjusted for proper eye position. The following techniques also assume a typical taxiway width. Since there are many combinations of turn angles, taxiway widths, fillet sizes and taxiway surface conditions, pilot judgment must dictate the point of turn initiation and the amount of nose wheel tiller required for each turn. Except for turns less than approximately 30°, speed should be 10 knots or less prior to turn entry. For all turns, keep in mind the main gear are located behind the nose wheels, which causes them to track inside the nose wheels during turns. The pilot position forward of the nose wheels and main gear is depicted in the table below.

Model	Pilot Seat Position (forward of nose gear) feet (meters)	Pilot Seat Position (forward of main gear) feet (meters)
777 - 200	12 (3.7)	97 (29.6)
777 - 200LR	12 (3.7)	97 (29.6)
777 - 300	12 (3.7)	114 (34.8)
777 - 300ER	12 (3.7)	114 (34.8)

Turns less than 90 degrees

During the turn, steer the nose wheels far enough beyond the centerline of the turn to keep the main gear close to the centerline.

Turns of 90 degrees or more

Initiate the turn as the intersecting taxiway centerline (or intended exit point) approaches the aft edge of the number 2 window. Initially use approximately full nose wheel steering tiller displacement. Adjust the tiller input as the airplane turns to keep the nose wheels outside of the taxiway centerline, near the outside radius of the turn. Nearing turn completion, when the main gear are clear of the inside radius, gradually release the tiller input as the airplane lines up with the intersecting taxiway centerline or intended taxi path.

Turns of 180 Degrees

If the available taxi surface is narrow, coordination with external observers may be required to complete the operation safely. Reference special aerodrome operating instructions, if available. In some cases (e.g., heavy weight, pilot uncertainty of runway and/or taxiway pavement edge locations and related safety margins, nearby construction, vehicles, potential FOD damage, etc.), towing the airplane to the desired location may be the safest option.

777 Flight Crew Training Manual

If a minimum radius 180° turn is necessary, consider using the ground crew to monitor the wheel path and provide relevant information as the turn progresses. The ground crew should be warned of the risk associated with jet blast and position themselves to avoid the hazard. Also ensure that obstacle clearance requirements are met. Since more than idle thrust is required, the flight crew must be aware of buildings or other objects in the area being swept by jet blast during the turn.

Note: Monitor the nose gear track closely, as it will leave the pavement in the turn before the main gear.

Approach the edge of the taxi surface at a shallow angle until the outboard side of the main gear wheels are near the edge. The lower outboard corner of the pilot's number 1 window is a good visual reference for the outboard side of the main gear wheels on the same side. The lower inboard corner of the pilot's number 1 window is also a good reference for the opposite side main gear wheels.

Note: Painted runway markings are slippery when wet and may cause skidding of the nose gear during the turn.

Turning radius can be reduced by following a few specific taxi techniques. Taxi the airplane so that the main gear tires are close to the runway edge. This provides more runway surface to make the turn. Stop the airplane completely with the thrust at idle. Hold the tiller to the maximum steering angle, release the brakes, then add thrust on the outboard engine. Only use the engine on the outboard side of the turn and maintain 5 to 10 knots during the turn to minimize turn radius. Light intermittent braking on the inside main gear helps decrease turn radius. Stopping the airplane in a turn is not recommended unless required to reduce the turn radius. As the airplane passes through 90° of turn, steer to place the main gear approximately on the runway centerline, then gradually reduce the tiller input as required to align the airplane with the new direction of taxi.

This technique results in a low speed turn and less runway being used. It does not impose undue stress on the landing gear and tires provided the wheel brakes are not locked during the turn. If the nose gear skids, a good technique is to apply the inside wheel brake briefly and keep the airplane turning with asymmetric thrust as needed. If the turnaround is planned on a surface significantly greater in width than the minimum required, a turn entry could be made, without stopping, at 5-10 knots speed, using intermittent inside wheel braking and thrust as needed. Wind, slope, runway or taxiway surface conditions, and center of gravity may also affect the turning radius.

The following diagrams show suggested airplane ground tracks for minimum radius 180° turns with various runway turnaround configurations. These ground tracks provide the best maneuver capability while providing the maximum runway length available for takeoff at the completion of the turn.

Techniques when using a Circular Turnaround

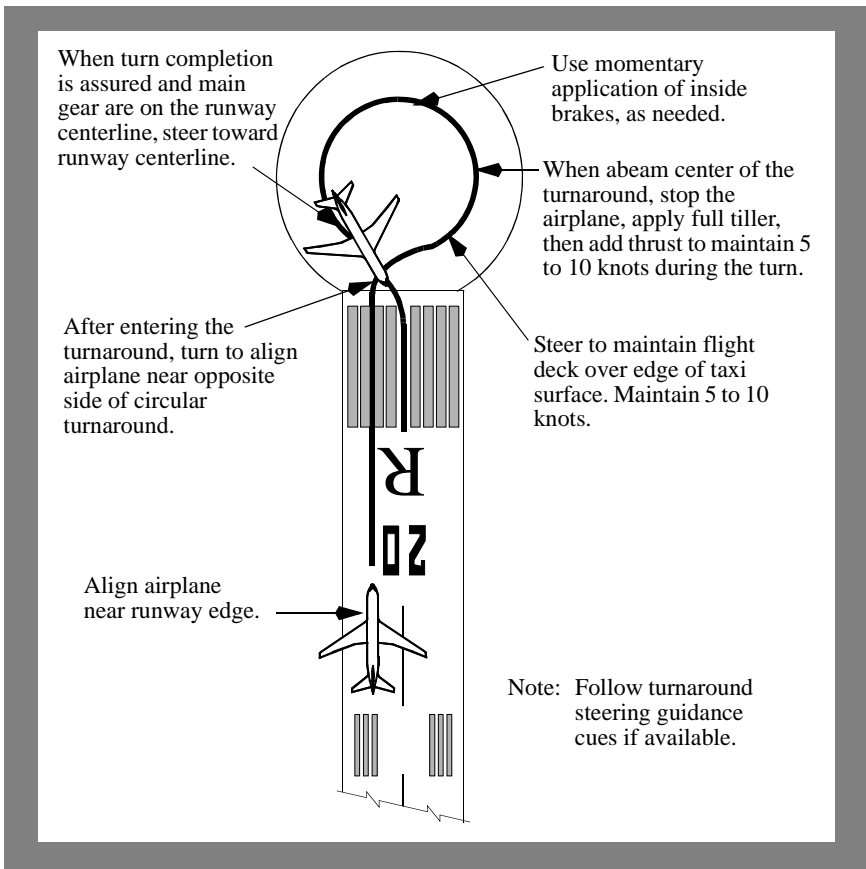

777 Flight Crew Training Manual

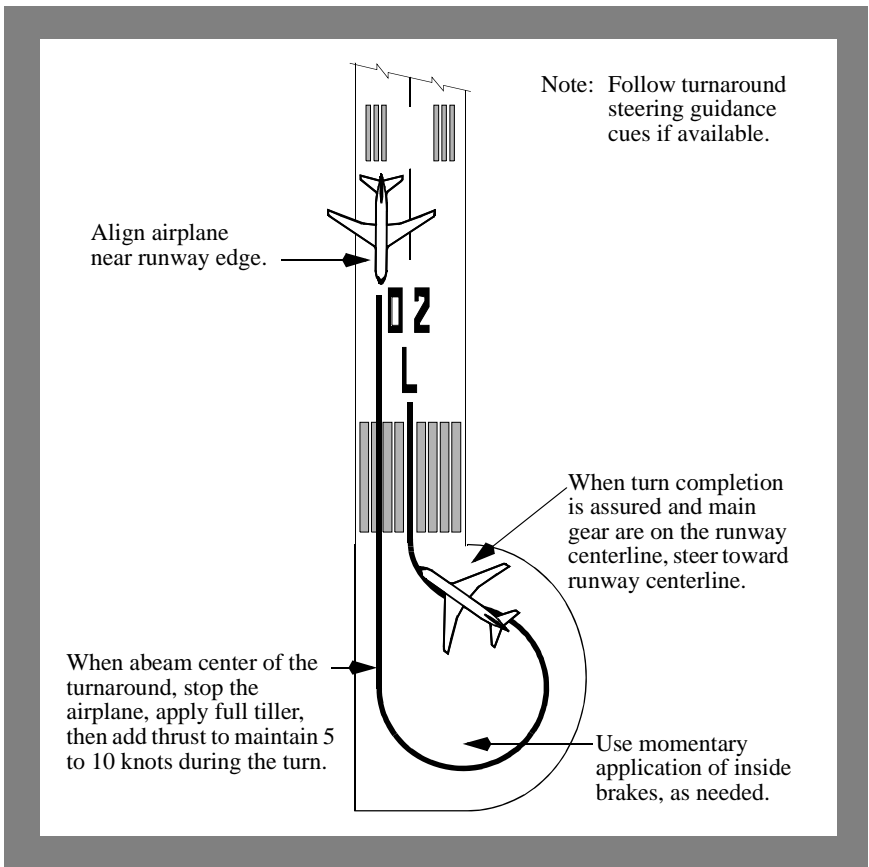
Techniques when using a Hammerhead Turnaround

Techniques when using a Hammerhead Turnaround

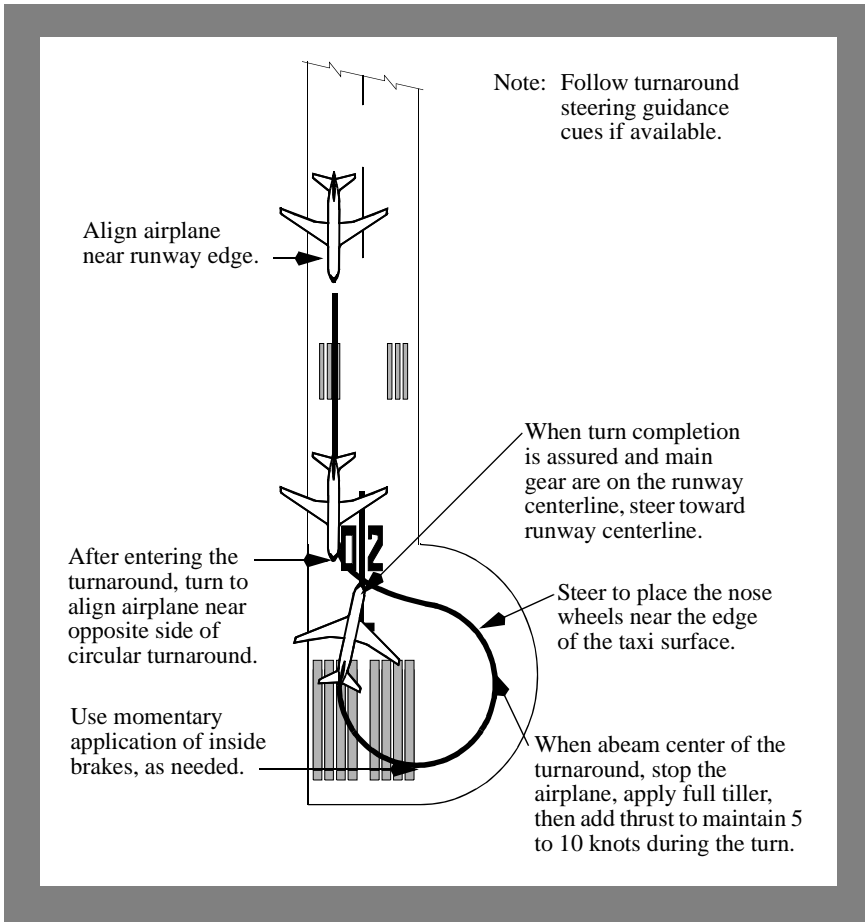

180 Degree (Pivot) Turns in Less than 147.6 feet / 45 m

If a non-normal or emergency situation requires that a turn be performed on a 147.6 feet (45 m) wide runway or taxi surface, towing is the preferred method. If a tow tug is not available and the turn must be performed, a pivot turn is recommended provided the following conditions are met:

- due to potentially high structural loads on pavement that is not solid, this method must not be used on a routine basis
- the pavement surface is sound and free of loose debris
- the airplane does not exceed maximum landing weight.

777 Flight Crew Training Manual

Recommended Pivot Turn Technique

If possible, choose the turn direction and location to minimize the potential for engine foreign object damage, jet blast damage and pavement damage during the turn.

Lineup the outside tires of the main landing gear near the outside edge of the edge of the taxi surface or runway. Bring the airplane to a complete stop with engines at idle thrust. If available, use a ground observer or ground maneuver camera to help accurately establish the airplane at the edge of the taxi surface prior to initiating the turn. If an observer is used to guide the lineup, the observer should be well clear of the area before the pivot turn is started.

Turn the tiller to the maximum steering angle and hold maximum steering angle until the nose wheels have cleared the far side of the pavement. Apply full braking pressure to the main gear on the side toward the inside of the turn. The braked landing gear truck must be locked until the nose wheels clear the far edge of the pavement. Apply sufficient thrust to the engine on the outside of the turn to pivot the airplane about the locked gear. The engine on the inside of the turn should remain at idle thrust.

Other considerations include:

- approximate pavement width required if the above method is used:

777-200, 777-200LR

- 126.0 feet (38.4 m)

777-300

- 143.1 feet (43.6 m)

777-300ER

- 143.2 feet (43.7m)

777-300, 777-300ER

Note: If the airplane is not initially lined up within approximately one foot (1/3 m) of the starting edge of the pavement, or if the inside main wheel brake is not locked throughout the turn, the turn may not be completed within the width of a 147.6 foot (45 m) pavement.

- large tire deflections and rubber trails are normal
- inspection of the main gear tires, the nose gear tires, and the pavement surface is recommended after completion of the pivot turn
- the resulting engine thrust on the outside engine may damage the runway shoulder surface, especially if it is unpaved
- the nose wheels may produce a scrubbing noise and vibration on the flight deck

- pivot turns on pavements that are not sound may cause pavement damage. In addition, if the pavement fails in such a way as to increase the forces between the pavement surface and the tires, gear and tire design loads may be exceeded with the potential for tire or gear damage
- loose debris may result in tire cuts which could lead to premature tire failure.

Taxi - Adverse Weather

Taxi under adverse weather conditions requires more awareness of surface conditions.

When taxiing on a slippery or contaminated surface, particularly with strong crosswinds, use reduced speeds. Use of differential engine thrust assists in maintaining airplane momentum through the turn. When nearing turn completion, placing both engines to idle thrust reduces the potential for nose gear skidding. Avoid using large nose wheel steering inputs to correct for skidding. Differential braking may be more effective than nose wheel steering on slippery or contaminated surfaces. If speed is excessive, reduce speed prior to initiating a turn.

Note: A slippery surface is any surface where the braking capability is less than that on a dry surface. Therefore, a surface is considered “slippery” when it is wet or contaminated with ice, standing water, slush, snow or any other deposit that results in reduced braking capability.

If icing conditions are present, use anti-ice as required by the FCOM. During prolonged ground operations, periodic engine run-ups should be accomplished to minimize ice build-up. These engine run-ups should be performed as defined in the FCOM.

Engine exhaust may form ice on the ramp and takeoff areas of the runway, or blow snow or slush which may freeze on airplane surfaces. If the taxi route is through slush or standing water in low temperatures, or if precipitation is falling with temperatures below freezing, taxi with flaps up. Extended or prolonged taxi times in heavy snow may necessitate de-icing prior to takeoff.

Low Visibility

Pilots need a working knowledge of airport surface lighting, markings, and signs for low visibility taxi operations. Understanding the functions and procedures to be used with stop bar lights, ILS critical area markings, holding points, and low visibility taxi routes is essential to conducting safe operations. Many airports have special procedures for low visibility operations. For example, airports operating under FAA criteria with takeoff and landing minimums below 1200 feet (350 m) RVR are required to have a low visibility taxi plan.

777 Flight Crew Training Manual

Flap Retraction after Landing

The Cold Weather Operations Supplementary Procedure defines how far the flaps may be retracted after landing in conditions where ice, snow, or slush may have contaminated the flap areas. If the flap areas are found to be contaminated, the flaps should not be retracted until maintenance has cleared the contaminants. Removal of the contaminants is a maintenance function addressed in the AMM.

Engine Out Taxi[Appendix A.2.3](#)

Engine Out Taxi (EOT) operations have the potential to save fuel and to reduce carbon emissions.

During EOT operations, the crew's attention should be focused on taxiing the airplane. Distractions should be kept to a minimum.

Boeing does not publish specific procedures for EOT operations. Each operator develops EOT policies, procedures, and flight crew familiarization materials specific to their operation and in accordance with the requirements of their regulatory authorities.



Intentionally
Blank



Takeoff and Initial Climb

Chapter 3

Table of Contents

Section TOC

Preface 3.1

Takeoff 3.1

 Takeoff - General 3.3

 Takeoff Flap Setting 3.3

 Thrust Management. 3.3

 Initiating Takeoff Roll. 3.3

 Rotation and Liftoff - All Engines 3.7

 Effect of Rotation Speed and Pitch Rate on Liftoff 3.9

 Center-Of-Gravity Effects. 3.10

Crosswind Takeoff 3.11

 Takeoff Crosswind Guidelines 3.11

 Directional Control 3.13

 Rotation and Takeoff. 3.13

 Gusty Wind and Strong Crosswind Conditions 3.13

Reduced and Derated Takeoff Thrust 3.14

 Reduced Takeoff Thrust (ATM) 3.15

 Derated Takeoff Thrust (Fixed Derate). 3.15

 Combination ATM and Fixed Derate 3.16

 Thrust Control 3.16

Improved Climb Performance Takeoff 3.17

Low Visibility Takeoff 3.17

Adverse Runway Conditions 3.17

Federal Aviation Regulation (FAR) Takeoff Field Length. 3.18

 FAR Takeoff 3.19



Rejected Takeoff Decision	3.20
Rejected Takeoff Maneuver	3.21
Go/Stop Decision Near V1	3.21
RTO Execution Operational Margins	3.22
Initial Climb - All Engines	3.26
Minimum Fuel Operation - Takeoff	3.26
Immediate Turn after Takeoff - All Engines	3.26
Roll Modes	3.27
Pitch Modes	3.27
Autopilot Engagement	3.27
Flap Retraction Schedule	3.28
Noise Abatement Takeoff	3.29
Takeoff - Engine Failure	3.30
General	3.30
Engine Failure Recognition	3.30
Rotation and Liftoff - One Engine Inoperative	3.30
Initial Climb - One Engine Inoperative	3.33
Immediate Turn after Takeoff - One Engine Inoperative	3.33
Autopilot Engagement - One Engine Inoperative	3.34
Flap Retraction - One Engine Inoperative	3.34
Flaps Up - One Engine Inoperative	3.34
Noise Abatement - One Engine Inoperative	3.35
Engine Failure During a Reduced Thrust (ATM) Takeoff	3.35
Engine Failure During a Derated Thrust (Fixed Derate) Takeoff ..	3.35
Engine Failure During a Combined ATM and Fixed Derate Takeoff	3.35



Preface

This chapter outlines the recommended operating practices and techniques for takeoff and initial climb. Engine failure during takeoff/initial climb is also addressed. The discussion portion of each illustration highlights important information.

The flight profile illustrations represent the recommended basic configuration during the accomplishment of the flight maneuvers, and provides a basis for standardization and crew coordination.

Takeoff

Normal takeoff procedures satisfy typical noise abatement requirements. Some airports may have special procedures which require modification of the takeoff profile.

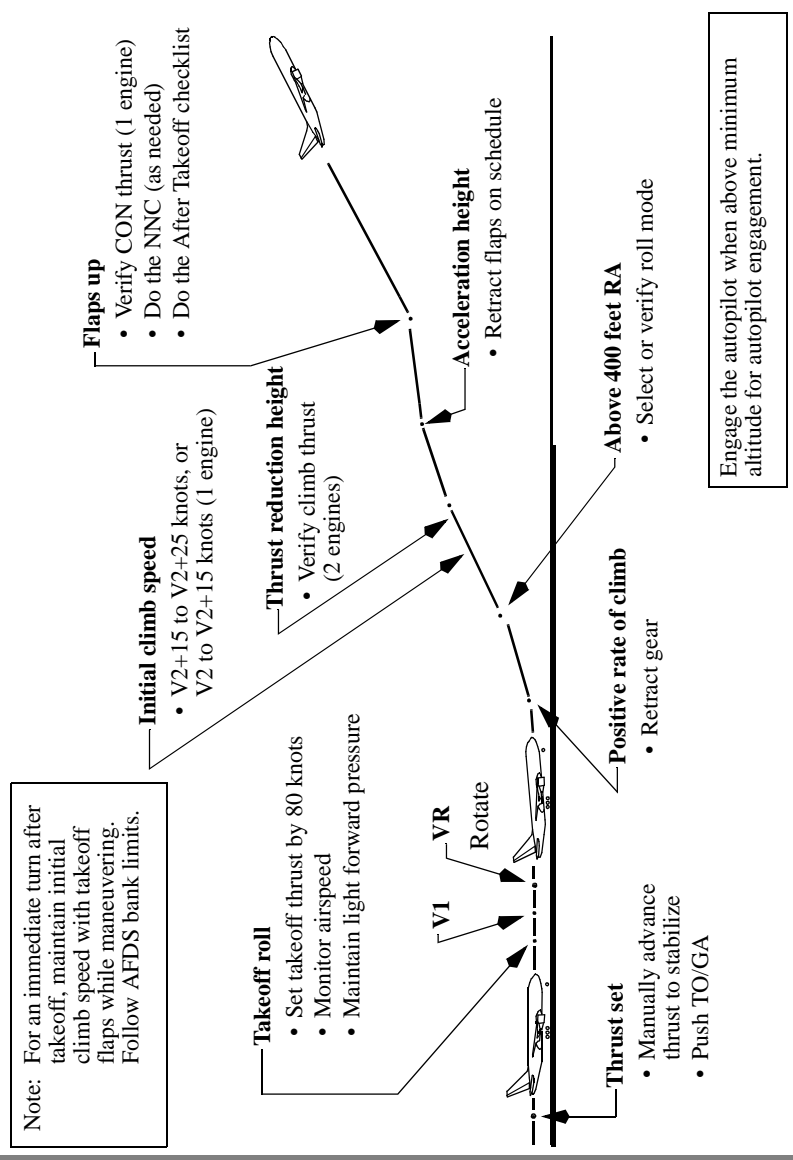

777 Flight Crew Training Manual

Takeoff - General

As part of the before start procedure, review the takeoff reference page to ensure the entries are correct and the preflight is complete. Ensure V2 is set on the MCP. The map display, map range and LEGS page sequence should be consistent with the departure procedure.

Review the LEGS page for any climb constraints. Ensure the climb page contains the appropriate altitude and airspeed restrictions consistent with the departure procedure.

Note: The lower center MFD is normally blank for takeoff to reduce the display of unnecessary information.

The PF normally displays the takeoff reference page on the CDU. Display of the takeoff reference page allows the crew to have immediate access to V-speeds during takeoff in the event that V-speeds are inadvertently removed from the airspeed display. After changes to the takeoff briefing have been updated during the Before Takeoff Procedure, the PF may elect to display the climb page for takeoff. However, to reduce heads down activity, climb constraint modification immediately after takeoff should normally be accomplished on the mode control panel. Modify the climb page when workload permits. The PM normally displays the LEGS page during takeoff and departure to allow timely route modification if necessary.

Takeoff Flap Setting

For takeoffs, when conditions permit, consider using larger flap settings to provide shorter takeoff distance. The minimum tail clearance remains constant for all takeoff flap settings. The rotation speed schedules were developed to maintain a constant tail clearance.

Thrust Management

The Electronic Engine Control (EEC) simplifies thrust management procedures. Having the EEC functioning does not relieve the pilots from monitoring the engine parameters and verifying proper thrust is obtained.

High thrust settings from jet engine blast over unpaved surfaces or thin asphalt pavement intended only to support occasional airplane movements can cause structural blast damage from loose rocks, dislodged asphalt pieces, and other foreign objects. Ensure run ups and takeoff operations are only conducted over well maintained paved surfaces and runways.

Initiating Takeoff Roll

Autothrottle and flight director use is recommended for all takeoffs. However, do not follow F/D commands until after liftoff.



777 Flight Crew Training Manual

A rolling takeoff procedure is recommended for setting takeoff thrust. It expedites the takeoff and reduces the risk of foreign object damage or engine surge/stall due to a tailwind or crosswind. Flight test and analysis prove that the change in takeoff roll distance due to the rolling takeoff procedure is negligible when compared to a standing takeoff.

Rolling takeoffs are accomplished in two ways:

- if cleared for takeoff before or while entering the runway, maintain normal taxi speed. When the airplane is aligned with the runway centerline ensure the nose wheel steering tiller is released and apply takeoff thrust by advancing the thrust levers to approximately 1.05 EPR (PW and RR) or 55% N1 (GE). Allow the engines to stabilize momentarily then promptly advance the thrust levers to takeoff thrust (autothrottle TO/GA). There is no need to stop the airplane before increasing thrust.
- if holding in position on the runway, ensure the nose wheel steering tiller is released, release brakes, then apply takeoff thrust as described above.

Note: Brakes are not normally held with thrust above idle unless a static run-up in icing conditions is required.

A standing takeoff procedure may be accomplished by holding the brakes until the engines are stabilized, ensure the nose wheel steering tiller is released, then release the brakes and promptly advance the thrust levers to takeoff thrust (autothrottle TO/GA).

Note: If the nose wheel steering tiller is not released before application of takeoff thrust, a configuration warning may occur due to the aft axle steering being out of the locked position.

Allowing the engines to stabilize provides uniform engine acceleration to takeoff thrust and minimizes directional control problems. This is particularly important if crosswinds exist or the runway surface is slippery. The exact initial setting is not as important as setting symmetrical thrust. If thrust is to be set manually, smoothly advance thrust levers toward takeoff thrust.

Note: During tailwind conditions, slight EPR (as installed) fluctuations may occur on some engines before 5 knots forward airspeed.

Note: Allowing the engines to stabilize for more than approximately 2 seconds before advancing thrust levers to takeoff thrust may adversely affect takeoff distance.

777 Flight Crew Training Manual

After thrust is set, a small deviation in N1 or EPR between engines should not warrant a decision to reject the takeoff unless this deviation is accompanied by a more serious event. (Refer to the QRH, Maneuvers Chapter, Rejected Takeoff, for criteria.) Ensure the target N1 is set by 80 knots, but minor adjustments may be made, if needed, immediately after 80 knots. Due to variation in engine types, thrust settings, runway conditions, etc., it is not practical to specify a precise tolerance in N1 or EPR difference between engines for the takeoff thrust setting.

If an engine exceedance occurs after thrust is set and the decision is made to continue the takeoff, do not retard the thrust lever in an attempt to control the exceedance. Retarding the thrust levers after thrust is set invalidates takeoff performance. When the PF judges that altitude (minimum 400 feet AGL) and airspeed are acceptable, the thrust lever should be retarded until the exceedance is within limits and the appropriate NNC accomplished.

Use of the nose wheel steering tiller is not recommended above 30 knots. However, pilots must use caution when using the nose wheel steering tiller above 20 knots to avoid over-controlling the nose wheels resulting in possible loss of directional control.

Light forward pressure is held on the control column. Keep the airplane on centerline with rudder pedal steering and rudder. The rudder becomes effective between 40 and 60 knots. Maximum nose wheel steering effectiveness is available when above taxi speeds by using rudder pedal steering.

Regardless of which pilot is making the takeoff, the captain should keep one hand on the thrust levers until V1 in order to respond quickly to a rejected takeoff condition. After V1, the captain's hand should be removed from the thrust levers.

The PM should monitor engine instruments and airspeed indications during the takeoff roll and announce any abnormalities. The PM should announce passing 80 knots and the PF should verify that his airspeed indicator is in agreement.

A pitot system blocked by protective covers or foreign objects can result in no airspeed indication, or airspeed indications that vary between instruments. It is important that aircrews ensure airspeed indicators are functioning and reasonable at the 80 knot callout. If the accuracy of either primary airspeed indication is in question, reference the standby airspeed indicator. Another source of speed information is the ground speed indication. Early recognition of a malfunction is important in making a sound go/stop decision. Refer to the Airspeed Unreliable section in chapter 8 for an expanded discussion of this subject.

**777 Flight Crew Training Manual**

The PM should verify that takeoff thrust has been set and the throttle hold mode (HOLD) is engaged. Once HOLD annunciates, the autothrottle cannot change thrust lever position, but thrust levers can be positioned manually. The HOLD mode remains engaged until VNAV engagement or another thrust mode is selected.

Note: Takeoff into headwind of 20 knots or greater may result in HOLD before the autothrottle can make final thrust adjustments.

The HOLD mode protects against thrust lever movement if a system fault occurs. Lack of the HOLD annunciation means the protective feature may not be active. If HOLD annunciation does not appear, no crew action is required unless a subsequent system fault causes unwanted thrust lever movement. As with any autothrottle malfunction, the autothrottle should then be disconnected and desired thrust set manually.

777 Flight Crew Training Manual
Rotation and Liftoff - All Engines

Takeoff speeds are established based on minimum control speed, stall speed, and tail clearance margins. Shorter-bodied airplanes are normally governed by stall speed margin while longer-bodied airplanes are normally limited by tail clearance margin. When a smooth continuous rotation is initiated at VR, tail clearance margin is assured because computed takeoff speeds depicted in the airport analysis or FMC are developed to provide adequate tail clearance.

Above 80 knots, relax the forward control column pressure to the neutral position. For optimum takeoff and initial climb performance, initiate a smooth continuous rotation at VR toward 15° of pitch attitude. The use of stabilizer trim during rotation is not recommended. After liftoff, use the attitude indicator as the primary pitch reference. The flight director, in conjunction with indicated airspeed and other flight instruments is used to maintain the proper vertical flight path.

Note: The flight director pitch command is not used for rotation.

With a consistent rotation technique, where the pilot uses approximately equal control forces and similar visual cues, the resultant rotation rate differs slightly depending upon airplane body length.

Note: Do not adjust takeoff speeds or control forces to compensate for increased body length.

Using the technique above, liftoff attitude is achieved in approximately 4 seconds. Resultant rotation rates vary from 2 to 2.5 degrees/second with rates being lowest on longer airplanes.

Typical Rotation, All Engines

The following figure shows typical rotation with all engines operating.

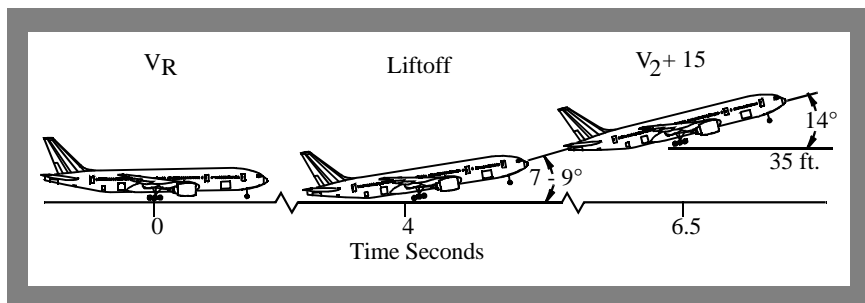

Retract the landing gear after a positive rate of climb is indicated on the altimeter. Retract flaps in accordance with the technique described in this chapter.

Typical Takeoff Tail Clearance

The following diagram and table show the effect of flap position on liftoff pitch attitude and minimum tail clearance during takeoff. Additionally, the last column shows the pitch attitude for tail contact with wheels on the runway and landing gear struts extended. For a discussion of tail strike procedures see chapter 8 and the Tail Strike NNC.

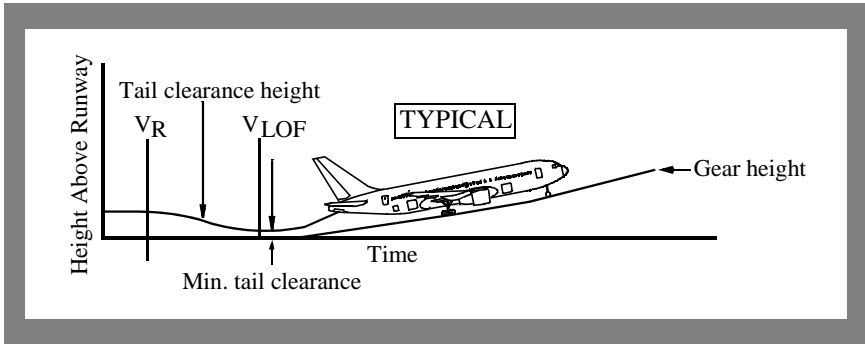

Model	Flaps	Liftoff Attitude (degrees)	Minimum Tail Clearance inches (cm)	Tail Strike Pitch Attitude (degrees)
777-200	5, 15, 20	8.5	37 (94)	12.1
777-200LR	5, 15, 20	8.5	37 (94)	12.1
777-300	5, 15, 20	7.0	36 (91)	8.9
777-300ER	5, 15, 20	8.5	30 (76)	10.0

Note: 777-300ER values valid when the Semi-Levered Gear (SLG) is operative. When the SLG is inoperative, use 777-300 values.

Effect of Rotation Speed and Pitch Rate on Liftoff

Takeoff and initial climb performance depend on rotating at the correct airspeed and proper rate to the rotation target attitude. Early or rapid rotation may cause a tail strike. Late, slow, or under-rotation increases takeoff ground roll. Any improper rotation decreases initial climb flight path.

An improper rotation can have an effect on the command speed after liftoff. If the rotation is delayed beyond $V_2 + 15$, the speed commanded by the flight director is rotation speed up to a maximum of $V_2 + 25$. An earlier liftoff does not affect the commanded initial climb speed, however, either case degrades overall takeoff performance.

The following diagram shows how a slow or under rotation during takeoff increases the distance to a height of 35 feet compared to a normal rotation.

Slow or Under Rotation (Typical)

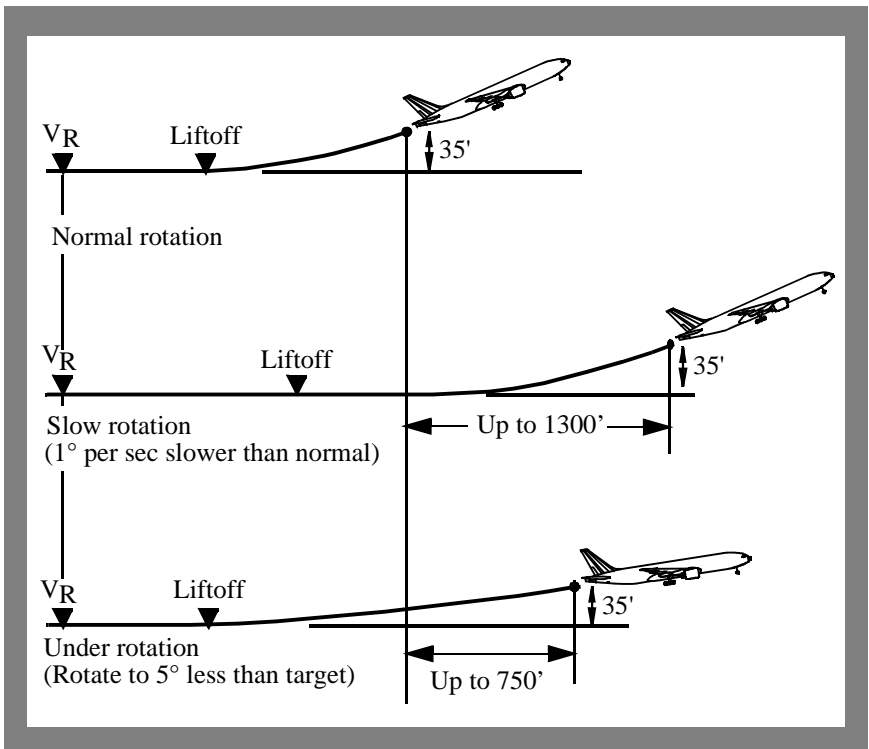



Center-Of-Gravity Effects

When taking off at light weight and with an aft CG, the combination of full thrust, rapid thrust application, and sudden brake release may tend to pitch the nose up, reducing nosewheel steering effectiveness. With CG at or near the aft limit, maintain forward pressure on the control column until 80 knots to increase nosewheel steering effectiveness. Above 80 knots, relax the forward control column pressure to the neutral position. At light weight and aft CG, use of reduced thrust and rolling takeoff technique is recommended whenever possible. The rudder becomes effective between 40 and 60 knots.

Operation with Alternate Forward Center of Gravity Limit for Takeoff

Takeoff performance is based on the forward CG limitations as defined in the AFM. However, takeoff performance can be improved by taking credit for an alternate (further aft) forward CG limit if shown in the AFM. Use of this data provides higher performance-limited takeoff weights than the basic AFM performance data.

Typically alternate forward CG is used to increase performance-limited takeoff weight for field length, climb or obstacle limited departures. Another potential benefit of alternate forward CG is to allow greater thrust reduction which increases engine reliability and reduces engine maintenance costs. However, this improved performance capability is only available if the operator has the certified data in their AFM and has approval from their regulatory agency to operate the airplane at an alternate forward CG limit.

A more aft CG increases the lift available at a given angle of attack due to the reduction in nose up trim required from the horizontal stabilizer. This allows VR and V2 to be reduced, which in turn reduces the field length required for takeoff. Reduction in field length required can also permit an increased field length limited weight. In most instances this reduction in nose up trim also results in a decrease in drag which improves the airplane's climb capability.

Note: The FMC calculated takeoff speeds and QRH takeoff speeds are not valid for operations using alternate forward CG. Takeoff speeds must be calculated using alternate forward CG performance data normally provided by dispatch or flight operations.

Crosswind Takeoff

The crosswind guidelines shown below were derived through flight test data, engineering analysis, and flight simulator evaluations.

Note: Engine stress and possible engine surge can occur with a strong crosswind or tailwind component if takeoff thrust is set before brake release. Therefore, the rolling takeoff procedure is strongly advised when crosswinds exceed 20 knots or tailwinds exceed 5 knots.

Takeoff Crosswind Guidelines

[Appendix A.2.3](#)

Crosswind guidelines are not considered limitations. Crosswind guidelines are provided to assist operators in establishing their own crosswind policies.

Takeoff crosswind guidelines increase with higher gross weights and more forward CGs and assume an engine out RTO and proper pilot technique. On slippery runways, crosswind guidelines are a function of runway surface condition and airplane loading. When using the following table:

- interpolation is permitted for intermediate gross weights and CG positions.
- for low gross weights where the takeoff aft CG limit is forward of 39% MAC and the airplane CG is aft of 35% MAC, interpolate using crosswinds from the columns labeled “Takeoff Aft Limit” and “35% MAC”.



777 Flight Crew Training Manual

TO Weight 1,000 lbs/kgs	Runway Condition	Center of Gravity (% MAC)			
		30% MAC or less	35% MAC	39% MAC	44% MAC
550 lbs / 250 kgs and above	Dry	40 K	40 K	40 K	29 K
	Wet	40 K	40 K	34 K	25 K
	Slush/Standing Water	35 K	31 K	27 K	21 K
	Snow - No Melting **	35 K	29 K	24 K	18 K
	Ice - No Melting **	15 K	15 K	15 K	10 K
		30% MAC or less	35% MAC	39% MAC	TO Aft Limit
470 lbs / 215 kgs	Dry	40 K	40 K	33 K	24 K
	Wet	40 K	34 K	29 K	21 K
	Slush/Standing Water	31 K	27 K	23 K	18 K
	Snow - No Melting **	30 K	25 K	21 K	16 K
	Ice - No Melting **	15 K	15 K	15 K	10 K
		30% MAC or less	35% MAC	39% MAC	TO Aft Limit
390 lbs / 180 kgs and below	Dry	40 K	33 K	28 K	22 K
	Wet	35 K	29 K	24 K	20 K
	Slush/Standing Water	28 K	24 K	20 K	17 K
	Snow - No Melting **	27 K	22 K	19 K	16 K
	Ice - No Melting **	15 K	15 K	15 K	10 K

*Winds measured at 33 feet (10 m) tower height and apply for runways 148 feet (45m) or greater in width.

** Takeoff on untreated ice or snow should only be attempted when no melting is present.

777 Flight Crew Training Manual

Directional Control

Initial runway alignment and smooth symmetrical thrust application result in good crosswind control capability during takeoff. Light forward pressure on the control column during the initial phase of takeoff roll (below approximately 80 knots) increases nose wheel steering effectiveness. Any deviation from the centerline during thrust application should be countered with immediate smooth and positive control inputs. Smooth rudder control inputs combined with small control wheel inputs result in a normal takeoff with no overcontrolling. Large control wheel inputs can have an adverse effect on directional control near V_1 (MCG) due to the additional drag of the extended spoilers.

Note: With wet or slippery runway conditions, the PM should give special attention to ensuring the engines have symmetrically balanced thrust indications.

Rotation and Takeoff

Begin the takeoff roll with the control wheel approximately centered. Throughout the takeoff roll, gradually increase control wheel displacement into the wind only enough to maintain approximately wings level.

Note: Excessive control wheel displacement during rotation and liftoff increases spoiler deployment. As spoiler deployment increases, drag increases and lift is reduced which results in reduced tail clearance, a longer takeoff roll, and slower airplane acceleration.

At liftoff, the airplane is in a sideslip with crossed controls. A slow, smooth recovery from this sideslip is accomplished by slowly neutralizing the control wheel and rudder pedals after liftoff.

Gusty Wind and Strong Crosswind Conditions

For takeoff in gusty or strong crosswind conditions, use of a higher thrust setting than the minimum required is recommended. When the prevailing wind is at or near 90° to the runway, the possibility of wind shifts resulting in gusty tailwind components during rotation or liftoff increases. During this condition, consider the use of thrust settings close to or at maximum takeoff thrust. The use of a higher takeoff thrust setting reduces the required runway length and minimizes the airplane exposure to gusty conditions during rotation, liftoff, and initial climb.



To increase tail clearance during strong crosswind conditions, consider using a higher VR if takeoff performance permits. This can be done by:

- using improved climb takeoff performance
- increasing VR speed to the performance limited gross weight rotation speed, not to exceed actual gross weight VR + 20 knots. Set V speeds for the actual gross weight. Rotate at the adjusted (higher) rotation speed. This increased rotation speed results in an increased stall margin, and meets takeoff performance requirements.

Avoid rotation during a gust. If a gust is experienced near VR, as indicated by stagnant airspeed or rapid airspeed acceleration, momentarily delay rotation. This slight delay allows the airplane additional time to accelerate through the gust and the resulting additional airspeed improves the tail clearance margin. Do not rotate early or use a higher than normal rotation rate in an attempt to clear the ground and reduce the gust effect because this reduces tail clearance margins. Limit control wheel input to that required to keep the wings level. Use of excessive control wheel increases spoiler deployment which has the effect of reducing tail clearance. All of these factors provide maximum energy to accelerate through gusts while maintaining tail clearance margins at liftoff. The airplane is in a sideslip with crossed controls at this point. A slow, smooth recovery from this sideslip is accomplished after liftoff by slowly neutralizing the control wheel and rudder pedals.

Reduced and Derated Takeoff Thrust

Normally, takeoffs are conducted with less than full rated takeoff thrust whenever performance capabilities permit. Lower takeoff thrust reduces EGT, improves engine reliability, and extends engine life.

Takeoff thrust reduction can be achieved using reduced takeoff thrust (Assumed Temperature Method or ATM), derated takeoff thrust (fixed derate), or a combination of these two methods. Regardless of the method, takeoff speeds based on the selected rating (full rated or fixed derate) and the selected assumed temperature should be used. These takeoff speeds may be obtained from the takeoff analysis (runway/airport analysis) or another approved source. Takeoff with less than full rated takeoff thrust using any of these methods complies with all regulatory takeoff performance requirements.

Note: Takeoff with less than full rated takeoff thrust is not recommended if windshear conditions exist or are suspected, unless the use of a fixed derate or ATM is required to meet a dispatch performance requirement.

777 Flight Crew Training Manual**Reduced Takeoff Thrust (ATM)**

Reduced takeoff thrust (ATM) is a takeoff thrust level less than the full rated takeoff thrust. Reduced takeoff thrust is achieved by selecting an assumed temperature higher than the actual ambient temperature.

When using ATM, the takeoff thrust setting is not considered a takeoff operating limit since minimum control speeds (VMCG and VMCA) are based on the full rated takeoff thrust. At any time during takeoff, thrust levers may be advanced to the full rated takeoff thrust.

Note: Reduced takeoff thrust (ATM) may be used for takeoff on a wet runway if approved takeoff performance data for a wet runway is used. However, reduced takeoff thrust (ATM) is not permitted for takeoff on a runway contaminated with standing water, slush, snow, or ice.

Note: Reduced takeoff thrust (ATM) may permit a lower takeoff weight when airplane controllability is limited by the Minimum Takeoff Weight requirement.

Derated Takeoff Thrust (Fixed Derate)

Derated takeoff thrust (fixed derate) is a certified takeoff thrust rating lower than full rated takeoff thrust. In order to use derated takeoff thrust, takeoff performance data for the specific fixed derate level is required. Derated takeoff thrust is obtained by selection of TO 1 or TO 2 in the FMC.

When using derated takeoff thrust, the takeoff thrust setting is considered a takeoff operating limit since minimum control speeds (VMCG and VMCA), stabilizer trim setting, and Minimum Takeoff Weight are based on the derated takeoff thrust.

Thrust levers should not be advanced beyond the fixed derate limit unless conditions are encountered during the takeoff where additional thrust is needed on both engines, such as a windshear condition. If an engine failure occurs during takeoff, any thrust increase beyond the fixed derate limit could result in loss of directional control.

Note: Derated takeoff thrust (fixed derate) may be used for takeoff on a wet runway and on a runway contaminated with standing water, slush, snow, or ice.

Derated takeoff thrust (fixed derate) may permit a higher takeoff weight when performance is limited by VMCG, such as on a runway contaminated with standing water, slush, snow, or ice. This is because derated takeoff thrust allows a lower VMCG.

Derated takeoff thrust (fixed derate) may permit a lower takeoff weight when takeoff weight is limited by the Minimum Takeoff Weight requirement.

Combination ATM and Fixed Derate

Note: All limitations and restrictions for reduced takeoff thrust (ATM) and derated takeoff thrust (fixed derate) must be observed.

Reduced takeoff thrust (ATM) and derated takeoff thrust (fixed derate) may be combined by first selecting a fixed derate and then an assumed temperature higher than the actual ambient temperature. Although the takeoff thrust setting is not considered a takeoff operating limit for the ATM thrust reduction, the selected fixed derate is still considered a takeoff operating limit since takeoff speeds consider VMCG and VMCA only at the fixed derate level of thrust. Since the crew has no indication of the fixed derate limit, thrust levers should not be advanced unless conditions are encountered during the takeoff where additional thrust is needed on both engines, such as a windshear condition. If an engine failure occurs during takeoff, any thrust increase beyond the fixed derate limit could result in loss of directional control.

Thrust Control

When conducting a reduced thrust (ATM) takeoff, if more thrust is needed (up to maximum thrust) when thrust is in HOLD mode, thrust levers must be advanced manually. If conditions are encountered during the takeoff where additional thrust is needed, such as a windshear condition, the crew should not hesitate to manually advance thrust levers to maximum thrust.

When conducting a derated thrust (fixed derate) takeoff or a takeoff with a combination ATM and fixed derate, takeoff speeds consider VMCG and VMCA only at the fixed derate level of thrust. Thrust levers should not be advanced beyond the fixed derate limit unless conditions are encountered during the takeoff where additional thrust is needed on both engines, such as a windshear condition. If an engine failure occurs during takeoff, any thrust increase beyond the fixed derate limit could result in loss of directional control.

When combining a high level of derate with a high assumed temperature, or if a climb thrust rating higher than the automatically selected climb thrust rating is selected, it is possible that the climb thrust may be higher than the takeoff thrust. In such case, thrust levers will advance forward upon reaching thrust reduction altitude.

If more thrust is needed (up to maximum thrust) when the airplane is on the ground and HOLD mode is displayed, the thrust levers must be manually advanced.

After the airplane is in the air, pushing a TO/GA switch advances the thrust levers to maximum available thrust and THR REF is annunciated.

Improved Climb Performance Takeoff

When not field length limited, an increased climb limit weight is achieved by using the excess field length to accelerate to higher takeoff and climb speeds. This improves the climb gradient, thereby raising the climb and obstacle limited weights. V1, VR and V2 are increased and must be obtained from dispatch or by airport analysis.

Low Visibility Takeoff

[Appendix A.2.3](#)

Low visibility takeoff operations, below landing minima, may require a takeoff alternate. When selecting a takeoff alternate, consideration should be given to unexpected events such as an engine failure or other non-normal situation that could affect landing minima at the takeoff alternate. Operators, who have authorization for engine inoperative Category II/III operations, may be authorized lower alternate minima.

With proper crew training and appropriate runway lighting, takeoffs with visibility as low as 500ft/150m RVR may be authorized (FAA). With takeoff guidance systems and centerline lighting that meets FAA or ICAO criteria for Category III operations, takeoffs with visibility as low as 300ft/75m RVR may be authorized. Regulatory agencies may apply takeoff crosswind limits specifically for low visibility takeoffs.

All RVR readings must be equal to or greater than required takeoff minima. If the touchdown or rollout RVR system is inoperative, the mid RVR may be substituted for the inoperative system. When the touchdown zone RVR is inoperative, pilot estimation of RVR may be authorized by regulatory agencies.

Adverse Runway Conditions

[Appendix A.2.4](#)

Slush, standing water, or deep snow reduces the airplane takeoff performance because of increased rolling resistance and the reduction in tire-to-ground friction.

Most operators specify weight reductions to the AFM field length and/or obstacle limited takeoff weight based upon the depth of powdery snow, slush, wet snow or standing water and a maximum depth where the takeoff should not be attempted.

Slush or standing water may cause damage to the airplane. The recommended maximum depth for slush, standing water, or wet snow is 0.5 inch (13 mm) on the runway. For dry snow the maximum depth is 4 inches (102 mm).

A slippery runway (wet, compact snow, ice) also increases stopping distance during a rejected takeoff. Takeoff performance and critical takeoff data are adjusted to fit the existing conditions. Check the airport analysis or the PI chapter of the FCOM for takeoff performance changes with adverse runway conditions.

Note: If there is an element of uncertainty concerning the safety of an operation with adverse runway conditions, do not takeoff until the element of uncertainty is removed.

During wet runway or slippery conditions, the PM must give special attention to ensuring that the thrust on the engines advances symmetrically. Any tendency to deviate from the runway centerline must immediately be countered with steering action and, if required, slight differential thrust.

Forward pressure on the control column during the initial portion of the takeoff roll (below approximately 80 knots) increases nose wheel steering effectiveness.

During takeoffs on icy runways, lag in rudder pedal steering and possible nose wheel skidding must be anticipated. Keep the airplane on the centerline with rudder pedal steering and rudder. The rudder becomes effective between 40 - 60 knots. If deviations from the centerline cannot be controlled either during the start of the takeoff roll or until the rudder becomes effective, immediately reject the takeoff.

Federal Aviation Regulation (FAR) Takeoff Field Length

The FAR takeoff field length is the longest of the following:

- the distance required to accelerate with all engines, experience an engine failure 1 second prior to V1, continue the takeoff and reach a point 35 feet above the runway at V2 speed. (Accelerate-Go Distance).
- the distance required to accelerate with all engines, experience an event 1 second prior to V1, recognize the event, initiate the stopping maneuver and stop within the confines of the runway (Accelerate-Stop Distance).
- 1.15 times the all engine takeoff distance required to reach a point 35 feet above the runway.

Stopping distance includes the distance traveled while initiating the stop and is based on the measured stopping capability as demonstrated during certification flight test.

During certification, maximum manual braking and speedbrakes are used. Thrust reversers are not used. Although reverse thrust and autobrakes are not used in determining the FAR accelerate-stop distance, thrust reversers and RTO autobrakes should be used during any operational rejected takeoff.

777 Flight Crew Training Manual

Calculating a V_1 speed that equates accelerate-go and accelerate-stop distances defines the minimum field length required for a given weight. This is known as a “balanced field length” and the associated V_1 speed is called the “balanced V_1 ”. The FMC provides takeoff speeds based on a balanced V_1 . If either an ATM or fixed derate reduced thrust takeoff is used, the FMC, if FMC takeoff speeds are available, will provide a balanced V_1 applicable to the lower thrust setting.

Takeoff gross weight must not exceed the climb limit weight, field length limit weight, obstacle limit weight, tire speed limit weight, or brake energy limit. If the weight is limited by climb, obstacle, or brake considerations, the limit weight may be increased by using takeoff speeds that are different from the normal balanced takeoff speeds provided by the FMC.

Different (unbalanced) takeoff speeds can be determined by using:

- improved climb to increase climb or obstacle limited weights
- maximum V_1 policy to increase obstacle limited weights
- minimum V_1 policy to increase brake energy limited weights
- clearway or stopway to increase field or obstacle limited weights.

If the takeoff weight is not based on normal balanced V_1 , the FMC takeoff speeds are not applicable and the operator should provide the pilot with a method to obtain the appropriate takeoff speeds.

FAR Takeoff

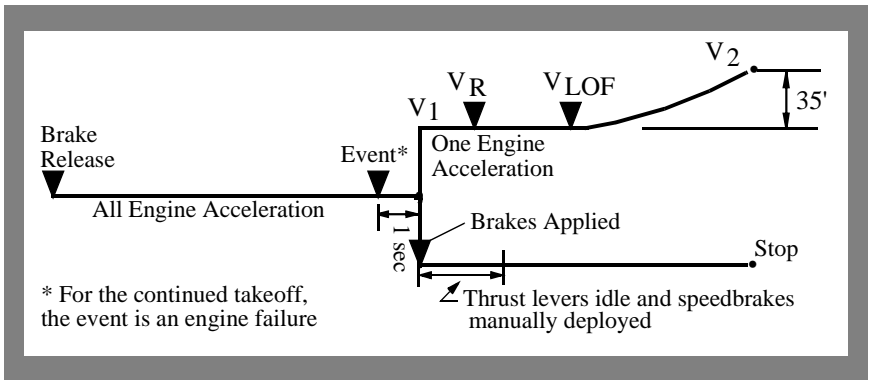

Rejected Takeoff Decision

The total energy that must be dissipated during an RTO is proportional to the square of the airplane velocity. At low speeds (up to approximately 80 knots), the energy level is low. Therefore, the airplane should be stopped if an event occurs that would be considered undesirable for continued takeoff roll or flight.

Examples include Master Caution, unusual vibrations or tire failure.

Note: Refer to the Rejected Takeoff NNM in the QRH for guidance concerning the decision to reject a takeoff below and above 80 knots.

As the airspeed approaches V1 during a balanced field length takeoff, the effort required to stop can approach the airplane maximum stopping capability. Therefore, the decision to stop must be made before V1.

Historically, rejecting a takeoff near V1 has often resulted in the airplane stopping beyond the end of the runway. Common causes include initiating the RTO after V1 and failure to use maximum stopping capability (improper procedures/techniques). Effects of improper RTO execution are shown in the diagrams located in the RTO Execution Operational Margins section, this chapter. The maximum braking effort associated with an RTO is a more severe level of braking than most pilots experience in normal service.

Rejecting the takeoff after V1 is not recommended unless the captain judges the airplane incapable of flight. Even if excess runway remains after V1, there is no assurance that the brakes have the capacity to stop the airplane before the end of the runway.

There have been incidents where pilots have missed FMC alerting messages informing them that the takeoff speeds have been deleted or they have forgotten to set the airspeed bugs. If, during a takeoff, the crew discovers that the V speeds are not displayed and there are no other fault indications, the takeoff may be continued. The lack of displayed V speeds with no other fault indications does not fit any of the published criteria for rejecting a takeoff (refer to the Rejected Takeoff NNM in the QRH). In the absence of displayed V speeds, the PM should announce V1 and VR speeds to the PF at the appropriate times during the takeoff roll. The V2 speed should be displayed on the MCP and primary airspeed indicators. If neither pilot recalls the correct rotation speed, rotate the airplane 5 to 10 knots before the displayed V2 speed.

777 Flight Crew Training Manual

Rejected Takeoff Maneuver

The RTO maneuver is initiated during the takeoff roll to expeditiously stop the airplane on the runway. The PM should closely monitor essential instruments during the takeoff roll and immediately announce abnormalities, such as “ENGINE FIRE”, “ENGINE FAILURE”, or any adverse condition significantly affecting safety of flight. The decision to reject the takeoff is the responsibility of the captain, and must be made before V1 speed. If the captain is the PM, he should initiate the RTO and announce the abnormality simultaneously.

Note: If the decision is made to reject the takeoff, the flight crew should accomplish the rejected takeoff non-normal maneuver as described in the Maneuvers chapter of the QRH.

If the takeoff is rejected before the HOLD annunciation, the autothrottle should be disengaged as the thrust levers are moved to idle. If the autothrottle is not disengaged, the thrust levers advance to the selected takeoff thrust position when released. After HOLD is annunciated, the thrust levers, when retarded, remain in idle. For procedural consistency, disengage the autothrottles for all rejected takeoffs.

If an engine failure occurs above TAC activation speed, TAC provides rudder input, as needed, to help maintain directional control. TAC rudder input is available during forward thrust operations only, until speed is reduced below TAC activation speed. With TAC inoperative, the PF must make rudder inputs.

If rejecting due to fire, in windy conditions, consider positioning the airplane so the fire is on the downwind side. After an RTO, comply with brake cooling requirements before attempting a subsequent takeoff.

Go/Stop Decision Near V1

It was determined when the aviation industry produced the Takeoff Safety Training Aid in 1992 that the existing definition of V1 might have caused confusion because they did not make it clear that V1 is the maximum speed at which the flight crew must take the first action to reject a takeoff. The U.S. National Transportation Safety Board (NTSB) also noted in their 1990 study of rejected takeoff accidents, that the late initiation of rejected takeoffs was the leading cause of runway overrun accidents. As a result, the FAA has changed the definition of V1 in FAR Part 1 to read as follows:

- V1 means the maximum speed in the takeoff at which the pilot must take the first action (e.g., apply brakes, reduce thrust, deploy speedbrakes) to stop the airplane within the accelerate-stop distance and
- V1 also means the minimum speed in the takeoff, following a failure of an engine at which the pilot can continue the takeoff and achieve the required height above the takeoff surface within the takeoff distance.



Pilots know that V1 is fundamental to making the Go/Stop decision. Under runway limited conditions, if the reject procedure is initiated at V1, the airplane can be stopped before reaching the end of the runway. See RTO Execution Operational Margins diagrams for the consequences of initiating a reject after V1 and/or using improper procedures.

When the takeoff performance in the AFM is produced, it assumes an engine failure or event one-second before V1. In a runway limited situation, this means the airplane reaches a height of 35 feet over the end of the runway if the decision is to continue the takeoff.

Within reasonable limits, even if the engine failure occurs earlier than the assumed one second before V1, a decision to continue the takeoff will mean that the airplane is lower than 35 feet at the end of the runway, but it is still flying. For example, if the engine fails 2 seconds before V1 and the decision is made to go, the airplane will reach a height of 15 to 20 feet at the end of the runway.

Although training has historically centered on engine failures as the primary reason to reject, statistics show engine thrust loss was involved in approximately one quarter of the accidents, and wheel or tire problems have caused almost as many accidents and incidents as have engine events. Other reasons that rejects occurred were for configuration, indication or light, crew coordination problems, bird strikes or ATC problems.

It is important to note here is that the majority of past RTO accidents were not engine failure events. Full takeoff thrust from all engines was available. With normal takeoff thrust, the airplane should easily reach a height of 150 feet over the end of the runway, and the pilot has the full length of the runway to stop the airplane if an air turnback is required.

Making the Go/Stop decision starts long before V1. Early detection, good crew coordination and quick reaction are the keys to a successful takeoff or stop.

RTO Execution Operational Margins

A successful rejected takeoff at or near V1 is dependent upon the captain making timely decisions and using the proper procedures.

The data in the following diagrams, extracted from the Takeoff Safety Training Aid, are provided as a reference. The individual diagrams show the approximate effects of various configuration items and procedural variations on the stopping performance of the airplane. These calculations are frequently based on estimated data and are intended for training discussion purposes only. The data are generally typical of the airplane at heavy weights, and except as noted otherwise, are based on the certified transition time.

777 Flight Crew Training Manual

Each condition is compared to the baseline condition. The estimated speed at the end of the runway and the estimated overrun distance are indicated at the right edge of each figure. The distance estimates assume an overrun area that can produce the same braking forces as the respective runway surface. If less than the baseline FAA accelerate-stop distance is required, the distance is denoted as a negative number.

777

Available Runway (DRY)

Baseline

AFM balanced field length
All-engine RTO, brakes and
speedbrakes only, no thrust reverse

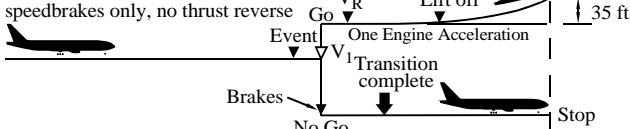

Effect of reverse thrust
Engine-out RTO, brakes, speedbrakes,
and 1 thrust reverser

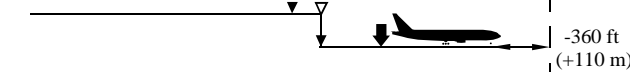

Effect of reverse thrust
All-engine RTO, brakes, speedbrakes,
and 2 thrust reversers

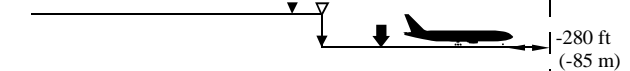

Effect of no speedbrakes
All-engine RTO, brakes only,
no thrust reverse

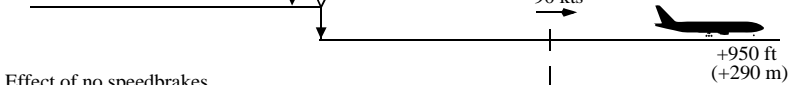

Effect of no speedbrakes
All-engine RTO, brakes and
2 thrust reversers

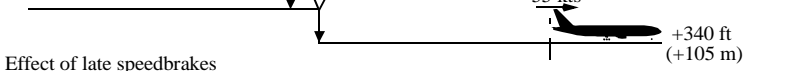

Effect of late speedbrakes
All-engine RTO, brakes, speedbrake
deployment 5 seconds after V₁,
no thrust reverse

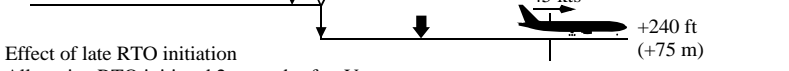

Effect of late RTO initiation
All-engine RTO initiated 2 seconds after V₁,
AFM transition, brakes and speedbrakes only,
no thrust reverse

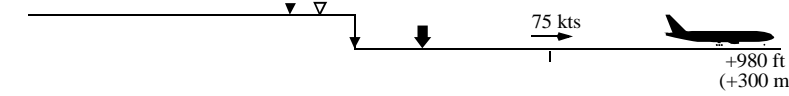

777 Flight Crew Training Manual

777

Available Runway (DRY)

Effect of less than maximum braking effort
 All-engine RTO, 3/4 brake pressure,
 speedbrakes, and 2 thrust reversers

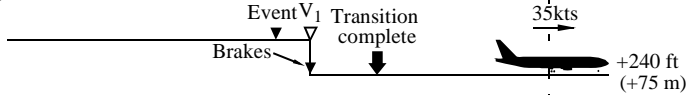

Effect of 2 blown tires
 All-engine RTO, brakes, speedbrakes,
 and 2 thrust reversers

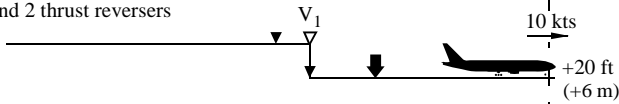
Available Runway (WET)

Effect of using dry runway performance
 (limit weight and V_1) on wet runway
 All-engine RTO, brakes, speedbrakes,
 and 2 thrust reversers

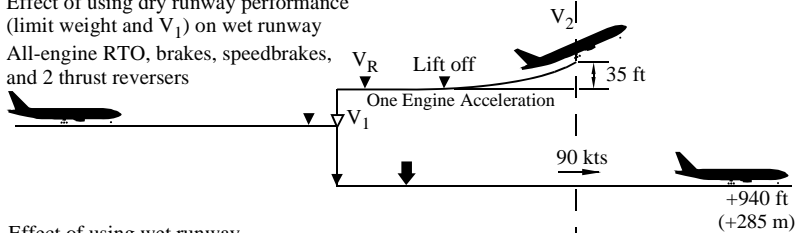

Effect of using wet runway
 performance (reduced V_1 and GW)
 All-engine RTO, brakes, speedbrakes,
 and 2 thrust reversers

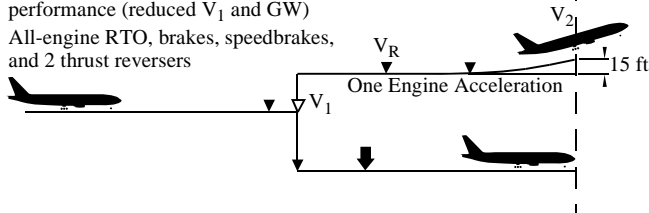

Initial Climb - All Engines

After liftoff, use the attitude indicator as the primary pitch reference. The flight director, in conjunction with indicated airspeed and other flight instruments is used to maintain the proper vertical flight path. Pitch, airspeed, and airspeed trends must be crosschecked whether the flight director is used or not.

After liftoff, the flight director commands pitch to maintain an airspeed of $V_2 + 15$ to 25 knots until another pitch mode is engaged.

$V_2 + 15$ is the optimum climb speed with takeoff flaps. It results in the maximum altitude gain in the shortest distance from takeoff. Acceleration to higher speeds reduces the altitude gain. If airspeed exceeds $V_2 + 15$ during the initial climb, stop the acceleration but do not attempt to reduce airspeed to $V_2 + 15$. Any speed between $V_2 + 15$ and $V_2 + 25$ knots results in approximately the same takeoff profile. Crosscheck indicated airspeed for proper initial climb speed.

Retract the landing gear after a positive rate of climb is indicated on the altimeter. Do not apply brakes after becoming airborne. Automatic wheel braking occurs during gear retraction. After gear and flaps are retracted, the PM should verify that the gear and flap indications are normal.

Minimum Fuel Operation - Takeoff

The minimum fuel recommended for takeoff is trip fuel plus reserves. On very short flights this fuel quantity may not be enough to prevent forward fuel pump low pressure lights from illuminating after takeoff.

If any main tank fuel pump indicates low pressure do not turn off fuel pump switches. Avoid rapid acceleration of the airplane, reduce nose-up body attitude and maintain minimum nose-up body angle required for a safe climb gradient.

Immediate Turn after Takeoff - All Engines

Obstacle clearance, noise abatement, or departure procedures may require an immediate turn after takeoff. Initiate the turn at the appropriate altitude (normally at least 400 feet AGL) and maintain $V_2 + 15$ to $V_2 + 25$ with takeoff flaps.

Note: A maximum bank angle of 30° is permitted at $V_2 + 15$ knots with takeoff flaps.

After completing the turn, and at or above acceleration height, accelerate and retract flaps while climbing.

Note: The possibility of an engine failure along the departure track must be considered. Special engine out procedures, if available, are preferable to a takeoff weight reduction to ensure all obstacles are cleared.

Roll Modes

After takeoff and climb is stabilized, select LNAV (if not armed before takeoff) after passing 400 feet AGL. If LNAV is armed for takeoff, it engages above 50 feet AGL and within 2.5 NM of the active leg. If the departure procedure or route does not begin at the end of the runway, it may be necessary to use the HDG SEL mode at 400 feet AGL to intercept the desired track for LNAV capture. When the departure procedure is not a part of the active flight plan, use HDG SEL, TRK SEL or HDG HOLD mode. When an immediate turn after takeoff is necessary, the desired heading may be preset before takeoff.

Nav aids and appropriate radials or tracks required for use during the departure may be displayed on the navigation display using the FIX page feature and/or VOR/ADF switches on the EFIS control panel. Use of the STA and WPT switches on the EFIS control panel provides additional information on the navigation display.

Pitch Modes

VNAV is normally armed for takeoff and engages at 400 feet AGL. The use of VNAV for takeoff, flap retraction and climb out is the preferred method of managing the AFDS for takeoff. This provides the VNAV profile and acceleration schedule compatible with the planned departure.

VNAV, armed on the ground with the appropriate acceleration altitude entered, is the recommended pitch mode for takeoff. When armed for takeoff, VNAV engages at 400 feet AGL and provides AFDS management for acceleration, flap retraction and climb out. The VNAV profile and acceleration schedule is compatible with most planned departures.

With VNAV engaged, acceleration is automatically commanded. Retract flaps on schedule. Check that the thrust reference changes from TO to CLB on the EICAS at the point selected on the takeoff reference page. If the thrust reference does not change automatically, manually select climb thrust.

If VNAV is not used, at acceleration height select FLCH and set the command speed to flaps up maneuver speed. Check that the thrust reference changes from TO to CLB on the EICAS. If the thrust reference does not change automatically, set climb thrust using the CLB/CON switch on the MCP.

Autopilot Engagement

The autopilot is FAA certified to allow engagement at or above 200 feet AGL after takeoff. Other regulations or airline operating directives may specify a higher minimum altitude. The airplane should be in trim, and the flight director commands should be satisfied before autopilot engagement. This prevents unwanted changes from the desired flight path during autopilot engagement.



Flap Retraction Schedule

The minimum altitude for flap retraction is 400 feet.

The altitude selected for acceleration and flap retraction may be specified for each airport. Safety, obstruction clearance, airplane performance or noise abatement requirements are usually the determining factors. Some operators have adopted a standard climb profile for all of their operations based on the airport which requires the greatest height for level off to clear a close-in obstacle with an engine failure.

During training flights, 1,000 feet AFE is normally used as the acceleration height to initiate thrust reduction and flap retraction. For noise abatement considerations during line operations, thrust reduction typically occurs at approximately 1,500 feet AFE and acceleration typically occurs between 1,500 and 3,000 feet AFE, or as specified by individual airport noise abatement procedures.

During flap retraction, selection of the next flap position is initiated when reaching the maneuver speed for the existing flap position. Therefore, when the new flap position is selected, the airspeed is below the maneuver speed for that flap position. For this reason, the airspeed should be increasing when selecting the next flap position. During flap retraction, at least adequate maneuver capability or 30° of bank (15° angle of bank and 15° overshoot) to stick shaker is provided at the flap retraction speed. Full maneuvering capability or at least 40° of bank (25° of bank and 15° overshoot) is provided when the airplane has accelerated to the recommended maneuver speed for the selected flap position.

With airspeed increasing, flap retractions should be initiated when airspeed reaches the maneuver speed for the existing flap position. The maneuver speed for the existing flap position is indicated by the numbered flap maneuver speed bugs on the airspeed display.

Takeoff Flap Retraction Speed Schedule

T/O Flaps	At "Display"	Select Flaps
20 or 15	"20" or "15"	5
	"5"	1
	"1"	UP
5	"5"	1
	"1"	UP

For flaps up maneuvering, maintain at least:

- "UP"

Noise Abatement Takeoff

Normal takeoff procedures satisfy typical noise abatement requirements. Thrust reduction and acceleration heights should be entered on the takeoff reference page of the FMC. Maintain flaps up maneuver speed until the noise abatement profile is satisfied, until clear of obstacles or above any minimum crossing altitude. This is normally achieved through the FMC speed restriction entered on the climb page. It may also be accomplished using speed intervention or FLCH.

Note: Specific local airport procedures should be followed.

Takeoff - Engine Failure

General

Differences between normal and engine out profiles are few. One engine out controllability is excellent during takeoff roll and after liftoff. Minimum control speed in the air is below VR and VREF.

Engine Failure Recognition

During an engine failure at or after V1, the TAC automatically inputs rudder to compensate for most of the yaw resulting from asymmetrical thrust. The PF is still required to add a small amount of rudder which aids in engine failure recognition. If the TAC is inoperative, the onset of the yaw may be rapid.

The airplane heading is the best indicator of the correct rudder pedal input. To counter the thrust asymmetry due to an engine failure, stop the yaw with rudder. Flying with lateral control wheel displacement or with excessive aileron trim causes spoilers to be raised.

Rotation and Liftoff - One Engine Inoperative

If an engine fails between V1 and liftoff, the TAC automatically inputs rudder to compensate for most of the yaw resulting from asymmetrical thrust. The PF is still required to add a small amount of rudder to maintain directional control. If the TAC is inoperative, maintain directional control by smoothly applying rudder proportionate with thrust decay.

During a normal all engine takeoff, a smooth continuous rotation toward 15° of pitch is initiated at VR. With an engine inoperative, a smooth continuous rotation is also initiated at VR; however, the target pitch attitude is approximately 2° to 3° below the normal all engine pitch attitude. The rate of rotation with an engine inoperative is also slightly slower (1/2° per second less) than that for a normal takeoff. After liftoff adjust pitch attitude to maintain the desired speed.

If an engine fails after liftoff, the TAC automatically inputs rudder to fully compensate for the yaw resulting from asymmetrical thrust. If the TAC is inoperative, apply rudder and aileron to control heading and keep the wings level. The correct rudder input approximately centers the control wheel.

Typical Rotation - One Engine Inoperative

Liftoff attitude depicted in the following tables should be achieved in approximately 5 seconds. Adjust pitch attitude, as needed, to maintain desired airspeed of V2 to V2 + 15 knots.

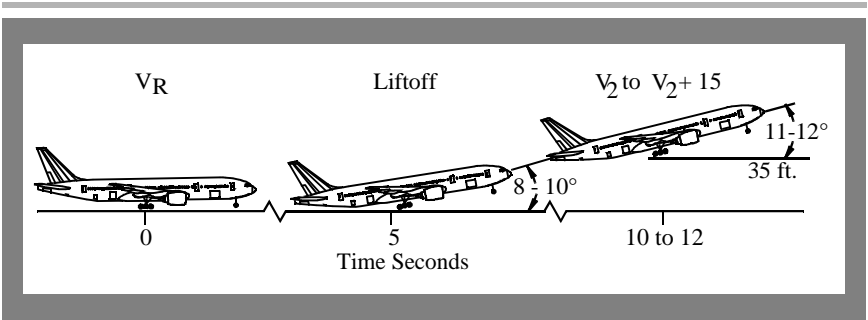
777 Flight Crew Training Manual

Retract the landing gear after a positive rate of climb is indicated on the altimeter.
Retract flaps in accordance with the technique described in this chapter.

Typical Takeoff Tail Clearance - One Engine Inoperative

The following diagram and table show the effect of flap position on liftoff pitch attitude and minimum tail clearance during takeoff with one engine inoperative. Additionally, the last column shows the pitch attitude for tail contact with wheels on the runway and landing gear struts extended. The tail strike pitch attitude remains the same as during takeoffs with all engines operating. For a discussion of tail strike procedures, see chapter 8 and the FCOM.

The minimum tail clearance remains constant for all takeoff flap settings. The rotation speed schedules were developed to maintain a constant tail clearance.

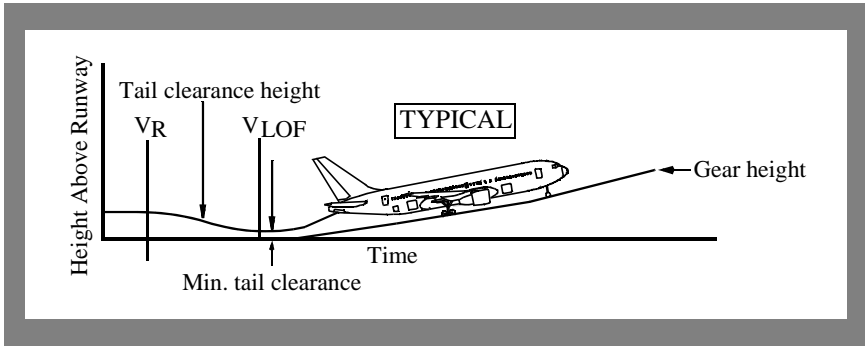

Model	Flaps	Liftoff Attitude (degrees)	Minimum Tail Clearance inches (cm)	Tail Strike Pitch Attitude (degrees)
777-200	5, 15, 20	9.5	26 (66)	12.1
777-200LR	5, 15, 20	9.5	35 (89)	12.1
777-300	5, 15, 20	8.0	24 (61)	8.9
777-300ER	5, 15, 20	9.0	16 (41)	10.0

Note: 777-300ER values valid when the Semi-Levered Gear (SLG) is operative. When the SLG is inoperative, use 777-300 values.

Initial Climb - One Engine Inoperative

The initial climb attitude should be adjusted to maintain a minimum of V_2 and a positive climb. After liftoff the flight director provides proper pitch guidance. Crosscheck indicated airspeed, vertical speed and other flight instruments. The flight director commands a minimum of V_2 , or the existing speed up to a maximum of $V_2 + 15$.

If the flight director is not used, attitude and indicated airspeed become the primary pitch references.

Retract the landing gear after a positive rate of climb is indicated on the altimeter. The initial climb attitude should be adjusted to maintain a minimum of V_2 . If an engine fails at an airspeed between V_2 and $V_2 + 15$, climb at the airspeed at which the failure occurred. If engine failure occurs above $V_2 + 15$, increase pitch to reduce airspeed to $V_2 + 15$ and maintain $V_2 + 15$ until reaching acceleration height.

The flight director roll mode commands ground track after liftoff until LNAV engagement or another roll mode is selected. If ground track is not consistent with desired flight path, use HDG SEL/TRK SEL/LNAV to achieve the desired track.

Indications of an engine fire, impending engine breakup or approaching or exceeding engine limits, should be dealt with as soon as possible. Accomplish the appropriate memory checklist items as soon as the airplane is under control, the gear has been retracted and a safe altitude (typically 400 feet AGL or above) has been attained. Accomplish the reference checklist items after the flaps have been retracted and conditions permit.

If an engine failure has occurred during initial climb, accomplish the appropriate checklist after the flaps have been retracted and conditions permit.

Immediate Turn after Takeoff - One Engine Inoperative

Obstacle clearance or departure procedures may require a special engine out departure procedure. If an immediate turn is required, initiate the turn at the appropriate altitude (normally at least 400 feet AGL). Maintain V_2 to $V_2 + 15$ knots with takeoff flaps while maneuvering.

Note: The AFDS limits the bank angle to 15° until $V_2 + 10$ knots to maintain at least adequate maneuver margin. The bank angle limit increases to 25° by $V_2 + 20$ knots if LNAV is engaged, or when HDG SEL or TRK SEL is engaged with the bank limit in AUTO.

After completing the turn, and at or above acceleration height, accelerate and retract flaps.

Autopilot Engagement - One Engine Inoperative

When at a safe altitude above 200 feet AGL with correct rudder pedal input as needed, the autopilot may be engaged. If the TAC is not operating, rudder trim must be manually applied.

Flap Retraction - One Engine Inoperative

The minimum altitude for flap retraction with an engine inoperative is 400 feet AGL. During training, Boeing uses 1,000 feet AFE as a standard altitude to initiate acceleration for flap retraction.

Acceleration height for a takeoff with an engine failure after V1 is based on accelerating to the recommended flaps up speed while retracting flaps and selecting maximum continuous thrust limits within 5 minutes (10 minutes optional) after initiating takeoff. Some combinations of high gross weight, takeoff flap selection and airport elevation may require initiating flap retraction as low as 400 feet after takeoff with an engine failure.

At typical training weights, adequate performance exists to climb to 1,000 feet before beginning flap retraction. Therefore, during training 1,000 feet is used as the acceleration height for engine failure after V1.

At engine out acceleration height, if VNAV is engaged, a near-level climb segment is commanded for acceleration. Retract flaps on the takeoff flap retraction speed schedule. With flaps up and airspeed at or above the flaps up maneuver speed, VNAV automatically sets the reference thrust limit to Max Continuous Thrust (CON).

At engine out acceleration height, if VNAV is not engaged, leave the pitch mode in TO/GA and select flaps up maneuver speed on the MCP. Engine-out acceleration and climb capability for flap retraction are functions of airplane thrust to weight ratio. The flight director commands a near level flap retraction segment.

Accelerate and retract flaps on the takeoff flap retraction speed schedule.

If the flight director is not being used at acceleration height, decrease pitch attitude to maintain approximately level flight while accelerating. Retract flaps on the takeoff flap retraction speed schedule.

As the airplane accelerates and flaps are retracted, the rudder is automatically adjusted by the TAC to maintain the control wheel centered. If the TAC is inoperative, manually adjust the rudder pedal position to maintain the control wheel centered and trim to relieve rudder pedal pressure.

Flaps Up - One Engine Inoperative

After flap retraction and at flaps up maneuver speed, if VNAV is not engaged, select FLCH, verify maximum continuous thrust (CON) is set and continue the climb to the obstacle clearance altitude.

777 Flight Crew Training Manual

Initiate the appropriate engine failure non-normal checklist followed by the After Takeoff checklist when the flaps are up and thrust is set. With flaps up, the FMC commands a climb at flaps up maneuver speed and the autothrottles transition automatically to maximum continuous thrust if VNAV is engaged. If this does not occur, select FLCH and flaps up maneuver speed until clear of obstacles. Maximum continuous thrust is automatically set when FLCH is selected.

Noise Abatement - One Engine Inoperative

When an engine failure occurs after takeoff, noise abatement is no longer a requirement.

Engine Failure During a Reduced Thrust (ATM) Takeoff

Since the reduced thrust (ATM) takeoff must still comply with all regulatory takeoff performance requirements, it is not necessary to increase thrust beyond the reduced level on the operating engine in the event of an engine failure. However, if more thrust is needed during an ATM takeoff, thrust on the operating engine may be increased to full rated takeoff thrust by manually advancing the thrust lever while still on the runway, or by pushing the TO/GA switch when airborne. This is because the takeoff speeds consider VMCG and VMCA at the full rated takeoff thrust.

Increasing thrust on the operating engine to full rated takeoff thrust provides additional performance margin. This additional performance margin is not a requirement for the reduced thrust takeoff and its use is at the discretion of the flight crew.

Engine Failure During a Derated Thrust (Fixed Derate) Takeoff

During a fixed derate takeoff, a thrust increase beyond the fixed derate limit following an engine failure could result in loss of directional control and should not be accomplished unless, in the opinion of the captain, terrain contact is imminent. This is because the takeoff speeds consider VMCG and VMCA only at the fixed derate level of thrust.

Engine Failure During a Combined ATM and Fixed Derate Takeoff

During a takeoff using both reduced thrust (ATM) and fixed derate, any thrust increase beyond the fixed derate limit following an engine failure could result in loss of directional control. This is because the takeoff speeds consider VMCG and VMCA only at the fixed derate level of thrust. Since the crew has no indication of the fixed derate limit, a thrust increase should not be accomplished unless in the opinion of the captain, terrain contact is imminent.



Intentionally
Blank



Climb, Cruise, Descent and Holding
Table of Contents

Chapter 4
Section TOC

Preface 4.1

Climb 4.1

 Reduced Thrust Climb. 4.1

 Climb Constraints 4.1

 Low Altitude Level Off. 4.2

 Transition to Climb 4.3

 Climb Speed Determination 4.3

 Engine Icing During Climb. 4.3

 Economy Climb. 4.4

 Economy Climb Schedule - FMC Data Unavailable 4.4

 Maximum Rate Climb. 4.4

 Maximum Angle Climb. 4.4

 Engine Inoperative Climb 4.4

Cruise 4.6

 Maximum Altitude 4.6

 Optimum Altitude 4.7

 Cruise Speed Determination 4.8

 Step Climb. 4.8

 Low Fuel Temperature 4.9

 Cruise Performance Economy. 4.11

 Engine Inoperative Cruise/Driftdown 4.12

 High Altitude High Speed Flight. 4.13

 ETOPS. 4.14

 Polar Operations 4.15

Descent 4.18

 Descent Speed Determination 4.18



Descent Path	4.18
Descent Constraints	4.18
Speed Intervention	4.19
Offpath Descent	4.19
Descent Planning	4.19
Descent Rates	4.20
Speedbrakes	4.21
Flaps and Landing Gear	4.21
Speed Restrictions	4.22
Engine Icing During Descent	4.22
Holding	4.22
Holding Airspeeds	4.23
Procedure Holding	4.23
Holding Airspeeds Not Available from the FMC	4.24



Preface

This chapter outlines recommended operating practices and techniques used during climb, cruise, descent and holding. Loss of an engine during climb or cruise and engine inoperative cruise/driftdown is also addressed. The recommended operating practices and techniques discussed in this chapter improve crew coordination, enhance safety, and provide a basis for standardization.

Climb

Reduced Thrust Climb

Engine service life may be extended by operating the engines at less than full climb rated thrust.

The FMC provides two reduced thrust climb selections on the THRUST LIMIT page:

- CLB 1 is a constant 10% derate of climb thrust
- CLB 2 is a constant 20% derate of climb thrust.

Reduced thrust climb may also be automatically selected by the FMC depending upon the amount of thrust reduction made for takeoff by either the fixed derate or assumed temperature method.

Climb thrust reductions are gradually removed as the airplane climbs until full climb thrust is restored. If rate of climb should drop below approximately 500 feet per minute, the next higher climb rating should be selected.

Prior to takeoff, the pilot may override the automatically selected climb thrust limit after the takeoff selection has been completed by selecting another climb thrust limit on the THRUST LIMIT page. When the automatically selected climb thrust limit is overridden, the previously selected takeoff derate is not affected.

Note: Use of reduced thrust for climb increases total trip fuel and should be evaluated by each operator.

Climb Constraints

Climb constraints may be automatically entered in the route when selecting a procedure, or manually entered through CDU entry. When the airplane levels off at an MCP altitude, that altitude is treated as a climb constraint by the FMC.

Normally, set all maximum or hard altitude constraints in the MCP altitude window. The next altitude may be set when the restriction has been assured or further clearance has been received. This procedure provides altitude alerting and ensures compliance with altitude clearance limits.

When using VNAV, if altitude constraints are closely spaced to the extent that crew workload is adversely affected and unwanted level-offs are a concern, the alternate MCP altitude setting technique can be used with operator approval. Refer to Chapter 1, MCP Altitude Setting Techniques Using VNAV for more information on this subject.

Note: When the alternate MCP altitude setting technique using VNAV is used, the selection of a pitch mode other than VNAV SPD for climbs will result in a risk of violating altitude constraints.

For climbs in pitch modes other than VNAV SPD, the MCP altitude must be set at the next altitude constraint, or as published for the departure.

When relieved of constraints by ATC, use of FLCH or VNAV with MCP altitude intervention is recommended in congested areas, or during times of high workload. Altitude intervention is accomplished by selecting the next desired altitude in the MCP altitude window, pushing the MCP altitude selector which deletes the altitude constraint and allows the airplane to climb to the MCP altitude.

Low Altitude Level Off

Occasionally a low altitude climb restriction is required after takeoff. This altitude restriction should be set in the MCP altitude window. When the airplane approaches this altitude, the mode annunciation changes to ALT or VNAV ALT and the airplane levels off. The autothrottle SPD mode engages and controls to the target speed. If altitude capture occurs while still in the TO/GA pitch mode, confirm the SPD autothrottle mode engages and set the desired command speed at level off.

High Takeoff Thrust - Low Gross Weight

When accomplishing a low altitude level off following a takeoff using high takeoff thrust and at a low gross weight, the crew should consider the following factors:

- altitude capture can occur just after liftoff due to the proximity of the level off altitude and the high climb rate of the airplane
- the AFDS control laws limit F/D and autopilot pitch commands for passenger comfort
- there may not be enough altitude below the intended level off altitude to complete the normal capture profile and an overshoot may occur unless crew action is taken.

To prevent an altitude and/or airspeed overshoot, the crew should consider doing one or more of the following:

- use reduced thrust for takeoff at low weights whenever possible
- reduce from takeoff to climb thrust earlier than normal

- disengage the AFDS and complete the level off manually if there is a possibility of an overshoot
- use manual thrust control as needed to manage speed and prevent flap overspeeds.

Transition to Climb

Maintain flaps up maneuvering speed until clear of obstacles or above minimum crossing altitudes. If there are no altitude or airspeed restrictions, accelerate to the desired climb speed schedule. The sooner the airplane can be accelerated to the climb speed schedule, the more time and fuel efficient the flight.

Climb Speed Determination

Enroute climb speed is automatically computed by the FMC and displayed on the climb and progress pages. It is also displayed as command speed when VNAV is engaged. Below the speed transition altitude the FMC targets the transition speed limit stored in the navigation database for the departure airport (250 knots below 10,000 feet MSL in FAA airspace), or flaps up maneuvering speed, whichever is higher. The FMC applies waypoint-related speed restrictions displayed on the LEGS pages, and altitude-related speed restrictions displayed on the climb page.

The FMC provides optimum climb speed modes for economy (ECON) operation and engine out (ENG OUT) operation. These optimum speeds can be changed before or during the climb. Reference speeds are also provided for maximum angle climb (MAX ANGLE) operation.

The ECON climb speed is a constant speed/constant Mach schedule optimized to obtain the minimum airplane operating cost. The constant Mach value is set equal to the economy cruise Mach calculated for the cruise altitude entered in the FMC.

For very low cruise altitudes the economy climb speed is increased above normal values to match the economy cruise speed at the entered cruise altitude. For ECON climb, the speed is a function of gross weight (predicted weight at top of climb), predicted top of climb wind, predicted top of climb temperature deviation from ISA, and cost index.

Engine Icing During Climb

Engine icing may form when not expected and may occur when there is no evidence of icing on the windshield or other parts of the airplane. Once ice starts to form, accumulation can build very rapidly. Although one bank of clouds may not cause icing, another bank, which is similar, may cause icing.

Note: The engine anti-icing system should be AUTO or ON whenever icing conditions exist or are anticipated. Failure to follow the recommended anti-ice procedures can result in engine stall, overtemperature or engine damage.

Economy Climb

The normal economy climb speed schedule of the FMC minimizes trip cost. It varies with gross weight and is influenced by cost index. The FMC generates a fixed speed schedule as a function of cost index and weight.

Economy climb speed normally exceeds 250 knots for all gross weights. FMC climb speed is limited to 250 knots below 10,000 feet (FAA Airspace), or a lower waypoint speed restriction, if entered. If the use of a higher speed below 10,000 feet is allowed, ECON speed provides additional cost savings.

Economy Climb Schedule - FMC Data Unavailable

- 250 knots/VREF 30 + 80, whichever is higher- Below 10,000 feet
- 310 knots/0.84M - Above 10,000 feet

Maximum Rate Climb

A maximum rate climb provides both high climb rates and minimum time to cruise altitude. Maximum rate climb can be approximated by using the following:

- flaps up Maneuver Speed + 60 knots until intercepting 0.82M

Note: The FMC does not provide maximum rate climb speeds.

Maximum Angle Climb

The FMC provides maximum angle climb speeds. Maximum angle climb speed is normally used for obstacle clearance, minimum crossing altitude or to reach a specified altitude in a minimum distance. It varies with gross weight and provides approximately the same climb gradient as flaps up maneuvering speed.

Engine Inoperative Climb

The recommended engine inoperative climb speed approximates the speed for maximum climb gradient and varies with gross weight and altitude. At high altitudes and weights, a fixed Mach is used as an upper limit on the engine out climb speed. Engine out climb speed is the FMC default used during climb when ENG OUT CLIMB is selected. Select ENG OUT CLIMB after flap retraction and all obstructions are cleared.

If a thrust loss occurs at other than takeoff thrust, set maximum continuous thrust on the operative engine and adjust the pitch to maintain airspeed.

777 Flight Crew Training Manual

In the clean configuration, select the engine out prompt on the CDU climb page. The engine out mode provides VNAV commands to climb at engine out climb speed to cruise altitude, or maximum engine out altitude, whichever is lower. If the airplane is currently above maximum engine out altitude, driftdown information is available. Upon reaching level off altitude, the command speed changes to EO SPD. Engine Out LRC or Company Speed (CO SPD) may be selected. Leave thrust set at maximum continuous thrust until airspeed increases to the commanded value.

Note: If computed climb speeds are not available, use flaps up maneuvering speed and maximum continuous thrust.

Cruise

This section provides general guidance for the cruise portion of the flight for maximum passenger comfort and economy.

Maximum Altitude

Appendix A.2.4

Maximum altitude is the highest altitude at which the airplane can be operated. It is determined by three basic characteristics, which are unique to each airplane model. The FMC predicted maximum altitude is the lowest of:

- maximum certified altitude (structural) - determined during certification and is usually set by the pressurization load limits on the fuselage
- thrust limited altitude - the altitude at which sufficient thrust is available to provide a specific minimum rate of climb. (Reference the Long Range Cruise Maximum Operating Altitude table in the PI chapter of the QRH). Depending on the thrust rating of the engines, the thrust limited altitude may be above or below the maneuver altitude capability

777-200, 777-300

- buffet or maneuver limited altitude - the altitude at which a specific maneuver margin exists prior to buffet onset. This altitude provides at least a 0.2g margin (33° bank) for FAA operations or a 0.3g margin (40° bank) for CAA/JAA operations prior to buffet.

777-200LR, 777-300ER

- buffet or maneuver limited altitude - the altitude at which a specific maneuver margin exists prior to buffet onset. This altitude provides at least a 0.3g margin (40° bank) prior to buffet.

Although each of these limits are checked by the FMC, available thrust may limit the ability to accomplish anything other than relatively minor maneuvering. The amber band limits do not provide an indication of maneuver capability as limited by available thrust.

The minimum maneuver speed indication on the airspeed display does not guarantee the ability to maintain level flight at that speed. Decelerating the airplane to the amber band may create a situation where it is impossible to maintain speed and/or altitude because as speed decreases airplane drag may exceed available thrust, especially while turning. Flight crews intending to operate at or near the maximum operation altitude should be familiar with the performance characteristics of the airplane in these conditions.

Note: To get the most accurate altitude limits from the FMC, ensure that the airplane weight, cruise CG, and temperature entries are correct.

777 Flight Crew Training Manual

For LNAV operation, the FMC provides a real-time bank angle limiting function. This function protects the commanded bank angle from exceeding the current available thrust limit. This bank angle limiting protection is only available when in LNAV.

For operations other than LNAV, when operating at or near maximum altitude fly at least 10 knots above the lower amber band and use bank angles of 10° or less. If speed drops below the lower amber band, immediately increase speed by doing one or more of the following:

- reduce angle of bank
- increase thrust up to maximum continuous
- descend.

Turbulence at or near maximum altitude can momentarily increase the airplane's angle-of attack and activate the stick shaker. When flying at speeds near the lower amber band, any maneuvering increases the load factor and further reduces the margin to buffet onset and stick shaker.

FMC fuel predictions are not available above the FMC maximum altitude and are not displayed on the CDU. VNAV is not available above FMC maximum altitude. Fuel burn at or above maximum altitude increases. Flight above this altitude is not recommended.

Optimum Altitude

Optimum altitude is the cruise altitude for minimum cost when operating in the ECON mode, and for minimum fuel burn when in the LRC or pilot-selected speed modes. In ECON mode, optimum altitude increases as either airplane weight or cost index decreases. In LRC or selected speed modes, optimum altitude increases as either airplane weight or speed decreases. On each flight, optimum altitude continues to increase as weight decreases during the flight.

For shorter trips, optimum altitude as defined above may not be achievable since the top of descent (T/D) point occurs prior to completing the climb to optimum altitude.

The selected cruise altitude should normally be as close to optimum as possible. Optimum altitude is the altitude that gives the minimum trip cost for a given trip length, cost index, and gross weight. It provides approximately a 1.5 load factor (approximately 48° bank to buffet onset) or better buffet margin. As deviation from optimum cruise altitude increases, performance economy deteriorates.

Some loss of thrust limited maneuver margin can be expected above optimum altitude. Levels 2000 feet above optimum altitude normally allows approximately 45° bank prior to buffet onset. The higher the airplane flies above optimum altitude, the more the thrust margin is reduced. Before accepting an altitude above optimum, determine that it will continue to be acceptable as the flight progresses under projected conditions of temperature and turbulence.

On airplanes with higher thrust engines, the altitude selection is most likely limited by maneuver margin to initial buffet. Projected temperature and turbulence conditions along the route of flight should be reviewed when requesting/accepting initial cruise altitude as well as subsequent step climbs.

Cruise Speed Determination

Cruise speed is automatically computed by the FMC and displayed on the CRZ and PROGRESS pages. It is also displayed by the command airspeed when VNAV is engaged. The default cruise speed mode is economy (ECON) cruise. The pilot can also select long range cruise (LRC), engine out modes, or overwrite fixed Mach or CAS values on the CRZ page target speed line.

ECON cruise is a variable speed schedule that is a function of gross weight, cruise altitude, cost index, and headwind or tailwind component. It is calculated to provide minimum operating cost for the entered cost index. Entry of zero for cost index results in maximum range cruise.

Note: Thrust limits or maximum speed limits are generally encountered with cost index entries of 5000 or more.

Headwinds increase the ECON CRZ speed. Tailwinds decrease ECON CRZ speed, but not below the zero wind maximum range cruise airspeed.

LRC is a variable speed schedule providing fuel mileage 1% less than the maximum available. The FMC does not apply wind corrections to LRC.

Required Time of Arrival (RTA) speed is generated to meet a time required at an RTA specified waypoint on the FMC LEGS page.

Step Climb

Flight plans not constrained by short trip distance are typically based on conducting the cruise portion of the flight close to optimum altitude. Since the optimum altitude increases as fuel is consumed during the flight, it is necessary to climb to a higher cruise altitude periodically to achieve the flight plan fuel burn. This technique, referred to as Step Climb Cruise, is typically accomplished by entering an appropriate step climb value in the FMC according to the available cruise levels. For most flights, one or more step climbs may be required before reaching T/D.

777 Flight Crew Training Manual

It may be especially advantageous to request an initial cruise altitude above optimum if altitude changes are difficult to obtain on specific routes. This minimizes the possibility of being held at a low altitude/high fuel consumption condition for long periods of time. The requested/accepted initial cruise altitude should be compared to the thrust limited or the maneuver margin limited altitudes. Remember, a cruise thrust limited altitude is dependent upon the cruise level temperature. If the cruise level temperature increases above the chart value for gross weight, maximum cruise thrust will not maintain desired cruise speed.

Step altitudes can be planned at waypoints or they can be optimum step points calculated by the FMC. Optimum step points are a function of the route length, flight conditions, speed mode, present airplane altitude, STEP TO altitude (or adjacent STEP TO altitudes) and gross weight. The FMC computed step point provides for minimum trip cost for the flight, including allowances for climb fuel. Initiate a cruise climb to the new altitude as close as practicable to the step climb point.

Note: FMC default values for the step climb may not be appropriate for RVSM or metric airspace. Manually enter the appropriate step climb values as needed.

Fuel for Enroute Climb

The additional fuel required for a 4,000 foot enroute climb varies from 300 to 1,000 lbs (225 to 450 kgs) depending on the airplane gross weight, initial altitude, air temperature, and climb speed. The fuel increment is largest for high gross weights and low initial altitudes. Additional fuel burn is offset by fuel savings in the descent. It is usually beneficial to climb to a higher altitude if recommended by the FMC or the flight plan, provided the wind information used is reliable.

Low Fuel Temperature

Fuel temperature changes relative to total air temperature. For example, extended operation at high cruise altitudes tends to reduce fuel temperature. In some cases the fuel temperature may approach the minimum fuel temperature limit.

Fuel freezing point should not be confused with fuel ice formation caused by frozen water particles. The fuel freezing point is the temperature at which the formation of wax crystals appears in the fuel. The Jet A fuel specification limits the freezing point to -40°C maximum, while the Jet A-1 limit is -47°C maximum. In the Commonwealth of Independent States (CIS), the fuel is TS-1 or RT, which has a maximum freezing point of -50°C, which can be lower in some geographical regions. The actual uplifted freezing point for jet fuels varies by the geographical region in which the fuel is refined.

Unless the operator measures the actual freezing point of the loaded fuel at the dispatch station, the maximum specification freezing point must be used. At most airports, the measured fuel freezing point can yield a lower freezing point than the specification maximum freezing point. The actual delivered freezing temperature can be used if it is known. Pilots should keep in mind that some airports store fuel above ground and, in extremely low temperature conditions, the fuel may already be close to the minimum allowable temperature before being loaded.

For blends of fuels, use the most conservative freezing point of the fuel on board as the freezing point of the fuel mixture. This procedure should be used until 3 consecutive refuelings with a lower freezing point fuel have been completed. Then the lower freezing point may be used. If fuel freezing point is projected to be critical for the next flight segment, wing tank fuel should be transferred to the center wing tank before refueling. The freezing point of the fuel being loaded can then be used for that flight segment.

Fuel temperature should be maintained within AFM limitations as specified in the Limitations chapter of the FCOM.

Maintaining a minimum fuel temperature should not be a concern unless the fuel temperature approaches the minimum temperature limit. The rate of cooling of the fuel is approximately 3° C per hour, with a maximum of 12° C per hour possible under the most extreme conditions.

Total air temperature can be raised in the following three ways, used individually or in combination:

- climb or descend to a warmer air mass
- deviate to a warmer air mass
- increase Mach number.

Note: In most situations, warmer air can be reached by descending but there have been reports of warmer air at higher flight levels. Air temperature forecasts should be carefully evaluated when colder than normal temperatures are anticipated.

It takes from 15 minutes to one hour to stabilize the fuel temperature. In most cases, the required descent would be 3,000 to 5,000 feet below optimum altitude. In more severe cases, descent to altitudes of 25,000 feet to 30,000 feet might be required. An increase of 0.01 Mach results in an increase of 0.5° to 0.7° C total air temperature.

[Appendix A.2.4](#)

777 Flight Crew Training Manual

Boeing has developed a Fuel Temperature Prediction Program (FTPP) to assist operators in addressing fuel freezing point concerns. This program is designed to be used during the flight planning process and is intended to interface with or be incorporated in an operator's flight planning system. It has been calibrated by flight test and operational data. This program enables the crew to determine if fuel temperature is a concern, helps to determine available options, and may prevent the need for in-flight crew action to stop the decline in fuel temperature.

Cruise Performance Economy

The flight plan fuel burn from departure to destination is based on certain assumed conditions. These include takeoff gross weight, cruise altitude, route of flight, temperature, enroute winds, and cruise speed.

Actual fuel burn should be compared to the flight plan fuel burn throughout the flight.

The planned fuel burn can increase due to:

- temperature above planned
- a lower cruise altitude than planned
- cruise altitude more than 2,000 feet above optimum altitude
- speed faster than planned or appreciably slower than long range cruise speed when long range cruise was planned
- stronger headwind component
- fuel imbalance
- improperly trimmed airplane
- excessive thrust lever adjustments.

Cruise fuel penalties can be approximated using the following guidance. For flight planning purposes, reference the appropriate airplane Flight Planning and Performance Manuals:

- ISA + 10° C: 1% increase in trip fuel
- 2,000 feet above optimum altitude: 1% to 2% increase in trip fuel
- 4,000 feet below optimum altitude: 4% to 5% increase in trip fuel
- 8,000 feet below optimum altitude: 12% to 14% increase in trip fuel
- cruise speed 0.01M above scheduled: 1% to 2% increase in trip fuel.

For cruise within 2,000 feet of optimum, long range cruise speed can be approximated by using 0.84M. Long range cruise also provides the best buffet margin at all cruise altitudes.

Note: If a discrepancy is discovered between actual fuel burn and flight plan fuel burn that cannot be explained by one of the items above, a fuel leak should be considered. Accomplish the applicable non-normal checklist.

Engine Inoperative Cruise/Driftdown

Performance of a non-normal checklist or sudden engine failure may lead to the requirement to perform a single engine driftdown.

Engine inoperative cruise information is available from the FMC.

If an engine failure occurs while at cruise altitude, it may be necessary to descend. On the FMC ACT CRZ page, select ENG OUT. This displays MOD CRZ calculated on engine out MCT and maintaining the airspeed displayed on the EO SPD line.

Set the engine out cruise altitude in the MCP altitude window and execute the EO D/D page. Thrust reference changes to CON and the autothrottle maintains MCT. The airplane descends in VNAV using the VNAV SPD pitch mode. The VNAV SPD mode may command the airplane to nearly level flight to control an airspeed increase above the driftdown target speed. If the excess airspeed cannot be reduced with the airplane in nearly level flight, then the FMC transitions to the VNAV PTH mode. In the VNAV PTH mode, the FMC commands a flight path for a 300 fpm descent rate. The autothrottle SPD mode then controls the airspeed.

At altitude capture the ENG OUT CRZ page is displayed. Maintain MCT and driftdown altitude until the EO SPD speed is established.

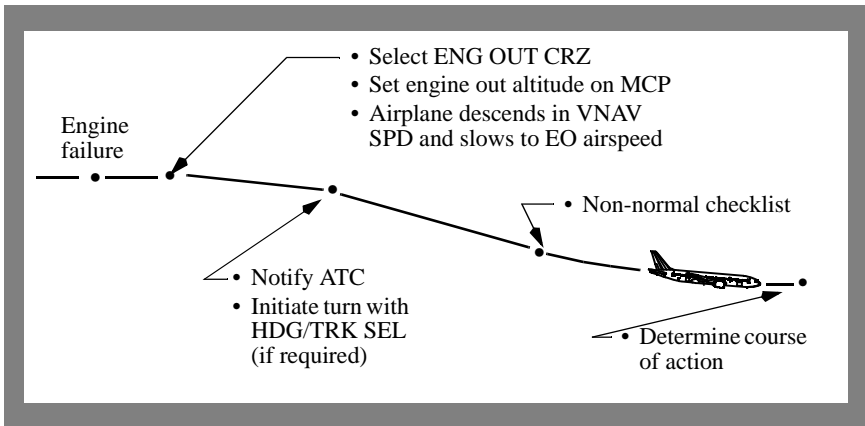

Note: If the airplane is at or below maximum engine out altitude when an engine becomes inoperative, select and execute the EO CRZ page and maintain engine out cruise speed.

If required to cruise at maximum altitude, set MCT and establish a climb, decelerating slowly to EO CLB speed. At level off select EO LRC for best fuel economy.

777 Flight Crew Training Manual

An alternate target driftdown speed can be selected using the MOD CRZ or EO D/D page. LRC speed would result in a lower driftdown altitude but better fuel performance. A company speed (CO SPD) could be selected, as specified in the AMI (Airline Modifiable Information file) and provides for a higher driftdown speed and a shorter flight time to the alternate.

An engine out cruise altitude can be entered on the MOD CRZ or EO D/D page. If an engine out cruise altitude is entered while the airplane is more than 150 feet above the computed maximum altitude, the FMC commands a driftdown schedule for descent to the entered engine out cruise altitude. If a cruise altitude is entered after the airplane has descended to within 150 feet of the computed maximum altitude or to a lower altitude, the FMC commands a cruise descent at approximately 1,250 fpm for descent to a lower engine out cruise altitude.

Unless altered by the pilot, the level off cruise mode will be the same as was used during driftdown. FMC fuel and ETA calculations for the driftdown and remainder of the trip will be consistent with the selected speed mode. For best fuel performance select the engine-out LRC mode following a minimum drag speed (E/O) driftdown.

When VNAV is not used during engine out, set MCT on the operative engine and maintain altitude until the airplane decelerates to the displayed appropriate engine out speed. Use engine out speed from the FMC while descending to the engine out cruise altitude. Remain at MCT until the airplane accelerates to LRC, then maintain LRC speed. If the FMC is inoperative use turbulence penetration airspeed to driftdown and the engine out long-range cruise tables in the QRH.

High Altitude High Speed Flight

The airplane exhibits excellent stability throughout the high altitude / high Mach range. Mach buffet is not normally encountered at high Mach cruise. The airplane does not have a Mach tuck tendency.

As speed nears MMO, drag increases rapidly. At high weights, sufficient thrust may not be available to accelerate to MMO in level flight at normal cruising altitudes.

Flight Control Sensitivity at High Speed and High Altitude

An understanding of flight control sensitivity at high speed and high altitude is necessary for operators of modern day airplanes. There have been reports of passenger injuries due to over-controlling the airplane during high altitude, high airspeed flight when overriding the control column with the autopilot engaged or after disengaging the autopilot with the disconnect switch.

Pilots should understand that, in general, the airplane is significantly more sensitive in pitch response (load factor) to column movement at cruise than it is at lower speeds associated with takeoff and landing. Similarly, for a given attitude change, the change in rate of climb is proportional to the true airspeed. For example, an attitude change at 290 knots KIAS at sea level that results in a 500 fpm rate of climb would result in approximately a 900 fpm rate if done at 290 knots KIAS at 35,000 feet. This is because 290 KIAS is equivalent to a TAS of approximately 290 knots at sea level and 490 knots at 35,000 feet. This characteristic is essentially true for small attitude changes, such as the kind used to hold altitude.

Other factors such as gross weight and CG also affect flight control sensitivity and stability, but as long as the CG is in the allowable range the handling qualities will be adequate. However, to avoid over-controlling the flight controls during high altitude high airspeed flight, smooth and small control inputs should be made after disconnecting the autopilot.

ETOPS

Extended Operations (ETOPS) for two engine airplanes are those flights which include points at a flying distance greater than one hour (in still air) from an adequate airport, at engine out cruise speed.

ETOPS Requirements and Approval

[Appendix A.2.5](#)

The Minimum Equipment List (MEL) and the Dispatch Deviations Guide (DDG) include dispatch relief levels appropriate to ETOPS. Refer to operators procedures and policies for more information on ETOPS requirements.

Flight and Performance

[Appendix A.2.5](#)

Crews undertaking ETOPS flights must be familiar with the ETOPS alternate airports listed in the flight plan. These airports must meet ETOPS weather minima which require an incremental increase above conventional alternate minimums at dispatch, and be located so as to ensure that the airplane can divert and land in the event of a system failure requiring a diversion.

777 Flight Crew Training Manual

Planning an ETOPS flight requires an understanding of the area of operations, critical fuel reserves, altitude capability, cruise performance tables and icing penalties. The Flight Planning and Performance Manual (FPPM) provides guidance to compute critical fuel reserves which are essential for the flight crew to satisfy the requirements of the ETOPS flight profile. The FPPM also provides one engine inoperative altitude capability and cruise and diversion fuel information at ETOPS planning speeds. This information is not included in the FCOM/QRH. Fuel reserve corrections must be made for winds, non-standard atmospheric conditions, performance deterioration caused by engines or airframe, and when needed, flight through forecast icing conditions.

Note: Critical fuel calculations are part of the ETOPS dispatch process and are not normally calculated by the flight crew. The crew normally receives ETOPS critical fuel information in the Computer Flight Plan (CFP).

Procedures

ETOPS engine-out procedures may be different from standard non-normal procedures. Following an engine failure the crew performs a modified “driftdown” procedure determined by the ETOPS route requirements. This procedure typically uses higher descent and cruise speeds, and a lower cruise altitude following engine failure. This allows the airplane to reach an alternate airport within the specific time limits authorized for the operator. These cruise speeds and altitudes are determined by the operator and approved by its regulatory agency and usually differ from the engine-out speeds provided by the FMC. The captain, however, has the discretion to modify this speed if actual conditions following the diversion decision dictate such a change.

Polar Operations[Appendix A.2.5](#)

Refer to the FMC Polar Navigation section in Volume 2 of the FCOM for specifics about operations in polar regions and a description of the boundaries of the polar regions.

During preflight planning extremely cold air masses should be noted and cold fuel temperatures should be considered. See the Low Fuel Temperature section in this chapter for details regarding recommendations and crew actions.

Due to limited availability of alternate airports relative to other regions, special attention should be given to diversion planning including airport conditions and availability of compatible fuel. Crews should be prepared to operate in QFE and metric altitude where required. Expect changes in assigned cruising levels enroute since standard cruising levels vary by FIR. Some airports provide QNH upon request, even if their standard is QFE. Metric wind speed (m/sec) may be all that is available. A simple approximation: 1 m/sec = 2 knots. A feet to meters conversion chart may be useful for planning step climbs, converting minima, etc.

Use caution when using ADF and/or VOR raw data. ADF orientation (true or magnetic) is determined by the heading reference selected by the crew. VOR radials are displayed according to the orientation of the VOR station.

Communications should be handled according to the applicable enroute charts. Above 82 degrees N, SATCOM is unavailable. HF frequencies and HF SELCAL must be arranged by the flight crew prior to the end of SATCOM coverage. Routine company communications procedures should include flight following to enable immediate assistance during a diversion or other emergency.

Note: To use SATCOM on the ground, the ADIRU must be aligned.

When navigating in the polar regions, magnetic heading should be considered unreliable or totally useless for navigation. Magnetic variations typically are extreme, often are not constant at the same point and change rapidly as airplane position changes. Ensure the computer flight plan shows true tracks and true headings. Grid headings may also be used as a reference for those airplanes equipped with grid heading indicators although no airplane systems use grid heading. For some high latitude airports, grid headings are shown on the instrument approach procedures. Note that unmapped areas in the GPWS terrain database display as magenta dots on the map, regardless of the airplane altitude.

The primary roll mode for polar operations should be LNAV, which may be used with the heading reference switch in the NORM position. HDG SEL/HOLD and TRK SEL/HOLD are functional but require the manual selection of TRUE heading reference. Deviations from planned route may be accomplished in TRK SEL or HDG SEL.

If either the North Pole (NPOLE) or the South Pole (S90EXXXXX or S90WXXXXX) waypoint is used, a rapid heading and track reversal occurs passing the polar waypoint. If operating in HDG/TRK SEL or HDG/TRK HOLD while near either pole, it is necessary to frequently update the heading/track selector to reflect the rapidly changing and/or reversed heading/track or the AFDS will command an unwanted turn. For this reason, LNAV is the preferred roll mode.

Loss of both GPS units or loss of GPS updating results in an increased ANP and possible display of the NAV UNABLE RNP message, but normally does not prevent polar operation.

777 Flight Crew Training Manual

The ADIRU is a fault tolerant unit. Total failure of the ADIRU is an extremely unlikely event since a number of independent failures must occur before all navigation functions are lost. In the unlikely event the ADIRU does fail, the non-normal checklist provides the crew with inoperative items and necessary crew actions. With at least one GPS operational, the Navigation Display is operational and accurately displays the FMC route and airplane track and position information. LNAV is inoperative. A heading reference must be entered into the FMC to regain use of the compass rose. Because of the large and rapidly changing magnetic variations in the polar regions, it may be more practical to enter the true track as a heading reference while in the polar region. This provides a more intuitive navigation display and allow tracking of the planned route in HDG SEL. True track may be obtained from the computer flight plan or from the Navigation Display. Magnetic compass information should be used, if available, to update the heading reference when departing the polar region. With a total ADIRU failure, plan a raw data instrument approach.

Descent

Descent Speed Determination

The default FMC descent speed schedule is an economy (ECON) descent from cruise altitude to the airport speed transition altitude. At the airport speed transition altitude, the airspeed is reduced to the airport speed restriction speed in the navigation database minus 10 knots. The speed schedule is adjusted to accommodate waypoint speed/altitude constraints displayed on the LEGS pages, and speed/altitude constraints displayed on the DES page. If desired, the ECON speed schedule can be modified by alternate Mach, Mach/IAS, or IAS values on the DES page target speed line. If the FMC information is not available, use target speeds from the Descent Rates table in this chapter.

Descent Path

An FMC path descent is the most economical descent method. At least one waypoint-related altitude constraint below cruise altitude on a LEGS page generates a descent guidance path. The path is built from the lowest constraint upward, assuming idle thrust, or approach idle below the anti-ice altitude entered on the DESCENT FORECAST page.

The path is based on the descent speed schedule, any entered speed/altitude constraints or forecast use of anti-ice. The path reflects descent wind values entered on the DESCENT FORECAST page.

Descent Constraints

Descent constraints may be automatically entered in the route when selecting an arrival procedure, or manually entered through the CDU.

Normally, set all mandatory altitude restrictions and “at or above” constraints in the MCP altitude window. The next altitude may be set when the restriction has been assured or further clearance has been received. This procedure provides altitude alerting and ensures compliance with altitude clearance limits.

When using VNAV, if altitude constraints are closely spaced to the extent that crew workload is adversely affected and unwanted level-offs are a concern, the alternate MCP altitude setting technique can be used with operator approval. Refer to Chapter 1, MCP Altitude Setting Techniques Using VNAV for more information on this subject.

Note: When the alternate MCP altitude setting technique using VNAV is used, the selection of a pitch mode other than VNAV PTH or VNAV SPD for descent will result in a risk of violating altitude constraints.

777 Flight Crew Training Manual

For descents in pitch modes other than VNAV PTH or VNAV SPD, the MCP altitude must be set at the next altitude constraint, or as published in the FCOM for an instrument approach.

Shallow vertical path segments may result in the autothrottle supplying partial thrust to maintain the target speed. Vertical path segments steeper than an idle descent may require the use of speedbrakes for speed control. Deceleration requirements below cruise altitude (such as at 10,000 MSL) are accomplished based on a rate of descent of approximately 500 fpm. When a deceleration is required at top of descent, it is performed in level flight.

Speed Intervention

VNAV speed intervention can be used to respond to ATC speed change requirements. VNAV SPD pitch mode responds to speed intervention by changing airplane pitch while the thrust remains at idle. VNAV PTH pitch mode may require the use of speedbrakes or increased thrust to maintain the desired airspeed.

Offpath Descent

The LEGS pages should reflect the planned arrival procedure. If a published arrival procedure is required for reference while being radar vectored, or the arrival is momentarily interrupted by a heading vector from ATC, the offpath descent circles provide a good planning tool to determine drag and thrust requirements for the descent.

The outer circle is referenced to the end of descent point, using a clean configuration and a direct path from the airplane position to the end of descent waypoint constraint. The inner circle is referenced to the end of descent point using speedbrakes. A separate waypoint may be entered on the OFFPATH DES page as a reference for the descent circles.

Both circles assume normal descent speed schedules, including deceleration at transition altitude, but do not include waypoint speed and altitude constraints.

Descent Planning

Flight deck workload typically increases as the airplane descends into the terminal area. Distractions must be minimized and administrative and nonessential duties completed before descent or postponed until after landing. Perform essential duties early in the descent so more time is available during the critical approach and landing phases.

Operational factors and/or terminal area requirements may not allow following the optimum descent schedule. Terminal area requirements can be incorporated into basic flight planning but ATC, weather, icing and other traffic may require adjustments to the planned descent schedule.

Proper descent planning is necessary to arrive at the desired altitude at the proper speed and configuration. The distance required for the descent is approximately 3 NM/1000 feet altitude loss for no wind conditions using ECON speed. Rate of descent is dependent upon thrust, drag, airspeed schedule and gross weight.

Descent Rates

Descent Rate tables provide typical rates of descent below 20,000 feet with idle thrust and speedbrakes extended or retracted.

Target Speed	Rate of Descent (Typical)	
	Clean	With Speedbrake
0.84M / 310 knots	2200 fpm	5300 fpm
250 knots	1400 fpm	3300 fpm
VREF 30 + 80	1000 fpm	2300 fpm

Normally, descend with idle thrust and in clean configuration (no speedbrakes). Maintain cruise altitude until the proper distance or time out for the planned descent and then hold the selected airspeed schedule during descent. Deviations from this schedule may result in arriving too high at destination and require circling to descend, or arriving too low and far out requiring extra time and fuel to reach destination.

The speedbrake may be used to correct the descent profile if arriving too high or too fast. The Descent Procedure is normally initiated before the airplane descends below the cruise altitude for arrival at destination, and should be completed by 10,000 feet MSL. The Approach Procedure is normally started at transition level.

Plan the descent to arrive at traffic pattern altitude at flaps up maneuvering speed approximately 12 miles from the runway when proceeding straight-in or about 8 miles out when making an abeam approach. A good crosscheck is to be at 10,000 feet AGL, 30 miles from the airport, at 250 knots.

Losing airspeed can be difficult and may require a level flight segment. For planning purposes, it requires approximately 60 seconds and 6 NM to decelerate from 310 to 250 knots in level flight without speedbrakes. It requires an additional 50 seconds and 4 NM to decelerate to flaps up maneuvering speed at average gross weights. Using speedbrakes to aid in deceleration reduces these times and distances by approximately 50%.

Maintaining the desired descent profile and using the map mode to maintain awareness of position ensures a more efficient operation. Maintain awareness of the destination weather and traffic conditions, and consider the requirements of a potential diversion. Review the airport approach charts and discuss the plan for the approach, landing, and taxi routing to parking. Complete the approach briefing as soon as practical, preferably before arriving at top of descent. This allows full attention to be given to airplane control.

Speedbrakes

The PF should keep a hand on the speedbrake lever when the speedbrakes are used in-flight. This helps prevent leaving the speedbrake extended when no longer required.

Use of speedbrakes does not appreciably affect airplane roll response. While using the speedbrakes in descent, allow sufficient altitude and airspeed margin to level off smoothly. Lower the speedbrakes before adding thrust.

To avoid buffeting, use of speedbrakes with flaps greater than 5 should be avoided. If circumstances dictate the use of speedbrakes with flaps extended, high sink rates during the approach should be avoided. Speedbrakes should be retracted before reaching 1,000 feet AGL.

The flaps are normally not used for increasing the descent rate. Normal descents are made in the clean configuration to pattern or instrument approach altitude.

When descending with the autopilot engaged and the speedbrakes extended at speeds near VMO/MMO, the airspeed may momentarily increase to above VMO/MMO if the speedbrakes are retracted quickly. To avoid this condition, smoothly and slowly retract the speedbrakes to allow the autopilot sufficient time to adjust the pitch attitude to maintain the airspeed within limits.

When the speedbrakes are retracted during altitude capture near VMO/MMO, a momentary overspeed condition may occur. This is because the autopilot captures the selected altitude smoothly by maintaining a fixed path while the thrust is at or near idle. To avoid this condition, it may be necessary to reduce the selected speed and/or descent rate prior to altitude capture or reduce the selected speed and delay speedbrake retraction until thrust is increased to maintain level off airspeed.

Flaps and Landing Gear

Normal descents are made in the clean configuration to pattern or instrument approach altitude. If greater descent rates are desired, extend the speedbrakes. When thrust requirements for anti-icing result in less than normal descent rates with speedbrakes extended, or if higher than normal descent rates are required by ATC clearance, the landing gear can be lowered to increase the rate of descent.

Extend the flaps when in the terminal area and conditions require a reduction in airspeed below flaps up maneuvering speed. Normally select flaps 5 prior to the approach fix going outbound, or just before entering downwind on a visual approach.

Note: Avoid using the landing gear for increased drag above 200 knots. This minimizes passenger discomfort and increases gear door life.

Speed Restrictions

Speed restrictions below specific altitudes/flight levels and in the vicinity of airports are common. At high gross weights, minimum maneuvering speed may exceed these limits. Consider extending the flaps to attain a lower maneuvering speed or obtain clearance for a higher airspeed from ATC.

Other speeds may be assigned by ATC. Pilots complying with speed adjustments are expected to maintain the speed within plus or minus 10 knots.

Engine Icing During Descent

The use of anti-ice and the increased thrust required increases the descent distance. Therefore, proper descent planning is necessary to arrive at the initial approach fix at the correct altitude, speed, and configuration. The anticipated anti-ice use altitude should be entered on the DESCENT FORECAST page to assist the FMC in computing a more accurate descent profile.

Engine icing may form when not expected and may occur when there is no evidence of icing on the windshield or other parts of the airplane. Once ice starts to form, accumulation can build very rapidly. Although one bank of clouds may not cause icing, another bank, which is similar, may induce icing.

Note: The engine anti-icing system should be AUTO or ON whenever icing conditions exist or are anticipated. Failure to follow the recommended anti-ice procedures can result in engine stall, overtemperature or engine damage.

Holding

Start reducing to holding airspeed 3 minutes before arrival time at the holding fix so that the airplane crosses the fix, initially, at or below the maximum holding airspeed.

If the FMC holding speed is greater than the ICAO or FAA maximum holding speed, holding may be conducted at flaps 1, using flaps 1 maneuvering speed. Flaps 1 uses approximately 7% more fuel than flaps up. Holding speeds in the FMC provide an optimum holding speed based upon fuel burn and speed capability, but are never lower than flaps up maneuvering speed.

777 Flight Crew Training Manual

Maintain clean configuration if holding in turbulence. Clean configuration is also recommended for holding in icing conditions. However, to comply with speed restrictions, flaps 1 may be used in icing.

If the holding pattern has not been programmed in the FMC, the initial outbound leg should be flown for 1 minute or 1 1/2 minutes as required by altitude. Timing for subsequent outbound legs should be adjusted as necessary to achieve proper inbound leg timing.

In extreme wind conditions or at high holding speeds, the defined holding pattern protected airspace may be exceeded. However, the holding pattern depicted on the map display will not exceed the limits.

Holding Airspeeds

Advise ATC if an increase in airspeed is necessary due to turbulence, if unable to accomplish any part of the holding procedure, or if unable to comply with speeds listed in the following tables.

ICAO Holding Airspeeds (Maximum)

Altitude	Speed
Through 14,000 feet	230 knots
Above 14,000 to 20,000 feet MSL	240 knots
Above 20,000 to 34,000 feet MSL	265 knots
Above 34,000 feet MSL	0.83M

FAA Holding Airspeeds (Maximum)

Altitude	Speed
Through 6,000 feet MSL	200 knots
6,001 feet MSL through 14,000 feet MSL	230 knots (210 knots Washington D. C. & New York FIRs)
14,001 feet MSL and above	265 knots

Procedure Holding

When a procedure holding pattern is selected from the navigation database and the FMC shows PROC HOLD on the legs page, the following is true when the PROC HOLD is the active leg:

- exiting the holding pattern is automatic; there is no need to select EXIT HOLD
- if the crew desires to remain in holding a new holding pattern must be entered.

Holding Airspeeds Not Available from the FMC

If holding speed is not available from the FMC, refer to the PI section of the QRH. If time does not permit immediate reference to the QRH, the following speed schedule may be used temporarily. This simplified holding speed schedule may not match the FMC or QRH holding speeds because the FMC and QRH holding speeds are based on many conditions that cannot be generalized into a simple schedule. However, this schedule provides a reasonable approximation of minimum fuel burn speed with appropriate margins to initial buffet.

Recommended holding speeds can be approximated by using the following guidance until more accurate speeds are obtained from the QRH:

- flaps up maneuvering speed approximates minimum fuel burn speed and may be used at low altitudes

777-200, 777-300

- above FL250, use VREF 30 + 100 knots to provide adequate buffet margin.

777-200LR, 777-300ER

- above 10,000 feet, use VREF 30 + 120 knots to provide adequate buffet margin.



Approach and Missed Approach

Chapter 5

Table of Contents

Section TOC

Preface	5.1
Approach	5.1
Instrument Approaches	5.1
Approach Briefing	5.2
Approach Category	5.2
Obstruction Clearance for a Circling Approach	5.3
Approach Clearance	5.3
Procedure Turn	5.3
Stabilized Approach Recommendations	5.4
Mandatory Missed Approach	5.5
Landing Minima	5.6
Radio Altimeter	5.6
Flap Configurations for Approach and Landing	5.6
Flap Setting for Lading	5.6
Flap Extension	5.7
Maneuver Margin	5.7
Missed Approach Point	5.7
Determination of a MAP	5.8
Instrument Landing System	5.8
Instrument Approach using VNAV	5.8
Localizer	5.9
Other Non-ILS Approaches	5.9
Precision Approach Radar	5.9
Airport Surveillance Radar	5.9
ILS Approach	5.10
Fail Operational	5.10



Fail Passive	5.10
ILS Approach - Fail Operational	5.11
Decision Altitude or Height - DA(H)	5.12
Alert Height - AH	5.12
Procedure Turn and Initial Approach	5.12
Approach	5.12
Decision Altitude or Height - DA(H)	5.16
Raw Data - (No Flight Director)	5.16
AFDS Autoland Capabilities	5.18
Low Visibility Approaches	5.19
AFDS Faults	5.21
ILS Approach - Landing Geometry	5.22
Non-Normal Operations	5.23
Non - ILS Instrument Approaches	5.26
Non - ILS Instrument Approaches - General	5.26
Procedure Turn and Initial Approach	5.34
Vertical Path Construction	5.34
Instrument Approach Using VNAV	5.37
Instrument Approach Using V/S or FPA	5.43
Instrument Approach - RNAV (RNP) SAAAR/AR	5.47
Visual Descent Point	5.50
Missed Approach - Non-ILS	5.51
Circling Approach	5.52
Circling Approach - General	5.53
Obstruction Clearance	5.53
Circling Approach - One Engine Inoperative	5.54
Missed Approach - Circling	5.55
Visual Traffic Pattern	5.57
Visual Approach - General	5.58



777 Flight Crew Training Manual

Thrust	5.58
Downwind and Base Leg	5.58
Final Approach	5.59
Engine Failure On Final Approach	5.59
Touch and Go Landings.....	5.60
Touch and Go Landing - General	5.61
Approach.....	5.61
Landing	5.61
Stop and Go Landings	5.61
Go-Around and Missed Approach - All Approaches	5.63
Go-Around and Missed Approach - All Engines Operating	5.64
Go-Around after Touchdown	5.66
Go-Around and Missed Approach - One Engine Inoperative	5.66
Engine Failure During Go-Around and Missed Approach.....	5.66



Intentionally
Blank



Preface

This chapter outlines recommended operating practices and techniques for ILS, non-ILS, circling and visual approaches, and the Go-Around and Missed Approach maneuver. Flight profile illustrations represent the recommended basic configuration for normal and non-normal flight maneuvers and provide a basis for standardization and crew coordination.

The maneuvers are normally accomplished as illustrated. However, due to conflicting traffic at training airports, air traffic separation requirements, and radar vectors, modifications may be necessary. Conditions beyond the control of the flight crew may preclude following an illustrated maneuver exactly. The maneuver profiles are not intended to replace good judgment and logic.

Approach

Instrument Approaches

All safe instrument approaches have certain basic factors in common. These include good descent planning, careful review of the approach procedure, accurate flying, and good crew coordination. Thorough planning is the key to a safe, unhurried, professional approach.

Ensure the waypoint sequence on the LEGS page, altitude and speed restrictions, and the map display reflect the air traffic clearance. Last minute air traffic changes or constraints may be managed by appropriate use of the MCP heading, altitude and airspeed selectors. Updating the waypoint sequence on the LEGS page should be accomplished only as time permits.

Complete the approach preparations before arrival in the terminal area. Set decision altitude or height DA(H), or minimum descent altitude or height MDA(H). Crosscheck radio and pressure altimeters whenever practical. Do not completely abandon enroute navigation procedures even though air traffic is providing radar vectors to the initial or final approach fix. Check ADF/VOR selector set to the proper position. Verify ILS, VOR and ADF are tuned and identified if required for the approach.

Note: The requirement to tune and identify nav aids can be satisfied by confirming that the tuned nav aid frequency is replaced by the correct alphabetical identifier on the PFD/ND or by aurally identifying the nav aid.

Check that the marker beacon is selected on the audio panel. The course and glide slope signals are reliable only when their warning flags are not displayed, localizer and glide slope pointers are in view, and the ILS identifier is received. Confirm the published approach inbound course is set or displayed.

Do not use radio navigation aid facilities that are out of service even though flight deck indications appear normal. Radio navigation aids that are out of service may have erroneous transmissions that are not detected by airplane receivers and no flight deck warning is provided to the crew.

Approach Briefing

Before the start of an instrument approach, the PF should brief the PM of his intentions in conducting the approach. Both pilots should review the approach procedure. All pertinent approach information, including minimums and missed approach procedures, should be reviewed and alternate courses of action considered.

As a guide, the approach briefing should include at least the following:

- weather and NOTAMS at destination and alternate, as applicable
- type of approach and the validity of the charts to be used
- navigation and communication frequencies to be used
- minimum safe sector altitudes for that airport
- approach procedure including courses and heading
- vertical profile including all minimum altitudes, crossing altitudes and approach minimums
- speed restrictions
- determination of the Missed Approach Point (MAP) and the missed approach procedure
- other related crew actions such as tuning of radios, setting of course information, or other special requirements
- taxi routing to parking
- any appropriate information related to a non-normal procedure
- management of AFDS.

Approach Category

Appendix A.2.6

An aircraft approach category is used for straight-in approaches. The designated approach category for an aircraft is defined using the maximum certified landing weight as listed in the AFM. Under FAA criteria, the speed used to determine the approach category is the landing reference speed (VREF). ICAO and other regulatory agencies may use different criteria.

Category	IAS
C	121 knots or more but less than 141 knots
D	141 knots or more but less than 166 knots

Under FAA criteria:

777 Flight Crew Training Manual

777-200, 777-200LR

- the 777-200 series airplanes are classified as Category “C” airplanes.

777-300, 777-300ER

- the 777-300 series airplanes and the 777 Freighter are classified as Category “D” airplanes.

Obstruction Clearance for a Circling Approach

For circling approaches, maximum airplane speeds are shown on the approach plate instead of airplane approach categories. Circling approach minimums for both FAA and ICAO criteria are based on obstruction clearance for approach maneuvering within a defined region of airspace. This region of airspace is determined by maximum IAS. This region gets larger with higher speed, which may result in higher approach minimums depending on the terrain characteristics surrounding the airport. Similarly, lower airspeed may result in a lower approach minimum. See the section titled Circling Approach later in this chapter for more information on obstruction clearance.

Approach Clearance

When cleared for an approach and on a published segment of that approach, the pilot is authorized to descend to the minimum altitude for that segment. When cleared for an approach and not on a published segment of the approach, maintain assigned altitude until crossing the initial approach fix or established on a published segment of that approach. If established in a holding pattern at the final approach fix, the pilot is authorized to descend to the procedure turn altitude when cleared for the approach.

If using a VNAV path, all altitude and speed constraints must be entered either manually, by selecting a published arrival, or by a combination of both. When properly entered, the VNAV path profile complies with all altitude and airspeed constraints. Crossing altitudes may be higher than the minimum altitudes for that segment because the VNAV path is designed to optimize descent profiles.

When conducting an instrument approach from the holding pattern, continue on the same pattern as holding, extend flaps to 5 on the outbound track parallel to final approach course. Turn inbound on the procedure turn heading. This type of approach is also referred to as a race track approach.

Procedure Turn

On most approaches the procedure turn must be completed within specified limits, such as within 10 NM of the procedure turn fix or beacon. The FMC depicted procedure turn, or holding pattern in lieu of procedure turn, complies with airspace limits. The published procedure turn altitudes are normally minimum altitudes.

The procedure turn size is determined by the ground speed at the IAF.

Adjust time outbound for airspeed, wind effects, and location of the procedure turn fix. If the procedure turn fix is crossed at an excessively high ground speed, the procedure turn protected airspace may be exceeded. The procedure turn should be monitored using the map to assure the airplane remains within protected airspace.

Stabilized Approach Recommendations

Maintaining a stable speed, descent rate, and vertical/lateral flight path in landing configuration is commonly referred to as the stabilized approach concept.

Any significant deviation from planned flight path, airspeed, or descent rate should be announced. The decision to execute a go-around is no indication of poor performance.

Note: Do not attempt to land from an unstable approach.

Recommended Elements of a Stabilized Approach

The following recommendations are consistent with criteria developed by the Flight Safety Foundation.

All approaches should be stabilized by 1,000 feet AFE in instrument meteorological conditions (IMC) and by 500 feet AFE in visual meteorological conditions (VMC). An approach is considered stabilized when all of the following criteria are met:

- the airplane is on the correct flight path
- only small changes in heading and pitch are required to maintain the correct flight path
- the airplane should be at approach speed. Deviations of +10 knots to – 5 knots are acceptable if the airspeed is trending toward approach speed
- the airplane is in the correct landing configuration
- sink rate is no greater than 1,000 fpm; if an approach requires a sink rate greater than 1,000 fpm, a special briefing should be conducted
- thrust setting is appropriate for the airplane configuration
- all briefings and checklists have been conducted.

Specific types of approaches are stabilized if they also fulfill the following:

- ILS approaches should be flown within one dot of the glide slope and localizer, or within the expanded localizer scale
- during a circling approach, wings should be level on final when the airplane reaches 300 feet AFE.

Unique approach procedures or abnormal conditions requiring a deviation from the above elements of a stabilized approach require a special briefing.

Note: An approach that becomes unstabilized below 1,000 feet AFE in IMC or below 500 feet AFE in VMC requires an immediate go-around.

777 Flight Crew Training Manual

These conditions should be maintained throughout the rest of the approach for it to be considered a stabilized approach. If the above criteria cannot be established and maintained at and below 500 feet AFE, initiate a go-around.

At 100 feet HAT for all visual approaches, the airplane should be positioned so the flight deck is within, and tracking to remain within, the lateral confines of the runway edges extended.

As the airplane crosses the runway threshold it should be:

- stabilized on approach airspeed to within + 10 knots until arresting descent rate at flare
- on a stabilized flight path using normal maneuvering
- positioned to make a normal landing in the touchdown zone (the first 3,000 feet or first third of the runway, whichever is less).

Initiate a go-around if the above criteria cannot be maintained.

Maneuvering (including runway changes and circling)

When maneuvering below 500 feet, be cautious of the following:

- descent rate change to acquire glide path
- lateral displacement from the runway centerline
- tailwind or crosswind components
- runway length available.

Mandatory Missed Approach

On all instrument approaches, where suitable visual reference has not been established and maintained, execute an immediate missed approach when:

- a navigation radio or flight instrument failure occurs which affects the ability to safely complete the approach
- the navigation instruments show significant disagreement
- on ILS final approach and either the localizer or the glide slope indicator shows full deflection
- on an RNP based approach and an alert message indicates that ANP exceeds RNP
- for airplanes with NPS, during RNP approach operation, anytime the NPS deviation exceeds the limit or an amber deviation alert occurs and the crew is unable to change to a non-RNP procedure
- for airplanes without NPS, during RNP approach operation, anytime the XTK exceeds 1.0 X RNP and the crew is unable to change to a non-RNP procedure
- on a radar approach and radio communication is lost.

Landing Minima

Most regulatory agencies require visibility for landing minima. Ceilings are not required. There are limits on how far an airplane can descend without visual contact with the runway environment when making an approach. Descent limits are based on a decision altitude or height DA(H) for approaches using a glide slope or certain approaches using a VNAV path; or a MDA(H) for approaches that do not use vertical guidance, or where a DA(H) is not authorized for use. Most agencies do not require specific visual references below alert height (AH).

Approach charts use the abbreviation DA(H) or MDA(H). DA(H) applies to Category I, II, and certain fail passive Category III operations. A decision altitude “DA” or minimum descent altitude “MDA” is referenced to MSL and the parenthetical height “(H)” is referenced to Touchdown Zone Elevation (TDZE) or threshold elevation. Example: A DA(H) of 1,440’ (200’) is a DA of 1,440’ with a corresponding height above the touchdown zone of 200’.

When RVR is reported for the landing runway, it typically is used in lieu of the reported meteorological visibility.

Radio Altimeter

A Radio Altimeter (RA) is normally used to determine DH when a DA(H) is specified for Category II or Category III approaches, or to determine alert height (AH) for Category III approaches. Procedures at airports with irregular terrain may use a marker beacon instead of a DH to determine the missed approach point.

The radio altimeter may also be used to crosscheck the primary altimeter over known terrain in the terminal area. However, unless specifically authorized, the radio altimeter is not used for determining MDA(H) on instrument approaches. It should also not be used for approaches where use of the radio altimeter is not authorized (RA NOT AUTHORIZED). However, if the radio altimeter is used as a safety backup, it should be discussed in the approach briefing.

Flap Configurations for Approach and Landing

During maneuvering for an approach, when the situation dictates an earlier than normal speed reduction, the use of flaps 15 or flaps 20 with the gear up is acceptable.

Flap Setting for Landing

For normal landings, use flaps 25 or flaps 30. When conditions permit, use flaps 30 to minimize landing speed, and landing distance. Flaps 25 provides better noise abatement and reduced flap wear/loads.

Note: Runway length and condition must be taken into account when selecting a landing flap position.

Flap Extension

During flap extension, selection of the flaps to the next flap position should be made when approaching, and before decelerating below, the maneuver speed for the existing flap position. The flap extension speed schedule provides full maneuver capability or at least 40° of bank (25° angle of bank and 15° overshoot) to stick shaker at all weights.

Flap Extension Schedule

Current Flap Position	At Speedtape "Display"	Select Flaps	Command Speed for Selected Flaps
UP	"UP"	1	"1"
1	"1"	5	"5"
5	"5"	20	"20"
20	"20"	25 or 30	(Vref 25 or Vref 30) plus wind additives

Maneuver Margin

Flight profiles should be flown at, or slightly above, the recommended maneuver speed for the existing flap configuration. These speeds approximate maximum fuel economy and allow full maneuvering capability (25° bank with a 15° overshoot).

Full maneuver margin exists for all normal landing procedures whenever speed is at or above the maneuver speed for the current flap setting. At least adequate maneuver margin exists with flaps 20 at VREF 30 + 5 during a go-around at go-around thrust.

Airspeeds recommended for non-normal flight profiles are intended to restore near normal maneuvering margins and/or aerodynamic control response.

The configuration changes are based on maintaining full maneuvering and/or maximum performance unless specified differently in individual procedures. It is necessary to apply wind additives to the VREF speeds. See the Command Speed section in chapter 1 for an explanation of wind additives.

Missed Approach Point

A Missed Approach Point (MAP) is a point where a missed approach must be initiated if suitable visual references are not available to make a safe landing or the airplane is not in a position to make a safe landing.

Determination of a MAP

For approaches such as ILS, the DA(H) in conjunction with the glide slope is used to determine the MAP. For non-ILS or G/S out approaches, two methods for determining the MAP are acceptable in lieu of timing due to the accuracy of FMC positioning:

- when arriving at the DA(H) or MDA(H) in conjunction with a VNAV path
- if not using a VNAV path, use of the map display to determine when the airplane has reached the VDP or the MAP. The approach legs along with distance and time to the missed approach waypoint are displayed on the map.

Timing During Approaches

Since FMC use is appropriate for instrument approach navigation, timing is not the primary means to determine the missed approach point. The probability of multiple failures that would result in timing being the only method of determining the missed approach point is remote. However, some regulatory agencies may still require the use of timing for approaches. The timing table, when included, shows the distance from the final approach fix to the MAP.

Timing for instrument approaches is not necessary as long as there is no unable RNP alert displayed.

Instrument Landing System

Arrival at the MAP is determined by reference to an altimeter. DA is determined by reference to the barometric altimeter, while DH is determined by reference to the radio altimeter.

Instrument Approach using VNAV

When specifically authorized by the appropriate regulatory authority, approaches may be flown to the following minima:

- a published VNAV DA(H)
- a published MDA(H) used as a decision altitude.

When either of the above minima are not specifically approved, and descent below the MDA(H) is not authorized, it is acceptable for the crew to use the published MDA(H) + 50 feet as the altitude to initiate the missed approach or decide to continue the approach to a landing. This technique is an acceptable means of complying with the MDA(H) during constant angle non-ILS approaches where a level off at MDA(H) is not planned.

Localizer

For most localizer approaches, the published MAP is the threshold of the runway. However, if a localizer approach is flown in VNAV PTH, use the missed approach criteria described in the Instrument Approach using VNAV section in this chapter.

Other Non-ILS Approaches

The MAP for all other non-ILS approaches is depicted on the approach chart. If the procedure has a final approach fix, the MAP may be short of the runway threshold, at the runway threshold, or located over a radio facility on the field. For on airport facilities (VOR or NDB) which do not have a final approach fix, the facility itself is the MAP and in most cases is beyond the runway threshold. Do not assume the airplane will always be in a position to make a normal landing when reaching the MDA(H) before reaching the MAP. When the MAP is at or beyond the runway threshold, the airplane must reach MDA(H) before arrival at the MAP if a normal final approach is to be made.

Precision Approach Radar

The MAP for a Precision Approach Radar (PAR) approach is the geographic point where the glide path intersects the DA(H). Arrival at the MAP is determined by the pilot using the altimeter or as observed by the radar controller, whichever occurs first.

Airport Surveillance Radar

During an Airport Surveillance Radar (ASR) approach, the radar controller is required to discontinue approach guidance when the airplane is at the MAP or one NM from the runway, whichever is greater. Perform the missed approach when instructed by the controller.

ILS Approach

The ILS approach flight pattern assumes all preparations for the approach such as review of approach procedure and setting of minima and radios are complete. It focuses on crew actions and avionic systems information. It also includes unique considerations during low weather minima operations. The flight pattern may be modified to suit local traffic and air traffic requirements.

Fail Operational

Fail operational refers to an AFDS capable of completing an ILS approach, autoland, and rollout following the failure of any single system component after passing alert height.

Fail Passive

Fail passive refers to an AFDS which in the event of a failure, causes no significant deviation of airplane flight path or attitude. A DA(H) is used as approach minimums.

ILS Approach - Fail Operational

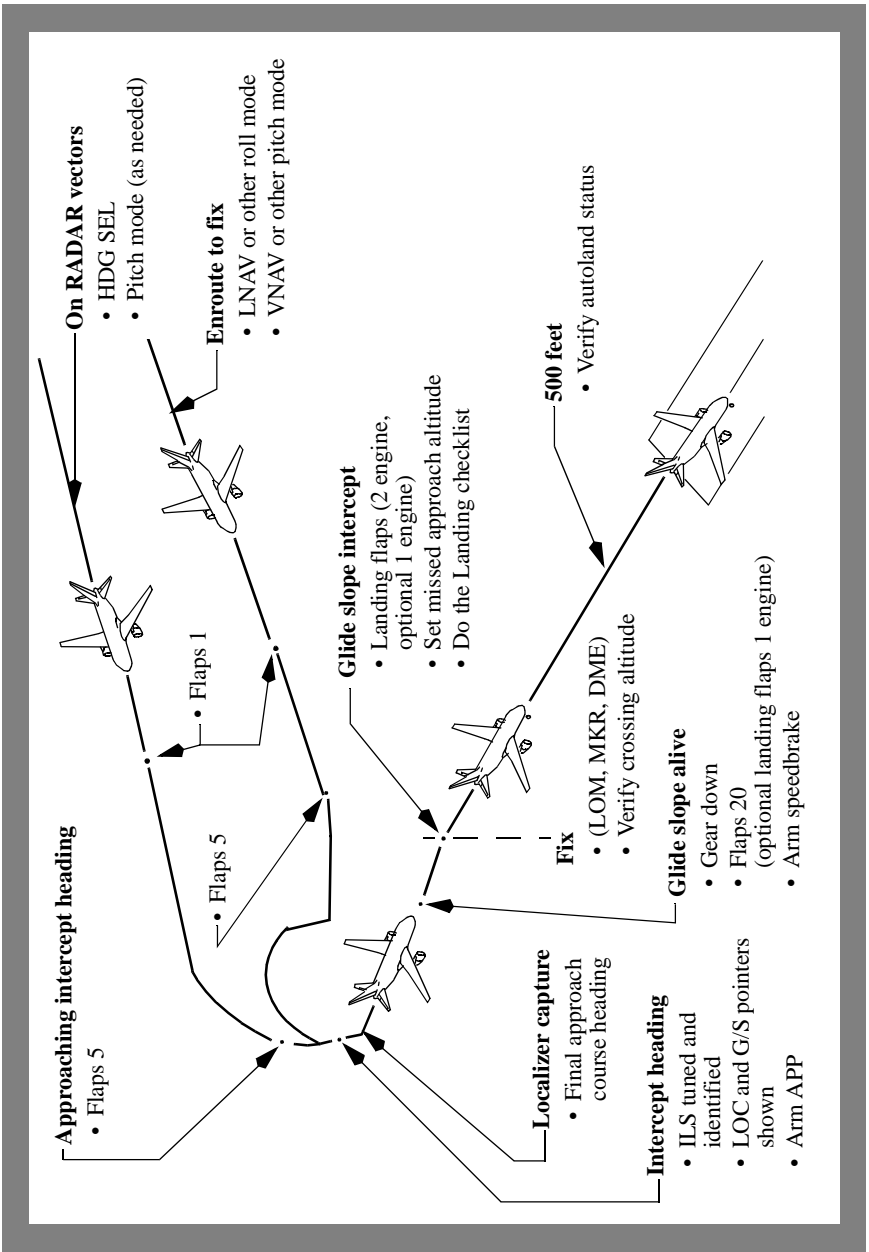

Decision Altitude or Height - DA(H)

A Decision Altitude or Height is a specified altitude or height in an ILS, GLS, PAR, or some approaches using a VNAV path or IAN where a missed approach must be initiated if the required visual reference to continue the approach has not been established. The “Altitude” value is typically measured by a barometric altimeter and is the determining factor for minima for Category I approaches, (e.g., ILS, GLS, or RNAV with VNAV). The “Height” value specified in parenthesis, typically a RA height above the touchdown zone (HAT), is advisory. The RA may not reflect actual height above terrain.

For most Category II and Category III fail passive approaches, the Decision Height is the controlling minima and the altitude value specified is advisory. A Decision Height is usually based on a specified radio altitude above the terrain on the final approach or touchdown zone.

Alert Height - AH

Alert heights are normally used for fail operational Category III operations. Alert height is a height above the runway, above which a Category III approach must be discontinued and a missed approach initiated if a specified failure occurs. For a discussion on specified failures, see the AFDS Faults section, this chapter. Radio altimeters are set in accordance with the airline's policy or at alert height to assist in monitoring autoland status. Most regulatory agencies do not require visual references below alert height.

Procedure Turn and Initial Approach

Cross the procedure turn fix at flaps 5 maneuvering airspeed. If a complete arrival procedure to the localizer and glide slope capture point has been selected via the CDU, the initial approach phase may be completed using LNAV and VNAV.

Approach

Both pilots should not be “heads-down” during the approach. In some cases, such as high density traffic, or when an arrival procedure is used only for reference, revising the FMS flight plan may not be appropriate. Displaying OFF PATH DESCENT circles on the map provides vertical flight path guidance which may assist in planning the approach.

If displaying the arrival procedure is not desired, perform a “DIRECT TO” or “INTERCEPT COURSE TO” the FAF, OM, or appropriate fix, to simplify the navigation display. This provides:

- a display of distance remaining to the FAF, OM, or appropriate fix
- a depiction of cross track error from the final approach course
- LNAV capability during the missed approach procedure.

777 Flight Crew Training Manual

The approach procedure may be flown using HDG SEL, TRK SEL, or LNAV for lateral tracking and VNAV, FLCH, V/S, or FPA for altitude changes. VNAV is the preferred descent mode when the FMS flight plan is programmed for the intended arrival. When VNAV is not available, FLCH is the preferred descent mode for altitude changes.

When maneuvering to intercept the localizer, decelerate and extend flaps to 5. Attempt to be at flaps 5 and flaps 5 maneuver speed before localizer capture.

When operating in speed intervention or the autothrottle SPD mode, timely speed selections minimize thrust lever movement during the approach. This reduces cabin noise levels and increases fuel efficiency. When flaps are extended, select the next lower speed just as the additional configuration drag takes effect.

Delaying the speed selection causes an increase in thrust, while selecting the lower speed too quickly causes thrust to decrease, then increase.

During the approach, adjust the map display and range to provide a scaled plan view of the area. When on an intercept heading and cleared for the approach, select the APP mode and observe the LOC and G/S mode annunciations are armed.

APP mode should not be selected until:

- the ILS is tuned and identified
- the airplane is on an inbound intercept heading
- both localizer and glide slope pointers appear on the attitude display in the proper position
- clearance for the approach has been received.

The glide slope may be captured before the localizer in some airplanes. The glide slope may be captured from either above or below. Glide slope capture does not occur if the intercept angle to the localizer is greater than 80°. The maximum intercept angle for the localizer is 120°. To avoid unwanted glide slope capture, LOC mode may be selected initially, followed by the APP mode.

When using LNAV to intercept the final approach course, ensure raw data indicates localizer interception to avoid descending on the glide slope with LOC not captured. If needed, use HDG SEL/TRK SEL or HDG HOLD/TRK HOLD to establish an intercept heading to the final approach course.

Final Approach

The pilots should monitor the quality of the approach, flare, landing and rollout, including speedbrake deployment and autobrake application.

At localizer capture, the heading bug automatically slews to the inbound course. For normal localizer intercept angles, very little overshoot occurs. Bank angles up to 30° may be commanded during the capture maneuver. For large intercept angles some overshoot can be expected.

Use the map display to maintain awareness of distance to go to the final approach fix. When the glide slope pointer begins to move (glide slope alive), extend the landing gear, select flaps 20, and decrease the speed to flaps 20 speed.

At glide slope capture, observe the flight mode annunciations for correct modes.

At this time, select landing flaps and VREF + 5 knots or VREF plus wind correction if landing manually, and do the Landing checklist. When using the autothrottle to touchdown, no additional wind correction is required to the final approach speed. The pilot monitoring should continue standard callouts during final approach and the pilot flying should acknowledge callouts.

When established on the glide slope, set the missed approach altitude in the altitude window of the MCP. Extension of landing flaps at speeds in excess of flaps 20 speed may cause flap load relief activation and large thrust changes.

Check for correct crossing altitude and begin timing, if required, when crossing the final approach fix (FAF or OM).

There have been incidents where airplanes have captured false glide slope signals and maintained continuous on glide slope indications as a result of an ILS ground transmitter erroneously left in the test mode. False glide slope signals can be detected by crosschecking the final approach fix crossing altitude and VNAV path information before glide slope capture. A normal pitch attitude and descent rate should also be indicated on final approach after glide slope capture. Further, if a glide slope anomaly is suspected, an abnormal altitude range-distance relationship may exist. This can be identified by crosschecking distance to the runway with altitude or crosschecking the airplane position with waypoints indicated on the navigation display. The altitude should be approximately 300 feet HAT per NM of distance to the runway for a 3° glide slope.

If a false glide slope capture is suspected, perform a missed approach if visual conditions cannot be maintained.

Below 1,500 feet radio altitude, the flare and rollout modes are armed. The autoland status annunciation should display LAND 3 or LAND 2. As the lowest weather minimums are directly related to the system status, both pilots must observe the autoland status annunciation.

If an autoland annunciation changes or system fault occurs above AH that requires higher weather minimums (reversion to LAND 2 or NO AUTOLAND), do not continue the approach below these higher minimums unless suitable visual reference with the runway environment is established.

777 Flight Crew Training Manual

Autopilots having fail operational capability are designed to safely continue an approach below AH after a single failure of an autopilot element. The autopilots protect against any probable system failure and safely land the airplane. AFDS design provides for an AH of at least 200 feet HAT but may be modified to a lower value by operators. The pilot should not interfere below AH unless it is clearly evident pilot action is required.

During an autoland with crosswind conditions, the runway alignment maneuver uses forward slip to reduce the crab angle of the airplane at touchdown. Alignment begins at 500 feet radio altitude or lower, depending on the strength of the crosswind. The amount of forward slip induced is limited to 5°. When a strong crosswind is present, the airplane does not fully align with the runway, but lands with a slight crab angle. In all cases, the upwind wing is low at touchdown.

The autopilot and autobrakes should remain engaged until a safe stop is assured and adequate visibility exists to control the airplane using visual references.

Intercepting Glide Slope from Above

The following technique may be used for ILS approaches, however it is not recommended for approaches using VNAV.

Normally the ILS profile is depicted with the airplane intercepting the glide slope from below in a level flight attitude. However, there are occasions when flight crews are cleared for an ILS approach when they are above the G/S. In this case, there should be an attempt to capture the G/S prior to the FAF. The map display can be used to maintain awareness of distance to go to the final approach fix. The use of autopilot is also recommended.

Note: Before intercepting the G/S from above, the flight crew must ensure that the localizer is captured before descending below the cleared altitude or the FAF altitude.

The following technique will help the crew intercept the G/S safely and establish stabilized approach criteria by 1,000 feet AFE:

- select APP on the MCP and verify that the G/S is armed
- establish final landing configuration and set the MCP altitude no lower than 1000 feet AFE
- select the V/S mode and set -1000 to -1500 fpm to achieve G/S capture and be stabilized for the approach by 1000 feet AFE. Use of the green altitude range arc may assist in establishing the correct rate of descent.

Monitor the rate of descent and airspeed to avoid exceeding flap placard speeds and flap load relief activation. At G/S capture observe the flight mode annunciations for correct modes and monitor G/S deviation. After G/S capture, continue with normal procedures. Comply with the recommendations on the use of speedbrakes found in chapter 4 of this manual.

Note: If the G/S is not captured or the approach not stabilized by 1000 feet AFE, initiate a go-around. Because of G/S capture criteria, the G/S should be captured and stabilized approach criteria should be established by 1000 feet AFE, even in VMC conditions. See the section titled Stabilized Approach Recommendations earlier in this chapter for more information on stabilized approach criteria.

Delayed Flap Approach (Noise Abatement)

If the approach is not being conducted in adverse conditions that would make it difficult to achieve a stabilized approach, the final flap selection may be delayed to conserve fuel or to accommodate speed requests by air traffic.

Intercept the glide slope with gear down and flaps 20 at flaps 20 speed. The thrust required to descend on the glide slope may be near idle. Approaching 1,000 feet AFE, select landing flaps, allow the speed to bleed off to the final approach speed, then adjust thrust to maintain it. Do the Landing checklist.

Note: For particularly noise sensitive areas, use the technique above but delay extending the landing gear until 1,500 feet AFE.

Decision Altitude or Height - DA(H)

The pilot monitoring should expand the instrument scan to include outside visual cues when approaching DA(H). Do not continue the approach below DA(H) unless the airplane is in a position from which a normal approach to the runway of intended landing can be made and suitable visual reference can be maintained. Upon arrival at DA(H), or any time thereafter, if any of the above requirements are not met, immediately execute the missed approach procedure. When visual contact with the runway is established, maintain the glide slope to the flare. Do not descend below the visual glide path.

Raw Data - (No Flight Director)

Raw data approaches are normally used during training to improve the instrument scanflow. If a raw data approach is required during normal operations, refer to the DDG or airline equivalent for the possibility of increased landing minima.

777 Flight Crew Training Manual

ILS deviation is displayed on the attitude display. ILS deviation may also be displayed on the ND by selecting APP mode on the EFIS Control Panel. The localizer course deviation scale on the attitude display remains normal scale during the approach and does not change to expanded scale at approximately 5/8 dot, as happens with F/D and/or autopilot engaged and localizer captured. Continue to crosscheck the map display against the attitude display raw data. Select VOR/ADF switches to display appropriate pointers on the ND.

The magnetic course/bearing information from the VOR/ADF pointers on the navigation display may be used to supplement the attitude display localizer deviation indication during initial course interception. Begin the turn to the inbound localizer heading at the first movement of the localizer pointer.

After course intercept, the track line and read-out on the navigation display may be used to assist in applying proper drift correction and maintaining desired course. Bank as needed to keep the localizer pointer centered and the track line over the course line. This method automatically corrects for wind drift with very little reference to actual heading required.

Large bank angles are rarely required while tracking inbound on the localizer. Use 5° to 10° of bank angle.

When the glide slope pointer begins to move (glide slope alive), lower the landing gear, extend flaps 20, and decelerate to flaps 20 speed. Intercepting the glide slope, extend landing flaps and establish the final approach speed. When established on the glide slope, preset the missed approach altitude in the altitude window. On final approach, maintain VREF + 5 knots or an appropriate correction for headwind component. Check altitude crossing the FAF. Begin timing, if required. To stabilize on the final approach speed as early as possible, it is necessary to exercise precise speed control during the glide slope intercept phase of the approach. The rate of descent varies with the glide slope angle and ground speed. Expeditious and smooth corrections should be made based on the ILS course and glide slope indications. Apply corrections at approximately the same rate and amount as the flight path deviations.

The missed approach procedure is the same as a normal missed approach. Flight Director guidance appears if TO/GA is selected. Refer to Go-Around and Missed Approach - All Approaches, this chapter.

AFDS Autoland Capabilities

Refer to the applicable AFM for AFDS limitations and a description of demonstrated autoland capabilities.

Note: For autoland use flaps 20 or 30.

Note: Autoland should not be attempted unless the final approach course path is aligned with the runway centerline. If the localizer beam is offset from the centerline the AFDS ROLLOUT mode may cause the airplane to depart the runway.

ILS Performance

Most ILS installations are subject to signal interference by either surface vehicles or aircraft. To prevent this interference, ILS critical areas are established near each localizer and glide slope antenna. In the United States, vehicle and aircraft operations in these critical areas are restricted any time the weather is reported less than 800 foot ceiling and/or visibility is less than 2 statute miles.

Flight inspections of ILS facilities do not necessarily include ILS beam performance inside the runway threshold or along the runway unless the ILS is used for Category II or III approaches. For this reason, the ILS beam quality may vary and autolands performed from a Category I approach at these facilities should be closely monitored.

Flight crews must remember that the ILS critical areas are usually not protected when the weather is above 800 foot ceiling and/or 2 statute miles visibility. As a result, ILS beam bends may occur because of vehicle or aircraft interference. Sudden and unexpected flight control movements may occur at a very low altitude or during the landing and rollout when the autopilot attempts to follow the beam bends. At ILS facilities where critical areas are not protected, be alert for this possibility and guard the flight controls (control wheel, rudder pedals and thrust levers) throughout automatic approaches and landings. Be prepared to disengage the autopilot and manually land or go-around.

The AFDS includes a monitor to detect significant ILS signal interference. If localizer or glide slope signal interference is detected by the monitor, the autopilot disregards erroneous ILS signals and remains engaged in an attitude stabilizing mode based on inertial data. Most ILS signal interferences last only a short time, in which case there is no annunciation to the flight crew other than erratic movement of the ILS raw data during the time the interference is present. No immediate crew action is required unless erratic or inappropriate autopilot activity is observed.

777 Flight Crew Training Manual

If the condition persists, it is annunciated on the PFD. If the autopilot is engaged, annunciations alert the flight crew that the autopilot is operating in a degraded mode and the airplane may no longer be tracking the localizer or glide slope. When the condition is no longer detected, the annunciations clear and the autopilot resumes using the ILS for guidance.

Autolands on Contaminated Runways

AFDS ROLLOUT mode performance cannot be assured when used on contaminated runways. The ROLLOUT mode relies on a combination of aerodynamic rudder control, nose wheel steering and main gear tracking to maintain the runway centerline using localizer signals for guidance. On a contaminated runway, nose wheel steering and main gear tracking effectiveness, and therefore airplane directional control capability, is reduced. To determine the maximum crosswind, use the most restrictive of the autoland crosswind limitation, or during low visibility approaches, the maximum crosswind authorized by the controlling regulatory agency. Consideration should also be given to the Landing Crosswind Guidelines published in chapter 6 of this manual or operator guidelines.

If an autoland is accomplished on a contaminated runway, the pilot must be prepared to disengage the autopilot and take over manually should ROLLOUT directional control become inadequate.

Low Visibility Approaches

A working knowledge of approach lighting systems and regulations as they apply to the required visual references is essential to safe and successful approaches. Touchdown RVR is normally controlling for Category I, II, and III approaches. For Category I and II approaches, mid and rollout RVR are normally advisory. For Category III operations mid and rollout RVR may be controlling. In some countries, visibility is used instead of RVR. Approval from the regulatory agency is required to use visibility rather than RVR.

During Category I approaches, visual reference requirements typically specify that either the approach lights or other aids be clearly visible to continue below DA(H). During Category I and II approaches, descent below 100 ft. above touchdown zone elevation may require (depending upon the criteria of the applicable regulatory authority) the red terminating bars or red side row bars (ALSF or Calvert lighting systems, or ICAO equivalent, as installed) to be distinctly visible. If actual touchdown RVR is at or above the RVR required for the approach, the runway environment (threshold, threshold lights and markings, touchdown zone, touchdown lights and markings) should become clearly visible resulting in a successful approach. After acquiring the red terminating bars or red side row bars, if the runway environment does not become distinctly visible execute an immediate missed approach.

Category III operations using fail passive autoland systems typically apply a DH of 50 ft. when approaching the threshold. In this instance, criteria requires that the runway environment be clearly visible. If not, execute an immediate missed approach.

Category III operations using fail operational autoland systems normally do not require specific visual references below AH.

A review of the approach and runway lighting systems available during the approach briefing is recommended as the pilot has only a few seconds to identify the lights required to continue the approach. For all low visibility approaches, a review of the airport diagram, expected runway exit, runway remaining lighting and expected taxi route during the approach briefing is recommended.

Regulatory agencies may require an additional 15% be added to the dry landing distance. Agencies may also require wind speed limitations less than maximum autoland wind speeds found in the FCOM.

AFDS System Configuration

Appendix A.2.6

System requirements described in this section do not include all of the systems and equipment required for each type of operation. Reference the applicable AFM or operating regulations for specific systems and equipment needed for Category II and Category III operations.

More detailed information concerning Category II and Category III operational requirements can be found in FAA advisory circulars or similar documents from other regulatory agencies.

Category II Operations

Category II approaches may be conducted using the autopilot or flight director only, with one or two engines.

Category III Operations

Category III operations are based on an approach to touchdown using the automatic landing system. Normal operations should not require pilot intervention. However, pilot intervention should be anticipated in the event inadequate airplane performance is suspected, or when an automatic landing cannot be safely accomplished in the touchdown zone. Guard the controls on approach through the landing roll and be prepared to take over manually, if required.

The airplane has been demonstrated to meet Category III criteria with two engines operating or with one engine operating for flaps 20 or flaps 30 landing.

AFDS Faults

Appendix A.2.6

Faults leading to non-normal operations can be divided into two categories:

- those occurring above AH
- those occurring at or below alert height.

Within these categories many non-normal situations or scenarios are possible. The flight deck is designed so that a quick analysis and decision can be made for virtually all non-normal or fault situations using the crew alerting system and autoland status annunciation.

If the flight crew is aware of the airplane equipment requirements for the approach, the following can be used for any AFDS fault indication:

Above Alert Height

Immediately after recognizing the fault from the crew alerting system, instrument flags, or engine indications, check autoland status annunciation.

- if the autoland status annunciation has not changed, and the equipment is not required for the approach or can be switched, (e.g., flight director), continue the approach
- if the autoland status annunciation has changed, or the equipment is required for the approach, adjust to the appropriate higher minimums or go-around. However, if suitable visual reference is established, consider landing.

At or Below Alert Height

For any EICAS alert, continue the approach to an automatic landing and rollout unless the alert is accompanied by a master caution. The pilot should not intervene unless it is clearly evident that pilot action is required.

A thorough fault analysis was included as a part of the fail operational certification. Below 200 feet AGL a safe landing and rollout can be made with any probable failure conditions.

Flight crew alerts (messages, lights, or aural) may occur at any time during the approach. Below alert height, multiple autopilots protect against any probable system failure and will safely land the airplane. The pilot should not intervene below AH unless it is evident that pilot action is required. If a fault affects the autobrakes, assume manual control of braking. Accomplish related procedures for system faults after rollout is complete and manual control of the airplane is resumed.

If the autopilot is unintentionally disengaged below alert height, the landing may be completed if suitable visual reference is established.

If a go-around is initiated with the autopilot disengaged, press the TO/GA switch. If the TO/GA switch is not pressed, the flight directors remain in the approach mode.

ILS Approach - Landing Geometry

The following diagrams use these conditions:

- data is based on typical landing weight
- airplane body attitudes are based on flaps 30, VREF 30 + 5 and should be reduced by 1° for each 5 knots above this speed
- pilot eye height is measured when the main gear is over the threshold
- airplane ILS antenna crosses threshold at 50 feet.

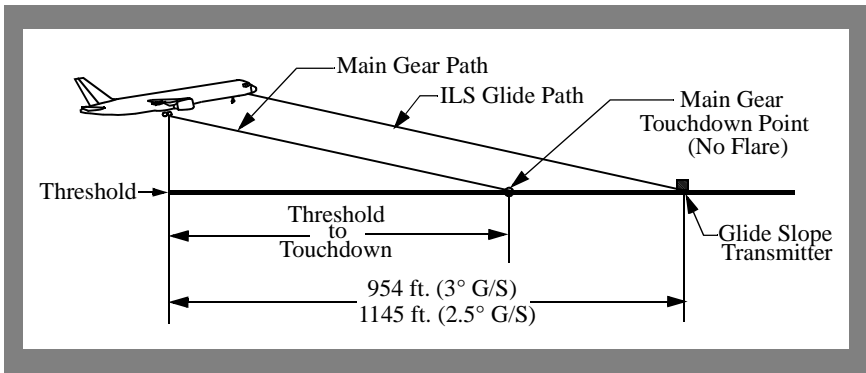

777 Model	Flaps 30		Main Gear over Threshold		Threshold to Main Gear Touchdown Point - No Flare (feet)
	Glide Path (degrees)	Airplane Body Attitude (degrees)	Pilot Eye Height (feet)	Main Gear Height (feet)	
- 200	2.5	2.4	58	30	681
	3.0	1.9	58	30	567
- 200LR	2.5	1.3	58	32	738
	3.0	0.9	57	32	611
- 300	2.5	1.9	58	29	669
	3.0	1.4	57	29	557
- 300ER	2.5	2.2	58	29	674
	3.0	1.7	58	29	561

Non-Normal Operations

This section describes pilot techniques associated with engine inoperative approaches. Techniques discussed minimize workload, improve crew coordination, and enhance flight safety. However, a thorough review of applicable Non-Normal Checklists associated with engine inoperative flight is a prerequisite to understanding this section.

One Engine Inoperative

AFDS management and associated procedures are the same as for the normal ILS approach. Flight director (manual) or autopilot and/or autothrottle may be used. Weather minima for an ILS with one engine inoperative are specified in the applicable AFM and/or the operator's Operational Specification or equivalent.

For a discussion about how yaw is controlled during an approach with one engine inoperative, refer to the section titled Engine Inoperative, Rudder Trim - All Instrument Approaches later in this chapter.

Refer to the Performance Inflight chapter of the QRH to determine if a flaps 30 landing is permissible. Intercept the localizer with flaps 5 at flaps 5 speed. When the glide slope is alive, lower the landing gear and extend flaps to 20. If a flaps 20 landing will be made, set final approach speed and decelerate. If a flaps 30 landing will be made, at glide slope capture, select landing flaps, set final approach speed, and decelerate.

Be prepared to take over manually in the event system performance is not satisfactory.

Additional engine-out logic is incorporated during runway alignment to ensure the downwind wing is not low at touchdown. If the crosswind is from the same side as the failed engine, then the airplane is crabbed by inducing a sideslip. This assures a "wings-level" approach. For moderate or strong crosswinds from the opposite side of the failed engine, no sideslip is induced as the failed engine high approach configuration guarantees an upwind wing low touchdown characteristic.

Engine Inoperative, Rudder Trim - All Instrument Approaches

During a multiple autopilot approach, the TAC automatically applies rudder inputs to control yaw until LAND 3 or LAND 2 annunciates. If the TAC is inoperative, the pilot must use rudder pedal pressure to control yaw, followed by rudder trim to maintain an in-trim condition until LAND 3 or LAND 2 annunciates. When LAND 3 or LAND 2 annunciates, regardless of the status of the TAC, rudder inputs are controlled by the autopilots. Directional control (yaw) is not affected by rudder trim with the autopilot in the LOC or ROLLOUT modes.

When the TAC is inoperative, the pilot must use rudder pedal pressure to control yaw, followed by rudder trim to maintain an in-trim condition until LAND 3 or LAND 2 annunciates. Rudder trim may be set to zero to facilitate directional control during thrust reduction. This should be accomplished by 500 feet AFE to allow the PM ample time to perform other duties and make appropriate altitude callouts.

When the TAC is inoperative, manually centering the rudder trim before landing allows most of the rudder pedal pressure to be removed when the thrust of the operating engine is retarded to idle at touchdown. Full rudder authority and rudder pedal steering capability are not affected by rudder trim.

If TAC is inoperative, it may not be advisable to manually center the rudder trim due to crew workload and the possibility of a missed approach. However, if touchdown occurs with the rudder still trimmed for the approach, be prepared for the higher rudder pedal forces required to track the centerline on rollout.

Engine Failure On Final Approach

If an engine failure should occur on final approach with the flaps in the landing position, adequate thrust is available to maintain the approach profile using landing flaps, if desired.

A landing using flaps 25 or 30 might be preferable in some circumstances, especially if the failure occurs on short final or landing on runways where stopping distance is critical.

The ability to continue the approach with an engine failure on final approach when Category III minima are necessary may also be a factor. If the approach is continued at flaps 20 or 30, increase the thrust to maintain the appropriate speed or ensure autothrottle operation is satisfactory.

If a go-around is required, follow the Go-Around and Missed Approach procedures for one engine inoperative, retracting the flaps to 20. Adequate performance is available at flaps 20. Subsequent flap retraction should be made at a safe altitude in level flight or a shallow climb.

777-200, 777-300

It is usually preferable to continue the approach using flaps 25 or 30. At weights near the landing climb capability limit it may be preferable to continue the approach using flaps 20. This provides a better thrust margin, less thrust asymmetry and improved go-around capability. If the decision is made to reduce the flap setting, thrust should be increased at the same time as the flap selection. Command speed should be increased to 15 knots over the previously set flaps 25 or 30 final approach speed. This sets a command speed that is equal to at least VREF for flaps 20 + 5 knots.

777 Flight Crew Training Manual

777-200LR, 777-300ER

It is usually preferable to continue the approach using flaps 25 or 30. At weights near the landing climb capability limit it may be preferable to continue the approach using flaps 20. This provides a better thrust margin, less thrust asymmetry and improved go-around capability. If the decision is made to reduce the flap setting, thrust should be increased at the same time as the flap selection. Command speed should be increased to 20 knots over the previously set flaps 25 or 30 final approach speed. This sets a command speed that is equal to at least VREF for flaps 20 + 5 knots.

If a go-around is required with flaps set at 20, maintain the additional 15 knots, select flaps 5 and continue the usual engine inoperative go-around. The decision to continue the approach at normal landing flaps, to retract the flaps to 20 or execute a go-around is a decision that should be made immediately.

Non - ILS Instrument Approaches

Non-ILS approaches are defined as:

- RNAV approach - an instrument approach procedure that relies on airplane area navigation equipment for navigational guidance. The FMS on Boeing airplanes is FAA-certified RNAV equipment that provides lateral and vertical guidance referenced from an FMS position. The FMS uses multiple sensors (as installed) for position updating to include GPS, DME-DME, VOR-DME, LOC-GPS, and IRS.
- GPS approach - an approach designed for use by airplanes using stand-alone GPS receivers as the primary means of navigation guidance. However, Boeing airplanes using FMS as the primary means of navigational guidance, have been approved by the FAA to fly GPS approaches provided an RNP of 0.3 or smaller is used.

Note: A manual FMC entry of 0.3 RNP is required if not automatically provided.

- VOR approach
- NDB approach
- LOC, LOC-BC, LDA, SDF, IGS, TACAN, or similar approaches.

Non-ILS approaches are normally flown using VNAV, V/S, or FPA pitch modes. Recommended roll modes are provided in the applicable FCOM procedure.

Non - ILS Instrument Approaches - General

Over the past several decades there have been a number of CFIT and unstabilized approach incidents and accidents associated with non-ILS approaches and landings. Many of these could have been prevented by the use of Continuous Descent Final Approach (CDFA) methods. Traditional methods of flying non-ILS approaches involve setting a vertical speed on final approach, leveling off at step-down altitudes (if applicable) and at MDA(H), followed by a transition to a visual final approach segment and landing. These traditional methods involve changing the flight path at low altitudes and are not similar to methods for flying ILS approaches. Further, these traditional methods often require of the crew a higher level of skill, judgment and training than the typical ILS approach.

The following sections describe methods for flying non-ILS CDFA. These methods provide a constant angle approach, which reduces exposure to crew error and CFIT accidents. These methods also make it much easier for the crew to achieve a stabilized approach to a landing once suitable visual reference to the runway environment has been established.

777 Flight Crew Training Manual

A typical Instrument Approach using VNAV, V/S, or FPA as illustrated, assumes all preparations for the approach; such as review of the approach procedure and setting of minima and radio tuning have been completed. The procedures illustrated focus generally on crew actions and avionics systems information. The flight pattern may be modified to suit local traffic and air traffic requirements.

The following discussions assume a straight-in instrument approach is being flown. A circling approach may be flown following an instrument approach using VNAV, V/S or FPA provided the MCP altitude is set in accordance with the circling approach procedure.

Types of Approaches

VNAV is the preferred method for accomplishing non-ILS approaches that have an appropriate vertical path defined on the FMC LEGS page. The section on Use of VNAV provides several methods for obtaining an appropriate path, to include published glide paths, and where necessary, a pilot constructed path. V/S or FPA may be used as an alternate method for accomplishing non-ILS approaches.

Use of the Autopilot during Approaches

Automatic flight is the preferred method of flying non-ILS approaches. Automatic flight minimizes flight crew workload and facilitates monitoring the procedure and flight path. During non-ILS approaches, autopilot use allows better course and vertical path tracking accuracy, reduces the probability of inadvertent deviations below path, and is therefore recommended until suitable visual reference is established on final approach.

Manually flying non-ILS approaches in IMC conditions increases workload and does not take advantage of the significant increases in efficiency and protection provided by the automatic systems. However, to maintain flight crew proficiency, pilots may elect to use the flight director without the autopilot when in VMC conditions.

Note: Currently, the VNAV PTH mode contains no path deviation alerting. For this reason, the autopilot should remain engaged until suitable visual reference has been established.

Raw Data Monitoring Requirements

During localizer-based approaches; LOC, LOC-BC, LDA, SDF, and IGS, applicable raw data must be monitored throughout the approach.

During non-localizer based approaches where the FMC is used for course or path tracking (VOR, TACAN, NDB, RNAV, GPS etc.), monitoring raw data is recommended, if available. Although continuous monitoring of raw data during approaches is not required, ground based navigation aid(s) should be checked for correct navigation no later than final approach.

During single FMC, or single DME or single GPS operation, in the event the single operational FMC, DME, or GPS fails during the FMC approach, there must be a non-FMC means of navigation available for a missed approach such as VOR/NDB raw data and/or radar, and there must be a non - FMC approach available. Failure of the remaining single DME need not be considered if GPS updating is being used.

Checking raw data for correct navigation before commencing the approach may be accomplished by:

- pushing the POS switch on the EFIS control panel and comparing the displayed raw data with the navaid symbols on the map. Example: The VOR radials and raw DME data should overlay the VOR/DME stations shown on the MAP and the GPS position symbol should nearly coincide with the tip of the airplane symbol (FMC position)
- displaying the VOR and/or ADF pointers on the map display and using them to verify your position relative to the map display.

Typical Navigation Display

The following diagram represents a typical navigation display with the POS display selected.

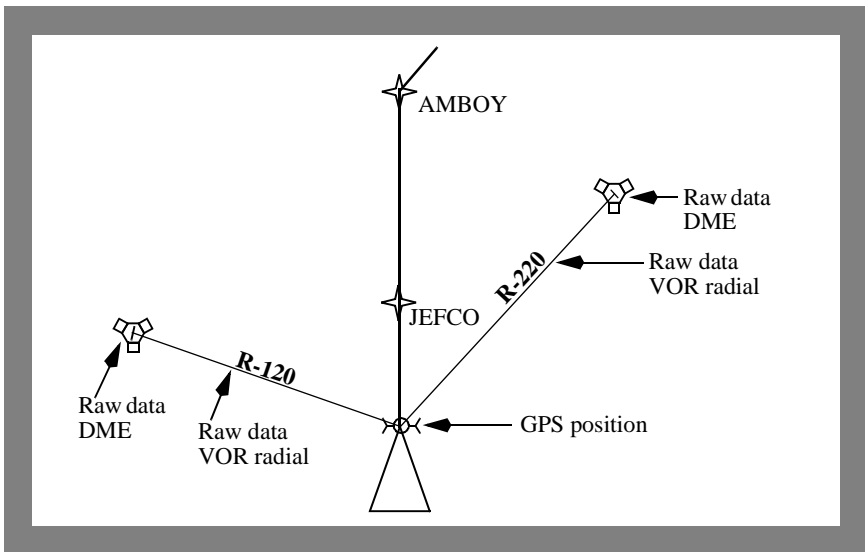

MAP Displays and Raw Data

The map mode should be used to the maximum extent practicable. The map display provides a plan view of the approach, including final approach and missed approach routing. The map increases crew awareness of progress and position during the approach.

777 Flight Crew Training Manual

The map is particularly useful when the inbound course does not align with runway centerline and allows the pilot to clearly determine the type of alignment maneuver required. The map can be used to integrate weather radar returns, terrain or traffic information within the approach path and airport area.

The preferred method for VOR or localizer tuning and final approach course selection is procedure tuning. This can be confirmed by observing the displayed frequency, identifier and course on the PFD or ND. The VOR automatically tunes for a VOR approach after passing the first waypoint on the approach procedure. Automatic procedure tuning also reduces crew workload in the terminal area by automatically tuning the missed approach VOR if a different one is required and aids the crew by reducing heads down time when last minute approach and/or runway changes are required. If required, the appropriate frequency and course may be preselected on the navigation radio page for display at the appropriate time. For localizer or localizer back course approaches, always use the front course.

Note: When appropriate, compare airplane position on the map with ILS, VOR, DME, and ADF systems to detect possible map shift errors. Use of the POS function selectable on the EFIS control panel is the recommended method for making this comparison. The VOR and ADF pointers should be displayed on the map.

RNAV Approaches

RNAV approaches may be flown provided the RNP being used is equal to or less than the RNP specified for the approach and is consistent with the AFM demonstrated RNP capability.

Approach Requirements Relating to RNP

With appropriate operational approval, approaches requiring RNP alerting may be conducted in accordance with the following provisions:

- AFM indicates that the airplane has been demonstrated for selected RNP
- at least one GPS or one DME is operational
- any additional GPS or DME requirements specified by Operations Specification or by the selected terminal area procedure must be satisfied
- when operating with the following RNP values, or smaller:

Approach Type	RNP
NDB, NDB/DME	0.6 NM
VOR, VOR/DME	0.5 NM
RNAV	0.5 NM
RNAV (GPS)/(GNSS)	0.3 NM

- no NAV UNABLE RNP alert is displayed during the approach.

Use of LNAV

To use LNAV for approaches and missed approaches, a proper series of legs/waypoints that describe the approach route (and missed approach) must appear on the LEGS page. There are two methods of loading these waypoints:

- Database Selection
 - This method is required for RNAV and GPS approaches. An approach procedure selected through the FMC arrivals page provides the simplest method of selecting proper waypoints. Procedures in the database comply with obstruction clearance criteria for non-ILS approaches.
 - No waypoints may be added or deleted between the FAF and the MAP. If the approach to be flown is not in the database, another approach having the same plan view may be selected. For example, an ILS procedure might be selected if the plan view (route) is identical to an NDB approach. In this case, waypoint altitudes must be checked and modified as required. When an approach is flown by this "overlay" method, raw data should be monitored throughout the approach to assure obstacle clearance.

Note: If an NDB approach for the desired runway is in the database, an overlay approach should not be used.

- If a waypoint is added to or deleted from a database procedure, FMC "on approach" logic (as described in the FCOM) is partially or completely disabled and the VNAV obstacle clearance integrity of the procedure may be adversely affected. If an additional waypoint reference is desired, use the FIX page and do not modify waypoints on the LEGS page.
- Manual Waypoint Entry
 - Due to potentially inadequate terrain clearance, manual waypoint entry should not be accomplished for RNAV or GPS approaches, nor should this method be used with VNAV after the FAF.
 - When no procedure is available from the FMC arrivals page, manual entry of a series of waypoints may be accomplished to define the approach routing. The waypoints may be conveniently defined by using names of waypoints or nav aids in the database, bearing/distance from such fixes, intersections of radials or latitude/longitude information.

777 Flight Crew Training Manual

- Procedure turns and DME arcs cannot usually be manually entered (unless they can be defined by a series of waypoints). Deviation from the defined route may require use of “DIRECT TO” or “INTERCEPT COURSE TO” when intercepting the inbound course. Constant monitoring of raw data during the approach is required.

Note: Procedure turns and DME arcs may require use of HDG SEL/TRK SEL.

LNAV cannot be used to track fix or radial data displayed on the map that is not part of the active route. A navaid/waypoint and the appropriate radial may be inserted on the FIX page to create a “course” line on the map that helps to improve situational awareness. A similar display may be created by manually tuning an appropriate VOR and selecting the desired course. These methods provide reference information on the map display only. They are not reflected on the LEGS page and cannot be tracked with LNAV. These methods should only be used when there is no opportunity to use an approach selected from the navigation database and should therefore be considered only when normal means of displaying approaches are not available. Pilots should be aware that the displayed course is an FMC calculated course and is not raw data information.

Note: HDG SEL or TRK SEL should be used to fly the approach ground track.

Note: Automatic procedure tuning is not available with manually entered waypoints.

If the approach is not available in the navigation database, select the landing runway from the FMC arrivals page. The runway and associated extended centerline then displays on the map to aid in maintaining position awareness.

Pilots should not become involved in excessive “heads down” FMC manipulation to build map displays while at low altitude. Raw data VOR, ILS, and ADF displays should be used to avoid distractions during higher workload phases of flight. Map building should be avoided below 10,000 feet AGL.

Use of VNAV

Approaches using VNAV may be accomplished using any of the recommended roll modes provided in the FCOM procedure.

A vertical path suitable for use of VNAV is one that approximates 3° and crosses the runway threshold at approximately 50 feet. To obtain such a VNAV path, maximum use of the navigation database is recommended. For approaches where an RNP is specified, or approaches where a DA(H) is used, the waypoints in the navigation database from the FAF onward may not be modified except to add a cold temperature correction, when appropriate, to the waypoint altitude constraints. With respect to the construction of a suitable final approach path, there are two types of approaches in the navigation database:

- approaches with a glide path (GP) angle displayed on the final approach segment of the LEGS page. The final approach segment is completely compatible with VNAV and complies with final approach step-down altitudes (minimum altitude constraints).
- approaches where no GP angle is published and where the approach end of the runway is defined by a runway waypoint (RWxx) or a missed approach point fix (MXxx or a named waypoint) exists. Normally these waypoints display an approximate 50 foot threshold crossing altitude constraint and may be used “as is” for VNAV. If the RWxx waypoint altitude constraint does not coincide with approximately 50 feet, this waypoint may be modified with a threshold crossing altitude of approximately 50 feet.

Note: Threshold crossing altitude normally requires entry of a four-digit number. Example: enter 80 feet as 0080.

- VNAV may be used for approaches modified in this way; however, the approach should be flown by constant reference to raw data (VOR, NDB, DME, etc.) and compliance with each minimum altitude constraint is required. Use of a DA(H) is not recommended when the final approach is manually constructed in this manner.
- ILS approaches coded with the appropriate threshold crossing height may be used as an overlay for other approaches such as LOC or NDB.

VNAV should be used only for approaches that have one of the following features:

- a published GP angle on the LEGS page for the final approach segment
- an RWxx waypoint coincident with the approach end of the runway
- a missed approach waypoint before the approach end of the runway, (e.g., MXxx).

These features permit construction of a normal glide path. VOR approaches with the missed approach point on the LEGS page beyond the runway threshold and circling only approaches do not have these features.

With the autopilot engaged, the EICAS alert message AUTOPILOT and VNAV mode fail indications are available to alert the flight crew of potential problems with the flight path.

777 Flight Crew Training Manual

When appropriate, make cold temperature altitude corrections by applying a correction from an approved table to the waypoint altitude constraints. The FMC obtains the GP angle displayed on the LEGS page from the navigation database. This GP angle is based on the standard atmosphere and is used by the FMC to calculate the VNAV path which is flown using a barometric reference. When OAT is lower than standard, true altitudes are lower than indicated altitudes. Therefore, if cold temperature altitude corrections are not made, the effective GP angle is lower than the value displayed on the LEGS page. When cold temperature altitude corrections are made, VNAV PTH operation and procedure tuning function normally; however, the airplane follows the higher of the glide path angle associated with the approach (if available) or the geometric path defined by the waypoint altitude constraints.

When on final approach, VNAV should be used with speed intervention active to reduce workload. Adding speed constraints to the final approach waypoints is normally not needed and causes extra workload without providing any safety benefit. This also reduces the ability to make last minute approach changes. However, if needed speed constraints may be changed if the default value is not suitable.

To prevent unnecessary level offs while descending in VNAV before the final approach, reset the MCP altitude selector to the next lower constraint before altitude capture, when compliance with the altitude restriction is assured.

Use of Altitude Intervention during Approaches using VNAV

Altitude intervention is appropriate during approaches only if the AFDS enters VNAV ALT mode above the approach path and descent must be continued. Entering VNAV ALT mode can occur if passing a waypoint on the approach and the crew has failed to reset the MCP altitude to a lower altitude. If this occurs, set the MCP altitude to the next lower altitude constraint or the DA(H) or MDA(H), as appropriate, and select altitude intervention. When VNAV altitude intervention is selected, VNAV path deviation indications on the map display disappear momentarily while the path is recalculated, but should reappear.

If altitude intervention is selected when on-approach logic is active, typically after the airplane has sequenced the first approach waypoint, level flight is commanded until reaching the VNAV path, then the airplane captures the VNAV path.

Note: When a PROC HOLD is active, VNAV altitude intervention functions normally by causing the next waypoint altitude constraint to be deleted and a descent to be initiated.

When using VNAV PTH or VNAV SPD, the selection of altitude intervention will:

- delete the next climb or descent waypoint altitude constraint if the MCP altitude is beyond the next altitude constraint
- prior to BP05, delete approach altitude constraints if the MCP altitude is beyond the next altitude constraint.

When using VNAV ALT, selection of altitude intervention:

- may delete down path altitude constraints if the altitude constraint is within 150 feet of the current airplane altitude
- does not effect other altitude constraints.

Note: With FMC BP05 and later, approach waypoint altitude constraints are not deleted by the use of the MCP altitude intervention function.

Non - ILS Approach - One Engine Inoperative

Maneuvering before and after the final approach fix with one engine inoperative is the same as for an all engine non-ILS approach.

Procedure Turn and Initial Approach

Cross the procedure turn fix at flaps 5 and flaps 5 maneuvering airspeed. If a complete arrival procedure has been selected via the CDU, the initial approach phase may be completed using LNAV and VNAV path, or other appropriate modes.

Vertical Path Construction

This section describes typical final approach vertical profile (path) construction criteria as they relate to flying instrument approaches using VNAV. This information may also be useful to pilots who wish to fly the vertical path using V/S or FPA.

Where there is a glide path (GP) angle coded in the navigation database, the FMC builds the descent path upward and back in the direction of the FAF by starting at the location of the missed approach waypoint (MAP) and its associated altitude constraint. The FMC calculates this path using the coded GP angle, also called the vertical angle. The MAP is normally shown on the LEGS page as a RWxx or MXxx waypoint. In some cases a named waypoint is used as the MAP. A GP angle is coded in the navigation database for nearly all straight-in approach procedures.

This GP angle is normally defined by the regulatory authority responsible for the approach procedure and provides a continuous descent at a constant flight path angle for a final approach path that complies with minimum altitudes at intermediate step-down fixes. The typical GP angle is approximately 3.00°, but can vary from 2.75° to 3.77°.

777 Flight Crew Training Manual

The projection of the vertical path upward and back toward the FAF along this coded GP angle stops at the next higher limiting altitude in the vertical profile. This limiting altitude is the more restrictive of the following:

- the “At” altitude on the constrained waypoint preceding the MAP
- the crossing altitude on the next “at or above” constrained waypoint preceding the MAP
- the speed transition or the speed restriction altitude, whichever is lower
- cruise altitude.

The following examples show typical VNAV final approach paths where there is a GP angle in the navigation database. The first example shows an RW_{xx} missed approach waypoint. The second example below shows the VNAV final approach path where there is a missed approach waypoint before the runway. Note that in the second case the projected path crosses the runway threshold at approximately 50 feet. VNAV guidance is level flight, however, when the airplane passes the missed approach point. Both examples are for “At” altitude constraints at the FAF.

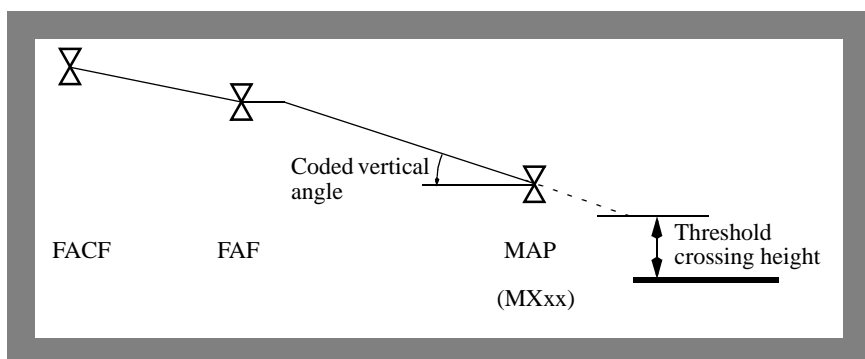
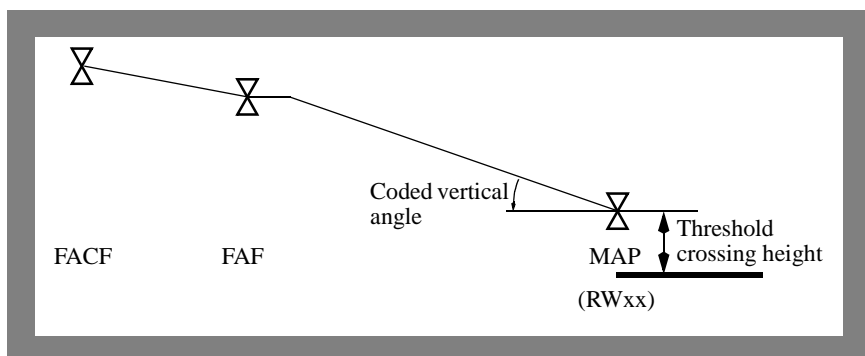

Note: The final approach course fix (FACF) is typically located on the final approach course approximately 7 NM before the FAF. The FAF referred to in the following procedures refers to the charted FAF and is intended to mean the point at which the final approach descent is begun.

For the non-ILS approach procedures with an “At” constraint altitude at the FAF, a short, level segment between the FAF and the final glide path (also called a “fly-off”) may result. For the ILS procedure, the constraint altitude at the FAF is computed to be the crossing altitude of the glide slope.

For procedures where both the FAF and FACF are coded with “at or above” altitude constraints, the crew should consider revising the FACF altitude constraint to “at” (hard constraint). This enables a shallower path before the FAF, permitting a normal deceleration for flap and gear extension. Example: In the diagram above, if both the FACF and the FAF contain “xxx/4000A” waypoint constraints, the crew should change “4000A” to “4000” at the FACF to modify the path for a more normal deceleration.

Crews can expect to see several other variations of approach path construction:

- approaches where the FAF has an “at or above” waypoint altitude constraint. The GP angle normally terminates at the FACF altitude constraint or the cruise altitude, whichever is lower. When this type of path is flown, the airplane passes above the FAF
- where there is more than one GP angle, such as for ILS approaches, the airplane uses the GP angle for the active leg to define the VNAV approach path. These types of paths are shown on the LEGS page as having two GP angle values, one approaching the FAF, the second approaching the runway (missed approach point).

Note: The coded GP angle is steeper than normal in temperatures warmer than ISA standard and is shallower than normal in temperatures colder than ISA standard.

Note: ILS approaches with step-down fixes, flown as G/S OUT, may have a vertical angle that does not satisfy the published minimum altitudes. This means use of VNAV PTH may result in small deviations below minimum step-down altitudes, and therefore the use of VNAV PTH is not recommended. Published localizer (LOC) only approaches are compatible with VNAV PTH.

Instrument Approach Using VNAV

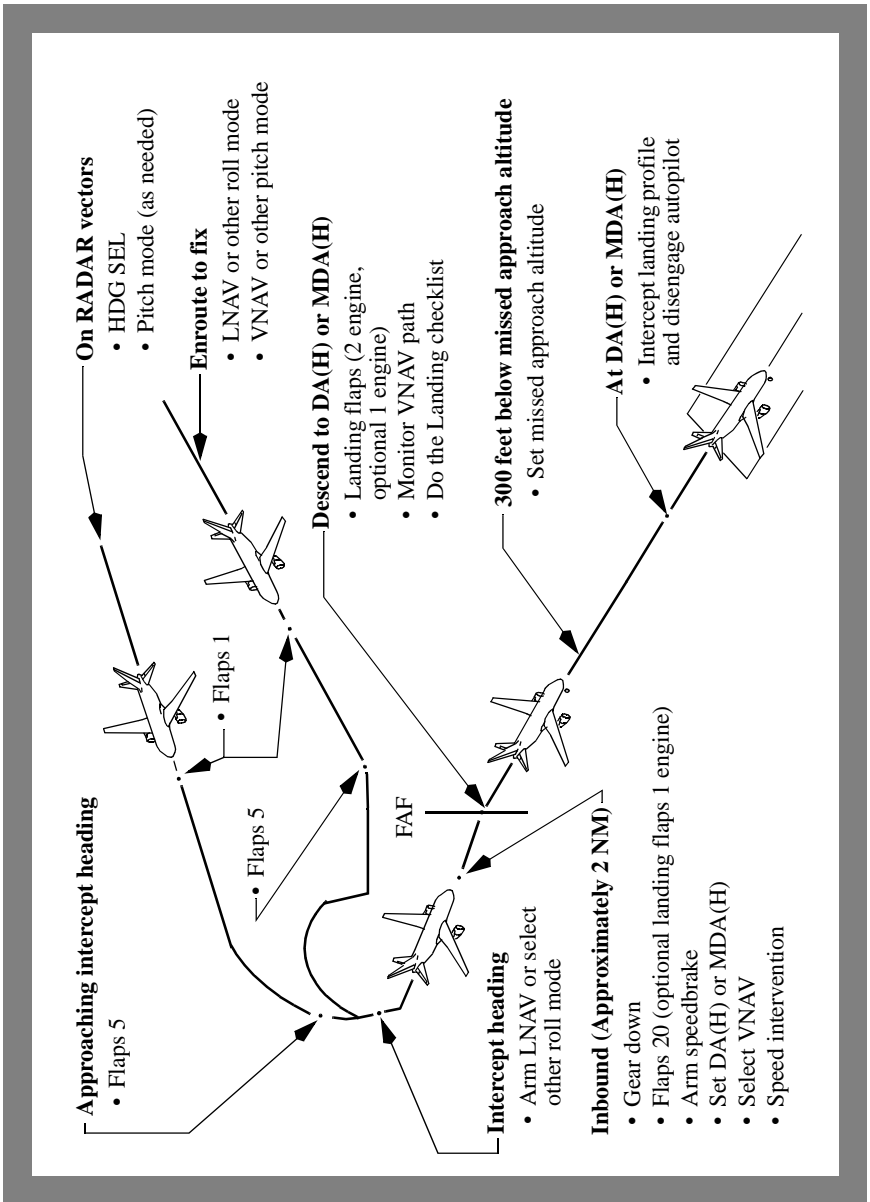

Approach Preparations for using VNAV

Select the approach procedure from the arrivals page of the FMC. Tune and identify appropriate navaids. Do not manually build the approach or add waypoints to the procedure. If additional waypoint references are desired, use the FIX page. To enable proper LNAV waypoint sequencing, select a straight-in intercept course to the FAF when being radar vectored to final approach. Verify/enter the appropriate RNP and set the DA(H) or MDA(H) using the baro minimums selector. If required to use MDA(H) for the approach minimum altitude, the barometric minimums selector should be set at MDA + 50 feet to ensure that if a missed approach is initiated, descent below the MDA(H) does not occur during the missed approach.

Note: The approach RNP value is determined from one of three sources: manual entry by the flight crew, FMC default, or the navigation database. A manual entry overrides all others. If the navigation database contains an RNP value for the final approach leg, the RNP will appear when the leg becomes active, or up to 30 NM prior if the previous leg does not have an associated RNP value. The FMC default approach RNP will appear (no manual entry or navigation database value) when passing the approach waypoint, including approach transitions, or when below 2,000 feet above the destination airport.

Transition to an Instrument Approach using VNAV

There are several techniques which help ensure a smooth descent transition to a non-ILS final approach where VNAV PTH will be used.

Note: The FAF is normally the waypoint shown on the LEGS page and map display just before the final approach segment. The following discussions assume the FAF altitude constraint is set in the MCP while descending toward the FAF.

If descending to FAF altitude in FLCH, V/S or FPA, or if in ALT at the FAF altitude, set DA(H) or MDA(H) in the MCP, engage VNAV and speed intervention when approximately 2 NM before the FAF. The airplane will descend on final approach in VNAV PTH.

If descending in VNAV PTH before final approach and the situation permits a continuous descent through final approach, remain in VNAV PTH while configuring the airplane for approach and landing. The airplane slows automatically to the FAF speed constraint. Reset the MCP to DA(H) or MDA(H) approximately 2 NM before the FAF (waypoint just before the final approach segment) to prevent level off, and select speed intervention.

777 Flight Crew Training Manual

If descending in VNAV SPD, the AFDS changes to VNAV PTH automatically when approaching the FAF if the airplane is on or below the path. When the flaps are extended to position 1 or greater and the airplane is below the path, VNAV PTH engages and the airplane levels off and remains level until intercepting the approach path. If above the path, the airplane continues to descend and capture the approach path from above. If immediate descent to FAF altitude constraint is required and the airplane has leveled off in VNAV PTH, select FLCH, descend to the FAF altitude, set DA(H) or MDA(H) in the MCP, then re-select VNAV and speed intervention. Reset the MCP to the DA(H) or MDA(H) approximately 2 NM before the FAF. If VNAV ALT has engaged beyond the FAF, set DA(H) or MDA(H) in the MCP and select altitude intervention without delay to enable continued descent on the final approach path. Execute a missed approach if the deviation above path becomes excessive enough to prevent achieving a stabilized approach.

Prior to final approach, the MCP altitude should be set at the appropriate altitude constraint (normally that for the next waypoint) to assure compliance with approach minimum altitudes while descending on the approach. To avoid leveling off, reset the MCP to the following waypoint altitude constraint as soon as the next waypoint altitude constraint is assured. However, if compliance with an altitude constraint is in question, consider leveling off or reducing the rate of descent to ensure a safe path.

Final Approach using VNAV

Approaching intercept heading, select flaps 5 and ensure LNAV or other appropriate roll mode is armed or engaged. Approaching the FAF (approximately 2 NM), select gear down and flaps 20 and adjust speed. Set the DA(H) or MDA(H) in the MCP altitude window, select VNAV, and ensure VNAV PTH and appropriate roll mode is annunciated. Use VNAV speed intervention to control speed.

When using LNAV to intercept the final approach course, shallow intercept angles or intercept angles that result in an overshoot may result in delayed capture of the final approach course. The FAF should not be crossed and descent should not begin if the airplane is not on the final approach course.

Note: For approach procedures where the vertical angle (“GP” angle shown on the LEGS page) begins earlier in the approach (prior to the FAF), the MCP may be set to the DA(H) or MDA(H) once established on the vertical angle.

When initiating descent on the final approach path, select landing flaps, slow to final approach speed and do the Landing checklist. If the charted FAF is too close to the runway to permit a stabilized approach, consider establishing final approach pitch mode and configuring for approach and landing earlier than specified in the FCOM procedure.

With the MCP altitude set to DA(H) or MDA(H) and the airplane stabilized on the final approach path, the map altitude range arc assists in determining the visual descent point (VDP). As soon as the airplane is at least 300 feet below the missed approach altitude and stabilized on final approach in VNAV PTH, set the MCP altitude to the missed approach altitude. VNAV path deviation indications on the map display assist in monitoring the vertical profile. The autopilot tracks the path in VNAV PTH resulting in arrival at, or near, the visual descent point by the DA(H) or MDA(H).

On the VNAV approach, the missed approach altitude is set after established on the final descent and more than 300 feet below the missed approach altitude. Some approaches have missed approach altitudes that are lower than the altitude at which the FAF is crossed. The flight crew must wait until the airplane is at least 300 feet below the missed approach altitude before setting the missed approach altitude in the MCP to avoid level off from occurring during the final approach descent.

MCP Altitude Setting during Approach using VNAV

For approaches using VNAV PTH, where there is a published GP angle, the MCP may be set according to Landing Procedure - Instrument Approach using VNAV found in Normal Procedures. The MCP is set to the DA(H)/MDA(H) just prior to the FAF altitude and reset on final approach to the missed approach altitude.

For instrument approaches where there are closely spaced waypoints between the IAF and the FAF, operators may permit crews, with appropriate training to set the FAF altitude initially, then when nearing the FAF altitude, the MCP may be set according to the Normal Procedures.

For approaches where there is a published GP angle between the IAF and the FAF, the MCP may be set to the DA (H) when intercepting the published GP.

Decision Altitude (DA(H)) or Minimum Descent Altitude (MDA(H))

When specifically authorized by the appropriate regulatory authority, approaches may be flown to the following minima:

- a published VNAV DA(H)
- a published MDA(H) used as a decision altitude.

When either of the above minima are not specifically authorized, use the MDA(H) specified for the instrument procedure.

777 Flight Crew Training Manual

The following diagram illustrates an approach procedure containing DA(H) and MDA(H) minimums for approaches using LNAV/VNAV or LNAV only.

STRAIGHT-IN LANDING RWY 28R					CIRCLE - TO - LAND		
LNAV/VNAV DA(H) 740' (727')			LNAV MDA(H) 1000' (987')		Max Kts	MDA(H)	
	ALS out		ALS out				
A	2	2½	RVR 40 or ¾	RVR 60 or 1¼	90	1000' (987') - 2	
B			RVR 50 or 1	1½	120		
C			2½	3	140		1140' (1027') - 3
D					2¼		165

Note: Some non-ILS approaches specify a VNAV DA(H). Regulations may require use of the autopilot in the VNAV PTH mode to permit use of the DA(H).

When reaching the DA(H) or MDA(H), be prepared to disengage the autopilot and land or execute an immediate go-around.

Note: If using an MDA(H), initiating a missed approach approximately 50 feet above MDA(H) may be necessary to avoid descending below the MDA(H) during the missed approach, if required for the procedure or by the regulatory authority.

The pilot monitoring should expand the instrument scan to include outside visual cues when approaching DA(H) or MDA(H). Do not continue the approach below DA(H) or MDA(H) unless the airplane is in a position from which a normal approach to the runway of intended landing can be made and suitable visual reference can be maintained. Upon arrival at DA(H) or MDA(H) or any time thereafter, if any of the above requirements are not met, immediately execute the missed approach procedure.

When suitable visual reference is established, maintain the descent path to the flare. Do not descend below the visual glide path. While VNAV PTH guidance may still be used as a reference once the airplane is below DA(H) or MDA(H), the primary means of approach guidance is visual.

Note: VNAV path guidance transitions to level flight once the missed approach fix is passed.



Simulated Instrument Approach Using VNAV

To maintain proficiency, crews may practice instrument approach using VNAV procedures while flying ILS approaches as follows:

- ensure the ILS is tuned and identified and the ILS raw data is monitored throughout the approach
- track the localizer using LOC or LNAV as the roll mode
- use VNAV as the pitch mode to track the GP angle. The GP angle on the approach chart normally coincides with the ILS glide slope angle
- disengage the autopilot by the minimum altitude specified in the Limitations chapter of the FCOM.

Note: Limit the use of the above technique to VMC weather conditions.

In ambient temperature conditions warmer than ISA standard, the airplane may remain slightly high relative to the ILS glide slope, and in temperatures colder than ISA standard, the airplane may remain slightly lower than the ILS glide slope. Discontinue use of this technique and manually track the localizer and glide slope if localizer or glide slope deviations become unacceptable.

Instrument Approach Using V/S or FPA

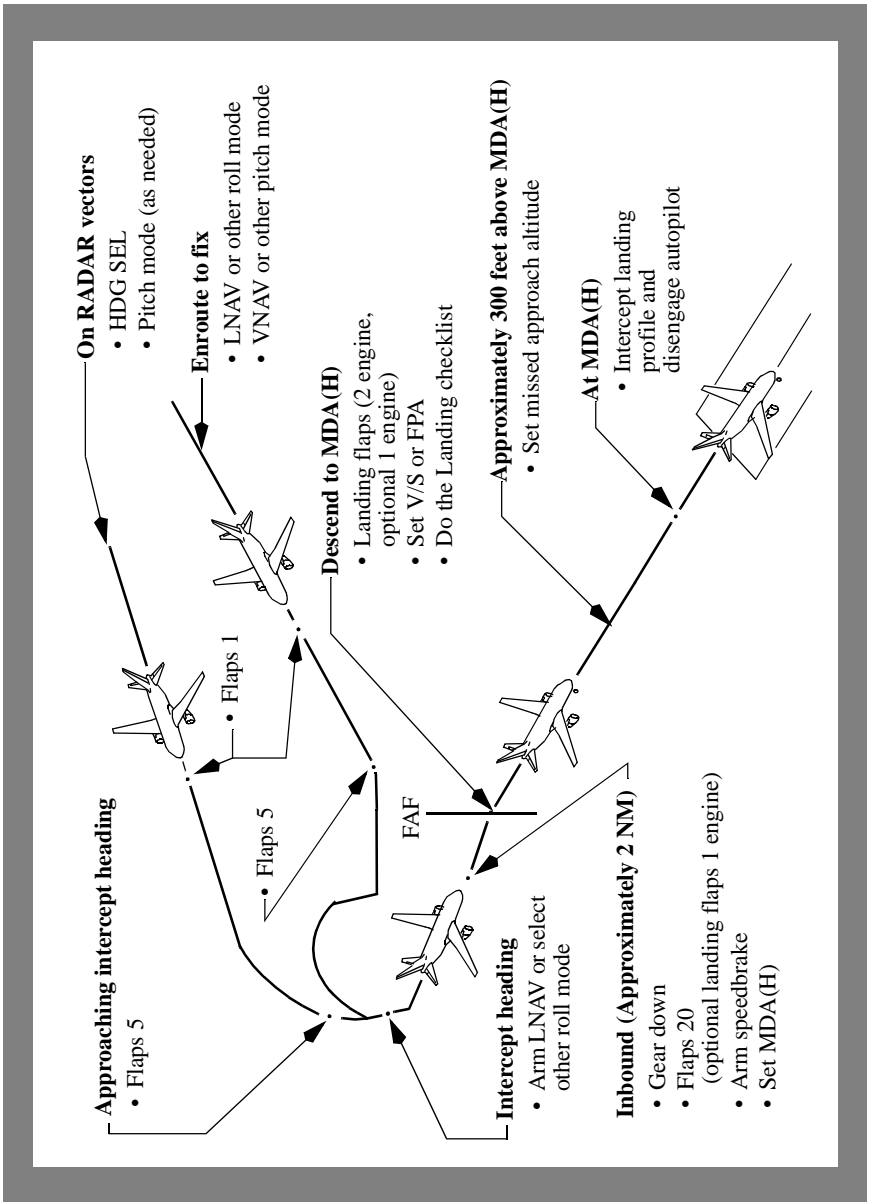

Approach Preparations for using V/S or FPA

Select the approach procedure from the arrivals page of the FMC. Tune and identify appropriate nav aids. If additional waypoint references are desired, use the FIX page. To enable proper LNAV waypoint sequencing, select a straight-in intercept course to the FAF when being radar vectored to final approach.

Verify/enter the appropriate RNP and set the MDA(H) using the baro minimums selector. If required to use MDA(H) for the approach minimum altitude, the barometric minimums selector should be set at MDA + 50 feet to ensure that if a missed approach is initiated, descent below the MDA(H) does not occur during the missed approach.

Final Approach using V/S or FPA

Approaching intercept heading, select flaps 5 and ensure LNAV or other appropriate roll mode is armed or engaged. Approaching the FAF (approximately 2 NM), select gear down and flaps 20 and adjust speed. Set the MCP altitude window to the first intermediate altitude constraint, or MDA(H) if no altitude constraint exists. If the altitude constraint is not at an even 100 foot increment, set the MCP altitude to the nearest 100 ft. increment below the altitude constraint. The MDA(H) may be set within 10 feet as long as the minimums are set using the minimums selector.

When initiating descent to MDA(H), select landing flaps, slow to final approach speed and do the Landing checklist. If the charted FAF is too close to the runway to permit a stabilized approach, consider establishing final approach pitch mode and configuring for approach and landing earlier than specified in the FCOM procedure.

At or after the FAF, select V/S or FPA mode and descend at appropriate vertical speed, or flight path angle, to arrive at the MDA(H) at a distance from the runway (VDP) to allow a normal landing profile. If V/S mode is used, initial selection of an appropriate V/S should be made considering the recommended vertical speeds that are published on the approach chart, if available. These recommended vertical speeds vary with the airplane's ground speed on final approach. If no recommended vertical speeds are available, set approximately -700 to -800 fpm.

If FPA mode is used, initial selection of an appropriate FPA should be made considering the final approach descent angle or glide path angle published on the approach chart, if available. If no descent angle or glide path angle is available from the approach chart, set -3.0° initially. FPA mode allows the pilot to select a flight path (e.g. -3.0°) which automatically compensates for headwind or tailwind component. This may permit reduced workload.

777 Flight Crew Training Manual

When stabilized in a descent on final approach, use one of the following techniques to make small incremental changes to the resulting vertical speed or FPA to achieve a constant angle descent to minimums. There should be no level flight segment at minimums.

Several techniques may be used to achieve a constant angle path that arrives at MDA(H) at or near the VDP:

- the most accurate technique is to monitor the VNAV path deviation indication on the map display and adjust descent rate or FPA to maintain the airplane on the appropriate path. This technique requires the path to be defined appropriately on the legs page and that the header GPx.xx is displayed for the missed approach point or there is a RWxx or MXxx, or named waypoint on the legs page with an altitude constraint which corresponds to approximately 50 ft. threshold crossing height. When this method is used, crews must ensure compliance with each minimum altitude constraint on the final approach segment (step-down fixes)
- select a descent rate or FPA that places the altitude range arc at or near the step-down fix or visual descent point (VDP). This technique requires the step-down fix or MDA(H) to be set in the MCP and may be difficult to use in turbulent conditions. See the Visual Descent Point section for more details on determining the VDP
- using 300 feet per NM for a 3° path, determine the desired HAA which corresponds to the distance in NM from the runway end. The PM can then call out recommended altitudes as the distance to the runway changes (Example: 900 feet - 3 NM, 600 feet - 2 NM, etc.). The descent rate or FPA should be adjusted in small increments for significant deviations from the nominal path.

Be prepared to land or go-around from the MDA(H) at the VDP. Note that a normal landing cannot be completed from the published missed approach point on many instrument approaches.

Approximately 300 feet above the MDA(H), select the missed approach altitude. Leaving the MDA(H), disengage the autopilot. Turn both F/Ds OFF, then place the PM's F/D ON. This eliminates unwanted commands for the PF and allows continued F/D guidance for the PM in the event of a go-around when pitch or roll mode is changed. Complete the landing.

On the V/S approach, the missed approach altitude is set when 300 feet above the MDA(H) to use the guidance of the altitude range arc during the approach and to prevent altitude capture and destabilizing the approach. Unlike an approach using VNAV, the occurrence of VNAV ALT is not an issue. Since there is no below path alerting, keeping the MDA(H) set as long as possible is recommended to help prevent inadvertent descent below MDA(H).

**Minimum Descent Altitude/Height (MDA(H))**

The pilot monitoring should expand the instrument scan to include outside visual cues when approaching MDA(H). Do not continue the approach below MDA(H) unless the airplane is in a position from which a normal approach to the runway of intended landing can be made and suitable visual reference can be maintained. Upon arrival at MDA(H) or any time thereafter, if any of the above requirements are not met, immediately execute the missed approach procedure.

When suitable visual reference is established, maintain the descent path to the flare. Do not descend below the visual glide path.

Instrument Approach - RNAV (RNP) SAAAR/AR

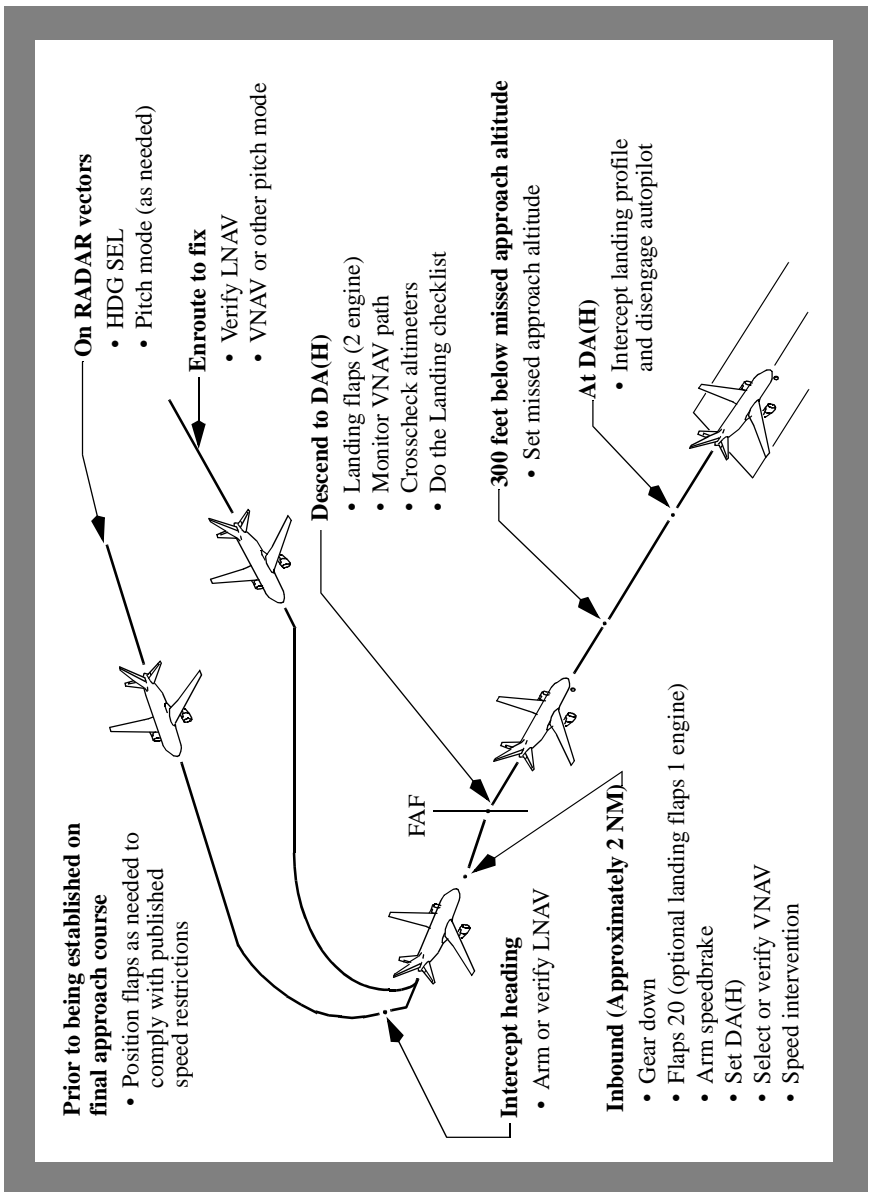

Instrument Approach - RNAV (RNP) SAAAR/AR - General**Appendix A.2.7**

This section applies only to operators who have approval to conduct RNAV (RNP) SAAAR/AR instrument approaches.

Approach Preparations using RNAV (RNP) SAAAR/AR

Select the approach procedure from the arrivals page of the FMC. If the IAF has an “at or above” altitude restriction, it may be changed to an “at” altitude restriction using the same altitude. Speed modifications are allowed as long as the maximum published speed is not exceeded. No other lateral or vertical modifications should be made at or after the IAF.

Prior to beginning the approach, the crew must brief the approach and complete needed preparations. These include, but are not limited to, the following items, which may be included in an approach review card or other type of briefing aid:

- equipment that must be operational prior to starting the approach
- selection of the approach procedure, normally without modifications, from the navigation database

Note: Conditions permitting, when ATC clears the crew to proceed direct to an intermediate fix or the FAF, a direct-to or intercept-course-to modification is acceptable unless the fix or FAF is immediately before an RF leg.

- for airplanes without NPS, one pilot should have the map display in the 10 NM or less range to monitor path tracking during the final approach segment
- for airplanes with NPS, the map display range may be set as the crew desires
- TERR display selected on at least one side
- RNP progress page displayed on the CDU, as needed. For airplanes equipped with NPS, selection of the CDU page is at the crew's discretion
- inhibiting of navigation radio updating, as needed. VOR/DME updating must always be OFF. DME-DME updating must be inhibited as needed.

Note: Prior to FMC BP14, DME-DME inhibiting is not possible. Procedures where the missed approach RNP is less than 0.6 nm are not authorized. Such procedures are annotated with a statement “Missed approach requires RNP less than 1.0”.

Note: For airplanes with FMC BP14 and later, use RAD NAV INHIBIT to inhibit all radio updating. When GPS updating is active, LOC updating is also inhibited.

777 Flight Crew Training Manual

The crew must select or verify the approach RNP. If there are multiple RNPs published for the approach procedure, the RNP availability prediction obtained at dispatch or transmitted to the crew will determine the lowest value that can be used by the crew. The crew should note if RNP availability outages affect selection of any of the published RNP values. RNP availability restrictions, due to known satellite outages, terrain masking, or other factors, can sometimes affect the availability of lower RNPs (less than 0.15 nm) but will only rarely affect use of RNPs above 0.15 nm. The highest available RNP should be selected by the crew that is permitted by the prevailing weather conditions. Weather permitting, if the approach default RNP from the FMC is 0.3 nm and is a published RNP for the procedure, it should be used so that the FMC can automatically select the approach RNP and change to the missed approach RNP if a missed approach is needed. Crew entry of the RNP will prevent automatic RNP changes until the crew deletes the RNP entry.

For airplanes with NPS, the flight crew may enter 125 feet for vertical RNP. While there are no vertical RNP values published on the approach chart, the use of 125 feet will cause the NPS amber deviation exceedance alert to occur at 75 feet or slightly less deviation, since vertical ANP will be at least 50 feet at all times.

Ensure that there is no UNABLE RNP alert shown before starting the approach. If the altimeter setting is changing rapidly, the crew should obtain an update just before starting the approach.

Select LNAV no later than the IAF. If on radar vectors, arm LNAV when approaching or established on an intercept heading to the final approach course. VNAV PTH must be engaged for all segments that contain a GP angle, as shown on the LEGS page, and must be selected nearing the FAF or earlier.

Final Approach using RNAV (RNP) SAAAR/AR

When initiating descent on the final approach path, select landing flaps, slow to final approach speed, and do the Landing checklist. Speed limits published on the approach chart must be complied with to enable adequate bank angle margins for the smaller radius-to-fix (RF) legs when strong winds exist. Bank angles will rarely exceed 15° when flying short radius RF legs unless the ground speed is very high due to strong tailwinds or high airplane speed.

The FMC and the alerting system monitors position accuracy and integrity (also called actual navigation performance), so there is no need for the crew to monitor the reception of GPS signals or the ANP. If the GPS signal is lost during the approach due to loss of both GPS receivers or satellite position data, the ANP will grow and an UNABLE RNP alert occurs. The ANP is an FMC calculation based on RAIM, method of updating, and other factors, and constantly fluctuates in value. As long as ANP does not exceed RNP, there is no practical or reliable way for the crew to interpret the fluctuations of ANP. If ANP grows large enough to exceed RNP, an UNABLE RNP alert occurs.

Once established on final approach, the RNAV (RNP) approach is flown like any other non-ILS approach using LNAV and VNAV.

Maximum Lateral and Vertical Deviations for RNAV (RNP) SAAAR/AR Operations

RNP-based approach operations are normally designed to a lateral containment standard that equals twice the value of the RNP that is published for the procedure. To provide an adequate safety margin to account for path tracking errors, crews are expected to maintain course within $1.0 \times \text{RNP}$. For example, an RNP 0.15 approach will have a lateral containment limit of 0.30 nm, and a lateral deviation limit of 0.15 nm. Vertically, the deviation limit below the path is normally -75 feet, which only applies from the FAF to the missed approach point, unless the approach is annotated otherwise. Prior to the FAF, the vertical limit below the path is determined by the minimum altitude at the next (active) waypoint published on the approach chart. If a deviation above the path occurs, the crew should apply the criteria for a stabilized approach to determine the need for a missed approach.

For airplanes without NPS, the crew must refer to the FMC progress pages for XTK and VTK information during the approach. It is recommended that the PF and PM both monitor path tracking using the map display. If a deviation occurs, and the correction back to course is not immediate, then the PM should refer to the FMC progress page and notify the PF if the maximum allowable deviations are reached. Fixation on the FMC deviation indications is not recommended.

For airplanes with NPS, the crew can refer to the NPS deviation indications. Full scale lateral and vertical deviation for NPS is equal to the FMC RNP value. If the deviation approaches the limit, an immediate correction back to the path is needed. If the deviation exceeds the limit or an amber deviation alert occurs, a missed approach is required unless the crew has suitable visual reference to continue to a landing. In the event of a missed approach for excessive deviation, the crew must continue to make corrections back to and maintain the required course.

Visual Descent Point

For a non-ILS approach, the VDP is defined as the position on final approach from which a normal descent from the MDA(H) to the runway touchdown point may be initiated when suitable visual reference is established. If the airplane arrives at the VDP, a stabilized visual segment is much easier to achieve since little or no flight path adjustment is required to continue to a normal touchdown.

VDPs are indicated on some non-ILS approach charts by a “V” symbol. The distance to the runway is shown below the “V” symbol. If no VDP is given, the crew can determine the point where to begin the visual descent by determining the height above the airport (HAA) of the MDA(H) and use 300 feet per NM distance to the runway.

777 Flight Crew Training Manual

In the following example, an MDA(H) of 550 feet MSL with a 100 feet touchdown zone elevation results in a HAA of 450 feet. At 300 feet per NM, the point to begin the visual descent is 1 ½ NM distance from the runway.

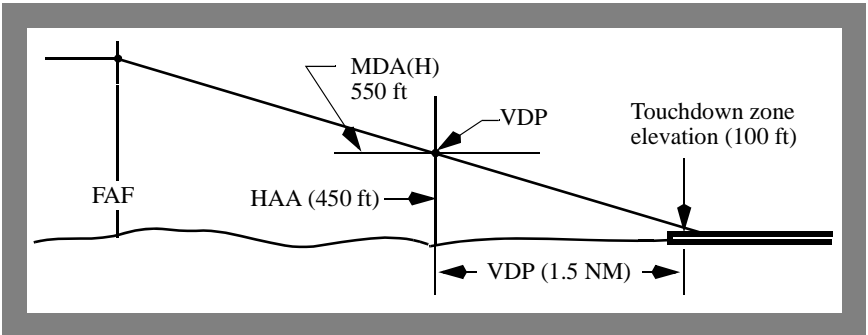

Most VDPs are between 1 and 2 NM from the runway. The following table provides more examples.

HAA (feet)	300	400	450	500	600	700
VDP Distance, NM	1.0	1.3	1.5	1.7	2.0	2.3

Note: If flying a VNAV path approach and the airplane remains on the published path, then the VDP is automatically complied with when the airplane arrives at the DA(H) or MDA(H). It is not necessary to determine the point to begin the visual descent for VNAV path approaches for this reason.

When flying an instrument approach using V/S or FPA, if the pilot adjusts the altitude range arc to approximately the VDP distance in front of the runway by varying the vertical speed or flight path angle, the airplane will remain close to or on the proper path for typical non-ILS approaches.

Missed Approach - Non-ILS

Refer to Go-Around and Missed Approach - All Approaches, this chapter.

Circling Approach

If a missed approach is needed at any time while circling, make an initial climbing turn toward the landing runway and intercept the missed approach course.

Configuration at MDA(H)

- Gear down
- Flaps 20 (landing flaps optional)
- Arm speedbrake

Before turning base or initiating the turn to base

- Landing flaps (if not previously selected)
- Do the Landing checklist

Minimum descent altitude

- Select ALT HOLD (as needed)
- Set missed approach altitude
- Select HDG SEL/HDG HOLD or TRK SEL/TRK HOLD

Intercepting landing profile

- Disengage autopilot

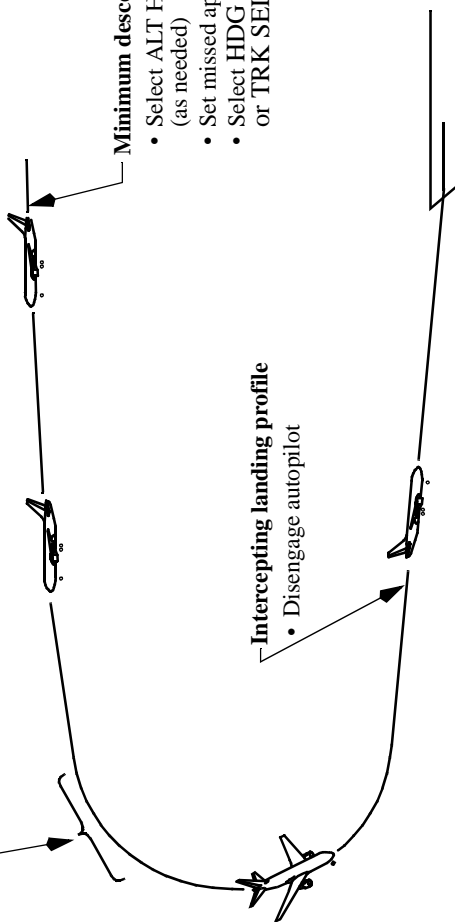

Circling Approach - General

The circling approach should be flown with landing gear down, flaps 20, and at flaps 20 maneuver speed. Use the weather minima associated with the anticipated circling speed. As an option the approach may be flown with flaps 25 or 30.

The circling approach may be flown following any instrument approach procedure. During the instrument approach, use VNAV, V/S, or FPA modes to descend to the circling MDA. Use of the APP mode for descent to the circling MDA is not recommended for several reasons:

- the AFDS does not level off at MCP altitude
- exiting the APP mode requires initiating a go-around or disengaging the autopilot and turning off the flight directors.

Maintain MDA(H) using ALT HOLD or VNAV ALT mode. Use HDG SEL/HDG HOLD or TRK SEL/TRK HOLD for the maneuvering portion of the circling approach.

When in ALT HOLD or VNAV ALT at the MDA(H) and before commencing the circling maneuver, set the missed approach altitude.

Before turning base or when initiating the turn to base leg, select landing flaps if not previously selected and begin decelerating to the approach speed plus wind correction. To avoid overshooting final approach course, adjust the turn to final to initially aim at the inside edge of the runway threshold. Timely speed reduction also reduces turning radius to the runway. Do the Landing checklist. Do not descend below MDA(H) until intercepting the visual profile to the landing runway.

Leaving MDA(H), disengage the autopilot. After intercepting the visual profile, cycle both F/D to OFF, and select the PM F/D to ON. This eliminates unwanted commands for the PF and allows continued F/D guidance for the PM in the event of a go-around when pitch or roll mode is changed. Complete the landing.

Note: If a go-around is selected with either flight director switch in the OFF position, the flight director pitch or roll command bar on the corresponding side will disappear when the first pitch or roll mode is selected or engaged.

Obstruction Clearance

Obstruction clearance areas during the circling approach are depicted in the following figure. Distances are determined by the maximum IAS during the circling approach and are depicted in the table following the figure.

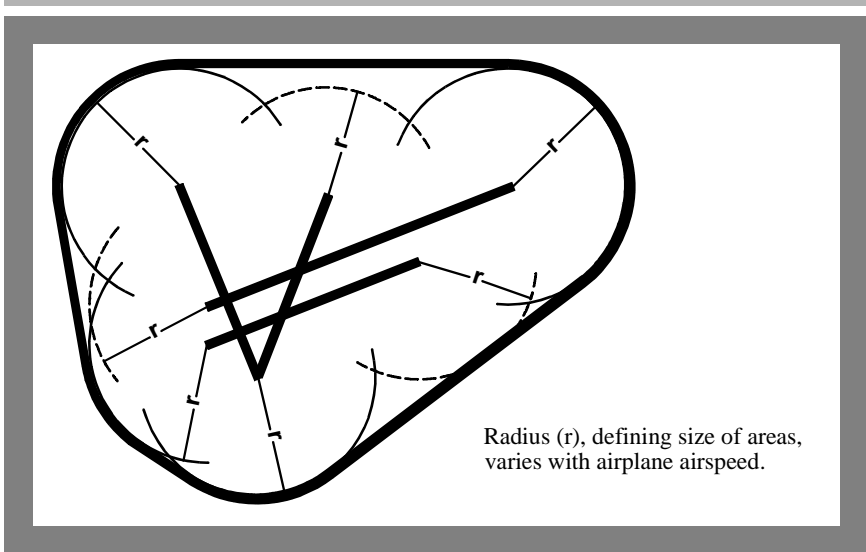

Radius (r), defining size of areas, varies with airplane airspeed.

FAA	
Maximum IAS	Circling Area Radius (r) from Threshold
140 Kts	1.7 NM
165 Kts	2.3 NM

ICAO	
Maximum IAS	Circling Area Radius (r) from Threshold
180 Kts	4.2 NM
205 Kts	5.28 NM

Note: Adjust airplane heading and timing so that the airplane ground track does not exceed the obstruction clearance distance from the runway at any time during the circling approach.

Circling Approach - One Engine Inoperative

If a circling approach is anticipated, maintain gear down, flaps 20 and a minimum of VREF 20 plus wind correction while circling. Do not descend below MDA(H) until intercepting the visual profile.

777 Flight Crew Training Manual

If landing with flaps 30, maintain gear down, flaps 20, and flaps 20 maneuver speed from the final approach fix until initiating the turn to base. Before turning base or when initiating the turn to base leg, select flaps 30, reduce speed to VREF 30 plus wind correction and intercept the landing profile. Do not descend below MDA(H) until intercepting the visual profile.

Under some flight conditions such as high temperatures, high pressure altitudes, and high airplane weight, limit thrust may be required to maintain level flight with the gear down and flaps 20. When these conditions are encountered consider retracting the landing gear for the circling portion of the approach after the descent to MDA(H). The GPWS gear override switch may be used to prevent nuisance warnings.

Missed Approach - Circling

If a missed approach is required at any time while circling, make a climbing turn in the shortest direction toward the landing runway. This may result in a turn greater than 180° to intercept the missed approach course. Continue the turn until established on an intercept heading to the missed approach course corresponding to the instrument approach procedure just flown. Maintain the missed approach flap setting until close-in maneuvering is completed.

Different patterns may be required to become established on the prescribed missed approach course. This depends on airplane position at the time the missed approach is started. The following figure illustrates the maneuvering that may be required. This ensures the airplane remains within the circling and missed approach obstruction clearance areas.

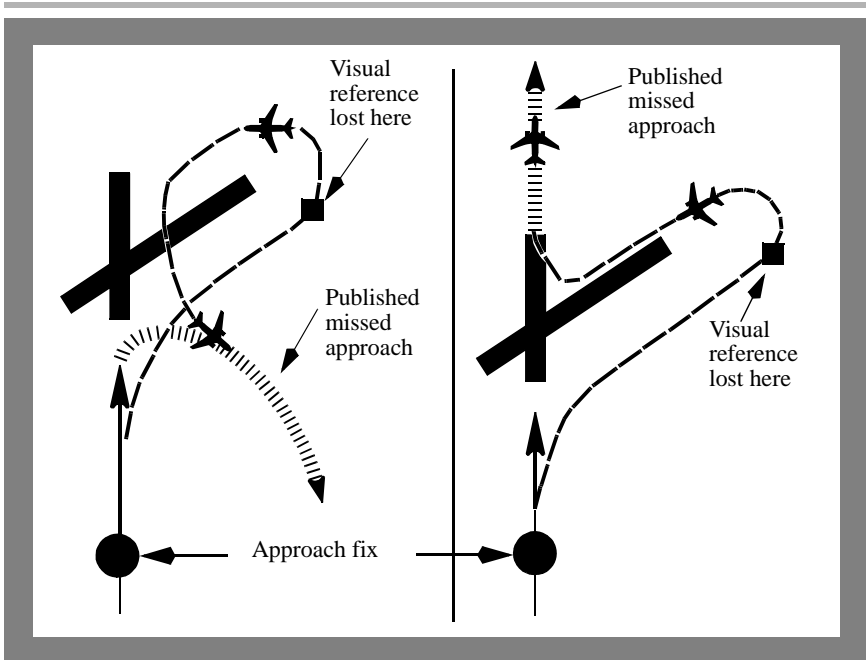

In the event that a missed approach must be accomplished from below the MDA(H), consideration should be given to selecting a flight path which assures safe obstacle clearance until reaching an appropriate altitude on the specified missed approach path.

Refer to Go-Around and Missed Approach - All Approaches, this chapter.

Visual Traffic Pattern

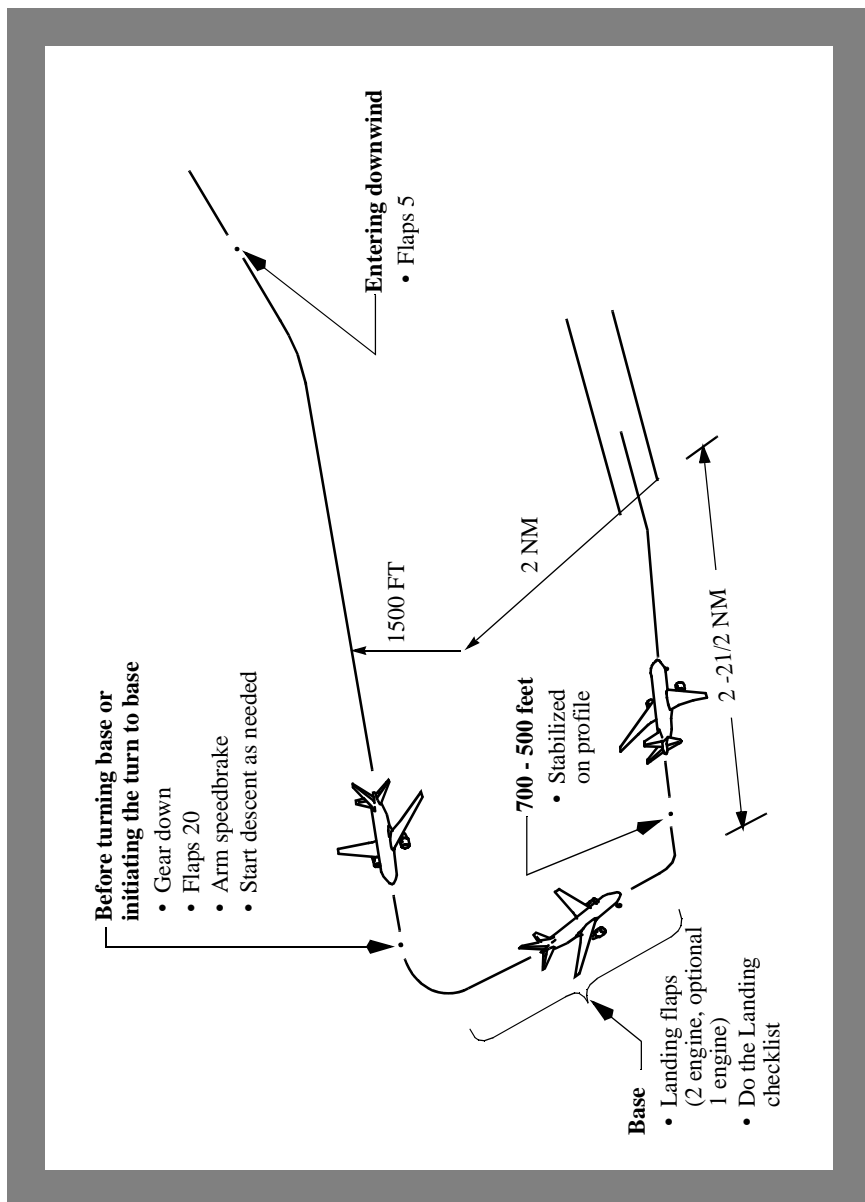

Visual Approach - General

The recommended landing approach path is approximately 2 1/2° to 3°. Once the final approach is established, the airplane configuration remains fixed and only small adjustments to the glide path, approach speed, and trim are necessary. This results in the same approach profile under all conditions.

Thrust

Engine thrust and elevators are the primary means to control attitude and rate of descent. Adjust thrust slowly using small increments. Sudden large thrust changes make airplane control more difficult and are indicative of an unstable approach. No large changes should be necessary except when performing a go-around. Large thrust changes are not required when extending landing gear or flaps on downwind and base leg. A thrust increase may be required when stabilizing on speed on final approach.

Downwind and Base Leg

Fly at an altitude of 1500 feet above the runway elevation and enter downwind with flaps 5 at flaps 5 maneuver speed. Maintain a track parallel to the landing runway approximately 2 NM abeam.

Before turning base or initiating the turn to base, extend the landing gear, select flaps 20, arm the speedbrake, and slow to flaps 20 maneuver speed or approach speed plus wind correction if landing at flaps 20. If the approach pattern must be extended, delay lowering gear and selecting flaps 20 until approaching the normal visual approach profile. Turning base leg, adjust thrust as required while descending at approximately 600-700 fpm.

Extend landing flaps before turning final. Allow the speed to decrease to the proper final approach speed and trim the airplane. Do the Landing checklist. When established in the landing configuration, maneuvering to final approach may be accomplished at final approach speed (VREF plus wind correction).

Final Approach

Roll out of the turn to final on the extended runway centerline and maintain the appropriate approach speed. An altitude of approximately 300 feet AFE for each NM from the runway provides a normal approach profile. Use of the autothrottle is recommended. However, if controlling thrust manually, attempt to keep thrust changes small to maintain speed and avoid large trim changes. With the airplane in trim and at approach airspeed, pitch attitude should be approximately the normal approach body attitude. At speeds above approach speed, pitch attitude is less. At speeds below approach speed, pitch attitude is higher. Slower speed reduces aft body clearance at touchdown. Stabilize the airplane on the selected approach airspeed with an approximate rate of descent between 700 and 900 feet per minute on the desired glide path, in trim. Stabilize on the profile by 500 feet above touchdown.

Note: Descent rates greater than 1,000 fpm should be avoided.

With one engine and TAC inoperative, the rudder trim may be centered before landing. This allows most of the rudder pedal pressure to be removed when the thrust of the operating engine is retarded to idle at touchdown.

Full rudder authority and rudder pedal steering capability are not affected by rudder trim. If touchdown occurs with the rudder still trimmed for the approach, be prepared for the higher rudder pedal forces required to track the centerline on rollout.

Engine Failure On Final Approach

In case of engine failure on visual final approach, use the procedure described in the ILS approach section, this chapter.

Touch and Go Landings

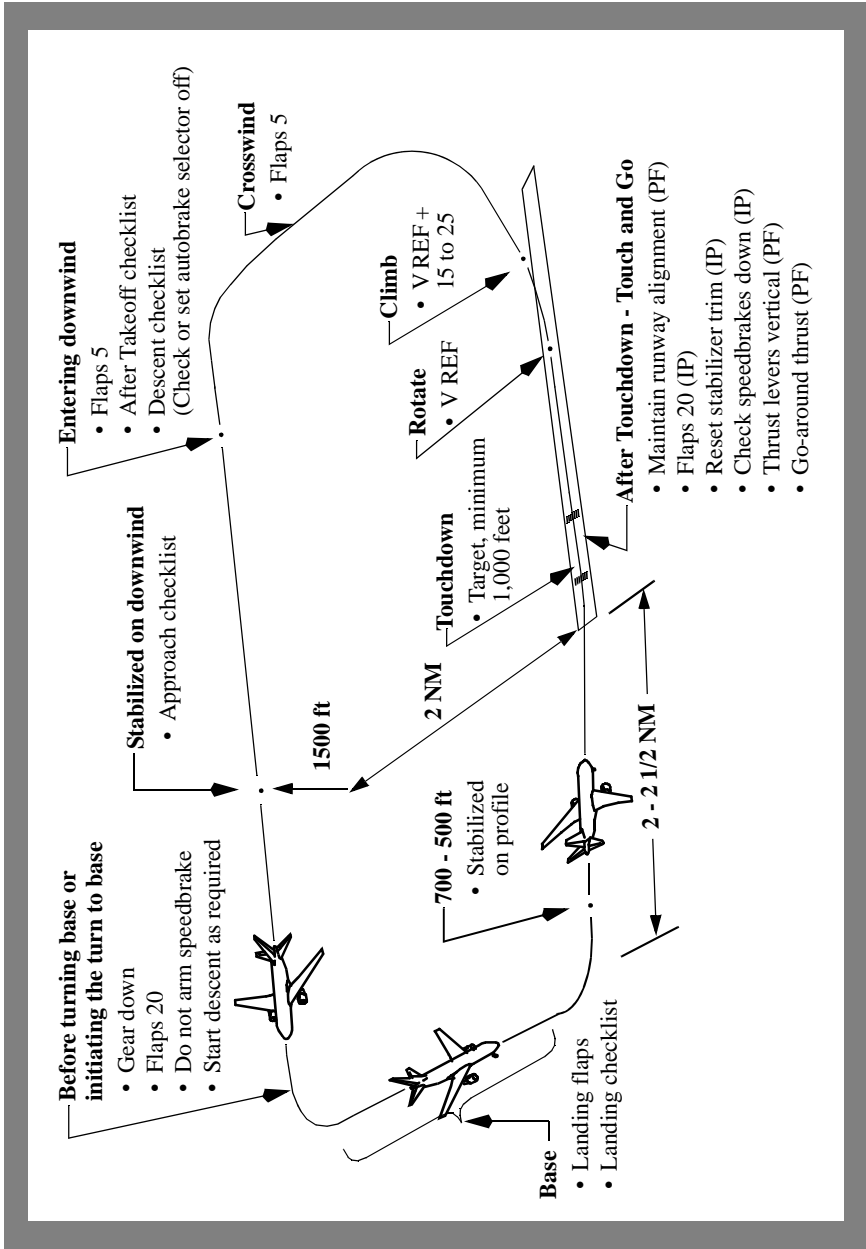

Touch and Go Landing - General

The primary objective of touch and go landings is approach and landing practice. It is not intended for landing roll and takeoff procedure training.

Approach

Accomplish the pattern and approach procedures as illustrated. The landing gear may remain extended throughout the maneuver for brake cooling, but be prepared to retract the landing gear if an actual engine failure occurs during go-around. Do not arm the speedbrakes. Select the autobrakes OFF.

Landing

The trainee should do a normal final approach and landing. After touchdown, the instructor selects flaps 20, sets stabilizer trim, ensures speedbrakes are down and at the appropriate time instructs the trainee to move the thrust levers to approximately the vertical position (so engines stabilize before applying go-around thrust). When the engines are stabilized, the instructor instructs the trainee to set thrust.

Note: Flaps 20 is recommended after touchdown to minimize the possibility of a tail strike during the takeoff.

WARNING: After reverse thrust is initiated, a full stop landing must be made.

At VREF, the instructor calls “ROTATE” and the trainee rotates smoothly to approximately 15° pitch and climb at VREF + 15 to 25 knots. The takeoff configuration warning siren may sound momentarily if the flaps are not retracting to flaps 20 and the thrust levers are advanced to approximately the vertical position.

Stop and Go Landings

The objective of stop and go landings is to include landing roll, braking, and takeoff procedure practice in the training profile.

Note: At high altitude airports, or on extremely hot days, stop and go landings are not recommended.

After performing a normal full-stop landing, a straight ahead takeoff may be performed if adequate runway is available (FAR field length must be available). After stopping, and before initiating the takeoff, do the following:

- set takeoff flaps
- trim the stabilizer for takeoff
- place speedbrake lever in the down detent
- place autobrake to RTO



- check the rudder trim
- set airspeed bugs for the flap setting to be used.

Perform a normal takeoff.

Do not make repeated full stop landings without allowing time for brake cooling. Brake heating is cumulative and brake energy limits may be exceeded. Flat tires may result.

Note: Flying the pattern with the gear extended assists in brake cooling.

Go-Around and Missed Approach - All Approaches

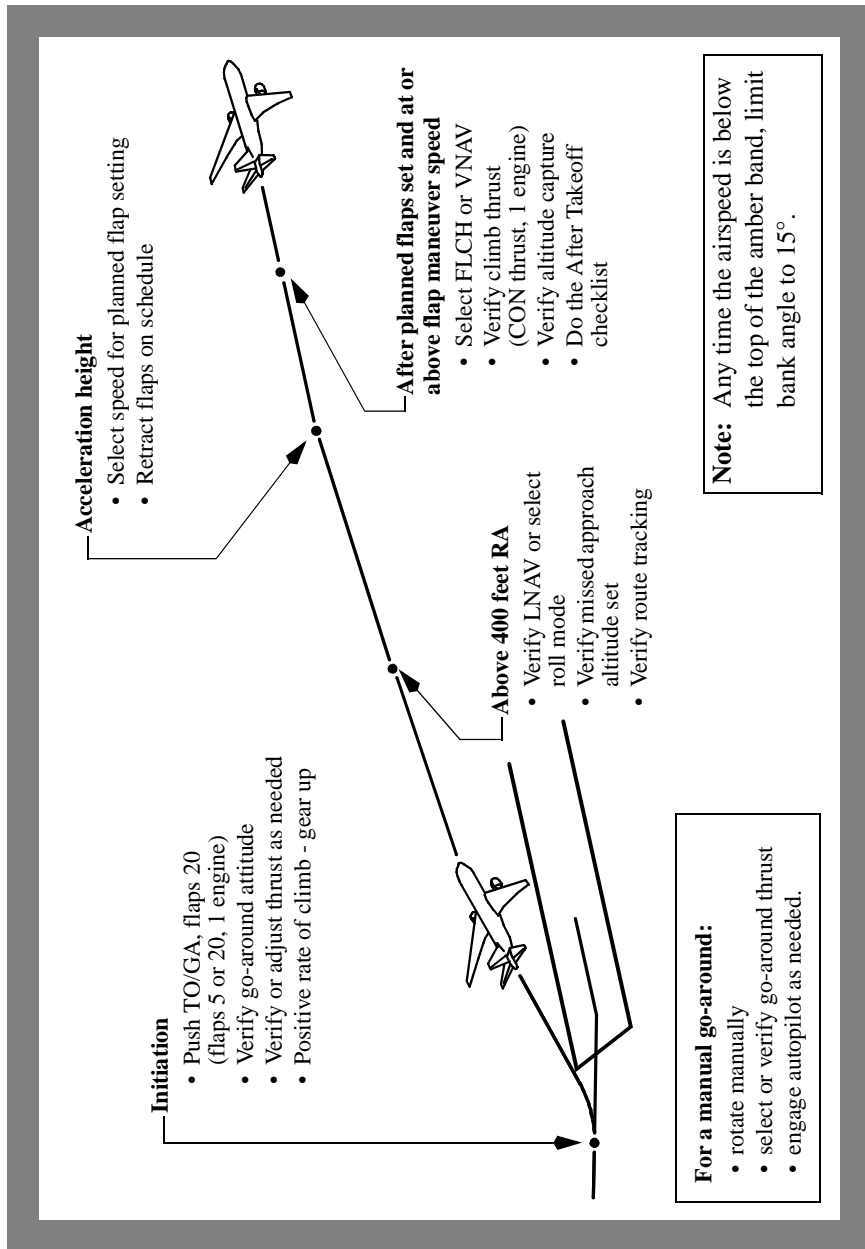

Go-Around and Missed Approach - All Engines Operating

The go-around and missed approach is generally performed in the same manner whether an instrument or visual approach was flown. The go-around and missed approach is flown using the Go-Around and Missed Approach procedure described in the FCOM. The discussion in this section supplements those procedures.

If a missed approach is required following an autopilot approach, leave the autopilots engaged. Push either TO/GA switch, call for flaps 20, ensure go-around thrust for the nominal climb rate is set and monitor autopilot performance. Retract the landing gear after a positive rate of climb is indicated on the altimeter.

At typical landing weights, actual thrust required for a normal go-around is usually considerably less than maximum go-around thrust. This provides a thrust margin for windshear or other situations requiring maximum thrust. If full thrust is desired after thrust for the nominal climb rate has been established, press TO/GA a second time.

If a missed approach is required following a manual instrument approach or visual approach, push either TO/GA switch, call for flaps 20, ensure/set go-around thrust, and rotate smoothly toward 15° pitch attitude. Then follow flight director commands and retract the landing gear after a positive rate of climb is indicated on the altimeter.

During an automatic go-around initiated at 50 feet, approximately 30 feet of altitude is lost. If touchdown occurs after a go-around is initiated, the go-around continues. Observe that the autothrottles apply go-around thrust or manually apply go-around thrust as the airplane rotates to the go-around attitude.

Note: An automatic go-around cannot be initiated after touchdown.

The TO/GA pitch mode initially commands a go-around attitude and then transitions to speed as the rate of climb increases. This speed is normally between command speed and command speed + 25 knots. The TO/GA roll mode maintains existing ground track. Above 400 feet AGL, verify that LNAV is engaged for airplanes equipped with the TO/GA to LNAV feature, or select a roll mode as appropriate.

The minimum altitude for flap retraction during a normal takeoff is not normally applicable to a missed approach procedure. However, obstacles in the missed approach flight path must be taken into consideration. During training, use 1,000 feet AGL to initiate acceleration for flap retraction, as during the takeoff procedure.

Note: Pitch and roll modes cannot be engaged until above 400 feet AGL.

777 Flight Crew Training Manual

If initial maneuvering is required during the missed approach, do the missed approach procedure through gear up before initiating the turn. Delay further flap retraction until initial maneuvering is complete and a safe altitude and appropriate speed are attained.

Command speed should not be increased until a safe altitude and acceleration height is attained. Accelerate to flap retraction speed by repositioning the command speed to the maneuver speed for the desired flap setting. Retract flaps on the normal flap/speed schedule. When the flaps are retracted to the desired position and the airspeed approaches maneuver speed, select FLCH or VNAV and ensure CLB thrust is set. Verify the airplane levels off at selected altitude and proper speed is maintained.

If VNAV is used during go-around, the FMC missed approach profile should contain the appropriate holding speeds and altitudes. Speed intervention may be used to further modify airspeed as needed. If VNAV ALT is displayed, a premature level off may occur and selection of FLCH may be required to complete the climb to the missed approach altitude.

Low Altitude Level Off - Low Gross Weight

When accomplishing a low altitude level off following a go-around at a low gross weight, the crew should consider the following factors:

- if full go-around thrust is used, altitude capture can occur just after the go-around is initiated due to the proximity of the level off altitude and the high climb rate of the airplane
- the AFDS control laws limit F/D and autopilot pitch commands for passenger comfort
- there may not be enough altitude below the intended level off altitude to complete the normal capture profile and an overshoot may occur unless crew action is taken.

To prevent an altitude and/or airspeed overshoot, the crew should consider doing one or more of the following:

- use the autothrottle
- press TO/GA switch once to command thrust sufficient for a 2,000 fpm climb rate
- if full go-around thrust is used, reduce to climb thrust earlier than normal
- disconnect the AFDS and complete the level off manually if there is a possibility of an overshoot
- if the autothrottle is not available, be prepared to use manual thrust control as needed to manage speed and prevent flap overspeed.

Go-Around after Touchdown

If a go-around is initiated before touchdown and touchdown occurs, continue with normal go-around procedures. The F/D go-around mode will continue to provide go-around guidance commands throughout the maneuver.

If a go-around is initiated after touchdown but before thrust reverser selection, auto speedbrakes retract and autobrakes disarm as thrust levers are advanced. The F/D go-around mode will not be available until go-around is selected after becoming airborne.

Once reverse thrust is initiated following touchdown, a full stop landing must be made. If an engine stays in reverse, safe flight is not possible.

Go-Around and Missed Approach - One Engine Inoperative

The missed approach with an engine inoperative should be accomplished in the same manner as a normal missed approach except use flaps 5 for the go-around flap setting for a flaps 20 approach or use flaps 20 as the go-around flap setting for a flaps 25 or 30 approach. After TO/GA is engaged, the AFDS commands a speed that is normally between command speed and command speed + 15 knots. The rudder is automatically positioned by the TAC to compensate for differential thrust with minimal input required from the pilot. Select maximum continuous thrust when flaps are retracted to the desired flap setting.

Note: If accomplishing a manual go-around with the TAC inoperative, the pilot must control yaw with rudder and trim. Some rudder pedal pressure may be required even with full rudder trim.

For a multi-autopilot go-around, yaw is initially controlled by the autopilots. When selecting another roll mode, pitch mode, or when altitude capture occurs above 400 feet AGL the autopilot reverts to single autopilot operation and the rudder control is maintained by the TAC.

Note: If the TAC is inoperative, be prepared to immediately apply rudder input when the autopilot reverts to single autopilot operation.

Engine Failure During Go-Around and Missed Approach

If an engine fails during a go-around, it is important that airspeed loss be recovered to prevent a high asymmetric thrust condition at lower than recommended airspeed. Follow flight director guidance to recover and maintain recommended airspeed. Use the same procedures as used for an engine failure during a flaps 20 takeoff.

Note: VREF 30 plus wind correction at flaps 20 may result in an airspeed that provides less than full maneuver margin (top of the amber band).



Landing

Table of Contents

Chapter 6

Section TOC

Preface 6.1

Visual Approach Slope Indicator (VASI/T - VASI) 6.1

 Three Bar VASI/T - VASI 6.2

 VASI Landing Geometry 6.3

Precision Approach Path Indicator 6.5

 PAPI Landing Geometry 6.5

Landing Geometry 6.5

 Visual Aim Point 6.5

 Runway Markings (Typical) 6.7

 Threshold Height 6.8

Flare and Touchdown 6.8

 Airspeed Control 6.9

 Landing Flare Profile 6.9

 Normal Touchdown Attitude 6.10

 Pitch and Roll Limit Conditions 6.20

 Bounced Landing Recovery 6.24

 Rejected Landing 6.25

Landing Roll 6.26

 Speedbrakes 6.26

 Directional Control and Braking during Landing Roll 6.27

 Factors Affecting Landing Distance 6.27

 Wheel Brakes 6.31

 Reverse Thrust Operation 6.35

Crosswind Landings 6.39

 Landing Crosswind Guidelines 6.39



777 Flight Crew Training Manual

Crosswind Landing Techniques.	6.40
Overweight Landing	6.41
Overweight Autolands Policy	6.43

Preface

This chapter outlines recommended operating practices and techniques for landing, rejected landings and landing roll. Techniques are provided to help the pilot effectively utilize approach lighting, control the airplane during crosswind landings and maintain directional control after landing. Additionally, information on factors affecting landing distance and landing geometry is provided.

Visual Approach Slope Indicator (VASI/T - VASI)

The VASI is a system of lights arranged to provide visual descent guidance information during the approach. All VASI systems are visual projections of the approach path normally aligned to intersect the runway at a point 1,000 or 1,800 feet beyond the threshold. Flying the VASI glide slope to touchdown is the same as selecting a visual aim point on the runway adjacent to the VASI installation.

When using a two-bar VASI, the difference between the eye reference path and the gear path results in a low approach with marginal threshold height. Therefore, the two-bar VASI system should not be used to determine proper approach profile. It may provide useful information in alerting the crew to low profile situations.

Some airports have three-bar VASI which provides two visual glide paths. The additional light bar is located upwind from a standard two-bar installation. When the airplane is on the glide path, the pilot sees the two white bars and one red bar. Three-bar VASI may be safely used with respect to threshold height, but may result in landing further down the runway.

For a T-VASI, flying the approach with one additional white fly down light visible provides additional wheel clearance.

Three Bar VASI/T - VASI

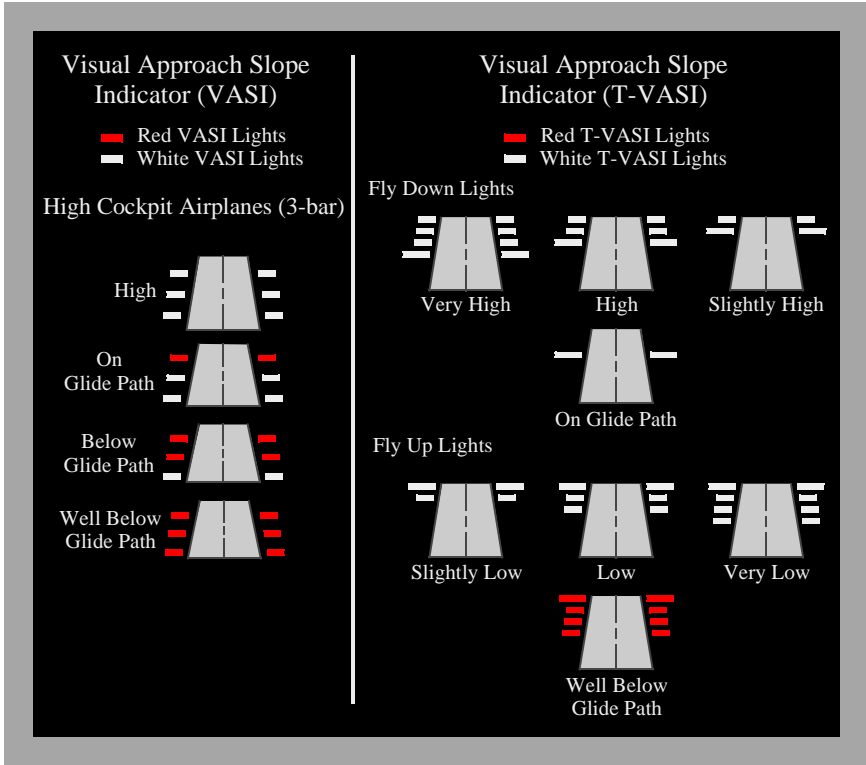

VASI Landing Geometry

Two-bar VASI installations provide one visual glide path which is normally set at 3°. Three-bar VASI installations provide two visual glide paths. The lower glide path is provided by the near and middle bars and is normally set at 3° while the upper glide path, provided by the middle and far bars, is normally 1/4° higher (3.25°). This higher glide path is intended for use only by high cockpit (long wheelbase) airplanes to provide a sufficient threshold crossing height.

Note: The use of a two bar VASI system is not recommended. A two bar VASI system provides a visual aim point that results in main landing gear touchdown at, or very near, the end of the runway threshold.

Two Bar/Three Bar VASI Landing Geometry

The following diagrams use these conditions:

- data is based upon typical landing weight
- airplane body attitudes are based on Flaps 30, VREF 30 + 5 and should be reduced by 1° for each 5 knots above this speed.
- pilot eye height is measured when the main gear is over the threshold.

Two Bar VASI Landing Geometry

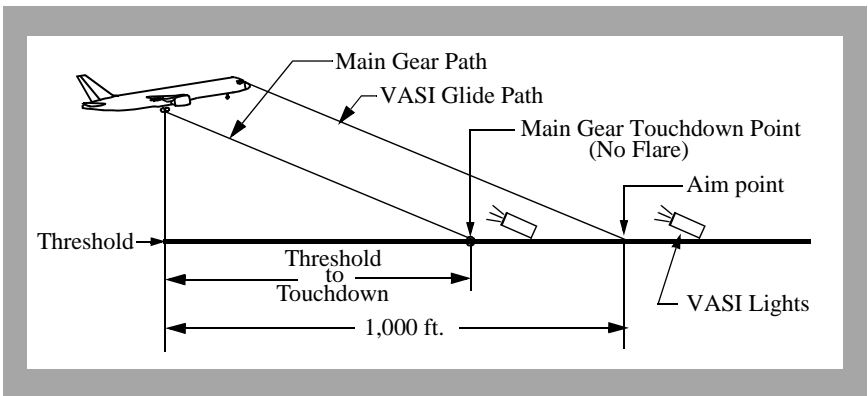

777 Flight Crew Training Manual

777 Model	Flaps 30		Main Gear over Threshold		Threshold to Main Gear Touchdown Point - No Flare (feet)
	Visual Glide Path (degrees)	Airplane Body Attitude (degrees)	Pilot Eye Height (feet)	Main Gear Height (feet)	
-200	3.0	1.9	47	20	373
-200LR	3.0	0.9	48	22	416
-300	3.0	1.4	46	19	363
-300ER	3.0	1.7	47	19	363

Three Bar (Upper Glide Path) VASI Landing Geometry

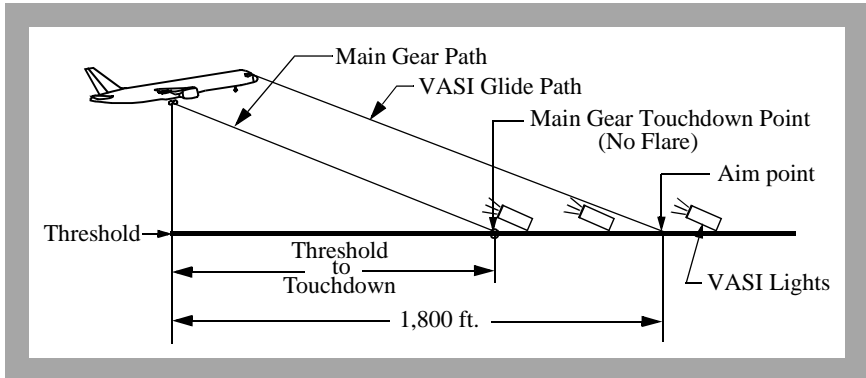

777 Model	Flaps 30		Main Gear over Threshold		Threshold to Main Gear Touchdown Point - No Flare (feet)
	Visual Glide Path (degrees)	Airplane Body Attitude (degrees)	Pilot Eye Height (feet)	Main Gear Height (feet)	
-200	3.25	1.7	97	69	1221
-200LR	3.25	0.6	97	72	1262
-300	3.25	1.2	96	69	1211
-300ER	3.25	1.5	97	69	1211

Precision Approach Path Indicator

The Precision Approach Path Indicator (PAPI) uses lights which are normally on the left side of the runway. They are similar to the VASI, but are installed in a single row of light units.

When the airplane is on a normal 3° glide path, the pilot sees two white lights on the left and two red lights on the right. The PAPI may be safely used with respect to threshold height, but may result in landing further down the runway. The PAPI is normally aligned to intersect the runway 1,000 to 1,500 feet down the runway.

PAPI Landing Geometry

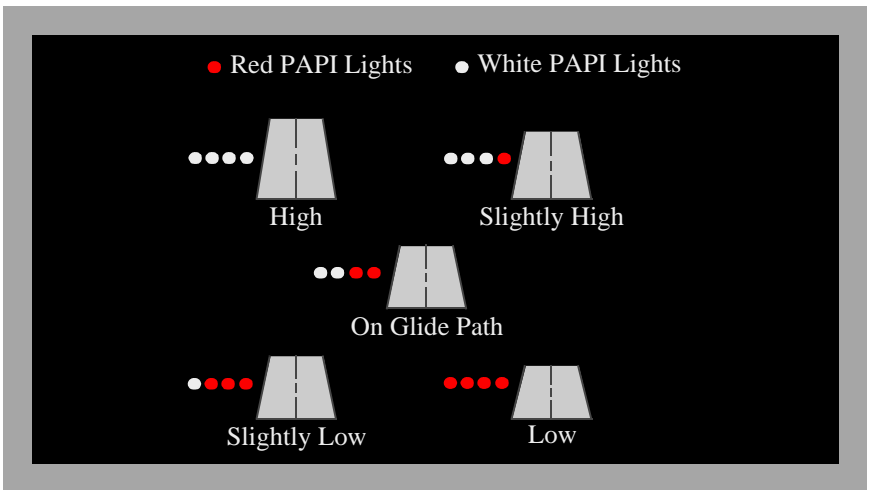

Landing Geometry

Visual Aim Point

During visual approaches many techniques and methods are used to ensure main landing gear touchdown at the desired point on the runway. One of the most common methods used is to aim at the desired gear touchdown point on the runway, then adjust the final approach glide path until the selected point appears stationary in relation to the airplane (the point does not move up or down in the pilot's field of view during the approach).

**777 Flight Crew Training Manual**

In first generation jet transports (e.g. B-707, DC-8), this method is acceptable because of the small difference between landing gear path and eye level path. Flare distance accounts for the small difference in paths. Gear touchdown occurs very near the visual aim point. However, in today's larger airplanes, the difference in gear path and eye-level path has increased because of the longer wheelbase and the increased flight deck height. Consequently, the main gear do not touchdown on the runway at the selected visual aim point.

Visual aim points versus gear touchdown point differences increase as glide path angle decreases as in a flat approach. For a particular visual approach, the difference between gear path and eye level path must be accounted for by the pilot.

Runway Markings (Typical)

The following runway markings are for runways served by a precision approach.

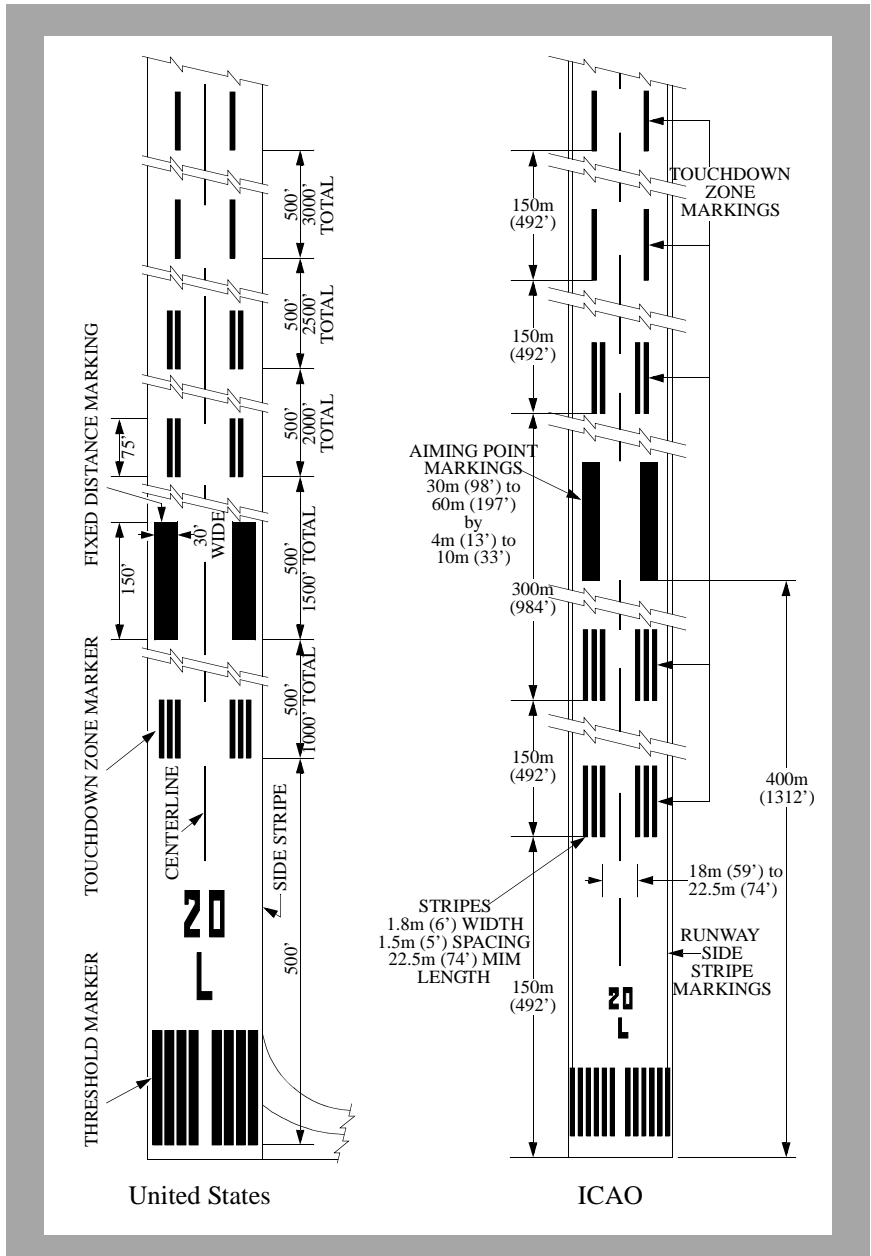

Threshold Height

Threshold height is a function of glide path angle and landing gear touchdown target. Threshold height for main gear and pilot eye level is shown in the Two Bar/Three Bar VASI Landing Geometry tables on a previous page. Special attention must be given to establishing a final approach that assures safe threshold clearance and gear touchdown at least 1,000 feet down the runway. If automatic callouts are not available, the radio altimeter should be used to assist the pilot in judging terrain clearance, threshold height and flare initiation height.

Flare and Touchdown

The techniques discussed here are applicable to all landings including one engine inoperative landings, crosswind landings and landings on slippery runways. Unless an unexpected or sudden event occurs, such as windshear or collision avoidance situation, it is not appropriate to use sudden, violent or abrupt control inputs during landing. Begin with a stabilized approach on speed, in trim and on glide path.

Note: When a manual landing is planned from an approach with the autopilot connected, the transition to manual flight should be planned early enough to allow the pilot time to establish airplane control before beginning the flare. The PF should consider disengaging the autopilot and disconnecting the autothrottle (if desired) 1 to 2 nm before the threshold, or approximately 300 to 600 feet above field elevation.

When the threshold passes under the airplane nose and out of sight, shift the visual sighting point to the far end of the runway. Shifting the visual sighting point assists in controlling the pitch attitude during the flare. Maintaining a constant airspeed and descent rate assists in determining the flare point. Initiate the flare when the main gear is approximately 20 feet above the runway by increasing pitch attitude approximately 2° - 3° . This slows the rate of descent.

If the autothrottle is engaged, the thrust lever begins to reduce toward idle at 25 feet. If the autothrottle is not engaged, after the flare is initiated, smoothly retard the thrust levers to idle, and make small pitch attitude adjustments to maintain the desired descent rate to the runway. Ideally, main gear touchdown should occur simultaneously with thrust levers reaching idle. Hold sufficient back pressure on the control column to keep the pitch attitude constant. A touchdown attitude as depicted in the figure below is normal with an airspeed of approximately VREF plus any gust correction.

Note: Do not trim during the flare or after touchdown. Trimming in the flare increases the possibility of a tail strike.

777 Flight Crew Training Manual

Airspeed Control

If engaged, the autothrottle retards the thrust so as to reach idle at touchdown. The 5 knot additive is bled off during the flare.

If the autothrottle is disengaged, or is planned to be disengaged prior to landing, maintain VREF plus the wind additive until beginning the flare. The steady headwind correction is bled off during the flare, however the gust correction is maintained to touchdown. Plan to touchdown at VREF plus the gust correction. With proper airspeed control and thrust management, touchdown should occur at no less than VREF - 5 knots.

Landing Flare Profile

The following diagrams use these conditions:

- 3° approach glide path
- flare distance is approximately 1,000 to 2,000 feet beyond the threshold
- typical landing flare times range from 4 to 8 seconds and are a function of approach speed
- airplane body attitudes are based upon typical landing weights, flaps 30, VREF 30 + 5 (approach) and VREF 30 + 0 (touchdown), and should be reduced by 1° for each 5 knots above this speed.

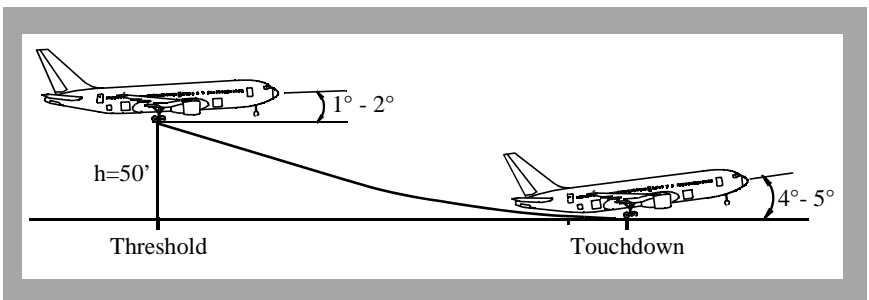

Typically, the pitch attitude increases slightly during the actual landing, but avoid over-rotating. Do not increase the pitch attitude after touchdown; this could lead to a tail strike.

Shifting the visual sighting point down the runway assists in controlling the pitch attitude during the flare. A smooth thrust reduction to idle also assists in controlling the natural nose down pitch change associated with thrust reduction. Hold sufficient back pressure on the control column to keep the pitch attitude constant.



777 Flight Crew Training Manual

Avoid rapid control column movements during the flare. If the flare is too abrupt and thrust is excessive near touchdown, the airplane tends to float in ground effect. Do not allow the airplane to float; fly the airplane onto the runway. Do not extend the flare by increasing pitch attitude in an attempt to achieve a perfectly smooth touchdown. Do not attempt to hold the nose wheels off the runway.

Normal Touchdown Attitude

The following figures illustrate the effect of airspeed on body attitude at touchdown. It shows airplane attitude at a normal touchdown speed for flaps 25 and flaps 30 (VREF to VREF - 5 knots). The illustration also shows that touchdown at a speed below normal touchdown speed, in this case VREF - 10 knots, seriously reduces aft fuselage-runway clearance.

Conditions

- Forward CG limit
- Sea level standard day
- -150 fpm sink rate at touchdown

777 Flight Crew Training Manual

Touchdown Body Attitudes - Kilograms

777-200

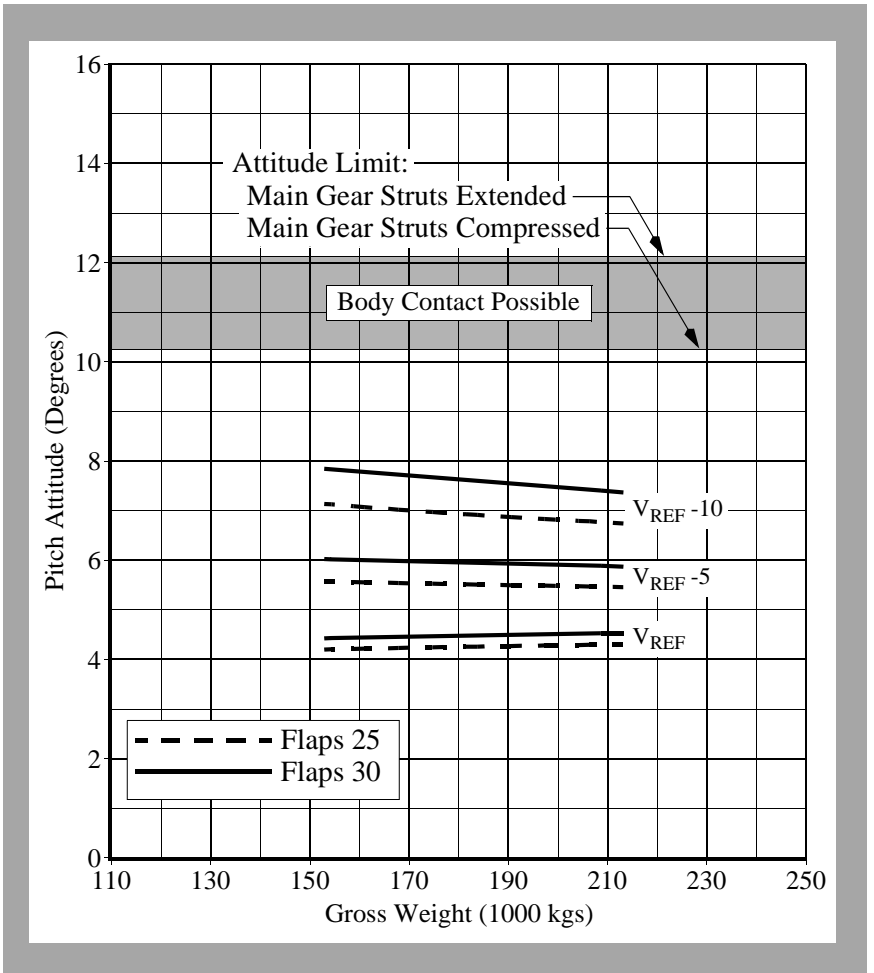

Touchdown Body Attitudes - Kilograms

777-200LR

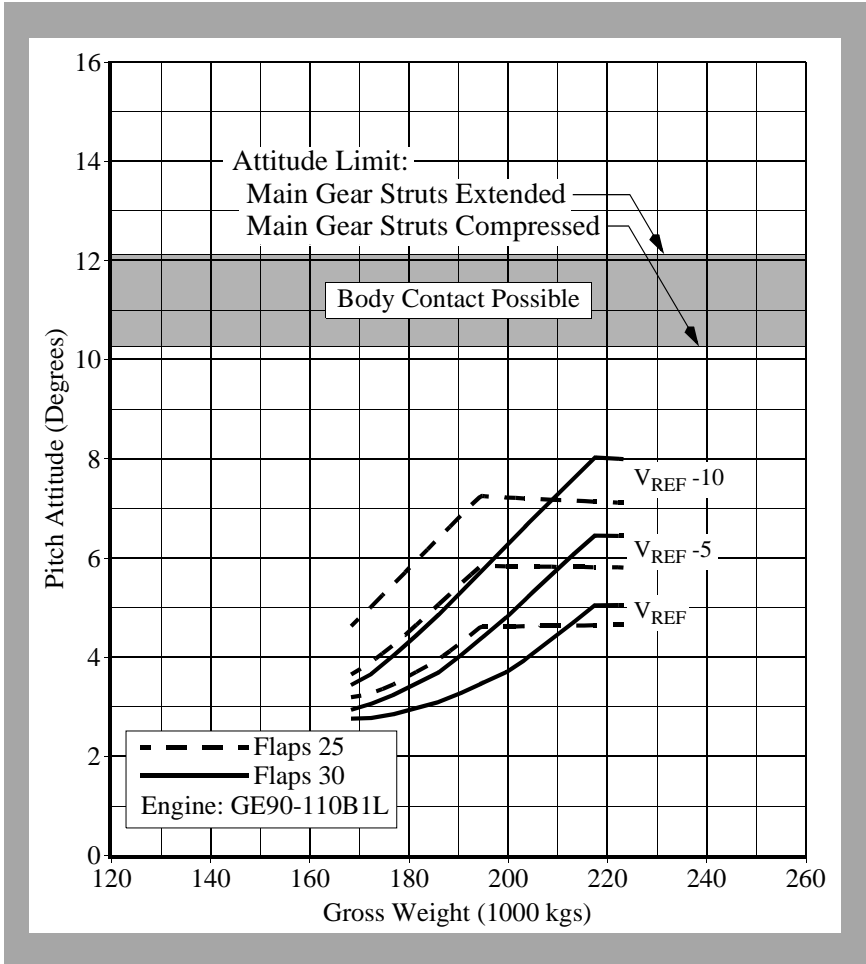

777 Flight Crew Training Manual

Touchdown Body Attitudes - Kilograms

777-300

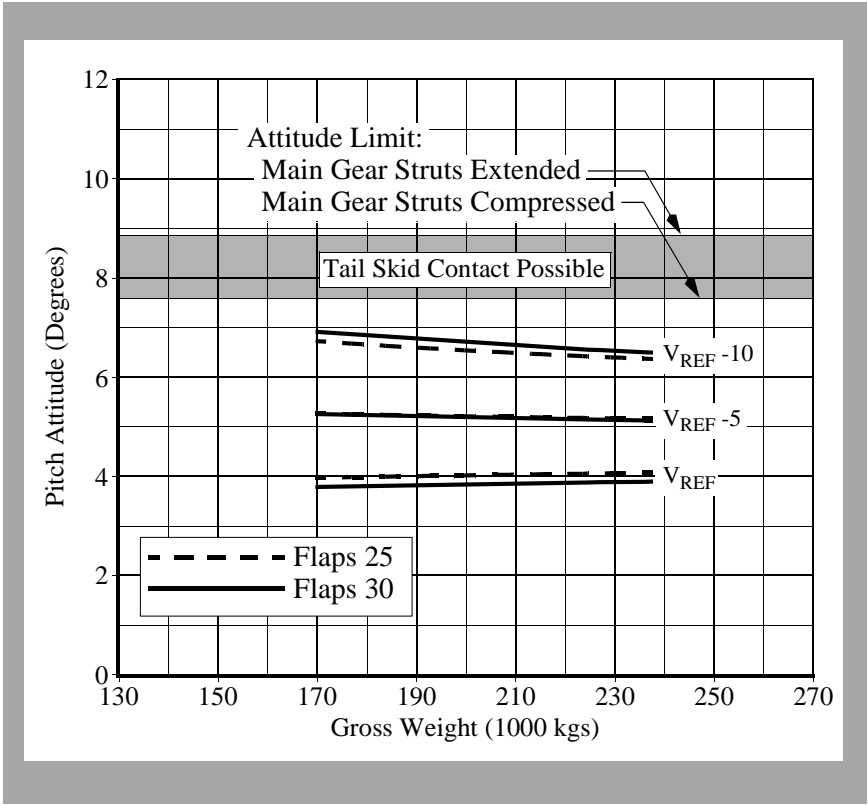

Touchdown Body Attitudes - Kilograms

777-300ER

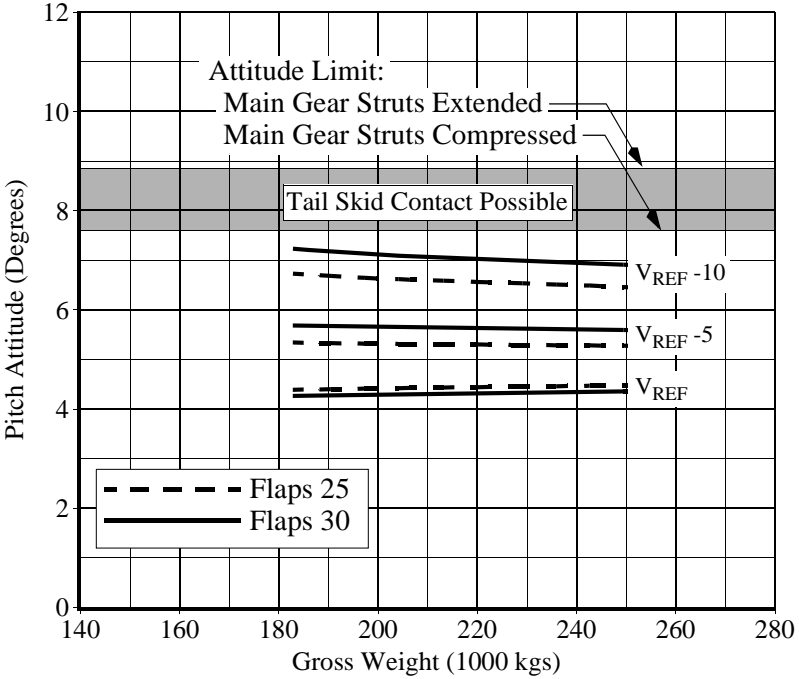

777 Flight Crew Training Manual

Touchdown Body Attitudes - Pounds

777-200

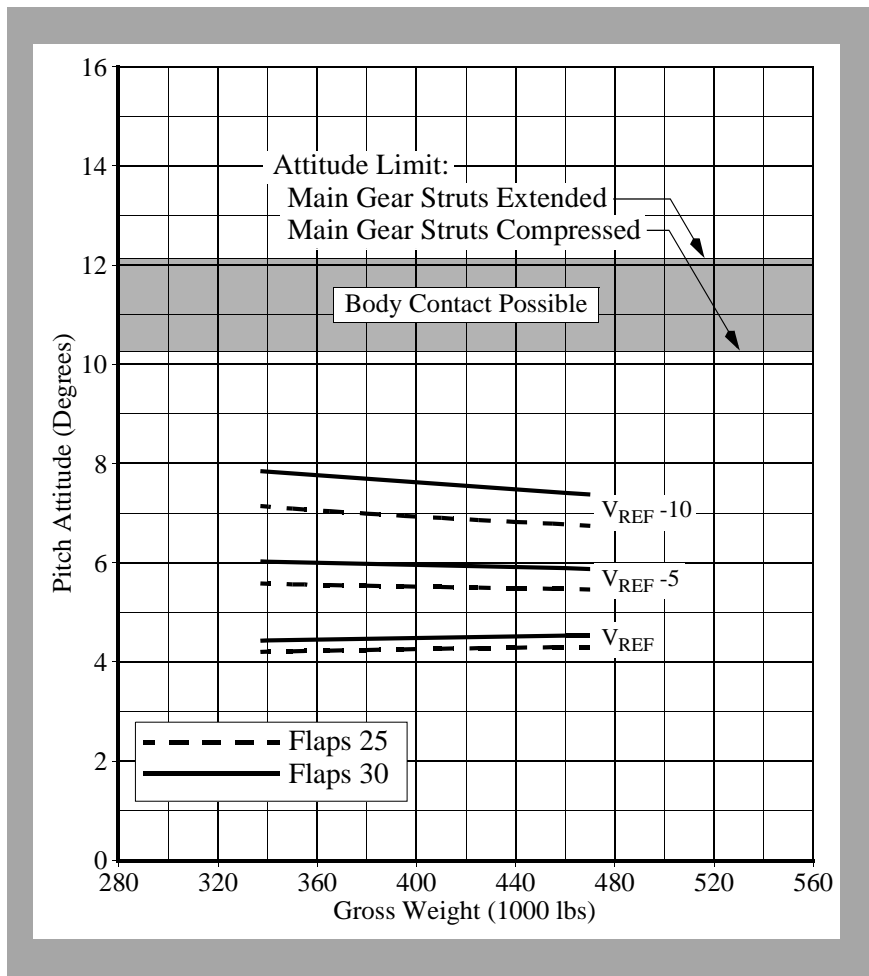

Touchdown Body Attitudes - Pounds

777-200LR

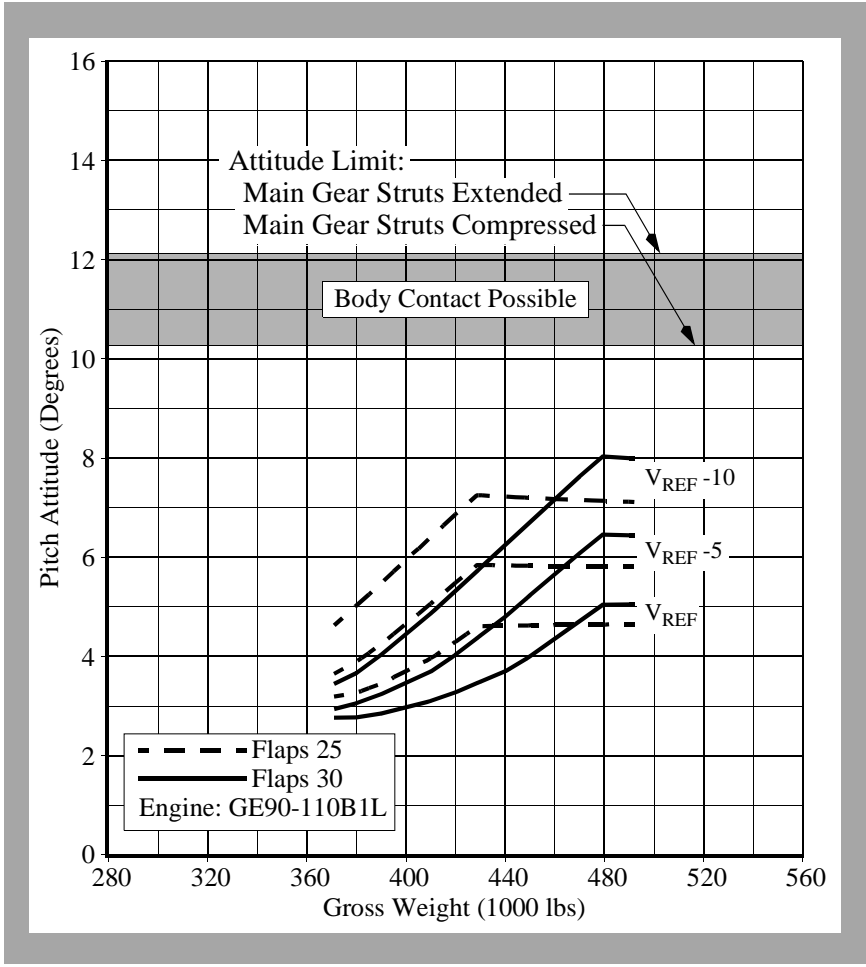

777 Flight Crew Training Manual

Touchdown Body Attitudes - Pounds

777-300

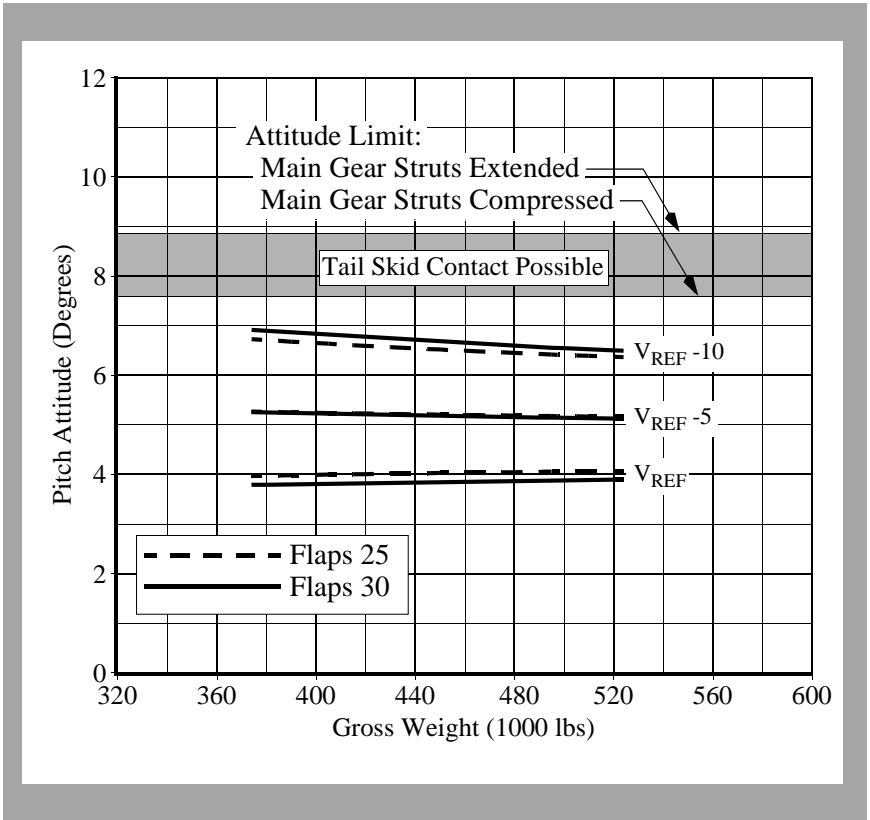

Touchdown Body Attitudes - Pounds

777-300ER

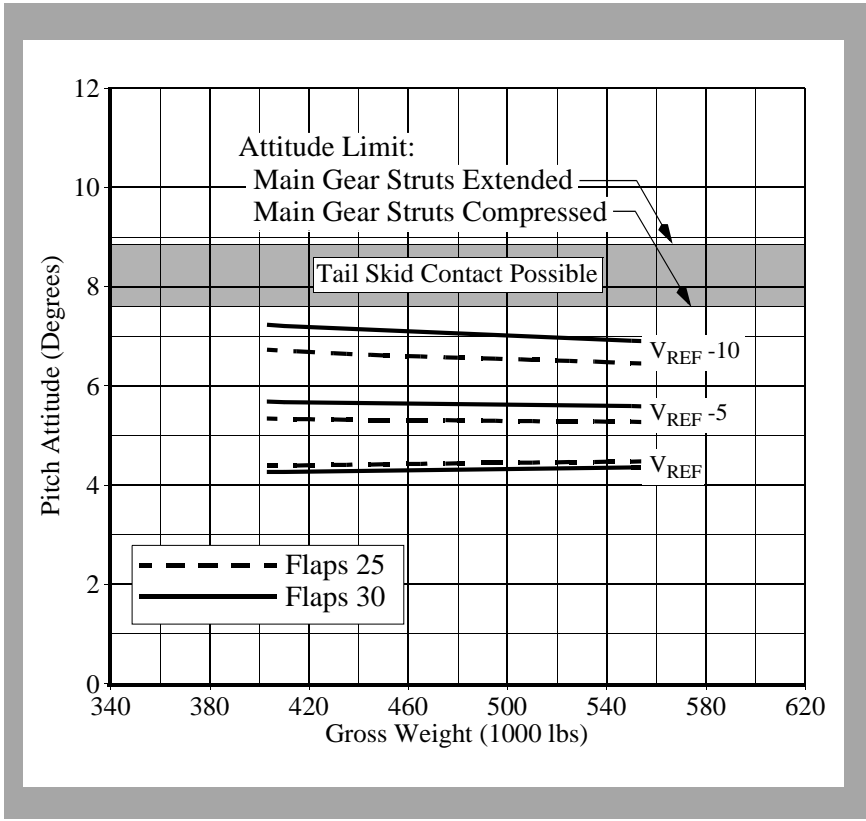



777 Flight Crew Training Manual



Pitch and Roll Limit Conditions

The Ground Contact Angles - Normal Landing figures illustrate body roll angle/pitch angles at which the airplane structure contacts the runway. Prolonged flare increases the body pitch attitude 2° to 3° . When prolonged flare is coupled with a misjudged height above the runway aft body contact is possible.

Fly the airplane onto the runway at the desired touchdown point and at the desired airspeed. Do not hold it off and risk the possibility of a tail strike.

Note: A smooth touchdown is not the criterion for a safe landing.

Conditions

- Pitch about main gear centerline
- Roll about main gear outside tire
- Struts fully compressed
- Valid for all flap detents
- Valid for all control surface positions

777 Flight Crew Training Manual

Ground Contact Angles - Normal Landing

777-200

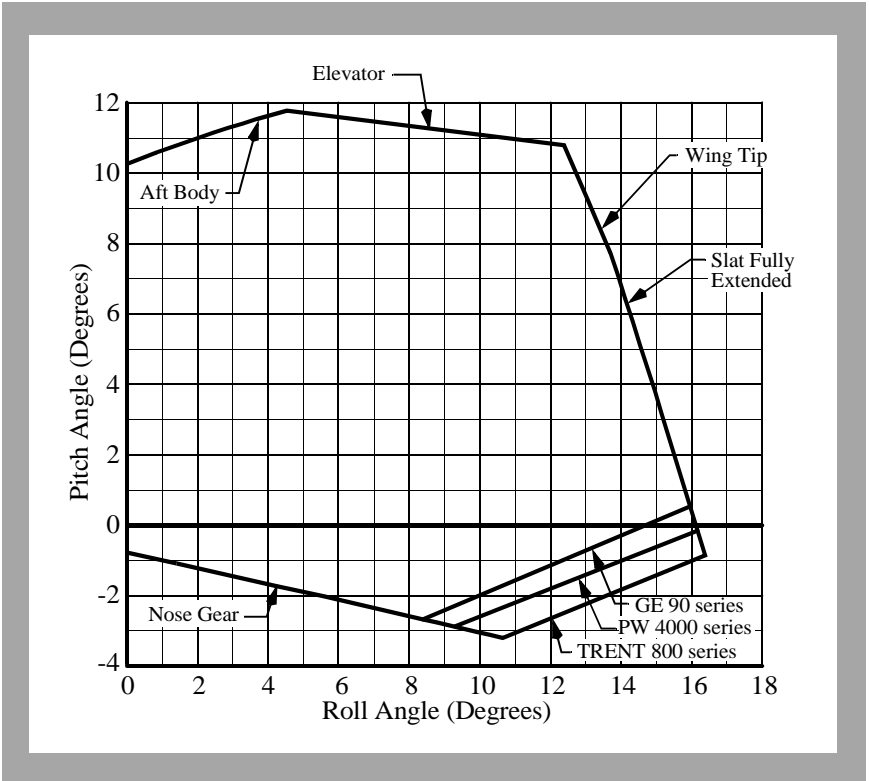

Ground Contact Angles - Normal Landing

777-200LR

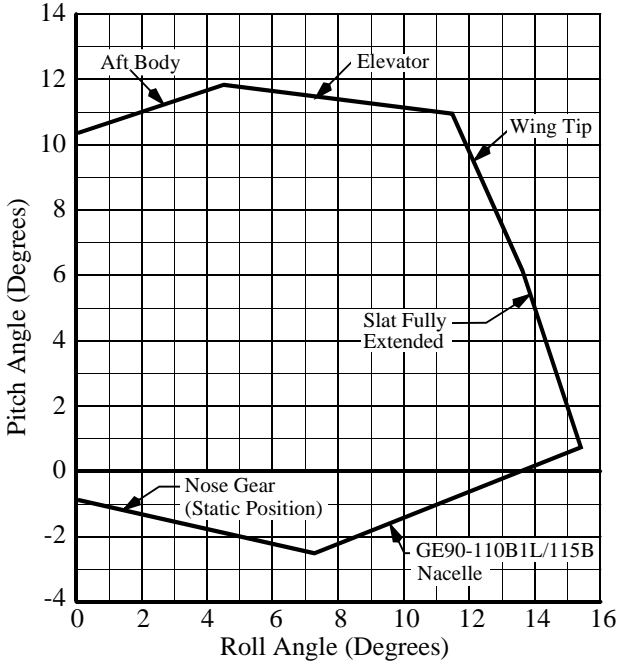

777 Flight Crew Training Manual

Ground Contact Angles - Normal Landing

777-300

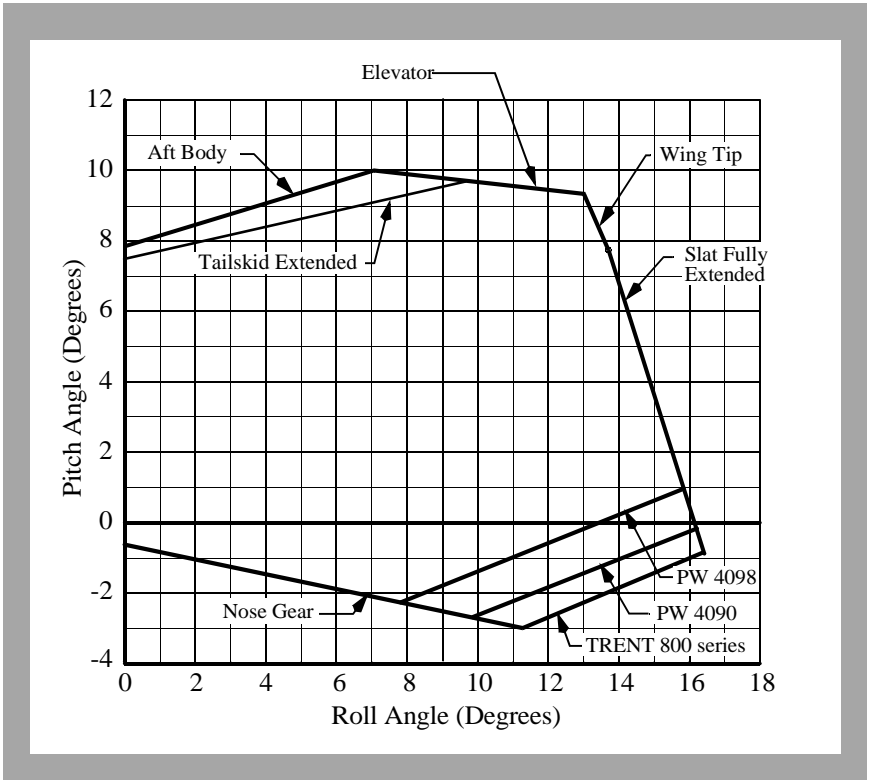

Ground Contact Angles - Normal Landing

777-300ER

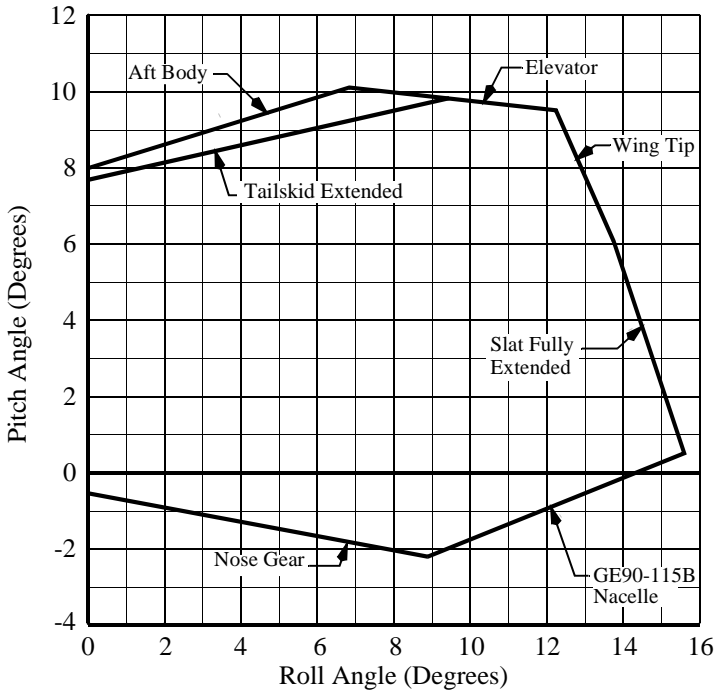

Bounced Landing Recovery

If the airplane should bounce, hold or re-establish a normal landing attitude and add thrust as necessary to control the rate of descent. Thrust need not be added for a shallow bounce or skip. When a high, hard bounce occurs, initiate a go-around. Apply go-around thrust and use normal go-around procedures. Do not retract the landing gear until a positive rate of climb is established because a second touchdown may occur during the go-around.

If higher than idle thrust is maintained through initial touchdown, the automatic speedbrake deployment may be disabled even when the speedbrakes are armed. This can result in a bounced landing.

If the speedbrakes started to extend on the initial touchdown, they will retract once the airplane becomes airborne again on a bounce, even if thrust is not increased. The speedbrakes must then be manually extended after the airplane returns to the runway.

Rejected Landing

A rejected landing maneuver is trained and evaluated by some operators and regulatory agencies. Although the FCOM/QRH does not contain a procedure or maneuver titled Rejected Landing, the requirements of this maneuver can be accomplished by doing the Go-Around Procedure if it is initiated before touchdown. Refer to Chapter 5, Go-Around after Touchdown, for more information on this subject.

Landing Roll

Avoid touching down with thrust above idle since this may establish an airplane nose up pitch tendency and increases landing roll.

After main gear touchdown, initiate the landing roll procedure. If the speedbrakes do not extend automatically move the speedbrake lever to the UP position without delay. Fly the nose wheels smoothly onto the runway without delay. Control column movement forward of neutral should not be required. Do not attempt to hold the nose wheels off the runway. Holding the nose up after touchdown for aerodynamic braking is not an effective braking technique and may result in high nose gear sink rates upon brake application.

To avoid possible airplane structural damage, do not make large nose down control column movements before the nose wheels are lowered to the runway.

To avoid the risk of a tail strike, do not allow the pitch attitude to increase after touchdown. However, applying excessive nose down elevator during landing can result in substantial forward fuselage damage. Do not use full down elevator. Use an appropriate autobrake setting or manually apply wheel brakes smoothly with steadily increasing pedal pressure as required for runway condition and runway length available. Maintain deceleration rate with constant or increasing brake pressure as required until stopped or desired taxi speed is reached.

Speedbrakes

The speedbrakes can be fully raised after touchdown while the nose wheels are lowered to the runway, with no adverse pitch effects. The speedbrakes spoil the lift from the wings, which places the airplane weight on the main landing gear, providing excellent brake effectiveness.

Unless speedbrakes are raised after touchdown, braking effectiveness may be reduced initially as much as 60%, since very little weight is on the wheels and brake application may cause rapid antiskid modulation.

Normally, speedbrakes are armed to extend automatically. Both pilots should monitor speedbrake extension after touchdown. In the event auto extension fails, the speedbrake should be manually extended immediately.

Pilot awareness of the position of the speedbrake lever during the landing phase is important in the prevention of over-run. The position of the speedbrakes should be announced during the landing phase by the PM. This improves the crew's situational awareness of the position of the spoilers during landing and builds good habit patterns which can prevent failure to observe a malfunctioned or disarmed spoiler system.

777 Flight Crew Training Manual

Directional Control and Braking during Landing Roll

If the nose wheels are not promptly lowered to the runway, braking and steering capabilities are significantly degraded and no drag benefit is gained. Rudder control is effective to approximately 60 knots. Rudder pedal steering is sufficient for maintaining directional control during the rollout. Do not use the nose wheel steering tiller until reaching taxi speed. In a crosswind, displace the control wheel into the wind to maintain wings level which aids directional control. Perform the landing roll procedure immediately after touchdown. Any delay markedly increases the stopping distance.

Stopping distance varies with wind conditions and any deviation from recommended approach speeds.

Factors Affecting Landing Distance

Advisory information for normal and non-normal configuration landing distances is contained in the PI section of the QRH. Actual stopping distances for a maximum effort stop are approximately 60% of the dry runway field length requirement. Factors that affect stopping distance include: height and speed over the threshold, glide slope angle, landing flare, lowering the nose to the runway, use of reverse thrust, speedbrakes, wheel brakes and surface conditions of the runway.

Note: Reverse thrust and speedbrake drag are most effective during the high speed portion of the landing. Deploy the speedbrake lever and activate reverse thrust with as little time delay as possible.

Note: Speedbrakes fully deployed, in conjunction with maximum reverse thrust and maximum manual antiskid braking provides the minimum stopping distance.

Floating above the runway before touchdown must be avoided because it uses a large portion of the available runway. The airplane should be landed as near the normal touchdown point as possible. Deceleration rate on the runway is approximately three times greater than in the air.

Height of the airplane over the runway threshold also has a significant effect on total landing distance. For example, on a 3° glide path, passing over the runway threshold at 100 feet altitude rather than 50 feet could increase the total landing distance by approximately 950 feet. This is due to the length of runway used up before the airplane actually touches down.

Glide path angle also affects total landing distance. As the approach path becomes flatter, even while maintaining proper height over the end of the runway, total landing distance is increased.

Non-Normal Landing Distance

Because of the higher approach speeds and the possible degraded capability of deceleration devices (spoiler, brakes, reversers) associated with the non-normal landing condition, the actual landing distance is increased. The Non-Normal Configuration Landing Distance table in the PI chapter of the QRH shows VREF and landing distances for various non-normal landing configurations and runway conditions.

Slippery Runway Landing Performance

[Appendix A.2.7](#)

When landing on slippery runways contaminated with ice, snow, slush or standing water, the reported braking action must be considered. Advisory information for reported braking actions of good, medium and poor is contained in the PI section of the QRH. The performance level associated with good is representative of a wet runway. The performance level associated with poor is representative of a wet ice covered runway. Also provided in the QRH are stopping distances for the various autobrake settings and for non-normal configurations. Pilots should use extreme caution to ensure adequate runway length is available when poor braking action is reported.

Pilots should keep in mind slippery/contaminated runway advisory information is based on an assumption of uniform conditions over the entire runway. This means a uniform depth for slush/standing water for a contaminated runway or a fixed braking coefficient for a slippery runway. The data cannot cover all possible slippery/contaminated runway combinations and does not consider factors such as rubber deposits or heavily painted surfaces near the end of most runways.

One of the commonly used runway descriptors is coefficient of friction. Ground friction measuring vehicles typically measure this coefficient of friction. Much work has been done in the aviation industry to correlate the friction reading from these ground friction measuring vehicles to airplane performance. Use of ground friction vehicles raises the following concerns:

- the measured coefficient of friction depends on the type of ground friction measuring vehicle used. There is not a method, accepted worldwide, for correlating the friction measurements from the different friction measuring vehicles to each other, or to the airplane's braking capability.
- most testing to date, which compares ground friction vehicle performance to airplane performance, has been done at relatively low speeds (100 knots or less). The critical part of the airplane's deceleration characteristics is typically at higher speeds (120 to 150 knots).

777 Flight Crew Training Manual

- ground friction vehicles often provide unreliable readings when measurements are taken with standing water, slush or snow on the runway. Ground friction vehicles might not hydroplane (aquaplane) when taking a measurement while the airplane may hydroplane (aquaplane). In this case, the ground friction vehicles would provide an optimistic reading of the runway's friction capability. The other possibility is the ground friction vehicles might hydroplane (aquaplane) when the airplane would not, this would provide an overly pessimistic reading of the runway's friction capability. Accordingly, friction readings from the ground friction vehicles may not be representative of the airplane's capability in hydroplaning conditions.
- ground friction vehicles measure the friction of the runway at a specific time and location. The actual runway coefficient of friction may change with changing atmospheric conditions such as temperature variations, precipitation etc. Also, the runway condition changes as more operations are performed.

The friction readings from ground friction measuring vehicles do supply an additional piece of information for the pilot to evaluate when considering runway conditions for landing. Crews should evaluate these readings in conjunction with the PIREPS (pilot reports) and the physical description of the runway (snow, slush, ice etc.) when planning the landing. Special care should be taken in evaluating all the information available when braking action is reported as POOR or if slush/standing water is present on the runway.

Factors Affecting Landing Distance (Typical)

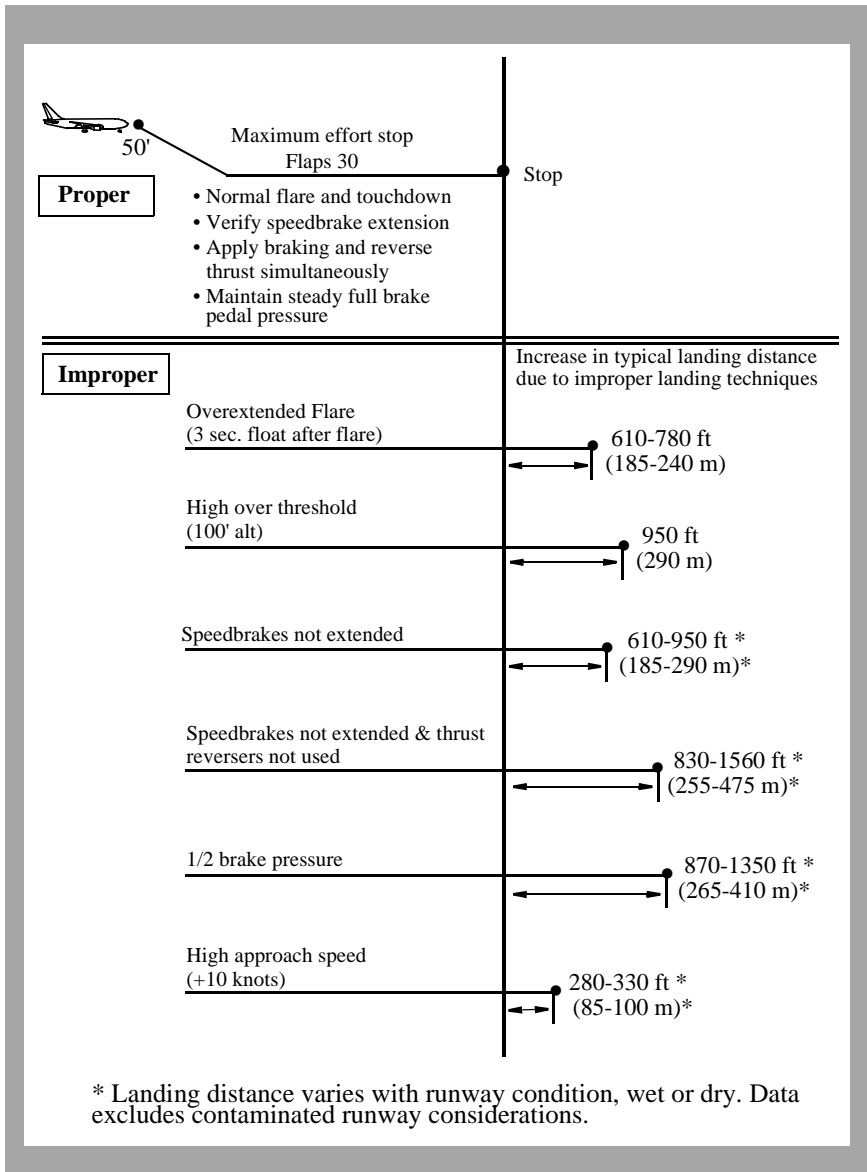

Wheel Brakes

Braking force is proportional to the force of the tires on the runway and the coefficient of friction between the tires and the runway. The contact area normally changes little during the braking cycle. The perpendicular force comes from airplane weight and any downward aerodynamic force such as speedbrakes.

The coefficient of friction depends on the tire condition and runway surface, (e.g. concrete, asphalt, dry, wet or icy).

Automatic Brakes

Use of the autobrake system is recommended whenever the runway is limited, when using higher than normal approach speeds, landing on slippery runways, or landing in a crosswind.

For normal operation of the autobrake system select a deceleration setting.

Settings include:

- **MAX AUTO:** Used when minimum stopping distance is required. Deceleration rate is less than that produced by full manual braking
- **3 or 4:** Should be used for wet or slippery runways or when landing rollout distance is limited
- **1 or 2:** These settings provide a moderate deceleration suitable for all routine operations.

Experience with various runway conditions and the related airplane handling characteristics provide initial guidance for the level of deceleration to be selected.

Immediate initiation of reverse thrust at main gear touchdown and full reverse thrust allow the autobrake system to reduce brake pressure to the minimum level. Since the autobrake system senses deceleration and modulates brake pressure accordingly, the proper application of reverse thrust results in reduced braking for a large portion of the landing roll.

The importance of establishing the desired reverse thrust level as soon as possible after touchdown cannot be overemphasized. This minimizes brake temperatures and tire and brake wear and reduces stopping distance on very slippery runways.

The use of minimum reverse thrust as compared to maximum reverse thrust can double the brake energy requirements and result in brake temperatures much higher than normal.

After touchdown, crewmembers should be alert for autobrake disengagement annunciations. The PM should notify the PF anytime the autobrakes disengage.

If stopping distance is not assured with autobrakes engaged, the PF should immediately apply manual braking sufficient to assure deceleration to a safe taxi speed within the remaining runway.

A table in the PI section of the QRH shows the relative stopping capabilities of the available autobrake selections.

Transition to Manual Braking

The speed at which the transition from autobrakes to manual braking is made depends on airplane deceleration rate, runway conditions and stopping requirements. Normally the speedbrakes remain deployed until taxi speed, but may be stowed earlier if stopping distance within the remaining runway is assured. When transitioning to manual braking, use reverse thrust as required until taxi speed. The use of speedbrakes and reverse thrust is especially important when nearing the end of the runway where rubber deposits affect stopping ability.

When transitioning from the autobrake system to manual braking, the PF should notify the PM. Techniques for release of autobrakes can affect passenger comfort and stopping distance. These techniques are:

- stow the speedbrake handle. When stopping distance within the remaining runway is assured, this method provides a smooth transition to manual braking, is effective before or after thrust reversers are stowed, and is less dependent on manual braking technique
- smoothly apply brake pedal force as in a normal stop, until the autobrake system disarms. Following disarming of the autobrakes, smoothly release brake pedal pressure. Disarming the autobrakes before coming out of reverse thrust provides a smooth transition to manual braking
- manually position the autobrake selector off (normally done by the PM at the direction of the PF).

Manual Braking

The following technique for manual braking provides optimum braking for all runway conditions:

The pilot's seat and rudder pedals should be adjusted so that it is possible to apply maximum braking with full rudder deflection.

Immediately after main gear touchdown, smoothly apply a constant brake pedal pressure for the desired braking. For short or slippery runways, use full brake pedal pressure.

- do not attempt to modulate, pump or improve the braking by any other special techniques
- do not release the brake pedal pressure until the airplane speed has been reduced to a safe taxi speed
- the antiskid system stops the airplane for all runway conditions in a shorter distance than is possible with either antiskid off or brake pedal modulation.

777 Flight Crew Training Manual

The antiskid system adapts pilot applied brake pressure to runway conditions by sensing an impending skid condition and adjusting the brake pressure to each individual wheel for maximum braking. When brakes are applied on a slippery runway, several skid cycles occur before the antiskid system establishes the right amount of brake pressure for the most effective braking.

If the pilot modulates the brake pedals, the antiskid system is forced to readjust the brake pressure to establish optimum braking. During this readjustment time, braking efficiency is lost.

Low available braking coefficient of friction on extremely slippery runways at high speeds may be interpreted as a total antiskid failure. Pumping the brakes degrades braking effectiveness. Maintain steadily increasing brake pressure, allowing the antiskid system to function at its optimum.

Although immediate braking is desired, manual braking techniques normally involve a four to five second delay between main gear touchdown and brake pedal application even when actual conditions reflect the need for a more rapid initiation of braking. This delayed braking can result in the loss of 800 to 1,000 feet of runway. Directional control requirements for crosswind conditions and low visibility may further increase the delays. Distractions arising from a malfunctioning reverser system can also result in delayed manual braking application.

Braking with Antiskid Inoperative

When the antiskid system is inoperative, the following techniques apply:

- ensure that the nose wheels are on the ground and the speedbrakes are extended before applying the brakes
- initiate wheel braking using very light pedal pressure and increase pressure as ground speed decreases
- apply steady pressure and **DO NOT PUMP** the pedals.

Antiskid-off braking requires even greater care during lightweight landings.

Carbon Brake Life

Brake wear is primarily dependent upon the number of brake applications. For example, one firm brake application causes less wear than several light applications. Continuous light applications of the brakes to keep the airplane from accelerating over a long period of time (riding the brakes) to maintain a constant taxi speed produces more wear than proper brake application.

During taxi, proper braking should involve applying brakes to decelerate the airplane, releasing the brakes when the lower speed is attained and allowing the airplane to accelerate, then repeating.

During landing, one hard, high energy, long-duration brake application produces the same amount of wear as a light, low-energy, short application. This is different from steel brakes that wear as a function of the energy input during the stop.

For normal landing conditions, autobrakes 2 or 3 optimizes brake wear, passenger comfort, and stopping performance. Since autobrake settings apply the brakes dependant upon the deceleration rate, an autobrake setting of 1 results in a higher probability that the autobrakes will modulate, especially when the reversers are used. Autobrakes 2 or 3 results in a continuous brake application, which can increase carbon brake life.

Brake Cooling

A series of taxi-back or stop and go landings without additional in-flight brake cooling can cause excessive brake temperatures. The energy absorbed by the brakes from each landing is cumulative.

Extending the gear a few minutes early in the approach normally provides sufficient cooling for a landing. Total in-flight cooling time can be determined from the Performance Inflight section of the QRH.

The brake temperature monitoring system may be used for additional flight crew guidance in assessing brake energy absorption. This system indicates a stabilized value approximately fifteen minutes after brake energy absorption. Therefore, an immediate or reliable indication of tire or hydraulic fluid fire, wheel bearing problems, or wheel fracture is not available. The brake temperature monitor readings may vary between brakes during normal braking operations.

Note: Brake energy data provided in the QRH should be used to identify potential overheating situations.

Close adherence to recommended landing roll procedures ensures minimum brake temperature build up.

Minimum Brake Heating

Consider using the following technique if landing overweight or other factors exist that may lead to excessive brake temperatures. A normal landing, at weights up to maximum landing weight, does not require special landing techniques.

Note: Autolands are not recommended for overweight landings.

To minimize brake temperature build-up, use the following landing techniques:

- do the overweight landing checklist (as needed)
- select the longest runway available but avoid landing downwind
- use the largest available landing flap setting

777 Flight Crew Training Manual

- use an autobrake setting, consistent with reported runway conditions, that will result in the use of all available runway length. A stopping distance safety margin should be used in accordance with airline policy. Although the autobrakes initially increase brake temperature, the brake contribution is minimized after reverser deployment
- use autothrottles to avoid having to use a wind additive in excess of VREF + 5 knots
- ensure all of the headwind correction is bled off before touchdown to avoid landing with excessive airspeed
- use a normal gear touchdown aim point
- do not allow the airplane to float
- ensure the spoilers deploy immediately after touchdown
- select maximum reverse thrust as soon as possible after main gear touchdown. Do not wait for nose wheel touchdown. The intention is to use reverse thrust as the major force that stops the airplane. The use of maximum reverse thrust further minimizes brake heating
- as soon as stopping is assured in the remaining runway, turn the autobrakes off and continue slowing the airplane with reverse thrust
- if stopping in the remaining runway is in doubt, continue use of autobrakes or take over manually and apply up to maximum braking as needed
- consider extending the landing gear early to provide maximum brake cooling as needed.

Reverse Thrust Operation

Awareness of the position of the forward and reverse thrust levers must be maintained during the landing phase. Improper seat position as well as long sleeved apparel may cause inadvertent advancement of the forward thrust levers, preventing movement of the reverse thrust levers.

The position of the hand should be comfortable, permit easy access to the autothrottle disconnect switch, and allow control of all thrust levers, forward and reverse, through full range of motion.

Note: Reverse thrust is most effective at high speeds.

After touchdown, with the thrust levers at idle, rapidly raise the reverse thrust levers up and aft to the interlock position, then apply reverse thrust as required. The PM should monitor engine operating limits and call out any engine operational limits being approached or exceeded, any thrust reverser failure, or any other abnormalities.

**777 Flight Crew Training Manual**

Maintain reverse thrust as required, up to maximum, until the airspeed approaches 60 knots. At this point start reducing the reverse thrust so that the reverse thrust levers are moving down at a rate commensurate with the deceleration rate of the airplane. The thrust levers should be positioned to reverse idle by taxi speed, then to full down after the engines have decelerated to idle. Reverse thrust is reduced to idle between 60 knots and taxi speed to prevent engine exhaust re-ingestion and to reduce the risk of FOD. It also helps the pilot maintain directional control in the event a reverser becomes inoperative.

Note: If an engine surges during reverse thrust operation, quickly select reverse idle on both engines.

The PM should call out 60 knots to assist the PF in scheduling the reverse thrust. The PM should also call out any inadvertent selection of forward thrust as reverse thrust is cancelled.

777 Flight Crew Training Manual

Reverse Thrust Operations

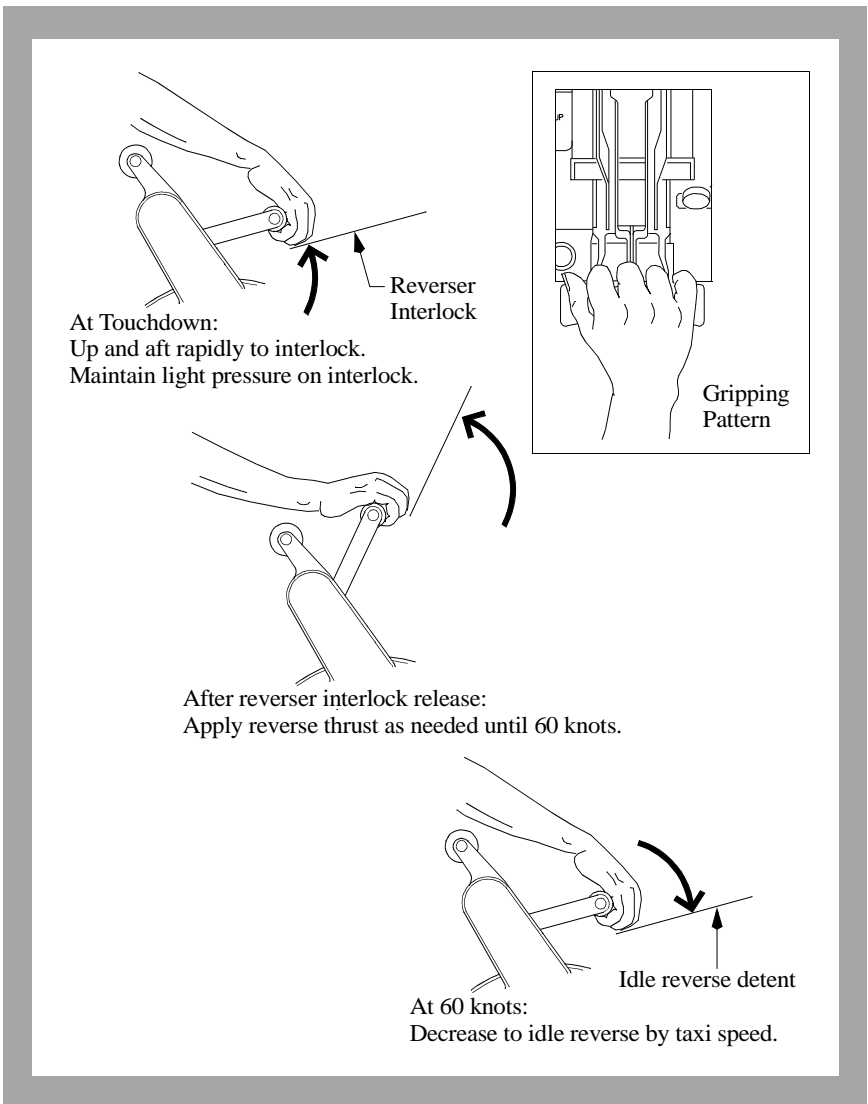

Reverse Thrust and Crosswind (All Engines)

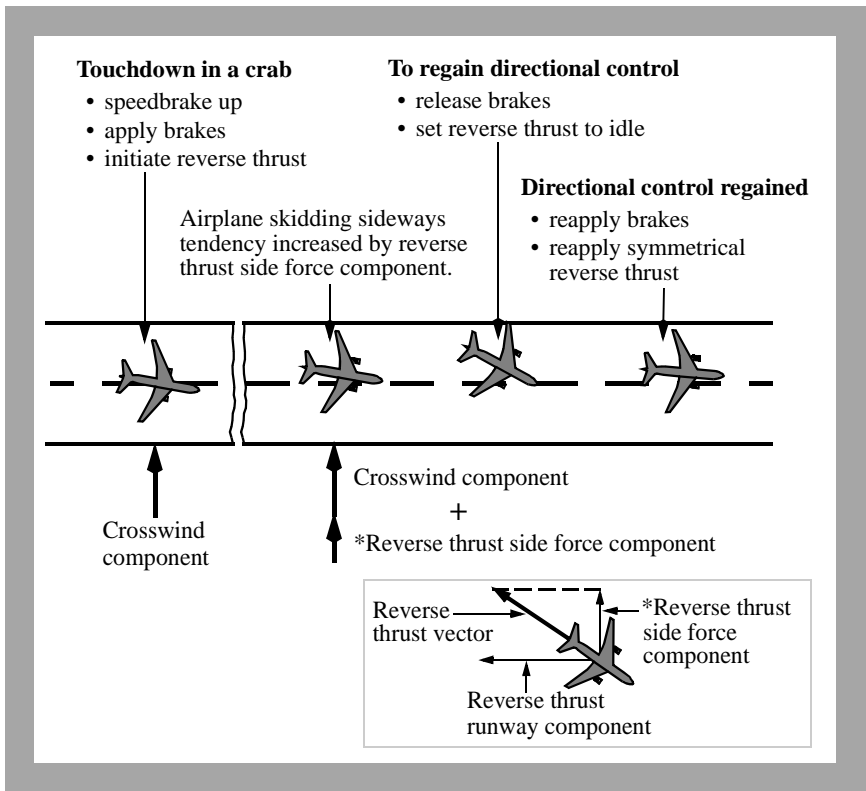

This figure shows a directional control problem during a landing rollout on a slippery runway with a crosswind. As the airplane starts to weathervane into the wind, the reverse thrust side force component adds to the crosswind component and drifts the airplane to the downwind side of the runway. Also, high braking forces reduce the capability of the tires to corner.

To correct back to the centerline, release the brakes and reduce reverse thrust to reverse idle. Releasing the brakes increases the tire-cornering capability and contributes to maintaining or regaining directional control. Setting reverse idle reduces the reverse thrust side force component without the requirement to go through a full reverser actuation cycle. Use rudder pedal steering and differential braking as required, to prevent over correcting past the runway centerline. When directional control is regained and the airplane is correcting toward the runway centerline, apply maximum braking and symmetrical reverse thrust to stop the airplane.

Note: Use of this technique increases the required landing distance.



777 Flight Crew Training Manual

Reverse Thrust - EEC in the Alternate Mode

Use normal reverse thrust techniques.

Reverse Thrust - Engine Inoperative

Asymmetrical reverse thrust may be used with one engine inoperative. Use normal reverse thrust procedures and techniques with the operating engine. If directional control becomes a problem during deceleration, return the thrust lever to the reverse idle detent.

Note: TAC does not operate during reverse thrust operation.

Crosswind Landings

The crosswind guidelines shown below were derived through flight test data, engineering analysis and flight simulator evaluations. These crosswind guidelines are based on steady wind (no gust) conditions and include all engines operating and engine inoperative. Gust effects were evaluated and tend to increase pilot workload without significantly affecting the recommended guidelines.

Landing Crosswind Guidelines

[Appendix A.2.7](#)

Crosswind guidelines are not considered limitations. Crosswind guidelines are provided to assist operators in establishing their own crosswind policies.

On slippery runways, crosswind guidelines are a function of runway surface condition. These guidelines assume adverse airplane loading and proper pilot technique.

Runway Condition	Crosswind Component (knots) *
Dry	45 ***
Wet	40 ***
Standing Water/Slush	20
Snow - No Melting **	35 ***
Ice - No Melting **	17

Note: Reduce crosswind guidelines by 5 knots on wet or contaminated runways whenever asymmetric reverse thrust is used.

*Winds measured at 33 feet (10 m) tower height and apply for runways 148 feet (45m) or greater in width.

** Landing on untreated ice or snow should only be attempted when no melting is present.

*** Sideslip only (zero crab) landings are not recommended with crosswind components in excess of 31 knots for 777-200 series and 777 Freighter airplanes or 35 knots for 777-300 series airplanes. This recommendation ensures adequate ground clearance and is based on maintaining adequate control margin.

Crosswind Landing Techniques

Three methods of performing crosswind landings are presented. They are the de-crab technique (with removal of crab in flare), touchdown in a crab, and the sideslip technique. Whenever a crab is maintained during a crosswind approach, offset the flight deck on the upwind side of centerline so that the main gear touches down in the center of the runway.

De-Crab During Flare

The objective of this technique is to maintain wings level throughout the approach, flare, and touchdown. On final approach, a crab angle is established with wings level to maintain the desired track. Just prior to touchdown while flaring the airplane, downwind rudder is applied to eliminate the crab and align the airplane with the runway centerline.

As rudder is applied, the upwind wing sweeps forward developing roll. Hold wings level with simultaneous application of aileron control into the wind. The touchdown is made with cross controls and both gear touching down simultaneously. Throughout the touchdown phase upwind aileron application is utilized to keep the wings level.

Touchdown In Crab

The airplane can land using crab only (zero sideslip) up to the landing crosswind guideline speeds. (See the landing crosswind guidelines table, this chapter).

On dry runways, upon touchdown the airplane tracks toward the upwind edge of the runway while de-crabbing to align with the runway. Immediate upwind aileron is needed to ensure the wings remain level while rudder is needed to track the runway centerline. The greater the amount of crab at touchdown, the larger the lateral deviation from the point of touchdown. For this reason, touchdown in a crab only condition is not recommended when landing on a dry runway in strong crosswinds.

On very slippery runways, landing the airplane using crab only reduces drift toward the downwind side at touchdown, permits rapid operation of spoilers and autobrakes because all main gears touchdown simultaneously, and may reduce pilot workload since the airplane does not have to be de-crabbed before touchdown. However, proper rudder and upwind aileron must be applied after touchdown to ensure directional control is maintained.

777 Flight Crew Training Manual

Sideslip (Wing Low)

The sideslip crosswind technique aligns the airplane with the extended runway centerline so that main gear touchdown occurs on the runway centerline.

The initial phase of the approach to landing is flown using the crab method to correct for drift. Prior to the flare the airplane centerline is aligned on or parallel to the runway centerline. Downwind rudder is used to align the longitudinal axis to the desired track as aileron is used to lower the wing into the wind to prevent drift. A steady sideslip is established with opposite rudder and low wing into the wind to hold the desired course.

Touchdown is accomplished with the upwind wheels touching just before the downwind wheels. Overcontrolling the roll axis must be avoided because overbanking could cause the engine nacelle or outboard wing flap to contact the runway. (See Ground Clearance Angles - Normal Landing charts, this chapter.)

Properly coordinated, this maneuver results in nearly fixed rudder and aileron control positions during the final phase of the approach, touchdown, and beginning of the landing roll. However, since turbulence is often associated with crosswinds, it is often difficult to maintain the cross control coordination through the final phase of the approach to touchdown.

If the crew elects to fly the sideslip to touchdown, it may be necessary to add a crab during strong crosswinds. (See the landing crosswind guidelines table, this chapter). Main gear touchdown is made with the upwind wing low and crab angle applied. As the upwind gear touches first, a slight increase in downwind rudder is applied to align the airplane with the runway centerline. At touchdown, increased application of upwind aileron should be applied to maintain wings level.

Overweight Landing

Accomplish the Overweight Landing NNC.

Overweight landings may be safely accomplished by using normal landing procedures and techniques. There are no adverse handling characteristics associated with overweight landings. Landing distance is normally less than takeoff distance for flaps 20, 25, or 30 landings at all gross weights. However, wet or slippery runway field length requirements should be verified from the landing distance charts in the PI Chapter of the QRH. Brake energy limits will not be exceeded under any normal or non-normal landing conditions.

The Overweight Landing NNC includes a check of landing weight against the landing climb limit weight. Guidance is provided to use flaps 20 for landing when the landing weight is greater than the landing climb limited weight or one engine is inoperative. If the landing weight is less than the landing climb limited weight but above the maximum landing weight and both engines are operative, an additional landing approach speed check must be made. This landing approach speed check is required to ensure that there is at least a 10 knot margin between the flaps 30 landing approach speed (VREF 30 plus additives for wind and gusts) and the flaps 30 placard speed. If a 10 knot margin exists, then flaps 30 is the recommended landing flap. However, if a 10 knot margin does not exist, then flaps 25 is the recommended landing flap and VREF 25 plus additives for wind and gusts is the recommended landing approach speed. Refer to the Overweight Landing NNC for the actual landing approach speed limits.

If stopping distance is a concern, reduce the landing weight as much as possible. At the captain's discretion, consider fuel jettison or reduce weight by holding at low altitude with a high drag configuration (gear down) to achieve maximum fuel burn-off.

Observe flap placard speeds during flap extension and on final approach. In the holding and approach patterns, maneuvers should be flown at the normal maneuver speeds. During flap extension, airspeed can be reduced by as much as 20 knots below normal maneuver speeds before extending to the next flap position. These lower speeds result in larger margins to the flap placards, while still providing normal bank angle maneuvering capability, but do not allow for a 15° overshoot margin in all cases.

Use the longest available runway, and consider wind and slope effects. Where possible avoid landing in tailwinds, on runways with negative slope, or on runways with less than normal braking conditions. Do not carry excess airspeed on final. This is especially important when landing during an engine inoperative or other non-normal condition. At weights above the maximum landing weight, the final approach maximum wind additive may be limited by the flap placards and load relief system.

Fly a normal profile. Ensure that a higher than normal rate of descent does not develop. Do not hold the airplane off waiting for a smooth landing. Fly the airplane onto the runway at the normal touchdown point. If a long landing is likely to occur, go-around. After touchdown, immediately apply maximum reverse thrust using all of the available runway for stopping to minimize brake temperatures. Do not attempt to make an early runway turnoff.

Autobrake stopping distance guidance is contained in the Performance Inflight section of the QRH. If adequate stopping distance is available based upon approach speed, runway conditions, and runway length, the recommended autobrake setting should be used.

Overweight Autolands Policy

Overweight autolands are not recommend. Autopilots on Boeing airplanes are not certified for automatic landings above maximum landing weight. At higher than normal speeds and weights, the performance of these systems may not be satisfactory and has not been thoroughly tested. An automatic approach may be attempted, however the pilot should disengage the autopilot prior to flare height and accomplish a manual landing.

In an emergency, should the pilot determine that an overweight autoland is the safest course of action, the approach and landing should be closely monitored by the pilot and the following factors considered:

- touchdown may be beyond the normal touchdown zone; allow for additional landing distance
- touchdown at higher than normal sink rates may result in exceeding structural limits
- plan for a go-around or manual landing if autoland performance is unsatisfactory; automatic go-arounds can be initiated until just prior to touchdown, and can be continued even if the airplane touches down after initiation of the go-around.



Intentionally
Blank



Preface 7.1

Acceleration to and Deceleration from VMO 7.1

Overspeed Protection 7.2

Engine Out Familiarization 7.2

 Rudder and Lateral Control (TAC Inoperative) 7.3

 Rudder and Lateral Control (TAC Operative) 7.4

 Thrust and Airspeed 7.4

High Altitude Maneuvering, “G” Buffet 7.5

Rapid Descent 7.6

 Autopilot Entry and Level Off 7.7

 Manual Entry and Level Off 7.8

 Landing Gear Extended Descent 7.8

 After Level Off 7.9

Stall Recovery 7.10

 Stall Protection Demonstration 7.10

 Recovery from a Fully Developed Stall 7.12

Bank Angle Protection 7.13

Terrain Avoidance 7.13

 Terrain Avoidance during Low RNP Operations 7.13

Traffic Alert and Collision Avoidance System 7.14

 Use of TA/RA, TA Only, and Transponder Only Modes 7.14

 Traffic Advisory 7.14

 Resolution Advisory 7.15



Upset Recovery	7.16
General	7.16
Upset Recovery Techniques	7.19
Windshear	7.20
General	7.20
Airplane Performance in Windshear	7.20
Avoidance, Precautions and Recovery	7.21

Preface

This chapter outlines the recommended operating practices and techniques used during maneuvers in both the training and operational environment. The flight profile illustrations represent the Boeing recommended basic configuration during the accomplishment of the flight maneuvers, and provides a basis for standardization and crew coordination.

Maneuvering for events such as Approach to Stall Recovery, Terrain Avoidance, Traffic Avoidance, Upset Recovery, or Windshear may result in deviation from the ATC clearance. The crew should expeditiously return to the applicable ATC clearance immediately following such maneuvering unless otherwise directed.

Acceleration to and Deceleration from VMO

Acceleration to and deceleration from VMO demonstrates performance capabilities and response to speed, thrust, and configuration changes throughout the medium altitude speed range of the airplane. This maneuver is performed in the full flight simulator and is for demonstration purposes only. It is normally performed at 10,000 to 15,000 feet, simulating slowdown to 250 knots due to speed restrictions.

VMO is a structural limitation and is the maximum operating indicated airspeed. It is a constant airspeed from sea level to the altitude where VMO and MMO coincide. MMO is the structural limitation above this altitude. Sufficient thrust is available to exceed VMO in level flight at lower altitudes. Failure to reduce to cruise thrust in level flight can result in excessive airspeed.

Begin the maneuver at existing cruise speed with the autothrottle connected and the autopilot disengaged. Set command speed to VMO. As speed increases observe:

- nose down trim required to keep airplane in trim and maintain level flight
- handling qualities during acceleration
- autothrottle protection at VMO.

At a stabilized speed just below VMO execute turns at high speed while maintaining altitude. Next, accelerate above VMO by disconnecting the autothrottle and increasing thrust.

When the overspeed warning occurs reduce thrust levers to idle, set command speed to 250 knots, and decelerate to command speed. Since the airplane is aerodynamically clean, any residual thrust results in a longer deceleration time. As airspeed decreases observe that nose up trim is required to keep airplane in trim and maintain level flight. During deceleration note the distance traveled from the time the overspeed warning stops until reaching 250 knots.



777 Flight Crew Training Manual

Once stabilized at 250 knots, set command speed to flaps up maneuvering speed and decelerate to command speed, again noting the distance traveled during deceleration. Observe the handling qualities of the airplane during deceleration.

This maneuver may be repeated using speedbrakes to compare deceleration times and distances.

Overspeed Protection

The object of the overspeed maneuver is to familiarize the pilot with airplane handling characteristics at and above VMO. It is not intended that the pilot should ever fly at airspeeds in excess of VMO.

While descending, select the V/S mode and increase the descent rate to 5000 feet per minute. Disengage the autopilot and trim as the airspeed increases. The airplane cannot be trimmed to an airspeed above VMO/MMO. As the airspeed increases above VMO, forward column pressure must be maintained to remain above VMO. Release pressure and the airplane pitch increases to reduce the airspeed to VMO.

Note: This maneuver is for demonstration purposes only and is performed in the simulator only.

Engine Out Familiarization

The exercises shown in the following table are performed to develop proficiency in handling the airplane with one engine inoperative and gain familiarization with rudder control requirements.

	Condition One	Condition Two
Airspeed	Flaps up maneuvering speed	V2
Landing Gear	Up	Down
Flaps	Up	20
Thrust	As Required	MCT
When In Trim - Retard one thrust lever to idle Controls - Apply to maintain heading, wings level Rudder - Apply to center control wheel Airspeed - Maintain with thrust (Condition One) Pitch (Condition Two) Trim - As required to relieve control forces		

One engine out controllability is excellent during takeoff roll and after lift-off. Minimum control speed in the air is below VR and VREF.

Rudder and Lateral Control (TAC Inoperative)

This familiarization is performed to develop proficiency in handling the airplane with an engine inoperative. It also helps to gain insight into rudder control requirements.

Under instrument conditions the instrument scan is centered around the attitude indicator. Roll is usually the first indication of an asymmetric condition. Roll control (ailerons) should be used to hold the wings level or maintain the desired bank angle. Stop the yaw by smoothly applying rudder at the same rate that thrust changes. When the rudder input is correct, very little control wheel displacement is necessary. Refine the rudder input as required and trim the rudder so the control wheel remains approximately level.

When the rudder is trimmed to level the control wheel, the airplane maintains heading. A small amount of bank toward the operating engine may be noticeable on the bank indicator. The slip/skid indicator is displaced slightly toward the operating engine.

If the airplane is trimmed with too much control wheel displacement, full lateral control is not available and spoilers on one wing may be raised, increasing drag.

Make turns at a constant airspeed and hold the rudder displacement constant. Do not attempt to coordinate rudder and lateral control in turns. Rudder pedal inputs produce roll due to yaw and induce the pilot to counter rudder oscillations with opposite control wheel.

The following figure shows correct and incorrect use of the rudder.

If an engine failure occurs with the autopilot engaged, manually position the rudder to approximately center the control wheel and add thrust. Trim the rudder to relieve rudder pedal pressure.

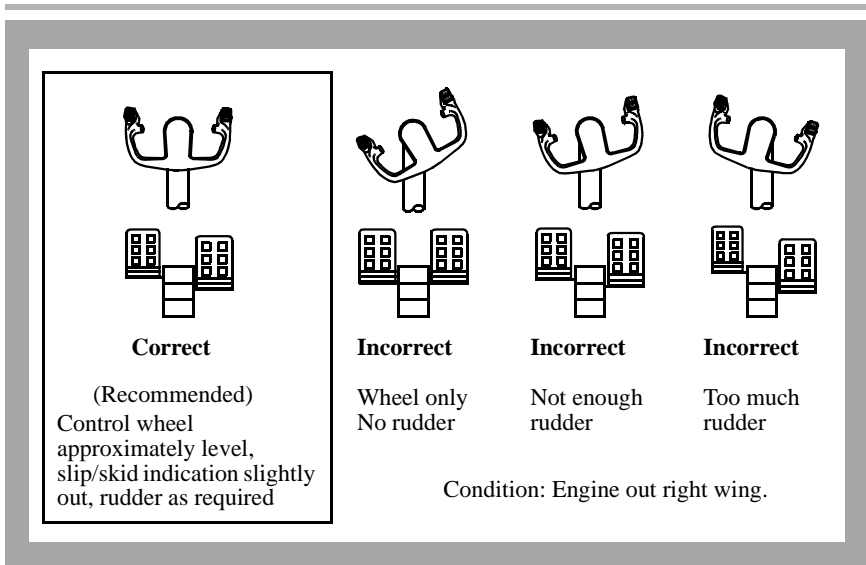

Rudder and Lateral Control (TAC Operative)

Engine out familiarization can also be performed with TAC operating to demonstrate its function. With TAC, an engine failure does not affect yaw as much as previous airplanes because the TAC rudder input greatly reduces the rudder input required from the pilot.

To provide an indication of the engine failure, TAC does not initially fully compensate for the yaw. Within a few seconds, sufficient rudder is input by TAC to center the control wheel.

Thrust and Airspeed

If not thrust limited, apply additional thrust, if required, to control the airspeed. The total two engine fuel flow existing at the time of engine failure may be used initially to establish a thrust setting at low altitude. If performance limited (high altitude), adjust airplane attitude to maintain airspeed while setting maximum continuous thrust.

Note: Autothrottle can be used effectively with an engine inoperative since the left and right autothrottle systems can be used independently while TAC provides automatic yaw compensation.

High Altitude Maneuvering, “G” Buffet

Airplane buffet reached as a result of airplane maneuvering is commonly referred to as “g” buffet. During turbulent flight conditions, it is possible to experience high altitude “g” buffet at speeds less than MMO. In training, buffet is induced to demonstrate the airplane’s response to control inputs during flight in buffet.

Note: Stick shaker is close to initial buffet for all weights and altitudes. Stick shaker activation may occur if the airplane is maneuvered beyond buffet.

Establish an airspeed of 0.81M to 0.84M. Induce “g” buffet by smoothly increasing the bank angle until the buffet is noticeable. Increase the rate of descent while increasing the bank angle to maintain airspeed. Do not exceed 30° of bank. If buffet does not occur by 30° of bank, increase control column back pressure until buffet occurs. When buffet is felt, relax back pressure and smoothly roll out to straight and level. Notice that the controls are fully effective at all times.

Rapid Descent

Appendix A.2.7

This section addresses basic techniques and procedures for a rapid descent. Some routes over mountainous terrain require careful operator planning to include carrying additional oxygen, special procedures, higher initial level off altitudes, and emergency routes in the event a depressurization is experienced. These requirements are normally addressed in an approved company route manual or other document that addresses route specific depressurization procedures.

This maneuver is designed to bring the airplane down smoothly to a safe altitude, in the minimum time, with the least possible passenger discomfort.

Note: Use of the autopilot is recommended.

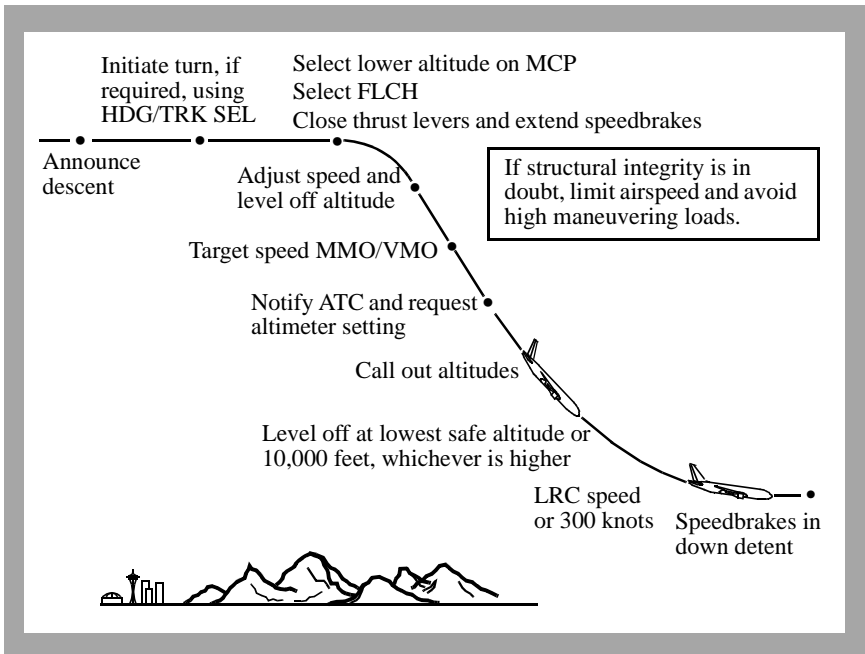

If the descent is performed because of a rapid loss of cabin pressure, crewmembers should place oxygen masks on and establish communication at the first indication of a loss of cabin pressurization. Verify cabin pressure is uncontrollable, and if so begin descent. If structural damage exists or is suspected, limit airspeed to current speed or less. Avoid high maneuvering loads.

777 Flight Crew Training Manual

Perform the maneuver deliberately and methodically. Do not be distracted from flying the airplane. If icing conditions are entered, use anti-ice and thrust as required.

Note: Rapid descents are normally made with the landing gear up.

The PM checks the lowest safe altitude, notifies ATC, and obtains an altimeter setting (QNH). Both pilots should verify that all memory items have been accomplished and call out any items not completed. The PM calls out 2,000 feet and 1,000 feet above the level off altitude.

Level off at the lowest safe altitude or 10,000 feet, whichever is higher. Lowest safe altitude is the Minimum Enroute Altitude (MEA), Minimum Off Route Altitude (MORA), or any other altitude based on terrain clearance, navigation aid reception, or other appropriate criteria.

If severe turbulent air is encountered or expected, reduce to the turbulent air penetration speed.

Autopilot Entry and Level Off

Flight Level Change (FLCH)

Because of airspeed and altitude protection and reduced crew workload, use of the autopilot with FLCH mode is the recommended technique for rapid descents. Use of the V/S or FPA mode is not recommended.

Initiate a turn, if required, using HDG/TRK SEL. Set a lower altitude in the altitude window. Select FLCH, close the thrust levers and smoothly extend the speedbrakes. If turn radius is a factor, the pilot should manually select the desired bank angle required to complete the maneuver in a safe manner. Autothrottles should be left engaged. The airplane pitches down smoothly while the thrust levers retard to idle. Adjust the speed as needed and ensure the altitude window is correctly set for the level off. During descent, the IAS/MACH speed window changes from MACH to IAS at approximately 310 KIAS. Manually reset to VMO as needed.

When approaching the target altitude, ensure the altitude is set in the MCP altitude select window. Altitude capture engages automatically. Adjusting the command speed to approximately LRC or 300 knots before level-off aids in smoothly transitioning to level flight. The pitch mode then controls altitude and the thrust levers increase to hold speed. Smoothly return the speedbrake lever to the down detent during the level off maneuver.



777 Flight Crew Training Manual

When descending with the autopilot engaged and the speedbrakes extended at speeds near VMO/MMO, the airspeed may momentarily increase to above VMO/MMO if the speedbrakes are retracted quickly. To avoid this condition, smoothly and slowly retract the speedbrakes to allow the autopilot sufficient time to adjust the pitch attitude to maintain the airspeed within limits.

When the speedbrakes are retracted during altitude capture near VMO/MMO, a momentary overspeed condition may also occur. This is because the autopilot captures the selected altitude smoothly by maintaining a fixed path while the thrust is at or near idle. To avoid this condition, it may be necessary to reduce the selected speed and/or descent rate before altitude capture or reduce the selected speed and delay speedbrake retraction until after level off is complete.

Manual Entry and Level Off

The entry may be accomplished on heading or a turn may be made to clear the airway or controlled track. However, since extending the speedbrakes initially reduces the maneuver margin, monitor the airspeed display and bank angle to ensure that at least minimum maneuver speed is maintained when turning.

To manually fly the maneuver, disconnect the autothrottles and retard thrust levers to idle. Smoothly extend the speedbrakes, disengage the autopilot and smoothly lower the nose to initial descent attitude (approximately 10° nose down).

About 10 knots before reaching target speed, slowly raise the pitch attitude to maintain target speed. Keep the airplane in trim at all times. If MMO/VMO is inadvertently exceeded, change pitch smoothly to decrease speed.

Approaching level off altitude, smoothly adjust pitch attitude to reduce rate of descent. The speedbrake lever should be returned to the down detent when approaching the desired level off altitude. After reaching level flight add thrust to maintain long range cruise or 300 knots.

Landing Gear Extended Descent

The rapid descent is normally made with the landing gear up. However, when structural integrity is in doubt and airspeed must be limited, extension of the landing gear may provide a more satisfactory rate of descent.

If the landing gear is to be used during the descent, comply with the landing gear placard speeds.

777 Flight Crew Training Manual

After Level Off

Recheck the pressurization system and evaluate the situation. Do not remove the crew oxygen masks if cabin altitude remains above 10,000 feet.

Note: Determine the new course of action based on weather, oxygen, fuel remaining, medical condition of crew and passengers, and available airports. Obtain a new ATC clearance.

Stall Recovery

The objective of the stall protection demonstration is to familiarize the pilot with stall warning and the correct recovery technique for conditions that are approaching stall, both with and without the autopilot. Recovery from a fully developed stall is discussed later in this section.

Stall Protection Demonstration

Stall warning is considered to be a warning readily identifiable by the pilot, either initial buffet or artificial (stick shaker). During initial stages of stall, local airflow separation results in buffeting (initial buffet), giving natural warning of an approach to stall. At cruise Mach numbers, stick shaker activation occurs just after reaching initial buffet. Initiate recovery from an approach to stall at the earliest recognizable stall warning, either initial buffet or stick shaker.

Begin the stall protection demonstration in level flight with flaps up at flaps up maneuvering speed. Select a speed in the IAS/MACH window that is below the minimum speed indication on the speed tape. Disengage the autopilot and autothrottle and retard the thrust levers to idle. As the speed decreases into the amber band, the PLI appears on the PFD. When the speed decreases approximately half way through the amber band, the AIRSPEED LOW caution message appears. The autothrottle wakes up, automatically engages in the SPD mode and returns the airplane to minimum maneuvering speed.

For the second part of the stall protection demonstration, select VREF 30 on the CDU. Disengage the autopilot, turn the autothrottle switches off and select a speed in the IAS/MACH window that is below the minimum speed indication on the speed tape. Maintain heading and altitude, and retard the thrust levers to idle. As the airplane decelerates, continue trimming and select flaps 20 on schedule. The pitch limit indicator appears on the PFD when the flaps are extended. The airplane can be trimmed down to an airspeed approximately equal to the minimum maneuver speed. Below this airspeed, nose up trim is inhibited. After the airspeed decreases into the amber band, use only control column inputs to maintain level flight. The stick shaker activates at minimum speed. If the airspeed reduces to slightly less than minimum speed, increased control column force is required to maintain level flight. Recovery from the approach to stall is conventional. Advance the thrust levers full forward and adjust pitch to maintain altitude. Lateral control is maintained with ailerons and spoilers. Rudder control should not be used to maintain wings level. A rudder input causes yaw and the resultant roll due to yaw is undesirable. Accelerate to flaps up maneuvering speed while retracting flaps.

777 Flight Crew Training Manual

To demonstrate autopilot stall protection, ensure that the pitch mode is ALT, turn the Autothrottle switches OFF and retard thrust levers to idle. As the airspeed approaches the minimum speed an AUTOPILOT caution message appears, an amber line is drawn through the selected pitch mode and the flight director pitch bar is removed. At minimum speed the stick shaker activates. Shortly after the stick shaker activates, the autopilot begins to descend from the selected altitude. The autopilot maintains a descent at a speed that is slightly above the minimum speed. To recover, return the speed to maneuvering speed by engaging the autothrottle with a higher speed selected or manually advance the thrust levers. Select a new pitch mode or disengage the autopilot and manually fly the airplane back to the starting altitude.

Recovery from a Fully Developed Stall

An airplane may be stalled in any attitude (nose high, nose low, high angle of bank) or any airspeed (turning, accelerated stall). It is not always intuitively obvious that the airplane is stalled.

An airplane stall is characterized by any one (or a combination) of the following conditions:

- buffeting, which could be heavy
- lack of pitch authority
- lack of roll control
- inability to arrest descent rate.

These conditions are usually accompanied by a continuous stall warning. A stall must not be confused with the stall warning that alerts the pilot to an approaching stall. Recovery from an approach to a stall is not the same as recovery from an actual stall. An approach to a stall is a controlled flight maneuver; a stall is an out-of-control, but recoverable, condition.

Note: Anytime the airplane enters a fully developed stall, the autopilot should be disengaged and the autothrottle should be disconnected.

To recover from a stall, angle of attack must be reduced below the stalling angle. Nose down pitch control must be applied and maintained until the wings are unstalled. Application of forward control column (as much as full forward may be required) should provide sufficient elevator control to produce a nose-down pitch rate.

Under certain conditions, on airplanes with underwing-mounted engines, it may be necessary to reduce thrust in order to prevent the angle of attack from continuing to increase. Once the wing is unstalled, upset recovery actions may be taken and thrust reapplied as needed.

If normal pitch control inputs do not stop an increasing pitch rate in a nose high situation, rolling the airplane to a bank angle that starts the nose down may be effective. Bank angles of about 45°, up to a maximum of 60°, could be needed. Normal roll controls - up to full deflection of ailerons and spoilers - may be used. Unloading the wing by maintaining continuous nose-down elevator pressure keeps the wing angle of attack as low as possible, making the normal roll controls as effective as possible.

Finally, if normal pitch control and roll control is ineffective, careful rudder input in the direction of the desired roll may be required to initiate a rolling maneuver recovery.

WARNING: Only a small amount of rudder is needed. Too much rudder applied too quickly or held too long may result in loss of lateral and directional control.

Bank Angle Protection

The objective of the turn maneuver is to familiarize the pilot with airplane handling characteristics beyond 35° of bank. During training, up to 45° of bank may be used for this maneuver. It is not intended that the pilot should ever be required to bank greater than 25° to 30° in any normal or non-normal condition.

With the autopilot OFF, initiate a turn beyond 35° of bank. Note that at approximately 35° of bank, the protection system provides opposing forces to the control wheel and that the PFD bank indicator turns amber. The protection forces can be overridden by the pilot and maximum control wheel deflection always commands maximum control surface deflection. Release the roll input and the protection system returns the airplane back to 30° of bank or less and the bank indicator returns to white.

Note: When flying with bank angle more than 30° the pilot must add control column back pressure to maintain level flight.

Terrain Avoidance

The Ground Proximity Warning System (GPWS) PULL UP Warning occurs when an unsafe distance or closure rate is detected with terrain below the airplane. The Look-ahead terrain alerting (as installed) also provides an aural warning when an unsafe distance is detected from terrain ahead of the airplane. Immediately accomplish the Terrain Avoidance maneuver found in the non-normal maneuvers section in the QRH.

Do not attempt to engage the autopilot and/or autothrottle until terrain clearance is assured.

Terrain Avoidance during Low RNP Operations

[Appendix A.2.8](#)

During low RNP operations (RNP less than 0.3) in close proximity to terrain on departure or approach, crews may experience occasional momentary terrain caution-level alerts. If these alerts are of short duration and have ceased, crews should verify they are on the required path and consider continuing the procedure using LNAV and VNAV. Depending upon where initiation occurs, the risks of terrain contact while executing a terrain avoidance maneuver may be higher than continuing on the required track.

Terrain warning-level alerts always require immediate action. The most appropriate crew actions regarding airplane bank angle and track during a terrain avoidance maneuver depend on where the maneuver is initiated. Operators should determine the most appropriate course of action for each leg of the procedure, if necessary, so crews are prepared to react correctly at all times.

Traffic Alert and Collision Avoidance System

The Traffic Alert and Collision Avoidance System (TCAS) is designed to enhance crew awareness of nearby traffic and issue advisories for timely visual acquisition or appropriate vertical flight path maneuvers to avoid potential collisions. It is intended as a backup to visual collision avoidance, application of right-of-way rules and ATC separation.

Use of TA/RA, TA Only, and Transponder Only Modes

TCAS operation should be initiated just before takeoff and continued until just after landing. Whenever practical, the system should be operated in the TA/RA mode to maximize system benefits. Operations in the Traffic Advisory (TA) Only or TCAS Off (Transponder Only) modes, to prevent nuisance advisories and display clutter, should be in accordance with operator policy.

The responsibility for avoiding collisions still remains with the flight crew and ATC. Pilots should not become preoccupied with TCAS advisories and displays at the expense of basic airplane control, normal visual lookout and other crew duties.

Traffic Advisory

A Traffic Advisory (TA) occurs when nearby traffic meets system minimum separation criteria, and is indicated aurally and visually on the TCAS traffic display. A goal of the TA is to alert the pilot of the possibility of an RA. If a TA is received, immediately accomplish the Traffic Avoidance Maneuver in the QRH.

Maneuvers based solely on a TA may result in reduced separation and are not recommended.

The TA ONLY mode may be appropriate under the following circumstances:

- during takeoff toward known nearby traffic (in visual contact) which would cause an unwanted RA during initial climb
- during closely spaced parallel runway approaches
- when flying in known close proximity to other airplanes
- in circumstances identified by the operator as having a verified and significant potential for unwanted or undesirable RAs
- engine out operation.

Resolution Advisory

When TCAS determines that separation from approaching traffic may not be sufficient, TCAS issues a Resolution Advisory (RA) aural warning and a pitch command. Maneuvering is required if any portion of the airplane symbol is within the red region on the attitude indicator. Flight crews should follow RA commands using established procedures unless doing so would jeopardize the safe operation of the airplane. If a RA is received, immediately accomplish the Traffic Avoidance maneuver in the QRH.

Resolution advisories are known to occur more frequently at locations where traffic frequently converges (e.g. waypoints). This is especially true in RVSM airspace. Climb or descent profiles should not be modified in anticipation of avoiding an RA unless specifically requested by ATC.

RA maneuvers require only small pitch attitude changes which should be accomplished smoothly and without delay. Properly executed, the RA maneuver is mild and does not require large or abrupt control movements. Remember that the passengers and flight attendants may not all be seated during this maneuver. The flight director is not affected by TCAS guidance. Therefore, when complying with an RA, flight director commands may be followed only if they result in a vertical speed that satisfies the RA command.

There have been reports of some flight crews responding incorrectly to the RA “Adjust Vertical Speed Adjust” (AVSA) by increasing rather than decreasing vertical speed. Flight crews should be aware that an AVSA always requires a reduction in vertical speed. Follow QRH procedures and comply with the RA commanded vertical speed.

During the RA maneuver, the aircrew attempts to establish visual contact with the target. However, visual perception of the encounter can be misleading, particularly at night. The traffic acquired visually may not be the same traffic causing the RA.

Pilots should maintain situational awareness since TCAS may issue RAs in conflict with terrain considerations, such as during approaches into rising terrain or during an obstacle limited climb. Continue to follow the planned lateral flight path unless visual contact with the conflicting traffic requires other action. Windshear, GPWS, and stall warnings take precedence over TCAS advisories. Stick shaker must be respected at all times. Complying with RAs may result in brief exceedance of altitude and/or placard limits. However, even at the limits of the operating envelope, in most cases sufficient performance is available to safely maneuver the airplane. Smoothly and expeditiously return to appropriate altitudes and speeds when clear of conflict. Maneuvering opposite to an RA command is not recommended since TCAS may be coordinating maneuvers with other airplanes.

Upset Recovery

For detailed information regarding the nature of upsets, aerodynamic principles, recommended training and other related information, refer to the Airplane Upset Recovery Training Aid available through your operator.

An upset can generally be defined as unintentionally exceeding any of the following conditions:

- pitch attitude greater than 25° nose up
- pitch attitude greater than 10° nose down
- bank angle greater than 45°
- within above parameters but flying at airspeeds inappropriate for the conditions.

General

Though flight crews in line operation rarely, if ever, encounter an upset situation, understanding how to apply aerodynamic fundamentals in such a situation helps them control the airplane. Several techniques are available for recovering from an upset. In most situations, if a technique is effective, it is not recommended that pilots use additional techniques. Several of these techniques are discussed in the example scenarios below:

- stall recovery
- nose high, wings level
- nose low, wings level
- high bank angles
- nose high, high bank angles
- nose low, high bank angles

Note: Higher than normal control forces may be required to control the airplane attitude when recovering from upset situations. Be prepared to use a firm and continuous force on the control column and control wheel to complete the recovery.

Stall Recovery

In all upset situations, it is necessary to recover from a stall before applying any other recovery actions. A stall may exist at any attitude and may be recognized by continuous stick shaker activation accompanied by one or more of the following:

- buffeting which could be heavy at times
- lack of pitch authority and/or roll control
- inability to arrest descent rate.

777 Flight Crew Training Manual

If the airplane is stalled, recovery from the stall must be accomplished first by applying and maintaining nose down elevator until stall recovery is complete and stick shaker activation ceases. Under certain conditions, it may be necessary to reduce some thrust in order to prevent the angle of attack from continuing to increase. Once stall recovery is complete, upset recovery actions may be taken and thrust reapplied as needed.

Nose High, Wings Level

In a situation where the airplane pitch attitude is unintentionally more than 25° nose high and increasing, the airspeed is decreasing rapidly. As airspeed decreases, the pilot's ability to maneuver the airplane also decreases. If the stabilizer trim setting is nose up, as for slow-speed flight, it partially reduces the nose-down authority of the elevator. Further complicating this situation, as the airspeed decreases, the pilot could intuitively make a large thrust increase. This causes an additional pitch up. At full thrust settings and very low airspeeds, the elevator, working in opposition to the stabilizer, has limited control to reduce the pitch attitude.

In this situation the pilot should trade altitude for airspeed, and maneuver the airplane's flight path back toward the horizon. This is accomplished by the input of up to full nose-down elevator and the use of some nose-down stabilizer trim. These actions should provide sufficient elevator control power to produce a nose-down pitch rate. It may be difficult to know how much stabilizer trim to use, and care must be taken to avoid using too much trim. Pilots should not fly the airplane using stabilizer trim, and should stop trimming nose down when they feel the g force on the airplane lessen or the required elevator force lessen. This use of stabilizer trim may correct an out-of-trim airplane and solve a less-critical problem before the pilot must apply further recovery measures. Because a large nose-down pitch rate results in a condition of less than 1 g, at this point the pitch rate should be controlled by modifying control inputs to maintain between 0 g and 1 g. If altitude permits, flight tests have determined that an effective way to achieve a nose-down pitch rate is to reduce some thrust.

If normal pitch control inputs do not stop an increasing pitch rate, rolling the airplane to a bank angle that starts the nose down should work. Bank angles of about 45°, up to a maximum of 60°, could be needed. Unloading the wing by maintaining continuous nose-down elevator pressure keeps the wing angle of attack as low as possible, making the normal roll controls as effective as possible. With airspeed as low as stick shaker onset, normal roll controls - up to full deflection of ailerons and spoilers - may be used. The rolling maneuver changes the pitch rate into a turning maneuver, allowing the pitch to decrease. Finally, if normal pitch control then roll control is ineffective, careful rudder input in the direction of the desired roll may be required to induce a rolling maneuver for recovery.

Only a small amount of rudder is needed. Too much rudder applied too quickly or held too long may result in loss of lateral and directional control. Because of the low energy condition, pilots should exercise caution when applying rudder.

The reduced pitch attitude allows airspeed to increase, thereby improving elevator and aileron control effectiveness. After the pitch attitude and airspeed return to a desired range the pilot can reduce angle of bank with normal lateral flight controls and return the airplane to normal flight.

Nose Low, Wings Level

In a situation where the airplane pitch attitude is unintentionally more than 10° nose low and going lower, the airspeed is increasing rapidly. A pilot would likely reduce thrust and extend the speedbrakes. Thrust reduction causes an additional nose-down pitching moment. Speedbrake extension causes a nose-up pitching moment, an increase in drag, and a decrease in lift for the same angle of attack. At airspeeds well above VMO/MMO, the ability to command a nose-up pitch rate with elevator may be reduced because of the extreme aerodynamic loads on the elevator.

Again, it is necessary to maneuver the airplane's flight path back toward the horizon. At moderate pitch attitudes, applying nose-up elevator, reducing thrust, and extending speedbrakes, if necessary, changes the pitch attitude to a desired range. At extremely low pitch attitudes and high airspeeds (well above VMO/MMO), nose-up elevator and nose-up trim may be required to establish a nose-up pitch rate.

High Bank Angles

A high bank angle is one beyond that necessary for normal flight. Though the bank angle for an upset has been defined as unintentionally more than 45°, it is possible to experience bank angles greater than 90°.

Any time the airplane is not in “zero-angle-of-bank” flight, lift created by the wings is not being fully applied against gravity, and more than 1 g is required for level flight. At bank angles greater than 67°, level flight cannot be maintained within AFM load factor limits. In high bank angle increasing airspeed situations, the primary objective is to maneuver the lift of the airplane to directly oppose the force of gravity by rolling in the shortest direction to wings level. Applying nose-up elevator at bank angles above 60° causes no appreciable change in pitch attitude and may exceed normal structure load limits as well as the wing angle of attack for stall. The closer the lift vector is to vertical (wings level), the more effective the applied g is in recovering the airplane.

A smooth application of up to full lateral control should provide enough roll control power to establish a very positive recovery roll rate. If full roll control application is not satisfactory, it may even be necessary to apply some rudder in the direction of the desired roll.

777 Flight Crew Training Manual

Only a small amount of rudder is needed. Too much rudder applied too quickly or held too long may result in loss of lateral and directional control or structural failure.

Nose High, High Bank Angles

A nose high, high angle of bank upset requires deliberate flight control inputs. A large bank angle is helpful in reducing excessively high pitch attitudes. The pilot must apply nose-down elevator and adjust the bank angle to achieve the desired rate of pitch reduction while considering energy management. Once the pitch attitude has been reduced to the desired level, it is necessary only to reduce the bank angle, ensure that sufficient airspeed has been achieved, and return the airplane to level flight.

Nose Low, High Bank Angles

The nose low, high angle of bank upset requires prompt action by the pilot as altitude is rapidly being exchanged for airspeed. Even if the airplane is at a high enough altitude that ground impact is not an immediate concern, airspeed can rapidly increase beyond airplane design limits. Simultaneous application of roll and adjustment of thrust may be necessary. It may be necessary to apply nose-down elevator to limit the amount of lift, which will be acting toward the ground if the bank angle exceeds 90°. This also reduces wing angle of attack to improve roll capability. Full aileron and spoiler input should be used if necessary to smoothly establish a recovery roll rate toward the nearest horizon. It is important to not increase g force or use nose-up elevator or stabilizer until approaching wings level. The pilot should also extend the speedbrakes as needed.

Upset Recovery Techniques

It is possible to consolidate and incorporate recovery techniques into two basic scenarios, nose high and nose low, and to acknowledge the potential for high bank angles in each scenario described above. Other crew actions such as recognizing the upset, reducing automation, and completing the recovery are included in these techniques. The recommended techniques provide a logical progression for recovering an airplane.

If an upset situation is recognized, immediately accomplish the Upset Recovery maneuver found in the non-normal maneuvers section in the QRH.

Windshear

General

Improper or ineffective vertical flight path control has been one of the primary factors in many cases of flight into terrain. Low altitude windshear encounters are especially significant because windshear can place the crew in a situation which requires the maximum performance capability of the airplane. Windshear encounters near the ground are the most threatening because there is very little time or altitude to respond to and recover from an encounter.

Airplane Performance in Windshear

Knowledge of how windshear affects airplane performance can be essential to the successful application of the proper vertical flight path control techniques during a windshear encounter.

The wind component is mostly horizontal at altitudes below 500 feet. Horizontal windshear may improve or degrade vertical flight path performance. Windshear that improves performance is first indicated in the flight deck by an increasing airspeed. This type of windshear may be a precursor of a shear that decreases airspeed and degrades vertical flight path performance.

Airspeed decreases if the tailwind increases, or headwind decreases, faster than the airplane is accelerating. As the airspeed decreases, the airplane normally tends to pitch down to maintain or regain the in-trim speed. The magnitude of pitch change is a function of the encountered airspeed change. If the pilot attempts to regain lost airspeed by lowering the nose, the combination of decreasing airspeed and decreasing pitch attitude produces a high rate of descent. Unless this is countered by the pilot, a critical flight path control situation may develop very rapidly. As little as 5 seconds may be available to recognize and react to a degrading vertical flight path.

In critical low altitude situations, trade airspeed for altitude, if possible. An increase in pitch attitude, even though the airspeed may be decreasing, increases the lifting force and improves the flight path angle. Proper pitch control, combined with maximum available thrust, utilizes the total airplane performance capability.

The crew must be aware of the normal values of airspeed, altitude, rate of climb, pitch attitude and control column forces. Unusual control column force may be required to maintain or increase pitch attitude when airspeed is below the in-trim speed. If significant changes in airspeed occur and unusual control forces are required, the crew should be alerted to a possible windshear encounter and be prepared to take action.

Avoidance, Precautions and Recovery

Crew actions are divided into three areas: Avoidance, Precautions and Recovery. For more information on avoidance and precautions, see the Windshear supplementary procedure in Volume 1 of the FCOM. For specific crew actions for recovery, see the Non-Normal Maneuvers section in the QRH.



Intentionally
Blank



Non-Normal Operations

Chapter 8

Table of Contents

Section TOC

Preface 8.1

Non-Normal Situation Guidelines 8.1

 Troubleshooting 8.2

 Approach and Landing 8.3

 Landing at the Nearest Suitable Airport 8.3

Ditching 8.4

 Send Distress Signals 8.4

 Advise Crew and Passengers 8.4

 Fuel Burn-Off 8.5

 Passenger Cabin Preparation 8.5

 Ditching Final 8.5

 Initiate Evacuation 8.5

Electrical 8.5

Engines, APU 8.5

 Engine Failure versus Engine Fire After Takeoff 8.5

 Fire Engine Tailpipe 8.6

 Loss of Engine Thrust Control 8.6

 Dual Engine Failure/Stall 8.7

 Engine Severe Damage Accompanied by High Vibration 8.7

 Recommended Technique for an In-Flight Engine Shutdown 8.8

 Bird Strikes 8.8

Evacuation 8.10

 Method of Evacuation 8.10

 Discharging Fire Bottles during an Evacuation 8.11



Flight Controls	8.11
Leading Edge or Trailing Edge Device Malfunctions	8.11
Flap Extension using the Secondary or Alternate System	8.12
Jammed Flight Controls	8.13
Inoperative Stabilizer	8.15
Stabilizer	8.15
Flight Instruments, Displays	8.15
Airspeed Unreliable	8.15
Fuel	8.17
Fuel Balance	8.17
Fuel Leak	8.18
Low Fuel	8.18
Fuel Jettison	8.19
Hydraulics	8.19
Hydraulic System(s) Inoperative - Landing	8.19
Landing Gear	8.20
Tire Failure during or after Takeoff	8.20
Landing on a Flat Tire	8.20
Gear Disagree	8.21
Overspeed	8.23
Tail Strike	8.24
Takeoff Risk Factors	8.25
Landing Risk Factors	8.26
Warning Systems	8.28
Wheel Well Fire	8.28
Windows	8.28
Window Damage	8.28



777 Flight Crew Training Manual

Flight with the Side Window(s) Open.	8.29
Situations Beyond the Scope of Non-Normal Checklists	8.29
Basic Aerodynamics and Systems Knowledge	8.29
Flight Path Control	8.31
Checklists with Memory Steps	8.31
Communications	8.32
Damage Assessment and Airplane Handling Evaluation	8.32
Landing Airport.	8.33



Intentionally
Blank



Preface

This chapter describes pilot techniques associated with accomplishing selected Non-Normal Checklists (NNCs) and provides guidance for situations beyond the scope of NNCs. Aircrews are expected to accomplish NNCs listed in the QRH. These checklists ensure maximum safety until appropriate actions are completed and a safe landing is accomplished. Techniques discussed in this chapter minimize workload, improve crew coordination, enhance safety, and provide a basis for standardization. A thorough review of the QRH section CI.2, (Checklist Instructions, Non-Normal Checklists), is an important prerequisite to understanding this chapter.

Non-Normal Situation Guidelines

When a non-normal situation occurs, the following guidelines apply:

- **NON-NORMAL RECOGNITION:** The crewmember recognizing the malfunction calls it out clearly and precisely
- **MAINTAIN AIRPLANE CONTROL:** It is mandatory that the Pilot Flying (PF) fly the airplane while the Pilot Monitoring (PM) accomplishes the NNC. Maximum use of the autoflight system is recommended to reduce crew workload
- **ANALYZE THE SITUATION:** NNCs should be accomplished only after the malfunctioning system has been positively identified. Review all EICAS messages to positively identify the malfunctioning system(s)

Note: Pilots should don oxygen masks and establish crew communications anytime oxygen deprivation or air contamination is suspected, even though an associated warning has not occurred.



- **TAKE THE PROPER ACTION:** Although some in-flight non-normal situations require immediate corrective action, difficulties can be compounded by the rate the PF issues commands and the speed of execution by the PM. Commands must be clear and concise, allowing time for acknowledgment of each command prior to issuing further commands. The PF must exercise positive control by allowing time for acknowledgment and execution. The other crewmembers must be certain their reports to the PF are clear and concise, neither exaggerating nor understating the nature of the non-normal situation. This eliminates confusion and ensures efficient, effective, and expeditious handling of the non-normal situation
- **EVALUATE THE NEED TO LAND:** If the NNC directs the crew to plan to land at the nearest suitable airport, or if the situation is so identified in the QRH section CI.2, (Checklist Instructions, Non-Normal Checklists), diversion to the nearest airport where a safe landing can be accomplished is required. If the NNC or the Checklist Instructions do not direct landing at the nearest suitable airport, the pilot must determine if continued flight to destination may compromise safety.

Troubleshooting

Troubleshooting can be defined as:

- taking steps beyond a published NNC in an effort to improve or correct a non-normal condition
- initiating an annunciated checklist without an EICAS alert message to improve or correct a perceived non-normal condition
- initiating diagnostic actions.

Examples of troubleshooting are:

- attempting to reset a system by cycling a system control or circuit breaker when not directed by the NNC
- using maintenance-level information to diagnose or take action
- using switches or controls intended only for maintenance.

Troubleshooting beyond checklist directed actions is rarely helpful and has caused further loss of system function or failure. In some cases, accidents and incidents have resulted. The crew should consider additional actions beyond the checklist only when completion of the published checklist steps clearly results in an unacceptable situation. In the case of airplane controllability problems when a safe landing is considered unlikely, airplane handling evaluations with gear, flaps or speedbrakes extended may be appropriate. In the case of jammed flight controls, do not attempt troubleshooting beyond the actions directed in the NNC unless the airplane cannot be safely landed with the existing condition. Always comply with NNC actions to the extent possible.

Note: Flight crew entry into an electronics compartment in flight is not recommended.

777 Flight Crew Training Manual

Crew distraction, caused by preoccupation with troubleshooting, has been a key factor in several fuel starvation and CFIT accidents. Boeing recommends completion of the NNC as published whenever possible, in particular for flight control malfunctions that are addressed by a NNC. Guidance for situations beyond the scope of the non-normal checklist is provided later in this chapter.

Approach and Landing

When a non-normal situation occurs, a rushed approach can often complicate the situation. Unless circumstances require an immediate landing, complete all corrective actions before beginning the final approach.

For some non-normal situations, the possibility of higher airspeed on approach, longer landing distance, a different flare profile or a different landing technique should be considered.

Plan an extended straight-in approach with time allocated for the completion of any lengthy NNC steps such as the use of alternate flap or landing gear extension systems. Arm autobrakes and speedbrakes unless precluded by the NNC.

Note: The use of autobrakes is recommended because maximum autobraking may be more effective than maximum manual braking due to timely application upon touchdown and symmetrical braking. However, the Advisory Information in the PI chapter of the QRH provides Non-Normal Configuration Landing Distance data based on the use of maximum manual braking. When used properly, maximum manual braking provides the shortest stopping distance.

Fly a normal glide path and attempt to land in the normal touchdown zone. After landing, use available deceleration measures to bring the airplane to a complete stop on the runway. The captain must determine if an immediate evacuation should be accomplished or if the airplane can be safely taxied off the runway.

Landing at the Nearest Suitable Airport

[Appendix A.2.8](#)

“Plan to land at the nearest suitable airport” is a phrase used in the QRH. This section explains the basis for that statement and how it is applied.

In a non-normal situation, the pilot-in-command, having the authority and responsibility for operation and safety of the flight, must make the decision to continue the flight as planned or divert. In an emergency situation, this authority may include necessary deviations from any regulation to meet the emergency. In all cases, the pilot-in-command is expected to take a safe course of action.

The QRH assists flight crews in the decision making process by indicating those situations where “landing at the nearest suitable airport” is required. These situations are described in the Checklist Instructions or the individual NNC.

The regulations regarding an engine failure are specific. Most regulatory agencies specify that the pilot-in-command of a twin engine airplane that has an engine failure or engine shutdown should land at the nearest suitable airport at which a safe landing can be made.

A suitable airport is defined by the operating authority for the operator based on guidance material but, in general, must have adequate facilities and meet certain minimum weather and field conditions. If required to divert to the nearest suitable airport (twin engine airplanes with an engine failure), the guidance material also typically specifies that the pilot should select the nearest suitable airport “in point of time” or “in terms of time.” In selecting the nearest suitable airport, the pilot-in-command should consider the suitability of nearby airports in terms of facilities and weather and their proximity to the airplane position. The pilot-in-command may determine, based on the nature of the situation and an examination of the relevant factors, that the safest course of action is to divert to a more distant airport than the nearest airport. For example, there is not necessarily a requirement to spiral down to the airport nearest the airplane’s present position if, in the judgment of the pilot-in-command, it would require equal or less time to continue to another nearby airport.

For persistent smoke or a fire which cannot positively be confirmed to be completely extinguished, the safest course of action typically requires the earliest possible descent, landing and evacuation. This may dictate landing at the nearest airport appropriate for the airplane type, rather than at the nearest suitable airport normally used for the route segment where the incident occurs.

Ditching

Send Distress Signals

Transmit Mayday, current position, course, speed, altitude, situation, intention, time and position of intended touchdown, and type of airplane using existing air-to-ground frequency. Set transponder code 7700 and, if practical, determine the course to the nearest ship or landfall.

Advise Crew and Passengers

Alert the crew and the passengers to prepare for ditching. Assign life raft positions (as installed) and order all loose equipment in the airplane secured. Put on life vests, shoulder harnesses, and seat belts. Do not inflate life vests until after exiting the airplane.

777 Flight Crew Training Manual

Fuel Burn-Off

Consider burning off fuel prior to ditching, if the situation permits. This provides greater buoyancy and a lower approach speed. However, do not reduce fuel to a critical amount, as ditching with engine thrust available improves ability to properly control touchdown.

Note: Fuel jettisoning may also be considered prior to ditching.

Passenger Cabin Preparation

Confer with cabin personnel either by interphone or by having them report to the flight deck in person to ensure passenger cabin preparations for ditching are complete.

Ditching Final

Transmit final position. Select flaps 30 or landing flaps appropriate for the existing conditions.

Advise the cabin crew of imminent touchdown. On final approach announce ditching is imminent and advise crew and passengers to brace for impact.

Maintain airspeed at VREF. Maintain 200 to 300 fpm rate of descent. Plan to touchdown on the windward side and parallel to the waves or swells, if possible. To accomplish the flare and touchdown, rotate smoothly to touchdown attitude of 10° to 12°. Maintain airspeed and rate of descent with thrust.

Initiate Evacuation

After the airplane has come to rest, proceed to assigned ditching stations and deploy slides/rafts. Evacuate as soon as possible, ensuring all passengers are out of the airplane.

Note: Be careful not to rip or puncture the slides/rafts. Avoid drifting into or under parts of the airplane. Remain clear of fuel-saturated water.

Electrical

Engines, APU**Engine Failure versus Engine Fire After Takeoff**

The NNC for an engine failure is normally accomplished after the flaps have been retracted and conditions permit.

In case of an engine fire, when the airplane is under control, the gear has been retracted, and a safe altitude has been attained (minimum 400 feet AGL) accomplish the NNC memory items. Due to asymmetric thrust considerations, Boeing recommends that the PF retard the affected thrust lever after the PM confirms that the PF has identified the correct engine. Reference items should be accomplished on a non-interfering basis with other normal duties after the flaps have been retracted and conditions permit.

Fire Engine Tailpipe

Engine tailpipe fires are typically caused by engine control malfunctions that result in the ignition of pooled fuel. These fires can be damaging to the engine and have caused unplanned evacuations.

If a tailpipe fire is reported, the crew should accomplish the NNC without delay. Flight crews should consider the following when dealing with this situation:

- motoring the engine is the primary means of extinguishing the fire
- to prevent an inappropriate evacuation, flight attendants should be notified without significant delay
- communications with ramp personnel and the tower are important to determine the status of the tailpipe fire and to request fire extinguishing assistance
- the engine fire checklist is inappropriate because the engine fire extinguishing agent is not effective against a fire inside the tailpipe.

Loss of Engine Thrust Control

All turbo fan engines are susceptible to this malfunction whether engine control is hydro-mechanical, hydro-mechanical with supervisory electronics (e.g. PMC) or Full Authority Digital Engine Control (FADEC). Engine response to a loss of control varies from engine to engine. Malfunctions have occurred in-flight and on the ground. The major challenge the flight crew faces when responding to this malfunction is recognizing the condition and determining which engine has malfunctioned. The Engine Limit or Surge or Stall NNC is written to include this malfunction. This condition can occur during any phase of flight.

Failure of engine or fuel control system components or loss of thrust lever position feedback has caused loss of engine thrust control. Control loss may not be immediately evident since many engines fail to some fixed RPM or thrust lever condition. This fixed RPM or thrust lever condition may be very near the commanded thrust level and therefore difficult to recognize until the flight crew attempts to change thrust with the thrust lever. Other engine responses include: shutdown, operation at low RPM, or thrust at the last valid thrust lever setting (in the case of a thrust lever feedback fault) depending on altitude or air/ground logic. In all cases, the affected engine does not respond to thrust lever movement or the response is abnormal.

777 Flight Crew Training Manual

Since recognition may be difficult, if a loss of engine control is suspected, the flight crew should continue the takeoff or remain airborne until the NNC can be accomplished. This helps with directional control and may preclude an inadvertent shutdown of the wrong engine. In some conditions, such as during low speed ground operations, immediate engine shutdown may be necessary to maintain directional control.

Dual Engine Failure/Stall

Dual engine failure is a situation that demands prompt action regardless of altitude or airspeed. Accomplish memory items and establish the appropriate airspeed to immediately attempt a windmill restart. There is a higher probability that a windmill start will succeed if the restart attempt is made as soon as possible (or immediately after recognizing an engine failure) to take advantage of high engine RPM. Use of higher airspeeds and altitudes below 30,000 feet improves the probability of a restart. Loss of thrust at higher altitudes may require descent to a lower altitude to improve windmill starting capability.

The in-flight start envelope defines the region where windmill starts were demonstrated during certification. It should be noted that this envelope does not define the only areas where a windmill start may be successful. The DUAL ENGINE FAIL/STALL NNC is written to ensure that flight crews take advantage of the high RPM at engine failure regardless of altitude or airspeed.

A hung or stalled in-flight start is normally indicated by stagnant RPM and/or increasing EGT. During start, engines may accelerate to idle slowly but action should not be taken if RPM is increasing and EGT is not near or rapidly approaching the limit.

Note: When electrical power is restored, do not confuse the establishment of APU generator power with the establishment of engine generator power at idle RPM and advance the thrust lever prematurely.

Engine Severe Damage Accompanied by High Vibration

Certain engine failures, such as fan blade separation can cause high levels of airframe vibration. Although the airframe vibration may seem severe to the flight crew, it is extremely unlikely that the vibration will damage the airplane structure or critical systems. However, the vibration should be reduced as soon as possible by reducing airspeed and descending. As altitude and airspeed change, the airplane may transition through various levels of vibration. In general, vibration levels decrease as airspeed decreases, however, at a given altitude vibration may temporarily increase or decrease as airspeed changes.

If vibration remains unacceptable, descending to a lower altitude (terrain permitting) allows a lower airspeed and normally lower vibration levels. Vibration will likely become imperceptible as airspeed is further reduced during approach.

The impact of a vibrating environment on human performance is dependent on a number of factors, including the orientation of the vibration relative to the body. People working in a vibrating environment may find relief by leaning forward or backward, standing, or otherwise changing their body position.

Once airframe vibration has been reduced to acceptable levels, the crew must evaluate the situation and determine a new course of action based on weather, fuel remaining, and available airports.

Recommended Technique for an In-Flight Engine Shutdown

Appendix A.2.8

Any time an engine shutdown is needed in flight, good crew coordination is essential. Airplane incidents have turned into airplane accidents as a result of the flight crew shutting down the incorrect engine.

When the flight path is under complete control, the crew should proceed with a deliberate, systematic process that identifies the affected engine and ensures that the operating engine is not shut down. Do not rush through the shutdown checklist, even for a fire indication. The following technique is an example that could be used:

When an engine shutdown is needed, the PF verbally coordinates confirmation of the affected engine with the PM and then turns off or directs the PM to turn off the affected A/T. The PF verbally confirms the affected engine with the PM and then slowly retards the thrust lever of the engine that will be shutdown.

Coordinate activation of the fuel control switch as follows:

- PM places a hand on and verbally identifies the fuel control switch for the engine that will be shutdown
- PF verbally confirms that the PM has identified the correct fuel control switch
- PM moves the fuel control switch to cutoff.

If the NNC requires activation of the engine fire switch, coordinate as follows:

- PM places a hand on and verbally identifies the engine fire switch for the engine that is shutdown
- PF verbally confirms that the PM has identified the correct engine fire switch
- PM pulls the engine fire switch.

Bird Strikes

Experience shows that bird strikes are common in aviation. Most bird strikes occur at very low altitudes, below 500 feet AGL. This section deals with bird strikes that affect the engines.

777 Flight Crew Training Manual

Recent studies of engine bird strikes reveal that approximately 50% of engine bird strikes damage the engine(s). The risk of engine damage increases proportionally with the size of the bird and with increased engine thrust settings. When an engine bird strike damages the engine, the most common indications are significant vibrations due to fan blade damage and an EGT increase.

Note: After any bird strike, the engines should be inspected by maintenance.

Preventative Strategies

Airports are responsible for bird control and should provide adequate wildlife control measures. If large birds or flocks of birds are reported or observed near the runway, the crew should consider:

- delaying the takeoff or landing when fuel permits. Advise the tower and wait for airport action before continuing
- takeoff or land on another runway that is free of bird activity, if available.

To prevent or reduce the consequences of a bird strike, the crew should:

- discuss bird strikes during takeoff and approach briefings when operating at airports with known or suspected bird activity.
- be extremely vigilant if birds are reported on final approach
- if birds are expected on final approach, plan additional landing distance to account for the possibility of no thrust reverser use if a bird strike occurs.

Note: The use of weather radar to scare the birds has not been proven effective.

Crew Actions for a Bird Strike During Takeoff

If a bird strike occurs during takeoff, the decision to continue or reject the takeoff is made using the criteria found in the Rejected Takeoff maneuver of the QRH.

If a bird strike occurs above 80 knots and prior to V1, and there is no immediate evidence of engine failure (e.g. failure, fire, power loss, or surge/stall), the preferred option is to continue with the take off followed by an immediate return, if required.

Crew Actions for a Bird Strike During Approach or Landing

If the landing is assured, continuing the approach to landing is the preferred option. If more birds are encountered, fly through the bird flock and land. Maintain as low a thrust setting as possible.

If engine ingestion is suspected, limit reverse thrust on landing to the amount needed to stop on the runway. Reverse thrust may increase engine damage, especially when engine vibration or high EGT are indicated.

Evacuation

If an evacuation is planned and time permits, a thorough briefing and preparation of the crew and passengers improves the chances of a successful evacuation. Flight deck preparations should include a review of pertinent checklists and any other actions to be accomplished. Appropriate use of autobrakes should be discussed. If evacuating due to fire in windy conditions, consider positioning the airplane so the fire is on the downwind side.

Notify cabin crew of possible adverse conditions at the affected exits. The availability of various exits may differ for each situation. Crewmembers must make the decision as to which exits are usable for the circumstances.

For unplanned evacuations, the captain needs to analyze the situation carefully before initiating an evacuation order. Quick actions in a calm and methodical manner improve the chances of a successful evacuation.

Method of Evacuation

When there is a need to evacuate passengers and crew, the captain has to choose between commanding an emergency evacuation using the emergency escape slides or less urgent means such as deplaning using stairs, jetways, or other means. All available sources of information should be used to determine the safest course of action including reports from the cabin crew, other airplanes, and air traffic control. The captain must then determine the best means of evacuation by carefully considering all factors. These include, but are not limited to:

- the urgency of the situation, including the possibility of significant injury or loss of life if a significant delay occurs
- the type of threat to the airplane, including structural damage, fire, reported bomb on board, etc.
- the possibility of fire spreading rapidly from spilled fuel or other flammable materials
- the extent of damage to the airplane
- the possibility of passenger injury during an emergency evacuation using the escape slides.

If in doubt, the crew should consider an emergency evacuation using the escape slides.

If there is a need to deplane passengers, but circumstances are not urgent and the captain determines that the Evacuation NNC is not needed, the normal shutdown procedure should be completed before deplaning the passengers.

777 Flight Crew Training Manual

Discharging Fire Bottles during an Evacuation

The evacuation NNC specifies discharge of the engine or APU fire bottles if an engine or APU fire warning light is illuminated. However, evacuation situations can present possibilities regarding the potential for fire that are beyond the scope of the NNC and may not activate an engine or APU fire warning. The crew should consider the following when deciding whether to discharge one or more fire bottles into the engines and/or APU:

- if an engine fire warning light is not illuminated, but a fire indication exists or a fire is reported in or near an engine, discharge both available fire bottles into the affected engine
- if the APU fire warning light is not illuminated, but a fire indication exists or a fire is reported in or near the APU, discharge the APU bottle
- the discharged halon agent is designed to extinguish a fire and has very little or no fire prevention capability in the engine nacelles. Halon dissipates quickly into the atmosphere
- there is no reason to discharge the engine or APU fire bottles for evacuations not involving fire indications existing or reported in or near an engine or APU, e.g., cargo fire, security or bomb threat, etc.

Flight Controls**Leading Edge or Trailing Edge Device Malfunctions**

Leading edge or trailing edge device malfunctions can occur during extension or retraction. This section discusses all flaps up and partial or asymmetrical leading/trailing edge device malfunctions for landings.

Note: When leading edge devices or trailing edge flaps are not in the proper position for flaps 20 or 30, autolands are not certified.

All Flaps and Slats Up Landing

The probability of both leading and trailing edge devices failing to extend is extremely remote. System reliability and design have reduced the need for some traditional non-normal landing procedures. As a result, an all flaps up landing NNC was not required for airplane certification and does not appear in the AFM or in the QRH.

Slats Drive Failure (Leading Edge) - Landing

Failure of the primary hydraulic drive for the leading edge slats causes the slats to automatically revert to the secondary mode (electric drive). The EICAS message “SLATS PRIMARY FAIL” is displayed. If the slats fail to respond in the electric drive mode or an asymmetry exists, the EICAS message “SLATS DRIVE” is displayed. The SLATS DRIVE NNC accommodates the most severe malfunction of no leading edge slats on one wing.



Flaps 1 position on the flap indicator is for leading edge devices. When flaps are extended to 1 and the leading edge devices fail to extend, the flap display expands. The flap indicator shows no trailing edge flap movement. Flap extension is limited to flaps 20 if slats are not fully extended.

The VREF specified in the QRH permits the approach to be flown wings level with the control wheel approximately level. Airplane pitch attitude at touchdown is less than normal. Do not allow the airplane to “float”. Fly the airplane onto the runway at the desired touchdown point. Exeditiously accomplish the landing roll procedure after touchdown.

Flap Drive Failure (Trailing Edge) - Landing

Failure of the primary hydraulic drive for the trailing edge flaps causes the flaps to automatically revert to the secondary mode (electric drive). The EICAS message “FLAPS PRIMARY FAIL” is displayed. If the flaps fail to respond in the electric drive mode or an asymmetry exists, the EICAS message “FLAPS DRIVE” is displayed. Accomplish the FLAPS DRIVE NNC. The inboard and outboard TE Flaps move as a single group. Flap load relief is not available in secondary mode of operation.

The VREF listed in the FLAPS DRIVE NNC allows normal maneuvering throughout the initial phases of the approach. On final, maintain VREF plus wind additive. If speed is allowed to decrease to VREF, 40° bank capability is not available.

The pitch attitude on final is several degrees higher than for normal configuration.

Do not allow the airspeed to go below VREF during the flare or the tail of the airplane may contact the runway. Do not allow the airplane to “float” just above the runway surface. Fly the airplane onto the runway at the recommended touchdown point. Exeditiously accomplish the landing roll procedure after touchdown.

Flap Extension using the Secondary or Alternate System

When extending the flaps using the secondary or alternate system, the recommended method for setting command speed differs from the method used during normal flap extension. Since the flaps extend more slowly when using the secondary or alternate system, it is recommended that the crew delay setting the new command speed until the flaps reach the selected position. This method may prevent the crew from inadvertently getting into a low airspeed condition if attention to airspeed is diverted while accomplishing other duties.

Jammed Flight Controls

Although rare, jamming of the flight control system has occurred on commercial airplanes. A jammed flight control can result from ice accumulation due to water leaks onto cables or components, dirt accumulation, component failure such as cable break or worn parts, improper lubrication, or foreign objects.

A flight control jam may be difficult to recognize, especially in a properly trimmed airplane. A jam in the pitch axis may be more difficult to recognize than a jam in other axes. In the case of the elevator, the jammed control can be masked by trim. Some indications of a jam are:

- unexplained autopilot disengagement
- autopilot that cannot be engaged
- undershoot or overshoot of an altitude during autopilot level-off
- higher than normal control forces required during speed or configuration changes.

If any jammed flight control condition exists, both pilots should apply force to try to either clear the jam or activate the override feature. There should be no concern about damaging the flight control mechanism by applying too much force to either clear a jammed flight control or activate an override feature. Maximum force may result in some flight control surface movement with a jammed flight control. If the jam clears, both pilot's flight controls are available.

Note: There are override features for the control wheel and the control column.

If the jam does not clear, activation of an override feature allows a flight control surface to be moved independent of the jammed control. Applying force to the non-jammed flight control activates the override feature. When enough force is applied, the jammed control is overridden allowing the non-jammed control to operate. To identify the non-jammed flight control, apply force to each flight control individually. The flight control that results in the greatest airplane control is the non-jammed control.

Note: The pilot of the non-jammed control should be the pilot flying for the remainder of the flight.

The non-jammed control requires a normal force, plus an additional override force to move the flight control surface. For example, if a force of 10 lbs (4 kgs) is normally needed to move the surface, and 50 lbs (23 kgs) of force is needed to activate the override, a total force of 60 lbs (27 kgs) is needed to move the control surface while in override. Response is slower than normal with a jammed flight control; however, sufficient response is available for airplane control and landing.



Individual flight control surfaces that do not respond correctly to pilot or autopilot inputs may cause either a FLIGHT CONTROLS or SPOILERS EICAS message to display. Because the flight control surfaces are electronically controlled, an individual flight control surface jam will not result in restricted movement of the control wheel, column, or pedals except to a limited extent in the case of spoilers 4 and 11.

Trim Inputs

If a jammed flight control condition exists, use manual inputs from other control surfaces to counter pressures and maintain a neutral flight control condition. The following table provides trim inputs that may be used to counter jammed flight control conditions.

Jammed Control	Manual Trim Inputs
Elevator	Stabilizer (select Direct mode to gain more stabilizer authority, if needed)
Aileron	Rudder
Rudder	Aileron

Note: Asymmetric engine thrust may aid roll and directional control if TAC is inoperative.

Approach and Landing

Attempt to select a runway with minimum crosswind. Complete approach preparations early. Recheck flight control surface operation prior to landing to determine if the malfunction still exists. Do not make abrupt thrust, speedbrake, or configuration changes. Make small bank angle changes. On final approach, do not reduce thrust to idle until after touchdown. Asymmetrical braking and asymmetrical thrust reverser deployment may aid directional control on the runway.

Note: In the event of an elevator jam, control forces will be significantly greater than normal and control response will be slower than normal to flare the airplane.

Go Around Procedure

If the elevator is known or suspected to be jammed, a go-around should be avoided if at all possible. To execute a go-around with a jammed elevator, smoothly advance throttles while maintaining pitch control with stabilizer and any available elevator. If a go-around is required, the go-around procedure is handled in the same manner as a normal go-around.

777 Flight Crew Training Manual

Inoperative Stabilizer

An inoperative stabilizer is indicated by the STABILIZER EICAS message. In contrast to airplanes with conventional flight control systems, normal pitch trim is still available in the normal flight control mode, however elevator authority is limited. The QRH specifies a maximum in-flight speed, adjusted approach speed and landing configuration that ensures adequate elevator control is available for the remainder of the flight. Use normal piloting techniques for landing.

Stabilizer

Hold the control column firmly to maintain the desired pitch attitude. If uncommanded trim motion continues, the stabilizer trim commands are interrupted when the control column is displaced in the opposite direction.

Flight Instruments, Displays**Airspeed Unreliable**

Unreliable airspeed indications can result from blocking or freezing of the pitot/static system or a severely damaged or missing radome. When the ram air inlet to the pitot head is blocked, pressure in the probe is released through the drain holes and the airspeed slowly drops to zero. If the ram air inlet and the probe drain holes are both blocked, pressure trapped within the system reacts unpredictably. The pressure may increase through expansion, decrease through contraction, or remain constant. In all cases, the airspeed indications would be abnormal. This could mean increasing indicated airspeed in climb, decreasing indicated airspeed in descent, or unpredictable indicated airspeed in cruise.

Unreliable airspeed may cause noticeable effects in the normal speed stability of the airplane since the normal pitch control law uses indicated airspeed. If the indicated airspeed falls below 50 knots, the flight control system changes to the secondary mode, which does not depend on airspeed.

The autothrottle system also uses indicated airspeed and should be turned off.

If the flight crew is aware of the problem, flight without the benefit of valid airspeed information can be safely conducted and should present little difficulty. Early recognition of erroneous airspeed indications requires familiarity with the interrelationship of attitude, thrust setting, and airspeed. A delay in recognition could result in loss of airplane control.



777 Flight Crew Training Manual

The flight crew should be familiar with the approximate pitch attitude for each flight maneuver. For example, climb performance is based on maintaining a particular airspeed or Mach number. This results in a specific body attitude that varies little with gross weight and altitude. Any significant change from the body attitude required to maintain a desired airspeed should alert the flight crew to a potential problem.

When the abnormal airspeed is recognized, immediately return the airplane to the target attitude and thrust setting for the flight regime. If continued flight without valid airspeed indications is necessary, consult the Flight With Unreliable Airspeed/Turbulent Air Penetration table in the Performance Inflight section of the QRH for the correct attitude, thrust settings, and V/S for actual airplane gross weight and altitude.

Ground speed information is available from the FMC and on the instrument displays. These indications can be used as a crosscheck. Many air traffic control radars can also measure ground speed.

For airplanes equipped with an Angle of Attack (AOA) indicator, maintain the analog needle at approximately the three o'clock position. This approximates a safe maneuvering speed or approach speed for the existing airplane configuration.

Descent

Idle thrust descents to 10,000 feet can be made by flying body attitude and checking rate of descent in the QRH tables. At 2,000 feet above the selected level off altitude, reduce rate of descent to 1,000 FPM. On reaching the selected altitude, establish attitude and thrust for the airplane configuration. If possible, allow the airplane to stabilize before changing configuration and altitude.

Approach

If available, accomplish an ILS approach. Establish landing configuration early on final approach. At glide slope intercept or beginning of descent, set thrust and attitude per the QRH tables and control the rate of descent with thrust.

Landing

Control the final approach so as to touch down approximately 1,000 feet to 1,500 feet beyond the threshold. Fly the airplane on to the runway, do not hold it off or let it "float" to touchdown.

Use autobraking if available. If manual braking is used, maintain adequate brake pedal pressure until a safe stop is assured. Immediately after touchdown, expeditiously accomplish the landing roll procedure.

Fuel

Fuel Balance

The primary purpose of fuel balance limitations on Boeing airplanes is for the structural life of the airframe and landing gear and not for controllability. A reduction in structural life of the airframe or landing gear can be caused by frequently operating with out-of-limit fuel balance conditions. Lateral control is not significantly affected when operating with fuel beyond normal balance limits.

The primary purpose for fuel balance alerts are to inform the crew that imbalances beyond the current state may result in increased trim drag and higher fuel consumption. The FUEL IMBALANCE NNC should be accomplished when a fuel balance alert is received.

There is a common misconception among flight crews that the fuel crossfeed valve should be opened immediately after an in-flight engine shutdown to prevent fuel imbalance. This practice is contrary to Boeing recommended procedures and could aggravate a fuel imbalance. This practice is especially significant if an engine failure occurs and a fuel leak is present. Arbitrarily opening the crossfeed valve and starting fuel balancing procedures, without following the checklist, can result in pumping usable fuel overboard.

The misconception may be further reinforced during simulator training. The fuel pumps in simulators are modeled with equal output pressure on all pumps so opening the crossfeed valve appears to maintain a fuel balance. However, the fuel pumps in the airplane have allowable variations in output pressure. If there is a sufficient difference in pump output pressures and the crossfeed valve is opened, fuel feeds to the operating engine from the fuel tank with the highest pump output pressure. This may result in fuel unexpectedly coming from the tank with the lowest quantity.

Fuel Balancing Considerations

The crew should consider the following when performing fuel balancing procedures:

- use of the FUEL IMBALANCE NNC in conjunction with good crew coordination reduces the possibility of crew errors
- routine fuel balancing when not near the imbalance limit increases the possibility of crew errors and does not significantly improve fuel consumption

- during critical phases of flight, fuel balancing should be delayed until workload permits. This reduces the possibility crew errors and allows crew attention to be focused on flight path control
- fuel imbalances that occur during approach need not be addressed if the reason for the imbalance is obvious (e.g. engine failure or thrust asymmetry, etc.).

Fuel Leak

Any time an unexpected fuel quantity indication, FMC or EICAS fuel message, or imbalance condition is experienced, a fuel leak should be considered as a possible cause. Maintaining a fuel log and comparing actual fuel burn to the flight plan fuel burn can help the pilot recognize a fuel leak.

Significant fuel leaks, although fairly rare, are difficult to detect. The Fuel Leak NNC assumes the leak is between the strut and the engine or in the center tank on 777-200 non ER airplanes. There is no specific fuel leak annunciation on the flight deck. A leak must be detected by discrepancies in the fuel log, by visual confirmation, or by some annunciation that occurs because of a leak. Any unexpected change in fuel quantity or fuel balance should alert the crew to the possibility of a leak. If a leak is suspected, it is imperative to follow the NNC.

The NNC leads the crew through steps to determine if the fuel leak is from the engine area. If an engine fuel leak is confirmed, the NNC directs the crew to shutdown the affected engine. There are two reasons for the shutdown. The first is to prevent loss of fuel which could result in a low fuel state. The second reason is that the fire potential is increased when fuel is leaking around the engine. The risk of fire increases further when the thrust reverser is used during landing. The thrust reverser significantly changes the flow of air around the engine which can disperse fuel over a wider area.

Low Fuel

A low fuel condition exists when the EICAS message FUEL QTY LOW is displayed.

Approach and Landing

In a low fuel condition, the clean configuration should be maintained as long as possible during the descent and approach to conserve fuel. However, initiate configuration changes early enough to provide a smooth, slow deceleration to final approach speed to prevent fuel from running forward in the tanks.

The FUEL QTY LOW NNC specifically calls for a flaps 20 approach and landing rather than a normal landing configuration as in other models. Testing and analysis shows that elevator authority at flaps 30 approach speeds is not adequate to enable the crew to successfully flare the airplane for landing in the unlikely event both engines failed in the landing configuration.

777 Flight Crew Training Manual

Runway conditions permitting, heavy braking and high levels of reverse thrust should be avoided to prevent uncovering all fuel pumps and possible engine flameout during landing roll.

Go-Around

If a go-around is necessary, apply thrust slowly and smoothly and maintain the minimum nose-up body attitude required for a safe climb gradient. Avoid rapid acceleration of the airplane. If any wing tank fuel pump low pressure light illuminates, do not turn the fuel pump switches off.

Fuel Jettison

Fuel jettison should be considered when situations dictate landing at high gross weights and adequate time is available to perform the jettison. When fuel jettison is to be accomplished, consider the following:

- ensure adequate weather minimums exist at airport of intended landing
- fuel jettison above 4,000 feet AGL ensures complete fuel evaporation
- downwind drift of fuel may exceed one NM per 1,000 feet of drop
- avoid jettisoning fuel in a holding pattern with other airplanes below.

Hydraulics

Proper planning of the approach is important. Consideration should be given to the effect the inoperative system(s) has on crosswind capabilities, autoflight, stabilizer trim, control response, control feel, reverse thrust, stopping distance, go-around configuration and performance required to reach an alternate airfield.

Hydraulic System(s) Inoperative - Landing

If the landing gear is extended using alternate gear extension, the gear cannot be raised. Flaps can be extended or retracted using the secondary drive system. However, the rate of flap travel is significantly reduced.

Flaps 20 and the VREF specified in the QRH are used for landing with multiple hydraulic systems inoperative to improve flare authority, control response and go-around capability. The airplane may tend to float during the flare. Do not allow the airplane to float. Fly the airplane onto the runway at the recommended point.

If nose wheel steering is inoperative and any crosswind exists, consideration should be given to landing on a runway where braking action is reported as good or better. Braking action becomes the primary means of directional control below approximately 60 knots where the rudder becomes less effective. If controllability is satisfactory, taxi clear of the runway using differential thrust and brakes.

Continued taxi with nose wheel steering inoperative is not recommended due to airplane control difficulties and heat buildup in the brakes.

Landing Gear

Tire Failure during or after Takeoff

If the crew suspects a tire failure during takeoff, the Air Traffic Service facility serving the departing airport should be advised of the potential for tire pieces remaining on the runway. The crew should consider continuing to the destination unless there is an indication that other damage has occurred (non-normal engine indications, engine vibrations, hydraulic system failures or leaks, etc.).

Continuing to the destination will allow the airplane weight to be reduced normally, and provide the crew an opportunity to plan and coordinate their arrival and landing when the workload is low.

Considerations in selecting a landing airport include, but are not limited to:

- sufficient runway length and acceptable surface conditions to account for the possible loss of braking effectiveness
- sufficient runway width to account for possible directional control difficulties
- altitude and temperature conditions that could result in high ground speeds on touchdown and adverse taxi conditions
- runway selection options regarding "taxi-in" distance after landing
- availability of operator maintenance personnel to meet the airplane after landing to inspect the wheels, tires, and brakes before continued taxi
- availability of support facilities should the airplane need repair.

Landing on a Flat Tire

Boeing airplanes are designed so that the landing gear and remaining tire(s) have adequate strength to accommodate a flat nose gear tire or main gear tire. When the pilot is aware of a flat tire prior to landing, use normal approach and flare techniques, avoid landing overweight and use the center of the runway. Use differential braking as needed for directional control. With a single tire failure, towing is not necessary unless unusual vibration is noticed or other failures have occurred.

In the case of a flat nose wheel tire, slowly and gently lower the nose wheels to the runway while braking lightly. Runway length permitting, use idle reverse thrust. Autobrakes may be used at the lower settings. Once the nose gear is down, vibration levels may be affected by increasing or decreasing control column back pressure. Maintain nose gear contact with the runway.

Flat main gear tire(s) cause a general loss of braking effectiveness and a yawing moment toward the flat tire with light or no braking and a yawing moment away from the flat tire if the brakes are applied harder. Maximum use of reverse thrust is recommended. Do not use autobrakes.

777 Flight Crew Training Manual

If uncertain whether a nose tire or a main tire has failed, slowly and gently lower the nose wheels to the runway and do not use autobrakes. Differential braking may be required to steer the airplane. Use idle or higher reverse thrust as needed to stop the airplane.

Note: Extended taxi distances or fast taxi speeds can cause significant increases in temperatures on the remaining tires.

Gear Disagree

Land on all available gear. The landing gear absorbs the initial shock and delays touchdown of airplane body parts. Recycling the landing gear in an attempt to extend the remaining gear is not recommended. A gear up or partial gear landing is preferable to running out of fuel while attempting to solve a gear problem.

Landing Runway

Consideration should be given to landing at the most suitable airport with adequate runway and fire fighting capability. Foaming the runway is not necessary. Tests have shown that foaming provides minimal benefit and it takes approximately 30 minutes to replenish the fire truck's foam supply.

Prior to Approach

If time and conditions permit, reduce weight as much as possible by burning off or jettisoning fuel to attain the slowest possible touchdown speed.

At the captain's command, advise the crew and the passengers of the situation, as needed. Coordinate with all ground emergency facilities. For example, fire trucks normally operate on a common VHF frequency with the airplane and can advise the crew of the airplane condition during the landing. Advise the cabin crew to perform emergency landing procedures and to brief passengers on evacuation procedures.

The NNC instructs the crew to inhibit the ground proximity system as needed to prevent nuisance warnings when close to the ground with the gear retracted.

For landing in any gear configuration, establish approach speed early and maintain a normal rate of descent.

Landing Techniques

Attempt to keep the airplane on the runway to minimize airplane damage and aid in evacuation. After touchdown lower the nose gently before losing elevator effectiveness. Use all aerodynamic capability to maintain directional control on the runway. At touchdown speed, the rudder has sufficient authority to provide directional control in most configurations. At speeds below 60 knots, use nose wheel/rudder pedal steering, if available, and differential braking as needed.



Use of Speedbrakes

During a partial gear or gear up landing, speedbrakes should be extended only when stopping distance is critical. Extending the speedbrakes before all gear, or the nose or the engine nacelle in the case of a gear that does not extend, have contacted the runway may compromise controllability of the airplane.

When landing with any gear that indicates up or partially extended, attempt to fly the area with the unsafe indication smoothly to the runway at the lowest speed possible, but before losing flight control effectiveness. A smooth touchdown at a low speed helps to reduce airplane damage and offers a better chance of keeping the airplane on the runway. Since the airplane is easier to control before body parts make ground contact, delay extending the speedbrakes until after the nose and both sides of the airplane have completed touchdown. If the speedbrakes are deployed before all areas have made contact with the runway, the airplane will complete touchdown sooner and at a higher speed.

Some crews or operators may elect to avoid the use of speedbrakes during any gear disagree event. However, most gear disagree events are the result of an indicator malfunction rather than an actual gear up condition. If the crew elects not to use speedbrakes during landing, be aware that stopping distance may rapidly become critical if all gear remain extended throughout touchdown and rollout.

Use of Reverse Thrust

During a partial gear or gear up landing, an engine making ground contact could suffer sufficient damage such that the thrust reverser mechanism may not operate. Selecting reverse thrust with any gear not extended may produce an additional asymmetric condition that makes directional control more difficult. Reverse thrust should be used only when stopping distance is critical.

If reverse thrust is needed, keep in mind that the airplane is easier to control before body parts make ground contact. If the thrust reversers are deployed before all gear, or the nose or the engine nacelle in the case of a gear that does not extend, have made contact with the runway, the airplane will complete touchdown sooner and at a higher speed.

After Stop

Accomplish an evacuation, if needed.

Gear Disagree Combinations

Both Main Gear Extended with Nose Gear Up

Land in the center of the runway. After touchdown lower the nose gently before losing elevator effectiveness.

777 Flight Crew Training Manual

Nose Gear Only Extended

Land in the center of the runway. Use normal approach and flare attitudes maintaining back pressure on the control column until ground contact. The engines contact the ground prior to the nose gear.

One Main Gear Extended and Nose Gear Extended

Land the airplane on the side of the runway that corresponds to the extended main gear down. At touchdown, maintain wings level as long as possible. Use rudder and nose wheel steering for directional control. After all gear, or the engine nacelle where the gear is not extended, have made contact with the runway, braking on the side opposite the unsupported wing should be used as needed to keep the airplane rolling straight.

One Main Gear Only Extended

Land the airplane on the side of the runway that corresponds to the extended main gear down. At touchdown, maintain wings level as long as possible. Use rudder for directional control. After all gear, or the nose or the engine nacelle in the case of gear that do not extend, have made contact with the runway, braking on the side opposite the unsupported wing should be used as needed to keep the airplane rolling straight.

All Gear Up or Partially Extended

Land in the center of the runway. The engines contact the ground first. There is adequate rudder available to maintain directional control during the initial portion of the ground slide. Attempt to maintain the centerline while rudder control is available.

Overspeed

VMO/MMO is the airplane maximum certified operating speed and should not be exceeded intentionally. However, crews can occasionally experience an inadvertent overspeed. Airplanes have been flight tested beyond VMO/MMO to ensure smooth pilot inputs will return the airplane safely to the normal flight envelope.

During cruise at high altitude, wind speed or direction changes may lead to overspeed events. Although autothrottle logic provides for more aggressive control of speed as the airplane approaches VMO or MMO, there are some conditions that are beyond the capability of the autothrottle system to prevent short term overspeeds.



777 Flight Crew Training Manual

When correcting an overspeed during cruise at high altitude, avoid reducing thrust to idle which results in slow engine acceleration back to cruise thrust and may result in over-controlling the airspeed or a loss of altitude. If autothrottle corrections are not satisfactory, deploy partial speedbrakes slowly until a noticeable reduction in airspeed is achieved. When the airspeed is below VMO/MMO, retract the speedbrakes at the same rate as they were deployed. The thrust levers can be expected to advance slowly to achieve cruise airspeed; if not, they should be pushed up more rapidly.

During descents at or near VMO/MMO, most overspeeds are encountered after the autopilot initiates capture of the VNAV path from above or during a level-off when the speedbrakes were required to maintain the path. In these cases, if the speedbrakes are retracted during the level-off, the airplane can momentarily overspeed. During descents using speedbrakes near VMO/MMO, delay retraction of the speedbrakes until after VNAV path or altitude capture is complete. Crews routinely climbing or descending in windshear conditions may wish to consider a 5 to 10 knot reduction in climb or descent speeds to reduce overspeed occurrences. This will have a minimal effect on fuel consumption and total trip time.

When encountering an inadvertent overspeed condition, crews should leave the autopilot engaged unless it is apparent that the autopilot is not correcting the overspeed. However, if manual inputs are required, disengage the autopilot. Be aware that disengaging the autopilot to avoid or reduce the severity of an inadvertent overspeed may result in an abrupt pitch change.

During climb or descent, if VNAV or FLCH pitch control is not correcting the overspeed satisfactorily, switching to the V/S mode temporarily may be helpful in controlling speed. In the V/S mode, the selected vertical speed can be adjusted slightly to increase the pitch attitude to help correct the overspeed. As soon as the speed is below VMO/MMO, VNAV or FLCH may be re-selected.

Note: Anytime VMO/MMO is exceeded, the maximum airspeed should be noted in the flight log.

Tail Strike

Tail strike occurs when the lower aft fuselage or tail skid (as installed) contacts the runway during takeoff or landing. A significant factor that appears to be common is the lack of flight crew experience in the model being flown. Understanding the factors that contribute to a tail strike can reduce the possibility of a tail strike occurrence.

Note: Anytime fuselage contact is suspected or known to have occurred, accomplish the appropriate NNC.

Takeoff Risk Factors

Any one of the following takeoff risk factors may precede a tail strike:

Mistrimmed Stabilizer

This usually results from using erroneous takeoff data, e.g., the wrong weights, or an incorrect center of gravity (CG). In addition, sometimes accurate information is entered incorrectly either in the flight management system (FMS) or set incorrectly on the stabilizer. The flight crew can prevent this type of error and correct the condition by challenging the reasonableness of the load sheet numbers. Comparing the load sheet numbers against past experience in the airplane can assist in approximating numbers that are reasonable.

Rotation at Improper Speed

This situation can result in a tail strike and is usually caused by early rotation due to some unusual situation, or rotation at too low an airspeed for the weight and/or flap setting.

Trimming during Rotation

Trimming the stabilizer during rotation may contribute to a tail strike. The pilot flying may easily lose the feel of the elevator while the trim is running which may result in an excessive rotation rate.

Excessive Rotation Rate

Flight crews operating an airplane model new to them, especially when transitioning from an airplane with unpowered flight controls to one with hydraulic assistance, are most vulnerable to using excessive rotation rate. The amount of control input required to achieve the proper rotation rate varies from one model to another. When transitioning to a new model, flight crews may not realize that it does not respond to pitch input in exactly the same way as their previous model.

Improper Use of the Flight Director

The flight director provides accurate pitch guidance only after the airplane is airborne. With the proper rotation rate, the airplane reaches 35 feet with the desired pitch attitude of about 15°. However, an aggressive rotation into the pitch bar at takeoff is not appropriate and can cause a tail strike.

Landing Risk Factors

A tail strike on landing tends to cause more serious damage than the same event during takeoff and is usually more expensive and time consuming to repair. In the worst case, the tail can strike the runway before the landing gear, thus absorbing large amounts of energy for which it is not designed. The aft pressure bulkhead is often damaged as a result.

Any one of the following landing risk factors may precede a tail strike:

Unstabilized Approach

An unstabilized approach is the biggest single cause of tail strike. Flight crews should stabilize all approach variables - on centerline, on approach path, on speed, and in the final landing configuration - by the time the airplane descends through 1,000 feet AFE. This is not always possible. Under normal conditions, if the airplane descends through 1,000 feet AFE (IMC), or 500 feet AFE (VMC), with these approach variables not stabilized, a go-around should be considered.

Flight recorder data show that flight crews who continue with an unstabilized condition below 500 feet seldom stabilize the approach. When the airplane arrives in the flare, it often has either excessive or insufficient airspeed. The result is a tendency toward large thrust and pitch corrections in the flare, often culminating in a vigorous pitch change at touchdown resulting in tail strike shortly thereafter. If the pitch is increased rapidly when touchdown occurs as ground spoilers deploy, the spoilers add additional nose up pitch force, reducing pitch authority, which increases the possibility of tail strike. Conversely, if the airplane is slow, increasing the pitch attitude in the flare does not effectively reduce the sink rate; and in some cases, may increase it.

A firm touchdown on the main gear is often preferable to a soft touchdown with the nose rising rapidly. In this case, the momentary addition of thrust may aid in preventing the tail strike. In addition, unstabilized approaches can result in landing long or a runway over run.

Holding Off in the Flare

The second most common cause of a landing tail strike is an extended flare, with a loss in airspeed that results in a rapid loss of altitude, (a dropped-in touchdown). This condition is often precipitated by a desire to achieve an extremely smooth/soft landing. A very smooth/soft touchdown is not essential, nor even desired, particularly if the runway is wet.

777 Flight Crew Training Manual

Trimming in the Flare

Trimming the stabilizer in the flare may contribute to a tail strike. The pilot flying may easily lose the feel of the elevator while the trim is running. Too much trim can raise the nose, even when this reaction is not desired. The pitch up can cause a balloon, followed either by dropping in or pitching over and landing in a three-point attitude. Flight crews should trim the airplane during the approach, but not in the flare.

Mishandling of Crosswinds

When the airplane is placed in a forward slip attitude to compensate for the wind effects, this cross-control maneuver reduces lift, increases drag, and may increase the rate of descent. If the airplane then descends into a turbulent surface layer, particularly if the wind is shifting toward the tail, the stage is set for tail strike.

The combined effects of high closure rate, shifting winds with the potential for a quartering tail wind, can result in a sudden drop in wind velocity commonly found below 100 feet. Combining this with turbulence can make the timing of the flare very difficult. The pilot flying can best handle the situation by using additional thrust, if needed, and by using an appropriate pitch change to keep the descent rate stable until initiation of the flare. Flight crews should clearly understand the criteria for initiating a go-around and plan to use this time-honored avoidance maneuver when needed.

Over-Rotation during Go-Around

Go-arounds initiated very late in the approach, such as during the landing flare or after touching down, are a common cause of tail strikes. When the go-around mode is initiated, the flight director immediately commands a go-around pitch attitude. If the pilot flying abruptly rotates up to the pitch command bar, a tail strike can occur before the airplane responds and begins climbing. During a go-around, an increase in thrust as well as a positive pitch attitude is needed. If the thrust increase is not adequate for the increased pitch attitude, the resulting speed decay will likely result in a tail strike. Another contributing factor in tail strikes may be a strong desire by the flight crew to avoid landing gear contact after initiating a late go-around when the airplane is still over the runway. In general, this concern is not warranted because a brief landing gear touchdown during a late go-around is acceptable. This had been demonstrated during autoland and go-around certification programs.



Warning Systems

If an unexpected landing gear configuration or GPWS alert occurs, the flight crew must ensure the proper configuration for the phase of flight. Time may be required in order to assess the situation, take corrective action and resolve the discrepancy. Flight path control and monitoring of instruments must never be compromised.

Note: If the warning occurs during the approach phase, a go-around may be necessary, followed by holding or additional maneuvering.

Wheel Well Fire

Prompt execution of the Wheel Well Fire NNC following a wheel well fire warning is important for timely gear extension. Landing gear speed limitations should be observed during this checklist.

Note: To avoid unintended deceleration below the new target airspeed, the autothrottle should remain engaged.

If airspeed is above 270 knots/.82 Mach, the airspeed must be reduced before extending the landing gear. Either of the following techniques results in the autothrottle reverting to the SPD mode and provides a more rapid speed reduction than using VNAV speed intervention or FLCH.

- select altitude hold and set approximately 250 knots
- set the MCP altitude to a desired level off altitude and use speed intervention to reduce airspeed.

Note: Additionally, the thrust levers may be reduced to idle and/or the speedbrakes may be used to expedite deceleration.

If the pitch mode is VNAV and the crew wishes to remain in that mode, select speed intervention to open the MCP command speed window and then set approximately 250 knots. If the pitch mode is FLCH and the crew wishes to remain in that mode, simply set approximately 250 knots. These techniques do not result in as rapid a speed reduction as reverting to the SPD mode, but allows the crew to remain in the pitch mode in use.

Windows

Window Damage

If both forward windows delaminate or forward vision is unsatisfactory, accomplish an ILS autoland, if available.

777 Flight Crew Training Manual

Flight with the Side Window(s) Open

The inadvertent opening of an unlatched flight deck window by air loads during the takeoff roll is not considered an event that warrants a high speed RTO.

Although the resulting noise levels may interfere with crew communications, it is safer to continue the takeoff and close the window after becoming airborne and the flight path is under control. The flight may be continued once the window is closed and locked and pressurization is normal. If the window is damaged and will not close, return to the departure airport.

If needed, the windows may be opened in-flight after depressurizing the airplane. It is recommended that the airplane be slowed since the noise levels increase at higher airspeed. Maneuvering speed for the flap setting in use is a good target speed. Intentions should be briefed and ATC notified prior to opening the window as the noise level can be high and make communications difficult, even at slow speeds. However, there is very little turbulence on the flight deck. Because of airplane design, there is an area of relatively calm air over the open window. Forward visibility can be maintained by looking out of the open window using care to stay clear of the airstream.

Situations Beyond the Scope of Non-Normal Checklists

It is rare to encounter in-flight events which are beyond the scope of the Boeing recommended NNCs. These events can arise as a result of unusual occurrences such as a midair collision, bomb explosion or other major malfunction. In these situations the flight crew may be required to accomplish multiple NNCs, selected elements of several different NNCs applied as necessary to fit the situation, or be faced with little or no specific guidance except their own judgment and experience. Because these situations are rare, it is not practical or possible to create definitive flight crew NNCs to cover all events.

The following guidelines may aid the flight crew in determining the proper course of action should an in-flight event of this type be encountered. Although these guidelines represent what might be called “conventional wisdom”, circumstances determine the course of action which the crew perceives will conclude the flight in the safest manner.

Basic Aerodynamics and Systems Knowledge

Knowledge of basic aerodynamic principles and airplane handling characteristics and a comprehensive understanding of airplane systems can be key factors in situations of this type.

**777 Flight Crew Training Manual**

Basic aerodynamic principles are known and understood by all pilots. Although not a complete and comprehensive list, following is a brief review of some basic aerodynamic principles and airplane systems information relevant to such situations:

- if aileron control is affected, rudder inputs can assist in countering unwanted roll tendencies. The reverse is also true if rudder control is affected
- if both aileron and rudder control are affected, the use of asymmetrical engine thrust may aid roll and directional control
- if elevator control is affected, stabilizer trim, bank angle and thrust can be used to control pitch attitude. To do this effectively, engine thrust and airspeed must be coordinated with stabilizer trim inputs. The airplane continues to pitch up if thrust is increased and positive corrective action is not taken by re-trimming the stabilizer. Flight crews should be aware of the airplane's natural tendency to oscillate in the pitch axis if the stable pitch attitude is upset. These oscillations are normally self damping in Boeing airplanes, but to ensure proper control, it may be desirable to use thrust and/or stabilizer trim to hasten damping and return to a stable condition. The airplane exhibits a pitch up when thrust is increased and a pitch down when thrust is decreased when operating in any flight control mode other than normal. Use caution when attempting to dampen pitch oscillations by use of engine thrust so that applications of thrust are timed correctly, and diverging pitch oscillations do not develop
- a flight control break-out feature is designed into all Boeing airplanes. If a jammed flight control exists, both pilots can apply force to either clear the jam or activate the break-out feature. There should be no concern about damaging the mechanism by applying too much force. In certain cases, clearing the jam may permit one of the control columns to operate the flight controls with portions of a control axis jammed. It may be necessary to apply break-out forces for the remainder of the flight on the affected control axis
- stall margin decreases with angle of bank and increasing load factors. Therefore, it is prudent to limit bank angle to 15° in the event maneuvering capability is in question. Increasing the normal flap/speed maneuvering schedule while staying within flap placard limits provides extra stall margin where greater bank angles are necessary
- all Boeing airplanes have the capability to land using any flap position, including flaps up. Use proper maneuvering and final approach speeds and ensure adequate runway is available to stop the airplane after landing.

Flight Path Control

When encountering an event of the type described above, the flight crew's first consideration should be to maintain or regain full control of the airplane and establish an acceptable flight path. This may require use of unusual techniques such as the application of full aileron or rudder or in an asymmetrical thrust situation, reduction of thrust on the operating engine(s) to regain lateral control. This may also require trading altitude for airspeed or vice versa. The objective is to take whatever action is necessary to control the airplane and maintain a safe flight path. Even in a worst case condition where it is not possible to keep the airplane flying and ground contact is imminent, a "controlled crash" is a far better alternative than uncontrolled flight into terrain.

Fuel jettison should be a primary consideration if airplane performance appears to be critical. In certain cases, this may also have a positive effect on lateral controllability.

If the operation of flaps is in doubt, leading and trailing edge flap position should not be changed unless it appears that airplane performance immediately requires such action. Consideration should be given to the possible effects of an asymmetrical flap condition on airplane control if flap position is changed. If no flap damage exists, wing flaps should be operated as directed in the associated NNC. Anytime an increasing rolling moment is experienced during flap transition (indicating a failure to automatically shutdown an asymmetric flap situation), return the flap handle to the previous position.

Unusual events adversely affecting airplane handling characteristics while airborne may continue to adversely affect airplane handling characteristics during landing ground roll. Aggressive differential braking and/or use of asymmetrical reverse thrust, in addition to other control inputs, may be required to maintain directional control.

Checklists with Memory Steps

After flight path control has been established, do the memory steps of the appropriate NNC. The emphasis at this point should be on containment of the problem. Reference steps are initiated after the airplane flight path and configuration are properly established.

Complete all applicable NNCs prior to beginning final approach. Exercise common sense and caution when accomplishing multiple NNCs with conflicting directions. The intended course of action should be consistent with the damage assessment and handling evaluation.

Communications

Establish flight deck communications as soon as possible. This may require use of the flight deck interphone system or, in extreme cases of high noise levels, hand signals and gestures in order to communicate effectively.

Declare an emergency with Air Traffic Control (ATC) to assure priority handling and emergency services upon landing. Formulate an initial plan of action and inform ATC. If possible, request a discrete radio frequency to minimize distractions and frequency changes. If unable to establish radio communication with ATC, squawk 7700 and proceed as circumstances dictate.

Communications with the cabin crew and with company ground stations are important, but should be accomplished as time permits. If an immediate landing is required, inform the cabin crew as soon as possible.

Damage Assessment and Airplane Handling Evaluation

Unless circumstances such as imminent airplane breakup or loss of control dictate otherwise, the crew should take time to assess the effects of the damage and/or conditions before attempting to land. Make configuration and airspeed changes slowly until a damage assessment and airplane handling evaluation have been done and it is certain that lower airspeeds can be safely used. In addition, limit bank angle to 15° and avoid large or rapid changes in engine thrust and airspeed that might adversely affect controllability. If possible, conduct the damage assessment and handling evaluation at an altitude that provides a safe margin for recovery should flight path control be inadvertently compromised. It is necessary for the flight crew to use good judgment in consideration of the existing conditions and circumstances to determine an appropriate altitude for this evaluation.

The evaluation should start with an examination of flight deck indications to assess damage. Consideration should be given to the potential cumulative effect of the damage. A thorough understanding of airplane systems operation can greatly facilitate this task.

If structural damage is suspected, attempt to assess the magnitude of the damage by direct visual observation from the flight deck and/or passenger cabin. While only a small portion of the airplane is visible to the flight crew from the flight deck, any visual observation data can be used to gain maximum knowledge of airplane configuration and status and can be valuable in determining subsequent actions.

The flight crew should consider contacting the company to inform them of the situation and use them as a potential source of information. In addition to current and forecast weather, and airfield conditions, it may be possible to obtain technical information and recommendations from expert sources. These expert sources are available from within the company as well as from Boeing.

777 Flight Crew Training Manual

If controllability is in question, consider performing a check of the airplane handling characteristics. The purpose of this check is to determine minimum safe speeds and the appropriate configuration for landing. If flap damage has occurred, prior to accomplishing this check, consider the possible effects on airplane control should an asymmetrical condition occur if flap position is changed. Accomplish this check by slowly and methodically reducing speed and lowering the flaps. Lower the landing gear only if available thrust allows.

As a starting point, use the flap/speed schedule as directed in the appropriate NNC. If stick shaker or initial stall buffet are encountered at or before reaching the associated flap speed, or if a rapid increase in wheel deflection and full rudder deflection are necessary to maintain wings level, increase speed to a safe level and consider this speed to be the minimum approach speed for the established configuration.

After the damage assessment and handling characteristics are evaluated, the crew should formulate a sequential plan for the completion of the flight.

If the airplane is very difficult to control, as a last resort consider disconnecting the primary flight control computers. Once disconnected, leave them disconnected for the remainder of the flight unless the disconnect makes the situation worse.

If airplane performance is a concern, use of the alternate flap or gear extension systems may dictate that the check of airplane handling characteristics be done during the actual approach. Configuration changes made by the alternate systems may not be reversible. The crew must exercise extreme caution on final approach with special emphasis on minimum safe speeds and proper airplane configuration. If asymmetrical thrust is being used for roll control or pitch authority is limited, plan to leave thrust on until touchdown.

Landing Airport

The following items should be considered when selecting an airport for landing:

- weather conditions (VMC preferred)
- enroute time
- length of runway available (longest possible runway preferred, wind permitting)
- emergency services available
- flight crew familiarity
- other factors dictated by the specific situation.



Intentionally
Blank



777 Flight Crew Training Manual

**Appendices
Operational Information**

**Appendix A
Section 1**

Preface

Information contained in this appendix is provided by the operator of organizations that use the 777 Flight Crew Training Manual.



Intentionally
Blank



Preface

Recommendations contained in this appendix are provided for the operations staff of operators that use the 777 Flight Crew Training Manual. Recommendations are based on Boeing experience, and are intended as guidance for consideration by each operator. Individual operators are responsible for determining the applicability of these recommendations to their operations. Some of these recommendations may need to be coordinated with applicable regulatory agencies.

Operational Philosophy

Events Requiring Maintenance Inspection

FCTM 1.1

Most operators establish procedures or policies to ensure that aircrews document ground or flight events which require a maintenance inspection after flight. Chapter 5 of the Aircraft Maintenance Manual (AMM) refers to such events as “Conditional Inspections”. Additional events, that are not listed in chapter 5 but may require maintenance inspection, should also be addressed.

Cold Temperature Altitude Corrections

FCTM 1.22

Operator coordination with local and en route air traffic control facilities is recommended for each cold weather airport or route in the system. Coordination should include:

- confirmation that minimum assigned altitudes or flight levels provide adequate terrain clearance for the coldest expected temperatures
- cold weather altitude correction procedures to be used for published procedures, to include the table being used
- a determination of which procedures or routes, if any, that have been designed for cold temperatures and can be flown as published (without altitude corrections).

RNAV Operations

Basic RNP Concept

FCTM 1.29

Operators should select FMC default values for RNP that meet the requirements of their route structure or terminal area procedures.

GPS Use in Non-WGS-84 Reference Datum Airspace

FCTM 1.33

Operators should consult appropriate sources to determine the current status of airspace in which they operate. Recommendations for operators are as follows:

- provided operational approval has been received and measures to ensure their accuracy have been taken, RNAV approaches may be flown with GPS updating enabled. Options available to operators may include surveys of the published approaches to determine if significant differences or position errors exist, developing special RNAV procedures complying with WGS-84 or equivalent, or inhibiting GPS updating
- for approaches based upon ground-based navigation aids such as ILS, VOR, LOC, NDB, etc., the GPS updating need not be inhibited provided that appropriate raw data is used throughout the approach and missed approach as the primary navigation reference. LNAV and VNAV may be used. As always, when a significant difference exists between the airplane position, raw data course, DME and/or bearing information, discontinue use of LNAV and VNAV. Provided the FMC is not used as the primary means of navigation for approaches, this method can be used as the “other appropriate procedure” in lieu of inhibiting GPS updating.

Operators are encouraged to survey their navigation databases and have all non-WGS-84 procedures eliminated or modified to WGS-84 standards.

AFDS Guidelines

MCP Altitude Setting Techniques Using VNAV

Alternate MCP Altitude Setting Technique

FCTM 1.36

Operators who wish to use the alternate MCP altitude setting technique for closely spaced altitude constraints should ensure crews are aware of the criticality of remaining in VNAV PTH and the potential for crew error. Operators should evaluate departures, arrivals, and approaches to determine which MCP technique is most appropriate and establish appropriate guidance and training to ensure that crews fully understand the following:

- to which terminal procedures this alternate technique applies
- during departures or arrivals, the selection of a pitch mode other than VNAV PTH or VNAV SPD will result in a risk of violating procedure altitude constraints.
- the possibility of deleting waypoints if altitude intervention is selected as described in chapter 5.

Note: Operators may also wish to use the alternate MCP altitude setting technique for Tailored Arrivals (TA) regardless of how closely the altitude constraints are spaced.

Push Back or Towing

FCTM 2.2

777 Flight Crew Training Manual

The development of specific pushback and towing procedures and policies are recommended which are tailored for specific operations. The flight operations and maintenance departments need to be primary in developing these procedures.

Proper training of both pilots and ground maintenance and good communication between the flight deck and ground personnel are essential for a safe operation.

Engine Out Taxi

FCTM 2.15

If operator policies, procedures and flight crew familiarization materials are appropriately applied, EOT operations can be conducted safely and should be acceptable to flight crews and regulatory authorities.

Operator policies, procedures and flight crew familiarization materials should include, but not be limited to the following:

- airport layout
- taxiway composition
- taxiway slope
- foreign object damage (FOD)
- airplane system redundancy
- engine warm-up and cool down times
- fuel balancing
- crew workload and heads-down time
- current weather, including temperature and wind
- current taxiway surface conditions

Each operator should establish Standard Operating Procedures (SOP) for EOT operations. These SOPs should provide the flight crew with clear, concise guidance for EOT operations.

More information on EOT operations is available in the Boeing Flight Operations Technical Bulletin titled "Engine Out Taxi". This Bulletin can be found on MyBoeingFleet.

Crosswind Takeoff

Takeoff Crosswind Guidelines

FCTM 3.11

Crosswind guidelines are not considered limitations. Crosswind guidelines are provided to assist operators in establishing their own crosswind policies.

Low Visibility Takeoff

FCTM 3.17

Low visibility takeoff operations, below landing minima, may require a takeoff alternate. When selecting a takeoff alternate, consideration should be given to unexpected events such as an engine failure or other non-normal situation that could affect landing minima at the takeoff alternate. Operators, who have authorization for engine inoperative Category II/III operations, may be authorized lower alternate minima.

With proper crew training and appropriate runway lighting, takeoffs with visibility as low as 500ft/150m RVR may be authorized (FAA). With takeoff guidance systems and centerline lighting that meets FAA or ICAO criteria for Category III operations, takeoffs with visibility as low as 300ft/75m RVR may be authorized. Regulatory agencies may impose takeoff crosswind limits specifically for low visibility takeoffs.

All RVR readings must be equal to or greater than required takeoff minima. If the touchdown or rollout RVR system is inoperative, the mid RVR may be substituted for the inoperative system. When the touchdown zone RVR is inoperative, pilot estimation of RVR may be authorized by regulatory agencies.

Adverse Runway Conditions

FCTM 3.17

Most operators specify weight reductions to the AFM field length and/or obstacle limited takeoff weight based upon the depth of powdery snow, slush, wet snow or standing water and a maximum depth where the takeoff should not be attempted.

Cruise

Maximum Altitude

FCTM 4.6

The minimum maneuver speed indication on the speed tape or airspeed display does not guarantee the ability to maintain level flight at that speed. Decelerating the airplane to the amber band may create a situation where it is impossible to maintain speed and/or altitude because as speed decreases airplane drag may exceed available thrust, especially while turning. Operators may wish to reduce exposure to this situation by changing the FMC parameters (via maintenance action) to suit individual operator needs. Flight crews intending to operate at or near the maximum operation altitude should be familiar with the performance characteristics of the airplane in these conditions.

Optimum Altitude

FCTM 4.7

Low Fuel Temperature

FCTM 4.9

777 Flight Crew Training Manual

Boeing has developed a Fuel Temperature Prediction Program (FTPP) to assist operators in addressing fuel freezing point concerns. This program is designed to be used during the flight planning process and is intended to interface with or be incorporated in an operator's flight planning system. It has been calibrated by flight test and operational data. This program enables the crew to determine if fuel temperature is a concern, helps to determine available options, and may prevent the need for in-flight crew action to stop the decline in fuel temperature.

ETOPS**ETOPS Requirements and Approval****FCTM 4.14**

Operators conducting ETOPS are required to comply with FAA regulations, FAA Advisory Circulars, or governing rules of other regulatory agencies. An operator must have an ETOPS configured airplane, and approved flight operations and maintenance programs in place to support ETOPS.

The operator ensures that the ETOPS airplane is in compliance with the requirements of the appropriate Configuration, Maintenance and Procedures (CMP) documents. The operator's maintenance department must develop programs which monitor and report reliability of the engines, airframe and ETOPS significant components. The Minimum Equipment List (MEL) and the Dispatch Deviations Guide (DDG) have been expanded to address the improved redundancy levels and the additional equipment unique to ETOPS configured airplanes.

Note: Reference MyBoeingFleet for more information on ETOPS.

Flight and Performance**FCTM 4.14**

Critical fuel calculations are part of the ETOPS dispatch process and are not normally calculated by the flight crew. The crew normally receives ETOPS critical fuel information in the Computer Flight Plan (CFP).

Polar Operations**FCTM 4.15**

Operators should develop a remote airport diversion plan to include supporting the airplane, passengers, and crew. Airplane equipment and document needs to be considered include, but are not necessarily limited to:

- cold weather clothing to enable a minimum of two crewmembers to exit the airplane at a diversion airport with extreme cold conditions
- comprehensive instructions on securing the airplane for cold weather to include draining water tanks, etc.
- diversion airport data to include airport diagrams, information on nearby terrain and photographs (if available), emergency equipment availability, etc.

Approach

Approach Category

FCTM 5.2

An operator may use a different approach category as determined in coordination with the applicable regulatory authority.

ILS Approach

Low Visibility Approaches

AFDS System Configuration

FCTM 5.20

The airplane equipment needed for Category II and Category III approaches is contained in the AFM. Operators are responsible for reviewing their AFM to determine equipment needed and submit these requirements along with other data to their applicable regulator in order to get approval for Cat II or III operations. Operators who have been approved for Cat II and III operations and have airplanes certified for these operations need to provide this information to their pilots.

More detailed information concerning Category II and Category III operational requirements can be found in FAA advisory circulars or similar documents from other regulatory agencies. The manufacturer's demonstrated compliance with the airworthiness performance standards does not constitute approval to conduct operations in lower weather minimums.

AFDS Faults

FCTM 5.21

Operators are responsible for reviewing their AFM and FAA advisory circulars or similar documents from other regulatory agencies to establish a pilot response if any of the required airplane equipment fails or the AFDS is degraded during a Category II or Category III approach. However, the requirements in the AFM do not necessarily denote all of the systems and equipment required for the types of operation specified. Applicable regulations may prescribe an operational requirement for additional systems (e.g. autobrake).

The pilot response along with other data should be submitted to the applicable regulator for approval. The operator needs to provide this information to their pilots.

More detailed information concerning Category II and Category III operational requirements can be found in FAA advisory circulars or similar documents from other regulatory agencies. The manufacturer's demonstrated compliance with the airworthiness performance standards does not constitute approval to conduct operations in lower weather minimums.

Instrument Approach - RNAV (RNP) SAAAR/AR

Instrument Approach - RNAV (RNP) SAAAR/AR - General

FCTM 5.48

Operators need approval to conduct RNAV (RNP) SAAAR/AR instrument approach procedures. Operators are responsible to determine equipment needed and submit these requirements along with other data to their applicable regulators in order to get approval for RNAV (RNP) SAAAR/AR operations.

Operators who have been approved to conduct these operations and have airplanes certified for these operations are encouraged to create a customized RNAV (RNP) SAAAR/AR Approach Review Card to provide information to their flight crews.

Note: More detailed information concerning SAAAR/AR operational and training requirements can be found in FAA advisory circulars or similar documents.

Landing Roll

Factors Affecting Landing Distance

Slippery Runway Landing Performance

FCTM 6.28

Slippery/contaminated runway advisory information is based on an assumption of uniform conditions over the entire runway. This means a uniform depth for slush/standing water for a contaminated runway or a fixed braking coefficient for a slippery runway. The data cannot cover all possible slippery/contaminated runway combinations and does not consider factors such as rubber deposits or heavily painted surfaces near the end of most runways. With these caveats in mind, it is up to the operator to determine operating policies based on the training and operating experience of their flight crews.

Crosswind Landings

Landing Crosswind Guidelines

FCTM 6.39

Crosswind guidelines are not considered limitations. Crosswind guidelines are provided to assist operators in establishing their own crosswind policies.

Rapid Descent

FCTM 7.6

Some routes over mountainous terrain require careful operator planning to include carrying additional oxygen, special procedures, higher initial level off altitudes, and emergency routes in the event a depressurization is experienced. These requirements are normally addressed in an approved company route manual or other document that addresses route specific depressurization procedures.

Terrain Avoidance

Terrain Avoidance during Low RNP Operations

FCTM 7.13

Terrain warning-level alerts always require immediate action. The most appropriate crew actions regarding airplane bank angle and track during a terrain avoidance maneuver depend on where the maneuver is initiated. Operators should determine the most appropriate course of action for each leg of the procedure, if necessary, so crews are prepared to react correctly at all times.

Operators are encouraged to report nuisance ground proximity alerts to airport authorities, Boeing, and to the appropriate avionics suppliers to enable appropriate corrective action.

Non-Normal Situation Guidelines

Landing at the Nearest Suitable Airport

FCTM 8.3

A suitable airport is defined by the operating authority for the operator based on guidance material, but in general must have adequate facilities and meet certain minimum weather and field conditions.

Engines, APU

Recommended Technique for an In-Flight Engine Shutdown

FCTM 8.8

Operators may develop their own crew coordination techniques for an in-flight engine shutdown. This technique should ensure that the objectives stated in the body of this manual are met. The section titled Recommended Technique for an In-Flight Engine Shutdown contains an example that could be used.



A

Acceleration to and Deceleration from VMO 7.1

Adverse Runway Conditions - Takeoff 3.17

Adverse Runway Conditions - Takeoff A.2.4

AFDS Autoland Capabilities 5.18

AFDS Faults 5.21

AFDS Guidelines. 1.33

AFDS Guidelines. A.2.2

Airspeed Unreliable. 8.15

Alert Height - AH 5.12

Antiskid Inoperative - Landing. 6.33

Antiskid Inoperative - Taxi. 2.6

Approach Briefing 5.2

Approach Category 5.2

Approach Category A.2.6

Approach Clearance 5.3

Automatic Flight - AFDS 1.34

Autopilot Engagement - After Takeoff. 3.27

Autothrottle Use. 1.34

B

Bird Strikes 8.8

Bounced Landing Recovery 6.24

C

Callouts 1.15

CAT II Operations 5.20

CAT III Operations. 5.20

Category II Operations 5.20

Category III Operations 5.20

Center-Of-Gravity Effects on Takeoff 3.10

Circling Approach - One Engine Inoperative 5.54

Circling Approach 5.52

Climb Constraints 4.1



777 Flight Crew Training Manual

Climb Performance Takeoff (Improved)	3.17
Cold Temperature Altitude Corrections	1.22
Cold Temperature Altitude Corrections	A.2.1
Command Speed - Non-Normal Conditions	1.12
Command Speed	1.11
Crew Resource Management	1.2
Crosswind Guidelines - Takeoff	3.11
Crosswind Landings	6.39
Crosswind Landings	A.2.7
Crosswind Takeoff	3.11
Crosswind Takeoff	A.2.3
Cruise Performance Economy	4.11

D

Damage Assessment and Airplane Handling Evaluation	8.32
Decision Altitude or Height - DA(H)	5.12
Decision Altitude or Height - DA(H)	5.16
Derated Takeoff Thrust (Fixed Derate)	3.15
Descent Constraints	4.18
Descent Path	4.18
Descent Planning	4.19
Descent Rates	4.20
Descent Speed Determination	4.18
Ditching	8.4
Dual Engine Failure	8.7

E

Economy Climb Schedule - FMC Data Unavailable	4.4
Economy Climb	4.4
Electronic Flight Bag	1.20
Electronic Flight Control System	1.39
Engine Failure During a Combined ATM and Fixed Derate	3.35
Engine Failure During a Derated Takeoff Thrust (Fixed Derate)	3.35
Engine Failure During a Reduced Thrust (ATM) Takeoff	3.35
Engine Failure Recognition - Takeoff	3.30
Engine Failure versus Engine Fire After Takeoff	8.5

777 Flight Crew Training Manual

Engine Icing During Climb	4.3
Engine Icing During Descent	4.22
Engine Inoperative Climb	4.4
Engine Inoperative, Rudder Trim - All Instrument Approaches	5.23
Engine Out Familiarization	7.2
Engine Out Taxi	2.15
Engine Severe Damage Accompanied by High Vibration	8.7
ETOPS	4.14
ETOPS	A.2.5
Evacuation	8.10
F	
Fire Engine Tailpipe	8.6
Flap Configurations for Approach and Landing	5.6
Flap Drive Failure (Trailing Edge) - Landing	8.12
Flap Extension Schedule	5.7
Flap Extension using the Secondary or Alternate System	8.12
Flap Maneuver Speeds	1.4
Flap Retraction - One Engine Inoperative	3.34
Flap Retraction Schedule	3.28
Flaps and Landing Gear	4.21
Flaps and Slats Up Landing	8.11
Flare and Touchdown	6.8
Flight Management Computer(s)/CDUs	1.26
Flight Path Vector	1.21
FMC Route Verification Techniques	1.26
Fuel Balance	8.17
Fuel for Enroute Climb	4.9
Fuel Jettison	8.19
Fuel Leak	8.18
Fuel Temperature	4.9
Fuel Temperature	A.2.4
G	
Gear Disagree	8.21
Go-Around after Touchdown	5.66



777 Flight Crew Training Manual

Go-Around and Missed Approach - All Engines Operating	5.64
Go-Around and Missed Approach - All Instrument Approaches	5.63
Go-Around and Missed Approach - Engine Failure During	5.66
Go-Around and Missed Approach - One Engine Inoperative	5.66
Go/Stop Decision Near V1	3.21
GPS Use in Non-WGS-84 Reference Datum Airspace	1.33
GPS Use in Non-WGS-84 Reference Datum Airspace	A.2.1

H

Headphone and Flight Deck Speaker Use	1.3
High Altitude High Speed Flight	4.13
High Altitude Maneuvering, "G" Buffet	7.5
Holding Airspeeds (FAA)	4.23
Holding Airspeeds (ICAO)	4.23
Holding	4.22
Hydraulic System(s) Inoperative - Landing	8.19

I

Icing - Operation in Icing Conditions	1.23
Icing - Training Flights in Icing Conditions	1.23
ILS - One Engine Inoperative	5.23
ILS Approach - Landing Geometry	5.22
ILS Approach	5.10
ILS Approach	A.2.6
ILS Performance	5.18
Immediate Turn after Takeoff - All Engines	3.26
Immediate Turn after Takeoff - One Engine Inoperative	3.33
Initial Climb - All Engines	3.26
Initial Climb - One Engine Inoperative	3.33
Instrument Approach - RNAV (RNP) SAAAR/AR	5.47
Instrument Approach Using VNAV	5.37
Instrument Approach Using V/S or FPA	5.43
Instrument Approaches	5.1

J

Jammed or Restricted Flight Controls	8.13
Jammed Stabilizer	8.15

777 Flight Crew Training Manual**L**

Landing at the Nearest Suitable Airport	8.3
Landing at the Nearest Suitable Airport	A.2.8
Landing Distance (Factors Affecting)	6.27
Landing Distance (Non-Normal)	6.28
Landing Flare Profile	6.9
Landing Minima	5.6
Landing on a Flat Tire	8.20
Landing Roll	6.26
Landing Roll	A.2.7
Liftoff - Effect of Rotation Speed and Pitch Rate	3.9
LNAV - Non-ILS Approach	5.30
Loss of Engine Thrust Control	8.6
Low Altitude Level Off - During Climb	4.2
Low Fuel Operations In-flight	8.18
Low Visibility Takeoff	3.17
Low Visibility Takeoff	A.2.3

M

Maintenance Inspection (Events Requiring)	1.1
Maintenance Inspection (Events Requiring)	A.2.1
Maneuver Margin - Landing and Go-Around	5.7
Maneuver Margins to Stick Shaker	1.7
Maneuver Speeds and Margins	1.4
Manual Flight	1.34
Maximum Altitude - Cruise	4.6
Maximum Altitude - Cruise	A.2.4
Maximum Angle Climb	4.4
Maximum Rate Climb	4.4
Minimum Fuel Operation - Takeoff	3.26
Minimum Maneuver Speed	1.4
Missed Approach - Non-ILS	5.51
Missed Approach Point	5.7
Missed Approach (Mandatory Conditions)	5.5

N



777 Flight Crew Training Manual

Noise Abatement - One Engine Inoperative	3.35
Noise Abatement Takeoff	3.29
Non - ILS Instrument Approach - Vertical Path Construction	5.34
Non - ILS Instrument Approaches	5.26
Non-Normal Operations	5.23
Non-Normal Situation Guidelines	8.1
Non-Normal Situation Guidelines	A.2.8
O	
Operational Philosophy	1.1
Operational Philosophy	A.2.1
Optimum Altitude - Cruise	4.7
Optimum Altitude - Cruise	A.2.4
Overspeed Protection	7.2
Overspeed	8.23
Overweight Landing	6.41
P	
Pilot Incapacitation	1.38
Pitch and Roll Limit Conditions	6.20
Pitch Modes - Takeoff	3.27
Polar Operations	4.15
Polar Operations	A.2.5
Precision Approach Path Indicator (PAPI)	6.5
Procedure Holding	4.23
Procedure Turn and Initial Approach - ILS	5.12
Procedure Turn and Initial Approach - Non-ILS Approaches	5.34
Procedure Turn	5.3
Push Back or Towing	2.2
Push Back or Towing	A.2.2
Push Back or Towing	A.2.3
Q	
Qualification Requirements (Checkride)	1.2
R	
Radio Altimeter	5.6
Rapid Descent	7.6

777 Flight Crew Training Manual

Rapid Descent	A.2.7
Raw Data - (No Flight Director) - ILS	5.16
Raw Data Monitoring Requirements - Non-ILS	5.27
Raw Data Monitoring Requirements - Non-ILS	5.29
Recommended Technique for an In-Flight Engine Shutdown	8.8
Reduced and Derated Takeoff Thrust	3.14
Reduced Takeoff Thrust (ATM)	3.15
Reduced Thrust Climb	4.1
Reference Speeds	1.13
Rejected Landing	6.25
Rejected Takeoff Decision	3.20
Rejected Takeoff Maneuver	3.21
Resolution Advisory	7.15
Reverse Thrust Operation - Landing Roll	6.35
Reverse Thrust (Ground	2.5
RNAV Operations	1.27
RNAV Operations	A.2.1
Roll Modes - Takeoff	3.27
Rotation and Liftoff - All Engines	3.7
Rotation and Liftoff - One Engine Inoperative	3.30
RTO Execution Operational Margins	3.22
Rudder Trim Technique - Recommended	1.24
Runway Markings (Typical)	6.7

S

Situations Beyond the Scope of Non-Normal Checklists	8.29
Slats Drive Failure (Leading Edge) - Landing	8.11
Speed Intervention	4.19
Speed Restrictions	4.22
Speedbrakes	4.21
Stabilized Approach Recommendations	5.4
Stall Recovery	7.10
Stop and Go Landings	5.61
Synoptic Display	1.3

T



777 Flight Crew Training Manual

Tail Strike	8.24
Takeoff - Adverse Runway Conditions	3.17
Takeoff - Combination ATM and Fixed Derate	3.16
Takeoff - Crosswind	3.11
Takeoff - Engine Failure	3.30
Takeoff - Reduced and Derated Takeoff Thrust	3.14
Takeoff - Tail Clearance	3.32
Takeoff - Tail Clearance	3.8
Takeoff Briefing	2.1
Takeoff Crosswind Guidelines	3.11
Takeoff Crosswind Guidelines	A.2.3
Takeoff Field Length (FAR)	3.18
Takeoff Flap Setting	3.3
Takeoff	3.1
Taxi - Adverse Weather	2.14
Taxi - Engine Out	2.15
Taxi - Minimum Radius	2.8
Taxi Speed and Braking	2.5
Terrain Avoidance	7.13
Terrain Avoidance	A.2.8
Threshold Height	6.8
Thrust Management - Takeoff	3.3
Thrust Use - Taxi	2.5
Tiller/Rudder Pedal Steering	2.6
Tire Failure during or after Takeoff	8.20
Touch and Go Landings	5.60
Touchdown Body Attitudes	6.10
Traffic Advisory	7.14
Traffic Alert and Collision Avoidance System	7.14
Training Objectives	1.2
Transition to Climb	4.3
Troubleshooting	8.2
Turbulent Air Penetration	1.39

U

777 Flight Crew Training Manual

Unscheduled Stabilizer Trim	8.15
Upset Recovery	7.16
V	
Visual Aim Point	6.5
Visual Approach Slope Indicator (VASI/T - VASI)	6.1
Visual Descent Point	5.50
Visual Traffic Pattern	5.57
VNAV - Non-ILS Approaches	5.31
W	
Weather Radar and Terrain Display Policy	1.33
Wheel Well Fire	8.28
Window Damage	8.28
Window(s) Open	8.29
Windshear	7.20



Intentionally
Blank