



WARNING

DO NOT USE THIS MANUAL OR ANY OF THE RELATED MATERIALS IN ANY WAY IN THE OPERATION, USE OR MAINTENANCE OF ANY AIRCRAFT. THESE MATERIALS HAVE BEEN PREPARED AND ARE PROVIDED SOLELY TO GIVE GUIDANCE ON THE LAYOUT AND STRUCTURE OF A TYPICAL AIRCRAFT MANUAL. THESE MATERIALS HAVE NOT BEEN APPROVED BY ANY AVIATION ADMINISTRATION FOR USE ON ANY AIRCRAFT AND SHOULD NEVER BE SO USED UNDER ANY CIRCUMSTANCES. FAILURE TO FOLLOW THIS WARNING COULD LEAD TO SERIOUS INJURY OR DEATH.

767-300
Flight Crew
Operations Manual
The Boeing Company

Copyright © 1999
The Boeing Company
All Rights Reserved

Document Number D632T001-300

Revision Number: 6
Revision Date: February 15, 2010



Copyright Information

Boeing claims copyright in each page of this document only to the extent that the page contains copyrightable subject matter. Boeing also claims copyright in this document as a compilation and/or collective work.

The right to reproduce, distribute, display, and make derivative works from this document, or any portion thereof, requires a license from Boeing. For more information, contact The Boeing Company, P.O. Box 3707, Seattle, Washington 98124.

Boeing, the Boeing signature, the Boeing logo, 707, 717, 727, 737, 747, 757, 767, 777, 787, BBJ, DC-8, DC-9, DC-10, MD-10, MD-11, MD-80, MD-88, MD-90 and the Boeing livery are all trademarks of The Boeing Company. No trademark license is granted in connection with this document unless provided in writing by Boeing.

Volume 1

Title Page 0
Preface 0
 V1V2 Model Identification 0.1
 Introduction 0.2
 Abbreviations 0.3
 V1V2 Revision Record 0.4
 V1V2 List of Effective Pages 0.5
 Bulletin Record 0.6
Limitations L
Normal Procedures NP
Supplementary Procedures SP
Performance Inflight PI

Volume 2

Airplane General, Emergency Equipment, Doors, Windows 1
Air Systems 2
Anti-Ice, Rain 3
Automatic Flight 4
Communications 5
Electrical 6
Engines, APU - PW 7
Engines, APU - GE 7
Fire Protection 8
Flight Controls 9
Flight Instruments, Displays 10
Flight Management, Navigation 11
Fuel 12
Hydraulics 13
Landing Gear 14

Warning Systems 15

General

The airplanes listed in the table below are covered in the Flight Crew Operations Manual (FCOM). The numbers are used to distinguish data peculiar to one or more, but not all of the airplanes. Where data applies to all airplanes listed, no reference is made to individual airplane numbers.

Use of the table below permits flight crew correlation of configuration differences by number within an operator's fleet for airplanes covered in this manual. Configuration data reflects the airplane as delivered configuration and is updated for service bulletin incorporations in conformance with the policy stated in the introduction section of this chapter.

Registry number is supplied by the national regulatory agency. Serial and tabulation numbers are supplied by Boeing.

| Registry Number | Serial Number | Tabulation Number |
|------------------------|----------------------|--------------------------|
| TBC-1 | 00000 | BC001 |
| TBC-2 | 00005 | BC002 |

Intentionally
Blank

General

This Flight Crew Operations Manual (FCOM) has been prepared by The Boeing Company. The purpose of this manual is to:

- provide the operating limitations, procedures, performance, and systems information the flight crew needs to safely and efficiently operate the 767 airplane during all anticipated operations
- serve as a comprehensive reference for use during transition training for the 767 airplane
- serve as a review guide for use in recurrent training and proficiency checks
- provide necessary operational data from the FAA approved airplane flight manual (AFM) to ensure that legal requirements are satisfied
- establish standardized procedures and practices to enhance Boeing operational philosophy and policy.

This manual is prepared for the owner/operator named on the title page specifically for the airplanes listed in the "Model Identification" section. It contains operational procedures and information, which apply only to these airplanes. The manual covers the Boeing delivered configuration of these airplanes. Changes to the delivered configuration are incorporated when covered by contractual revision agreements between the owner/operator and the Boeing Company.

This manual is not suitable for use for any airplanes not listed in the "Model Identification" section. Further, it may not be suitable for airplanes that have been transferred to other owners/operators.

Owners/operators are solely responsible for ensuring the operational documentation they are using is complete and matches the current configuration of the listed airplanes. This includes the accuracy and validity of all information furnished by the owner/operator or any other party. Owners/operators receiving active revision service are responsible to ensure that any modifications to the listed airplanes are properly reflected in the operational procedures and information contained in this manual.

The manual is periodically revised to incorporate pertinent procedural and systems information. Items of a more critical nature will be incorporated in operational bulletins and distributed in a timely manner. In all cases, such revisions and changes must remain compatible with the approved AFM with which the operator must comply. In the event of conflict with the AFM, the AFM shall supersede.

This manual is written under the assumption that the user has had previous multi-engine jet aircraft experience and is familiar with basic jet airplane systems and basic pilot techniques common to airplanes of this type. Therefore, the operations manual does not contain basic flight information that is considered prerequisite training.

Any questions about the content or use of this manual can be directed to:

Boeing Commercial Airplanes

Commercial Aviation Services

Attn: 767 Manager, Flight Technical Data

P.O. Box 3707, M/C 20-89

Seattle, Washington, 98124-2207 USA

Email - flightraining@boeing.com

Telephone: (206) 662-4000

Fax:(206) 662-4743

Organization

The FCOM is organized in the following manner.

Volume 1 –

- Preface – contains general information regarding the manual’s purpose, structure, and content. It also contains lists of abbreviations, a record of revisions, bulletins, and a list of effective pages.
- Limitations and Normal Procedures chapters cover operational limitations and normal procedures. All operating procedures are based on a thorough analysis of crew activity required to operate the airplane, and reflect the latest knowledge and experience available.
- Supplementary Procedures chapter covers those procedures accomplished as required rather than routinely on each flight.
- Performance Inflight chapter contains performance information necessary for inflight use.

Volume 2 – Chapters 1 through 15 contain general airplane and systems information. These chapters are generally subdivided into sections covering controls and indicators and systems descriptions.

Quick Reference Handbook (QRH) – The QRH covers normal checklists, in-flight performance, non-normal checklists, and non-normal maneuvers.

Page Numbering

The FCOM uses a decimal page numbering system. The page number is divided into three fields; chapter, section, and page. An example of a page number for the hydraulics chapter follows: chapter 13, section 20, page 3.

Example Page Number

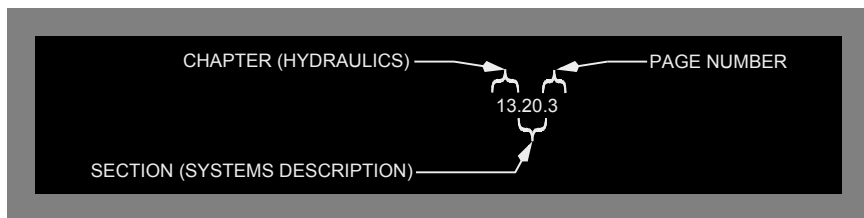

Page Identification

Each page is identified by a customer document number and a page date. The customer document number is composed of the general 767 FCOM, D632T001–, and is followed by the customer identification. The page date is the date of publication of the manual or the most recent revision date.

Example Page Identification

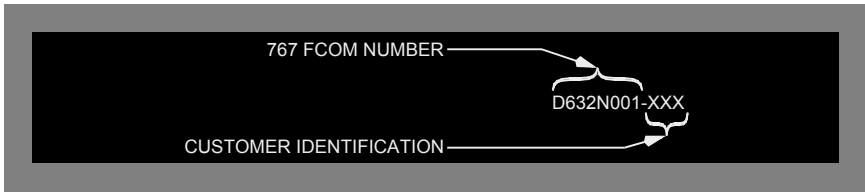

Warnings, Cautions, and Notes

The following levels of written advisories are used throughout the manual and are not to be confused with EICAS messages, which are separately identified in the text.

WARNING: An operating procedure, technique, etc., that may result in personal injury or loss of life if not carefully followed.

CAUTION: An operating procedure, technique, etc., that may result in damage to equipment if not carefully followed.

Note: An operating procedure, technique, etc., considered essential to emphasize. Information contained in notes may also be safety related.

Flight Crew Operations Manual Configuration

Customer airplane configuration determines the data provided in this manual. The Boeing Company keeps a list of each airplane configuration as it is built and modified through the Service Bulletin process. The FCOM does not reflect customer originated modifications without special contract provisions.

Airplane Effectivities

Differences in airplane configuration are shown by use of airplane effectivities throughout Volumes 1 and 2, and the Quick Reference Handbook

The following rules are used to express airplane effectivities:

1. Airplane effectivities are listed in alpha-numeric order. A range of airplanes is defined by the word “through”, e.g. **N601BC through N605BC** includes all N6xxBC series aircraft in order as listed on the model ID page. A comma in the the range, e.g. **N601BC through N603BC, N605BC** indicates that **N604BC** is excluded from the range.
2. Airplane effectivities apply only to the paragraph, illustration, operational note, procedural step, etc. and to subordinate items (if any).

Example (with subordinate items):

N601BC through N604BC

Right radio tuning panel.....Set

Verify that the OFF light is extinguished.

First officer’s audio control panel.....Set

In this example, the effectivity N601BC through N604BC applies to the first procedural step and further indented (subordinate) step only. The effectivity does not include the next equivalently indented step.

The first step (Right radio tuning panel) is effective for airplanes N601BC through N604BC, the second step (First officer’s audio control panel) is effective for all airplanes:

Example (without subordinate items):

N601BC through N602BC

Thrust reversers inoperative.

Autobrake system inoperative.

In this example, the effectivity N601BC through N602BC applies to the first operational note only. The effectivity does not apply to the next equivalently indented operational note.

The first operational note (Thrust reverser inoperative.) is effective for airplanes N601BC through N602BC only, the next operational note (Autobrake ...) is effective for all airplanes.

3. When airplane effectivities are stated immediately below a checklist title, the entire checklist applies to the listed airplanes only. In the following example, the OIL FILTER checklist is applicable to N601BC through N603BC only:



4. When Boeing has been notified airplanes are to be modified by service bulletin (SB), the effectivity statement will include 'Add' and 'Delete' versions, as appropriate, in parentheses. Depending upon the modification, there may not be both an 'Add' and an 'Delete' version.

The text before the semicolon in the parentheses lists the range of airplanes being modified. The text after the semicolon indicates the 'before' or 'after' version and briefly describes what the SB does. The following examples illustrate this:

Example ('Add' version):

**(SB Adds N604BC when Dual Oil Filters are installed)
The engine may be operated normally.**

"SB Adds N604BC" means the incorporation of the SB (i.e. installation of Dual Oil Filters in this example) is scheduled to begin for airplane N604BC. The words "SB Adds, when Dual Oil Filters are installed" indicate the associated operational note (The engine may be operated normally.) applies to N604BC when the SB has been incorporated.

Example ('Deletes' version):

**(SB Deletes N604BC when Dual Oil Filters are installed)
The engine must be operated at idle thrust.**

For airplane N604BC the SB (i.e. installation of Dual Oil Filters in this example) has not been incorporated. The associated operational note (The engine must be operated at idle thrust) applies N604BC.

"SB Deletes N604BC" means the incorporation of the SB (i.e. installation of Dual Oil Filters in this example) is scheduled to begin for airplane N604BC. The words "The engine must be operated at idle thrust " will apply to N604BC until the SB has been incorporated.

General

The following abbreviations may be found throughout the manual. Some abbreviations may also appear in lowercase letters. Abbreviations having very limited use are explained in the chapter where they are used.

| A | |
|-------|---|
| ABV | Above |
| AC | Alternating Current |
| ACARS | Aircraft Communications Addressing and Reporting System |
| ACP | Audio Control Panel |
| ACT | Active |
| ADC | Air Data Computer |
| ADF | Automatic Direction Finder |
| ADI | Attitude Director Indicator |
| ADIRS | Air Data Inertial Reference System |
| ADIRU | Air Data Inertial Reference Unit |
| AFDS | Autopilot Flight Director System |
| AFM | Airplane Flight Manual (FAA approved) |
| A/G | Air/Ground |
| AGL | Above Ground Level |
| AIL | Aileron |
| ALT | Altitude |
| ALTN | Alternate |

| | |
|-------|---|
| AM | Amplitude Modulation |
| AMI | Airline Modifiable Information |
| ANP | Actual Navigational Performance |
| ANT | Antenna |
| AOA | Angle of Attack |
| AOC | Airline Operational Communication Data Link |
| A/P | Autopilot |
| APL | Airplane |
| APP | Approach |
| APU | Auxiliary Power Unit |
| ARINC | Aeronautical Radio, Incorporated |
| ARPT | Airport |
| ARR | Arrival |
| ASA | Autoland Status Annunciator |
| ASYM | Asymmetry |
| A/T | Autothrottle |
| ATA | Actual Time of Arrival |
| ATC | Air Traffic Control |
| ATT | Attitude |

| | |
|------------|--------------------------------------|
| AUTO-THROT | Autothrottle |
| AUTO | Automatic |
| AUX | Auxiliary |
| AVAIL | Available |
| B | |
| BARO | Barometric |
| BAT | Battery |
| B/CRS | Back Course |
| BFO | Beat Frequency Oscillator |
| BKR | Breaker |
| BLD | Bleed |
| BLW | Below |
| BRG | Bearing |
| BRT | Bright |
| BTL | Bottle |
| C | |
| C | Captain Celsius Center Cool |
| CANC | Cancel |
| CAP | Capture |
| CAPT | Captain |
| CB | Circuit Breaker |
| CDU | Control Display Unit |
| CG | Center of Gravity |
| CHR | Chronograph |
| CKT | Circuit |
| CL | Close |
| CLB | Climb |

| | |
|--------|----------------------------|
| CLR | Clear |
| CMD | Command |
| CO | Company |
| COMM | Communication |
| COMP | Comparator |
| COMPT | Compartment |
| CON | Continuous |
| CONFIG | Configuration |
| CONT | Control |
| COOL | Cooling |
| CRS | Course |
| CRT | Cathode Ray Tube |
| CRZ | Cruise |
| CTL | Control |
| CTR | Center |
| CWS | Control Wheel Steering |
| D | |
| DA(H) | Decision Altitude (Height) |
| DC | Direct Current |
| DCU | Display Concentrator Unit |
| DDG | Dispatch Deviations Guide |
| DEL | Delete |
| DEP | Departure |
| DEPR | Depressurize |
| DES | Descent |
| DH | Decision Height |
| DIFF | Differential |
| DISC | Disconnect |

767 Flight Crew Operations Manual

| | |
|---------------|---|
| DISCH | Discharge |
| DK | Deck |
| DME | Distance Measuring Equipment |
| DN | Down |
| DSPL | Display |
| E | |
| E/D | End of Descent |
| E/E | Electrical/Electronic |
| EEC | Electronic Engine Control |
| EFI | Electronic Flight Instruments |
| EFIS | Electronic Flight Instrument System |
| EGT | Exhaust Gas Temperature |
| EICAS | Engine Indication and Crew Alerting System |
| ELEC | Electrical |
| ELEV | Elevator |
| EMER | Emergency |
| ENG | Engine |
| ENT | Entry |
| EO | Engine Out |
| EPR | Engine Pressure Ratio |
| EQPT or EQUIP | Equipment |
| ETOPS | Extended Range Operation with Twin Engine Airplanes |
| EVAC | Evacuation |
| EXEC | Execute |

| | |
|--------------------|---------------------------------------|
| EXT | Extend or External |
| F | |
| F | Fahrenheit |
| FADEC | Full Authority Digital Engine Control |
| FCC | Flight Control Computer |
| FCOM | Flight Crew Operations Manual |
| FD, F/D or FLT DIR | Flight Director |
| FF | Fuel Flow |
| FILT | Filter |
| FL CH or FLCH | Flight Level Change |
| FLT | Flight |
| FMA | Flight Mode Annunciations |
| FMC | Flight Management Computer |
| FMS | Flight Management System |
| F/O or F O | First Officer |
| FPA | Flight Path Angle |
| FPV | Flight Path Vector |
| FPM | Feet Per Minute |
| FREQ | Frequency |
| F/S | Fast/Slow |
| FT | Feet |
| FWD | Forward |
| FWSOV | Fire Wall Shut Off Valve |
| G | |
| GA | Go-Around |
| GEN | Generator |

| | |
|---------|---------------------------------|
| GMT | Greenwich Mean Time |
| GND | Ground |
| GPS | Global Positioning System |
| GPWS | Ground Proximity Warning System |
| G/S | Glide Slope |
| GS | Ground Speed |
| H | |
| HDG | Heading |
| HF | High Frequency |
| HI | High |
| HLD | Hold |
| HPSOV | High Pressure Shut Off Valve |
| HSI | Horizontal Situation Indicator |
| HYD | Hydraulic |
| I | |
| IAS | Indicated Airspeed |
| IDENT | Identification |
| IGN | Ignition |
| IGS | Instrument Guidance System |
| IND LTS | Indicator Lights |
| INIT | Initialization |
| INSTR | Instrument |
| ILS | Instrument Landing System |
| INBD | Inboard |
| IND | Indicator |
| INOP | Inoperative |

| | |
|---------------|-----------------------------------|
| INT or INTPH | Interphone |
| INTC | Intercept |
| ISFD | Integrated Standby Flight Display |
| IRS | Inertial Reference System |
| ISA | International Standard Atmosphere |
| ISLN | Isolation |
| K | |
| K or KTS | Knots |
| KGS | Kilograms |
| L | |
| L | Left |
| LBS | Pounds |
| LD | Load |
| LDA | Localizer-type Directional Aid |
| LDG | Landing |
| LE | Leading Edge |
| LIM | Limit |
| LKD | Locked |
| L NAV or LNAV | Lateral Navigation |
| LOC | Localizer |
| LT | Light |
| LWR CTR | Lower Center |
| LWR DSPLY | Lower Display |
| M | |
| M | Mach |
| MAG | Magnetic |

767 Flight Crew Operations Manual

| | |
|--------|--|
| MAN | Manual |
| MAX | Maximum |
| MCP | Mode Control Panel |
| MDA(H) | Minimum Descent Altitude (Height) |
| MEL | Minimum Equipment List |
| MIC | Microphone |
| MFD | Multifunction Display |
| MIN | Minimum |
| MLS | Microwave Landing System |
| MMO | Maximum Mach Operating Speed |
| MOD | Modify |
| MSG | Message |
| MTRS | Meters |
| N | |
| N | Normal |
| NAV | Navigation |
| ND | Navigation Display |
| NM | Nautical Miles |
| NORM | Normal |
| N1 | Low Pressure Rotor Speed |
| N2 | High Pressure Rotor Speed (Pratt & Whitney engines) Intermediate Pressure Rotor Speed (Rolls-Royce engines) |
| N3 | High Pressure Rotor Speed (Rolls-Royce engines) |

| | |
|------------------|------------------------------|
| O | |
| OAT | Outside Air Temperature |
| OFST | Offset |
| OP | Open |
| OUTBD DSPL | Outboard Display |
| OVHT | Overheat |
| OVRD | Override |
| OVSPD | Overspeed |
| OXY or O2 | Oxygen |
| P | |
| PA | Passenger Address |
| PASS | Passenger |
| PCP | Pilot Call Panel |
| PERF | Performance |
| PES | Pitch Enhancement System |
| PF | Pilot Flying |
| PFD | Primary Flight Display |
| PM | Pilot Monitoring |
| PNL | Panel |
| POS | Position |
| PPOS | Present Position |
| PRES or PRESS | Pressure |
| PREV | Previous |
| P/RST | Push To Reset |
| PROX | Proximity |
| PRV | Pressure Regulating Valve |
| PSI | Pounds Per Square Inch |

| | |
|-----------------|---|
| PTH | Path |
| PTT | Push To Talk |
| PTU | Power Transfer Unit |
| PWR | Power |
| PWS | Predictive Windshear System |
| Q | |
| QFE | Local Station Pressure |
| QNH | Local Station Pressure Corrected to MSL |
| QTY | Quantity |
| R | |
| R | Right |
| RA | Radio Altitude Resolution Advisory |
| RAD | Radio |
| RAT | Ram Air Turbine |
| RDMI | Radio Distance Magnetic Indicator |
| REC | Recorder |
| RECIR or RECIRC | Recirculation |
| REF | Reference |
| REV | Reverse |
| RF | Refill |
| RMI | Radio Magnetic Indicator |
| RNP | Required Navigational Performance |
| RPM | Revolutions Per Minute |
| RST | Reset |
| RNV | Area Navigation (RNAV) |
| RSVR | Reservoir |

| | |
|----------------|-------------------------------------|
| R/T | Radio Transmit |
| RTE | Route |
| RTO | Rejected Takeoff |
| RUD | Rudder |
| RVSM | Reduced Vertical Separation Minimum |
| S | |
| SAT | Static Air Temperature Satellite |
| SB | Service Bulletin |
| S/C | Step Climb |
| SDF | Simplified Directional Facility |
| SEL | Select |
| SELCAL | Selective Calling |
| SENS | Sensitivity |
| SERV | Service |
| SPD | Speed |
| SPDBRK | Speedbrake |
| STAB | Stabilizer |
| STBY | Standby |
| SYS | System |
| T | |
| T or TRU | True |
| T or TK or TRK | Track |
| TA | Traffic Advisory |
| TAI | Thermal Anti-Ice |
| TAT | Total Air Temperature |
| T/C | Top of Climb |

767 Flight Crew Operations Manual

| | |
|-------------------|--|
| TCAS | Traffic Alert and Collision Avoidance System |
| T/D | Top of Descent |
| TE | Trailing Edge |
| TEMP | Temperature |
| TERR | Terrain |
| TFC | Traffic |
| TFR | Transfer |
| THR | Throttle Thrust |
| TO or T/O | Takeoff |
| TO/GA | Takeoff/Go-Around |
| TURB | Turbine Turbulence |
| U | |
| UNLKD | Unlocked |
| UNSCHD or UNSCHED | Unscheduled |
| UPR DSPL | Upper Display |
| USB | Upper Side Band |
| UTC | Universal Time Coordinated |
| UTIL | Utility |
| V | |
| VA | Design maneuvering Speed |
| VAL | Valve |
| VERT | Vertical |
| VHF | Very High Frequency |
| VIB | Vibration |
| VLV | Valve |

| | |
|---------------|---------------------------|
| VMO | Maximum Operating Speed |
| V NAV or VNAV | Vertical Navigation |
| VOR | VHF Omnidirectional Range |
| VR | Rotation Speed |
| VREF | Reference Speed |
| VSI | Vertical Speed Indicator |
| V/S | Vertical Speed |
| VTK | Vertical Track |
| V1 | Takeoff Decision Speed |
| V2 | Takeoff Safety Speed |
| W | |
| W | Warm |
| WHL | Wheel |
| WPT | Waypoint |
| WXR | Weather Radar |
| X | |
| X-FEED | Crossfeed |
| XPDR or XPNDR | Transponder |
| XTK | Cross Track |

Intentionally
Blank

Revision Transmittal Letter

To: All holders of The Boeing Company 767 Flight Crew Operations Manual (FCOM), Boeing Document Number D632T001-300.

Subject: Flight Crew Operations Manual Revision.

CAUTION. Before inserting this FCOM revision check the Bulletin Record, Section 6, against the enclosed Flight Crew Operations Manual Bulletins (OMBs). If all OMBs listed in Section 6 are enclosed, this FCOM has been completely reprinted for customer convenience due to the large number of changed pages.

This revision reflects the most current information available to The Boeing Company 45 days prior to the subject revision date. The following revision highlights explain changes in this revision. The Revision Record page explains the use of revision bars to identify new or revised information.

Revision Record

| No. | Revision Date | Date Filed |
|-----|-------------------|------------|
| 0 | February 14, 2007 | |
| 2 | February 18, 2008 | |
| 4 | February 19, 2009 | |
| 6 | February 15, 2010 | |

| No. | Revision Date | Date Filed |
|-----|-----------------|------------|
| 1 | August 17, 2007 | |
| 3 | August 21, 2008 | |
| 5 | August 19, 2009 | |
| | | |

General

The Boeing Company issues FCOM revisions to provide new or revised procedures and information. Formal revisions also incorporate appropriate information from previously issued FCOM bulletins.

The revision date is the approximate date the manual is mailed to the customer and is effective upon receipt.

Formal revisions include a Transmittal Letter, a new Revision Record, Revision Highlights, and a current List of Effective Pages. Use the information on the new Revision Record and List of Effective Pages to verify the FCOM content.

Pages containing revised material have revision bars and highlights associated with the changed text or illustration. Revision bars associated with revised effectivity due to additions, deletions of airplanes or changes to previous registration numbers will not have highlights.

The record should be completed by the person incorporating the revision into the manual.

Filing Instructions

Consult the List of Effective Pages (0.5). Pages identified with an asterisk (*) are either replacement pages or new (original) issue pages. Remove corresponding old pages and replace or add new pages. Remove pages that are marked DELETED; there are no replacement pages for deleted pages.

Be careful when inserting changes not to throw away pages from the manual that are not replaced. The List of Effective Pages determines the correct content of the manual.

Revision Highlights

Highlights have page numbers; section and paragraph titles are provided.

This section (0.4) replaces the existing section 0.4 in your manual.

Throughout the manual, airplane effectivity may be updated to reflect coverage as listed on the Preface - Model Identification page, or to show service bulletin airplane effectivity. Highlights are not supplied.

This manual is published from a database; the text and illustrations are marked with configuration information. Occasionally, because the editors rearrange the database markers, or mark items with configuration information due to the addition of new database content, some customers may receive revision bars on content that appears to be unchanged. Pages may also be republished without revision bars due to slight changes in the flow of the document.

Chapter 0 - Preface

Section 2 - Introduction

General

0.2.2 - Revised contact information.

Section 6 - Bulletin Record

0.6.1 - Deleted reference to temporary information for cross model standardization.

0.6.6 - Revised to reflect current bulletin status.

Chapter 0-B - Bulletins**Section 72 - Bulletin**

0-B.72.1 - Revised to include Service Bulletin information.

Section 73 - Bulletin

0-B.73.1 - Revised bulletin to include Service Bulletin information.

Chapter NP - Normal Procedures**Section 21 - Amplified Procedures**

Preflight Procedure – Captain

NP.21.21 - Re-issued information related to RDMI to ensure proper distribution.

Before Start Procedure

NP.21.25 - Revised to verify both PRESS lights illuminated.

Takeoff Procedure

NP.21.33 - Revised the takeoff procedure to incorporate NTSB recommendations (NTSB/AAR-07/05) and SAFO 06013.

NP.21.33 - Relocated wing landing light step to accommodate NTSB recommendations (NTSB/AAR-07/05) and SAFO 06013.

Climb and Cruise Procedure

NP.21.37 - Revised information to advise crews to refer to the Center Tank Fuel Pumps Operations manual bulletin for procedures in climb and cruise.

Chapter SP - Supplementary Procedures**Section 1 - Airplane General, Emer. Equip., Doors, Windows**

Doors

SP.1.1 - Abbreviated section name to fit on the page correctly.

Section 4 - Automatic Flight

AFDS

SP.4.1 - Clarified comment to verify flight director and autoflight mode. Standardized across models.

Section 16 - Adverse Weather

Cold Weather Operations

SP.16.2 - Revised visibility limit to be consistent with the AFM.

SP.16.2 - Added ice to surface contaminants which could change or affect normal system operations. Changes made for Boeing cross-model standardization.

SP.16.2 - Wording changed for Boeing cross-model standardization.

Chapter PI - Performance Inflight -

Section 12 - Advisory Information

Normal Configuration Landing Distance

PI.12.1-2 - Changed header to say APP SPD ADJ instead of VREF ADJ for clarification.

Section 22 - Advisory Information

Normal Configuration Landing Distance

PI.22.1-2 - Changed header to say APP SPD ADJ instead of VREF ADJ for clarification.

Chapter 1 - Airplane General, Emergency Equipment, Doors, Windows

Section 22 - Instrument Panels

Control Stand

1.22.1 - Deleted Rich position from fuel control panel.

Chapter 2 - Air Systems

Section 20 - Air Conditioning System Description

Air Distribution

2.20.2 - Added information describing passenger airplane air distribution. This information was incorrectly removed by a previous change.

Chapter 8 - Fire Protection

Section 10 - Controls and Indicators

Cargo and APU Fire Panel

8.10.3 - Revised description for clarity. Replaced "the extinguisher bottle" with "either extinguisher bottle".

Chapter 10 - Flight Instruments, Displays**Section 10 - EFIS Controls and Indicators**

ADIs with Flight Mode Annunciations (FMA) on Top

10.10.1 - Deleted ADI illustration with flight director bars, fast/slow airspeed indicators, and flight management information displayed on top.

10.10.1 - Added ADI illustration with fast/slow airspeed indicators and A/T annunciated.

10.10.3 - Added callout for airplanes with A/T annunciated below thrust mode.

ADI Speed Tape

10.10.7 - Corrected spelling of the word maneuvering and airspeed.

10.10.9 - Corrected spelling of the word maneuvering.

Radar

10.10.39-40 - Corrected spelling of the word controlled.

10.10.41 - Corrected spelling of the word annunciation.

Look-Ahead Terrain

10.10.45 - Corrected spelling of the word look.

10.10.46 - Corrected spelling of the word annunciation and display.

Chapter 11 - Flight Management, Navigation**Section 40 - FMC Preflight**

Position Initialization Page

11.40.9 - Corrected callout title to "SET IRS POS" as displayed on POS INIT page.

Chapter 15 - Warning Systems**Section 10 - Controls and Indicators**

GPWS Controls

15.10.14 - Deleted reference to the amber light to reflect actual fleet configuration. Pushing the switch inhibits certain GPWS alerts but does not cause a light to illuminate.

Predictive Windshear (PWS)

15.10.21 - Revised description of PWS alerting to reflect automatic pop-up of PWS symbology and weather radar display when terrain (TERR) mode is selected.

15.10.21 - Added note regarding automatic pop-up of PWS symbology when terrain (TERR) mode is selected on the HSI display.

Section 20 - System Description

Predictive Windshear (PWS)

15.20.24 - Added information regarding the automatic pop-up of PWS symbology.

15.20.25-26 - Added description of automatic pop-up of weather radar display, including PWS symbology.

15.20.25-26 - Deleted reference to the terrain (TERR) switch for consistency.

Section 30 - EICAS Messages

TCAS

15.30.1 - Added message inhibit description for the EICAS advisory message "TCAS OFF".

Preface**Chapter 0****V1V2 List of Effective Pages****Section 5**

| Page | Date |
|--------------------------------|-------------------|
| Volume 1 | |
| * Title Page | February 15, 2010 |
| * Copyright | February 15, 2010 |
| 0.TOC.0.1-2 | August 21, 2008 |
| * 0.1.1-2 | February 15, 2010 |
| 0.2.1 | February 18, 2008 |
| * 0.2.2 | February 15, 2010 |
| 0.2.3 | February 19, 2009 |
| 0.2.4 | February 18, 2008 |
| 0.2.5-6 | August 19, 2009 |
| 0.3.1 | February 14, 2007 |
| 0.3.2-5 | August 21, 2008 |
| 0.3.6 | February 14, 2007 |
| 0.3.7 | February 18, 2008 |
| 0.3.8 | February 14, 2007 |
| Revision Record (tab) | |
| * 0.4.1-6 | February 15, 2010 |
| * 0.4.7-8 | Deleted |
| List of Effective Pages | |
| * 0.5.1-12 | February 15, 2010 |
| Bulletins (tab) | |
| * 0.6.1-6 | February 15, 2010 |
| * 0.6.7-8 | Deleted |
| 0-B.1.1 | August 17, 2007 |
| * 0-B.1.2 | February 15, 2010 |
| 0-B.2.1 | August 17, 2007 |
| * 0-B.2.2 | February 15, 2010 |

| Page | Date |
|-------------------------|-------------------|
| Bulletins (cont) | |
| 0-B.3.1 | August 17, 2007 |
| * 0-B.3.2 | February 15, 2010 |
| 0-B.4.1 | August 17, 2007 |
| * 0-B.4.2 | February 15, 2010 |
| 0-B.5.1 | August 17, 2007 |
| * 0-B.5.2 | February 15, 2010 |
| 0-B.6.1 | August 17, 2007 |
| * 0-B.6.2 | February 15, 2010 |
| 0-B.7.1 | August 17, 2007 |
| * 0-B.7.2 | February 15, 2010 |
| 0-B.8.1 | August 17, 2007 |
| * 0-B.8.2 | February 15, 2010 |
| 0-B.9.1 | August 17, 2007 |
| * 0-B.9.2 | February 15, 2010 |
| 0-B.10.1 | August 17, 2007 |
| * 0-B.10.2 | February 15, 2010 |
| 0-B.11.1-2 | August 17, 2007 |
| * 0-B.11.3 | February 15, 2010 |
| 0-B.11.4 | February 18, 2008 |
| 0-B.12.1 | August 17, 2007 |
| * 0-B.12.2 | February 15, 2010 |
| 0-B.13.1 | August 17, 2007 |
| * 0-B.13.2 | February 15, 2010 |
| 0-B.14.1 | August 17, 2007 |
| * 0-B.14.2 | February 15, 2010 |
| 0-B.15.1 | August 17, 2007 |
| * 0-B.15.2 | February 15, 2010 |
| 0-B.16.1 | August 17, 2007 |

* = Revised, Added, or Deleted

Copyright © The Boeing Company. See title page for details.

767 Flight Crew Operations Manual

| Page | Date | Page | Date |
|------------------|-------------------|------------------|-------------------|
| Bulletins (cont) | | Bulletins (cont) | |
| * 0-B.16.2 | February 15, 2010 | * 0-B.29.2 | February 15, 2010 |
| 0-B.17.1-4 | August 17, 2007 | 0-B.30.1 | August 17, 2007 |
| * 0-B.17.5 | February 15, 2010 | * 0-B.30.2 | February 15, 2010 |
| 0-B.17.6 | February 18, 2008 | 0-B.31.1-3 | August 17, 2007 |
| 0-B.18.1-2 | August 17, 2007 | * 0-B.31.4 | February 15, 2010 |
| * 0-B.18.3 | February 15, 2010 | 0-B.32.1 | August 17, 2007 |
| 0-B.18.4-33 | August 17, 2007 | * 0-B.32.2 | February 15, 2010 |
| 0-B.18.34 | February 18, 2008 | 0-B.33.1 | August 17, 2007 |
| 0-B.19.1 | August 17, 2007 | * 0-B.33.2 | February 15, 2010 |
| * 0-B.19.2 | February 15, 2010 | 0-B.34.1 | August 17, 2007 |
| 0-B.20.1 | August 17, 2007 | * 0-B.34.2 | February 15, 2010 |
| * 0-B.20.2 | February 15, 2010 | 0-B.35.1 | August 17, 2007 |
| 0-B.21.1 | August 17, 2007 | * 0-B.35.2 | February 15, 2010 |
| * 0-B.21.2 | February 15, 2010 | 0-B.36.1 | August 17, 2007 |
| 0-B.22.1 | August 17, 2007 | * 0-B.36.2 | February 15, 2010 |
| * 0-B.22.2 | February 15, 2010 | 0-B.37.1 | August 17, 2007 |
| 0-B.23.1 | August 17, 2007 | * 0-B.37.2 | February 15, 2010 |
| * 0-B.23.2 | February 15, 2010 | 0-B.38.1 | August 17, 2007 |
| 0-B.24.1 | August 17, 2007 | * 0-B.38.2 | February 15, 2010 |
| * 0-B.24.2 | February 15, 2010 | 0-B.39.1 | August 17, 2007 |
| 0-B.25.1 | August 17, 2007 | * 0-B.39.2-4 | February 15, 2010 |
| * 0-B.25.2 | February 15, 2010 | 0-B.40.1-2 | August 17, 2007 |
| 0-B.26.1 | August 17, 2007 | * 0-B.40.3 | February 15, 2010 |
| * 0-B.26.2 | February 15, 2010 | 0-B.40.4 | February 18, 2008 |
| 0-B.27.1-2 | August 17, 2007 | 0-B.41.1 | August 17, 2007 |
| * 0-B.27.3 | February 15, 2010 | * 0-B.41.2 | February 15, 2010 |
| 0-B.27.4 | February 18, 2008 | 0-B.42.1 | August 17, 2007 |
| 0-B.28.1 | August 17, 2007 | * 0-B.42.2 | February 15, 2010 |
| * 0-B.28.2 | February 15, 2010 | 0-B.43.1-2 | August 17, 2007 |
| 0-B.29.1 | August 17, 2007 | * 0-B.43.3 | February 15, 2010 |

* = Revised, Added, or Deleted

767 Flight Crew Operations Manual

| Page | Date | Page | Date |
|------------------|-------------------|------------------|-------------------|
| Bulletins (cont) | | Bulletins (cont) | |
| 0-B.43.4 | February 18, 2008 | * 0-B.56.3 | February 15, 2010 |
| 0-B.44.1 | August 17, 2007 | 0-B.56.4 | February 18, 2008 |
| * 0-B.44.2 | February 15, 2010 | 0-B.57.1-2 | August 17, 2007 |
| 0-B.45.1 | August 17, 2007 | * 0-B.57.3 | February 15, 2010 |
| * 0-B.45.2 | February 15, 2010 | 0-B.57.4 | February 18, 2008 |
| 0-B.46.1 | August 17, 2007 | 0-B.58.1-2 | August 17, 2007 |
| * 0-B.46.2 | February 15, 2010 | * 0-B.58.3 | February 15, 2010 |
| 0-B.47.1 | August 17, 2007 | 0-B.58.4 | February 18, 2008 |
| * 0-B.47.2 | February 15, 2010 | 0-B.59.1 | August 17, 2007 |
| 0-B.48.1-2 | August 17, 2007 | * 0-B.59.2 | February 15, 2010 |
| * 0-B.48.3 | February 15, 2010 | 0-B.61.1 | August 17, 2007 |
| 0-B.48.4 | February 18, 2008 | * 0-B.61.2 | February 15, 2010 |
| 0-B.49.1-2 | August 17, 2007 | 0-B.62.1-2 | August 17, 2007 |
| * 0-B.49.3 | February 15, 2010 | * 0-B.62.3 | February 15, 2010 |
| 0-B.49.4 | February 18, 2008 | 0-B.62.4 | February 18, 2008 |
| 0-B.50.1-2 | August 17, 2007 | 0-B.63.1 | August 17, 2007 |
| * 0-B.50.3 | February 15, 2010 | * 0-B.63.2 | February 15, 2010 |
| 0-B.50.4 | February 18, 2008 | 0-B.64.1 | August 17, 2007 |
| 0-B.51.1 | August 17, 2007 | * 0-B.64.2 | February 15, 2010 |
| * 0-B.51.2 | February 15, 2010 | 0-B.65.1 | August 17, 2007 |
| 0-B.52.1 | August 17, 2007 | * 0-B.65.2 | February 15, 2010 |
| * 0-B.52.2 | February 15, 2010 | 0-B.66.1-2 | August 17, 2007 |
| 0-B.53.1 | August 17, 2007 | * 0-B.66.3 | February 15, 2010 |
| * 0-B.53.2 | February 15, 2010 | 0-B.66.4 | February 18, 2008 |
| 0-B.54.1 | August 17, 2007 | 0-B.67.1-2 | August 17, 2007 |
| * 0-B.54.2 | February 15, 2010 | * 0-B.67.3 | February 15, 2010 |
| 0-B.55.1-2 | August 17, 2007 | 0-B.67.4 | February 18, 2008 |
| * 0-B.55.3 | February 15, 2010 | 0-B.68.1-2 | August 17, 2007 |
| 0-B.55.4 | February 18, 2008 | * 0-B.68.3 | February 15, 2010 |
| 0-B.56.1-2 | August 17, 2007 | 0-B.68.4 | February 18, 2008 |

* = Revised, Added, or Deleted

767 Flight Crew Operations Manual

| Page | Date | Page | Date |
|-------------------------|-------------------|--------------------------------|-------------------|
| Bulletins (cont) | | Normal Procedures (cont) | |
| 0-B.70.1 | August 17, 2007 | * NP.21.21 | February 15, 2010 |
| * 0-B.70.2-4 | February 15, 2010 | NP.21.22-24 | February 14, 2007 |
| * 0-B.72.1-2 | February 15, 2010 | * NP.21.25 | February 15, 2010 |
| * 0-B.73.1-3 | February 15, 2010 | NP.21.26 | February 18, 2008 |
| 0-B.73.4 | August 19, 2009 | NP.21.27-29 | February 19, 2009 |
| 0-B.74.1 | September 5, 2008 | NP.21.30-31 | August 17, 2007 |
| * 0-B.74.2 | February 15, 2010 | NP.21.32 | August 21, 2008 |
| 0-B.75.1-3 | August 19, 2009 | * NP.21.33-48 | February 15, 2010 |
| * 0-B.75.4 | February 15, 2010 | Supplementary Procedures (tab) | |
| Limitations (tab) | | * SP.TOC.0.1-6 | February 15, 2010 |
| L.TOC.0.1-2 | February 19, 2009 | SP.05.1 | February 19, 2009 |
| L.10.1-3 | August 21, 2008 | SP.05.2 | February 14, 2007 |
| L.10.4 | February 19, 2009 | * SP.1.1-4 | February 15, 2010 |
| Normal Procedures (tab) | | SP.2.1-2 | August 21, 2008 |
| * NP.TOC.0.1-2 | February 15, 2010 | SP.3.1-2 | February 14, 2007 |
| NP.11.1 | February 18, 2008 | * SP.4.1-8 | February 15, 2010 |
| NP.11.2 | February 19, 2009 | SP.5.1-2 | February 14, 2007 |
| NP.11.3 | February 18, 2008 | SP.6.1-2 | February 14, 2007 |
| NP.11.4 | August 21, 2008 | SP.6.3 | August 21, 2008 |
| NP.11.5-7 | February 18, 2008 | SP.6.4 | February 14, 2007 |
| NP.11.8 | February 19, 2009 | SP.7.1-2 | February 14, 2007 |
| NP.21.1-2 | February 14, 2007 | SP.8.1-2 | February 14, 2007 |
| NP.21.3-4 | August 19, 2009 | SP.10.1-2 | February 14, 2007 |
| NP.21.5-10 | February 14, 2007 | SP.11.1-14 | February 14, 2007 |
| NP.21.11 | February 18, 2008 | SP.12.1-2 | February 14, 2007 |
| NP.21.12-14 | February 14, 2007 | SP.15.1 | February 14, 2007 |
| NP.21.15 | February 19, 2009 | SP.15.2 | August 17, 2007 |
| NP.21.16-17 | February 14, 2007 | SP.16.1 | August 19, 2009 |
| NP.21.18-19 | August 21, 2008 | * SP.16.2 | February 15, 2010 |
| NP.21.20 | February 19, 2009 | SP.16.3-4 | February 19, 2009 |

* = Revised, Added, or Deleted

767 Flight Crew Operations Manual

| Page | Date | Page | Date |
|---------------------------------|-------------------|-------------------------------|-----------------|
| Supplementary Procedures (cont) | | Performance - Inflight (cont) | |
| SP.16.5-16 | August 19, 2009 | PI.27.7 | August 19, 2009 |
| Performance - Inflight (tab) | | PI.27.8-12 | August 21, 2008 |
| PI.TOC.1-2 | February 18, 2008 | (blank tab) | |
| PI.TOC.10.1-4 | February 19, 2009 | | |
| PI.10.1-6 | August 21, 2008 | | |
| PI.10.7-14 | February 19, 2009 | | |
| PI.10.15-16 | August 19, 2009 | | |
| PI.10.17-24 | February 19, 2009 | | |
| PI.11.1-6 | August 21, 2008 | | |
| * PI.12.1-2 | February 15, 2010 | | |
| PI.12.3-10 | February 19, 2009 | | |
| PI.12.11-12 | August 21, 2008 | | |
| PI.13.1-10 | August 21, 2008 | | |
| PI.14.1-4 | August 21, 2008 | | |
| PI.15.1-4 | August 21, 2008 | | |
| PI.16.1-7 | August 21, 2008 | | |
| PI.16.8 | August 19, 2009 | | |
| PI.16.9-12 | August 21, 2008 | | |
| PI.TOC.20.1-4 | August 19, 2009 | | |
| PI.20.1-6 | August 21, 2008 | | |
| PI.20.7-12 | August 19, 2009 | | |
| PI.21.1-6 | August 21, 2008 | | |
| * PI.22.1-2 | February 15, 2010 | | |
| PI.22.3-10 | February 19, 2009 | | |
| PI.22.11-12 | August 21, 2008 | | |
| PI.23.1-8 | August 21, 2008 | | |
| PI.24.1-8 | August 21, 2008 | | |
| PI.25.1-6 | August 21, 2008 | | |
| PI.26.1-6 | August 21, 2008 | | |
| PI.27.1-6 | August 21, 2008 | | |

* = Revised, Added, or Deleted

767 Flight Crew Operations Manual

| Page | Date | Page | Date |
|--|-------------------|---|-------------------|
| Volume 2 | | 1 Airplane General, Emergency Equipment, Doors, Windows (cont) | |
| 1 Airplane General, Emergency Equipment, Doors, Windows (tab) | | 1.40.10-12 | February 14, 2007 |
| * 1.TOC.0.1-4 | February 15, 2010 | 1.40.13 | August 17, 2007 |
| * 1.10.1-2 | February 15, 2010 | 1.40.14-15 | February 19, 2009 |
| 1.10.3-4 | August 17, 2007 | 1.40.16 | February 14, 2007 |
| 1.20.1 | February 14, 2007 | 1.45.1 | August 17, 2007 |
| 1.20.2 | February 18, 2008 | 1.45.2-3 | August 19, 2009 |
| 1.20.3-4 | February 14, 2007 | 1.45.4 | February 14, 2007 |
| 1.21.1-2 | February 14, 2007 | 1.45.5 | August 17, 2007 |
| 1.21.3 | August 17, 2007 | 1.45.6 | February 14, 2007 |
| 1.21.4-6 | February 14, 2007 | 1.50.1 | February 14, 2007 |
| * 1.22.1 | February 15, 2010 | * 1.50.2 | February 15, 2010 |
| 1.22.2-4 | February 14, 2007 | 1.50.3 | August 17, 2007 |
| 1.30.1-5 | February 14, 2007 | 1.50.4 | February 14, 2007 |
| 1.30.6-7 | August 17, 2007 | 2 Air Systems (tab) | |
| 1.30.8-10 | February 19, 2009 | * 2.TOC.0.1-2 | February 15, 2010 |
| 1.30.11 | February 14, 2007 | 2.10.1-6 | February 14, 2007 |
| 1.30.12 | August 17, 2007 | 2.10.7-8 | February 18, 2008 |
| 1.30.13-14 | February 19, 2009 | 2.10.9-14 | February 14, 2007 |
| 1.30.15-16 | August 17, 2007 | 2.20.1 | August 21, 2008 |
| 1.30.17 | August 19, 2009 | * 2.20.2-3 | February 15, 2010 |
| 1.30.18-21 | August 17, 2007 | 2.20.4-6 | February 14, 2007 |
| 1.30.22 | February 18, 2008 | 2.30.1-2 | February 14, 2007 |
| 1.30.23-25 | August 17, 2007 | 2.40.1 | August 19, 2009 |
| 1.30.26-28 | February 19, 2009 | 2.40.2 | August 21, 2008 |
| 1.40.1-2 | February 14, 2007 | 2.40.3-4 | February 19, 2009 |
| 1.40.3 | August 19, 2009 | 2.50.1 | February 14, 2007 |
| 1.40.4 | February 19, 2009 | 2.50.2 | August 19, 2009 |
| 1.40.5-6 | August 17, 2007 | 2.50.3-4 | February 14, 2007 |
| 1.40.7-9 | February 18, 2008 | | |

* = Revised, Added, or Deleted

767 Flight Crew Operations Manual

| Page | Date | Page | Date |
|---------------------------------|-------------------|--------------------------------|-------------------|
| 3 Anti-Ice, Rain (tab) | | 5 Communications (cont) | |
| 3.TOC.0.1-2 | February 19, 2009 | 5.20.1 | February 14, 2007 |
| 3.10.1-2 | February 14, 2007 | 5.20.2 | August 17, 2007 |
| 3.10.3-4 | August 17, 2007 | 5.20.3-4 | February 14, 2007 |
| 3.20.1-4 | February 19, 2009 | 5.30.1 | August 17, 2007 |
| 3.30.1-2 | February 14, 2007 | 5.30.2-4 | February 14, 2007 |
| 4 Automatic Flight (tab) | | 5.40.1-3 | August 21, 2008 |
| 4.TOC.0.1-2 | August 19, 2009 | 5.40.4 | February 14, 2007 |
| 4.10.1 | February 14, 2007 | 5.50.1-2 | February 14, 2007 |
| 4.10.2 | August 17, 2007 | 6 Electrical (tab) | |
| 4.10.3-4 | February 14, 2007 | 6.TOC.0.1-2 | August 21, 2008 |
| 4.10.5-8 | August 19, 2009 | 6.10.1-2 | February 14, 2007 |
| 4.10.9 | August 17, 2007 | 6.10.3-4 | August 17, 2007 |
| 4.10.10 | August 21, 2008 | 6.10.5-6 | February 14, 2007 |
| 4.10.11 | August 19, 2009 | 6.20.1-3 | February 14, 2007 |
| 4.10.12 | February 14, 2007 | 6.20.4 | August 17, 2007 |
| 4.10.13-18 | August 19, 2009 | 6.20.5 | February 18, 2008 |
| 4.20.1 | August 21, 2008 | 6.20.6-8 | August 17, 2007 |
| 4.20.2 | February 14, 2007 | 6.20.9-12 | February 14, 2007 |
| 4.20.3 | February 19, 2009 | 6.30.1-2 | February 14, 2007 |
| 4.20.4 | February 14, 2007 | 7 Engines, APU (tab) | |
| 4.20.5-6 | February 19, 2009 | 7.TOC.0.1-4 | August 21, 2008 |
| 4.20.7 | August 19, 2009 | 7.11.1-2 | February 14, 2007 |
| 4.20.8-18 | February 19, 2009 | 7.11.3-5 | February 18, 2008 |
| 4.30.1 | August 17, 2007 | 7.11.6 | February 19, 2009 |
| 4.30.2 | February 14, 2007 | 7.11.7-12 | February 14, 2007 |
| 5 Communications (tab) | | 7.11.13-14 | August 17, 2007 |
| 5.TOC.0.1-2 | August 21, 2008 | 7.11.15-22 | February 14, 2007 |
| 5.10.1-2 | February 14, 2007 | 7.12.1-2 | February 14, 2007 |
| 5.10.3 | August 17, 2007 | 7.12.3 | February 18, 2008 |
| 5.10.4-10 | February 14, 2007 | 7.12.4 | August 17, 2007 |

* = Revised, Added, or Deleted

767 Flight Crew Operations Manual

| Page | Date | Page | Date |
|-----------------------|-------------------|---------------------------------------|-------------------|
| 7 Engines, APU (cont) | | 8 Fire Protection (tab) | |
| 7.12.5 | February 19, 2009 | 8.TOC.0.1-2 | August 21, 2008 |
| 7.12.6-10 | February 14, 2007 | 8.10.1-2 | August 17, 2007 |
| 7.12.11 | August 17, 2007 | * 8.10.3 | February 15, 2010 |
| 7.12.12-22 | February 14, 2007 | 8.10.4-6 | August 17, 2007 |
| 7.15.1-2 | February 14, 2007 | 8.20.1-4 | February 14, 2007 |
| 7.21.1-8 | February 14, 2007 | 8.20.5 | August 17, 2007 |
| 7.21.9 | February 19, 2009 | 8.20.6 | February 14, 2007 |
| 7.21.10 | August 17, 2007 | 8.30.1-2 | February 14, 2007 |
| 7.21.11 | February 14, 2007 | 9 Flight Controls (tab) | |
| 7.21.12 | August 17, 2007 | 9.TOC.0.1-2 | August 21, 2008 |
| 7.21.13 | February 14, 2007 | 9.10.1 | February 14, 2007 |
| 7.21.14 | August 17, 2007 | 9.10.2 | August 21, 2008 |
| 7.21.15 | February 14, 2007 | 9.10.3 | February 14, 2007 |
| 7.21.16 | August 17, 2007 | 9.10.4 | August 17, 2007 |
| 7.21.17-18 | February 14, 2007 | 9.10.5 | February 19, 2009 |
| 7.22.1-4 | February 14, 2007 | 9.10.6-12 | August 17, 2007 |
| 7.22.5 | August 17, 2007 | 9.20.1-12 | February 14, 2007 |
| 7.22.6 | February 14, 2007 | 9.30.1-2 | February 14, 2007 |
| 7.22.7 | August 19, 2009 | 10 Flight Instruments, Displays (tab) | |
| 7.22.8 | February 14, 2007 | 10.TOC.0.1-4 | August 19, 2009 |
| 7.22.9 | February 19, 2009 | * 10.10.1 | February 15, 2010 |
| 7.22.10 | February 14, 2007 | 10.10.2 | August 17, 2007 |
| 7.22.11 | August 17, 2007 | * 10.10.3-7 | February 15, 2010 |
| 7.22.12-16 | February 14, 2007 | 10.10.8 | August 19, 2009 |
| 7.22.17 | August 17, 2007 | * 10.10.9 | February 15, 2010 |
| 7.22.18 | February 14, 2007 | 10.10.10-31 | August 17, 2007 |
| 7.30.1-2 | February 14, 2007 | 10.10.32-35 | February 19, 2009 |
| 7.41.1-4 | August 17, 2007 | 10.10.36 | August 17, 2007 |
| 7.42.1-3 | August 17, 2007 | 10.10.37-38 | August 19, 2009 |
| 7.42.4 | February 14, 2007 | * 10.10.39-43 | February 15, 2010 |

* = Revised, Added, or Deleted

767 Flight Crew Operations Manual

| Page | Date | Page | Date |
|--|-------------------|---|-------------------|
| 10 Flight Instruments, Displays (cont) | | 11 Flight Management, Navigation (cont) | |
| 10.10.44 | February 18, 2008 | 11.20.8 | August 17, 2007 |
| * 10.10.45-46 | February 15, 2010 | 11.30.1-2 | February 14, 2007 |
| 10.10.47-48 | February 18, 2008 | 11.31.1-4 | February 14, 2007 |
| 10.10.49 | August 21, 2008 | 11.31.5 | August 19, 2009 |
| 10.10.50 | February 18, 2008 | 11.31.6-7 | February 14, 2007 |
| 10.10.51 | August 21, 2008 | 11.31.8 | August 19, 2009 |
| 10.10.52-58 | February 18, 2008 | 11.31.9-11 | February 14, 2007 |
| 10.20.1-2 | August 17, 2007 | 11.31.12 | February 18, 2008 |
| 10.20.3-6 | August 19, 2009 | 11.31.13-17 | February 14, 2007 |
| 10.30.1 | February 14, 2007 | 11.31.18 | August 19, 2009 |
| 10.30.2 | August 17, 2007 | 11.31.19-23 | February 14, 2007 |
| 10.30.3 | August 21, 2008 | 11.31.24 | August 17, 2007 |
| 10.30.4-5 | August 17, 2007 | 11.31.25 | February 14, 2007 |
| 10.30.6 | February 14, 2007 | 11.31.26 | August 17, 2007 |
| 10.30.7-8 | August 17, 2007 | 11.31.27-32 | February 14, 2007 |
| 10.30.9-10 | February 14, 2007 | 11.32.1-2 | August 19, 2009 |
| 10.40.1 | February 14, 2007 | 11.32.3-4 | February 14, 2007 |
| 10.40.2 | August 19, 2009 | 11.40.1 | February 14, 2007 |
| 10.40.3-6 | February 14, 2007 | 11.40.2 | August 21, 2008 |
| 10.50.1-2 | February 14, 2007 | 11.40.3 | February 14, 2007 |
| 11 Flight Management, Navigation (tab) | | 11.40.4 | August 17, 2007 |
| 11.TOC.0.1-6 | August 21, 2008 | 11.40.5 | August 19, 2009 |
| 11.10.1 | February 14, 2007 | 11.40.6 | February 14, 2007 |
| 11.10.2 | August 17, 2007 | 11.40.7-8 | February 19, 2009 |
| 11.10.3 | February 14, 2007 | * 11.40.9 | February 15, 2010 |
| 11.10.4 | August 17, 2007 | 11.40.10-15 | February 14, 2007 |
| 11.10.5 | February 19, 2009 | 11.40.16 | February 19, 2009 |
| 11.10.6-9 | February 14, 2007 | 11.40.17-26 | February 14, 2007 |
| 11.10.10-16 | August 17, 2007 | 11.40.27 | February 19, 2009 |
| 11.20.1-7 | February 14, 2007 | 11.40.28-29 | February 14, 2007 |

* = Revised, Added, or Deleted

767 Flight Crew Operations Manual

| Page | Date | Page | Date |
|---|-------------------|---|-------------------|
| 11 Flight Management, Navigation (cont) | | 11 Flight Management, Navigation (cont) | |
| 11.40.30 | February 19, 2009 | 11.43.21-22 | August 17, 2007 |
| 11.40.31-34 | February 14, 2007 | 11.43.23 | February 19, 2009 |
| 11.41.1 | August 19, 2009 | 11.43.24-28 | August 17, 2007 |
| 11.41.2-9 | February 14, 2007 | 11.50.1-6 | February 14, 2007 |
| 11.41.10-11 | August 17, 2007 | 11.60.1-6 | February 14, 2007 |
| 11.41.12 | February 14, 2007 | 12 Fuel (tab) | |
| 11.42.1 | February 14, 2007 | 12.TOC.0.1-2 | August 21, 2008 |
| 11.42.2 | February 19, 2009 | 12.10.1-4 | February 14, 2007 |
| 11.42.3 | August 17, 2007 | 12.20.1-2 | February 14, 2007 |
| 11.42.4 | February 19, 2009 | 12.20.3 | August 17, 2007 |
| 11.42.5 | August 17, 2007 | 12.20.4 | February 18, 2008 |
| 11.42.6 | February 19, 2009 | 12.20.5-8 | February 14, 2007 |
| 11.42.7-8 | August 17, 2007 | 12.30.1-2 | February 14, 2007 |
| 11.42.9 | August 21, 2008 | 13 Hydraulics (tab) | |
| 11.42.10 | February 19, 2009 | 13.TOC.0.1-2 | August 21, 2008 |
| 11.42.11 | August 17, 2007 | 13.10.1-4 | August 17, 2007 |
| 11.42.12 | August 21, 2008 | 13.20.1 | February 14, 2007 |
| 11.42.13-28 | August 17, 2007 | * 13.20.2-3 | February 15, 2010 |
| 11.42.29 | August 21, 2008 | 13.20.4 | February 14, 2007 |
| 11.42.30 | February 19, 2009 | 13.20.5-6 | August 17, 2007 |
| 11.42.31-35 | August 17, 2007 | 13.20.7-8 | February 14, 2007 |
| 11.42.36 | February 18, 2008 | 13.30.1-2 | February 14, 2007 |
| 11.42.37-40 | August 17, 2007 | 14 Landing Gear (tab) | |
| 11.42.41 | August 19, 2009 | 14.TOC.0.1-2 | August 21, 2008 |
| 11.42.42-44 | August 17, 2007 | 14.10.1-3 | February 14, 2007 |
| 11.43.1-5 | February 14, 2007 | 14.10.4-6 | August 17, 2007 |
| 11.43.6 | August 17, 2007 | 14.10.7-8 | February 14, 2007 |
| 11.43.7-10 | February 14, 2007 | 14.20.1-2 | February 19, 2009 |
| 11.43.11-18 | August 17, 2007 | 14.20.3-6 | February 14, 2007 |
| 11.43.19-20 | February 14, 2007 | 14.30.1-2 | February 14, 2007 |

* = Revised, Added, or Deleted

767 Flight Crew Operations Manual

| Page | Date |
|--------------------------|-------------------|
| 15 Warning Systems (tab) | |
| 15.TOC.0.1-4 | August 21, 2008 |
| 15.10.1-8 | February 14, 2007 |
| 15.10.9 | August 17, 2007 |
| 15.10.10 | February 14, 2007 |
| 15.10.11 | February 18, 2008 |
| 15.10.12 | August 21, 2008 |
| 15.10.13 | August 17, 2007 |
| * 15.10.14 | February 15, 2010 |
| 15.10.15-19 | August 21, 2008 |
| 15.10.20 | August 17, 2007 |
| * 15.10.21-22 | February 15, 2010 |
| 15.10.23-25 | August 21, 2008 |
| 15.10.26-27 | February 19, 2009 |
| 15.10.28-29 | August 21, 2008 |
| 15.10.30 | February 18, 2008 |
| 15.20.1-6 | February 14, 2007 |
| 15.20.7 | August 19, 2009 |
| 15.20.8-12 | February 14, 2007 |
| 15.20.13 | August 17, 2007 |
| 15.20.14-19 | February 18, 2008 |
| 15.20.20-22 | August 21, 2008 |
| 15.20.23 | February 18, 2008 |
| * 15.20.24-26 | February 15, 2010 |
| 15.20.27-34 | February 18, 2008 |
| * 15.30.1-2 | February 15, 2010 |
| (blank tab) | |

* = Revised, Added, or Deleted

Intentionally
Blank

* = Revised, Added, or Deleted

General

The Boeing Company issues Flight Crew Operations Manual Bulletins to provide important information to flight crews prior to the next formal revision of the Flight Crew Operations Manual. The transmitted information may be of interest to only specific Operators or may apply to all Operators of this model airplane. Each bulletin will vary.

Bulletins are numbered sequentially for each operator. Each new bulletin is recorded in this record when received and filed as instructed. A bulletin may not apply to all airplane models. In this case, the bulletin specifically identifies the airplane effectivity. When appropriate, the next formal FCOM revision will include an updated bulletin record page.

Bulletin status is defined as follows:

- In Effect (IE) – the bulletin contains pertinent information not otherwise covered in the Flight Crew Operations Manual. The bulletin remains active and should be retained in the manual
- Incorporated (INC) – the bulletin operating information has been incorporated into the Flight Crew Operations Manual. However, the bulletin remains active and should be retained in the manual
- Cancelled (CANC) – the bulletin is no longer active and should be removed from the Flight Crew Operations Manual. All bulletins previously cancelled are no longer listed in the Bulletin Record.

The person filing a new or revised bulletin should amend the Bulletin Record as instructed in the Administrative Information section of the bulletin. When a bulletin includes replacement pages for the Flight Crew Operations Manual or QRH, the included pages should be filed as instructed in the Flight Crew Operations Manual Information section of the bulletin.

| Number | Subject | Date | Status |
|---------------|---|-------------------|---------------|
| TBC-1 | 767-300/RB211-524H Takeoff Thrust Shortfall | February 14, 2007 | IE |
| TBC-2 | ADF Receiver Lockups | February 14, 2007 | IE |
| TBC-3 | ADI Blanking | February 14, 2007 | IE |

| Number | Subject | Date | Status |
|--------|--|-------------------|--------|
| TBC-4 | APU Automatic Shutdown At High Altitude | February 14, 2007 | INC |
| TBC-5 | Assumed Temperature Reduced Thrust Use | February 14, 2007 | IE |
| TBC-6 | Autoland | February 14, 2007 | IE |
| TBC-7 | Autoland Status Annunciator (ASA) Annunciation Change During Coupled Approach | February 14, 2007 | IE |
| TBC-8 | Automatic Landing Operations | February 14, 2007 | IE |
| TBC-9 | B/CRS (Localizer Backcourse) Autopilot/Flight Director Anomaly With -105 Flight Control Computer Installed | February 14, 2007 | IE |
| TBC-10 | Uncommanded Flap/Slat Extension | February 14, 2007 | IE |
| TBC-11 | Fuel In Engine Oil System CF6-80 C2 | February 14, 2007 | IE |
| TBC-12 | Packs Off Takeoff | February 14, 2007 | INC |
| TBC-13 | FMC VFR Approach Anomaly | February 14, 2007 | IE |
| TBC-14 | Uncommanded Autopilot Engagements Or Uncommanded Autoflight Mode Changes | February 14, 2007 | IE |
| TBC-15 | VNAV Descent Through MCP Altitude | February 14, 2007 | IE |
| TBC-16 | Cabin Pressurization Control System (CPCS) Anomaly | February 14, 2007 | IE |
| TBC-17 | Center Tank Fuel Pumps | February 14, 2007 | IE |
| TBC-18 | Consecutive Conditional Altitude Waypoints Map Anomaly | February 14, 2007 | IE |

767 Flight Crew Operations Manual

| Number | Subject | Date | Status |
|---------------|--|-------------------|---------------|
| TBC-19 | Continuous Ignition For Flaps 1 Takeoff | February 14, 2007 | IE |
| TBC-20 | Dual FMC Restarts And Data Link Fail CDU Messages | February 14, 2007 | IE |
| TBC-21 | Electronic Engine Control (EEC) Software Anomaly | February 14, 2007 | IE |
| TBC-22 | Flight Management Computer (FMC) Anomaly of Engine Indicating and Crew Alerting System (EICAS) Alert | February 14, 2007 | IE |
| TBC-23 | Flight Management Computer (FMC) Anomaly During Descent Phase of Flight | February 14, 2007 | IE |
| TBC-24 | Flight Management Computer (FMC) Lockup Resulting from Internal Timer Anomaly | February 14, 2007 | IE |
| TBC-25 | Flight Management Computer (FMC) Lockup Resulting from Flight Plan Route Uplink | February 14, 2007 | IE |
| TBC-26 | FMC Holding Pattern Anomaly | February 14, 2007 | IE |
| TBC-27 | FMC CDU Scratchpad Message "Enter IRS Position" | February 14, 2007 | IE |
| TBC-28 | FMC VNAV Anomaly During Intermediate Level Off | February 14, 2007 | IE |
| TBC-29 | FMC Failure During VOR Remote Tuning | February 14, 2007 | IE |
| TBC-30 | FMC Assumed Temperature Derate Anomaly | February 14, 2007 | IE |
| TBC-31 | Fuel System Imbalance Anomaly | February 14, 2007 | IE |
| TBC-32 | FMC Alternate Airport Anomaly | February 14, 2007 | IE |
| TBC-33 | FMC Altitude Display Anomaly | February 14, 2007 | IE |

767 Flight Crew Operations Manual

| Number | Subject | Date | Status |
|---------------|---|-------------------|---------------|
| TBC-34 | FMC Engine Out (E/O) Standard Instrument Departure (SID) | February 14, 2007 | IE |
| TBC-35 | Incorrect Display of VREF On The ADI Speed Tape | February 14, 2007 | IE |
| TBC-36 | Invalid ILS Indication | February 14, 2007 | IE |
| TBC-37 | Pegasus Flight Management Computer (FMC) VNAV Level Off Anomaly | February 14, 2007 | IE |
| TBC-38 | Pegasus FMC HSI Map Display Anomaly | February 14, 2007 | IE |
| TBC-39 | Performance Adjustments for Thrust Shortfall of PW4000 Series Powered Airplanes with FB2B and FB2T Fans Installed | February 14, 2007 | IE |
| TBC-40 | PW4000 Engine Operation In Heavy Rain Or Hail | February 14, 2007 | IE |
| TBC-41 | PW4000 Engine Idle Modification | February 14, 2007 | IE |
| TBC-42 | Unscheduled In Motion Brake Application | February 14, 2007 | IE |
| TBC-43 | Uncommanded Autopilot Engagement, Flight Mode Changes, And IAS/MACH Window Speed Changes | February 14, 2007 | IE |
| TBC-44 | Uncommanded CDU Page Changes | February 14, 2007 | IE |
| TBC-45 | Use of Manual Trim for Flap 1 Takeoff | February 14, 2007 | IE |
| TBC-46 | VNAV Descent to Holding Altitude | February 14, 2007 | IE |
| TBC-47 | CDU Page Changes During Engine Inoperative Operation | February 14, 2007 | IE |
| TBC-48 | CF6-80C2 FADEC Engine Operation In Heavy Rain Or Hail | February 14, 2007 | IE |

767 Flight Crew Operations Manual

| Number | Subject | Date | Status |
|---------------|---|-------------------|---------------|
| TBC-49 | Erroneous ILS Receiver Outputs | February 14, 2007 | IE |
| TBC-50 | Flight Management Computer (FMC) Resynchronizations | February 14, 2007 | IE |
| TBC-51 | Loss Of FMC Operation | February 14, 2007 | IE |
| TBC-52 | VNAV PATH Altitude Overshoot | February 14, 2007 | IE |
| TBC-53 | Engine Inoperative FMC Data | February 14, 2007 | IE |
| TBC-54 | EICAS Indication Of Impending Engine Fuel Filter Bypass | February 14, 2007 | IE |
| TBC-55 | FMC Display of ATS Datalink Messages From Previous Flights | February 14, 2007 | IE |
| TBC-56 | Loss of Inertial Reference System (IRS) Input to RDMI/RMI During Standby Power Operation | February 14, 2007 | INC |
| TBC-57 | Installation of Pratt & Whitney PW4000 Engines with Ring-Case Compressor (RCC) | February 14, 2007 | INC |
| TBC-58 | Pegasus Flight Management Computer (FMC) Lock-Up Anomaly Due to Data-Bus Communications Failure | February 14, 2007 | IE |
| TBC-59 | Incorrect Turn Direction During a Standard Instrument Departure (SID) | February 14, 2007 | IE |
| TBC-61 | Performance Predictions Anomaly in Flight Management Computer (FMC) Product Improvement Package (PIP) and Pegasus Software Versions | February 14, 2007 | IE |
| TBC-62 | Center Tank Fuel Pump Automatic Power Removal System | February 14, 2007 | INC |
| TBC-63 | Pegasus Flight Management Computer (FMC) Departure Routing Anomaly | February 14, 2007 | IE |

| Number | Subject | Date | Status |
|-----------|---|-------------------|--------|
| TBC-64 | Uncommanded Auxiliary Power Unit (APU) Shutdown Prior to Engine Start | February 14, 2007 | IE |
| TBC-65 | Pegasus-FMC Control and Display Unit (CDU) Anomaly | February 14, 2007 | IE |
| TBC-66 | Auxiliary Power Unit (APU) Bleed Air Supply Fault | May 1, 2007 | IE |
| TBC-67 | B/E Aerospace 174660-N3 Crew Oxygen Mask | May 1, 2007 | IE |
| TBC-68 | B/E Aerospace 174692-N7 Crew Oxygen Mask | May 1, 2007 | IE |
| TBC-70 | Integrated Standby Flight Display (ISFD) Initialization Anomaly | May 1, 2007 | IE |
| TBC-72 R1 | Honeywell Flight Management Computer (FMC) Anomaly | February 15, 2010 | IE |
| TBC-73 R1 | Missing Advisory-Level Message Logic in EICAS Computer P/N S242N701-1001 Operating Program Software (OPS) Version 6 | February 15, 2010 | IE |
| TBC-74 | Hand microphone use with flight deck PC power outlets | September 5, 2008 | IE |
| TBC-75 | General Electric (GE) CF6-80C2 Engine Flameout Mitigation | February 20, 2009 | IE |
| | | | |
| | | | |
| | | | |
| | | | |
| | | | |
| | | | |
| | | | |



Flight Crew Operations Manual Bulletin for The Boeing Company

The Boeing Company
Seattle, Washington 98124-2207



Number: TBC-1

IssueDate: February 14, 2007

Airplane Effectivity: All Airplanes

Subject: 767-300/RB211-524H Takeoff Thrust Shortfall

Reason: This bulletin provides information contained in Blue Bulletin BAB-13 R1, dated January 10, 1994, which provided flight crews with takeoff performance weight penalties.

Information in this bulletin is recommended by The Boeing Company, but may not be FAA approved at the time of writing. In the event of conflict with the FAA approved Airplane Flight Manual (AFM), the AFM shall supersede. The Boeing Company regards the information or procedures described herein as having a direct or indirect bearing on the safe operation of this model airplane.

THE FOLLOWING PROCEDURE AND/OR INFORMATION IS EFFECTIVE UPON RECEIPT

Background Information

Rolls-Royce has advised operators of possible insufficient fuel flow margins on some RB211-524H engines due to fuel metering unit (FMU) wear which can result in performance restrictions for operations from airport pressure altitudes below minus 200 feet within a defined band of outside air temperatures. Modifications to the FMU are currently being evaluated by the engine manufacturer. Rolls-Royce has issued Non-Mod Service Bulletin RB211-71-9276 Rev.5 which requires an FMU health check. The takeoff weight decrements provided below are to be applied in conjunction with the health check defined in the Rolls-Royce Service Bulletin.

Operations Manual Information

The following table shows takeoff weight decrements to be applied when pressure altitude and outside air temperature are within the values indicated. Note that the pressure altitudes shown are all negative and will only be encountered under high QNH conditions. If an operator does not normally take credit for high pressure conditions, no penalty is required.

| PRESSURE ALTITUDE RANGE (FT) | IF TEMPERATURE RANGE IS BETWEEN: (°C) | DECREASE TAKEOFF LIMITED WEIGHT BY: (KG) |
|---------------------------------|---|--|
| ABOVE -200 | ----- | 0 |
| -201 TO -400 | 26 TO 32 | 650 |
| -401 TO -600 | 24 TO 34 | 1250 |
| -601 TO -800 | 22 TO 34 | 1900 |
| -801 TO -1000 | 20 TO 35 | 2550 |
| -1001 TO -1200 | 18 TO 36 | 3200 |
| -1201 TO -1400 | 17 TO 37 | 3800 |
| -1401 TO -1600 | 15 TO 38 | 4450 |
| -1601 TO -1800 | 14 TO 38 | 5100 |
| -1801 TO -2000 | 12 TO 39 | 5700 |

Administrative Information

Insert this bulletin behind the Operations Manual Bulletin Record page in Volume 1 of your Operations Manual. Amend the Operations Manual Bulletin Record to show bulletin TBC-1 "In Effect" (IE).

This Operations Manual Bulletin will be canceled after Boeing is notified that all affected airplanes in the operators fleet have been modified by Rolls-Royce Service Bulletins RR SB 73-9666 and RR SB 73-9694.

Please send all correspondence regarding Operations Manual Bulletins status to one of the following addresses:

Boeing Commercial Airplanes
Commercial Aviation Services
Attn: 767 Manager, Flight Technical Data
P.O. Box 3707, M/C 20-89
Seattle, Washington, 98124-2207 USA
Telephone: (206) 662-4000
Fax: (206) 662-4743



Flight Crew Operations Manual Bulletin for The Boeing Company

The Boeing Company
Seattle, Washington 98124-2207



Number: TBC-2

IssueDate: February 14, 2007

Airplane Effectivity: All Airplanes

Subject: ADF Receiver Lockups

Reason: This bulletin provides information informing flight crews of the potential for ADF receiver lockups.

Information in this bulletin is recommended by The Boeing Company, but may not be FAA approved at the time of writing. In the event of conflict with the FAA approved Airplane Flight Manual (AFM), the AFM shall supersede. The Boeing Company regards the information or procedures described herein as having a direct or indirect bearing on the safe operation of this model airplane.

THE FOLLOWING PROCEDURE AND/OR INFORMATION IS EFFECTIVE UPON RECEIPT

Background Information

Random occurrences of ADF receiver lockups have been reported during short term electrical power interruptions such as during power source transfers. This lockup renders the ADF inoperative and is indicated by the bearing pointer failure flag in view when ADF is selected on the RDMI. If the flight requires the use of the ADF, it is recommended that operation of the ADF be verified after electrical power transfer and before departure. Ensure selection of an in-range station for verification, since selection of an out of range station will produce the same failure flag on the RDMI.

Operation of the ADF may be fully restored by cycling the ADF circuit breaker. During preflight the ADF circuit breaker may be cycled to restore the system.

Production revisions to correct these receiver lockups are incorporated on currently delivered airplanes. Boeing Service Bulletin 767-34-0016 corrects this anomaly.

Administrative Information

Insert this bulletin behind the Operations Manual Bulletin Record page in Volume 1 of your Operations Manual. Amend the Operations Manual Bulletin Record to show bulletin TBC-2 "In Effect" (IE).

This Operations Manual Bulletin will be canceled after Boeing is notified that all affected airplanes in the operators fleet have been modified by Boeing Service Bulletin 767-34-0016.

Please send all correspondence regarding Operations Manual Bulletins status to one of the following addresses:

Boeing Commercial Airplanes
Commercial Aviation Services
Attn: 767 Manager, Flight Technical Data
P.O. Box 3707, M/C 20-89
Seattle, Washington, 98124-2207 USA
Telephone: (206) 662-4000
Fax: (206) 662-4743



Flight Crew Operations Manual Bulletin for The Boeing Company

The Boeing Company
Seattle, Washington 98124-2207



Number: TBC-3

IssueDate: February 14, 2007

Airplane Effectivity: All Airplanes

Subject: ADI Blanking

Reason: This bulletin provides information informing flight crews of the potential for ADI blanking.

Information in this bulletin is recommended by The Boeing Company, but may not be FAA approved at the time of writing. In the event of conflict with the FAA approved Airplane Flight Manual (AFM), the AFM shall supersede. The Boeing Company regards the information or procedures described herein as having a direct or indirect bearing on the safe operation of this model airplane.

THE FOLLOWING PROCEDURE AND/OR INFORMATION IS EFFECTIVE UPON RECEIPT

Background Information

There have been reported instances where the ADI has blanked when the HSI is displaying a large amount of data. In each of these instances, the HSI WPT switch was being used to display waypoints on the HSI.

Boeing Service Bulletin 767-34-0008 corrects this problem. Until the modification is incorporated, the HSI WPT switch must be left in the OFF position for all flight operations. Should flight crews wish to display waypoints in addition to those included in the route of flight, the waypoints need simply be inserted as fixes on the fix page(s).

If such blanking does occur as the result of inadvertent actuation of the HSI WPT switch, first reduce the amount of data selected for display by placing the mapswitches to OFF, then select the affected EFI instrument source select switch to ALTN. The EFI instrument source select switch may then be returned to normal if desired.

Administrative Information

Insert this bulletin behind the Operations Manual Bulletin Record page in Volume 1 of your Operations Manual. Amend the Operations Manual Bulletin Record to show bulletin TBC-3 "In Effect" (IE).

This Operations Manual Bulletin will be canceled after Boeing is notified that all affected airplanes in the operators fleet have been modified by Boeing Service Bulletin 767-34-0008.

Please send all correspondence regarding Operations Manual Bulletins status to one of the following addresses:

Boeing Commercial Airplanes
Commercial Aviation Services
Attn: 767 Manager, Flight Technical Data
P.O. Box 3707, M/C 20-89
Seattle, Washington, 98124-2207 USA
Telephone: (206) 662-4000
Fax: (206) 662-4743



Flight Crew Operations Manual Bulletin for The Boeing Company

The Boeing Company
Seattle, Washington 98124-2207



Number: TBC-4

IssueDate: February 14, 2007

Airplane Effectivity: All Airplanes

Subject: APU Automatic Shutdown At High Altitude

Reason: This bulletin provides flight crews with a modified APU Fault procedure for restarting the APU after an automatic shutdown at high altitude.

Information in this bulletin is recommended by The Boeing Company, but may not be FAA approved at the time of writing. In the event of conflict with the FAA approved Airplane Flight Manual (AFM), the AFM shall supersede. The Boeing Company regards the information or procedures described herein as having a direct or indirect bearing on the safe operation of this model airplane.

THE FOLLOWING PROCEDURE AND/OR INFORMATION IS EFFECTIVE UPON RECEIPT

Background Information

A recent modification to the APU has been found to cause a possible automatic shutdown of the APU. Automatic shutdown of the APU is indicated by the APU FAULT advisory message on EICAS and illumination of the APU FAULT Light.

Investigations by both Boeing and AlliedSignal have revealed that a new APU Gearbox Shutoff Valve, PN 3616848-1, can cause the automatic shutdown. The PN 3616848-1 valve has been installed on ND199 during production at Boeing and is installed on other airplanes if Allied Signal Service Bulletin GTCP331-49-7147 has been incorporated.

It has been found that the APU, on airplanes with the PN 3616848-1 valve, can be restarted and will operate normally at or below 35,000 feet.

Older airplanes with a previously installed valve, PN3289514-1, are not experiencing automatic APU shutdowns.

Testing has confirmed that a PN 3616848-2 configuration of the valve corrects the shutdown problem. Allied Signal Service Bulletin GTCP331-49-7263 provides instructions for replacing the PN 3616848-1 valve with the -2 valve.

Operating Instructions

If an automatic shutdown of the APU occurs, accomplish the APU Fault procedure.

The APU Fault procedure has been modified to instruct descending to 35,000 feet or below if APU operation is required.

Administrative Information

Insert this bulletin behind the Operations Manual Bulletin Record page in Volume 1 of your Operations Manual. Amend the Operations Manual Bulletin Record to show bulletin TBC-4 "Incorporated" (INC).

This Operations Manual Bulletin will be canceled after Boeing is notified that all affected airplanes in the operators fleet have been modified by Allied Signal Service Bulletin GTCP331-49-7263.

Please send all correspondence regarding Operations Manual Bulletins status to one of the following addresses:

Boeing Commercial Airplanes
Commercial Aviation Services
Attn: 767 Manager, Flight Technical Data
P.O. Box 3707, M/C 20-89
Seattle, Washington, 98124-2207 USA
Telephone: (206) 662-4000
Fax: (206) 662-4743



Flight Crew Operations Manual Bulletin for The Boeing Company

The Boeing Company
Seattle, Washington 98124-2207



Number: TBC-5

IssueDate: February 14, 2007

Airplane Effectivity: All Airplanes

Subject: Assumed Temperature Reduced Thrust Use

Reason: This bulletin provides information advising flight crews of thrust shortfall that may occur when the assumed temperature method of reduced takeoff thrust is used in combination with takeoff derates on 767-200 airplanes.

Information in this bulletin is recommended by The Boeing Company, but may not be FAA approved at the time of writing. In the event of conflict with the FAA approved Airplane Flight Manual (AFM), the AFM shall supersede. The Boeing Company regards the information or procedures described herein as having a direct or indirect bearing on the safe operation of this model airplane.

THE FOLLOWING PROCEDURE AND/OR INFORMATION IS EFFECTIVE UPON RECEIPT

Background Information

On 767-200 airplanes with takeoff thrust derate capability, after selecting Takeoff Derate 1 or 2, additional takeoff thrust reductions can be obtained using the assumed temperature method. The Thrust Management Computer (TMC) calculates derated takeoff thrust %N1 (derate 1 or 2) including any assumed temperature selected on the Thrust Mode Select Panel (TMSP).

It was determined that the originally published %N1 data for assumed temperature reduced thrust with Takeoff Derate 1 or 2 are incorrect. These data are also incorporated into the -304 TMC. The incorrect data may result in a thrust shortfall if assumed temperature reduced thrust is used in combination with Takeoff Derate 1 or 2. Assumed temperature reduction applied to full rated takeoff thrust does not result in such an adverse affect. The Takeoff Derate 1 and 2 assumed temperature reduced thrust setting data have been revised. The revised data has been incorporated in the -305 TMC. Boeing Service Bulletin 767-22-0022 is available for converting a -304 TMC to a -305 TMC.

Operating Instructions

Until Boeing Service Bulletin 767-22-0022 is incorporated, do not use assumed temperature reduced thrust with Takeoff Derate 1 or 2 selected.

Assumed temperature reduced thrust may be used with Full rated takeoff thrust.

Administrative Information

Insert this bulletin behind the Operations Manual Bulletin Record page in Volume 1 of your Operations Manual. Amend the Operations Manual Bulletin Record to show bulletin TBC-5 "In Effect" (IE).

This Operations Manual Bulletin will be canceled after Boeing is notified that all affected airplanes in the operators fleet have been modified by Boeing Service Bulletin 767-22-0022.

Please send all correspondence regarding Operations Manual Bulletins status to one of the following addresses:

Boeing Commercial Airplanes
Commercial Aviation Services
Attn: 767 Manager, Flight Technical Data
P.O. Box 3707, M/C 20-89
Seattle, Washington, 98124-2207 USA
Telephone: (206) 662-4000
Fax: (206) 662-4743



Flight Crew Operations Manual Bulletin for The Boeing Company

The Boeing Company
Seattle, Washington 98124-2207



Number: TBC-6

IssueDate: February 14, 2007

Airplane Effectivity: All Airplanes

Subject: Autoland

Reason: This bulletin provides information informing flight crews of conditions that preclude the use of autoland.

Information in this bulletin is recommended by The Boeing Company, but may not be FAA approved at the time of writing. In the event of conflict with the FAA approved Airplane Flight Manual (AFM), the AFM shall supersede. The Boeing Company regards the information or procedures described herein as having a direct or indirect bearing on the safe operation of this model airplane.

THE FOLLOWING PROCEDURE AND/OR INFORMATION IS EFFECTIVE UPON RECEIPT

Background Information

During the 767-300 autoland certification, unusually high sink rates at touchdown were encountered in high density altitude conditions with tailwinds, and groundspeeds in excess of 165 knots. An improved autoland system was developed to reduce sink rates at these conditions. Subsequent evaluation of the 767-200 under similar conditions has shown that high sink rates could also develop at touchdown from an autoland for all 767-200s with the -103, -105, and -106 FCC without the improved autoland system activated. The improved autoland system is standard for all 767-300 airplanes and available for retrofit on the 767-200 airplanes by installing the -106 or later FCC and activating the wiring change of Boeing Service Bulletin 767-22-0026 or production introduction of equivalent configuration by PRR B11723 (Part A and B).

Operating Instructions

Pending operator fleetwide FCC and wiring update the following applies:

If groundspeed on short final approach (approximately 200 feet AGL) exceeds 165 knots, accomplish a manual landing.

Administrative Information

Insert this bulletin behind the Operations Manual Bulletin Record page in Volume 1 of your Operations Manual. Amend the Operations Manual Bulletin Record to show bulletin TBC-6 "In Effect" (IE).

This Operations Manual Bulletin will be canceled after Boeing is notified that all affected airplanes in the operators fleet have been modified by Boeing Service Bulletin 767-22-0026.

Please send all correspondence regarding Operations Manual Bulletins status to one of the following addresses:

Boeing Commercial Airplanes
Commercial Aviation Services
Attn: 767 Manager, Flight Technical Data
P.O. Box 3707, M/C 20-89
Seattle, Washington, 98124-2207 USA
Telephone: (206) 662-4000
Fax: (206) 662-4743



Flight Crew Operations Manual Bulletin for The Boeing Company

The Boeing Company
Seattle, Washington 98124-2207



Number: TBC-7

IssueDate: February 14, 2007

Airplane Effectivity: All Airplanes

Subject: Autoland Status Annunciator (ASA) Annunciation Change During Coupled Approach

Reason: This bulletin provides information informing flight crews of temporary recommended procedures for coupled approach anomalies.

Information in this bulletin is recommended by The Boeing Company, but may not be FAA approved at the time of writing. In the event of conflict with the FAA approved Airplane Flight Manual (AFM), the AFM shall supersede. The Boeing Company regards the information or procedures described herein as having a direct or indirect bearing on the safe operation of this model airplane.

THE FOLLOWING PROCEDURE AND/OR INFORMATION IS EFFECTIVE UPON RECEIPT

Background Information

During a test flight at Boeing, all three autopilot channels disconnected during a coupled approach. Analysis revealed that this condition is caused by an error introduced between the Flight Control Computers (FCC) during a power transfer. The error occurs if one source of electrical power fails after the LAND 3 annunciation appears during approach. During the power transfer, air data from the Air Data computers is interrupted. The time required for the electrical system to revert to normal, then re-isolate may exceed the limit allowed for interruption of air data, and result in loss of air data to one FCC for the duration of the approach. As a result, an autopilot disconnect may occur during flare or during go-around. Service Bulletin 767-22-0038 corrects this anomaly.

Disconnecting the autopilots causes the electrical system to revert to normal operations (non-isolated), and resets the autoland system and ASA to allow normal LAND 2 or LAND 3 operation on subsequent approaches.

Operating Instructions

If, during an autopilot (coupled) approach, following the LAND 3 annunciation, the Autoland Status Annunciator (ASA) is observed to change to LAND 2, execute a manual landing on that approach (weather permitting), or execute a manual go-around.

If the approach is continued, the autopilot must be disconnected prior to landing. If a go-around is accomplished, the autopilot must be disconnected prior to executing the go-around.

A subsequent autopilot (coupled) approach and landing may be conducted provided LAND 2 or LAND 3 remains annunciated on that approach.

Administrative Information

Insert this bulletin behind the Operations Manual Bulletin Record page in Volume 1 of your Operations Manual. Amend the Operations Manual Bulletin Record to show bulletin TBC-7 "In Effect" (IE).

This Operations Manual Bulletin will be canceled after Boeing is notified that all affected airplanes in the operators fleet have been modified by Boeing Service Bulletin 767-22-0038.

Please send all correspondence regarding Operations Manual Bulletins status to one of the following addresses:

Boeing Commercial Airplanes
Commercial Aviation Services
Attn: 767 Manager, Flight Technical Data
P.O. Box 3707, M/C 20-89
Seattle, Washington, 98124-2207 USA
Telephone: (206) 662-4000
Fax: (206) 662-4743



Flight Crew Operations Manual Bulletin for The Boeing Company

The Boeing Company
Seattle, Washington 98124-2207



Number: TBC-8

IssueDate: February 14, 2007

Airplane Effectivity: All Airplanes

Subject: Automatic Landing Operations

Reason: This bulletin provides information informing flight crews of the potential for autopilot disconnect.

Information in this bulletin is recommended by The Boeing Company, but may not be FAA approved at the time of writing. In the event of conflict with the FAA approved Airplane Flight Manual (AFM), the AFM shall supersede. The Boeing Company regards the information or procedures described herein as having a direct or indirect bearing on the safe operation of this model airplane.

THE FOLLOWING PROCEDURE AND/OR INFORMATION IS EFFECTIVE UPON RECEIPT

Background Information

An anomaly has been identified which has an adverse affect on the integrity of the automatic landing system and can result in increased potential for autopilot disconnect at low altitude.

An operator has reported three cases of multiple autopilot disconnect, These disconnects are the result of distortion of the glideslope signal resulting from the proximity of the radome lower hinge arm to the glideslope antenna. Individual system installation tolerances (airplane and airport) may affect the probability of such autopilot disconnects.

Boeing Service Bulletin 767-53-0022 dated December 20, 1985 has been released to provide instructions to correct the situation. This Service Bulletin provides for interim corrective action involving removal of the lower hinge arm.

Administrative Information

Insert this bulletin behind the Operations Manual Bulletin Record page in Volume 1 of your Operations Manual. Amend the Operations Manual Bulletin Record to show bulletin TBC-8 "In Effect" (IE).

This Operations Manual Bulletin will be canceled after Boeing is notified that all affected airplanes in the operators fleet have been modified by Boeing Service Bulletin 767-53-0022.

Please send all correspondence regarding Operations Manual Bulletins status to one of the following addresses:

Boeing Commercial Airplanes
Commercial Aviation Services
Attn: 767 Manager, Flight Technical Data
P.O. Box 3707, M/C 20-89
Seattle, Washington, 98124-2207 USA
Telephone: (206) 662-4000
Fax: (206) 662-4743



Flight Crew Operations Manual Bulletin for The Boeing Company

The Boeing Company
Seattle, Washington 98124-2207



Number: TBC-9

IssueDate: February 14, 2007

Airplane Effectivity: All Airplanes

Subject: B/CRS (Localizer Backcourse) Autopilot/Flight Director Anomaly
With -105 Flight Control Computer Installed

Reason: This bulletin provides information advising flight crews to avoid engaging an autopilot after capturing the localizer B/CRS mode provided recommendations in the event the autopilot were inadvertently engaged after B/CRS capture.

Information in this bulletin is recommended by The Boeing Company, but may not be FAA approved at the time of writing. In the event of conflict with the FAA approved Airplane Flight Manual (AFM), the AFM shall supersede. The Boeing Company regards the information or procedures described herein as having a direct or indirect bearing on the safe operation of this model airplane.

THE FOLLOWING PROCEDURE AND/OR INFORMATION IS EFFECTIVE UPON RECEIPT

Background Information

The -105 Flight Control Computer (FCC) has an anomaly when flying a backcourse approach using the flight director and subsequently engaging an autopilot. If an autopilot is engaged after flight director localizer B/CRS capture, B/CRS may disengage and, depending upon course error, one of the following would occur: for course errors less than 60 degrees, the FCCs revert to HDG HOLD and LOC mode arms; for course errors 60 degrees or greater, the FCCs revert to LOC mode and command a 30 degree bank turn to capture the localizer front course resulting in turning away from the backcourse localizer centerline.

The -106 FCC installed by Boeing Service Bulletin 767-22-0026 or production equivalent configuration (PRR B11723) corrects this anomaly.

Operating Instructions

If the autopilot is to be used for a localizer backcourse, engage the autopilot prior to localizer B/CRS capture. In the event the autopilot is not engaged prior to B/CRS capture, the autopilot and both Flight Directors must be switched off. The autopilot may then be re-engaged if desired, prior to reselecting B/CRS. Operation of the flight director for backcourse localizer is not affected if the autopilot is not engaged.

Administrative Information

Insert this bulletin behind the Operations Manual Bulletin Record page in Volume 1 of your Operations Manual. Amend the Operations Manual Bulletin Record to show bulletin TBC-9 "In Effect" (IE).

This Operations Manual Bulletin will be canceled after Boeing is notified that all affected airplanes in the operators fleet have been modified by Boeing Service Bulletin 767-22-0026.

Please send all correspondence regarding Operations Manual Bulletins status to one of the following addresses:

Boeing Commercial Airplanes
Commercial Aviation Services
Attn: 767 Manager, Flight Technical Data
P.O. Box 3707, M/C 20-89
Seattle, Washington, 98124-2207 USA
Telephone: (206) 662-4000
Fax: (206) 662-4743



Flight Crew Operations Manual Bulletin for The Boeing Company

The Boeing Company
Seattle, Washington 98124-2207



Number: TBC-10

IssueDate: February 14, 2007

Airplane Effectivity: All Airplanes

Subject: Uncommanded Flap/Slat Extension

Reason: This bulletin provides flight crews with interim operating instructions in the event the flap indicator is oscillating.

Information in this bulletin is recommended by The Boeing Company, but may not be FAA approved at the time of writing. In the event of conflict with the FAA approved Airplane Flight Manual (AFM), the AFM shall supersede. The Boeing Company regards the information or procedures described herein as having a direct or indirect bearing on the safe operation of this model airplane.

THE FOLLOWING PROCEDURE AND/OR INFORMATION IS EFFECTIVE UPON RECEIPT

Background Information

Several operators have reported erratic trailing edge flap indications during electrical power transfers. The flap indicator needles oscillate erratically between "UP" and "1" and the built in test equipment LEDs for section three on the Flap/Slat Electronic Unit (FSEU) have been noted to be flashing. These symptoms could continue unless the FSEU section three circuit breakers are pulled for approximately 15 seconds and then reset.

An operator reported an inflight occurrence of oscillating flap indicator needles when selecting Flaps 1 accompanied by a TE FLAP DISAGREE message and intermittent illumination of the LEADING EDGE Light. The LE SLAT ASYMMETRY, LE SLAT DISAGREE and TE FLAP DISAGREE checklists were accomplished resulting in arming of the alternate flap system. At 5000 feet, 208 knots, a sudden loss of airspeed to 180 knots with buffet and altitude ballooning to 5500 feet were experienced. The flap handle was up and the alternate flap selector was in normal, but visual inspection from the cabin showed the flaps to be at position 30. A normal landing was made and the airplane arrived at the gate with the flaps and slats down, the flap handle up, and the flap indicator oscillating. The alternate system would not move the flaps or slats.

All conditions returned to normal after power was removed from the airplane and restored.

The flap needle fluctuations described above are caused by electrical power transfers. Boeing Service Bulletin 767-27-0058 corrects this problem.

Operating Instructions

Until all FSEUs are modified, the following interim operating instructions are recommended:

To prevent possible uncommanded flap/slat extension or retraction, do not arm the alternate flap system during cruise or when above the Flap "1" Placard speed, or when the flap indicator needles are oscillating. If flap indicator needles are oscillating, use normal system to extend/retract flaps.

Administrative Information

Insert this bulletin behind the Operations Manual Bulletin Record page in Volume 1 of your Operations Manual. Amend the Operations Manual Bulletin Record to show bulletin TBC-10 "In Effect" (IE).

This Operations Manual Bulletin will be canceled after Boeing is notified that all affected airplanes in the operators fleet have been modified by Boeing Service Bulletin 767-27-0058.

Please send all correspondence regarding Operations Manual Bulletins status to one of the following addresses:

Boeing Commercial Airplanes
Commercial Aviation Services
Attn: 767 Manager, Flight Technical Data
P.O. Box 3707, M/C 20-89
Seattle, Washington, 98124-2207 USA
Telephone: (206) 662-4000
Fax: (206) 662-4743



Flight Crew Operations Manual Bulletin for The Boeing Company

The Boeing Company
Seattle, Washington 98124-2207



Number: TBC-11

IssueDate: February 14, 2007

Airplane Effectivity: All Airplanes

Subject: Fuel In Engine Oil System CF6-80 C2

Reason: This bulletin provides information informing flight crews of the possibility of fuel entering the engine oil system.

Information in this bulletin is recommended by The Boeing Company, but may not be FAA approved at the time of writing. In the event of conflict with the FAA approved Airplane Flight Manual (AFM), the AFM shall supersede. The Boeing Company regards the information or procedures described herein as having a direct or indirect bearing on the safe operation of this model airplane.

THE FOLLOWING PROCEDURE AND/OR INFORMATION IS EFFECTIVE UPON RECEIPT

Background Information

There have been numerous reported events on CF6-80C2 powered airplanes where engine oil has been contaminated with fuel. Several of these events resulted in uncontained engine failures in flight when a fire has occurred in the oil vent system shortly after takeoff.

There are four points where fuel can leak into and contaminate the oil:

1. Fuel/oil Heat Exchanger leakage.
2. N1 Hydro Mechanical Sensor.
3. Seal in the Fuel Control Unit.
4. Fuel lines on the Fuel Control Unit being switched.

GE Service Bulletin 72-648 has been issued to prevent uncontained engine failures in the event a fire occurs in the oil vent system.

Boeing previously advised that internal leakage of fuel into the oil system should be suspected if the oil quantity indication was at or approaching 20 or more units after engine start. However, since issue of the original bulletin, several operators have reported oil quantity indications of approximately 21 units after engine start which, when investigated, were not due to fuel/oil contamination. The increase in oil quantity was due to a slight over servicing, expansion of oil due to temperature increase or an increase in scavenge efficiency with the engine at idle. For these reasons, the oil quantity check after engine start has been increased to 22 units.

Information on these events has shown inconsistent indications for fuel in the oil system which cannot provide a sound basis for flight crew procedures inflight. Since flight crews do not continuously monitor the oil system indications, changes in the oil system parameters may not be noticed. However, if the oil quantity is observed to be increasing during steady state operation, or if at any time during engine operation the oil quantity indication is at or approaching 22 or more units, then internal leakage of fuel into the oil system should be suspected. This condition should be entered in the Flight Log for maintenance action prior to the next flight.

The first cockpit indication of a fuel contaminated oil system may be an increasing or overfilled oil tank quantity. The rate of oil quantity increase depends on the severity of the fuel leak. Leaks are normally detected by maintenance personnel during required checks, or while investigating flight crew complaints of increasing oil quantity. An extreme overfull condition may be accompanied by increasing oil temperature, fluctuating or decreasing oil pressure, or fuel/oil fumes in the cabin.

Additional maintenance checks have been implemented following servicing of the oil tanks, or after maintenance on the engine oil or fuel system, to detect fuel contamination of the oil. This results in more frequent checks of the oil system.

Operating Instructions

Since the data on at least one uncontained failure indicates the oil tank was over filled at engine start, accomplish the following check until GE Service Bulletin 72-648 is incorporated.

At least 30 seconds after the engine reaches stabilized idle and prior to taxi:

OIL QUANTITY ----- CHECK

If the oil quantity indicates 22 or more units, maintenance investigation is required prior to takeoff.

Administrative Information

Insert this bulletin behind the Operations Manual Bulletin Record page in Volume 1 of your Operations Manual. Amend the Operations Manual Bulletin Record to show bulletin TBC-11 "In Effect" (IE).

This Operations Manual Bulletin will be canceled after Boeing is notified that all affected airplanes in the operators fleet have been modified by GE Service Bulletin 72-648.

Please send all correspondence regarding Operations Manual Bulletins status to one of the following addresses:

Boeing Commercial Airplanes
Commercial Aviation Services
Attn: 767 Manager, Flight Technical Data
P.O. Box 3707, M/C 20-89
Seattle, Washington, 98124-2207 USA
Telephone: (206) 662-4000
Fax: (206) 662-4743

Intentionally
Blank



Flight Crew Operations Manual Bulletin for The Boeing Company

The Boeing Company
Seattle, Washington 98124-2207



Number: TBC-12

IssueDate: February 14, 2007

Airplane Effectivity: All Airplanes

Subject: Packs Off Takeoff

Reason: This bulletin provides information informing flight crews of an interim procedure to prevent possible jamming of the outflow valve during a packs off takeoff. The Packs Off Takeoff supplementary normal procedure now incorporates this bulletin.

Information in this bulletin is recommended by The Boeing Company, but may not be FAA approved at the time of writing. In the event of conflict with the FAA approved Airplane Flight Manual (AFM), the AFM shall supersede. The Boeing Company regards the information or procedures described herein as having a direct or indirect bearing on the safe operation of this model airplane.

THE FOLLOWING PROCEDURE AND/OR INFORMATION IS EFFECTIVE UPON RECEIPT

Background Information

There have been a few reports of uncontrollable cabin pressurization when the packs were turned on following a packs off takeoff, with subsequent inability to depressurize the airplane normally after landing. This has sometimes resulted in inability to open the cabin doors for several minutes. Boeing has verified that it is possible for the outflow valve to jam in the closed position when the airplane is configured for a packs off takeoff. This can be prevented by using the manual system to position the outflow valve approximately three-quarters open prior to takeoff.

Operating Instructions

If a packs off takeoff is desired, accomplish the “Packs Off Takeoff” supplementary normal procedure. This procedure incorporates the interim steps necessary until the system is modified.

Administrative Information

Insert this bulletin behind the Operations Manual Bulletin Record page in Volume 1 of your Operations Manual. Amend the Operations Manual Bulletin Record to show bulletin TBC-12 "Incorporated" (INC).

This Operations Manual Bulletin will be canceled after Boeing is notified that all affected airplanes in the operators fleet have been modified by Boeing Service Letter SL 767-21-047C and Allied Signal Service Bulletins 2117388-21-2655 and 606832-21-2661.

Please send all correspondence regarding Operations Manual Bulletins status to one of the following addresses:

Boeing Commercial Airplanes
Commercial Aviation Services
Attn: 767 Manager, Flight Technical Data
P.O. Box 3707, M/C 20-89
Seattle, Washington, 98124-2207 USA
Telephone: (206) 662-4000
Fax: (206) 662-4743



Flight Crew Operations Manual Bulletin for The Boeing Company

The Boeing Company
Seattle, Washington 98124-2207



Number: TBC-13

IssueDate: February 14, 2007

Airplane Effectivity: All Airplanes

Subject: FMC VFR Approach Anomaly

Reason: This bulletin provides information informing flight crews of temporary recommended procedures for FMC generated VFR approaches.

Information in this bulletin is recommended by The Boeing Company, but may not be FAA approved at the time of writing. In the event of conflict with the FAA approved Airplane Flight Manual (AFM), the AFM shall supersede. The Boeing Company regards the information or procedures described herein as having a direct or indirect bearing on the safe operation of this model airplane.

THE FOLLOWING PROCEDURE AND/OR INFORMATION IS EFFECTIVE UPON RECEIPT

Background Information

On a recent customer revenue flight, an anomaly was discovered when a VFR approach was selected. Further evaluation concluded that the anomaly affects airplanes with software version PS4052970-952. The anomaly does not pertain to other FMC software versions.

When operating an FMC with software version PS4052970-952 and an FMC generated VFR approach is selected on the Arrivals page by line selecting the "VFR APPR" prompt, the resulting course from the VFR final approach fix to the runway threshold may be computed in error. The erroneous course is displayed on the legs page and the HSI. The T/D may also be displaced. If engaged, LNAV will fly the displayed erroneous course.

Operating Instructions

Do not perform FMC generated VFR approaches using the VFR APPR line select key when using this software number. A valid VFR approach with accurate course information can be created by manually inserting the desired runway extension on the RWY EXT line.

When operating FMCs with other software numbers, VFR approaches may still be selected, if available.

Administrative Information

Insert this bulletin behind the Operations Manual Bulletin Record page in Volume 1 of your Operations Manual. Amend the Operations Manual Bulletin Record to show bulletin TBC-13 "In Effect" (IE).

The FMC anomaly will be corrected by Boeing Service Bulletin 767-34-0182. Other FMC's are corrected by Boeing Service Bulletin 767-34-0186 or 767-34-0188 or 767-34-0199 or 767-34-0205. Refer to individual Service Bulletin for applicability.

This Operations Manual Bulletin will be canceled after Boeing is notified that the affected FMC operating program is no longer installed on any of the airplanes in the operators fleet.

Please send all correspondence regarding Operations Manual Bulletins status to one of the following addresses:

Boeing Commercial Airplanes
Commercial Aviation Services
Attn: 767 Manager, Flight Technical Data
P.O. Box 3707, M/C 20-89
Seattle, Washington, 98124-2207 USA
Telephone: (206) 662-4000
Fax: (206) 662-4743



Flight Crew Operations Manual Bulletin for The Boeing Company

The Boeing Company
Seattle, Washington 98124-2207



Number: TBC-14

IssueDate: February 14, 2007

Airplane Effectivity: All Airplanes

Subject: Uncommanded Autopilot Engagements Or Uncommanded Autoflight Mode Changes

Reason: This bulletin provides information informing flight crews of temporary recommended procedures in the event of uncommanded autopilot engagement or autoflight mode changes.

Information in this bulletin is recommended by The Boeing Company, but may not be FAA approved at the time of writing. In the event of conflict with the FAA approved Airplane Flight Manual (AFM), the AFM shall supersede. The Boeing Company regards the information or procedures described herein as having a direct or indirect bearing on the safe operation of this model airplane.

THE FOLLOWING PROCEDURE AND/OR INFORMATION IS EFFECTIVE UPON RECEIPT

Background Information

Boeing flight tests have encountered a condition that can cause uncommanded autopilot engagement or mode changes of the autopilot or flight director. This condition may occur at any time or altitude except when multiple autopilots are engaged for approach.

This condition is caused by faulty Mode Control Panel pushbutton switches installed during production or repair. The condition affects the left and center Flight Control Computers. These Flight Control Computers normally provide commands for the left and center autopilots and flight directors.

The normal means for disconnecting the autopilot (autopilot disengage switch, autopilot disengage bar, and control wheel stabilizer trim switches) are not affected by this problem.

Boeing and Collins are working aggressively to facilitate the modification of affected units by mid summer, 1993. To date, no in service events have been reported to Boeing.

Operating Instructions

Flight crews should be prepared to disengage the autopilot during critical phases of flight including takeoff. Flight Mode Displays must be closely monitored. An uncommanded mode change or autopilot engagement can be corrected by selecting the desired mode or disconnecting the autopilot.

Administrative Information

Insert this bulletin behind the Operations Manual Bulletin Record page in Volume 1 of your Operations Manual. Amend the Operations Manual Bulletin Record to show bulletin TBC-14 "In Effect" (IE).

This Operations Manual Bulletin will be canceled after Boeing is notified that all affected airplanes in the operators fleet have been modified by Collins Component Service Bulletin MCP-701-22-19, dated April 23, 1993 or Collins Component Service Bulletin MCP-704-22-10, dated April 23, 1993. Additional details and specific applicability of the Service Bulletins are contained in Boeing All-operator telex M-7272-93-2738, dated May 10, 1993.

Please send all correspondence regarding Operations Manual Bulletins status to one of the following addresses:

Boeing Commercial Airplanes
Commercial Aviation Services
Attn: 767 Manager, Flight Technical Data
P.O. Box 3707, M/C 20-89
Seattle, Washington, 98124-2207 USA
Telephone: (206) 662-4000
Fax: (206) 662-4743



Flight Crew Operations Manual Bulletin for The Boeing Company

The Boeing Company
Seattle, Washington 98124-2207



Number: TBC-15

IssueDate: February 14, 2007

Airplane Effectivity: All Airplanes

Subject: VNAV Descent Through MCP Altitude

Reason: This bulletin provides information informing flight crews that VNAV may command the airplane to descend through the MCP altitude when a B (at or below) altitude constraint is entered on the FMC RTE LEGS page for a holding pattern.

Information in this bulletin is recommended by The Boeing Company, but may not be FAA approved at the time of writing. In the event of conflict with the FAA approved Airplane Flight Manual (AFM), the AFM shall supersede. The Boeing Company regards the information or procedures described herein as having a direct or indirect bearing on the safe operation of this model airplane.

THE FOLLOWING PROCEDURE AND/OR INFORMATION IS EFFECTIVE UPON RECEIPT

Background Information

Operators have reported a condition in which the airplane may descend below the MCP Altitude Window value during VNAV descent.

Boeing has determined this anomaly can occur on all 767 airplanes except for airplanes that both:

- Have "VERSION 2.0" displayed on the FMC CDU IDENT page after the operating program number, and
- Incorporate the VNAV ALT mode.

VNAV descents may continue below MCP Altitude Window settings when both of the following conditions have been met.

- The HOLD AT line on the RTE LEGS page contains a B (at or below) altitude constraint, and
- The MCP Altitude Window is set for the same value as the B altitude constraint.

This anomaly will not occur when a B altitude constraint is entered on the waypoint line above the HOLD AT waypoint line.

The cause of the anomaly has been identified and will be addressed in the next revisions of the FMC software scheduled for update on 767 airplanes.

Operating Instructions

For VNAV descent, flight crews should not use B (at or below) altitude constraints on the HOLD AT line of the RTE LEGS page for holding patterns in the descent profile.

Administrative Information

Insert this bulletin behind the Operations Manual Bulletin Record page in Volume 1 of your Operations Manual. Amend the Operations Manual Bulletin Record to show bulletin TBC-15 "In Effect" (IE).

This Operations Manual Bulletin will be canceled after Boeing is notified that all affected airplanes in the operators fleet have been modified by either Boeing Service Bulletin 767-34-0205 or Boeing Service Bulletin 767-34-0211 or Boeing Service Bulletin 767-34-0212 or Boeing Service Bulletin 767-34-0222.

Please send all correspondence regarding Operations Manual Bulletins status to one of the following addresses:

Boeing Commercial Airplanes
Commercial Aviation Services
Attn: 767 Manager, Flight Technical Data
P.O. Box 3707, M/C 20-89
Seattle, Washington, 98124-2207 USA
Telephone: (206) 662-4000
Fax: (206) 662-4743



Flight Crew Operations Manual Bulletin for The Boeing Company

The Boeing Company
Seattle, Washington 98124-2207



Number: TBC-16

IssueDate: February 14, 2007

Airplane Effectivity: All Airplanes

Subject: Cabin Pressurization Control System (CPCS) Anomaly

Reason: To inform flight crews of a Cabin Pressurization Control System anomaly.

Information in this bulletin is recommended by The Boeing Company, but may not be FAA approved at the time of writing. In the event of conflict with the FAA approved Airplane Flight Manual (AFM), the AFM shall supersede. The Boeing Company regards the information or procedures described herein as having a direct or indirect bearing on the safe operation of this model airplane.

THE FOLLOWING PROCEDURE AND/OR INFORMATION IS EFFECTIVE UPON RECEIPT

Background Information

An anomaly has been discovered with the Cabin Pressurization Control System (CPCS). A recent software change in the CPCS may result in the outflow valve closing and the airplane pressurizing on the ground. In some cases, this has resulted in the inability to open the passenger entry doors.

Boeing has discovered this anomaly was introduced in a recent software change in the Cabin Pressurization Controllers (CPC). Specifically, airplane pressurization can occur after an electrical power transfer is accomplished. This includes, but is not limited to, electrical power transfers as a result of normal engine start and shutdown operations.

The affected Honeywell CPC software is:

2117388-11

2117388-12 and,

2117388-13.

Operating Instructions

The following highlighted procedural steps should be executed as shown below immediately after the “Fuel Control switches” step as published in the Normal Procedures section of The Boeing Company Operations Manual, Volume I:

FUEL CONTROL switches ----- CUT OFF C

Verify ENG VALVE and SPAR VALVE lights extinguished.

CABIN ALTITUDE MODE SELECTOR ----- MAN F/O

If outflow valve not fully open:

CABIN ALTITUDE MANUAL CONTROL ----- CLIMB F/O

Position outflow valve fully open.

The above highlighted procedural steps should be accomplished during all shutdown operations. This will preclude the CPC anomaly from inadvertently pressurizing the cabin. Proper execution of the “Preflight Procedure – First Officer” during the subsequent flight will ensure the pressurization system is properly configured for flight.

Administrative Information

Insert this bulletin behind the Operations Manual Bulletin Record page in Volume 1 of your Operations Manual. Amend the Operations Manual Bulletin Record to show bulletin TBC-16 "In Effect" (IE).

This anomaly is corrected by Boeing Service Bulletin 767-21-0166 or 767-21-0168. This Operations Manual Bulletin will be canceled after Boeing is notified that all affected airplanes in the operator’s fleet have been modified.

Boeing Maintenance Tip 21-017 is related to this Operations Manual Bulletin.

Please send all correspondence regarding Operations Manual Bulletins status to one of the following addresses:

Boeing Commercial Airplanes
Commercial Aviation Services
Attn: 767 Manager, Flight Technical Data
P.O. Box 3707, M/C 20-89
Seattle, Washington, 98124-2207 USA
Telephone: (206) 662-4000
Fax: (206) 662-4743



Flight Crew Operations Manual Bulletin for The Boeing Company

The Boeing Company
Seattle, Washington 98124-2207



Number: TBC-17

IssueDate: February 14, 2007

Airplane Effectivity: All Airplanes

Subject: Center Tank Fuel Pumps

Reason: This bulletin informs flight crews of the potential for fuel pump damage that could create a potential ignition source and provides additional information and alternate operating instructions for flight crews. This bulletin provides Federal Aviation Administration (FAA)-approved alternate flight crew operations procedures granted under the provisions of FAA Letter 140S-04-03: "Alternative Method of Compliance (AMOC) to Airworthiness Directive 2001-15-08," dated March 1, 2004.

Information in this bulletin is recommended by The Boeing Company, but may not be FAA approved at the time of writing. In the event of conflict with the FAA approved Airplane Flight Manual (AFM), the AFM shall supersede. The Boeing Company regards the information or procedures described herein as having a direct or indirect bearing on the safe operation of this model airplane.

THE FOLLOWING PROCEDURE AND/OR INFORMATION IS EFFECTIVE UPON RECEIPT

Background Information

Airworthiness Directive (AD) 2001-15-08

An operator removed a center tank fuel pump and found a damaged inlet diffuser assembly. Diffuser assembly damage may cause metal-to-metal contact, creating a potential ignition source. Ignition of fuel vapors may occur if the damaged pump is not fully immersed in fuel. Approximately 500 kilograms (1000 pounds) of fuel is required to ensure the center tank pumps remain completely immersed in fuel.

Pump damage may be accompanied by tripping of the fuel pump circuit breakers.

Center tank pump inlet diffuser damage has been the subject of FAA Airworthiness Directives. The AD's required inspection and replacement of affected fuel pumps, and incorporation of pump improvements per Boeing Service Bulletin SB 767-28-0046. The damaged pump in a reported event had the equivalent of this Service Bulletin incorporated.

Selecting the center tank fuel pumps off before the center tank fuel quantity falls below 500 kilograms (1000 pounds) or at the first indication of low pump pressure, whichever occurs first, ensures that fuel vapors will not come in contact with a potentially damaged fuel pump. The first indication of fuel pump low pressure is the brief, intermittent illumination of the pump PRESS light before the tank quantity indicates zero. EICAS delays the CTR L or R FUEL PUMP messages until the PRESS lights illuminate continuously.

The FUEL CONFIG Light illuminates and the FUEL CONFIG advisory message appears when the center tank fuel pump switches are OFF with greater than 500 kilograms (1200 pounds) in the center tank. Flight crews may experience the FUEL CONFIG light and EICAS message appearing after the center tank fuel pump switches are selected OFF.

A scavenge system (as installed), operating with fuel pressure from the main (wing) tank pumps, will operate automatically to transfer any remaining fuel in the center tank to the main tanks. Fuel transfer begins when the main tanks are approximately half empty.

If the center tank fuel pumps are on during takeoff, a minimum of 2,300 kilograms (5000 pounds) must be in the center tank when the entry doors are closed with the airplane readied for initial taxi. This quantity should reduce the need for flight crews to select center tank pump switches off below 10,000 feet.

If one center tank fuel pump fails with ample fuel in the center tank, the failed pump should be selected OFF. The crossfeed valve(s) should be opened to prevent a fuel unbalance. The remaining center tank pump can remain ON until the center tank fuel quantity approaches 500 kilograms (1000 pounds).

There are no changes to the Fuel Jettison (as installed) or the Low Fuel Non-normal Procedures.

The following Boeing All Operators telegraphic messages were issued on this subject:

- M-7240-97-1126, dated July 22, 1997
- M-7240-97-1259, dated August 14, 1997
- M-7240-97-1486, dated September 18, 1997.

Alternative Method of Compliance (AMOC) to AD 2001-15-08

Boeing submitted request for AMOC to the Seattle Aircraft Certification Office (SACO) and Aircraft Evaluation Group (AEG) of the FAA Northwest Region Branch. The FAA has approved all provisions of the Boeing requested AMOC, per FAA Letter 140S-04-3, "Alternative Method of Compliance to Airworthiness Directive 2001-15-08," dated March 1, 2004. The Operating Instructions section of this Operations Manual Bulletin delineates the alternate flight crew operating procedures to those contained in AD 2001-15-08.

IMPORTANT: Operator adoption of the alternate flight crew operations procedures granted under the AMOC is contingent upon operator notification of the AMOC requirements and operational approval from the Principal Operations Inspector (POI). Since most airplanes affected by this Operations Manual Bulletin are not operated under United States registry, the FAA-approved AMOC has no authority. Final approval for all airplanes operated under foreign government registry must be granted by the appropriate government regulatory authority.

Operating Instructions

Airworthiness Directive (AD) 2001-15-08

If the center tank fuel pumps are on during takeoff, a minimum of 2,300 kilograms (5000 pounds) must be in the center tank when the entry doors are closed with the airplane readied for initial taxi.

As the center tank approaches empty during normal use, select both center tank fuel pump switches OFF with the first occurrence of any of the following:

- at or before center tank fuel quantity reaches 500 kilograms (1000 pounds), or
- either center tank fuel pump PRESS lights illuminate, or
- either the CTR L or R FUEL PUMP EICAS advisory messages are displayed.

If the Fuel Jettison Non-normal Procedure is being used to empty the center tank, complete the jettison procedure and select the center tank fuel pump switches to OFF when the CTR L or R FUEL PUMP EICAS messages are observed or as soon as either of the center tank fuel pump PRESS lights illuminate.

If a center tank fuel pump fails with ample fuel in the center tank, accomplish the FUEL PUMP Non-normal Procedure.

Alternative Method of Compliance (AMOC) to AD 2001-15-08

The intent of the following alternate operating procedures is to provide identical 767 center tank fuel pump operating procedures to those recently mandated by FAA AD on the 757 airplane. The following are 767 alternate flight crew operating procedures approved by FAA AMOC:

1. Center tank fuel operation. The center tank fuel pump switches must be selected ON if center tank fuel quantity is 5,000 pounds (2,300 kilograms) or greater with the airplane readied for initial taxi.

Both center tank fuel pump switches must be OFF for takeoff and initial climb if center tank fuel is less than 5,000 pounds (2,300 kilograms) with the airplane readied for initial taxi. Both center tank fuel pumps should be selected ON above 10,000 feet MSL or after the pitch attitude has been reduced to begin acceleration to climb speed, if more than 1,000 pounds (500 kilograms) of fuel remains in the center tank.

Both center tank fuel pump switches must be selected OFF when center tank fuel quantity reaches approximately 1,000 pounds (500 kilograms). For airplanes not equipped with a center tank scavenge system, this 1,000 pounds (500 kilograms) of fuel may only be used in a low fuel situation.

Note: In cruise flight, center tank fuel may be reduced to approximately 800 pounds (400 kilograms) as necessary to extinguish the amber FUEL CONFIG light and “FUEL CONFIG” alert message on EICAS. This will allow the fuel configuration alert to activate for a fuel imbalance condition.

2. Non-normal checklist considerations. The amber FUEL CONFIG light will illuminate and the “FUEL CONFIG” alert message will display on EICAS with approximately 1,200 pounds (600 kilograms) of fuel quantity in the center tank and the center tank fuel pump switches are selected OFF. Do not accomplish the FUEL CONFIGURATION non-normal checklist prior to or during takeoff with less than 5,000 pounds (2,300 kilograms) of fuel in the center tank, unless an imbalance is noticed between the main tanks.

If the amber FUEL CONFIG light illuminates and the “LOW FUEL” alert message displays on EICAS, accomplish the LOW FUEL non-normal checklist, as published. All center tank fuel may be used regardless of the amount of fuel remaining in the center tank.

If a center fuel tank pump amber PRESS light illuminates and the “CTR L,R FUEL PUMP” alert message displays on EICAS with fuel in the center tank, accomplish the FUEL PUMP non-normal checklist, as published. A fuel pump failure should be assumed in this situation.

If fuel jettison operation is required, accomplish the FUEL JETTISON non-normal checklist, as published. All center tank fuel is available for jettison operations, as allowed under AD 2001-15-08.

3. Increase in certified Maximum Zero Fuel Weight (MZFW). Provided the affects of airplane center-of-gravity (CG) are verified to be within allowable limits, the zero fuel weight of the airplane plus the weight of fuel in the center tank may exceed the certified MZFW up to a value of 5,000 pounds (2,300 kilograms). This MZFW increase is to allow for center tank fuel, which cannot be used during takeoff and initial climb. The magnitude of the increase in zero fuel weight is not to exceed the weight of loaded fuel in the center tank and is only permitted when operating under the Airplane Flight Manual (AFM) revisions mandated by AD 2001-15-08.

Administrative Information

Insert this bulletin behind the Operations Manual Bulletin Record page in Volume 1 of your Operations Manual. Amend the Operations Manual Bulletin Record to show bulletin TBC-17 "In Effect" (IE).

This condition is corrected by Boeing Service Bulletin 767-28-0062. This bulletin will be cancelled after Boeing is notified that all affected airplanes in your fleet have been modified.

Please send all correspondence regarding Operations Manual Bulletins status to one of the following addresses:

Boeing Commercial Airplanes
Commercial Aviation Services
Attn: 767 Manager, Flight Technical Data
P.O. Box 3707, M/C 20-89
Seattle, Washington, 98124-2207 USA
Telephone: (206) 662-4000
Fax: (206) 662-4743

Intentionally
Blank



Flight Crew Operations Manual Bulletin for The Boeing Company

The Boeing Company
Seattle, Washington 98124-2207



Number: TBC-18

IssueDate: February 14, 2007

Airplane Effectivity: All Airplanes

Subject: Consecutive Conditional Altitude Waypoints Map Anomaly

Reason: To inform flight crews of an HSI Map display anomaly associated with routes containing two consecutive conditional altitude waypoints.

Information in this bulletin is recommended by The Boeing Company, but may not be FAA approved at the time of writing. In the event of conflict with the FAA approved Airplane Flight Manual (AFM), the AFM shall supersede. The Boeing Company regards the information or procedures described herein as having a direct or indirect bearing on the safe operation of this model airplane.

THE FOLLOWING PROCEDURE AND/OR INFORMATION IS EFFECTIVE UPON RECEIPT



Background Information

During flight test, a Boeing flight crew experienced an HSI Map display anomaly. Simulator and lab tests show that when two consecutive conditional altitude waypoints exist in a procedure, the Map display of the magenta line does not reflect the intended path on the active leg for the conditional altitude waypoint. The displayed magenta line may erroneously indicate a turn prior to the airplane satisfying the required altitude for the turn. Conditional altitude waypoints are depicted as a small circle along with the altitude on the HSI Map display and their location depends on the airplane satisfying the altitude associated with the leg.

Consecutive conditional altitude waypoints may appear in Standard Instrument Departures (SID) and Missed Approach procedures and are automatically entered into the route when a procedure is selected from the FMC DEPARTURES or ARRIVALS page. Procedures which use this combination of two consecutive altitude waypoints usually require a climb to a specified altitude followed by a small turn to intercept a VOR radial while climbing to a higher altitude. Approximately 400 procedures worldwide are affected by this anomaly.

Honeywell and Boeing are investigating this anomaly.

The typical HSI Map display and corresponding RTE LEGS page display for conditional altitude waypoints are shown below:

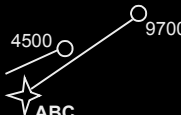
| Description | ND Map Display | CDU LEGS Page Display |
|--|---|--|
| Constant Heading to an Altitude |  | 070° HDG (4500) |
| Constant Course to an Altitude |  | 070° TRK (4500) |
| Outbound Radial to an Altitude |  | 070° (9700) |
| Consecutive Course to an Altitude Followed by Outbound Radial to an Altitude |  | 070° TRK (4500) 063° (9700) |

Operating Instructions

When flying a SID or missed approach procedure containing consecutive conditional altitude waypoints, the active route shown on the HSI Map is incorrect; however, LNAV guidance is reliable and may be flown using either the flight director or autopilot. Monitor LNAV progress and insure all altitudes and turn points are consistent with the procedure and available raw data.

Three different vendors (Jeppesen, Swissair and Racal) supply navigation data bases for the FMC. Currently affected procedures for each vendor’s navigation data base are contained in the original bulletin and are not reissued with this bulletin. To determine which vendor supplies your data base, check the Navigation Data Line on the FMC IDENT page. The navigation data base identifier begins with a three letter code. Use the Navigation Data Base vs. Vendor Reference Table (A) to determine the vendor associated with the three letter navigation data base identifier. Then locate the vendor tables (B1, B2 and B3) to determine the affected procedures.

Administrative Information

Insert this bulletin behind the Operations Manual Bulletin Record page in Volume 1 of your Operations Manual. Amend the Operations Manual Bulletin Record to show bulletin TBC-18 "In Effect" (IE).

This anomaly is corrected by Boeing Service Bulletin 767-34-0291 or 767-34-0301 or 767-34-0302 or 767-34-0303 or 767-34-0304. Refer to individual Service Bulletin for applicability.

Please send all correspondence regarding Operations Manual Bulletins status to one of the following addresses:

Boeing Commercial Airplanes
Commercial Aviation Services
Attn: 767 Manager, Flight Technical Data
P.O. Box 3707, M/C 20-89
Seattle, Washington, 98124-2207 USA
Telephone: (206) 662-4000
Fax: (206) 662-4743

Operations Manual Bulletin Attachment
Consecutive Conditional Altitude Waypoints Map Anomaly

| Table A | | | | | | | |
|--|---------------|----------------|---------------|----------------|---------------|----------------|----------------|
| Navigation Data Base vs. Vendor Reference Table | | | | | | | |
| Nav. ID | Vendor | Nav. ID | Vendor | Nav. ID | Vendor | Nav. ID | Vendor* |
| AA7 | J | BA1 | J | CI4 | J | ET2 | J |
| AC1 | J | BB2 | S | CI5 | J | ET3 | J |
| AC3 | J | BE0 | J | CJ1 | J | ET4 | J |
| AC4 | J | BE3 | J | CM2 | J | ET6 | J |
| AE1 | S | BE4 | J | CM3 | J | EZ1 | S |
| AE2 | S | BE6 | J | CO1 | J | EZ2 | S |
| AE3 | S | BE7 | J | CP1 | J | FA1 | J |
| AF4 | S | BE8 | J | CP4 | J | FA2 | J |
| AH3 | J | BE9 | J | CP9 | J | FI1 | J |
| AH6 | J | BI1 | J | CV1 | S | FS1 | J |
| AI4 | J | BI6 | J | CX4 | J | FX1 | J |
| AJ1 | J | BI7 | J | CZ5 | J | GA5 | S |
| AM1 | J | BK1 | J | CZ6 | J | GB1 | J |
| AM6 | J | BK1 | J | DL1 | J | GB2 | J |
| AN6 | A | BO1 | J | DL2 | J | GD1 | J |
| AR1 | J | BO4 | J | DL3 | J | GF1 | J |
| AR5 | J | BR1 | J | DL3 | J | GF2 | J |
| AT1 | J | BR2 | J | DL4 | J | GF5 | J |
| AT2 | J | BY1 | R | DL5 | J | GG1 | J |
| AT4 | J | BY2 | R | DP1 | J | GS1 | J |
| AV1 | J | BY3 | R | DP5 | J | HE4 | J |
| AW1 | J | BY4 | R | DP8 | J | HP5 | J |
| AW2 | J | BY6 | R | EE1 | J | HV2 | S |
| AY1 | J | CA2 | J | EK2 | S | HV5 | S |
| AY8 | J | CA4 | J | ER1 | J | HV6 | S |
| AZ8 | S | CB2 | J | ET1 | J | HY6 | S |
| AZ8 | S | CB2 | J | ET1 | J | HY6 | S |

*J = Jeppesen (Table B1) S = Swissair (Table B2) R = Racal (Table B3)

Operations Manual Bulletin Attachment
Consecutive Conditional Altitude Waypoints Map Anomaly

| Table A | | | | | | | |
|--|---------------|----------------|---------------|----------------|---------------|----------------|----------------|
| Navigation Data Base vs. Vendor Reference Table | | | | | | | |
| Nav. ID | Vendor | Nav. ID | Vendor | Nav. ID | Vendor | Nav. ID | Vendor* |
| IB1 | S | LA2 | J | MS5 | J | PT4 | R |
| IB3 | S | LA6 | J | MS6 | J | PT5 | R |
| IL5 | J | LH4 | S | MT1 | J | PT6 | R |
| IL6 | J | LH5 | S | MU1 | J | QF1 | J |
| JD7 | J | LO1 | J | MX1 | J | QF4 | J |
| JD9 | J | LO6 | J | MX4 | J | QN2 | J |
| JG4 | J | LU1 | S | NG6 | J | QN3 | J |
| JK1 | S | LU3 | S | NH1 | J | QQ2 | J |
| JK3 | S | LU4 | S | NH2 | J | RA1 | J |
| JL1 | J | LU5 | S | NH4 | J | RG1 | J |
| JL2 | J | LU6 | S | NH6 | J | RG2 | J |
| JL4 | J | LU7 | S | NS1 | J | RS6 | J |
| JL6 | J | LY2 | J | NS2 | J | SA4 | J |
| KE2 | J | LY3 | J | NS3 | J | SA6 | J |
| KE4 | J | LY7 | J | NU1 | J | SE1 | J |
| KF1 | J | MA6 | J | NW1 | J | SI1 | J |
| KF2 | J | MD0 | J | NW4 | J | SK4 | S |
| KF3 | J | MD1 | J | OZ1 | J | SK5 | S |
| KF4 | J | MD2 | J | OZ2 | J | SK6 | S |
| KL4 | S | MD3 | J | OZ4 | J | SN7 | S |
| KL5 | S | MH1 | S | PA1 | S | SQ4 | J |
| KL7 | S | MH4 | J | PL1 | J | SR4 | S |
| KT1 | J | MJ1 | J | PL2 | J | SR5 | S |
| KT2 | J | MK1 | J | PR4 | J | ST1 | J |
| KT6 | J | MP2 | S | PT1 | J | SU6 | J |
| KU6 | S | MP5 | S | PT2 | J | SV5 | J |
| LA1 | J | MS1 | J | PT3 | J | TA1 | J |

*J = Jeppesen (Table B1) S = Swissair (Table B2) R = Racal (Table B3)

Operations Manual Bulletin Attachment
Consecutive Conditional Altitude Waypoints Map Anomaly

| Table A | | | | | | | |
|---|---------------|----------------|---------------|----------------|---------------|----------------|----------------|
| Navigation Data Base vs. Vendor Reference Table | | | | | | | |
| Nav. ID | Vendor | Nav. ID | Vendor | Nav. ID | Vendor | Nav. ID | Vendor* |
| TA5 | J | UK3 | R | WE1 | J | | |
| TE4 | J | UK6 | S | WO2 | J | | |
| TE6 | J | UN1 | S | XG1 | J | | |
| TE7 | J | UN2 | S | XO2 | S | | |
| TG5 | S | UN5 | S | XO5 | J | | |
| TK2 | J | UP1 | J | XY1 | S | | |
| TQ2 | S | UP3 | J | YK1 | J | | |
| TQ3 | S | UP5 | J | YN1 | J | | |
| TR1 | J | UP6 | J | YX1 | J | | |
| TR2 | J | US5 | J | ZB1 | R | | |
| TR3 | J | US6 | J | ZB2 | R | | |
| TS1 | J | UX1 | J | ZB3 | R | | |
| TS2 | J | UX2 | J | ZB4 | R | | |
| TW1 | J | UX3 | J | ZO1 | J | | |
| TW2 | J | VE1 | J | | | | |
| TW3 | J | VE2 | S | | | | |
| TW4 | J | VO1 | S | | | | |
| TZ1 | J | VO3 | S | | | | |
| TZ2 | J | VP1 | S | | | | |
| TZ3 | J | VR1 | J | | | | |
| TZ4 | J | VS4 | S | | | | |
| UA1 | J | VZ1 | J | | | | |
| UA2 | J | VZ2 | J | | | | |
| UA4 | J | VZ4 | J | | | | |
| UC1 | J | VZ5 | J | | | | |
| UD1 | J | VZ6 | J | | | | |
| *J = Jeppesen (Table B1) S = Swissair (Table B2) R = Racal (Table B3) | | | | | | | |

Operations Manual Bulletin Attachment
Consecutive Conditional Altitude Waypoints Map Anomaly

| Table B1 | | | |
|---|--------------------------------|------------------|---------------|
| Jeppesen Navigation Data Base - Standard Instrument Departures | | | |
| ICAO ID | Airport | Departure | Runway |
| EDFH | Hahn, Germany | RUWE1E | RW03 |
| EHAM | Amsterdam,Schipol, Netherlands | EO01L | RW01L |
| EHAM | Amsterdam,Schipol, Netherlands | EO09L | RW09L |
| EHAM | Amsterdam,Schipol, Netherlands | EO27L | RW27L |
| ENBO | Bodo, Norway | GLOM2B | RW26 |
| ENBO | Bodo, Norway | STOB1B | RW26 |
| ENDU | Bardufoss, Norway | BDF2 | RW11 |
| ENDU | Bardufoss, Norway | LAVN2A | RW11 |
| ENDU | Bardufoss, Norway | TULD2A | RW11 |
| ENZV | Stavanger/Sola, Norway | BANK1D | RW29 |
| ENZV | Stavanger/Sola, Norway | DOG11D | RW11 |
| ENZV | Stavanger/Sola, Norway | DOLF1D | RW29 |
| ENZV | Stavanger/Sola, Norway | FUND1D | RW29 |
| ENZV | Stavanger/Sola, Norway | GRAM1D | RW11 |
| ENZV | Stavanger/Sola, Norway | LUCK1D | RW29 |
| ENZV | Stavanger/Sola, Norway | MADY1D | RW11 |
| ENZV | Stavanger/Sola, Norway | OKLA1D | RW11 |
| ENZV | Stavanger/Sola, Norway | SIRD1D | RW11 |
| ENZV | Stavanger/Sola, Norway | STON1D | RW29 |
| ESNN | Sundsvall-Harnosand, Sweden | LUE1C | RW34 |
| ESNN | Sundsvall-Harnosand, Sweden | STEW2C | RW34 |
| FACT | Cape Town, South Africa | OKTE2B | RW19 |
| FACT | Cape Town, South Africa | PARI2B | RW19 |
| GCFV | Fuerteventura, Canary Is | KORA1R | RW19 |
| GCFV | Fuerteventura, Canary Is | LPC2R | RW19 |
| GCFV | Fuerteventura, Canary Is | LT1R | RW19 |
| GCFV | Fuerteventura, Canary Is | SAMA1R | RW19 |
| GCFV | Fuerteventura, Canary Is | TFN1R | RW19 |

Operations Manual Bulletin Attachment
Consecutive Conditional Altitude Waypoints Map Anomaly

| Table B1 | | | |
|---|--------------------------|------------------|---------------|
| Jeppesen Navigation Data Base - Standard Instrument Departures | | | |
| ICAO ID | Airport | Departure | Runway |
| GCFV | Fuerteventura, Canary Is | TFS2R | RW19 |
| GCFV | Fuerteventura, Canary Is | VAST1R | RW19 |
| KBZN | Boseman/Gallatin, MT | BZN365 | RW30 |
| KBZN | Boseman/Gallatin, MT | BZN86S | RW30 |
| KBZN | Boseman/Gallatin, MT | BZN86W | RW30 |
| KCGZ | Casa-Grande, AZ | UCZKJ1 | RW05 |
| KHLN | Helena, MT | HLN2 | RW05 |
| KHLN | Helena, MT | HLN2 | RW09 |
| KINW | Winslow, AZ | HLN1 | RW29 |
| KLAX | Los Angeles, CA | BEVAN1 | ALL |
| KMSO | Missoula, MT | MSOEAS | RW29 |
| KPHX | Phoenix/Sky Harbor, AZ | MISSY2 | RW26B |
| KSJC | San Jose, CA | SUNOL5 | RW12 |
| KSTS | Santa Rosa/Sonoma Co, CA | STS5 | RW01 |
| KSTS | Santa Rosa/Sonoma Co, CA | STS5 | RW14 |
| KSTS | Santa Rosa/Sonoma Co, CA | STS5 | RW19 |
| KSTS | Santa Rosa/Sonoma Co, CA | STS5 | RW32 |
| LEAS | Asturias, Spain | ARPO1B | RW11 |
| LEAS | Asturias, Spain | LURI1B | RW11 |
| LEAS | Asturias, Spain | MUSI1B | RW11 |
| LEAS | Asturias, Spain | RATP1B | RW11 |
| LEIB | Ibza, Spain | MHN1E | RW24 |
| LEIB | Ibza, Spain | MJV1E | RW24 |
| LEPA | Palma de Mallorca, Spain | MEBU1A | RW24 |
| LEPA | Palma de Mallorca, Spain | MHN1A | RW24 |
| LEPA | Palma de Mallorca, Spain | MJV1B | RW06 |
| LEPA | Palma de Mallorca, Spain | OSGA1A | RW24 |
| LFMI | Istres/Le Tube, France | LUC6D | RW15 |

Operations Manual Bulletin Attachment
Consecutive Conditional Altitude Waypoints Map Anomaly

| Table B1 | | | |
|---|---------------------------------|------------------|---------------|
| Jeppesen Navigation Data Base - Standard Instrument Departures | | | |
| ICAO ID | Airport | Departure | Runway |
| LGAT | Athens, Greece | FALC1F | RW15 |
| LGAT | Athens, Greece | KOR1F | RW15 |
| LGAT | Athens, Greece | KRS1F | RW15 |
| LGAT | Athens, Greece | TNG1F | RW15 |
| LGAT | Athens, Greece | VIL11F | RW15 |
| LGKL | Kalamata, Greece | KLM1V | RW17 |
| LGKL | Kalamata, Greece | KLM1Y | RW17 |
| LGKP | Karpathos, Greece | KRC1A | RW30 |
| LGKP | Karpathos, Greece | KRC1B | RW12 |
| LGKV | Kavala/Megas Alexandros, Greece | ALX3A | RW05 |
| LGKV | Kavala/Megas Alexandros, Greece | ALX3B | RW23 |
| LGKV | Kavala/Megas Alexandros, Greece | LMO3A | RW05 |
| LGKV | Kavala/Megas Alexandros, Greece | LMO3B | RW23 |
| LGKV | Kavala/Megas Alexandros, Greece | PERE3A | RW05 |
| LGKV | Kavala/Megas Alexandros, Greece | RODO1A | RW05 |
| LGKV | Kavala/Megas Alexandros, Greece | RODO1B | RW23 |
| LGMK | Mikonos, Greece | RIPL1A | RW34 |
| LGMK | Mikonos, Greece | RIPL1B | RW16 |
| LGMT | Mitilini, Greece | LSV1A | RW33 |
| LGRX | Araxos, Greece | ALAK1M | RW36 |
| LGRX | Araxos, Greece | ARGU1M | RW36 |
| LGRX | Araxos, Greece | IXON1M | RW36 |
| LGRX | Araxos, Greece | KESA1M | RW36 |
| LGRX | Araxos, Greece | KOR1M | RW36 |
| LGRX | Araxos, Greece | KRK1M | RW36 |
| LGRX | Araxos, Greece | TRL1M | RW36 |
| LGSR | Santorini, Greece | AST11E | RW16 |
| LGSR | Santorini, Greece | ATLA1B | RW34 |

Operations Manual Bulletin Attachment
Consecutive Conditional Altitude Waypoints Map Anomaly

| Table B1 | | | |
|---|--------------------------------|------------------|---------------|
| Jeppesen Navigation Data Base - Standard Instrument Departures | | | |
| ICAO ID | Airport | Departure | Runway |
| LGSR | Santorini, Greece | ATLA1C | RW16 |
| LGSR | Santorini, Greece | MIL1E | RW34 |
| LGSR | Santorini, Greece | MIL1F | RW34 |
| LGSR | Santorini, Greece | MIL1G | RW16 |
| LGSR | Santorini, Greece | MIL1H | RW16 |
| LGTG | Tanagra, Greece | AGH1C | RW28 |
| LGTG | Tanagra, Greece | AGH1D | RW10 |
| LGTG | Tanagra, Greece | ATH1C | RW28 |
| LGTG | Tanagra, Greece | ATH1D | RW10 |
| LGTG | Tanagra, Greece | IXON1C | RW28 |
| LGTG | Tanagra, Greece | IXON1D | RW10 |
| LGTG | Tanagra, Greece | OLID1C | RW28 |
| LGTG | Tanagra, Greece | OLID1D | RW10 |
| LGTG | Tanagra, Greece | SKL1F | RW28 |
| LGTG | Tanagra, Greece | SKL1G | RW10 |
| LGTS | Thessaloniki/Makedonia, Greece | ARNA1E | RW28 |
| LGTS | Thessaloniki/Makedonia, Greece | FSK1E | RW28 |
| LGTS | Thessaloniki/Makedonia, Greece | LAMB1E | RW28 |
| LGTS | Thessaloniki/Makedonia, Greece | LOPO1E | RW28 |
| LGTS | Thessaloniki/Makedonia, Greece | SKL1E | RW28 |
| LGTS | Thessaloniki/Makedonia, Greece | TSL1F | RW28 |
| LIBC | Crotone, Italy | CDC5A | RW35 |
| LIBC | Crotone, Italy | CDC5B | RW17 |
| LIMP | Parma, Italy | PAR5V | RW02 |
| LIPZ | Venezia/Tessera, Italy | CHI5H | RW22 |
| LIPZ | Venezia/Tessera, Italy | RON5H | RW22 |
| LIPZ | Venezia/Tessera, Italy | ROTA5H | RW22 |
| LIRQ | Florence, Italy | PIS5A | RW23 |

Operations Manual Bulletin Attachment
Consecutive Conditional Altitude Waypoints Map Anomaly

| Table B1 | | | |
|---|--------------------------------------|------------------|---------------|
| Jeppesen Navigation Data Base - Standard Instrument Departures | | | |
| ICAO ID | Airport | Departure | Runway |
| LSGC | Les Eplatures, Switzerland | FRI1B | RW24 |
| LSGC | Les Eplatures, Switzerland | HOC1A | RW24 |
| LSGC | Les Eplatures, Switzerland | HOC1B | RW24 |
| LSGC | Les Eplatures, Switzerland | SPR1B | RW24 |
| LSZG | Grenchen, Switzerland | SHU2T | RW25 |
| LSZG | Grenchen, Switzerland | WIL2T | RW25 |
| MGGT | Guatemala/La Aurora, Guatemala | SJOB | RW01 |
| MGGT | Guatemala/La Aurora, Guatemala | PALEN | RW01 |
| MKJP | Kingston/Norman Manley, Jamaica | MLY1 | RW12 |
| MUCU | Santiago de Cuba/Antonio Maceo, Cuba | CAOBA2 | RW09 |
| NFNA | Nausori, Fiji | ALFA | RW10 |
| NFNA | Nausori, Fiji | BRAVO | RW10 |
| NFNA | Nausori, Fiji | BRAVO | RW28 |
| NFNA | Nausori, Fiji | CHARLI | RW10 |
| NSFA | Apia/Faleolo, Samoa | ALFA | RW26 |
| NTAA | Tahiti, Tahiti | EMIR1A | RW04 |
| NTAA | Tahiti, Tahiti | KAIN1A | RW04 |
| NTAA | Tahiti, Tahiti | METU1A | RW04 |
| OIAW | Ahwaz, Iran | GABK1B | RW30 |
| OIAW | Ahwaz, Iran | GABK1H | RW12 |
| OIAW | Ahwaz, Iran | MIS1B | RW30 |
| OIAW | Ahwaz, Iran | MIS1H | RW12 |
| OIBB | Bushehr, Iran | KUGV1A | RW31 |
| OIBB | Bushehr, Iran | KUGV1B | RW13 |
| OIBB | Bushehr, Iran | KUGV1C | RW31 |
| OICC | Kermanshah, iran | RULI1D | RW11 |
| OIGG | Rasht, Iran | RALG1A | RW27 |
| OIGG | Rasht, Iran | RALG1B | RW09 |

Operations Manual Bulletin Attachment
Consecutive Conditional Altitude Waypoints Map Anomaly

| Table B1 | | | |
|---|---------------------|------------------|---------------|
| Jeppesen Navigation Data Base - Standard Instrument Departures | | | |
| ICAO ID | Airport | Departure | Runway |
| OIGG | Rasht, Iran | RART1A | RW27 |
| OIGG | Rasht, Iran | RART1B | RW09 |
| OIKB | Bandar Abbass, Iran | TAVN2A | RW03 |
| OIKK | Kerman, Iran | ALGU2B | RW34 |
| OIKK | Kerman, Iran | ALGU2D | RW34 |
| OIKK | Kerman, Iran | ALGU2E | RW34 |
| OIKK | Kerman, Iran | ALGU3A | RW34 |
| OIKK | Kerman, Iran | ALGU3C | RW16 |
| OIKK | Kerman, Iran | ALKE2C | RW34 |
| OIKK | Kerman, Iran | ALKE3A | RW34 |
| OIKK | Kerman, Iran | ALKE3B | RW16 |
| OIKK | Kerman, Iran | ALKU2D | RW34 |
| OIKK | Kerman, Iran | ALKU2E | RW16 |
| OIKK | Kerman, Iran | ALKU3A | RW34 |
| OIKK | Kerman, Iran | ALKU3B | RW16 |
| OIKK | Kerman, Iran | ALKU3C | RW16 |
| OIKK | Kerman, Iran | ALME2D | RW34 |
| OIKK | Kerman, Iran | ALME3A | RW34 |
| OIKK | Kerman, Iran | ALME3C | RW16 |
| OIKK | Kerman, Iran | ALMI2A | RW34 |
| OIKK | Kerman, Iran | ALMI2B | RW16 |
| OIKK | Kerman, Iran | ALMI2C | RW16 |
| OIKK | Kerman, Iran | ALMI2D | RW34 |
| OIKK | Kerman, Iran | ALMO1A | RW34 |
| OIKK | Kerman, Iran | ALMO2B | RW34 |
| OIKK | Kerman, Iran | ALMO2C | RW16 |
| OIKK | Kerman, Iran | ALMO2D | RW34 |
| OIKK | Kerman, Iran | ALMO2E | RW34 |

Operations Manual Bulletin Attachment
Consecutive Conditional Altitude Waypoints Map Anomaly

| Table B1 | | | |
|---|---------------------|------------------|---------------|
| Jeppesen Navigation Data Base - Standard Instrument Departures | | | |
| ICAO ID | Airport | Departure | Runway |
| OIMM | Mashhad, Iran | METK2A | RW13 |
| OIMM | Mashhad, Iran | METK2B | RW31 |
| OIMM | Mashhad, Iran | METK2C | RW31 |
| OIMM | Mashhad, Iran | MIDM1A | RW13 |
| OIMM | Mashhad, Iran | MIDM1B | RW31 |
| OIMM | Mashhad, Iran | NOTS2A | RW13 |
| OIMM | Mashhad, Iran | NOTS2B | RW13 |
| OIMM | Mashhad, Iran | NOTS2C | RW31 |
| OIMM | Mashhad, Iran | RAMI2A | RW13 |
| OIMM | Mashhad, Iran | RAMI2B | RW31 |
| OISS | Shiraz, Iran | KISE1B | RW11 |
| OITR | Uromiyeh, Iran | BONA1B | RW21 |
| OITR | Uromiyeh, Iran | ZAJ1B | RW21 |
| OITT | Tabriz, Iran | RUDA1B | RW12 |
| OITT | Tabriz, Iran | RUDA1D | RW12 |
| OIZH | Zaheadan, Iran | DANO2B | RW17 |
| OLBA | Beirut, Lebanon | KAD1C | RW18 |
| OLBA | Beirut, Lebanon | KAD1C | RW21 |
| RJCH | Hakodate, Japan | HWE2R | RW12 |
| RJCN | Nakashibetsu, Japan | NSE2R | RW26 |
| RJFE | Fukue, Japan | FUER1 | RW21 |
| RJFE | Fukue, Japan | JB2 | RW03 |
| RJFE | Fukue, Japan | OLE2 | RW03 |
| RJFY | Kanoya, Japan | EASTRE | RW08 |
| RJFY | Kanoya, Japan | WESTRE | RW26 |
| RJKA | Amami, Japan | AME1R | RW03 |
| RJKA | Amami, Japan | AME1R | RW21 |
| RJOB | Okayama, Japan | OKC2 | RW07 |

Operations Manual Bulletin Attachment
Consecutive Conditional Altitude Waypoints Map Anomaly

| Table B1 | | | |
|---|-------------------------------------|------------------|---------------|
| Jeppesen Navigation Data Base - Standard Instrument Departures | | | |
| ICAO ID | Airport | Departure | Runway |
| RJOB | Okayama, Japan | OYE2R | RW07 |
| RJOB | Okayama, Japan | WASYU1 | RW07 |
| RJOC | Izumo, Japan | OIE2 | RW07 |
| RJOC | Izumo, Japan | TRE4 | RW07 |
| RJOC | Izumo, Japan | XZE1R | RW07 |
| RJOC | Izumo, Japan | XZE3E | RW07 |
| RJOW | Iwami, Japan | IME1R | RW29 |
| RJSA | Aomori, Japan | MRE1R | RW06 |
| RJSA | Aomori, Japan | MRE1R | RW24 |
| RJSF | Fukushima, Japan | GTC1 | RW19 |
| RJSF | Fukushima, Japan | SDE1 | RW19 |
| RJSF | Fukushima, Japan | YTE1 | RW19 |
| RJSY | Shonai, Japan | YSE1R | RW27 |
| RJTH | Hachliojima, Japan | HCE1R | RW25 |
| RJTH | Hachliojima, Japan | HCE2W | RW25 |
| RJTO | Oshma, Japan | MJ1 | RW21 |
| RJTO | Oshma, Japan | SPENS2 | RW03 |
| RKJY | Yeosu, Korea | GOSB1A | RW17 |
| RKJY | Yeosu, Korea | NIKE1A | RW17 |
| ROAH | Naha, Japan | NHC2SR | RW18 |
| RPMD | Davao/Francisco Bangoy, Phillipines | SID1B | RW23 |
| RPMD | Davao/Francisco Bangoy, Phillipines | SID2 | RW23 |
| RPMD | Davao/Francisco Bangoy, Phillipines | SID3 | RW23 |
| RPMD | Davao/Francisco Bangoy, Phillipines | SID4 | RW23 |
| RPMZ | Zamboanga, Phillipines | SID1 | RW09 |
| RPMZ | Zamboanga, Phillipines | SID1 | RW27 |
| RPMZ | Zamboanga, Phillipines | SID2 | RW09 |
| RPMZ | Zamboanga, Phillipines | SID2 | RW27 |

Operations Manual Bulletin Attachment
Consecutive Conditional Altitude Waypoints Map Anomaly

| Table B1 | | | |
|---|---|------------------|---------------|
| Jeppesen Navigation Data Base - Standard Instrument Departures | | | |
| ICAO ID | Airport | Departure | Runway |
| RPMZ | Zamboanga, Phillipines | SID7 | RW09 |
| RPMZ | Zamboanga, Phillipines | SID7 | RW27 |
| RPVM | Lapu-Lapu/Mactan, Phillipines | SID15 | RW04 |
| RPVM | Lapu-Lapu/Mactan, Phillipines | SID15A | RW04 |
| RPVM | Lapu-Lapu/Mactan, Phillipines | SID16 | RW04 |
| SCFA | Antofagasta, Chile | ANCLA2 | RW18 |
| SCFA | Antofagasta, Chile | ANCLA3 | RW19 |
| SCFA | Antofagasta, Chile | COLOSB | RW18 |
| SCFA | Antofagasta, Chile | COLOSC | RW19 |
| SCFA | Antofagasta, Chile | MOREK1 | RW18 |
| SCFA | Antofagasta, Chile | MOREK2 | RW19 |
| SCIE | Concepcion/Carriel, Chile | CORNLA | RW20 |
| SCSE | La Serena/La Florida, Chile | LILEN1 | RW29 |
| SVCS | Charallave/Oscar Machado Zuoloaga, Venezuela | 3NOL10 | RW10 |
| ZYTL | Dalian, China | D15T | RW28 |

**Operations Manual Bulletin Attachment
Consecutive Conditional Altitude Waypoints Map Anomaly**

| Table B1 Jeppesen Navigation Data Base - Approaches/Missed Approaches | | |
|--|----------------------------------|-----------------|
| ICAO ID | Airport | Approach |
| CYDN | Dauphin, Manitoba, Canada | VOR14 |
| CYXE | Saskatoon, Sask., Canada | VOR33 |
| CYYB | North Bay, Ontario, Canada | VOR18 |
| ENAT | Alta, Norway | ILS12 |
| ENBO | Bodo, Norway | ILS08 |
| ENKB | Kristiansund/Kvernberget, Norway | VOR25 |
| FADN | Durban/Louis Botha, South Africa | VOR23 |
| FYWH | Windhoek/Lughawe, Namibia | VOR26 |
| GCCR | Arrecife/Lanzarote, Canary Is. | ILS04 |
| KAHN | Athens/Ben Epps, GA | VOR02 |
| KALW | Walla Walla, WA | VOR02 |
| KBKE | Baker, OR | VOR12 |
| KBLH | Blythe, CA | VOR26 |
| KBOI | Boise, ID | VOR10R |
| KBOI | Boise, ID | ILS10R |
| KBPI | Big Piney/Marbleton, WY | VOR31 |
| KCEC | Crescent City, CA | VOR11 |
| KCEC | Crescent City, CA | ILS11 |
| KCEC | Crescent City, CA | VOR11 |
| KCMA | Camarillo, CA | VOR26 |
| KCOE | Coeur D'alene, ID | VOR01 |
| KCOE | Coeur D'alene, ID | ILS05 |
| KDLF | Del Rio, TX | VOR13C |
| KDLF | Del Rio, TX | VOR31C |
| KDRO | Durango/La Plata Co., CO | VOR02 |
| KDRO | Durango/La Plata Co., CO | ILS02 |
| KEEO | Meeker, CO | RNV03 |
| KFLG | Flagstaff, Puliam, AZ | VOR21 |

Operations Manual Bulletin Attachment
Consecutive Conditional Altitude Waypoints Map Anomaly

| Table B1 | | |
|---|----------------------------|-----------------|
| Jeppesen Navigation Data Base - Approaches/Missed Approaches | | |
| ICAO ID | Airport | Approach |
| KGFK | Grand Forks, ND | VOR17R |
| KGFK | Grand Forks, ND | VOR35L |
| KHVR | Havre City-Co, MT | VOR07 |
| KHYS | Hays, KS | VOR16 |
| KHYS | Hays, KS | VOR34 |
| KHYS | Hays, KS | VOR16 |
| KHYS | Hays, KS | VOR34 |
| KIGM | Kingman, AZ | VOR21 |
| KJAC | Jackson Hole, WY | ILS18 |
| KLMT | Klamath Falls, OR | VOR32 |
| KLMT | Klamath Falls, OR | ILS32 |
| KNGP | Corpus Christi, TX | VOR13R |
| KNQX | Key West, FL | VOR07 |
| KONA | Winona Muni/Max Conrad, MN | VOR29 |
| KOTH | North Bend Muni, OR | VOR04 |
| KPMD | Palmdale, CA | VOR25 |
| KPMD | Palmdale, CA | ILS25 |
| KPNE | North Philadelphia, PA | VOR24 |
| KPUC | Price/Carbon Co, UT | VOR36 |
| KRWL | Rawlins Muni, WY | VOR22 |
| KSBM | Sheboygan Co, WI | VOR03 |
| KSBY | Salisbury/Wicomico Co., MD | ILS32 |
| KSBY | Salisbury/Wicomico Co., MD | VOR14 |
| KSBY | Salisbury/Wicomico Co., MD | VOR32 |
| KSVC | Silver City/Grant Co, NM | LOC26 |
| KSVN | Savannah/Hunter, GA | VOR28 |
| KTMA | Tifton, GA | VOR27 |
| KTMA | Tifton, GA | VOR33 |

Operations Manual Bulletin Attachment
Consecutive Conditional Altitude Waypoints Map Anomaly

| Table B1 | | |
|---|---|-----------------|
| Jeppesen Navigation Data Base - Approaches/Missed Approaches | | |
| ICAO ID | Airport | Approach |
| KTRM | Palm Springs Thermal, CA | VOR30 |
| KTVF | Thief River Falls, MN | VOR31 |
| KTWF | Twin Falls/Sun Valley, ID | VOR07 |
| LEBL | Barcelona, Spain | VOR02 |
| LEBL | Barcelona, Spain | ILS07 |
| LGKO | Marathon/Kotroni, Greece | VOR15 |
| LGKO | Marathon/Kotroni, Greece | VOR33 |
| LIPE | Bologna/Borgo Panigale, Italy | VOR12 |
| LIPE | Bologna/Borgo Panigale, Italy | ILS12 |
| LTAQ | Samsun, Turkey | VOR21 |
| MDBH | Barahona, Dominican Republic | VOR12 |
| MDBH | Barahona, Dominican Republic | VOR30 |
| MDPP | Puerto Plata, Dominican Republic | VOR26 |
| MDSO | Santo Domingo/De Las Americas, Dominican Republic | VOR17 |
| MDSO | Santo Domingo/De Las Americas, Dominican Republic | VOR35 |
| MHTG | Tegucigalpa/Toncontin, Honduras | VOR01 |
| MPDA | David/Enrique Malek, Panama | VOR04 |
| MPTO | Panama/Tocumen, Panama | VOR03L |
| MUCU | Santiago de Cuba/Antonio Maceo, Cuba | ILS09 |
| MUCU | Santiago de Cuba/Antonio Maceo, Cuba | LOC09 |
| NCRG | Avarua/Rarotonga, Cook Is. | ILS08 |
| NCRG | Avarua/Rarotonga, Cook Is. | ILS26 |
| NSFA | Faleolo, Samoa | ILS08 |
| NZNR | Napier, New Zealand | VOR16 |
| OEBH | Bisha, Saudi Arabia | ILS18 |
| OEDR | Dhahran, Saudi Arabia | VOR34L |
| OEDR | Dhahran, Saudi Arabia | ILS34L |

Operations Manual Bulletin Attachment
Consecutive Conditional Altitude Waypoints Map Anomaly

| Table B1 | | |
|---|---------------------------------|-----------------|
| Jeppesen Navigation Data Base - Approaches/Missed Approaches | | |
| ICAO ID | Airport | Approach |
| OIBJ | Jam Tohid, Iran | VOR11 |
| OIBJ | Jam Tohid, Iran | ILS11 |
| OIFM | Esfahan, Iran | VOR26L |
| OIFM | Esfahan, Iran | VOR26R |
| PABI | Delta Junction, AK | VOR18 |
| PAMC | McGrath, AK | VOR16 |
| PAYA | Yakutat, AK | VOR11 |
| PAYA | Yakutat, AK | VOR29 |
| PHTO | Hilo, Hawaii | ILS26 |
| RJBD | Nanki-Shirahama, Japan | VOR15 |
| RJBD | Nanki-Shirahama, Japan | LOC15 |
| RJCB | Obhiro, Japan | ILS35 |
| RJCH | Hakodate, Japan | VOR12 |
| RJCH | Hakodate, Japan | ILS12 |
| RJCH | Hakodate, Japan | LOC12 |
| RJCM | Memambetsu, Japan | ILS18 |
| RJDC | Yamaguchi-Ubi/Honshu Is., Japan | VOR07 |
| RJDT | Tsushima, Japan | LOC32 |
| RJDT | Tsushima, Japan | VOR32 |
| RJFK | Kagoshima, Japan | VOR34 |
| RJFK | Kagoshima, Japan | ILS34 |
| RJKB | Okierabu, Japan | VOR22 |
| RJKN | Tokunoshima Is., Japan | VOR01 |
| RJNT | Toyama, Japan | LOC20 |
| RJOB | Okayama, Japan | ILS07 |
| RJOM | Matsuyama, Japan | ILS14 |
| RJOR | Tottori, Japan | ILS10 |
| RJOS | Tokushima, Japan | VOR29 |

Operations Manual Bulletin Attachment
Consecutive Conditional Altitude Waypoints Map Anomaly

| Table B1 | | |
|---|---|-----------------|
| Jeppesen Navigation Data Base - Approaches/Missed Approaches | | |
| ICAO ID | Airport | Approach |
| RJSF | Fukushima, Japan | ILS01 |
| RJSF | Fukushima, Japan | VOR01 |
| RJSF | Fukushima, Japan | VOR19 |
| RJSN | Nigata, Japan | VOR10 |
| RJSN | Nigata, Japan | VOR28 |
| RJSN | Nigata, Japan | ILS28 |
| RJSY | Shonai, Japan | VOR27 |
| RJSY | Shonai, Japan | VOR09 |
| RKPK | Kimhae, Korea | VOR36 |
| ROMY | Miyako, Japan | ILS22 |
| ROMY | Miyako, Japan | VOR04 |
| ROMY | Miyako, Japan | VOR22 |
| RORY | Yoron, Japan | VOR14 |
| RORY | Yoron, Japan | VOR32 |
| RPLL | Manila, Phillipines | VOR06 |
| RPLL | Manila, Phillipines | ILS06 |
| RPMD | Davao/Francisco Bangoy, Phillipines | VOR23 |
| RPMD | Davao/Francisco Bangoy, Phillipines | VOR05 |
| RPVA | Tacloban/Daniel Z. Romualdez, Phillipines | VOR36 |
| RPVB | Bacolod Negros Occidental, Phillipines | VOR04 |
| SBFL | Florianopolis/Hercilioluz, Brazil | VOR32 |
| SBUP | Castilho/Urubupunga, Brazil | VOR29 |
| SLVR | Viru Viru, Bolivia | ILS33 |
| SPIM | Lima-Callao, Peru | VOR33 |
| TGPY | Point Salines, GranaVORa | VOR10 |
| VAGO | Goa, India | VOR08 |
| VOMM | Madras, India | VOR12 |
| VOMM | Madras, India | VOR30 |

Operations Manual Bulletin Attachment
Consecutive Conditional Altitude Waypoints Map Anomaly

| Table B1 | | |
|---|--------------------------------------|-----------------|
| Jeppesen Navigation Data Base - Approaches/Missed Approaches | | |
| ICAO ID | Airport | Approach |
| VTBU | Rayong/Utapao, Thailand | VOR18 |
| VTSB | Surat Thani, Thailand | VOR22 |
| VTUW | Nakon Phanom, Thailand | VOR15 |
| WAAU | Kendari/Wolter Monginsidi, Indonesia | VOR26 |
| WAMM | Manado/Sam Ratulangi, India | ILS36 |
| WAPP | Ambon/Patimura, Indonesia | ILS04 |
| WRLI | Balikpapan/Sepinggan, Indonesia | ILS25 |
| YMAY | Albury, Australia | VOR07 |
| ZGNN | Nanning/Wuxu, China | VOR23 |

Operations Manual Bulletin Attachment
Consecutive Conditional Altitude Waypoints Map Anomaly

| Table B2 | | | |
|---|------------------------------|--------------------------|-----------------------|
| Swissair Navigation Data Base - Standard Instrument Departures | | | |
| Origin Airport | Airport Name | FMC-CDU Departure | FMC-CDU Runway |
| EDFH | Hahn, Germany | RUWE1E | RW03 |
| GCFV | Fuerteventura, Canary Is | KORA1R | RW19 |
| GCFV | Fuerteventura, Canary Is | LPC1R | RW19 |
| GCFV | Fuerteventura, Canary Is | LPC2R | RW19 |
| GCFV | Fuerteventura, Canary Is | LT1R | RW19 |
| GCFV | Fuerteventura, Canary Is | SAMA1R | RW19 |
| GCFV | Fuerteventura, Canary Is | TFN1R | RW19 |
| GCFV | Fuerteventura, Canary Is | TFS2R | RW19 |
| GCFV | Fuerteventura, Canary Is | VAST1R | RW19 |
| HKJK | Nairobi/Jomo Kenyatta, Kenya | LADANC | RW06 |
| KHLN | Helena, MT | HLN2 | RW05 |
| KHLN | Helena, MT | HLN2 | RW09 |
| KSJC | San Jose, CA | ALTAM6 | RW12 |
| KSJC | San Jose, CA | SUNOL5 | RW12 |
| LEAS | Asturias, Spain | ARPO1A | RW29 |
| LEAS | Asturias, Spain | ARPO1B | RW11 |
| LEAS | Asturias, Spain | LURI1A | RW29 |
| LEAS | Asturias, Spain | LURI1B | RW11 |
| LEAS | Asturias, Spain | MUSI1A | RW29 |
| LEAS | Asturias, Spain | MUSI1B | RW11 |
| LEAS | Asturias, Spain | RATP1A | RW29 |
| LEAS | Asturias, Spain | RATP1B | RW11 |
| LEIB | Ibza, Spain | EO24 | RW24 |
| LEIB | Ibza, Spain | MHN1E | RW24 |
| LEIB | Ibza, Spain | MJV1E | RW24 |
| LEPA | Palma de Mallorca, Spain | MEBU1A | RW24 |
| LEPA | Palma de Mallorca, Spain | MHN1A | RW24 |

Operations Manual Bulletin Attachment
Consecutive Conditional Altitude Waypoints Map Anomaly

| Table B2 | | | |
|---|--------------------------------|--------------------------|-----------------------|
| Swissair Navigation Data Base - Standard Instrument Departures | | | |
| Origin Airport | Airport Name | FMC-CDU Departure | FMC-CDU Runway |
| LEPA | Palma de Mallorca, Spain | MJV1B | RW06 |
| LEPA | Palma de Mallorca, Spain | OSGA1A | RW24 |
| LGAT | Athens, Greece | KEA1D | RW33 |
| LGAT | Athens, Greece | KRS1D | RW33 |
| LGAT | Athens, Greece | TNG1D | RW33 |
| LGAT | Athens, Greece | VIL1F | RW15 |
| LGSK | Skiathos, Greece | AGH1A | RW20 |
| LGSK | Skiathos, Greece | AGH1B | RW02 |
| LGSK | Skiathos, Greece | KORS1A | RW20 |
| LGSK | Skiathos, Greece | KORS1B | RW02 |
| LGSK | Skiathos, Greece | TNG1A | RW20 |
| LGSK | Skiathos, Greece | TNG1B | RW02 |
| LGSK | Skiathos, Greece | TSL1A | RW20 |
| LGSK | Skiathos, Greece | TSL1B | RW02 |
| LGTG | Tanagra, Greece | AGH1C | RW28 |
| LGTG | Tanagra, Greece | AGH1D | RW10 |
| LGTG | Tanagra, Greece | ATH1C | RW28 |
| LGTG | Tanagra, Greece | ATH1D | RW10 |
| LGTG | Tanagra, Greece | IXON1C | RW28 |
| LGTG | Tanagra, Greece | IXON1D | RW10 |
| LGTG | Tanagra, Greece | OLID1C | RW28 |
| LGTG | Tanagra, Greece | OLID1D | RW10 |
| LGTG | Tanagra, Greece | SKL1F | RW28 |
| LGTG | Tanagra, Greece | SKL1G | RW10 |
| LGTS | Thessaloniki/Makedonia, Greece | EO28 | RW28 |
| LGTS | Thessaloniki/Makedonia, Greece | EO34 | RW34 |
| LGTS | Thessaloniki/Makedonia, Greece | TSL1F | RW28 |
| LIBC | Crotone, Italy | CDC5A | RW35 |

Operations Manual Bulletin Attachment
Consecutive Conditional Altitude Waypoints Map Anomaly

| Table B2 | | | |
|---|---|--------------------------|-----------------------|
| Swissair Navigation Data Base - Standard Instrument Departures | | | |
| Origin Airport | Airport Name | FMC-CDU Departure | FMC-CDU Runway |
| | | | |
| LIBC | Crotone, Italy | CDC5B | RW17 |
| LIPZ | Venezia/Tessera, Italy | CHI5H | RW22 |
| LIPZ | Venezia/Tessera, Italy | RON5H | RW22 |
| LIPZ | Venezia/Tessera, Italy | ROTA5H | RW22 |
| LIRQ | Florence, Italy | PIS5A | RW23 |
| LLBG | Tel Aviv/D. Ben Gurion, Israel | IRM2E | RW26 |
| LLBG | Tel Aviv/D. Ben Gurion, Israel | IRM2F | RW30 |
| LLBG | Tel Aviv/D. Ben Gurion, Israel | NAT3E | RW26 |
| LLBG | Tel Aviv/D. Ben Gurion, Israel | SALA2E | RW26 |
| LLBG | Tel Aviv/D. Ben Gurion, Israel | SALA2F | RW30 |
| LLBG | Tel Aviv/D. Ben Gurion, Israel | SOL3E | RW26 |
| LLBG | Tel Aviv/D. Ben Gurion, Israel | TALM2E | RW26 |
| MGGT | Guatemala/La Aurora, Guatemala | SJOB | RW01 |
| MKJP | Kingston/Norman Manley, Jamaica | ENEKA3 | RW30 |
| MKJP | Kingston/Norman Manley, Jamaica | LETUM3 | RW30 |
| MKJP | Kingston/Norman Manley, Jamaica | NORAN3 | RW30 |
| MKJP | Kingston/Norman Manley, Jamaica | OSTER3 | RW30 |
| MKJP | Kingston/Norman Manley, Jamaica | OZARK3 | RW30 |
| MKJP | Kingston/Norman Manley, Jamaica | TIGON1 | RW30 |
| MUCU | Santiago de Cuba/Antonio Maceo, Cuba | CAOBA2 | RW09 |
| MUCU | Santiago de Cuba/Antonio Maceo, Cuba | SANTO3 | RW09 |

Operations Manual Bulletin Attachment
Consecutive Conditional Altitude Waypoints Map Anomaly

| Table B2 | | | |
|---|--------------------------------------|--------------------------|-----------------------|
| Swissair Navigation Data Base - Standard Instrument Departures | | | |
| Origin Airport | Airport Name | FMC-CDU Departure | FMC-CDU Runway |
| MUCU | Santiago de Cuba/Antonio Maceo, Cuba | SANTO3 | RW27 |
| NSFA | Apia/Faleolo, Samoa | ALFA | RW08 |
| NSFA | Apia/Faleolo, Samoa | BRAVO | RW08 |
| NSFA | Apia/Faleolo, Samoa | SALA | RW08 |
| NSFA | Apia/Faleolo, Samoa | TELE | RW08 |
| NSFA | Apia/Faleolo, Samoa | VASA | RW08 |
| OIBB | Bushehr, Iran | KUGV1A | RW31 |
| OIBB | Bushehr, Iran | KUGV1B | RW13 |
| OIBB | Bushehr, Iran | KUGV1C | RW31 |
| OIBB | Bushehr, Iran | KUGV1D | RW13 |
| OICC | Kermanshah, iran | RULI1D | RW11 |
| OIFM | Esfahan, Iran | LABT1A | RW26 |
| OIFM | Esfahan, Iran | LADA1A | RW26 |
| OIFM | Esfahan, Iran | LADA2C | RW26 |
| OIFM | Esfahan, Iran | LADA2D | RW08 |
| OIFM | Esfahan, Iran | LADL1A | RW26 |
| OIFM | Esfahan, Iran | LADL2C | RW26 |
| OIFM | Esfahan, Iran | LADL2D | RW08 |
| OIFM | Esfahan, Iran | LARB1A | RW26 |
| OIGG | Rasht, Iran | RALG1A | RW27 |
| OIGG | Rasht, Iran | RALG1B | RW09 |
| OIGG | Rasht, Iran | RART1A | RW27 |
| OIGG | Rasht, Iran | RART1B | RW09 |
| OIKB | Bandar Abbass, Iran | MOBO1B | RW21 |
| OIKB | Bandar Abbass, Iran | MOBO2C | RW03 |
| OIKB | Bandar Abbass, Iran | TAVN2A | RW03 |
| OIKB | Bandar Abbass, Iran | TAVN2E | RW03 |

Operations Manual Bulletin Attachment
Consecutive Conditional Altitude Waypoints Map Anomaly

| Table B2 | | | |
|---|---------------------|--------------------------|-----------------------|
| Swissair Navigation Data Base - Standard Instrument Departures | | | |
| Origin Airport | Airport Name | FMC-CDU Departure | FMC-CDU Runway |
| OIKK | Kerman, Iran | ALGU2B | RW34 |
| OIKK | Kerman, Iran | ALGU2D | RW34 |
| OIKK | Kerman, Iran | ALGU2E | RW34 |
| OIKK | Kerman, Iran | ALGU2F | RW16 |
| OIKK | Kerman, Iran | ALGU3A | RW34 |
| OIKK | Kerman, Iran | ALGU3C | RW16 |
| OIKK | Kerman, Iran | ALKE2C | RW34 |
| OIKK | Kerman, Iran | ALKE2D | RW16 |
| OIKK | Kerman, Iran | ALKE3A | RW34 |
| OIKK | Kerman, Iran | ALKE3B | RW16 |
| OIKK | Kerman, Iran | ALKU2D | RW34 |
| OIKK | Kerman, Iran | ALKU2E | RW16 |
| OIKK | Kerman, Iran | ALKU2F | RW16 |
| OIKK | Kerman, Iran | ALKU3A | RW34 |
| OIKK | Kerman, Iran | ALKU3B | RW16 |
| OIKK | Kerman, Iran | ALKU3C | RW16 |
| OIKK | Kerman, Iran | ALME2D | RW34 |
| OIKK | Kerman, Iran | ALME2F | RW16 |
| OIKK | Kerman, Iran | ALME3A | RW34 |
| OIKK | Kerman, Iran | ALME3C | RW16 |
| OIKK | Kerman, Iran | ALMI2A | RW34 |
| OIKK | Kerman, Iran | ALMI2B | RW16 |
| OIKK | Kerman, Iran | ALMI2C | RW16 |
| OIKK | Kerman, Iran | ALMI2D | RW34 |
| OIKK | Kerman, Iran | ALMI2E | RW16 |
| OIKK | Kerman, Iran | ALMI2F | RW16 |
| OIKK | Kerman, Iran | ALMO1A | RW34 |
| OIKK | Kerman, Iran | ALMO2B | RW34 |

Operations Manual Bulletin Attachment
Consecutive Conditional Altitude Waypoints Map Anomaly

| Table B2 | | | |
|---|---------------------|--------------------------|-----------------------|
| Swissair Navigation Data Base - Standard Instrument Departures | | | |
| Origin Airport | Airport Name | FMC-CDU Departure | FMC-CDU Runway |
| OIKK | Kerman, Iran | ALMO2C | RW16 |
| OIKK | Kerman, Iran | ALMO2D | RW34 |
| OIKK | Kerman, Iran | ALMO2E | RW34 |
| OIKK | Kerman, Iran | ALMO2F | RW16 |
| OIMM | Mashhad, Iran | METK2A | RW13 |
| OIMM | Mashhad, Iran | METK2B | RW31 |
| OIMM | Mashhad, Iran | METK2C | RW31 |
| OIMM | Mashhad, Iran | MIDM1A | RW13 |
| OIMM | Mashhad, Iran | MIDM1B | RW31 |
| OIMM | Mashhad, Iran | NOTS2A | RW13 |
| OIMM | Mashhad, Iran | NOTS2B | RW13 |
| OIMM | Mashhad, Iran | NOTS2C | RW31 |
| OIMM | Mashhad, Iran | RAMI2A | RW13 |
| OIMM | Mashhad, Iran | RAMI2B | RW31 |
| OITR | Uromiyeh, Iran | ZAJ1B | RW21 |
| OITT | Tabriz, Iran | RUDA1B | RW12 |
| OITT | Tabriz, Iran | RUDA1D | RW12 |
| OIZH | Zaheadan, Iran | DANO2B | RW17 |
| OIYY | Yazd, Iran | BOMI1D | RW13 |
| OIYY | Yazd, Iran | BONE1D | RW13 |
| OIYY | Yazd, Iran | BONI1D | RW13 |
| OIYY | Yazd, Iran | BONO1D | RW13 |
| OIZH | Zahedan, Iran | DANO2B | RW17 |
| OLBA | Beirut, Lebanon | KAD1C | RW18 |
| OLBA | Beirut, Lebanon | KAD1C | RW21 |
| OLBA | Beirut, Lebanon | KAD1D | RW03 |
| OLBA | Beirut, Lebanon | KAD1D | RW36 |
| ROAH | Naha, Japan | NHC2SR | RW18 |

**Operations Manual Bulletin Attachment
Consecutive Conditional Altitude Waypoints Map Anomaly**

| Table B2 | | | |
|---|--|--------------------------|-----------------------|
| Swissair Navigation Data Base - Standard Instrument Departures | | | |
| Origin Airport | Airport Name | FMC-CDU Departure | FMC-CDU Runway |
| RPVB | Bacolod Negros Occidental, Philippines | SID 2 | RW22 |
| RPVM | Lapu-Lapu/Mactan, Phillipines | SID15 | RW04 |
| RPVM | Lapu-Lapu/Mactan, Phillipines | SID15A | RW04 |
| RPVM | Lapu-Lapu/Mactan, Phillipines | SID16 | RW04 |
| SCIE | Concepcion/Carriel, Chile | CO4TCO | RW20 |
| SCIE | Concepcion/Carriel, Chile | CO4VLD | RW20 |

Operations Manual Bulletin Attachment
Consecutive Conditional Altitude Waypoints Map Anomaly

| Table B2 | | |
|---|--|-----------------|
| Swissair Navigation Data Base - Approaches/Missed Approaches | | |
| Destination Airport | Airport Name | Approach |
| EGPB | Sumburgh, UK | ILS27 |
| ENBR | Fergen/Flesland, Norway | ILS35 |
| FCBB | Brazzaville/Maya-Maya, Congo | ILS06 |
| FMCH | Moroni/Hahaia, Comores | ILS02 |
| GCRR | Arrecife/Lanzarote, Canary Is. | ILS04 |
| HAAB | Addis Ababa/Bole, Ethiopia | ILS25 |
| HAAB | Addis Ababa/Bole, Ethiopia | VOR25 |
| HADR | Dire Dawa/Abba Tenna Dejazmatch Yilma, Ethopia | VOR15 |
| HESH | Sharm-El-Shiekh, Egypt | ILS04 |
| KMKC | Kansas City/Downtown, KS | ILS03 |
| KPMD | Palmdale, CA | ILS25 |
| LEAM | Almeria, Spain | NDB08 |
| LEBL | Barcelona, Spain | VOR02 |
| LEBL | Barcelona, Spain | ILS07 |
| LEBL | Barcelona, Spain | ILS25 |
| LFLC | Clermont-Ferrand/Aulnat, France | ILS26 |
| LGKO | Marathon/Kotroni, Greece | VOR15 |
| LGKO | Marathon/Kotroni, Greece | VOR33 |
| LIPE | Bologna/Borgo Panigale, Italy | ILS12 |
| LIRZ | Perugia, Italy | VOR01 |
| LPLA | Lajes-Terceira, Is, Portugal | ILS15 |
| LTCG | Trabzon, Turkey | ILS11 |
| MUCU | Santiago de Cuba/Antonio Maceo, Cuba | ILS09 |
| NWWW | Noumea/La Tontouta, New Caledonia | ILS11 |
| OEDR | Dhahran, Saudi Arabia | ILS34L |
| OIBJ | Jam Tohid, Iran | VOR11 |

Operations Manual Bulletin Attachment
Consecutive Conditional Altitude Waypoints Map Anomaly

| Table B2 | | |
|---|---|-----------------|
| Swissair Navigation Data Base - Approaches/Missed Approaches | | |
| Destination Airport | Airport Name | Approach |
| OIBJ | Jam Tohid, Iran | ILS11 |
| OINR | Ramsar, Iran | NDB31 |
| PAYA | Yakutat, AK | VOR02 |
| RJCH | Hakodate, Japan | ILS12 |
| RJCH | Hakodate, Japan | LOC12 |
| RJFK | Kagoshima, Japan | ILS34 |
| RJNK | Kanazawa/Komatsu, Japan | ILS06 |
| RJNN | Najoya, Japan | VOR34 |
| RJNN | Najoya, Japan | ILS34 |
| RJSA | Aomori, Japan | ILS24 |
| RJSN | Nigata, Japan | ILS28 |
| RJSS | Sendai, Japan | ILS27 |
| RKPK | Kimhae, Korea | ILS36 |
| RKPK | Kimhae, Korea | LOC36 |
| ROAH | Naha, Japan | VOR18 |
| RPLL | Manila/Ninoy Aquino, Phillipines | VOR06 |
| RPVB | Bacolod Negros Occidental, Phillipines | VOR04 |
| VOMM | Madras, India | VOR25 |
| VTUW | Nakon Phanom, Thailand | VOR15 |
| WAPP | Ambon/Patimura, Indonesia | ILS04 |

**Operations Manual Bulletin Attachment
Consecutive Conditional Altitude Waypoints Map Anomaly**

| Table B3 Racal Navigation Data Base - Standard Instrument Departures | | | |
|---|------------------------------------|--------------------------|-----------------------|
| Origin Airport | Airport Name | FMC-CDU Departure | FMC-CDU Runway |
| ESNN | Sundsvall-Harnosand, Sweden | LUE1C | RW34 |
| FACT | Cape Town, South Africa | OKTE2B | RW19 |
| FACT | Cape Town, South Africa | PARI2B | RW19 |
| GCFV | Fuerteventura, Canary Is | KORA1R | RW19 |
| GCFV | Fuerteventura, Canary Is | LPC2R | RW19 |
| GCFV | Fuerteventura, Canary Is | LT1R | RW19 |
| GCFV | Fuerteventura, Canary Is | SAMA1R | RW19 |
| GCFV | Fuerteventura, Canary Is | TFN1R | RW19 |
| GCFV | Fuerteventura, Canary Is | TFS2R | RW19 |
| GCFV | Fuerteventura, Canary Is | VAST1R | RW19 |
| LEIB | Ibza, Spain | MHN1E | RW24 |
| LEIB | Ibza, Spain | MJV1E | RW24 |
| LEPA | Palma de Mallorca, Spain | MEBU1A | RW24 |
| LEPA | Palma de Mallorca, Spain | MHN1A | RW24 |
| LEPA | Palma de Mallorca, Spain | MJV1B | RW06 |
| LEPA | Palma de Mallorca, Spain | OSGA1A | RW24 |
| LGMT | Mitilini, Greece | LSV1A | RW33 |
| LIMP | Parma, Italy | PAR5V | RW02 |
| LIMP | Parma, Italy | PAR5Y | RW20 |
| MGGT | Guatemala/La Aurora, Guatemala | PALEN | RW01 |
| MKJP | Kingston/Norman Manley, Jamaica | ENEKA3 | RW30 |
| MKJP | Kingston/Norman Manley, Jamaica | MLY1 | RW12 |
| MKJP | Kingston/Norman Manley, Jamaica | NORAN3 | RW30 |
| MKJP | Kingston/Norman Manley, Jamaica | TIGON1 | RW30 |

**Operations Manual Bulletin Attachment
Consecutive Conditional Altitude Waypoints Map Anomaly**

| Table B3 | | | |
|--|--------------------------------------|--------------------------|-----------------------|
| Racal Navigation Data Base - Standard Instrument Departures | | | |
| Origin Airport | Airport Name | FMC-CDU Departure | FMC-CDU Runway |
| MUCU | Santiago de Cuba/Antonio Maceo, Cuba | CAOBA2 | RW09 |
| MUCU | Santiago de Cuba/Antonio Maceo, Cuba | SANTO3 | RW09 |
| MUCU | Santiago de Cuba/Antonio Maceo, Cuba | SANTO3 | RW27 |
| OLBA | Beirut, Lebanon | KAD1C | RW18 |
| OLBA | Beirut, Lebanon | KAD1C | RW21 |

Operations Manual Bulletin Attachment
Consecutive Conditional Altitude Waypoints Map Anomaly

| Table B3 | | |
|---|---|-----------------|
| Racal Navigation Data Base - Approaches/Missed Approache | | |
| Destination Airport | Airport Name | Approach |
| DTTX | Sfax/El Maou, Tunisia | VOR15 |
| DTTX | Sfax/El Maou, Tunisia | VOR33 |
| EGPE | Inverness, UK | VOR06 |
| EGPE | Inverness, UK | VOR24 |
| ENBO | Bodo, Norway | ILS08 |
| GCCR | Arrecife/Lanzarote, Canary Is. | VOR04 |
| HEAX | Alexandria, Egypt | VOR04 |
| HEAX | Alexandria, Egypt | VOR36 |
| KDRO | Durango/La Plata Co., CO | ILS02 |
| LIPE | Bologna/Borgo Panigale, Italy | VOR12 |
| LTCG | Trabzon, Turkey | VOR11 |
| MDPP | Puerto Plata, Dominican Republic | VOR26 |
| MDSO | Santo Domingo/De Las Americas, Dominican Republic | VOR35 |
| NSFA | Faleolo, Samoa | ILS08 |
| NWWW | Noumea/La Tontouta, New Caledonia | ILS11 |
| OEDR | Dhahran, Saudi Arabia | ILS34L |
| RJCH | Hakodate, Japan | ILS12 |
| RJOM | Matsuyama, Japan | ILS14 |
| RPLL | Manila, Phillipines | ILS06 |
| SLVR | Viru Viru, Bolivia | ILS33 |
| SPIM | Lima-Callao, Peru | VOR33 |
| TFFF | Forte-de-France/Le Lamentin Martinique, France | VOR27 |
| WMKL | Pulau/Langkawi, Malaysia | VOR03 |

Intentionally
Blank



Flight Crew Operations Manual Bulletin for The Boeing Company

The Boeing Company
Seattle, Washington 98124-2207



Number: TBC-19

IssueDate: February 14, 2007

Airplane Effectivity: All Airplanes

Subject: Continuous Ignition For Flaps 1 Takeoff

Reason: This bulletin provides information informing flight crews of the need to manually select continuous ignition for a flaps 1 takeoff.

Information in this bulletin is recommended by The Boeing Company, but may not be FAA approved at the time of writing. In the event of conflict with the FAA approved Airplane Flight Manual (AFM), the AFM shall supersede. The Boeing Company regards the information or procedures described herein as having a direct or indirect bearing on the safe operation of this model airplane.

THE FOLLOWING PROCEDURE AND/OR INFORMATION IS EFFECTIVE UPON RECEIPT

Background Information

Continuous ignition is not presently activated when FLAPS 1 is selected with the Engine Start Selector in the AUTO position. A wiring change to automatically activate continuous ignition for a FLAPS 1 takeoff is scheduled for production introduction on airplane line number 136 then 138 and on. This same configuration will be available for retrofit by Boeing Service Bulletin 74-0002. In the interim, manual selection of continuous ignition must be made for all takeoffs that utilize a setting of FLAPS 1.

Operations Manual Information

Effective immediately, the following pen and ink changes should be made to the normal procedure:

TAXI-OUT PROCEDURE

Add the following step immediately after the second step, "Flaps....._____":

Engine Start Selectors ----- CONT

If using FLAPS 1 setting for takeoff.

AFTER TAKEOFF PROCEDURE

Add the following statement to the PNF duties after the statement, "Position flap lever as directed.":

If FLAPS 1 used for takeoff, reposition Engine Start Selectors to AUTO.

Administrative Information

Insert this bulletin behind the Operations Manual Bulletin Record page in Volume 1 of your Operations Manual. Amend the Operations Manual Bulletin Record to show bulletin TBC-19 "In Effect" (IE).

This Operations Manual Bulletin will be canceled after Boeing is notified that all affected airplanes in the operators fleet have been modified by Boeing Service Bulletin 767-74-0002.

Please send all correspondence regarding Operations Manual Bulletins status to one of the following addresses:

Boeing Commercial Airplanes
Commercial Aviation Services
Attn: 767 Manager, Flight Technical Data
P.O. Box 3707, M/C 20-89
Seattle, Washington, 98124-2207 USA
Telephone: (206) 662-4000
Fax: (206) 662-4743



Flight Crew Operations Manual Bulletin for The Boeing Company

The Boeing Company
Seattle, Washington 98124-2207



Number: TBC-20

IssueDate: February 14, 2007

Airplane Effectivity: All Airplanes

Subject: Dual FMC Restarts And Data Link Fail CDU Messages

Reason: This bulletin provides information informing flight crews of temporary recommended procedures required to avoid dual FMC restarts.

Information in this bulletin is recommended by The Boeing Company, but may not be FAA approved at the time of writing. In the event of conflict with the FAA approved Airplane Flight Manual (AFM), the AFM shall supersede. The Boeing Company regards the information or procedures described herein as having a direct or indirect bearing on the safe operation of this model airplane.

THE FOLLOWING PROCEDURE AND/OR INFORMATION IS EFFECTIVE UPON RECEIPT

Background Information

This bulletin applies to airplanes with Product Improvement Package (PIP) software installed in the Flight Management Computer (FMC) and with no ACARS installed. ACARS equipment allows electronic, non-voice communication between the airplane and ground stations. Communications are received in the cockpit on a dedicated ACARS unit, on a printer or, in the case of data link, directly into the Flight Management Computer.

An error in the PIP software results in a restart of both FMC computers when the first waypoint in the route is reached. The dual restart does not occur on every flight, however, it is not predictable. The restart results in both CDUs displaying the menu page with no prompt for selection of the FMC function. Both HSIs will display the MAP FAIL flag during the restart. The FMCs and HSIs normally recover within 30 seconds. After recovery, the FMC prompt will be displayed on the menu page and it can be selected to return to FMC operation. The route will revert to inactive, requiring reactivation and execution. Performance data will be lost during the restart and will have to be re-entered by the crew.

The restart is caused by the PIP software accessing areas of the FMC memory dedicated to ACARS data link. Without the FMC configured for ACARS, the data in this area of memory is misused, resulting in FMC restarts.

As an interim solution to avoid restarts, the FMC will be reconfigured to expect ACARS and data link installed and operational. Because of the reconfiguration, a prompt for a DATA LINK page will be available on the INIT/REF INDEX page. The DATA LINK page will display DATA LINK FAIL in the lower, right corner and will otherwise be a non-functional page. DATA LINK FAIL does not affect the normal operation of the FMC or CDU. Also, a line for Ref OAT and a line for LIM TOGW (limit takeoff gross weight) will appear on the TAKEOFF REF 2/2 page. If a temperature value is entered in the Ref OAT line, the V-speeds on the TAKEOFF REF 1/2 page will revert to dashes. The LIM TOGW line will not display dashes so it will not accept data entered with the CDU numeric keys.

The FMC will be automatically reconfigured with the interim solution in the next navigation data base update.

Operating Instructions

Do not use the DATA LINK page. Disregard DATA LINK FAIL indications.

Do not enter a value in the Ref OAT line.

Administrative Information

Insert this bulletin behind the Operations Manual Bulletin Record page in Volume 1 of your Operations Manual. Amend the Operations Manual Bulletin Record to show bulletin TBC-20 "In Effect" (IE).

Please send all correspondence regarding Operations Manual Bulletins status to one of the following addresses:

Boeing Commercial Airplanes
Commercial Aviation Services
Attn: 767 Manager, Flight Technical Data
P.O. Box 3707, M/C 20-89
Seattle, Washington, 98124-2207 USA
Telephone: (206) 662-4000
Fax: (206) 662-4743



Flight Crew Operations Manual Bulletin for The Boeing Company

The Boeing Company
Seattle, Washington 98124-2207



Number: TBC-21

IssueDate: February 14, 2007

Airplane Effectivity: All Airplanes

Subject: Electronic Engine Control (EEC) Software Anomaly

Reason: To inform flight crews of an EEC software anomaly that may prevent display of EICAS messages IDLE DISAGREE or ENG LOW IDLE.

Information in this bulletin is recommended by The Boeing Company, but may not be FAA approved at the time of writing. In the event of conflict with the FAA approved Airplane Flight Manual (AFM), the AFM shall supersede. The Boeing Company regards the information or procedures described herein as having a direct or indirect bearing on the safe operation of this model airplane.

THE FOLLOWING PROCEDURE AND/OR INFORMATION IS EFFECTIVE UPON RECEIPT

Background Information

The EEC sets minimum or approach idle automatically. Minimum idle is selected for most ground and flight operations. Approach idle, set at a slightly higher thrust setting than minimum idle, is selected when any of the following conditions exist:

- flaps not up, or
- engine anti-ice ON, or
- engine start selector CONT (airplanes modified by SB 767-73-0043)

EICAS advisory message IDLE DISAGREE and ENG LOW IDLE alert the crew of incorrect engine idle settings.

Boeing has received operator reports of incorrect idle settings without display of the appropriate EICAS message. Engineering investigation has determined an EEC software anomaly is responsible. Updated EEC software (Version 8.2.O) corrects the anomaly and restores EICAS alert of idle control system faults.

Operating Instructions

This bulletin does not apply to airplanes modified by GE Service Bulletin 73-0250 REV 2 (EEC software Version 8.2.O).

When operating at idle thrust under conditions requiring approach idle, verify both engines are at approach idle. If one engine is not at approach idle, advance thrust lever on the affected engine until thrust matches the engine operating at approach idle.

Administrative Information

Insert this bulletin behind the Operations Manual Bulletin Record page in Volume 1 of your Operations Manual. Amend the Operations Manual Bulletin Record to show bulletin TBC-21 "In Effect" (IE).

This Operations Manual Bulletin will be canceled after Boeing is notified that all affected airplanes in the operators fleet have been modified by GE Service Bulletin 73-0250 REV 2.

Please send all correspondence regarding Operations Manual Bulletins status to one of the following addresses:

Boeing Commercial Airplanes
Commercial Aviation Services
Attn: 767 Manager, Flight Technical Data
P.O. Box 3707, M/C 20-89
Seattle, Washington, 98124-2207 USA
Telephone: (206) 662-4000
Fax: (206) 662-4743



Flight Crew Operations Manual Bulletin for The Boeing Company

The Boeing Company
Seattle, Washington 98124-2207



Number: TBC-22

IssueDate: February 14, 2007

Airplane Effectivity: All Airplanes

Subject: Flight Management Computer (FMC) Anomaly of Engine Indicating and Crew Alerting System (EICAS) Alert

Reason: To inform flight crews of a Pegasus-FMC alerting anomaly following an FMC failure and associated corrective action.

Information in this bulletin is recommended by The Boeing Company, but may not be FAA approved at the time of writing. In the event of conflict with the FAA approved Airplane Flight Manual (AFM), the AFM shall supersede. The Boeing Company regards the information or procedures described herein as having a direct or indirect bearing on the safe operation of this model airplane.

THE FOLLOWING PROCEDURE AND/OR INFORMATION IS EFFECTIVE UPON RECEIPT

Background Information

A Pegasus-FMC anomaly exists, which may not result in the display of the associated EICAS advisory-level “L FMC FAIL” or “R FMC FAIL” alerts. This anomaly occurs when an FMC experiences specific internal faults that inhibit the transmission of the FMC-failure signal to the EICAS computers. However, the secondary discrete alerting lights and indications associated with an FMC failure will correctly illuminate to provide the necessary flight crew awareness of an FMC failure condition.

The secondary discrete alerting lights and indications, which are always associated with an FMC failure, are:

1. Illumination of the amber Control and Display Unit (CDU) “FAIL” light;
2. Display of the amber Horizontal Situation Indicator (HSI) “MAP” flag with the associated FMC Instrument Source Selector positioned to the failed FMC detent; and,
3. Display of the “SINGLE FMC [L,R] OPERATION” scratch-pad message on the operable FMC CDU.

Boeing has confirmed this anomaly exists in all Pegasus-FMC software. Pegasus-FMC software is identified by either of the following OP PROGRAM part numbers located on the IDENT page:

- 3413-HNP-02C-03
- 3414-HNP-02C-04.

Operating Instructions

If the CDU “FAIL” light illuminates accompanied by the display of the “MAP” flag on the associated HSI and the CDU scratch-pad message “SINGLE FMC [L,R] OPERATION”, the associated FMC should be considered failed. Therefore, the non-normal FMC FAIL checklist should be accomplished.

Administrative Information

Insert this bulletin behind the Operations Manual Bulletin Record page in Volume 1 of your Operations Manual. Amend the Operations Manual Bulletin Record to show bulletin TBC-22 "In Effect" (IE).

This anomaly is corrected by Boeing Service Bulletin 767-34-0317.

Please send all correspondence regarding Operations Manual Bulletins status to one of the following addresses:

Boeing Commercial Airplanes
Commercial Aviation Services
Attn: 767 Manager, Flight Technical Data
P.O. Box 3707, M/C 20-89
Seattle, Washington, 98124-2207 USA
Telephone: (206) 662-4000
Fax: (206) 662-4743



Flight Crew Operations Manual Bulletin for The Boeing Company

The Boeing Company
Seattle, Washington 98124-2207



Number: TBC-23

IssueDate: February 14, 2007

Airplane Effectivity: All Airplanes

Subject: Flight Management Computer (FMC) Anomaly During Descent Phase of Flight

Reason: To inform flight crews of a Pegasus-FMC anomaly during the descent phase of flight.

Information in this bulletin is recommended by The Boeing Company, but may not be FAA approved at the time of writing. In the event of conflict with the FAA approved Airplane Flight Manual (AFM), the AFM shall supersede. The Boeing Company regards the information or procedures described herein as having a direct or indirect bearing on the safe operation of this model airplane.

THE FOLLOWING PROCEDURE AND/OR INFORMATION IS EFFECTIVE UPON RECEIPT

Background Information

A Pegasus-FMC anomaly exists which may result in different Flight Mode Annunciation (FMA) pitch mode displays between the Attitude Direction Indicators (ADI) and accompanied by inconsistent flight path deviation indications on the Horizontal Situation Indicators (HSI). This anomaly may occur if any flight plan modification is entered and executed near the top of descent point or during the descent or approach phases of flight. When the anomaly occurs, the FMA pitch mode annunciations “VNAV SPD” and “VNAV PATH” (“VNAV PTH”, as installed) simultaneously display between the captain’s and first officer’s ADIs. The HSI track deviation scale pointers may also indicate different vertical path deviations and may even result in one or both vertical path deviation scales not being displayed.

Boeing has confirmed this anomaly exists in all Pegasus-FMC software. Pegasus-FMC software is identified by either of the following OP PROGRAM part numbers located on the IDENT page:

- 3413-HNP-02C-03
- 3414-HNP-02C-04.

Operating Instructions

If continued VNAV mode use is desired, perform a “Direct-To” entry to the active waypoint. This action may result in the correct display of consistent FMA pitch modes associated with VNAV operation. If this action does not result in the correct display of consistent FMA pitch modes, and continued flight director and/or autopilot use is desired, select another appropriate Mode Control Panel (MCP) pitch mode.

Administrative Information

Insert this bulletin behind the Operations Manual Bulletin Record page in Volume 1 of your Operations Manual. Amend the Operations Manual Bulletin Record to show bulletin TBC-23 "In Effect" (IE).

This anomaly is corrected by Boeing Service Bulletin 767-34-0317.

Please send all correspondence regarding Operations Manual Bulletins status to one of the following addresses:

Boeing Commercial Airplanes
Commercial Aviation Services
Attn: 767 Manager, Flight Technical Data
P.O. Box 3707, M/C 20-89
Seattle, Washington, 98124-2207 USA
Telephone: (206) 662-4000
Fax: (206) 662-4743



Flight Crew Operations Manual Bulletin for The Boeing Company

The Boeing Company
Seattle, Washington 98124-2207



Number: TBC-24

IssueDate: February 14, 2007

Airplane Effectivity: All Airplanes

Subject: Flight Management Computer (FMC) Lockup Resulting from Internal Timer Anomaly

Reason: To inform flight crews of a Pegasus-FMC Timer anomaly and associated corrective action.

Information in this bulletin is recommended by The Boeing Company, but may not be FAA approved at the time of writing. In the event of conflict with the FAA approved Airplane Flight Manual (AFM), the AFM shall supersede. The Boeing Company regards the information or procedures described herein as having a direct or indirect bearing on the safe operation of this model airplane.

THE FOLLOWING PROCEDURE AND/OR INFORMATION IS EFFECTIVE UPON RECEIPT

Background Information

A Pegasus-FMC internal software timer anomaly has been discovered, which may result in a single or dual FMC to lockup during power transfers on the ground. This anomaly has been identified to have a timing cycle of approximately 12.5 hours. If a power transfer resulting in an FMC power interrupt occurs during the last 5-minutes of the 12.5-hour timer cycle, a single or dual FMC lockup can occur. This anomaly has not been reported to occur in service while airborne.

767 Maintenance Tip MT34-028, dated July, 15 1998, was issued by The Boeing Company to provide airline maintenance personnel, or equivalent, the necessary information to prevent the FMC software clock timer-induced lockup.

The recommended action specified in this Boeing Maintenance Tip is as follows:

“To prevent occurrence of an FMC [lockup], cycle the left FMC circuit breaker for at least 10 seconds. Wait for at least 5 minutes after returning power to the left FMC and then cycle the right FMC circuit breaker for at least 10 seconds. Perform this action daily and before any flight operation that will exceed 12.5 hours. If an FMC [lockup] occurs, the FMC can be recovered by performing the aforementioned recommended action.”

Operating Instructions

On the ground before each flight, verify maintenance personnel, or equivalent, have complied with 767 Maintenance Tip MT34-028, dated July 15, 1998:

- If maintenance personnel have complied, then no flight crew action is required.
- If maintenance personnel is not available at your location, the flight crew should perform the recommended action specified in MT34-028, dated July 15, 1998.

Administrative Information

Insert this bulletin behind the Operations Manual Bulletin Record page in Volume 1 of your Operations Manual. Amend the Operations Manual Bulletin Record to show bulletin TBC-24 "In Effect" (IE).

This anomaly will be corrected by Boeing Service Bulletin 767-34-0291 scheduled to be available April 1, 1999. This Operations Manual Bulletin will be canceled after Boeing is notified that all affected airplanes in the operators fleet have been modified.

Please send all correspondence regarding Operations Manual Bulletins status to one of the following addresses:

Boeing Commercial Airplanes
Commercial Aviation Services
Attn: 767 Manager, Flight Technical Data
P.O. Box 3707, M/C 20-89
Seattle, Washington, 98124-2207 USA
Telephone: (206) 662-4000
Fax: (206) 662-4743



Flight Crew Operations Manual Bulletin for The Boeing Company

The Boeing Company
Seattle, Washington 98124-2207



Number: TBC-25

IssueDate: February 14, 2007

Airplane Effectivity: All Airplanes

Subject: Flight Management Computer (FMC) Lockup Resulting from Flight Plan Route Uplink

Reason: This bulletin describes a Pegasus-FMC Datalink anomaly and associated corrective actions.

Information in this bulletin is recommended by The Boeing Company, but may not be FAA approved at the time of writing. In the event of conflict with the FAA approved Airplane Flight Manual (AFM), the AFM shall supersede. The Boeing Company regards the information or procedures described herein as having a direct or indirect bearing on the safe operation of this model airplane.

THE FOLLOWING PROCEDURE AND/OR INFORMATION IS EFFECTIVE UPON RECEIPT

Background Information

A Pegasus-FMC software anomaly exists, which may result in the lock up of both the left and right FMC when repeated attempts to load a route uplink are accomplished. When a route uplink is received and the scratchpad message, "ROUTE 1 UPLINK READY" or "ROUTE 2 UPLINK READY" displays, the flight crew normally loads the route by pushing line-select key 4L adjacent to the "< LOAD" prompt on the RTE 1/X page. If the "< LOAD" prompt is selected and the software anomaly is in effect, the route will not load and the "< LOAD" prompt will continue to display at line-select key 4L. Furthermore, repeated attempts to load the route uplink may result in a single or dual FMC lockup. If an FMC lockup occurs, pulling an FMC circuit breaker(s) to remove power will not return either FMC to normal operation. To resolve the lockup, maintenance personnel, or equivalent, must software load an earlier edition of the navigation database. Line selecting the out-of-date navigation data base on the IDENT page will not correct the lockup.

Note: This Pegasus-FMC software anomaly occurs randomly and does not affect all route uplinks.

Operating Instructions

On ground:

When the “ROUTE 1 UPLINK READY” or “ROUTE 2 UPLINK READY” scratchpad message displays, push line-select key 4L adjacent to the “< LOAD” prompt on the RTE 1/X page only once. Verify the “< LOAD” prompt at line-select key 4L on the RTE page disappears. If the “< LOAD” prompt at line-select key 4L remains displayed, do not re-select.

If the route is INACTIVE, select the “PURGE >” prompt at line-select key 4R. The route uplink will purge normally and the FMC will continue normal operation. Subsequent uplinks may be attempted.

If the route is ACTIVE, manually enter a new flight plan, if required. Do not attempt a subsequent load of the failed route uplink. If the aircraft is on the ground, maintenance personnel, or equivalent, may pull both FMC circuit breakers for approximately 10 seconds, then reset both FMC circuit breakers to clear the anomaly.

In flight:

Do not load a route uplink via the “< LOAD” prompt adjacent to line-select key 4L on the RTE 1/X page.

Administrative Information

Insert this bulletin behind the Operations Manual Bulletin Record page in Volume 1 of your Operations Manual. Amend the Operations Manual Bulletin Record to show bulletin TBC-25 "In Effect" (IE).

This anomaly will be corrected by Boeing Service Bulletin 767-34-0291 scheduled to be available April 1, 1999. This Operations Manual Bulletin will be canceled after Boeing is notified that all affected airplanes in the operators fleet have been modified.

Please send all correspondence regarding Operations Manual Bulletins status to one of the following addresses:

Boeing Commercial Airplanes
Commercial Aviation Services
Attn: 767 Manager, Flight Technical Data
P.O. Box 3707, M/C 20-89
Seattle, Washington, 98124-2207 USA
Telephone: (206) 662-4000
Fax: (206) 662-4743



Flight Crew Operations Manual Bulletin for The Boeing Company

The Boeing Company
Seattle, Washington 98124-2207



Number: TBC-26

IssueDate: February 14, 2007

Airplane Effectivity: All Airplanes

Subject: FMC Holding Pattern Anomaly

Reason: To inform flight crews of incorrect FMC holding pattern size when flying without LNAV engaged.

Information in this bulletin is recommended by The Boeing Company, but may not be FAA approved at the time of writing. In the event of conflict with the FAA approved Airplane Flight Manual (AFM), the AFM shall supersede. The Boeing Company regards the information or procedures described herein as having a direct or indirect bearing on the safe operation of this model airplane.

THE FOLLOWING PROCEDURE AND/OR INFORMATION IS EFFECTIVE UPON RECEIPT

Background Information

The FMC calculates holding pattern size based on the target holding airspeed, current winds and altitude when crossing the holding fix, and FAA/ICAO holding protected airspace limits. The FMC updates holding pattern size, as required, each time the airplane crosses the holding fix. However, current FMC software prevents pattern size update if LNAV was not engaged on the previous crossing of the holding fix. If a holding pattern has been modified after crossing the holding fix without LNAV engaged, the FMC will not update the holding pattern size when the fix is crossed again. The airplane must cross the holding fix twice with LNAV engaged for FMC holding pattern update to occur. This does not affect holding pattern size for initial holding pattern entry.

The anomaly can occur when descending in holding or modifying a holding pattern. In one reported event, the flight crew created a holding pattern in the FMC at an initial approach fix and entered the holding pattern using HDG SEL. Upon receiving ATC clearance, the flight crew began a descent and engaged LNAV. Before crossing the holding fix twice with LNAV engaged, the flight crew descended to an altitude where the original holding pattern size no longer met protected airspace criteria. A GPWS warning was generated from nearby terrain. This terrain alert would have been avoided had a holding pattern update occurred.

The anomaly does not exist with PEGASUS FMC, P/N S242T102-455.

Operating Instructions

When possible, enter and fly FMC holding patterns with LNAV engaged. Holding pattern size will be updated, as required, each time the airplane crosses the holding fix and the airplane will remain within FAA/ICAO hold protected airspace. Cross check lateral and vertical navigation for proper operation.

If 1) climbing or descending in, or 2) modifying, a holding pattern without LNAV engaged, fly the holding pattern in HDG SEL and use time/distance techniques. Under these conditions, use the FMC holding pattern for reference only since pattern size is not updated when the holding fix is crossed.

Administrative Information

Insert this bulletin behind the Operations Manual Bulletin Record page in Volume 1 of your Operations Manual. Amend the Operations Manual Bulletin Record to show bulletin TBC-26 "In Effect" (IE).

This anomaly is corrected by Boeing Service Bulletin 767-34-0291 or 767-34-0301 or 767-34-0302 or 767-34-0303 or 767-34-0304. Refer to individual Service Bulletin for applicability.

This Operations Manual Bulletin will be canceled after Boeing is notified that all affected airplanes in the operators fleet have been modified.

Please send all correspondence regarding Operations Manual Bulletins status to one of the following addresses:

Boeing Commercial Airplanes
Commercial Aviation Services
Attn: 767 Manager, Flight Technical Data
P.O. Box 3707, M/C 20-89
Seattle, Washington, 98124-2207 USA
Telephone: (206) 662-4000
Fax: (206) 662-4743



Flight Crew Operations Manual Bulletin for The Boeing Company

The Boeing Company
Seattle, Washington 98124-2207



Number: TBC-27

IssueDate: February 14, 2007

Airplane Effectivity: All Airplanes

Subject: FMC CDU Scratchpad Message "Enter IRS Position"

Reason: To inform flight crews the FMC CDU scratchpad message ENTER IRS POSITION may not display when an incorrect present position is entered for IRS alignment.

Information in this bulletin is recommended by The Boeing Company, but may not be FAA approved at the time of writing. In the event of conflict with the FAA approved Airplane Flight Manual (AFM), the AFM shall supersede. The Boeing Company regards the information or procedures described herein as having a direct or indirect bearing on the safe operation of this model airplane.

THE FOLLOWING PROCEDURE AND/OR INFORMATION IS EFFECTIVE UPON RECEIPT

Background Information

The FMC CDU scratchpad message ENTER IRS POSITION indicates the flight crew-entered present position did not pass an IRS comparison check, or the IRS is ready to enter the navigation mode and a present position has not been entered. Operators have reported isolated incidents of IRS alignment without display of the ENTER IRS POSITION message when an incorrect present position has been entered during preflight. As a result, airplanes have inadvertently dispatched with unreliable IRS position information. Engineering analysis indicates the anomaly is the result of a timing problem between the FMCs.

Engaging the autothrottle for takeoff (GPS not available) does not correct the error. If the error is sufficiently large, FMC radio position updating will be locked out in flight. GPS position updating (if available) will function and slowly correct the position error at a rate of 4 NM per minute.

In addition, large initial position errors can cause IRS magnetic variation errors affecting the accuracy of magnetic heading and track. Excessive magnetic track errors can cause AFDS localizer mode failure and subsequent inhibiting of automatic approaches. Complete correction of the FMC/IRS position error requires landing and full realignment in the navigation mode.

The flight crew can detect a large FMC position error by comparing relative positions of the airplane and runway symbols on the HSI. On the POS REF page, individual IRS positions should be compared to the required alignment position (gate coordinates, etc.). If an initial position error is discovered before takeoff, a fast alignment with a correct position entry may not resolve the problem. A full alignment must be accomplished by rotating the IRS Mode Selectors to OFF, then to NAV, and entering the correct present position in the SET IRS POSITION line on the POS INIT page.

Also, due to an unrelated anomaly, the use of LAST POS for IRS alignment has not always resulted in correct IRS alignment. If the last positions stored in the FMCs differ, using either for IRS alignment may result in an incorrect alignment position.

This anomaly exists only in PIP FMC and Pegasus FMC. Following are the affected software part numbers:

- Pegasus: 3413-HNP-02C-03.
- PIP: PS4052970-952, -953, -954, -955, -956

Operating Instructions

During preflight, after entering present position on SET IRS POS line, select the POS REF page and verify L, C, and R IRS position coordinates are correct.

If an incorrect initial position is discovered in flight, the situation cannot be corrected without full IRS realignment on the ground.

Administrative Information

Insert this bulletin behind the Operations Manual Bulletin Record page in Volume 1 of your Operations Manual. Amend the Operations Manual Bulletin Record to show bulletin TBC-27 "In Effect" (IE).

The PEGASUS FMC anomaly will be corrected by Boeing Service Bulletin 767-34-0291. Other FMC's are corrected by Boeing Service Bulletin 767-34-0301 or 767-34-0302 or 767-34-0303 or 767-34-0304. Refer to individual Service Bulletin for applicability.

This Operations Manual Bulletin will be canceled after Boeing is notified that all affected airplanes in the operators fleet have been modified.

Please send all correspondence regarding Operations Manual Bulletins status to one of the following addresses:

Boeing Commercial Airplanes
Commercial Aviation Services
Attn: 767 Manager, Flight Technical Data
P.O. Box 3707, M/C 20-89
Seattle, Washington, 98124-2207 USA
Telephone: (206) 662-4000
Fax: (206) 662-4743

Intentionally
Blank



Flight Crew Operations Manual Bulletin for The Boeing Company

The Boeing Company
Seattle, Washington 98124-2207



Number: TBC-28

IssueDate: February 14, 2007

Airplane Effectivity: All Airplanes

Subject: FMC VNAV Anomaly During Intermediate Level Off

Reason: To inform pilots of a VNAV anomaly which may result in a level-off altitude error.

Information in this bulletin is recommended by The Boeing Company, but may not be FAA approved at the time of writing. In the event of conflict with the FAA approved Airplane Flight Manual (AFM), the AFM shall supersede. The Boeing Company regards the information or procedures described herein as having a direct or indirect bearing on the safe operation of this model airplane.

THE FOLLOWING PROCEDURE AND/OR INFORMATION IS EFFECTIVE UPON RECEIPT

Background Information

Boeing has received operator reports of VNAV overshooting the intended altitude following climb. This occurred at intermediate altitudes when the local barometric pressure was significantly lower than standard. Each event occurred when the level-off was initiated shortly after climbing through transition altitude.

The FMC uses a filter to smooth the computed aircraft altitude to compensate for a rapid adjustment to the barometric correction setting. This altitude smoothing function compensates for a barometric correction change at the rate of 1 inch mercury (33.9 hPa) or 1000 feet in two minutes.

During climb, when a VNAV level-off is initiated shortly after passing transition altitude and the altimeter is reset from a very low pressure to QNE (29.92 or 1013), VNAV may overshoot the level-off. In descent, an undershoot condition may occur when a VNAV level-off is initiated shortly after passing the transition level and the altimeter has been reset from QNE to a very low pressure QNH setting. The amount of overshoot or undershoot depends on the amount of barometric correction, when the altimeter is reset, and the elapsed time from altimeter reset to level-off.

Operating Instructions

If leveling off within 2000 feet after changing altimeter setting from QNE to QNH, or QNH to QNE, do not use VNAV to execute the level-off if QNH is less than 29.70 hg/1006 hPa (low altimeter setting). After the level-off is complete, VNAV may be re-engaged for climb or cruise.

Administrative Information

Insert this bulletin behind the Operations Manual Bulletin Record page in Volume 1 of your Operations Manual. Amend the Operations Manual Bulletin Record to show bulletin TBC-28 "In Effect" (IE).

This anomaly is corrected by Boeing Service Bulletin 767-34A0389. This Flight Crew Operations Manual Bulletin will be canceled after Boeing is notified that all affected airplanes in the operator's fleet have been modified.

Please send all correspondence regarding Operations Manual Bulletins status to one of the following addresses:

Boeing Commercial Airplanes
Commercial Aviation Services
Attn: 767 Manager, Flight Technical Data
P.O. Box 3707, M/C 20-89
Seattle, Washington, 98124-2207 USA
Telephone: (206) 662-4000
Fax: (206) 662-4743



Flight Crew Operations Manual Bulletin for The Boeing Company

The Boeing Company
Seattle, Washington 98124-2207



Number: TBC-29

IssueDate: February 14, 2007

Airplane Effectivity: All Airplanes

Subject: FMC Failure During VOR Remote Tuning

Reason: This bulletin provides information informing flight crews that FMC failure can occur when remote tuning a VOR station with the FMC while the right autopilot is engaged.

Information in this bulletin is recommended by The Boeing Company, but may not be FAA approved at the time of writing. In the event of conflict with the FAA approved Airplane Flight Manual (AFM), the AFM shall supersede. The Boeing Company regards the information or procedures described herein as having a direct or indirect bearing on the safe operation of this model airplane.

THE FOLLOWING PROCEDURE AND/OR INFORMATION IS EFFECTIVE UPON RECEIPT

Background Information

While remote tuning a VOR with the FMC during a recent test flight, a dual FMC restart occurred with a loss of performance data and deactivation of the active route. Investigation has revealed that this anomaly is due to a conflict between the FMC tuning master, which is normally the left FMC, and the FMC guidance master, which is determined by which autopilot is engaged. Therefore, this anomaly only occurs when remote tuning a VOR while the right autopilot is engaged, but does not occur every time this situation is encountered.

The indication to the flight crew that this anomaly is about to occur is that when a VOR frequency or identifier is line selected to the VOR display line on Progress page 1/2, the data remains in the scratch pad and does not transfer to the line. If no further action is attempted, an FMC generated short term interrupt will occur, the scratch pad will clear and normal operation will be restored. However, a second attempt to remote tune will result in a long term restart and a loss of performance data and deactivation of the rote. A third attempt will result in dual FMC failure (single failure with -952 and -953 software).

Operating Instructions

Until this anomaly is corrected, do not remote tune VOR stations using the FMC when the right autopilot is engaged.

Administrative Information

Insert this bulletin behind the Operations Manual Bulletin Record page in Volume 1 of your Operations Manual. Amend the Operations Manual Bulletin Record to show bulletin TBC-29 "In Effect" (IE).

This anomaly is corrected by Boeing Service Bulletin 767-34-0242.

Please send all correspondence regarding Operations Manual Bulletins status to one of the following addresses:

Boeing Commercial Airplanes
Commercial Aviation Services
Attn: 767 Manager, Flight Technical Data
P.O. Box 3707, M/C 20-89
Seattle, Washington, 98124-2207 USA
Telephone: (206) 662-4000
Fax: (206) 662-4743



Flight Crew Operations Manual Bulletin for The Boeing Company

The Boeing Company
Seattle, Washington 98124-2207



Number: TBC-30

IssueDate: February 14, 2007

Airplane Effectivity: All Airplanes

Subject: FMC Assumed Temperature Derate Anomaly

Reason: This bulletin provides information for flight crews regarding FMC anomaly.

Information in this bulletin is recommended by The Boeing Company, but may not be FAA approved at the time of writing. In the event of conflict with the FAA approved Airplane Flight Manual (AFM), the AFM shall supersede. The Boeing Company regards the information or procedures described herein as having a direct or indirect bearing on the safe operation of this model airplane.

THE FOLLOWING PROCEDURE AND/OR INFORMATION IS EFFECTIVE UPON RECEIPT

Background Information

Re-entering the previously entered assumed temperature on the CDU TAKEOFF REF page may not be accepted by the FMC. Assumed temperature entries selected via the Thrust Mode Select Panel (TMSP) are accepted by the FMC.

This anomaly appears on airplanes with an earlier version of the PEGASUS FMC installed. The earlier version can be identified by the OP PROGRAM part number displayed on the IDENT page:

- 3413-HNP-02C-03

Operating Instructions

Enter assumed temperature using the TMSP if the FMC assumed temperature entry is not accepted.

Administrative Information

Insert this bulletin behind the Operations Manual Bulletin Record page in Volume 1 of your Operations Manual. Amend the Operations Manual Bulletin Record to show bulletin TBC-30 "In Effect" (IE).

This anomaly will be corrected by Boeing Service Bulletin 767-34-0291 scheduled to be available April 1, 1999. This Operations Manual Bulletin will be canceled after Boeing is notified that all affected airplanes in the operators fleet have been modified.

Please send all correspondence regarding Operations Manual Bulletins status to one of the following addresses:

Boeing Commercial Airplanes
Commercial Aviation Services
Attn: 767 Manager, Flight Technical Data
P.O. Box 3707, M/C 20-89
Seattle, Washington, 98124-2207 USA
Telephone: (206) 662-4000
Fax: (206) 662-4743



Flight Crew Operations Manual Bulletin for The Boeing Company

The Boeing Company
Seattle, Washington 98124-2207



Number: TBC-31

IssueDate: February 14, 2007

Airplane Effectivity: All Airplanes

Subject: Fuel System Imbalance Anomaly

Reason: To provide information regarding a fuel system imbalance anomaly.

Information in this bulletin is recommended by The Boeing Company, but may not be FAA approved at the time of writing. In the event of conflict with the FAA approved Airplane Flight Manual (AFM), the AFM shall supersede. The Boeing Company regards the information or procedures described herein as having a direct or indirect bearing on the safe operation of this model airplane.

THE FOLLOWING PROCEDURE AND/OR INFORMATION IS EFFECTIVE UPON RECEIPT

Background Information

Boeing has received several operator reports of an imbalance anomaly pertaining to the 767 Fuel System. All operator reports describe simultaneous fuel consumption from the center fuel tank and either the left or right main fuel tank, or simultaneous fuel consumption between the center fuel tank and both left and right main fuel tanks.

Boeing analysis has determined this simultaneous fuel tank consumption anomaly is a result of the center fuel tank pumps not producing adequate pressure to override the main tank fuel pumps. With exception of an empty center fuel tank, the occurrence of the anomaly cannot be accurately predicted for any given flight or any given flight condition.

Boeing is continuing investigation of this anomaly. Several modifications have been made to the center fuel tank override pumps as directed by Federal Aviation Administration (FAA) Airworthiness Directive (AD) 2001-15-08, Amendment 39-12342, effective September 4, 2001, which may be responsible for the imbalance characteristic. FAA AD 2001-15-08 supercedes FAA AD 97-19-15, which is no longer in effect. Therefore, flight crews should be advised of this simultaneous fuel consumption anomaly and provided with recommended operating instructions as temporary corrective action.

The recommended operating instructions contained in this Operations Manual Bulletin have demonstrated in service to both terminate the simultaneous fuel consumption characteristic as well as prevent re-occurrence of the characteristic for the remainder of flight.

There are two means for the flight crew to determine if fuel is simultaneously being consumed from the center fuel tank and either or both main fuel tanks. These are:

1. Flight crew observance of Fuel Quantity Indicating System (FQIS) quantity indicators simultaneously decreasing from the center fuel tank and either or both left and right main fuel tanks without receiving an EICAS fuel system alert; or,
2. Flight crew observance of FQIS quantity indicators simultaneously decreasing from the center fuel tank and either or both left and right main fuel tanks after receiving an EICAS fuel system alert.

Operating Instructions

1. If the flight crew observes FQIS quantity indicators simultaneously decreasing from the center tank and either the left or right main fuel tank without the “FUEL CONFIG” advisory-level EICAS alert displayed and FUEL CONFIG light illuminated, accomplish the FUEL BALANCING supplementary procedure.

Note: Accomplishing the FUEL BALANCING supplementary procedure allows the center tank fuel pump on the low main fuel tank side to resume override pressure. The left and right main fuel tanks will remain unbalanced at the amount at which the low main fuel tank pumps are selected OFF. When center tank fuel is depleted, the main tanks will begin balancing.

2. If the EICAS advisory-level “FUEL CONFIG” alert displays accompanied by the FUEL CONFIG light, and the flight crew observes FQIS quantity indicators simultaneously decreasing from the center tank and either the left or right main fuel tank, accomplish the FUEL CONFIGURATION non-normal checklist.

Note: Accomplishing the FUEL CONFIGURATION non-normal checklist allows the center tank fuel pump on the low main fuel tank side to resume override pressure. The left and right main fuel tanks will remain unbalanced at the amount at which the low main fuel tank pumps are selected OFF. When center tank fuel is depleted, the main tanks will begin balancing.

3. If the flight crew observes FQIS quantity indicators simultaneously decreasing from the center tank and both the left and right main fuel tanks without the “LOW FUEL” caution-level EICAS alert displayed, continue normal operation.

Note: Operator in-service reports have indicated a higher rate of fuel consumption from the center fuel tank being observed in comparison to the rate of fuel consumption from the left and right main fuel tanks. In addition, Boeing analysis has determined that the center fuel tank will empty before the main fuel tank quantities are reduced by an appreciable amount.

4. If the EICAS caution-level “LOW FUEL” alert displays accompanied by the FUEL CONFIG light, accomplish the LOW FUEL non-normal checklist.

Note: In-service reports have indicated a higher rate of fuel consumption from the center fuel tank in comparison to the rate of fuel consumption from the left and right main fuel tanks. In addition, subsequent Boeing analysis has determined that the center fuel tank will empty before the main fuel tank quantities are reduced by an appreciable amount. Therefore, the “LOW FUEL” alert should be treated with all due vigilance, and the LOW FUEL non-normal checklist accomplished.

5. If the flight crew suspects a fuel leak may exist, accomplish the ENGINE FUEL LEAK non-normal checklist.

Note: Accomplishing the ENGINE FUEL LEAK non-normal checklist is appropriate if the flight crew suspects or confirms a fuel leak exists. One or more of the following may be evidence of a fuel leak:

- a. Visual observation of fuel spray from strut or engine;
 - b. Excessive engine fuel flow;
 - c. Total fuel quantity decreasing at an abnormal rate;
 - d. “FUEL CONFIG” message on EICAS;
 - e. “LOW FUEL” message on EICAS
 - f. FUEL DISAGREE – PROG 2 or FUEL QTY ERROR – PROG 2 message on the CDU scratchpad;
 - g. INSUFFICIENT FUEL message on the CDU scratchpad.
6. If fuel jettison operation is required, accomplish the FUEL JETTISON non-normal checklist.

Note: Accomplishing the FUEL JETTISON non-normal checklist will exclusively isolate the center tank fuel for fuel jettison operation.

As a reminder, Auxiliary Power Unit (APU) operation on the ground or in flight may result in depletion of fuel from the left main fuel tank. Therefore, flight crews should be reminded that a left and right main fuel tank unbalance condition might be a result of APU operation.

Master Minimum Equipment List (MMEL) Item 28-41-1 allows airplane dispatch with an FQIS quantity indicator inoperative if the associated provisos are complied with. Boeing recommends not dispatching an airplane under MMEL Item 28-41-1, if the airplane has been modified by Service Bulletins 767-28-0052 or 767-28-0062, or production equivalents, and center tank fuel is loaded. With a main fuel tank FQIS quantity indicator inoperative, flight crew confusion can result in determining whether the fuel system anomaly described above is occurring or if a suspected engine fuel leak condition exists.

Boeing further recommends if a main fuel tank FQIS quantity indicator failure occurs after dispatch on an airplane modified by Service Bulletin 767-28-0052 or 767-28-0062 with center tank fuel loaded, the flight be terminated by taxiing back to parking or landing at the nearest suitable airport.

Administrative Information

Insert this bulletin behind the Operations Manual Bulletin Record page in Volume 1 of your Operations Manual. Amend the Operations Manual Bulletin Record to show bulletin TBC-31 "In Effect" (IE).

This condition is under investigation. This bulletin will be revised to include Service Bulletin information when available.

Please send all correspondence regarding Operations Manual Bulletins status to one of the following addresses:

Boeing Commercial Airplanes
Commercial Aviation Services
Attn: 767 Manager, Flight Technical Data
P.O. Box 3707, M/C 20-89
Seattle, Washington, 98124-2207 USA
Telephone: (206) 662-4000
Fax: (206) 662-4743



Flight Crew Operations Manual Bulletin for The Boeing Company

The Boeing Company
Seattle, Washington 98124-2207



Number: TBC-32

IssueDate: February 14, 2007

Airplane Effectivity: All Airplanes

Subject: FMC Alternate Airport Anomaly

Reason: This bulletin provides information for flight crews regarding FMC anomaly.

Information in this bulletin is recommended by The Boeing Company, but may not be FAA approved at the time of writing. In the event of conflict with the FAA approved Airplane Flight Manual (AFM), the AFM shall supersede. The Boeing Company regards the information or procedures described herein as having a direct or indirect bearing on the safe operation of this model airplane.

THE FOLLOWING PROCEDURE AND/OR INFORMATION IS EFFECTIVE UPON RECEIPT

Background Information

When the ALTN CDU page is selected, the displayed alternate airports may contain only three airports because one airport is duplicated.

This anomaly appears on airplanes with an earlier version of the PEGASUS FMC installed. The earlier version can be identified by the OP PROGRAM part number displayed on the IDENT page:

- 3413-HNP-02C-03

Operating Instructions

If necessary, select or enter the appropriate alternate airport.

Administrative Information

Insert this bulletin behind the Operations Manual Bulletin Record page in Volume 1 of your Operations Manual. Amend the Operations Manual Bulletin Record to show bulletin TBC-32 "In Effect" (IE).

This anomaly will be corrected by Boeing Service Bulletin 767-34-0291 scheduled to be available April 1, 1999. This Operations Manual Bulletin will be canceled after Boeing is notified that all affected airplanes in the operators fleet have been modified.

Please send all correspondence regarding Operations Manual Bulletins status to one of the following addresses:

Boeing Commercial Airplanes
Commercial Aviation Services
Attn: 767 Manager, Flight Technical Data
P.O. Box 3707, M/C 20-89
Seattle, Washington, 98124-2207 USA
Telephone: (206) 662-4000
Fax: (206) 662-4743



Flight Crew Operations Manual Bulletin for The Boeing Company

The Boeing Company
Seattle, Washington 98124-2207



Number: TBC-33

IssueDate: February 14, 2007

Airplane Effectivity: All Airplanes

Subject: FMC Altitude Display Anomaly

Reason: This bulletin provides information for flight crews regarding FMC anomaly.

Information in this bulletin is recommended by The Boeing Company, but may not be FAA approved at the time of writing. In the event of conflict with the FAA approved Airplane Flight Manual (AFM), the AFM shall supersede. The Boeing Company regards the information or procedures described herein as having a direct or indirect bearing on the safe operation of this model airplane.

THE FOLLOWING PROCEDURE AND/OR INFORMATION IS EFFECTIVE UPON RECEIPT

Background Information

During descent, the HSI and CDU LEGS page may display “altitudes” instead of “flight levels” when above the destination airport’s transition level or may display “flight levels” instead of “altitudes” when below the destination airport’s transition level. This anomaly should not affect crew checklist procedures which require altimeter change at the transition level for the local area.

This anomaly appears on airplanes with an earlier version of the PEGASUS FMC installed. The earlier version can be identified by the OP PROGRAM part number displayed on the IDENT page:

- 3413-HNP-02C-03

Operating Instructions

Ensure that the appropriate altimeter setting for the local area is set at transition level.

Administrative Information

Insert this bulletin behind the Operations Manual Bulletin Record page in Volume 1 of your Operations Manual. Amend the Operations Manual Bulletin Record to show bulletin TBC-33 "In Effect" (IE).

This anomaly will be corrected by Boeing Service Bulletin 767-34-0291 scheduled to be available April 1, 1999. This Operations Manual Bulletin will be canceled after Boeing is notified that all affected airplanes in the operators fleet have been modified.

Please send all correspondence regarding Operations Manual Bulletins status to one of the following addresses:

Boeing Commercial Airplanes
Commercial Aviation Services
Attn: 767 Manager, Flight Technical Data
P.O. Box 3707, M/C 20-89
Seattle, Washington, 98124-2207 USA
Telephone: (206) 662-4000
Fax: (206) 662-4743



Flight Crew Operations Manual Bulletin for The Boeing Company

The Boeing Company
Seattle, Washington 98124-2207



Number: TBC-34

IssueDate: February 14, 2007

Airplane Effectivity: All Airplanes

Subject: FMC Engine Out (E/O) Standard Instrument Departure (SID)

Reason: This bulletin provides information for flight crews regarding engine out FMC anomaly after takeoff.

Information in this bulletin is recommended by The Boeing Company, but may not be FAA approved at the time of writing. In the event of conflict with the FAA approved Airplane Flight Manual (AFM), the AFM shall supersede. The Boeing Company regards the information or procedures described herein as having a direct or indirect bearing on the safe operation of this model airplane.

THE FOLLOWING PROCEDURE AND/OR INFORMATION IS EFFECTIVE UPON RECEIPT

Background Information

On flights such as training flights where multiple takeoffs and landings occur, the Engine Out Standard Instrument Departure (E/O SID) will not automatically load with loss of an engine after takeoff. The E/O SID can still be manually selected by the crew.

This anomaly appears on airplanes with an earlier version of the PEGASUS FMC installed. The earlier version can be identified by the OP PROGRAM part number displayed on the IDENT page:

- 3413-HNP-02C-03

Operations Manual Information

Ensure the departure runway is re-selected prior to each takeoff if the engines have not been shutdown.

Administrative Information

Insert this bulletin behind the Operations Manual Bulletin Record page in Volume 1 of your Operations Manual. Amend the Operations Manual Bulletin Record to show bulletin TBC-34 "In Effect" (IE).

This anomaly will be corrected by Boeing Service Bulletin 767-34-0291 scheduled to be available April 1, 1999. This Operations Manual Bulletin will be canceled after Boeing is notified that all affected airplanes in the operators fleet have been modified.

Please send all correspondence regarding Operations Manual Bulletins status to one of the following addresses:

Boeing Commercial Airplanes
Commercial Aviation Services
Attn: 767 Manager, Flight Technical Data
P.O. Box 3707, M/C 20-89
Seattle, Washington, 98124-2207 USA
Telephone: (206) 662-4000
Fax: (206) 662-4743



Flight Crew Operations Manual Bulletin for The Boeing Company

The Boeing Company
Seattle, Washington 98124-2207



Number: TBC-35

IssueDate: February 14, 2007

Airplane Effectivity: All Airplanes

Subject: Incorrect Display of VREF On The ADI Speed Tape

Reason: This bulletin provides information for flight crews regarding FMC anomaly.

Information in this bulletin is recommended by The Boeing Company, but may not be FAA approved at the time of writing. In the event of conflict with the FAA approved Airplane Flight Manual (AFM), the AFM shall supersede. The Boeing Company regards the information or procedures described herein as having a direct or indirect bearing on the safe operation of this model airplane.

THE FOLLOWING PROCEDURE AND/OR INFORMATION IS EFFECTIVE UPON RECEIPT

Background Information

Flight test has discovered an anomaly in the Pegasus FMC which may cause the display of incorrect Vref information on one of the two ADI Speed Tapes. When a manual “speed-only” Vref change is made to a previously entered Vref on the APPROACH REF page, the new value will be displayed correctly on one Speed Tape, but the other Speed Tape will remain at the previously entered speed value. This anomaly occurs only when a speed scratchpad entry (/ XXX) is line-selected into 4R on the APPROACH REF page.

Example 1, no anomaly: During the Approach check, the Captain downselects line 3R (30 O/ 133 KT) and then enters it into 4R. The 133 KT Vref speed bug will be correctly displayed on both sides.

Example 2, with anomaly: The Captain directs a Vref speed change to 140 KT and “ / 140 ” is entered into 4R on the APPROACH REF page. In this case, the Vref bug will be displayed at 140 on one speed tape, but the previously entered value (133) is displayed on the other speed tape. The speed tape displaying the correct value is on the side of the master FMC and does not depend on which CDU is used to make the input.

This anomaly only occurs when a speed-only format entry is made. This anomaly appears on airplanes with the PEGASUS FMC installed. The PEGASUS FMC can be identified by the OP PROGRAM part number displayed on the IDENT page:

- 3413-HNP-02C-03

Operating Instructions

When a previous Vref entry requires a speed alteration, ensure that the entry into 4R includes both the desired flap setting and the new Vref speed (e.g. 30° / 134). The FMC computed speeds in 1R, 2R, or 3R may also be downselected and then entered into 4R for display on both speed tapes.

Administrative Information

Insert this bulletin behind the Operations Manual Bulletin Record page in Volume 1 of your Operations Manual. Amend the Operations Manual Bulletin Record to show bulletin TBC-35 "In Effect" (IE).

This anomaly will be corrected by Boeing Service Bulletin 767-34-0291 scheduled to be available April 1, 1999. This Operations Manual Bulletin will be canceled after Boeing is notified that all affected airplanes in the operators fleet have been modified.

Please send all correspondence regarding Operations Manual Bulletins status to one of the following addresses:

Boeing Commercial Airplanes
Commercial Aviation Services
Attn: 767 Manager, Flight Technical Data
P.O. Box 3707, M/C 20-89
Seattle, Washington, 98124-2207 USA
Telephone: (206) 662-4000
Fax: (206) 662-4743



Flight Crew Operations Manual Bulletin for The Boeing Company

The Boeing Company
Seattle, Washington 98124-2207



Number: TBC-36

IssueDate: February 14, 2007

Airplane Effectivity: All Airplanes

Subject: Invalid ILS Indication

Reason: This bulletin provides information informing flight crews of the potential for false localizer indications.

Information in this bulletin is recommended by The Boeing Company, but may not be FAA approved at the time of writing. In the event of conflict with the FAA approved Airplane Flight Manual (AFM), the AFM shall supersede. The Boeing Company regards the information or procedures described herein as having a direct or indirect bearing on the safe operation of this model airplane.

THE FOLLOWING PROCEDURE AND/OR INFORMATION IS EFFECTIVE UPON RECEIPT

Background Information

It has been determined by ground tests that Electro Magnetic Interference (EMI) generated by X-band weather radar systems may cause false localizer indications on the EFIS. The EMI causes audio noise in all three ILS systems and may cause false localizer deviation indications on both Captain's and First Officer's EFIS. The EMI also affects the standby attitude ILS display. The false localizer indication may occur when the ILS receiver is tuned to an ILS frequency not in use or when a normal localizer signal being received goes off the air for any reason. There are no visual indications in the cockpit to warn the flight crew of this localizer signal anomaly.

The EMI, which causes false localizer indications, is introduced into the ILS system by weather radar interference picked up by the localizer antenna. Some ILS frequencies are more susceptible than others to EMI interference. VOR and glideslope signals, and indications, are not known to be affected by the EMI.

Airline Engineering and Maintenance personnel are being advised of the EMI anomaly and will be provided information to correct the problem via Service Letter and Service Bulletin.

Operating Instructions

When conditions permit, accomplish ILS approaches with weather radar OFF.

If this is not possible, until the affected airplane radars are modified, the following operating instructions apply:

If the weather radar is OFF, follow the normal procedures. If the weather radar is ON, in addition to the normal procedures perform the following:

- Aurally identify the ILS station prior to the outer marker and continuously monitor the audio signal through completion of the ILS approach.
- Unless the runway is in sight, do not continue an ILS approach if the ILS audio signal is lost.
- Do not use ILS localizer to track outbound (eg departures, ILS outbound to procedure turn, or missed approaches).

Administrative Information

Insert this bulletin behind the Operations Manual Bulletin Record page in Volume 1 of your Operations Manual. Amend the Operations Manual Bulletin Record to show bulletin TBC-36 "In Effect" (IE).

This Operations Manual Bulletin will be canceled after Boeing is notified that all affected airplanes in the operators fleet have been modified by Boeing Service Bulletin 767-34A0055.

Please send all correspondence regarding Operations Manual Bulletins status to one of the following addresses:

Boeing Commercial Airplanes
Commercial Aviation Services
Attn: 767 Manager, Flight Technical Data
P.O. Box 3707, M/C 20-89
Seattle, Washington, 98124-2207 USA
Telephone: (206) 662-4000
Fax: (206) 662-4743



Flight Crew Operations Manual Bulletin for The Boeing Company

The Boeing Company
Seattle, Washington 98124-2207



Number: TBC-37

IssueDate: February 14, 2007

Airplane Effectivity: All Airplanes

Subject: Pegasus Flight Management Computer (FMC) VNAV Level Off Anomaly

Reason: This bulletin provides information for flight crews regarding FMC anomaly.

Information in this bulletin is recommended by The Boeing Company, but may not be FAA approved at the time of writing. In the event of conflict with the FAA approved Airplane Flight Manual (AFM), the AFM shall supersede. The Boeing Company regards the information or procedures described herein as having a direct or indirect bearing on the safe operation of this model airplane.

THE FOLLOWING PROCEDURE AND/OR INFORMATION IS EFFECTIVE UPON RECEIPT

Background Information

Several in-service occurrences of an anomaly at high altitude have been reported on airplanes equipped with the Pegasus FMC. During a normal cruise altitude capture, VNAV SPD transitions to VNAV PATH. If the cruise altitude is near Cruise Thrust Limit Altitude and the airplane climb speed is slightly below target cruise speed when altitude capture is initiated, the airplane may pitch down and descend attempting to accelerate to the target speed. Also, some occurrences have been accompanied by a thrust lever reduction concurrent with the descent.

This anomaly appears on airplanes with the PEGASUS FMC installed. The PEGASUS FMC can be identified by the OP PROGRAM part number displayed on the IDENT page:

- 3413-HNP-02C-03 or
- 3414-HNP-02C-04

Operating Instructions

Normal pilot action is appropriate. The Boeing Fight Crew Training Manual and Operations Manual recommend that for any unsatisfactory automatic system performance that the pilot intervenes. Should this anomaly occur at high altitude, the pilot should ensure proper thrust is set and complete the level-off.

Any operator observing this condition, especially where the condition also results in a thrust lever reduction, is requested to provide flight profile data such as:

- summary of pilot actions (CDU entries, flight mode changes, such as autopilot flight level change to VNAV engagement or use of VNAV during climb)
- VNAV mode displayed (VNAV PATH or VNAV SPD)
- autothrottle mode displayed (EPR/N1, SPD, IDLE etc...)
- TMC mode displayed (CLB, CRZ etc...)
- airplane state (altitude, climb rate, speed, and speed target).

Administrative Information

Insert this bulletin behind the Operations Manual Bulletin Record page in Volume 1 of your Operations Manual. Amend the Operations Manual Bulletin Record to show bulletin TBC-37 "In Effect" (IE).

This anomaly is corrected by Boeing Service Bulletin 767-34-0317.

Please send all correspondence regarding Operations Manual Bulletins status to one of the following addresses:

Boeing Commercial Airplanes
Commercial Aviation Services
Attn: 767 Manager, Flight Technical Data
P.O. Box 3707, M/C 20-89
Seattle, Washington, 98124-2207 USA
Telephone: (206) 662-4000
Fax: (206) 662-4743



Flight Crew Operations Manual Bulletin for The Boeing Company

The Boeing Company
Seattle, Washington 98124-2207



Number: TBC-38

IssueDate: February 14, 2007

Airplane Effectivity: All Airplanes

Subject: Pegasus FMC HSI Map Display Anomaly

Reason: This bulletin provides information for flight crews regarding an FMC anomaly.

Information in this bulletin is recommended by The Boeing Company, but may not be FAA approved at the time of writing. In the event of conflict with the FAA approved Airplane Flight Manual (AFM), the AFM shall supersede. The Boeing Company regards the information or procedures described herein as having a direct or indirect bearing on the safe operation of this model airplane.

THE FOLLOWING PROCEDURE AND/OR INFORMATION IS EFFECTIVE UPON RECEIPT

Background Information

Data search function. At initial power up, the FMC searches the navigation database for all nav aids, airports, and waypoints within a 700NM radius and loads them into memory. The data search function requires approximately 25 seconds and is done in background (not visible to the pilot). The search is also initiated when any function on the HSI control panel is changed (e.g. range scale, mode, or map switches). If a “power transition” occurs while the search is in progress, the search function will not operate again until power is removed from the FMC’s. Removing FMC power resets the search function.

Problem. Operators have reported several in-service occurrences of an HSI display anomaly in which nav aids, airports, and waypoints were not displayed when the respective switch on the HSI control panel was selected. The anomaly is caused by the occurrence of an airplane power transition (e.g. during engine start) while the FMC’s EFIS data search function is in progress.

This anomaly may not be detectable by the crew until the airplane is more than 700NM from the departure airport because it is likely that a successful search occurred at power up prior to any failure. In this case, the map data may appear correct until exceeding the 700NM radius. Beyond that radius, map background data may not be displayed. Tuned nav aids, alternate airports (as shown on the ALTN page) and entries on the FIX page will be displayed as expected.

This anomaly appears on airplanes with the PEGASUS FMC installed. The PEGASUS FMC can be identified by the OP PROGRAM part numbers, either 3413-HNP-02C-03 or 3414-HNP-02C-04, displayed on the IDENT page.

Operating Instructions

1. Avoid making switch selections on the HSI control panel within approximately 30 seconds of an anticipated power transfer (e.g. ground to APU, APU to engine generator).
2. If preflight data has already been entered and the anomaly is suspected (e.g. an unanticipated power transfer occurred), normal operation can be restored by maintenance personnel as advised in the Boeing maintenance TIP sheets 757 MT 34-032 and 767 MT 34-036 dated 06 Aug 99.
3. If this occurs while airborne, the discrepancy should be documented for maintenance action.

Administrative Information

Insert this bulletin behind the Operations Manual Bulletin Record page in Volume 1 of your Operations Manual. Amend the Operations Manual Bulletin Record to show bulletin TBC-38 "In Effect" (IE).

This anomaly is corrected by Boeing Service Bulletin 767-34-0317.

Please send all correspondence regarding Operations Manual Bulletins status to one of the following addresses:

Boeing Commercial Airplanes
Commercial Aviation Services
Attn: 767 Manager, Flight Technical Data
P.O. Box 3707, M/C 20-89
Seattle, Washington, 98124-2207 USA
Telephone: (206) 662-4000
Fax: (206) 662-4743



Flight Crew Operations Manual Bulletin for The Boeing Company

The Boeing Company
Seattle, Washington 98124-2207



Number: TBC-39

IssueDate: February 14, 2007

Airplane Effectivity: All Airplanes

Subject: Performance Adjustments for Thrust Shortfall of PW4000 Series Powered Airplanes with FB2B and FB2T Fans Installed

Reason: To provide subject adjustments for Operations Manual (OM) Performance Inflight (PI) chapter in accordance with 767 Airworthiness Directive AD 2001-01-10.

Information in this bulletin is recommended by The Boeing Company, but may not be FAA approved at the time of writing. In the event of conflict with the FAA approved Airplane Flight Manual (AFM), the AFM shall supersede. The Boeing Company regards the information or procedures described herein as having a direct or indirect bearing on the safe operation of this model airplane.

THE FOLLOWING PROCEDURE AND/OR INFORMATION IS EFFECTIVE UPON RECEIPT

Background Information

This bulletin advises operators of revised performance information applicable to the 767 with Pratt & Whitney PW4000 series engines equipped with FB2B or FB2T fans. Engines equipped with FB2B/FB2T (Phase 0/1) fans have been found to be subject to a shortfall in thrust at high EPR due to fan blade leading edge erosion which occurs normally in service. Engines equipped with FB2C (Phase 3) fans have been shown to be free from thrust degradation and have no shortfall in rated thrust. All PW4062 engines are equipped with FB2C (Phase 3) fans and therefore are not affected by this bulletin.

Engine Identification:

On each airplane, each engine's model designation must be established. Listed below are the model designations as they appear on the dataplate for engines with a hardware configuration that includes an FB2C (Phase 3) fan. Unless all engines on a particular airplane have been confirmed to have FB2C (Phase 3) fans, the performance adjustments will apply.

PW4000 Engine Dataplate Model Designations For Engines With FB2C (Phase 3) Fans which are **NOT** Affected by the Thrust Shortfall:

| | |
|--------------|---------------|
| PW4052 (-3) | PW4052 (-1C) |
| PW4056 (-3) | PW4056 (-1C) |
| PW4060 (-3) | PW4060 (-1C) |
| PW4060A (-3) | PW4060A (-1C) |
| PW4060C (-3) | PW4060C (-1C) |
| PW4062 (-3) | PW4062 (-1C) |

Operating Instructions

The following airplane performance adjustments apply when operating with one or both engines which are not equipped with FB2C (Phase 3) fans.

Reduce Long Range Cruise Maximum Operating Altitude by 800 ft.

Reduce Engine Inoperative Altitude Capability for all speeds by 1500 ft.

Reduce Gear Down Long Range Cruise Altitude Capability by 1400 ft.

Reduce Engine Inoperative Gear Down Long Range Cruise Altitude Capability by 2000 ft.

Increase Driftdown/LRC Cruise Range Capability fuel required by 2%.

Operations Manual Performance Inflight (PI) Chapter and FMC performance numbers should be adjusted accordingly.

Administrative Information

Insert this bulletin behind the Operations Manual Bulletin Record page in Volume 1 of your Operations Manual. Amend the Operations Manual Bulletin Record to show bulletin TBC-39 "In Effect" (IE).

This Operations Manual Bulletin will remain in effect as long as 767 Airworthiness Directive AD 2001-01-10 is effective. Application of the information contained herein may change if and when alternate means of compliance with the AD are granted.

Please send all correspondence regarding Operations Manual Bulletins status to one of the following addresses:

Boeing Commercial Airplanes
Commercial Aviation Services
Attn: 767 Manager, Flight Technical Data
P.O. Box 3707, M/C 20-89
Seattle, Washington, 98124-2207 USA
Telephone: (206) 662-4000
Fax: (206) 662-4743

Intentionally
Blank



Flight Crew Operations Manual Bulletin for The Boeing Company

The Boeing Company
Seattle, Washington 98124-2207



Number: TBC-40

IssueDate: February 14, 2007

Airplane Effectivity: All Airplanes

Subject: PW4000 Engine Operation In Heavy Rain Or Hail

Reason: This bulletin provides information informing flight crews of temporary recommended procedures for maintaining a minimum thrust setting of approach idle if heavy rain or hail is encountered or anticipated.

Information in this bulletin is recommended by The Boeing Company, but may not be FAA approved at the time of writing. In the event of conflict with the FAA approved Airplane Flight Manual (AFM), the AFM shall supersede. The Boeing Company regards the information or procedures described herein as having a direct or indirect bearing on the safe operation of this model airplane.

THE FOLLOWING PROCEDURE AND/OR INFORMATION IS EFFECTIVE UPON RECEIPT

Background Information

In compliance with Airworthiness Directive 90-20-11, PW4000 series engines are currently limited inflight to a minimum thrust setting of approach idle. A new Airworthiness Directive 93-08-16 has been released which will restore inflight low idle operation. Boeing Service Bulletin 767-73-0041 is expected to be released in late November, 1993 providing the necessary information for this modification.

However, the Boeing preferred method of operating the PW4000 series engine in very heavy rain or hail is to maintain a minimum thrust setting of approach idle. An airplane modification is planned to automatically set a minimum thrust setting of approach idle when ignition is selected to CONT. In the interim, Boeing recommends that the flight crew procedures be modified to maintain a minimum of approach idle in conditions likely to result in very heavy rain or hail encounter. Increasing engine RPM to approach idle will assure satisfactory engine operation.

Operating Instructions

Flights should be conducted to avoid thunderstorm activity by over flight or circumnavigation. To the maximum extent possible, heavy rain or hail should also be avoided. Weather radar, pilot reports, and flight crew observations may be used by the flight crew to determine when heavy rain or hail is anticipated. Should flight in heavy rain or hail be encountered or anticipated, accomplish the following procedure:

PW4000 SERIES ENGINE OPERATION IN HEAVY RAIN OR HAIL

Condition: Heavy rain or hail encountered or anticipated.

If TAT is 10 degrees C or below:

ENGINE ANTI-ICE-----ON

[Maintains a minimum thrust setting of approach idle and provides continuous ignition.]

If TAT is above 10 degrees C:

ENGINE START SELECTORS----- CONT

[Provides flameout protection.]

AUTOTHROTTLE (If engaged) ----- DISENGAGE

Autothrottle may remain engaged during takeoff, climb and cruise.

[Prevents autothrottle thrust reduction below desired setting during descent.]

THRUST LEVERS ----- SET

Set a minimum of 50 % N1 at or above 10,000 ft, 45% N1 below 10,000 ft except for landing.

Note: In heavy precipitation, engine parameter fluctuations may occur, particularly a noticeable drop in EGT. Engine parameters will return to normal immediately upon leaving the area of heavy precipitation.

Administrative Information

Insert this bulletin behind the Operations Manual Bulletin Record page in Volume 1 of your Operations Manual. Amend the Operations Manual Bulletin Record to show bulletin TBC-40 "In Effect" (IE).

This Operations Manual Bulletin will be canceled after Boeing is notified that all affected airplanes in the operators fleet have been modified by Boeing Service Bulletin 767-73-0044.

Please send all correspondence regarding Operations Manual Bulletins status to one of the following addresses:

Boeing Commercial Airplanes
Commercial Aviation Services
Attn: 767 Manager, Flight Technical Data
P.O. Box 3707, M/C 20-89
Seattle, Washington, 98124-2207 USA
Telephone: (206) 662-4000
Fax: (206) 662-4743

Intentionally
Blank



Flight Crew Operations Manual Bulletin for The Boeing Company

The Boeing Company
Seattle, Washington 98124-2207



Number: TBC-41

IssueDate: February 14, 2007

Airplane Effectivity: All Airplanes

Subject: PW4000 Engine Idle Modification

Reason: This bulletin provides information informing flight crews of temporary recommended procedures for descent planning.

Information in this bulletin is recommended by The Boeing Company, but may not be FAA approved at the time of writing. In the event of conflict with the FAA approved Airplane Flight Manual (AFM), the AFM shall supersede. The Boeing Company regards the information or procedures described herein as having a direct or indirect bearing on the safe operation of this model airplane.

THE FOLLOWING PROCEDURE AND/OR INFORMATION IS EFFECTIVE UPON RECEIPT

Background Information

Recent test cell and inflight testing have revealed a potential for engine surges following rapid, re-application of full power after several minutes operation at minimum idle. Further, ground and flight testing have shown no occurrence of this anomaly when inflight engine idle is limited to approach idle. This condition has not been reported by any operator as an in-service problem.

When Boeing Service Bulletin 767-73-0033 is incorporated, the engine fuel control system limits the inflight idle to approach idle. This change affects the FMC descent forecast which must be modified by the crew prior to descent. There is no impact on takeoff or landing performance and a small change in trip fuel.

Boeing Service Bulletin 767-73-0041 enables returning to inflight idle settings.

Operating Instructions

To assist in forecasting an accurate descent path in-flight, 30 minutes, or not less than 50 miles, prior to top of descent, the flight crew should enter on the Descent Forecast Page on the FMC, a TAI/ON altitude equal to the top of descent altitude until Boeing Service Bulletin 767-73-0041 is incorporated.

Administrative Information

Insert this bulletin behind the Operations Manual Bulletin Record page in Volume 1 of your Operations Manual. Amend the Operations Manual Bulletin Record to show bulletin TBC-41 "In Effect" (IE).

This Operations Manual Bulletin will be canceled after Boeing is notified that all affected airplanes in the operators fleet have been modified by Boeing Service Bulletin 767-73-0041.

Please send all correspondence regarding Operations Manual Bulletins status to one of the following addresses:

Boeing Commercial Airplanes
Commercial Aviation Services
Attn: 767 Manager, Flight Technical Data
P.O. Box 3707, M/C 20-89
Seattle, Washington, 98124-2207 USA
Telephone: (206) 662-4000
Fax: (206) 662-4743



Flight Crew Operations Manual Bulletin for The Boeing Company

The Boeing Company
Seattle, Washington 98124-2207



Number: TBC-42

IssueDate: February 14, 2007

Airplane Effectivity: All Airplanes

Subject: Unscheduled In Motion Brake Application

Reason: This bulletin provides information informing flight crews of temporary recommended procedures for arming autobrakes.

Information in this bulletin is recommended by The Boeing Company, but may not be FAA approved at the time of writing. In the event of conflict with the FAA approved Airplane Flight Manual (AFM), the AFM shall supersede. The Boeing Company regards the information or procedures described herein as having a direct or indirect bearing on the safe operation of this model airplane.

THE FOLLOWING PROCEDURE AND/OR INFORMATION IS EFFECTIVE UPON RECEIPT

Background Information

Several incidents of unscheduled in motion brake application while positioning the autobrakes selector to RTO have been reported.

Operating Instructions

Pending completion of Boeing Service Bulletin 767-32-0057, it is suggested that flight crews comply with the published Boeing procedural sequence and select RTO before taxi. In addition, it is recommended that RTO be selected only when the airplane is not in motion to preclude any possibility of interference with the pushback operation.

Administrative Information

Insert this bulletin behind the Operations Manual Bulletin Record page in Volume 1 of your Operations Manual. Amend the Operations Manual Bulletin Record to show bulletin TBC-42 "In Effect" (IE).

This Operations Manual Bulletin will be canceled after Boeing is notified that all affected airplanes in the operators fleet have been modified by Boeing Service Bulletin 767-32-0057.

Please send all correspondence regarding Operations Manual Bulletins status to one of the following addresses:

Boeing Commercial Airplanes
Commercial Aviation Services
Attn: 767 Manager, Flight Technical Data
P.O. Box 3707, M/C 20-89
Seattle, Washington, 98124-2207 USA
Telephone: (206) 662-4000
Fax: (206) 662-4743



Flight Crew Operations Manual Bulletin for The Boeing Company

The Boeing Company
Seattle, Washington 98124-2207



Number: TBC-43

IssueDate: February 14, 2007

Airplane Effectivity: All Airplanes

Subject: Uncommanded Autopilot Engagement, Flight Mode Changes, And IAS/MACH Window Speed Changes

Reason: To advise flight crews of the possibility of uncommanded autopilot engagement, flight mode changes, and IAS/Mach Window speed changes, and provide recommended temporary instructions for these situations.

Information in this bulletin is recommended by The Boeing Company, but may not be FAA approved at the time of writing. In the event of conflict with the FAA approved Airplane Flight Manual (AFM), the AFM shall supersede. The Boeing Company regards the information or procedures described herein as having a direct or indirect bearing on the safe operation of this model airplane.

THE FOLLOWING PROCEDURE AND/OR INFORMATION IS EFFECTIVE UPON RECEIPT

Background Information

UNCOMMANDED AUTOPILOT ENGAGEMENT AND FLIGHT MODE CHANGES

Boeing has received reports from operators of uncommanded autopilot engagement and flight mode changes. The reports document at least one rejected takeoff and one undesired heading change. Engineering investigation has determined these anomalies are caused by faulty MCP push-button switches installed during production or subsequent component repair. Intermittent switch malfunction can cause this anomaly without pilot action. The normal means for disengaging the autopilot, Autopilot Disengage Switches and the Autopilot Disengage Bar, are unaffected by this anomaly and operate normally.

Alert Service Bulletin SB 767-22A0092 corrects these anomalies.

UNCOMMANDED IAS/MACH WINDOW SELECTED SPEED CHANGES

Boeing has also received reports from operators of unexpected transition from selected speed to 0.80 Mach upon multiple channel autopilot engagement during automatic approach, and upon autopilot disengagement. Under these conditions, the selected IAS/MACH Window speed changes to 0.80 Mach, requiring pilot intervention to regain airspeed control. Investigation has determined these anomalies occur only with older flight control computers (FCC S241T100-101 thru 109 and S241T100-131 thru 133).

Alert Service Bulletin SB 767-22A0092 corrects these anomalies.

Operating Instructions

UNCOMMANDED AUTOPILOT ENGAGEMENT

Flight crews should closely monitor ADI flight mode annunciations for autopilot status, and be prepared to respond to uncommanded autopilot engagement during critical phases of flight, including takeoff. Uncommanded autopilot engagement can be corrected by disengaging the autopilot.

UNCOMMANDED FLIGHT MODE CHANGES

Flight crews should closely monitor ADI flight mode annunciations for autothrottle, roll, and pitch status, and be prepared to respond to uncommanded mode changes during critical phases of flight, including takeoff. Uncommanded flight mode changes can be corrected by selecting the desired mode on the MCP.

UNCOMMANDED IAS/MACH WINDOW SPEED CHANGES

Flight crews should closely monitor command speed bug and be prepared to respond to uncommanded changes to 0.80 Mach under the following conditions:

- multiple channel autopilot engagement during automatic approach
- autopilot disengagement.

If the command speed changes to 0.80 Mach under either condition; disconnect the autothrottle, push the IAS/MACH Select Switch to change IAS/MACH Window display to IAS, then set desired speed in the IAS/MACH Window. After resetting speed, the autothrottle may be reconnected.

Administrative Information

Insert this bulletin behind the Operations Manual Bulletin Record page in Volume 1 of your Operations Manual. Amend the Operations Manual Bulletin Record to show bulletin TBC-43 "In Effect" (IE).

This Operations Manual Bulletin will be canceled after Boeing is notified that all affected airplanes in the operators fleet have been modified by Boeing Alert Service Bulletin SB 767-22A0092.

Please send all correspondence regarding Operations Manual Bulletins status to one of the following addresses:

Boeing Commercial Airplanes
Commercial Aviation Services
Attn: 767 Manager, Flight Technical Data
P.O. Box 3707, M/C 20-89
Seattle, Washington, 98124-2207 USA
Telephone: (206) 662-4000
Fax: (206) 662-4743

Intentionally
Blank



Flight Crew Operations Manual Bulletin for The Boeing Company

The Boeing Company
Seattle, Washington 98124-2207



Number: TBC-44

IssueDate: February 14, 2007

Airplane Effectivity: All Airplanes

Subject: Uncommanded CDU Page Changes

Reason: This bulletin provides information for flight crews regarding FMC anomaly.

Information in this bulletin is recommended by The Boeing Company, but may not be FAA approved at the time of writing. In the event of conflict with the FAA approved Airplane Flight Manual (AFM), the AFM shall supersede. The Boeing Company regards the information or procedures described herein as having a direct or indirect bearing on the safe operation of this model airplane.

THE FOLLOWING PROCEDURE AND/OR INFORMATION IS EFFECTIVE UPON RECEIPT

Background Information

On airplanes with PEGASUS FMC installed, crews may experience an uncommanded page change on the CDU.

This anomaly appears on airplanes with an earlier version of the PEGASUS FMC installed. The earlier version can be identified by the OP PROGRAM part number displayed on the IDENT page:

- 3413-HNP-02C-03

Operating Instructions

Select the desired page appropriate for phase of flight.

Administrative Information

Insert this bulletin behind the Operations Manual Bulletin Record page in Volume 1 of your Operations Manual. Amend the Operations Manual Bulletin Record to show bulletin TBC-44 "In Effect" (IE).

This anomaly will be corrected by Boeing Service Bulletin 767-34-0291 scheduled to be available April 1, 1999. This Operations Manual Bulletin will be canceled after Boeing is notified that all affected airplanes in the operators fleet have been modified.

Please send all correspondence regarding Operations Manual Bulletins status to one of the following addresses:

Boeing Commercial Airplanes
Commercial Aviation Services
Attn: 767 Manager, Flight Technical Data
P.O. Box 3707, M/C 20-89
Seattle, Washington, 98124-2207 USA
Telephone: (206) 662-4000
Fax: (206) 662-4743



Flight Crew Operations Manual Bulletin for The Boeing Company

The Boeing Company
Seattle, Washington 98124-2207



Number: TBC-45

IssueDate: February 14, 2007

Airplane Effectivity: All Airplanes

Subject: Use of Manual Trim for Flap 1 Takeoff

Reason: This bulletin provides information providing flight crews with interim operating instructions for setting stabilizer trim for a Flap 1 takeoff.

Information in this bulletin is recommended by The Boeing Company, but may not be FAA approved at the time of writing. In the event of conflict with the FAA approved Airplane Flight Manual (AFM), the AFM shall supersede. The Boeing Company regards the information or procedures described herein as having a direct or indirect bearing on the safe operation of this model airplane.

THE FOLLOWING PROCEDURE AND/OR INFORMATION IS EFFECTIVE UPON RECEIPT

Background Information

A dual position nose down electric trim limit switch was incorporated by Boeing Service Bulletins 767-27-0052 and 767-27A0071 and in production on airplane line number 183 and on. The purpose of this modification was to limit nose down stabilizer trim to 1.5 units with the flaps up and to .5 units with the flaps down.

Since flap position is sensed from the position of the trailing edge flaps, the flight crew may be unable to electrically set the stabilizer trim forward of 1.5 units when using Flap 1 (leading edge only).

Future revision of the above Service Bulletins will be issued to change the flap position sensor to the leading edge flaps which will set the stabilizer limit switch to .5 units for all flap down conditions.

Operating Instructions

Pending incorporation of the revised Service Bulletins, flight crews may be required to use the Stabilizer Trim Levers when selecting stab trim positions between 1.5 and .5 units for a Flap 1 takeoff.

Administrative Information

Insert this bulletin behind the Operations Manual Bulletin Record page in Volume 1 of your Operations Manual. Amend the Operations Manual Bulletin Record to show bulletin TBC-45 "In Effect" (IE).

This Operations Manual Bulletin will be canceled after Boeing is notified that all affected airplanes in the operators fleet have been modified by Boeing Service Bulletins 767-27A0071 R2 and 767-27-0052 R2.

Please send all correspondence regarding Operations Manual Bulletins status to one of the following addresses:

Boeing Commercial Airplanes
Commercial Aviation Services
Attn: 767 Manager, Flight Technical Data
P.O. Box 3707, M/C 20-89
Seattle, Washington, 98124-2207 USA
Telephone: (206) 662-4000
Fax: (206) 662-4743



Flight Crew Operations Manual Bulletin for The Boeing Company

The Boeing Company
Seattle, Washington 98124-2207



Number: TBC-46

IssueDate: February 14, 2007

Airplane Effectivity: All Airplanes

Subject: VNAV Descent to Holding Altitude

Reason: This bulletin provides information for flight crews regarding an FMC anomaly.

Information in this bulletin is recommended by The Boeing Company, but may not be FAA approved at the time of writing. In the event of conflict with the FAA approved Airplane Flight Manual (AFM), the AFM shall supersede. The Boeing Company regards the information or procedures described herein as having a direct or indirect bearing on the safe operation of this model airplane.

THE FOLLOWING PROCEDURE AND/OR INFORMATION IS EFFECTIVE UPON RECEIPT

Background Information

An operator has reported incidents of VNAV incorrectly allowing descent through the selected MCP altitude. This may occur while descending enroute to a holding pattern. When a VNAV descent is in progress and an altitude constraint is entered in 1R on the HOLD page, the altitude constraint will be displayed in large font on the respective HOLD AT line on the LEGS page. This condition results in the altitude constraint being placed on the HOLD, not necessarily on the waypoint. In some cases, VNAV may allow the airplane to descend below the constraint / HOLD altitude, even if the MCP window is set at the HOLD altitude.

A corresponding anomaly does not exist while the airplane is in a climb. While performing a VNAV climb to a holding pattern, the airplane will not climb through the MCP altitude.

This anomaly has been verified by Boeing and exists in the 200K, 700K, 1-Meg Non PIP FMCs. The anomaly will not occur on those FMCs which incorporate the VNAV ALT mode.

The pilot can identify the applicable FMC by reference to Line 5 on the IDENT page. The applicable FMC will show DRAG FACTOR on Line 5L and F-F Factor (fuel flow factor) on Line 5R.

For information purposes, the non-applicable FMCs will show DRAG/FF (drag and fuel flow factor) on Line 5L and CO DATA on Line 5R (PIP FMC) or OPC on Line 5L and DRAG/FF on Line 5R (PEGASUS). The installed CDU does not provide a reliable indication of the installed FMC because some airplanes have been retrofitted with PIP or PEGASUS FMCs while retaining the basic CDU.

Operating Instructions

When directed to descend and hold at a specified altitude at a waypoint in the route, enter the altitude constraint on the LEGS page. This can be done prior to or after creating the HOLD but must be done on the LEGS page.

Administrative Information

Insert this bulletin behind the Operations Manual Bulletin Record page in Volume 1 of your Operations Manual. Amend the Operations Manual Bulletin Record to show bulletin TBC-46 "In Effect" (IE).

This anomaly will be corrected by Boeing Service Bulletin 767-34-0301 or 767-34-0302 or 767-34-0303. Refer to individual Service Bulletin for applicability.

Please send all correspondence regarding Operations Manual Bulletins status to one of the following addresses:

Boeing Commercial Airplanes
Commercial Aviation Services
Attn: 767 Manager, Flight Technical Data
P.O. Box 3707, M/C 20-89
Seattle, Washington, 98124-2207 USA
Telephone: (206) 662-4000
Fax: (206) 662-4743



Flight Crew Operations Manual Bulletin for The Boeing Company

The Boeing Company
Seattle, Washington 98124-2207



Number: TBC-47

IssueDate: February 14, 2007

Airplane Effectivity: All Airplanes

Subject: CDU Page Changes During Engine Inoperative Operation

Reason: This bulletin provides information informing flight crews of temporary recommended procedures for determining the engine out cruise speed.

Information in this bulletin is recommended by The Boeing Company, but may not be FAA approved at the time of writing. In the event of conflict with the FAA approved Airplane Flight Manual (AFM), the AFM shall supersede. The Boeing Company regards the information or procedures described herein as having a direct or indirect bearing on the safe operation of this model airplane.

THE FOLLOWING PROCEDURE AND/OR INFORMATION IS EFFECTIVE UPON RECEIPT

Background Information

The FMC operating programs listed immediately below will not allow the CDU display to automatically switch from ACT ENG OUT CRZ D/D to ACT ENG OUT CRZ following single engine driftdown unless VNAV is engaged. Selecting VNAV in single engine cruise will cause the CDU to display ACT ENG OUT CRZ.

Operating Programs

| | | |
|---------------|---------------|---------------|
| PS4038178-131 | PS4052520-132 | PS4052520-136 |
| PS4038178-132 | PS4052520-133 | PS4052520-137 |
| PS4038178-133 | PS4052520-134 | PS4052520-140 |
| PS4052520-123 | PS4052520-135 | PS4052970-940 |

Incorporation of Boeing Service Bulletin 767-34-0103 will correct this problem for General Electric powered airplanes.

Incorporation of Boeing Service Bulletin 767-34-0079 will correct this problem for Pratt & Whitney powered airplanes.

Operating Instructions

During engine inoperative operation, engine out LRC speed may be determined using the CDU if VNAV is engaged. IF VNAV is not engaged, use the QRH or other approved source to determine engine out long range cruise speed.

Administrative Information

Insert this bulletin behind the Operations Manual Bulletin Record page in Volume 1 of your Operations Manual. Amend the Operations Manual Bulletin Record to show bulletin TBC-47 "In Effect" (IE).

This Operations Manual Bulletin will be canceled after Boeing is notified that all affected airplanes in the operators fleet have been modified by Boeing Service Bulletin 767-34-0103 or 767-34-0079.

Please send all correspondence regarding Operations Manual Bulletins status to one of the following addresses:

Boeing Commercial Airplanes
Commercial Aviation Services
Attn: 767 Manager, Flight Technical Data
P.O. Box 3707, M/C 20-89
Seattle, Washington, 98124-2207 USA
Telephone: (206) 662-4000
Fax: (206) 662-4743



Flight Crew Operations Manual Bulletin for The Boeing Company

The Boeing Company
Seattle, Washington 98124-2207



Number: TBC-48

IssueDate: February 14, 2007

Airplane Effectivity: All Airplanes

Subject: CF6-80C2 FADEC Engine Operation In Heavy Rain Or Hail

Reason: This bulletin provides information informing flight crews of temporary recommended procedures for maintaining a minimum thrust setting of approach idle if heavy rain or hail is encountered or anticipated.

Information in this bulletin is recommended by The Boeing Company, but may not be FAA approved at the time of writing. In the event of conflict with the FAA approved Airplane Flight Manual (AFM), the AFM shall supersede. The Boeing Company regards the information or procedures described herein as having a direct or indirect bearing on the safe operation of this model airplane.

THE FOLLOWING PROCEDURE AND/OR INFORMATION IS EFFECTIVE UPON RECEIPT

Background Information

GE Aircraft Engines has conducted hail ingestion testing to determine the capability of the CF6-80C2 engine to meet ingestion criterion recommended by the Aerospace Industries Association following their "Investigation of Power Loss and Instability in Inclement Weather." Based upon this testing, GE has concluded that the Power Management Control (PMC) equipped engines have sufficient capability under all conditions; however, the FADEC equipped engines, because of their lower minimum idle speed in flight, and different Variable Bypass Valve (VBV) schedules, may have less than the desired capability at engine speeds below approach idle.

Flights through clouds, drizzle, light rain or snow will have no effect on engine operation assuming current procedures for these conditions are observed. However, flight through heavy rain or hail can cause engine spool down or flame out if thrust settings are below approach idle. To clarify weather conditions of concern, very heavy precipitation is rarely encountered except in thunderstorms.

An airplane modification is planned to automatically set a minimum thrust setting of approach idle when ignition is selected to CONT. In the interim, Boeing recommends that the flight crew procedures be modified to maintain a minimum of approach idle in conditions likely to result in very heavy rain or hail encounter. Increasing engine RPM to approach idle will assure satisfactory engine operation in the worst case conditions.

Operating Instructions

Flights should be conducted to avoid thunderstorm activity by over flight or circumnavigation. To the maximum extent possible, heavy rain or hail should also be avoided. Weather radar, pilot reports, and flight crew observations may be used by the flight crew to determine when heavy rain or hail is anticipated. Should flight in heavy rain or hail be encountered or anticipated, accomplish the following procedure:

CF6-80C2 SERIES FADEC ENGINE OPERATION IN HEAVY RAIN OR HAIL

Condition: Heavy rain or hail encountered or anticipated.

ENGINE START SELECTORS ----- .CONT

[Provides flameout protection.]

If TAT is 10 degrees C or below:

ENGINE ANTI-ICE----- -ON

[Maintains a minimum thrust setting of approach idle and provides continuous ignition.]

If TAT is above 10 degrees C:

AUTOTHROTTLE (If engaged) ----- DISENGAGE

Autothrottle may remain engaged during takeoff, climb and cruise.

[Prevents autothrottle thrust reduction below desired setting during descent.]

THRUST LEVERS ----- SET

Set a minimum of 50% N1 at or above 10,000 ft, 45% N1 below 10,000 ft except for landing.

Note: In heavy precipitation, engine parameter fluctuations may occur, particularly a noticeable drop in EGT. Engine parameters will return to normal immediately upon leaving the area of heavy precipitation.

Administrative Information

Insert this bulletin behind the Operations Manual Bulletin Record page in Volume 1 of your Operations Manual. Amend the Operations Manual Bulletin Record to show bulletin TBC-48 "In Effect" (IE).

This Operations Manual Bulletin will be canceled after Boeing is notified that all affected airplanes in the operators fleet have been modified by Boeing Service Bulletin 767-73-0043.

Please send all correspondence regarding Operations Manual Bulletins status to one of the following addresses:

Boeing Commercial Airplanes
Commercial Aviation Services
Attn: 767 Manager, Flight Technical Data
P.O. Box 3707, M/C 20-89
Seattle, Washington, 98124-2207 USA
Telephone: (206) 662-4000
Fax: (206) 662-4743

Intentionally
Blank



Flight Crew Operations Manual Bulletin for The Boeing Company

The Boeing Company
Seattle, Washington 98124-2207



Number: TBC-49

IssueDate: February 14, 2007

Airplane Effectivity: All Airplanes

Subject: Erroneous ILS Receiver Outputs

Reason: To advise operators of possible erroneous outputs from the Allied Signal "Quantum" ILS receivers.

Information in this bulletin is recommended by The Boeing Company, but may not be FAA approved at the time of writing. In the event of conflict with the FAA approved Airplane Flight Manual (AFM), the AFM shall supersede. The Boeing Company regards the information or procedures described herein as having a direct or indirect bearing on the safe operation of this model airplane.

THE FOLLOWING PROCEDURE AND/OR INFORMATION IS EFFECTIVE UPON RECEIPT

Background Information

A potential fault within the Allied Signal "Quantum" ILS receiver may cause either an erroneous localizer deviation indication or an erroneous glideslope deviation indication on the Standby ADI or on EFIS. The localizer and glideslope deviation indication on the opposite EFIS is not affected if this fault occurs in a single ILS receiver.

The Autopilot Flight Director System (AFDS) compares signals from the three ILS receivers and will not use signals from a faulty receiver. No EFIS flags are accompanied by the AFDS exclusion of a faulty ILS receiver; the AFDS simply ignores the receiver which is in disagreement. The Autoland Status Annunciator (ASA) will display "NO LAND 3", if installed, when the AFDS senses a faulty receiver. The AFDS will continue with the approach with no degradation in autopilot or flight director performance. In this case, the flight crew can expect the ASA "LAND 2" or "AUTOLAND 2", as installed, to display. If the airplane is dispatched with one inoperable ILS receiver, and a subsequent ILS receiver fault occurs, the ASA "NO AUTOLND" or "MANUAL LND", as installed, will display. The flight director command bar(s) will disappear from view.

Operating Instructions

This Operations Manual bulletin applies to all airplanes equipped with Allied Signal “Quantum” ILS receiver (P/N 066-50006-0101).

If both EFI Instrument Source Select switches are in the ALTN position, do not attempt any departure, approach, or missed approach utilizing a localizer or glideslope based navigation radio station. This will preclude the flight crew from potentially being presented with faulty localizer or glideslope deviation raw data in the event of a center ILS receiver fault. Such departure, approach or missed approaches include, but are not limited to: ILS, IGS, Localizer-only, Localizer-Backcourse, LDA and SDF-type instrument procedures.

While cross-checking the Captain’s and First Officer’s EFIS, if a disagreement is noted between the two ILS raw data indications during an approach, attempt to isolate the faulty signal as described below:

Note: The following should only be attempted if time permits. It should be completed prior to 1500 feet AGL and prior to the final approach fix:

- The Pilot Not Flying (PNF) should push the EFI Instrument Source Select switch to the ALTN position.
- If the Captain’s and First Officer’s ILS raw data indications agree, continue the approach and landing.
- If the ILS raw data indications disagree, the PNF should return the EFI Instrument Source Select switch to the normal position, and the Pilot Flying (PF) should push the EFI Instrument Source Select switch to the ALTN position.
- If the Captain’s and First Officer’s displays agree, continue with the approach and landing. Otherwise, initiate a go-around unless visual contact with the runway has been established.

If a go-around has been initiated, it is possible to inhibit the display of an erroneous deviation indication by placing the ILS in the “parked” mode. This can be accomplished by rotating the ILS Frequency Selector until “- - - -” is displayed on the ILS Frequency Indicator. The ILS Frequency Selector should be left in this position for a minimum of one minute before re-tuning the radio for the approach. A second approach can be attempted using normal procedures.

Administrative Information

Insert this bulletin behind the Operations Manual Bulletin Record page in Volume 1 of your Operations Manual. Amend the Operations Manual Bulletin Record to show bulletin TBC-49 "In Effect" (IE).

This anomaly is corrected by Boeing Service Bulletin 767-34A0269.

Please send all correspondence regarding Operations Manual Bulletins status to one of the following addresses:

Boeing Commercial Airplanes
Commercial Aviation Services
Attn: 767 Manager, Flight Technical Data
P.O. Box 3707, M/C 20-89
Seattle, Washington, 98124-2207 USA
Telephone: (206) 662-4000
Fax: (206) 662-4743

Intentionally
Blank



Flight Crew Operations Manual Bulletin for The Boeing Company

The Boeing Company
Seattle, Washington 98124-2207



Number: TBC-50

IssueDate: February 14, 2007

Airplane Effectivity: All Airplanes

Subject: Flight Management Computer (FMC) Resynchronizations

Reason: This bulletin provides information providing flight crews with interim operating instructions to reduce the number of FMC resynchronizations.

Information in this bulletin is recommended by The Boeing Company, but may not be FAA approved at the time of writing. In the event of conflict with the FAA approved Airplane Flight Manual (AFM), the AFM shall supersede. The Boeing Company regards the information or procedures described herein as having a direct or indirect bearing on the safe operation of this model airplane.

THE FOLLOWING PROCEDURE AND/OR INFORMATION IS EFFECTIVE UPON RECEIPT

Background Information

Reports have been received of excessive resynchronizations (resynchs) following entry of the arrival procedure. The majority of resynchs occurred in a tailwind condition shortly after entering an arrival procedure and the estimated thermal anti-ice (TAI) ON altitude. An investigation revealed that the majority of the resynchs were caused by a disagreement between the FMC descent paths.

Resynchs are a normal process used to restore the FMCs to identical states. However, they can be irritating to flight crews when they frequently occur during the accomplishment of normal procedures. When two FMCs are operating, both FMCs operate independently, but are required to maintain data synchronization. This is accomplished by the FMCs comparing data and resynching if the data is outside of established tolerances. Descent path comparisons occur every 5 minutes during climb, every 5 to 10 seconds in cruise, and immediately following any route modification.

A flight plan or vertical profile modification results in multiple recomputations of the descent path. The computations are performed asynchronously by the two FMCs and use the latest available wind data. It is possible, because of the asynchronous computations, that each FMC may use a different wind value. This may result in different values being computed for some parameters, such as speeds, causing a descent path miscompare. In FMCs with disc memories, the second consecutive miscomparison causes a resynch if the airplane is within 100 miles of the top of descent point. Entry of a non-executed modification, such as a TAI ON altitude, is more likely to cause miscomparisons since the timing of the initiation of the computation is less critically controlled than for an executed modification.

Descent paths are calculated using forecast and predicted wind. Forecast wind is displayed on the PERF INIT page cruise wind line and on the RTE DATA and DES FORECAST pages. Predicted wind in cruise is a blending of the actual wind at the present position and the forecast wind. When near the top of descent, predicted wind becomes equal to the actual wind. The probability of a resynch occurring is increased if no wind entry is made after the initial cruise wind entry on the PERF INIT page. When in cruise, if the actual wind is different from the entered wind, a difference will exist between forecast wind and predicted wind. In this condition, entry of the TAI ON altitude may cause a descent path miscomparison when the descent path is recomputed, which may in turn result in a resynch. If the TAI ON altitude entry is made shortly after the initial entry of the descent path, the probability of a resynch occurring may be increased further.

Operating Instructions

For many reasons, it is operationally beneficial to enter the arrival procedure early in the flight and make accurate wind forecast entries. If the forecast changes, new entries should be made.

To reduce resynchs near the top of descent:

- Enter an arrival procedure, or a descent waypoint altitude constraint, as early in the flight as possible.
- Prior to entry or deletion of TAI ON altitude, check that the cruise wind on PERF INIT page equals actual cruise wind. If not equal, enter actual wind direction and speed.

Administrative Information

Insert this bulletin behind the Operations Manual Bulletin Record page in Volume 1 of your Operations Manual. Amend the Operations Manual Bulletin Record to show bulletin TBC-50 "In Effect" (IE).

Please send all correspondence regarding Operations Manual Bulletins status to one of the following addresses:

Boeing Commercial Airplanes
Commercial Aviation Services
Attn: 767 Manager, Flight Technical Data
P.O. Box 3707, M/C 20-89
Seattle, Washington, 98124-2207 USA
Telephone: (206) 662-4000
Fax: (206) 662-4743

Intentionally
Blank



Flight Crew Operations Manual Bulletin for The Boeing Company

The Boeing Company
Seattle, Washington 98124-2207



Number: TBC-51

IssueDate: February 14, 2007

Airplane Effectivity: All Airplanes

Subject: Loss Of FMC Operation

Reason: This bulletin provides information informing flight crews of temporary recommended procedures for manually tuning the VOR/DME's.

Information in this bulletin is recommended by The Boeing Company, but may not be FAA approved at the time of writing. In the event of conflict with the FAA approved Airplane Flight Manual (AFM), the AFM shall supersede. The Boeing Company regards the information or procedures described herein as having a direct or indirect bearing on the safe operation of this model airplane.

THE FOLLOWING PROCEDURE AND/OR INFORMATION IS EFFECTIVE UPON RECEIPT

Background Information

During a recent Boeing flight test both FMC's shutdown after multiple resync attempts. It has been determined that this anomaly may occur with some FMC's when both VOR/DME control panels are operated in MAN. This condition is more likely to occur with a large number of navigation aids in the data base and when flight plan changes are being made through the CDU.

In the unlikely event this problem should occur, recovery of FMC operation can be accomplished only by returning at least one of the VOR/DME control panels to AUTO, and pulling both FMC-L and FMC-R circuit breakers for a minimum of 15 seconds before resetting.

Boeing Service Bulletin 767-34-0079 corrects this problem for Pratt and Whitney powered airplanes.

Boeing Service Bulletin 767-34-0103 corrects this problem for General Electric powered airplanes.

Operating Instructions

If it is desired to tune both VOR's manually during departure or enroute, at least one of the VOR's should be tuned remotely through the CDU, so that both AUTO/MANUAL Select Switches on the VOR/DME control panels are not in MAN at the same time.

The above recommendations also apply during approaches whenever practical, except for VOR approaches, where current procedures remain unchanged. For VOR approaches, the pilot flying should remain in MAP mode, if map data is acceptable. One pilot is required to display raw data by selecting VOR mode and manually tuning the VOR frequency. The other pilot should preselect the VOR frequency on his VOR/DME control panel and return to AUTO mode.

Administrative Information

Insert this bulletin behind the Operations Manual Bulletin Record page in Volume 1 of your Operations Manual. Amend the Operations Manual Bulletin Record to show bulletin TBC-51 "In Effect" (IE).

This Operations Manual Bulletin will be canceled after Boeing is notified that all affected airplanes in the operators fleet have been modified by Boeing Service Bulletin 767-34-0079 or 767-34-0103.

Please send all correspondence regarding Operations Manual Bulletins status to one of the following addresses:

Boeing Commercial Airplanes
Commercial Aviation Services
Attn: 767 Manager, Flight Technical Data
P.O. Box 3707, M/C 20-89
Seattle, Washington, 98124-2207 USA
Telephone: (206) 662-4000
Fax: (206) 662-4743



Flight Crew Operations Manual Bulletin for The Boeing Company

The Boeing Company
Seattle, Washington 98124-2207



Number: TBC-52

IssueDate: February 14, 2007

Airplane Effectivity: All Airplanes

Subject: VNAV PATH Altitude Overshoot

Reason: To inform crews that during climb the VNAV PATH mode can temporarily overshoot its programmed altitude.

Information in this bulletin is recommended by The Boeing Company, but may not be FAA approved at the time of writing. In the event of conflict with the FAA approved Airplane Flight Manual (AFM), the AFM shall supersede. The Boeing Company regards the information or procedures described herein as having a direct or indirect bearing on the safe operation of this model airplane.

THE FOLLOWING PROCEDURE AND/OR INFORMATION IS EFFECTIVE UPON RECEIPT

Background Information

Recent testing has shown that during VNAV climbs (using either flight director or autopilot), the VNAV PATH mode may temporarily overshoot the programmed altitude. This can occur during level offs at either waypoint altitude constraints or at the cruise altitude entered on the VNAV cruise page. Altitude overshoots of as much as 500 feet have been observed before the airplane returned to the programmed altitude.

These overshoots are caused by two factors:

- an unannounced internal FMC performance verification/update of the current VNAV descent path, or
- a flight crew execution of a FMC modification.

If either of these events happens at or near the altitude where the FMC transitions to VNAV PATH for the level off, mode transition to VNAV PATH is delayed, and the airplane will overshoot the programmed altitude by an amount proportional to the climb rate.

Setting the MCP altitude to each intermediate VNAV waypoint altitude constraint will assure that level offs below the final cruise altitude will occur using the ALT CAP mode, and the overshoot will not occur. However, the final VNAV cruise altitude is always captured in VNAV PATH, and the overshoot will be possible, even if the MCP altitude is set to the final cruise value.

This anomaly only occurs with the following FMCs installed:

- S242T102-226
- S242T102-330
- PS4052970-944

Operating Instructions

Avoid executing any FMC modifications when approaching either a waypoint altitude constraint or the final cruise altitude.

All intermediate waypoint altitude restrictions should be set on the MCP.

During all level offs in the VNAV PATH mode, be prepared to disconnect the autopilot/flight director and manually level the airplane as required.

Administrative Information

Insert this bulletin behind the Operations Manual Bulletin Record page in Volume 1 of your Operations Manual. Amend the Operations Manual Bulletin Record to show bulletin TBC-52 "In Effect" (IE).

This anomaly is corrected by Boeing Service Bulletin 767-34-0266 or 767-34-0267. Refer to individual Service Bulletin for applicability.

Please send all correspondence regarding Operations Manual Bulletins status to one of the following addresses:

Boeing Commercial Airplanes
Commercial Aviation Services
Attn: 767 Manager, Flight Technical Data
P.O. Box 3707, M/C 20-89
Seattle, Washington, 98124-2207 USA
Telephone: (206) 662-4000
Fax: (206) 662-4743



Flight Crew Operations Manual Bulletin for The Boeing Company

The Boeing Company
Seattle, Washington 98124-2207



Number: TBC-53

IssueDate: February 14, 2007

Airplane Effectivity: All Airplanes

Subject: Engine Inoperative FMC Data

Reason: This bulletin provides information informing flight crews of temporary recommended procedures for drift down subsequent engine out cruise for use with the FMC.

Information in this bulletin is recommended by The Boeing Company, but may not be FAA approved at the time of writing. In the event of conflict with the FAA approved Airplane Flight Manual (AFM), the AFM shall supersede. The Boeing Company regards the information or procedures described herein as having a direct or indirect bearing on the safe operation of this model airplane.

THE FOLLOWING PROCEDURE AND/OR INFORMATION IS EFFECTIVE UPON RECEIPT

Background Information

Some FMC operating programs do not provide accurate engine out performance data following engine shutdown. VNAV should not be used for driftdown and subsequent engine out cruise operation and flight planning with the following operating programs installed:

FMC OPERATING PROGRAM

| | |
|---------------|---------------|
| PS4038178-103 | PS4038178-130 |
| PS4038178-122 | PS4052520-121 |
| PS4038178-124 | PS4052520-122 |
| PS4038178-126 | PS4052520-130 |
| PS4038178-128 | PS4052520-131 |
| PS4038178-129 | |

Incorporation of Boeing Service Bulletin 767-34-0079 will correct this problem for Pratt and Whitney powered airplanes.

Incorporation of Boeing Service Bulletin 767-34-0103 will correct this problem for General Electric powered airplanes.

Operating Instructions

Following completion of the Engine Failure/Shutdown checklist, perform the following procedure in lieu of engine inoperative VNAV descent:

THRUST LEVER (Operating engine) ----- SET

Adjust thrust lever to obtain maximum continuous thrust.

IAS/MACH SELECTOR -----SET

Set airspeed to driftdown speed from QRH or other approved performance source.

ALTITUDE SELECTOR ----- SET

Set level off altitude using 1 Engine Inoperative Driftdown Speed/Level Off table, or the Altitude Capability LRC table in the QRH, or other approved performance source.

Allow the airspeed to bleed off to driftdown airspeed, then descend in FLCH at that speed until the rate of descent decreases to approximately 200 fpm. Use V/S to maintain this rate of descent to ensure altitude capture, then adjust thrust to maintain desired cruise speed. Do not use the FMC time or fuel predictions for flight planning. Use the Performance section of the Operations Manual, or other approved source for flight planning data.

Administrative Information

Insert this bulletin behind the Operations Manual Bulletin Record page in Volume 1 of your Operations Manual. Amend the Operations Manual Bulletin Record to show bulletin TBC-53 "In Effect" (IE).

This Operations Manual Bulletin will be canceled after Boeing is notified that all affected airplanes in the operators fleet have been modified by Boeing Service Bulletin 767-34-0079 or 767-34-0103. Refer to the individual Service Bulletin for applicability.

Please send all correspondence regarding Operations Manual Bulletins status to one of the following addresses:

Boeing Commercial Airplanes
Commercial Aviation Services
Attn: 767 Manager, Flight Technical Data
P.O. Box 3707, M/C 20-89
Seattle, Washington, 98124-2207 USA
Telephone: (206) 662-4000
Fax: (206) 662-4743



Flight Crew Operations Manual Bulletin for The Boeing Company

The Boeing Company
Seattle, Washington 98124-2207



Number: TBC-54

IssueDate: February 14, 2007

Airplane Effectivity: All Airplanes

Subject: EICAS Indication Of Impending Engine Fuel Filter Bypass

Reason: This bulletin informs flight crews of the requirement to check EICAS status messages for indication of impending engine fuel filter bypass.

Information in this bulletin is recommended by The Boeing Company, but may not be FAA approved at the time of writing. In the event of conflict with the FAA approved Airplane Flight Manual (AFM), the AFM shall supersede. The Boeing Company regards the information or procedures described herein as having a direct or indirect bearing on the safe operation of this model airplane.

THE FOLLOWING PROCEDURE AND/OR INFORMATION IS EFFECTIVE UPON RECEIPT

Background Information

Fuel contamination can lead to fuel starvation and engine power loss. Each engine fuel system is equipped with a filter to remove contaminants, and a pressure relief valve to allow bypass of an obstructed filter element. A pressure differential switch provides EICAS indication of filter element obstruction prior to pressure relief valve actuation and filter bypass.

Impending fuel filter bypass is indicated only by the EICAS message L or R ENG FUEL FILT. On some airplanes, the EICAS message is an advisory level, however, on other airplanes it is only a status level message. A recent finding by the US Federal Aviation Administration (FAA) determined a status level message does not provide appropriate indication of this condition. Until the updated EICAS computers are installed in all airplanes, FAA Airworthiness Directive AD 96-07-09 requires flight crews to check EICAS for the status message L or R ENG FUEL FILT. If other status level messages are observed as a consequence of complying with this Airworthiness Directive, the flight crew may deal with them in accordance with the appropriate operator policy.

This bulletin contains instructions for checking status messages.

Operating Instructions

If the L or R ENG FUEL FILT advisory message is displayed, refer to the Fuel Filter non-normal procedure in the QRH.

If the EICAS status cue is displayed any time after engine start, check the status display for the status message L or R ENG FUEL FILT. If a L or R ENG FUEL FILT status message is displayed, refer to the existing Engine Fuel Filter non-normal procedure in the QRH. Specific crew action in response to single or multiple L or R ENG FUEL FILT messages is not established by Boeing or the FAA. Any crew action is left up to the individual operator policy.

This requirement will remain in effect until updated EICAS computers are installed in all airplanes.

Boeing policy on flight crew use of status messages has not changed. After engine start, any condition having adverse effect on safe continuation of the flight, requiring crew attention, will appear as an EICAS alert message (warning, caution or advisory). Operators are encouraged to upgrade the EICAS computers in existing fleet airplanes.

Administrative Information

Insert this bulletin behind the Operations Manual Bulletin Record page in Volume 1 of your Operations Manual. Amend the Operations Manual Bulletin Record to show bulletin TBC-54 "In Effect" (IE).

The updated EICAS computers are available with Boeing Service Bulletin SB 767-31-0086 or SB 767-31-0091 or SB 767-31-0099 or SB 767-31-0100. Refer to the individual Service Bulletin for applicability.

This Operations Manual Bulletin will be canceled after Boeing is notified that all affected airplanes in the operators fleet have been modified.

Please send all correspondence regarding Operations Manual Bulletins status to one of the following addresses:

Boeing Commercial Airplanes
Commercial Aviation Services
Attn: 767 Manager, Flight Technical Data
P.O. Box 3707, M/C 20-89
Seattle, Washington, 98124-2207 USA
Telephone: (206) 662-4000
Fax: (206) 662-4743



Flight Crew Operations Manual Bulletin for The Boeing Company

The Boeing Company
Seattle, Washington 98124-2207



Number: TBC-55

IssueDate: February 14, 2007

Airplane Effectivity: All Airplanes

Subject: FMC Display of ATS Datalink Messages From Previous Flights

Reason: To inform flight crews of an FMC anomaly in which old datalink messages are displayed on the CDU.

Information in this bulletin is recommended by The Boeing Company, but may not be FAA approved at the time of writing. In the event of conflict with the FAA approved Airplane Flight Manual (AFM), the AFM shall supersede. The Boeing Company regards the information or procedures described herein as having a direct or indirect bearing on the safe operation of this model airplane.

THE FOLLOWING PROCEDURE AND/OR INFORMATION IS EFFECTIVE UPON RECEIPT

Background Information

An operator has reported occurrences of old Air Traffic Services (ATS) Datalink messages being displayed on the CDU. All reported events involve messages which were transmitted during the airplane's previous flight(s). For example, one crew reported being cleared to FL360 via an uplink "CLIMB TO AND MAINTAIN FL360, REPORT REACHING FL360." The flight crew left the xxxxZ ATC UPLINK page displayed on the CDU to report arrival at the new altitude. While approaching level-off, the crew noticed that the message text had changed to "CLIMB TO AND MAINTAIN FL350." They contacted ATC via HF and confirmed the original clearance. In another event, a crew noticed during preflight that all of the ATC messages on the previous flight were still displayed on the ATC LOG page.

The ATC log should automatically clear after each flight. This anomaly is allowing the old messages to remain in memory and to be displayed inappropriately.

This anomaly is only anticipated on airplanes that have:

- Pegasus 2002 FMC software or earlier and

- Operational Program Configuration (OPC) option for ATS Datalink is enabled

Note: A Boeing Maintenance Tip 767 MT 34-051 will be released recommending opening both FMC circuit breakers sometime prior to each flight and then resetting them after approximately ten seconds.

Operating Instructions

The following should be performed:

1. When each ATC uplink is received during flight, confirm that the uplink message text is similar to that expected and that the timestamp is within a few minutes of that expected. The timestamp is displayed in the respective uplink message page title (e.g. 1428Z ATC UPLINK). Timestamps can also be verified on the ATC LOG page.
2. If the message is left displayed on the CDU or re-displayed after the crew has responded to it, verify that the message and timestamp are unchanged and that the messages and timestamps displayed on the ATC LOG page are valid. If the message text or timestamps are incorrect, or any doubt exists regarding the integrity of the message, revert to voice procedures.

Example: ATC UPLINK page



Example: ATC LOG page

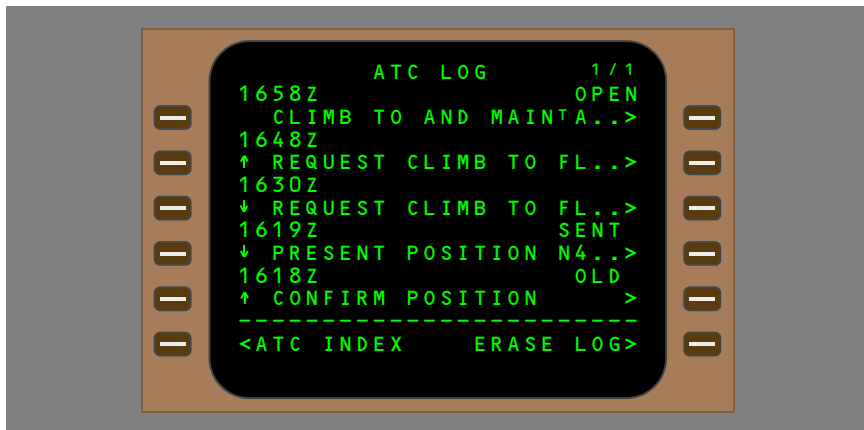

Administrative Information

Insert this bulletin behind the Operations Manual Bulletin Record page in Volume 1 of your Operations Manual. Amend the Operations Manual Bulletin Record to show bulletin TBC-55 "In Effect" (IE).

Pegasus 2003 FMC software will include a change to ensure that all ATS datalink messages from previous flights are erased. Boeing Service Bulletins 767-34-0389 and 767-34-0390 for upgrade to Pegasus 2003 FMC software are scheduled for release in February, 2004.

Please send all correspondence regarding Operations Manual Bulletins status to one of the following addresses:

Boeing Commercial Airplanes
Commercial Aviation Services
Attn: 767 Manager, Flight Technical Data
P.O. Box 3707, M/C 20-89
Seattle, Washington, 98124-2207 USA
Telephone: (206) 662-4000
Fax: (206) 662-4743

Intentionally
Blank



Flight Crew Operations Manual Bulletin for The Boeing Company

The Boeing Company
Seattle, Washington 98124-2207



Number: TBC-56

IssueDate: February 14, 2007

Airplane Effectivity: All Airplanes

Subject: Loss of Inertial Reference System (IRS) Input to RDMI/RMI During Standby Power Operation

Reason: To inform affected operators of RDMI/RMI inability to automatically select valid IRS heading data during standby power operation and provide temporary Quick Reference Handbook (QRH) replacement pages.

Information in this bulletin is recommended by The Boeing Company, but may not be FAA approved at the time of writing. In the event of conflict with the FAA approved Airplane Flight Manual (AFM), the AFM shall supersede. The Boeing Company regards the information or procedures described herein as having a direct or indirect bearing on the safe operation of this model airplane.

THE FOLLOWING PROCEDURE AND/OR INFORMATION IS EFFECTIVE UPON RECEIPT

Background Information

Boeing has discovered some airplanes received an incorrect wiring configuration, which affects Radio Distance Magnetic Indicator (RDMI/RMI) operation on standby power. The incorrect wiring exists only on airplanes with production installation of Hydraulic Driven Generator (HDG) wiring provisions. This Operations Manual Bulletin is not effective for airplanes with an HDG installed.

On airplanes without an HDG installed, failure of both engine Integrated Drive Generators (IDG) combined with an Auxiliary Power Unit (APU) or APU electrical generator failure results in the main battery providing the sole source of electrical power. The standby busses are powered from the main battery and are certified to provide a minimum of 30-minutes of power to essential equipment. On some airplane configurations with the main battery and APU battery paralleled, a minimum of 90-minutes of standby electrical power is available.

Normally, the right IRU provides heading data to the captain's RDMI/RMI resulting in proper compass card and VOR-bearing pointer operation. On HDG-equipped airplanes during HDG operation, the right IRU de-powers after a 5-minute time delay with the left and center IRUs continuously remaining powered. In addition, the source input to the captain's RDMI/RMI automatically switches to the center IRU, to sustain normal operation of the RDMI/RMI during HDG operation.

On airplanes with only HDG wiring provisions and without an HDG installed, automatic IRU source switching to the captain's RDMI/RMI is not provided during standby power operation. As a result, the captain's RDMI/RMI compass card "HDG" flag and the left VOR-bearing pointer flag will display due to the loss of valid IRU heading data.

Boeing is in the process of issuing a Service Bulletin to all operators with the incorrect wiring configuration. With the Service Bulletin incorporated on the affected airplanes, the captain's RDMI/RMI will be capable of automatic selection of valid IRS heading data during operation on standby power. As an alternative to retrofitting this Service Bulletin, operators can elect to retrofit an HDG as the existing IRU wiring configuration on the affected airplanes addressed by this Operations Manual Bulletin is compatible with an HDG-equipped airplane.

Operating Instructions

Remove and replace the applicable AC BUS OFF checklist in the QRH with the checklist provided by this Operations Manual Bulletin. The revised checklist includes a step to push the first officer's IRS instrument source select switch to the ALTN position. By accomplishing this additional step during execution of the AC BUS OFF checklist, the captain's RDMI/RMI compass card and left VOR bearing pointer will continue to operate normally.

Administrative Information

Insert this bulletin behind the Operations Manual Bulletin Record page in Volume 1 of your Operations Manual. Amend the Operations Manual Bulletin Record to show bulletin TBC-56 "Incorporated" (INC).

This anomaly is corrected by Boeing Service Bulletin 767-34-0433. This Operations Manual Bulletin will be canceled after Boeing is notified that all affected airplanes in the operator's fleet have been modified.

Please send all correspondence regarding Operations Manual Bulletins status to one of the following addresses:

Boeing Commercial Airplanes
Commercial Aviation Services
Attn: 767 Manager, Flight Technical Data
P.O. Box 3707, M/C 20-89
Seattle, Washington, 98124-2207 USA
Telephone: (206) 662-4000
Fax: (206) 662-4743

Intentionally
Blank



Flight Crew Operations Manual Bulletin for The Boeing Company

The Boeing Company
Seattle, Washington 98124-2207



Number: TBC-57

IssueDate: February 14, 2007

Airplane Effectivity: All Airplanes

Subject: Installation of Pratt & Whitney PW4000 Engines with Ring-Case Compressor (RCC)

Reason: To inform flight crews of operational effects of PW4000 engines equipped with Ring-Case Compressor (RCC) section.

Information in this bulletin is recommended by The Boeing Company, but may not be FAA approved at the time of writing. In the event of conflict with the FAA approved Airplane Flight Manual (AFM), the AFM shall supersede. The Boeing Company regards the information or procedures described herein as having a direct or indirect bearing on the safe operation of this model airplane.

THE FOLLOWING PROCEDURE AND/OR INFORMATION IS EFFECTIVE UPON RECEIPT

Background Information

Boeing and Pratt & Whitney are introducing the Ring-Case Compressor (RCC) modification to correct high power surge problems experienced with the PW4000 series engine. High power surging is the subject of Boeing Service Related Problem (SRP) 72-0024. The modification includes replacement of the basic segmented high-pressure compressor case with a new ring-style case designed to improve compressor blade tip clearance. Boeing estimates RCC-equipped engines will be intermixed with non-RCC engines in the 767 fleet for a period of four years.

Electronic Engine Control (EEC) software version SCN13 is required to optimize the engine operating characteristics of the new RCC design. The SCN13 EEC software incorporates new control logic that varies stator vane schedules and acceleration rates, but only when installed on an RCC-equipped engine. The new control logic will not be activated when SCN13 EEC software is installed on non-RCC engines and is not present in previous EEC software versions.

Due to the SCN13 EEC software control logic, noticeable differences in acceleration time between RCC and non-RCC engines can occur. Thrust asymmetry levels can be reached, which can create low airspeed directional control difficulties. However, the problem is only significant if engines are accelerated directly to the takeoff thrust setting from idle. Per the Boeing-recommended normal takeoff procedure, if engines are stabilized at approximately 1.10 EPR prior to setting takeoff thrust, asymmetry levels will be minimized and directional control problems avoided.

In addition, engines equipped with SCN13 EEC software installed exhibits reduced bleed air supply pressure. This reduction in bleed air pressure does not affect airplane systems operation with exception of responding to a forward or aft cargo compartment fire warning above 35,000 feet. If a cargo compartment fire warning occurs at airplane altitudes above 35,000 feet, the CARGO FIRE checklist contained in the QRH is revised by this Operations Manual Bulletin to include flight crew guidance to accomplish a descent to 35,000 feet or below. This will ensure sufficient bleed air supply to comply with cargo compartment smoke penetration requirements set forth under Federal Aviation Regulations.

Operating Instructions

Flight crews are reminded to follow the takeoff thrust setting practice contained in the normal Takeoff Procedure as published in Volume I of the Boeing 767 Operations Manual:

Advance thrust levers to approximately 1.10 EPR. Push EPR (THR, as installed) switch.

Stabilization at 1.10 EPR will minimize thrust asymmetry and directional control problems, which might occur during operation with an airplane intermix of RCC and non-RCC equipped engines.

Administrative Information

Insert this bulletin behind the Operations Manual Bulletin Record page in Volume 1 of your Operations Manual. Amend the Operations Manual Bulletin Record to show bulletin TBC-57 "Incorporated" (INC).

This Operations Manual Bulletin will be canceled upon operator notification of pure-fleet incorporation of Boeing Service Bulletin 767-71-0108.

Please send all correspondence regarding Operations Manual Bulletins status to one of the following addresses:

Boeing Commercial Airplanes
Commercial Aviation Services
Attn: 767 Manager, Flight Technical Data
P.O. Box 3707, M/C 20-89
Seattle, Washington, 98124-2207 USA
Telephone: (206) 662-4000
Fax: (206) 662-4743

Intentionally
Blank



Flight Crew Operations Manual Bulletin for The Boeing Company

The Boeing Company
Seattle, Washington 98124-2207



Number: TBC-58

IssueDate: February 14, 2007

Airplane Effectivity: All Airplanes

Subject: Pegasus Flight Management Computer (FMC) Lock-Up Anomaly Due to Data-Bus Communications Failure

Reason: To inform flight crews of a Pegasus-FMC anomaly resulting in the lock up of one or both FMCs and to provide temporary operating instructions for lock-up resolution.

Information in this bulletin is recommended by The Boeing Company, but may not be FAA approved at the time of writing. In the event of conflict with the FAA approved Airplane Flight Manual (AFM), the AFM shall supersede. The Boeing Company regards the information or procedures described herein as having a direct or indirect bearing on the safe operation of this model airplane.

THE FOLLOWING PROCEDURE AND/OR INFORMATION IS EFFECTIVE UPON RECEIPT

Background Information

Boeing has confirmed operator reports of in-service single and dual Pegasus-FMC lock-up events resulting from a data-bus communications anomaly. When the anomaly occurs, one or both FMCs may lock up preventing normal CDU access and control of the FMC(s). This lock-up anomaly and the information and recommended operating instructions contained in this Operations Manual Bulletin are only applicable to Pegasus-FMC software versions.

Operator reports indicate the most common lock-up event involves a single FMC; however, dual FMC lock-up events have also been reported. An FMC lock up is indicated by the continuous display of the "SINGLE FMC OPERATION" scratch-pad message with no response to CDU function or line-select keys and may be accompanied by display of the "L,R FMC FAIL" advisory-level EICAS alert message(s), illumination of the amber FAIL light on the CDU(s), and the amber "MAP" flag on the associated HSI display(s). In some cases, both FMCs may continue to operate normally, but no data communication or data comparison occurs between the master FMC and the spare FMC.

Honeywell is aware of this Pegasus-FMC anomaly. The planned fix to the problem is under investigation.

Operating Instructions

If the "SINGLE FMC OPERATION" scratch-pad message displays on the ground on either CDU, or both FMCs lock up as described above on the ground or in-flight, a single attempt at cycling both FMC circuit breakers can be accomplished, flight conditions permitting, as follows:

Note: If in-flight, Boeing recommends the following procedure be accomplished with an autopilot and the autothrottle engaged due to the requirement of a flight crew member leaving his/her station to achieve access to the overhead circuit breaker panel.

Do not use LNAV or VNAV while attempting the following procedure.

L "FMCS CMPTR" circuit breaker (Location E9) - - - - - .PULL

R "FMCS CMPTR" circuit breaker (Location E30) - - - - - PULL

Wait 20 seconds.

L "FMCS CMPTR" circuit breaker (Location E9) - - - - - PUSH

R "FMCS CMPTR" circuit breaker (Location E30) - - - - - PUSH

Wait until MENU page reappears with the "< FMC" prompt at line-select key 1L., then select the prompt by pushing line-select key 1L.

FMC ROUTE - - - - -ENTER

Begin route entry by re-entering ORIGIN airport identifier to ensure previous route is initially deleted.

FMC PERFORMANCE DATA - - - - -ENTER

If normal FMC operation is restored, LNAV and/or VNAV may be engaged, as needed.

The temporary procedural steps provided above should restore normal FMC operation; however, some FMC faults may preclude normal operation. If the above procedure does not restore normal FMC operation, DO NOT accomplish a second attempt as this may result in further systems' degradation.

If the "SINGLE FMC OPERATION" scratch-pad message displays during flight, accomplish the FMC FAIL checklist as published in the Boeing Quick Reference Handbook (QRH), or operator equivalent.

Accomplishing the checklist steps contained in the FMC FAIL checklist will configure the airplane systems for single FMC operation. For Pegasus-FMC equipped airplanes which interface with CDUs equipped with the "MENU" mode-select key, continued ETOPS operation should not be compromised due to the alternate navigation functionality.

Administrative Information

Insert this bulletin behind the Operations Manual Bulletin Record page in Volume 1 of your Operations Manual. Amend the Operations Manual Bulletin Record to show bulletin TBC-58 "In Effect" (IE).

This Operations Manual Bulletin will be revised to include service bulletin information when available.

Boeing Maintenance Tip 767 MT 34-047 is related to this Operations Manual Bulletin.

Please send all correspondence regarding Operations Manual Bulletins status to one of the following addresses:

Boeing Commercial Airplanes
Commercial Aviation Services
Attn: 767 Manager, Flight Technical Data
P.O. Box 3707, M/C 20-89
Seattle, Washington, 98124-2207 USA
Telephone: (206) 662-4000
Fax: (206) 662-4743

Intentionally
Blank



Flight Crew Operations Manual Bulletin for The Boeing Company

The Boeing Company
Seattle, Washington 98124-2207



Number: TBC-59

IssueDate: February 14, 2007

Airplane Effectivity: All Airplanes

Subject: Incorrect Turn Direction During a Standard Instrument Departure (SID)

Reason: To inform pilots of a Pegasus Flight Management Computer System anomaly.

Information in this bulletin is recommended by The Boeing Company, but may not be FAA approved at the time of writing. In the event of conflict with the FAA approved Airplane Flight Manual (AFM), the AFM shall supersede. The Boeing Company regards the information or procedures described herein as having a direct or indirect bearing on the safe operation of this model airplane.

THE FOLLOWING PROCEDURE AND/OR INFORMATION IS EFFECTIVE UPON RECEIPT

Background Information

An operator has reported cases of the Pegasus-FMC commanding a turn opposite to that expected and displayed on the map during a SID. Each of the reported occurrences involves a SID with a course reversal shortly after takeoff. In these cases, a right turn was correctly displayed on the map but the FMC commanded a left turn when certain criteria existed. Specifically, when the airplane has a steep initial climb, the airplane may reach an altitude constraint with the airplane in a position to immediately sequence the next leg. For example, many SIDs are coded with an initial "runway heading" leg (VA leg type) that climbs to a specified altitude. In some procedures, the SID also has a "heading to an intercept" leg (VI leg type) with an associated turn direction following the VA leg.

When this anomaly occurs, the airplane may reach the specified altitude in a position to immediately sequence the next (VI) leg. Should this simultaneous sequence occur, the VI leg with the turn direction is no longer in the route. Since the turn direction is no longer in the route, the FMC will revert to normal turn logic and command a turn in the shortest direction to the new course. The shortest turn direction may be in the opposite direction from that depicted for the departure. When this anomaly occurs, the map will continue to display the correct magenta path but the airplane may turn in the opposite direction.

The only reported occurrence of this anomaly has been on the RW34 departures at Fukuoka, Japan. However, the software anomaly could cause a similar problem at other airports.

The information and operating instructions contained in this Flight Crew Operations Manual Bulletin are only applicable to Pegasus-FMC software versions.

Operating Instructions

During a SID, should the FD or autopilot begin a turn opposite to that displayed on the map or described in the SID description, use HDG SEL to fly the correct chart course to complete the turn in the correct direction. Following completion of the turn, LNAV may be re-engaged and FD guidance may be followed or the autopilot may be engaged normally.

Administrative Information

Insert this bulletin behind the Operations Manual Bulletin Record page in Volume 1 of your Operations Manual. Amend the Operations Manual Bulletin Record to show bulletin TBC-59 "In Effect" (IE).

This anomaly is corrected by Boeing Service Bulletin 767-34-0471. This Flight Crew Operations Manual Bulletin will be canceled after Boeing is notified that all affected airplanes in the operator's fleet have been modified.

Please send all correspondence regarding Operations Manual Bulletins status to one of the following addresses:

Boeing Commercial Airplanes
Commercial Aviation Services
Attn: 767 Manager, Flight Technical Data
P.O. Box 3707, M/C 20-89
Seattle, Washington, 98124-2207 USA
Telephone: (206) 662-4000
Fax: (206) 662-4743



Flight Crew Operations Manual Bulletin for The Boeing Company

The Boeing Company
Seattle, Washington 98124-2207



Number: TBC-61

IssueDate: February 14, 2007

Airplane Effectivity: All Airplanes

Subject: Performance Predictions Anomaly in Flight Management Computer (FMC) Product Improvement Package (PIP) and Pegasus Software Versions

Reason: To inform flight crews of a performance prediction anomaly on FMC-PIP and Pegasus-FMC software versions.

Information in this bulletin is recommended by The Boeing Company, but may not be FAA approved at the time of writing. In the event of conflict with the FAA approved Airplane Flight Manual (AFM), the AFM shall supersede. The Boeing Company regards the information or procedures described herein as having a direct or indirect bearing on the safe operation of this model airplane.

THE FOLLOWING PROCEDURE AND/OR INFORMATION IS EFFECTIVE UPON RECEIPT

Background Information

Boeing has confirmed operator reports regarding erroneous performance predictions following execution of the ABEAM PTS function on the LEGS page of the FMC-Product Improvement Package (PIP) and Pegasus-FMC software versions. When OAT values have been previously entered in the ALT/OAT field of line-select key 5R on a waypoint WIND page, and the ABEAM PTS function is subsequently selected after a "direct-to" flight plan modification, the OAT value on the WIND page erroneously changes to 0-degrees. After execution, fuel predictions are erroneously recalculated based upon 0-degrees instead of the previously entered value for the respective cruise altitude. Operators have reported display of the INSUFFICIENT FUEL alert-level scratch pad message with the fuel prediction values being much lower than originally planned. Additionally, there are no flight deck annunciations or alerts to indicate an OAT value on the WIND page has erroneously changed.

This Flight Crew Operations Manual Bulletin is only applicable to the FMC-Product Improvement Package (PIP) and Pegasus-FMC software versions. Previous FMC software versions do not include the ABEAM PTS function, the ALT/OAT field entry, or individual waypoint WIND pages, and therefore, are not affected.

Operating Instructions

Following selection and prior to executing the ABEAM PTS function, verify the OAT value on the respective WIND page. If necessary, enter the airplane altitude and the indicated Static Air Temperature (SAT) value from PROGRESS page 2 into the ALT/OAT field for the next route waypoint. This OAT entry will propagate to all down-track waypoints. Following entry of the SAT value into the ALT/OAT field and execution of the route modification, the FMC fuel predictions should be near those obtained from the flight plan.

Administrative Information

Insert this bulletin behind the Operations Manual Bulletin Record page in Volume 1 of your Operations Manual. Amend the Operations Manual Bulletin Record to show bulletin TBC-61 "In Effect" (IE).

The corrective action for the anomaly described in this Flight Crew Operations Manual Bulletin is still under investigation. This bulletin will be revised to include Service Bulletin information when available.

Please send all correspondence regarding Operations Manual Bulletins status to one of the following addresses:

Boeing Commercial Airplanes
Commercial Aviation Services
Attn: 767 Manager, Flight Technical Data
P.O. Box 3707, M/C 20-89
Seattle, Washington, 98124-2207 USA
Telephone: (206) 662-4000
Fax: (206) 662-4743



Flight Crew Operations Manual Bulletin for The Boeing Company

The Boeing Company
Seattle, Washington 98124-2207



Number: TBC-62

IssueDate: February 14, 2007

Airplane Effectivity: All Airplanes

Subject: Center Tank Fuel Pump Automatic Power Removal System

Reason: To provide information and operating instructions regarding installation of the Center Tank Fuel Pump Automatic Power Removal System.

Information in this bulletin is recommended by The Boeing Company, but may not be FAA approved at the time of writing. In the event of conflict with the FAA approved Airplane Flight Manual (AFM), the AFM shall supersede. The Boeing Company regards the information or procedures described herein as having a direct or indirect bearing on the safe operation of this model airplane.

THE FOLLOWING PROCEDURE AND/OR INFORMATION IS EFFECTIVE UPON RECEIPT

Background Information

An automatic power removal system is installed on each center tank fuel pump. This system is being installed to preclude continued center tank fuel pump operation after center tank fuel is depleted. The system is intended to serve as a supplementary means to the flight crew procedural action of removing power from the fuel pumps by selecting the center tank fuel pump switches off when the EICAS advisory-level CTR L,R FUEL PUMP alert messages show. The automatic power removal system is installed to meet requirements contained in Special Federal Aviation Regulation (SFAR) 88.

Center tank fuel depletion at each center fuel pump is detected by a fuel pressure sensor located at each pump. Approximately 10-seconds after steady-state low fuel pump pressure is detected at a fuel pump, the respective advisory-level CTR L,R FUEL PUMP message shows on EICAS. Steady-state low fuel pump pressure is indicated by continuous illumination of the amber PRESS light in the respective center fuel pump switch located on the overhead panel. Several seconds after the respective EICAS message shows, power is automatically removed from the fuel pump. Therefore, operation of the automatic power removal system is transparent to the flight crew and is provided as a supplementary means to ensure continued center tank fuel pump operation is terminated.

On airplanes equipped with the fuel jettison system, the automatic power removal system is inhibited during fuel jettison operation. All center tank fuel pumps associated with fuel jettison operation will continue to operate whenever the Fuel Jettison selector is positioned ON.

Operating Instructions

The normal procedures contained in Volume I and the fuel pump system description contained in Volume II of the Flight Crew Operations Manual (FCOM) are slightly modified to accommodate the installation of the center tank fuel pump automatic power removal system. The specific Volume I normal procedures modifications include:

1. Verifying that the amber PRESS light illuminates and the CTR L FUEL PUMP and CTR R FUEL PUMP messages show on EICAS after selecting each center tank fuel pump switch on during the Before Start procedure.

Verifying that both PRESS lights illuminate and the CTR L FUEL PUMP and CTR R FUEL PUMP messages show before engine start ensures the fuel pump pressure sensors are operating normally; and,

2. Selecting both center tank fuel pump switches off when either CTR L FUEL PUMP or CTR R FUEL PUMP message shows on EICAS and the center tank is empty. If center tank usable fuel is indicated when either message shows, the respective center fuel pump switch is selected off while the remaining center fuel pump switch stays on to allow for continued center tank fuel consumption. Also, during cruise flight with both center tank fuel pump switches off, whenever center tank usable fuel is indicated, both center tank fuel pump switches may be reselected on.

The center fuel tank totalizer is calibrated to indicate zero quantity when a CTR L,R FUEL PUMP message shows; however, at some airplane pitch attitudes, a center tank usable fuel quantity may be indicated, such as dispatch operations with a center tank fuel load which will deplete during the takeoff or initial climb flight phase.

As a reminder, if the flight crew observes either the CTR L FUEL PUMP or CTR R FUEL PUMP message showing on EICAS with an appreciable center tank fuel quantity indicated, a fuel pump failure should be assumed, and the FUEL PUMP non-normal checklist contained in the Quick Reference Handbook (QRH), or operator equivalent, should be accomplished.

The normal procedures provided in this FCOMB are also compatible with airplanes modified by Service Bulletin 767-28-0062 but not modified with the automatic power removal system. Therefore, operators with a fleet configuration of which all airplanes have been modified by Service Bulletin 767-28-0062 may desire to use the procedures provided by this FCOMB regardless of the installation status of the automatic power removal system.

IMPORTANT: Airplanes not modified by Service Bulletin 767-28-0062, or production equivalent, are subject to the operating mandates of FAA Airworthiness Directive (AD) 2001-15-08, which is the subject of Flight Crew Operations Manual Bulletin (FCOMB), Subject: "Center Tank Fuel Pumps." Boeing is currently in the process of requesting FAA Alternative Method of Compliance (AMOC) approval to allow consideration of the 767 Center Tank Fuel Pump Automatic Power Removal system as providing equivalent compliance to the operational restrictions published in AD 2001-15-08. If the Boeing-requested AMOC is approved, then the service bulletin retrofit installation of the automatic power removal system will allow affected operators to use the procedures contained in this FCOMB instead of those mandated under AD 2001-15-08. However until FAA response to this Boeing AMOC request is determined, airplanes not modified with Service Bulletin 767-28-0062, or production equivalent, must remain in compliance with AD 2001-15-08, or the airplane country of registry's regulatory equivalent. This FCOMB will be revised accordingly when FAA response to the Boeing AMOC request has been determined.

For future planning purposes, operators are advised that Boeing is expecting eventual FAA AD issuance mandating the retrofit installation of the automatic power removal system.

Administrative Information

Insert this bulletin behind the Operations Manual Bulletin Record page in Volume 1 of your Operations Manual. Amend the Operations Manual Bulletin Record to show bulletin TBC-62 "Incorporated" (INC).

This Flight Crew Operations Manual Bulletin will remain in effect until the next FCOM scheduled revision to provide operators ample time to file the replacement FCOM pages contained herein.

Please send all correspondence regarding Operations Manual Bulletins status to one of the following addresses:

Boeing Commercial Airplanes
Commercial Aviation Services
Attn: 767 Manager, Flight Technical Data
P.O. Box 3707, M/C 20-89
Seattle, Washington, 98124-2207 USA
Telephone: (206) 662-4000
Fax: (206) 662-4743

Intentionally
Blank



Flight Crew Operations Manual Bulletin for The Boeing Company

The Boeing Company
Seattle, Washington 98124-2207



Number: TBC-63

IssueDate: February 14, 2007

Airplane Effectivity: All Airplanes

Subject: Pegasus Flight Management Computer (FMC) Departure Routing Anomaly

Reason: To inform flight crews of a Pegasus-FMC anomaly regarding route discontinuity removal between a selected departure and the active route.

Information in this bulletin is recommended by The Boeing Company, but may not be FAA approved at the time of writing. In the event of conflict with the FAA approved Airplane Flight Manual (AFM), the AFM shall supersede. The Boeing Company regards the information or procedures described herein as having a direct or indirect bearing on the safe operation of this model airplane.

THE FOLLOWING PROCEDURE AND/OR INFORMATION IS EFFECTIVE UPON RECEIPT

Background Information

Boeing has confirmed operator reports of a Pegasus-FMC anomaly related to removal of a route discontinuity between a selected departure and the active route. Boeing engineering has confirmed this software anomaly may occur if a route discontinuity is removed using the RTE page 2 instead of using the RTE LEGS page. Some operator reports indicate the waypoint identifier disappears from the scratch pad when line-selected into the discontinuity boxes, but the RTE page title never indicates the route modification, hence the entry attempt is not successful. And in some cases, a subsequent FMC lockup may result.

Honeywell is aware of this Pegasus-FMC anomaly. The planned fix to the problem is under investigation.

Operating Instructions

To prevent the occurrence of this anomaly, removal of route discontinuities between a selected departure and the active route using the RTE LEGS page instead of RTE page 2 is recommended.

Administrative Information

Insert this bulletin behind the Operations Manual Bulletin Record page in Volume 1 of your Operations Manual. Amend the Operations Manual Bulletin Record to show bulletin TBC-63 "In Effect" (IE).

This Flight Crew Operations Manual Bulletin will be revised to include service bulletin information when available.

Please send all correspondence regarding Operations Manual Bulletins status to one of the following addresses:

Boeing Commercial Airplanes
Commercial Aviation Services
Attn: 767 Manager, Flight Technical Data
P.O. Box 3707, M/C 20-89
Seattle, Washington, 98124-2207 USA
Telephone: (206) 662-4000
Fax: (206) 662-4743



Flight Crew Operations Manual Bulletin for The Boeing Company

The Boeing Company
Seattle, Washington 98124-2207



Number: TBC-64

IssueDate: February 14, 2007

Airplane Effectivity: All Airplanes

Subject: Uncommanded Auxiliary Power Unit (APU) Shutdown Prior to Engine Start

Reason: To inform flight crews of an uncommanded APU shutdown fault prior to engine start and provide temporary operating instructions.

Information in this bulletin is recommended by The Boeing Company, but may not be FAA approved at the time of writing. In the event of conflict with the FAA approved Airplane Flight Manual (AFM), the AFM shall supersede. The Boeing Company regards the information or procedures described herein as having a direct or indirect bearing on the safe operation of this model airplane.

THE FOLLOWING PROCEDURE AND/OR INFORMATION IS EFFECTIVE UPON RECEIPT

Background Information

Boeing has received operator reports of a fault pertaining to an uncommanded Auxiliary Power Unit (APU) shutdown on the ground prior to engine start. Boeing has confirmed the shutdown fault occurs randomly and is a result of pneumatic air reverse flow when either or both Pack Control Selectors are positioned OFF. The uncommanded APU shutdown occurs when the APU Electronic Control Unit (ECU) is unable to compensate for the pneumatic pressure pulse when either or both pack control valve(s) close. Boeing has confirmed the shutdown fault may occur under the following conditions:

- Both engines shutdown;
- APU running;
- APU Bleed Air switch ON; and,
- A Pack Control selector positioned OFF.

Therefore, flight crew recognition of this fault is primarily noticeable when accomplishing the normal “Before Engine Start” procedure after positioning the Pack Control Selectors OFF in preparation for the initial engine start. If the fault is active and an uncommanded APU shutdown occurs, the APU can be restarted without delay without any required time consideration for cool down.

Boeing has confirmed the fault can only occur upon positioning either or both Pack Control Selectors OFF with the APU as the sole source of pneumatic power. Therefore, exposure to the fault described above is isolated to ground operations and specific to APU bleed air supply for initial engine start.

Operating Instructions

For operators experiencing in-service interruption due to uncommanded APU shutdown prior to engine start, the following temporary operating instructions are recommended:

Prior to positioning the Pack Control Selectors OFF when accomplishing the “Before Start Procedure”, select the APU Bleed Air switch OFF and allow the APU Bleed Air VALVE transition light to momentarily illuminate and extinguish. Then, position the left and right Pack Control Selectors OFF and allow the PACK OFF lights to illuminate. Finally, select the APU Bleed Air switch ON to restore pneumatic air to each engine’s starter, and accomplish a normal engine start.

Administrative Information

Insert this bulletin behind the Operations Manual Bulletin Record page in Volume 1 of your Operations Manual. Amend the Operations Manual Bulletin Record to show bulletin TBC-64 "In Effect" (IE).

This Flight Crew Operations Manual Bulletin will be revised to include service bulletin information when available.

Please send all correspondence regarding Operations Manual Bulletins status to one of the following addresses:

Boeing Commercial Airplanes
Commercial Aviation Services
Attn: 767 Manager, Flight Technical Data
P.O. Box 3707, M/C 20-89
Seattle, Washington, 98124-2207 USA
Telephone: (206) 662-4000
Fax: (206) 662-4743



Flight Crew Operations Manual Bulletin for The Boeing Company

The Boeing Company
Seattle, Washington 98124-2207



Number: TBC-65

IssueDate: February 14, 2007

Airplane Effectivity: All Airplanes

Subject: Pegasus-FMC Control and Display Unit (CDU) Anomaly

Reason: To inform flight crews of a Pegasus-FMC CDU anomaly and associated corrective actions.

Information in this bulletin is recommended by The Boeing Company, but may not be FAA approved at the time of writing. In the event of conflict with the FAA approved Airplane Flight Manual (AFM), the AFM shall supersede. The Boeing Company regards the information or procedures described herein as having a direct or indirect bearing on the safe operation of this model airplane.

THE FOLLOWING PROCEDURE AND/OR INFORMATION IS EFFECTIVE UPON RECEIPT

Background Information

An anomaly has been discovered, which may cause a CDU keyboard to not respond to any CDU function and mode key selections with the exception of the “MENU” function and mode key. This CDU anomaly may cause a CDU to reset to a non-responsive state following one or multiple power transfers. This could occur during a normal engine start sequence or at any time power transfers from one generator source to another. This anomaly occurs only during CDU resets after power interrupts.

This anomaly appears on airplanes with the PEGASUS FMC installed. The PEGASUS FMC can be identified by a “VNAV” mode key on the CDU.

Operations Manual Information

There are two flight crew actions, either of which return the CDU to normal operation in the event a CDU does not respond to function and mode key selections. They are:

1. Push the “MENU” key on the affected CDU keyboard. This action will display the MENU page with the FMC prompt at line-select key 1L. Then, push line-select key 1L.

Or,

2. Rotate the Nav Instrument Source Selector on the affected side to the offside FMC detent, then return the selector to the respective FMC position.

Administrative Information

Insert this bulletin behind the Operations Manual Bulletin Record page in Volume 1 of your Operations Manual. Amend the Operations Manual Bulletin Record to show bulletin TBC-65 "In Effect" (IE).

This anomaly is corrected by Boeing Service Bulletin 767-34-0295.

Please send all correspondence regarding Operations Manual Bulletins status to one of the following addresses:

Boeing Commercial Airplanes

Commercial Aviation Services

Attn: 767 Manager, Flight Technical Data

P.O. Box 3707, M/C 20-89

Seattle, Washington, 98124-2207 USA

Telephone: (206) 662-4000

Fax: (206) 662-4743



Flight Crew Operations Manual Bulletin for The Boeing Company

The Boeing Company
Seattle, Washington 98124-2207



Number: TBC-66

IssueDate: May 1, 2007

Airplane Effectivity: All Airplanes

Subject: Auxiliary Power Unit (APU) Bleed Air Supply Fault

Reason: To advise flight crews of an APU bleed air supply fault and provide temporary operating instructions.

Information in this bulletin is recommended by The Boeing Company, but may not be FAA approved at the time of writing. In the event of conflict with the FAA approved Airplane Flight Manual (AFM), the AFM shall supersede. The Boeing Company regards the information or procedures described herein as having a direct or indirect bearing on the safe operation of this model airplane.

THE FOLLOWING PROCEDURE AND/OR INFORMATION IS EFFECTIVE UPON RECEIPT

Background Information

Boeing has received operator reports of a fault pertaining to 767-400ER Auxiliary Power Unit (APU) bleed air supply. Boeing has confirmed the fault occurs randomly and may result in uncommanded closure of the APU bleed air valve due to incorrect signal-timing between the Cabin Temperature Controller (CTC) and the APU Electronic Control Unit (ECU) when either or both Pack Control Selectors are positioned OFF. The uncommanded APU bleed air valve closure results in a loss of pneumatic air to the using systems. Boeing has confirmed the signal-timing fault may occur under the following conditions:

- Both engines shutdown;
- APU running;
- APU Bleed Air switch ON; and,
- A Pack Control selector positioned OFF.

Therefore, flight crew recognition of this fault is primarily noticeable when accomplishing the normal “Before Engine Start” procedure after positioning the Pack Control Selectors OFF in preparation for the initial engine start. If the fault is active, bleed air supply will deplete resulting in inability to start engines and requiring a full APU shutdown and restart to restore normal APU bleed air valve operation.

Boeing has confirmed the fault can only occur upon positioning either or both Pack Control Selectors OFF with the APU as the sole source of pneumatic power. Therefore, exposure to the fault described above is isolated to ground operations and specific to APU bleed air supply for initial engine start.

In addition, Boeing has confirmed the fault cannot occur during an in-flight engine start attempt using the APU for pneumatic starter assist.

Operating Instructions

To preclude exposure to the fault described above, accomplish the following Before Start Procedure revision when attempting the initial engine start:

Prior to positioning the Pack Control Selectors OFF when accomplishing the “Before Start Procedure”, select the APU Bleed Air switch OFF and allow the APU Bleed Air VALVE transition light to momentarily illuminate and extinguish. Then, position the left and right Pack Control Selectors OFF. Finally, select the APU Bleed Air switch ON to restore pneumatic air to each engine’s starter, and accomplish a normal engine start.

Flight crews are reminded that with the APU running, if either or both Pack Control Selectors are positioned OFF with APU Bleed Air valve open, the APU bleed air supply fault described above may occur. Normal APU Bleed Air valve operation is only restored by accomplishing a full APU shutdown and restart.

Administrative Information

Insert this bulletin behind the Operations Manual Bulletin Record page in Volume 1 of your Operations Manual. Amend the Operations Manual Bulletin Record to show bulletin TBC-66 "In Effect" (IE).

This anomaly is corrected by Boeing Service Bulletin 767-21-0190. This Flight Crew Operations Manual Bulletin will be canceled after Boeing is notified that all affected airplanes in the operator’s fleet have been modified.

Please send all correspondence regarding Operations Manual Bulletins status to one of the following addresses:

Boeing Commercial Airplanes
Commercial Aviation Services
Attn: 767 Manager, Flight Technical Data
P.O. Box 3707, M/C 20-89
Seattle, Washington, 98124-2207 USA
Telephone: (206) 662-4000
Fax: (206) 662-4743

Intentionally
Blank



Flight Crew Operations Manual Bulletin for The Boeing Company

The Boeing Company
Seattle, Washington 98124-2207



Number: TBC-67

IssueDate: May 1, 2007

Airplane Effectivity: All Airplanes

Subject: B/E Aerospace 174660-N3 Crew Oxygen Mask

Reason: To inform flight crews of the proper donning and stowage procedures for the B/E Aerospace 174660-N3 Crew Oxygen Mask.

Information in this bulletin is recommended by The Boeing Company, but may not be FAA approved at the time of writing. In the event of conflict with the FAA approved Airplane Flight Manual (AFM), the AFM shall supersede. The Boeing Company regards the information or procedures described herein as having a direct or indirect bearing on the safe operation of this model airplane.

THE FOLLOWING PROCEDURE AND/OR INFORMATION IS EFFECTIVE UPON RECEIPT

Background Information

During the certification test for the B/E Aerospace 174660-N3 Crew Oxygen Mask, it was determined that specific donning and stowage procedures were required.

Improper stowage of the mask could result in the harness not properly inflating during the subsequent use of the mask. Improper inflation could delay the donning of the mask, thereby, creating an unsafe condition.

It was determined that a stowage procedure for this specific mask was required to ensure the mask properly inflates when donned by flight crews.

Donning and stowage procedures will be incorporated into the Operations Manual at a future revision.

Operations Manual Information

Donning Procedure for the B/E Aerospace 174660-N3 Crew Oxygen Mask:

1. Grasp the regulator with the hand nearest the stowage box.
2. Pull upward to expose the entire regulator and inflation lever.

3. Re-grip the regulator and squeeze the inflation lever while pulling the mask from the stowage box.
4. Pull the mask across in front of you, toward the center of the aircraft (to ensure ample hose extension) while rolling the mask face-up.
5. Leaning slightly toward the center of the aircraft, place your face into the mask. Bring the mask toward your face so that the lower portion of the mask contacts your chin first, then roll the top of the mask toward your forehead so the harness goes over and behind your head.
6. Release the inflation lever so the harness holds the mask in place.

Stowage Procedure for the B/E Aerospace 174660-N3 Crew Oxygen Mask:

1. Set the regulator to the 100% position.
2. Ensure that the cloth liner is secured at the top of the stowage box and is laying flat against all interior sides of the box.
3. Coil the supply hose into the bottom of the stowage box, making the largest diameter possible.
4. Ensure that the harness is completely deflated.
5. Hold the mask by the regulator with the face piece down and the inside of the mask toward you. Ensure the regulator inlet hose rotates freely.
6. Grasp the harness “cross”; pull it towards the top of the face piece (down) and tightly roll the mask around it. Allow the excess harness to hang down from the top of the rolled face piece.

CAUTION: Do not push the harness “cross” into or behind the nose piece. Doing this may cause the cross straps to hang up on the mask during inflation.

7. Position the supply hose along the side of the rolled face piece toward the aft-inboard corner of the Captain’s mask stowage box and toward the aft-inboard corner of the First Officer’s mask stowage box.
8. Insert the mask-regulator assembly into the stowage box, beginning with the harness (regulator up).
9. Press down on the mask-regulator until all but the regulator control knob is below the top surface of the stowage box.
10. Close the right-hand door, then close the left-hand door, using caution not to pinch the supply hose. The “OXY ON” flag will be visible on the door.
11. Depress the TEST/RESET lever on the right-hand door and release.
12. The “OXY ON” flag disappears when the TEST/RESET lever is released.

**WARNING: Do not push the red Release Levers on the regulator.
Doing this will inflate the harness and prevent the correct
stowage of the mask regulator.**

Administrative Information

Insert this bulletin behind the Operations Manual Bulletin Record page in Volume 1 of your Operations Manual. Amend the Operations Manual Bulletin Record to show bulletin TBC-67 "In Effect" (IE).

This Operations Manual Bulletin will be cancelled in a future revision to the Operations Manual.

Please send all correspondence regarding Operations Manual Bulletins status to one of the following addresses:

Boeing Commercial Airplanes
Commercial Aviation Services
Attn: 767 Manager, Flight Technical Data
P.O. Box 3707, M/C 20-89
Seattle, Washington, 98124-2207 USA
Telephone: (206) 662-4000
Fax: (206) 662-4743

**Intentionally
Blank**



Flight Crew Operations Manual Bulletin for The Boeing Company

The Boeing Company
Seattle, Washington 98124-2207



Number: TBC-68

IssueDate: May 1, 2007

Airplane Effectivity: All Airplanes

Subject: B/E Aerospace 174692-N7 Crew Oxygen Mask

Reason: To inform flight crews of the proper donning and stowage procedures for the B/E Aerospace 174692-N7 Crew Oxygen Mask.

Information in this bulletin is recommended by The Boeing Company, but may not be FAA approved at the time of writing. In the event of conflict with the FAA approved Airplane Flight Manual (AFM), the AFM shall supersede. The Boeing Company regards the information or procedures described herein as having a direct or indirect bearing on the safe operation of this model airplane.

THE FOLLOWING PROCEDURE AND/OR INFORMATION IS EFFECTIVE UPON RECEIPT

Background Information

During the certification test for the B/E Aerospace 174692-N7 Crew Oxygen Mask, it was determined that specific donning and stowage procedures were required.

Improper stowage of the mask could result in the harness not properly inflating during the subsequent use of the mask. Improper inflation could delay the donning of the mask, thereby, creating an unsafe condition.

It was determined that a stowage procedure for this specific mask was required to ensure the mask properly inflates when donned by flight crews.

Donning and stowage procedures will be incorporated into the Operations Manual at a future revision.

Operations Manual Information

Donning Procedure for the B/E Aerospace 174692-N7 Crew Oxygen Mask:

1. Grasp the regulator with the hand nearest the stowage box.
2. Pull up and squeeze the inflation levers while pulling the mask from the stowage box.

3. Pull the mask across in front of you, toward the center of the aircraft (to ensure ample hose extension) while rolling the mask face-up
4. Pull the mask across in front of you, toward the center of the aircraft (to ensure ample hose extension) while rolling the mask face-up.
5. Leaning slightly toward the center of the aircraft, place your face into the mask. Bring the mask toward your face so that the lower portion of the mask contacts your chin first, then roll the top of the mask toward your forehead so the harness goes over and behind your head.
6. Release the inflation lever so the harness holds the mask in place.

Stowage Procedure for the B/E Aerospace 174660-N3 Crew Oxygen Mask:

1. Set the regulator to the 100% position.
2. Ensure that the cloth liner is secured at the top of the stowage box and is laying flat against all interior sides of the box.
3. Coil the supply hose into the bottom of the stowage box, making the largest diameter possible.
4. Ensure that the harness is completely deflated.
5. Hold the mask by the regulator with the face piece down and the inside of the mask toward you. Ensure the regulator inlet hose rotates freely.

CAUTION: Do not push the harness “cross” into or behind the nose piece. Doing this may cause the cross straps to hang up on the mask during inflation.

6. Grasp the harness “cross”; pull it towards the top of the face piece (down) and tightly roll the mask around it. Allow the excess harness to hang down from the top of the rolled face piece.
7. Position the supply hose along the side of the rolled face piece toward the aft- inboard corner of the Captain’s mask stowage box and toward the aft-inboard corner of the First Officer’s mask stowage box.
8. Insert the mask-regulator assembly into the stowage box, beginning with the harness (regulator up).
9. Press down on the mask-regulator until all but the regulator control knob is below the top surface of the stowage box.
10. Close the right-hand door, then close the left-hand door, using caution not to pinch the supply hose. The “OXY ON” flag will be visible on the door.

**WARNING: Do not push the red Release Levers on the regulator.
Doing this will inflate the harness and prevent the correct
stowage of the mask regulator.**

11. Depress the TEST/RESET lever on the right-hand door and release.
12. The "OXY ON" flag disappears when the TEST/RESET lever is released.

Administrative Information

Insert this bulletin behind the Operations Manual Bulletin Record page in Volume 1 of your Operations Manual. Amend the Operations Manual Bulletin Record to show bulletin TBC-68 "In Effect" (IE).

This Operations Manual Bulletin will be cancelled in a future revision to the Operations Manual.

Please send all correspondence regarding Operations Manual Bulletins status to one of the following addresses:

Boeing Commercial Airplanes
Commercial Aviation Services
Attn: 767 Manager, Flight Technical Data
P.O. Box 3707, M/C 20-89
Seattle, Washington, 98124-2207 USA
Telephone: (206) 662-4000
Fax: (206) 662-4743

**Intentionally
Blank**



Flight Crew Operations Manual Bulletin for The Boeing Company

The Boeing Company
Seattle, Washington 98124-2207



Number: TBC-70

IssueDate: May 1, 2007

Airplane Effectivity: All Airplanes

Subject: Integrated Standby Flight Display (ISFD) Initialization Anomaly

Reason: To inform flight crews of an ISFD initialization anomaly and provide corrective action.

Information in this bulletin is recommended by The Boeing Company, but may not be FAA approved at the time of writing. In the event of conflict with the FAA approved Airplane Flight Manual (AFM), the AFM shall supersede. The Boeing Company regards the information or procedures described herein as having a direct or indirect bearing on the safe operation of this model airplane.

THE FOLLOWING PROCEDURE AND/OR INFORMATION IS EFFECTIVE UPON RECEIPT

Background Information

Boeing has received reports of incorrect attitude on the Integrated Standby Flight Display (ISFD). Subsequent investigation has found that improper initialization of the ISFD can cause attitude display anomalies. The display anomaly shows after takeoff as an obvious error in pitch and /or roll.

The Integrated Standby Flight Display (ISFD) performs a two-minute initialization immediately after the Battery switch has been positioned ON. Any change in airplane position during this initialization period may result in inaccurate attitude information. The anomaly is not detectable by ISFD internal monitoring and may not show an obvious error in roll and/or pitch indications when compared to the pilots' primary flight instruments during preflight. Gust effects or movement of cabin occupants during the ISFD initialization period will not cause the anomaly.

Re-initialization can only be accomplished by cycling electrical power to the ISFD while the airplane is on the ground. This can be accomplished by removing all airplane electrical power or by an approved maintenance procedure. The RST switch on the ISFD should only be pushed in response to the ATT:RST amber message.

Operating Instructions

An Airplane Flight Manual (AFM) Limitation will be published that states:

"INTEGRATED STANDBY FLIGHT DISPLAY (IF INSTALLED)

The Flight Crew must verify the airplane was not moved during Integrated Standby Flight Display alignment. If unable to verify, then the power up alignment process must be reinitialized and completed prior to flight."

To comply with the AFM limitation, the airline must have procedures in place to assure flight crews on the first flight of the day, crew change, or after any complete airplane power down, that ISFD alignment was completed before the airplane was moved.

The following note will be added to the Electrical Power Up Supplementary Procedure:

Battery Switch ON

Note: Do not move the airplane until ISFD initialization is complete.

The following is included in the Captain's Preflight Procedure:

ISFD. CHECK

Approach Mode Display - Blank

Set local altimeter setting.

Verify flight instrument indications are correct.

Verify no flags or messages displayed.

Administrative Information

Insert this bulletin behind the Operations Manual Bulletin Record page in Volume 1 of your Operations Manual. Amend the Operations Manual Bulletin Record to show bulletin TBC-70 "In Effect" (IE).

This anomaly is corrected by Boeing Service Bulletin 767-34-0405. This Flight Crew Operations Manual Bulletin will be canceled after Boeing is notified that all affected airplanes in the operator's fleet have been modified.

Please send all correspondence regarding Operations Manual Bulletins status to one of the following addresses:

Boeing Commercial Airplanes
Commercial Aviation Services
Attn: 767 Manager, Flight Technical Data
P.O. Box 3707, M/C 20-89
Seattle, Washington, 98124-2207 USA
Telephone: (206) 662-4000
Fax: (206) 662-4743

Intentionally
Blank



Flight Crew Operations Manual Bulletin for The Boeing Company

The Boeing Company
Seattle, Washington 98124-2207



Number: TBC-72 R1

IssueDate: February 15, 2010

Airplane Effectivity: All Airplanes

Subject: Honeywell Flight Management Computer (FMC) Anomaly

Reason: To inform flight crews of a Honeywell FMC anomaly that incorrectly deletes a speed constraint.

Revised to include Service Bulletin information.

Information in this bulletin is recommended by The Boeing Company, but may not be FAA approved at the time of writing. In the event of conflict with the FAA approved Airplane Flight Manual (AFM), the AFM shall supersede. The Boeing Company regards the information or procedures described herein as having a direct or indirect bearing on the safe operation of this model airplane.

THE FOLLOWING PROCEDURE AND/OR INFORMATION IS EFFECTIVE UPON RECEIPT

Background Information

Boeing has confirmed operator reports of a Honeywell FMC anomaly that incorrectly deletes a speed constraint. Some SIDs are designed to limit turn radius to maintain clearance with other traffic or restricted airspace. Some of these procedures also have an AT-OR-ABOVE altitude restriction in conjunction with the speed constraint. Typically, the airplane will be required to limit speed until passing the respective waypoint as well as climb above the altitude constraint. In these procedures, VNAV will incorrectly delete the speed constraint prior to reaching the waypoint if the altitude constraint has been satisfied. When this happens, VNAV will command speed to accelerate to ECON speed (or SEL speed) prior to reaching the constrained waypoint. This anomaly exists on all Boeing 747 / 757 / 767 / 777 airplanes equipped with the Honeywell FMC.

Operating Instructions

To prevent exceeding a speed restriction when accompanied by an AT-OR-ABOVE altitude constraint, use speed intervention (enter speed constraint in the MCP Speed Window) until the constrained waypoint is sequenced. After passing the waypoint, select VNAV as desired.

Administrative Information

Insert this bulletin behind the Operations Manual Bulletin Record page in Volume 1 of your Operations Manual. Amend the Operations Manual Bulletin Record to show bulletin TBC-72 R1 "In Effect" (IE).

■ This anomaly is corrected by Boeing Service Bulletin 767-34-0566.

Please send all correspondence regarding Operations Manual Bulletins status to one of the following addresses:

Boeing Commercial Airplanes
Commercial Aviation Services
Attn: 767 Manager, Flight Technical Data
P.O. Box 3707, M/C 20-89
Seattle, Washington, 98124-2207 USA
Telephone: (206) 662-4000
Fax: (206) 662-4743



Flight Crew Operations Manual Bulletin for The Boeing Company

The Boeing Company
Seattle, Washington 98124-2207



Number: TBC-73 R1

IssueDate: February 15, 2010

Airplane Effectivity: All Airplanes

Subject: Missing Advisory-Level Message Logic in EICAS Computer P/N S242N701-1001 Operating Program Software (OPS) Version 6

Reason: To inform flight crews of missing EICAS OPS Version 6 advisory-level message logic and to provide temporary operating instructions with OPS Version 6 installed.

Revised to include Service Bulletin information.

Information in this bulletin is recommended by The Boeing Company, but may not be FAA approved at the time of writing. In the event of conflict with the FAA approved Airplane Flight Manual (AFM), the AFM shall supersede. The Boeing Company regards the information or procedures described herein as having a direct or indirect bearing on the safe operation of this model airplane.

THE FOLLOWING PROCEDURE AND/OR INFORMATION IS EFFECTIVE UPON RECEIPT

Background Information

Boeing and Rockwell Collins have confirmed the EICAS advisory-level "L ENG FUEL FILT" alert message is not available on airplanes installed with EICAS computer P/N S242N701-1001 with Operating Program Software (OPS) Version 6. This software version is installed by incorporation of Boeing Service Bulletin 767-31-0236, or production equivalent.

Each engine fuel system is equipped with a filter to remove contaminants and a pressure relief valve to allow bypass of an obstructed filter element. A pressure differential switch provides EICAS alerting of filter element obstruction prior to pressure relief valve actuation and filter bypass. Contaminants in the fuel system may result in erratic engine operation and flameout.

The EICAS advisory-level "L ENG FUEL FILT" alert message indicates an impending fuel filter bypass condition exists on the left engine. In addition, a status-level "L ENG FUEL FILT" message shows on the EICAS Status page. The STATUS Cue indication appears anytime a new status message exists with the EICAS Status page not displayed.

Boeing has been notified by the Federal Aviation Administration (FAA) Aircraft Certification Office (ACO) that an Immediate Adopted Rule (IAR) is being drafted, which will result in imminent issuance of an Airworthiness Directive (AD) regarding this missing advisory-level message.

Operating Instructions

In the interim period with EICAS OPS Version 6 installed, the following temporary operating instructions are provided:

If the STATUS Cue shows anytime on the ground after engine start or during flight, select the Status Page on the secondary EICAS display, and verify the "L ENG FUEL FILT" message is not shown. If the "L ENG FUEL FILT" message is not shown on the Status Page, the secondary engine parameters may be reselected on the secondary EICAS display, or the display may be blanked. If the "L ENG FUEL FILT" message is shown on the Status Page, accomplish the ENGINE FUEL FILTER non-normal checklist as published in the Boeing Quick Reference Handbook (QRH). If on the ground, check the Dispatch Deviations Guide (DDG), or operator equivalent.

In the unlikely event the status-level "L ENG FUEL FILT" and advisory-level "R ENG FUEL FILT" messages are simultaneously shown, an impending fuel filter bypass condition exists on both engines. With both messages shown, airplane fuel system contamination may be present and may result in erratic engine operation and flameout.

Further flight crew action in response to either or both the "L ENG FUEL FILT" status-level message and the "R ENG FUEL FILT" advisory-level messages being shown are not established by Boeing or the FAA. Any further flight crew action should be determined by individual operator policy.

Boeing policy on flight crew use of status-level messages has not changed. After engine start, any condition having adverse effect on safe continuation of the flight appears as an EICAS alert message (Warning, Caution, or Advisory). If other status-level messages are shown as a consequence of complying with these temporary operating instructions, the flight crew should respond in accordance with the appropriate operator policy.

Administrative Information

Insert this bulletin behind the Operations Manual Bulletin Record page in Volume 1 of your Operations Manual. Amend the Operations Manual Bulletin Record to show bulletin TBC-73 R1 "In Effect" (IE).

On airplanes with EICAS OPS Version 6 installed, the effects of this Flight Crew Operations Manual Bulletin are immediately corrected by:

- Incorporation of EICAS OPS Version 5 by either of the following applicable actions:
 - On airplanes of cumulative line (C/L) number 881 or prior, installation of Boeing Service Bulletin 767-31-0180;
 - or**
 - On airplanes of C/L number 882 and greater, installation per Airplane Maintenance Manual (AMM) 31-41-02/201.
- or**
- Incorporation of EICAS OPS Version 7 by Boeing Service Bulletin 767-31-0267.

This Flight Crew Operations Manual Bulletin will be "Cancelled" (CANC) upon operator notification to Boeing that all affected airplanes covered in this Flight Crew Operations Manual have been modified replacing EICAS OPS Version 6.

Please send all correspondence regarding Operations Manual Bulletins status to one of the following addresses:

Boeing Commercial Airplanes
Commercial Aviation Services
Attn: 767 Manager, Flight Technical Data
P.O. Box 3707, M/C 20-89
Seattle, Washington, 98124-2207 USA
Telephone: (206) 662-4000
Fax: (206) 662-4743

Intentionally
Blank



Flight Crew Operations Manual Bulletin for The Boeing Company

The Boeing Company
Seattle, Washington 98124-2207



Number: TBC-74

IssueDate: September 5, 2008

Airplane Effectivity: All Airplanes

Subject: Hand microphone use with flight deck PC power outlets

Reason: To inform flight crews of a new restriction on using the flight deck PC power outlets when the hand microphone is used.

Information in this bulletin is recommended by The Boeing Company, but may not be FAA approved at the time of writing. In the event of conflict with the FAA approved Airplane Flight Manual (AFM), the AFM shall supersede. The Boeing Company regards the information or procedures described herein as having a direct or indirect bearing on the safe operation of this model airplane.

THE FOLLOWING PROCEDURE AND/OR INFORMATION IS EFFECTIVE UPON RECEIPT

Background Information

Boeing has received customer complaints of interference when using hand held microphones both on the ground and in flight. Investigation has shown interference may be caused by items plugged into the PC power outlets on the flight deck. Any item plugged into a PC power outlet, whether turned on or not, can cause interference. AC 91-21.1B prohibits the use of items that cause interference with communications.

Boeing is issuing placards that state: "WHEN USING HAND MIC REMOVE PWR CORD FROM OUTLET."

Operating Instructions

Remove any power cord from the flight deck PC power outlet before using the hand microphone.

Administrative Information

Insert this bulletin behind the Operations Manual Bulletin Record page in Volume 1 of your Operations Manual. Amend the Operations Manual Bulletin Record to show bulletin TBC-74 "In Effect" (IE).

This condition is temporary until the system is modified. This bulletin will be revised to include Service Bulletin information when available.

This Operations Manual Bulletin will be cancelled after Boeing is notified that all affected airplanes in the operators fleet have been modified by Boeing Service Bulletin.

Please send all correspondence regarding Operations Manual Bulletins status to one of the following addresses:

Boeing Commercial Airplanes
Commercial Aviation Services
Attn: 767 Manager, Flight Technical Data
P.O. Box 3707, M/C 20-89
Seattle, Washington, 98124-2207 USA
Telephone: (206) 662-4000
Fax: (206) 662-4743



Flight Crew Operations Manual Bulletin for The Boeing Company

The Boeing Company
Seattle, Washington 98124-2207



Number: TBC-75

IssueDate: February 20, 2009

Airplane Effectivity: All Airplanes

Subject: General Electric (GE) CF6-80C2 Engine Flameout Mitigation

Reason: To provide flight crews with updated background information on engine flameout events in visible moisture with TAT at or below 10°C in the vicinity of convective weather systems; and to provide revised operating instructions.

Information in this bulletin is recommended by The Boeing Company, but may not be FAA approved at the time of writing. In the event of conflict with the FAA approved Airplane Flight Manual (AFM), the AFM shall supersede. The Boeing Company regards the information or procedures described herein as having a direct or indirect bearing on the safe operation of this model airplane.

THE FOLLOWING PROCEDURE AND/OR INFORMATION IS EFFECTIVE UPON RECEIPT

Background Information

Boeing and General Electric (GE) are investigating several CF6-80C2 engine flameout events which have occurred on various airplane models since 1991. Investigation of weather, flight data, and pilot reports associated with these events suggest the flameout events have occurred at altitudes with Static Air Temperature (SAT) above 0°C in the vicinity of convective weather systems. Boeing and GE believe ice accumulated aft of the fan during a descent or deceleration may have been shed and ingested into the engine when the thrust levers were subsequently advanced.

Boeing and GE investigations conclude the airplanes most likely encountered ice crystals lifted by convective activity prior to the engine flameout. At very cold temperatures near thunderstorms the airplane can encounter visible moisture made up of high concentrations of small ice crystals. These ice crystals do not cause weather radar returns. Flight crews have reported deviating around strong weather radar returns when the flameout events have occurred. Flight crews have also reported rain on the windshield when the outside air temperature was too cold for liquid water to exist. Boeing attributes this to ice crystals that melt upon impact with the heated windshield, giving the appearance of rain. These types of ice crystals do not accumulate on cold aircraft surfaces.

Flight crew reports and airplane data have shown the airplane TAT indication may often erroneously indicate 0°C for a period of time just prior to engine flameout events. This anomalous behavior is due to ice crystals partially blocking the probe and is not a cause for the engine flameout but is confirmation that ice crystals were present.

The Operating Instructions contained in this bulletin use engine anti-ice and wing anti-ice. Increased bleed air extraction from the engine causes the combustor to operate at a higher fuel-to-air ratio. This reduces the probability of flameout. In some engine flameout events, engine anti-ice was previously selected on. Boeing and GE understand that the Operating Instructions contained in this bulletin may not prevent all flameout events. However, increased engine bleed air extraction does provide a large increase in the margin to flameout.

These engine flameout events typically occur when the airplane is leveling off at an intermediate altitude. ATC permitting, make a continuous descent at idle thrust. This decreases the exposure time to the ice crystal condition and a potential engine flameout.

If an engine flameout occurs on an airplane equipped with Full Authority Digital Engine Control (FADEC) engines, the Electronic Engine Control (EEC) attempts to relight the engine when it detects N2 below 50% or a rapid decrease in N2. Engines accelerate to idle very slowly at high altitudes. In some of these events, it has taken 120 seconds or more to reach commanded thrust levels. This may be incorrectly interpreted by the flight crew as an engine that is still flamed out instead of an engine already in the process of relighting. If N2 is steadily increasing and EGT remains within limits, the start is progressing normally. In all events investigated, the affected engines successfully started, including some outside the in-flight start envelope. If N2 is steadily increasing and EGT remains within limits following a single engine flameout, the flight crew need not accomplish the ENGINE FAILURE OR SHUTDOWN followed by the ENGINE IN-FLIGHT START checklist. The DUAL ENGINE FAILURE checklist should be accomplished for dual engine flameout events.

Use of wing anti-ice at altitudes above 22,000 feet has not been included in the Operating Instructions to ensure no adverse impact on airplane systems which use engine bleed air.

Entering the TAI/ON ALT on the DESCENT FORECAST page of the FMC adjusts the VNAV path calculation for approach idle conditions with engine anti-ice ON.

Operating Instructions

When TAT is at or below 10°C in visible moisture with engine thrust reduced for a descent or a speed reduction even with SAT less than -40°C:

CAUTION: Do not use engine or wing anti-ice when TAT is above 10°C.

ENGINE ANTI-ICE switches / selectors. ON

[Increases bleed air extraction to improve engine flameout margin.]

At or below 22,000 feet:

WING ANTI-ICE switch / selector ON

[Increases bleed air extraction to improve engine flameout margin.]

During flight in Instrument Meteorological Conditions (IMC), avoid flying directly over significant amber or red depicted map weather radar regions. Use of the weather radar gain and tilt functions are recommended to assess weather radar return reflectivity.

During airplane descent and ATC permitting, attempt a continuous descent at idle thrust to decrease exposure to ice crystal conditions.

Engine and wing anti-ice may be selected OFF (or AUTO, as installed) when the conditions described above no longer exist and are not required for existing flight conditions.

Administrative Information

Insert this bulletin behind the Operations Manual Bulletin Record page in Volume 1 of your Operations Manual. Amend the Operations Manual Bulletin Record to show bulletin TBC-75 "In Effect" (IE).

This condition is under investigation. This Flight Crew Operations Manual bulletin remains in effect until further notice.

This bulletin supersedes the bulletin titled "Engine Flameout Protection GE CF6-80C2 Engines".

Please send all correspondence regarding Operations Manual Bulletins status to one of the following addresses:

Boeing Commercial Airplanes
Commercial Aviation Services
Attn: 767 Manager, Flight Technical Data
P.O. Box 3707, M/C 20-89
Seattle, Washington, 98124-2207 USA
Telephone: (206) 662-4000
Fax: (206) 662-4743

Operating Limitations L.10

 General L.10.1

 Airplane General L.10.1

 Operational Limitations L.10.1

 Non-AFM Operational Information L.10.1

 Weather Radar L.10.2

 Weight Limitations L.10.2

 Flight Deck Security Door L.10.2

 Door Mounted Escape Slides L.10.3

 Auto Flight L.10.3

 Aircraft Communications Addressing and Reporting
 System (ACARS) L.10.3

 Engine L.10.4

 Engine Fuel System L.10.4

 Reverse Thrust L.10.4

 Flight Controls L.10.4

 Navigation L.10.4

 Ground Proximity Warning System (GPWS)
 Look-Ahead Alerting L.10.4

Intentionally
Blank

Limitations
Operating Limitations**Chapter L**
Section 10**General**

This chapter contains Airplane Flight Manual (AFM) limitations and Boeing recommended operating limitations. Limitations that are obvious, shown on displays or placards, or incorporated within an operating procedure are not contained in this chapter.

Airplane General**Operational Limitations**

| | |
|--|-------------------------------|
| Runway slope | ± 2% |
| Maximum Operating Altitude | 43,100 feet pressure altitude |
| Maximum Takeoff and Landing Altitude | 8,400 feet pressure altitude |
| Maximum Takeoff and Landing Tailwind Component | 10 knots |

Non-AFM Operational Information

Note: The following items are not AFM limitations, but are provided for flight crew information.

Turbulent air penetration speed is: 290 KIAS/.78 Mach, whichever is lower.

The navigation and display system does not support operations at latitudes greater than 87° North or South.

Do not operate HF radios during refueling operations.

RVSM Altimeter Cross Check Limits

Standby altimeters do not meet altimeter accuracy requirements of RVSM.

The maximum allowable in-flight difference between Captain and First Officer altitude displays for RVSM operation is 200 feet.

The maximum allowable on-the-ground differences between Captain and First Officer altitude displays for RVSM operation are:

| Field Elevation | Max Difference Between Captain & F/O | Max Difference Between Captain or F/O & Field Elevation |
|-----------------|--------------------------------------|---|
| SEA LEVEL | 40 feet | 75 feet |
| 5,000 feet | 45 feet | 75 feet |
| 10,000 feet | 50 feet | 75 feet |

Weather Radar

Do not operate the weather radar in a hanger or within 50 feet of any personnel or fuel spill.

Note: The hanger and personnel restrictions do not apply to the weather radar test mode.

Weight Limitations

Maximum Weight Limitations

| Weights | Pounds |
|---------------------------------|---------|
| Maximum Taxi Weight (MTW) | 413,000 |
| Maximum Take Off Weight (MTOW) | 412,000 |
| Maximum Landing Weight (MLW) | 320,000 |
| Maximum Zero Fuel Weight (MZFW) | 295,000 |

Other Weight Restrictions

Note: These weights may be further restricted by field length limits, climb limits, tire speed limits, brake energy limits, obstacle clearance, or enroute and landing requirements.

Flight Deck Security Door

Verify that an operational check of the Flight Deck Access System has been accomplished according to approved procedures once each flight day.

Door Mounted Escape Slides

[Option – Passenger not Freighter Model]

Entry door evacuation slide systems must be armed and engagement of the girt bar with door sill verified prior to taxi, takeoff, or landing whenever passengers are carried.

Auto Flight

[Option – FAA certification]

After takeoff, the autopilot must not be engaged below 200 feet AGL.

Use of aileron trim with the autopilot engaged is prohibited.

Maximum allowable wind speeds when landing weather minima are predicated on autoland operations:

| | |
|-----------|----------|
| Headwind | 25 knots |
| Crosswind | 25 knots |
| Tailwind | 10 knots |

Aircraft Communications Addressing and Reporting System (ACARS)

The ACARS is limited to the transmission and receipt of messages which will not create an unsafe condition if the message is improperly received, such as the following conditions:

- the message or parts of the message are delayed or not received,
- the message is delivered to the wrong recipient, or
- the message content may be frequently corrupted.

However, Pre-Departure, Digital Automatic Terminal Information Service, Oceanic Clearances, Weight and Balance and Takeoff Data messages can be transmitted and received over ACARS if they are verified per approved operational procedures.

Engine

Continuous ignition must be on (engine start selector in the CONT position) while operating in severe turbulence.

Note: Continuous ignition is automatically provided in icing conditions when engine anti-ice is on.

Flight crew shall not blank engine vibration display during takeoff.

Engine Fuel System

The minimum inflight fuel tank temperature is 3°C (5°F) above the freeze point of the fuel being used.

The maximum fuel temperature is 49°C (120°F) {Jet B/ JP-4: 43°C (109°F)}

The center tank may contain up to 22,050 pounds of fuel with less than full main tanks provided center tank fuel weight plus actual zero fuel weight does not exceed the maximum zero fuel weight, and center of gravity limits are observed.

Reverse Thrust

Reverse thrust is for ground use only.

Backing the airplane with use of reverse thrust is prohibited.

Flight Controls

The maximum altitude for flap extension is 20,000 ft.

Avoid rapid and large alternating control inputs, especially in combination with large changes in pitch, roll, or yaw (e.g. large side slip angles) as they may result in structural failure at any speed, including below VA.

Navigation

Do not operate under IFR or at night into airports north of 73° North or south of 60° South Latitude whose navigation aids are referenced to magnetic north.

Ground Proximity Warning System (GPWS) Look-Ahead Alerting

Do not use the terrain display for navigation.

The use of look-ahead terrain alerting and terrain display functions is prohibited within 15 NM of takeoff, approach or landing at an airport not contained in the GPWS terrain database. Refer to Honeywell Document 060-4267-000 for airports and runways contained in the installed GPWS terrain database.

Normal Procedures

Chapter NP

Table of Contents

Section 0

Introduction NP.11

 General NP.11.1

 Scan Flow and Areas of Responsibility NP.11.1

 Normal Procedures Philosophy and Assumptions NP.11.2

 Configuration Check NP.11.3

 Crew Duties NP.11.4

 Control Display Unit (CDU) Procedures NP.11.5

 Autopilot Flight Director System (AFDS) Procedures NP.11.5

 Preflight and Postflight Scan Flow NP.11.6

 Areas of Responsibility - Captain as Pilot Flying or Taxiing NP.11.7

 Areas of Responsibility - First Officer as Pilot Flying or Taxiing NP.11.8

Amplified Procedures NP.21

 Preliminary Preflight Procedure – Captain or First Officer NP.21.1

 CDU Preflight Procedure - Captain and First Officer NP.21.3

 Exterior Inspection NP.21.5

 Preflight Procedure – First Officer NP.21.11

 Preflight Procedure – Captain NP.21.20

 Before Start Procedure NP.21.24

 Pushback or Towing Procedure NP.21.27

 Engine Start Procedure NP.21.28

 Engine Start Procedure NP.21.29

 Before Taxi Procedure NP.21.30

 Before Takeoff Procedure NP.21.32

 Takeoff Procedure NP.21.33

| | |
|---|----------|
| Takeoff Flap Retraction Speed Schedule | NP.21.36 |
| Climb and Cruise Procedure. | NP.21.37 |
| Descent Procedure | NP.21.38 |
| Approach Procedure. | NP.21.39 |
| Flap Extension Schedule | NP.21.39 |
| Landing Procedure - ILS | NP.21.40 |
| Landing Procedure - Instrument Approach Using VNAV | NP.21.41 |
| Go-Around and Missed Approach Procedure | NP.21.43 |
| Landing Roll Procedure | NP.21.44 |
| After Landing Procedure | NP.21.45 |
| Shutdown Procedure. | NP.21.46 |
| Secure Procedure | NP.21.48 |

General

This chapter gives:

- an introduction to the normal procedures philosophy and assumptions
- step by step normal procedures

Scan Flow and Areas of Responsibility

The scan flow and areas of responsibility diagrams shown are representative and may not match the configuration(s) of your airplanes.

The scan flow diagram provides general guidance on the order each flight crew member should follow when doing the preflight and postflight procedures. Specific guidance on the items to be checked are detailed in the amplified Normal Procedures. For example, preflight procedure details are in the Preflight Procedure - Captain and Preflight Procedure - First Officer.

Normal Procedures Philosophy and Assumptions

Normal procedures verify for each phase of flight that:

- the airplane condition is satisfactory
- the flight deck configuration is correct

Normal procedures are done on each flight. Refer to the Supplementary Procedures (SP) chapter for procedures that are done as needed, for example the adverse weather procedures.

Normal procedures are used by a trained flight crew and assume:

- all systems operate normally
- the full use of all automated features (LNAV, VNAV, autoland, autopilot, and autothrottle)

Normal procedures also assume coordination with the ground crew before:

- hydraulic system pressurization, or
- flight control surface movement, or
- airplane movement

Normal procedures do not include steps for flight deck lighting and crew comfort items.

Normal procedures are done by memory and scan flow. The panel illustration in this section shows the scan flow. The scan flow sequence may be changed as needed.

Configuration Check

It is the crew member's responsibility to verify correct system response. Before engine start, use lights or indications to verify each system's condition or configuration.

If there is an incorrect configuration or response:

- verify that the system controls are set correctly
- check the respective circuit breaker as needed. Maintenance must first determine that it is safe to reset a tripped circuit breaker on the ground
- test the respective system light as needed

Before engine start, review the EICAS alert messages and status display.

If there are unexpected messages:

- check the Dispatch Deviations Guide (DDG) or the operator equivalent to decide if the condition has a dispatch effect
- decide if maintenance is needed

If, during or after engine start, there is an alert message:

- do the respective non-normal checklist (NNC)
- on the ground, check the DDG or the operator equivalent

After engine start, EICAS alert messages are the primary means of alerting the flight crew to non-normal conditions or incorrect configurations.

After engine start, there is no need to check status messages. Any message that has an adverse affect on safe continuation of the flight appears as an EICAS alert message.

Crew Duties

Preflight and postflight crew duties are divided between the captain and first officer. Phase of flight duties are divided between the Pilot Flying (PF) and the Pilot Monitoring (PM).

Each crewmember is responsible for moving the controls and switches in their area of responsibility:

- The phase of flight areas of responsibility for both normal and non-normal procedures are shown in the Area of Responsibility illustrations in this section. Typical panel locations are shown.
- The preflight and postflight areas of responsibility are defined by the "Preflight Procedure - Captain" and "Preflight Procedure - First Officer".

The captain may direct actions outside of the crewmember's area of responsibility.

The general PF phase of flight responsibilities are:

- taxiing
- flight path and airspeed control
- airplane configuration
- navigation

The general PM phase of flight responsibilities are:

- checklist reading
- communications
- tasks asked for by the PF
- monitoring taxiing, flight path, airspeed, airplane configuration, and navigation

PF and PM duties may change during a flight. For example, the captain could be the PF during taxi but be the PM during takeoff through landing.

Normal procedures show who does a step by crew position (C, F/O, PF, or PM):

- in the procedure title, or
- in the far right column, or
- in the column heading of a table

The mode control panel is the PF's responsibility. When flying manually, the PF directs the PM to make the changes on the mode control panel.

The captain is the final authority for all tasks directed and done.

Control Display Unit (CDU) Procedures

Before taxi, the captain or first officer may make CDU entries. The other pilot must verify the entries.

Make CDU entries before taxi or when stopped, when possible. If CDU entries must be made during taxi, the PM makes the entries. The PF must verify the entries before they are executed.

In flight, the PM usually makes the CDU entries. The PF may also make simple, CDU entries when the workload allows. The pilot making the entries executes the change only after the other pilot verifies the entries.

During high workload times, for example departure or arrival, try to reduce the need for CDU entries. Do this by using the MCP heading, altitude, and speed control modes. The MCP can be easier to use than entering complex route modifications into the CDU.

Autopilot Flight Director System (AFDS) Procedures

The crew must always monitor:

- airplane course
- vertical path
- speed

When selecting a value on the MCP, verify that the respective value changes on the flight instruments, as applicable.

The crew must verify manually selected or automatic AFDS changes. Use the FMA to verify mode changes for the:

- autopilot
- flight director
- autothrottle

During LNAV and VNAV operations, verify all changes to the airplane's:

- course
- vertical path
- thrust
- speed

Announcing changes on the FMA and thrust mode display when they occur is a good CRM practice.

Preflight and Postflight Scan Flow

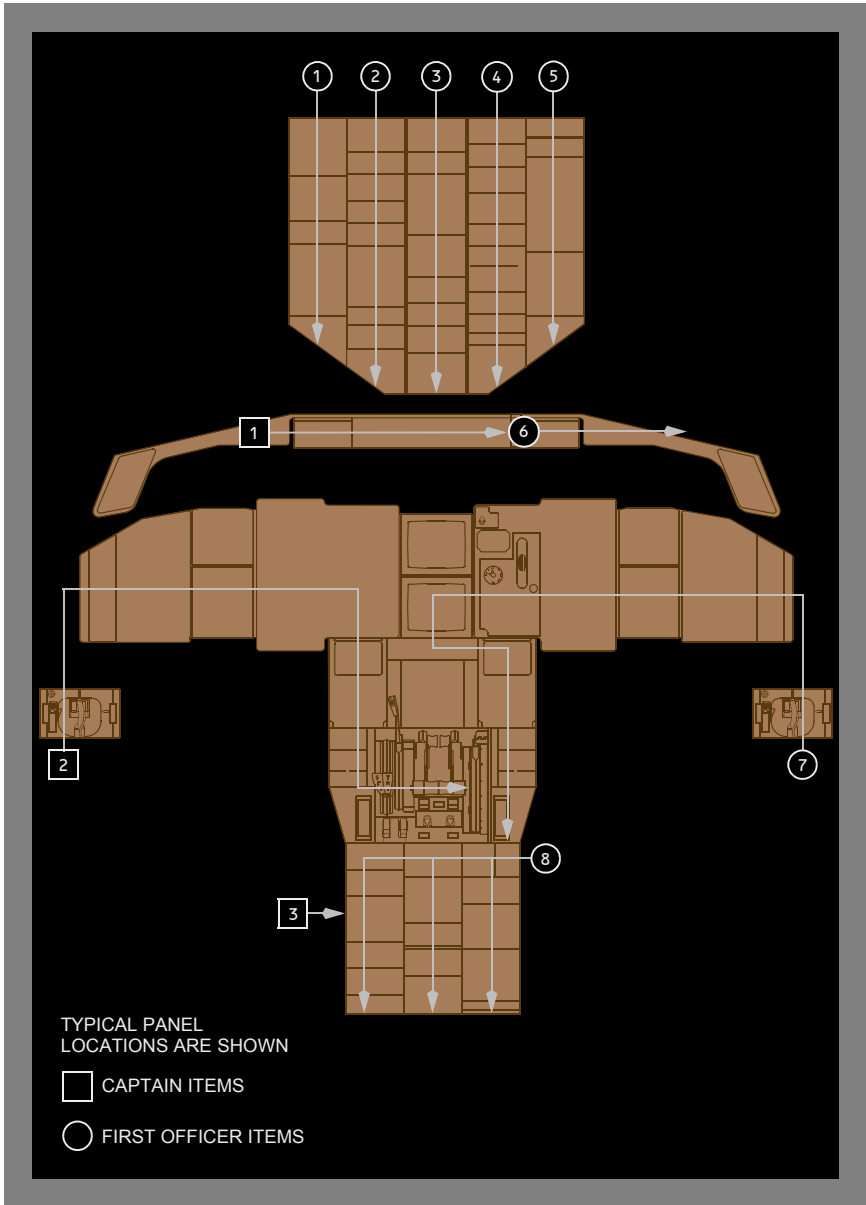

Areas of Responsibility - Captain as Pilot Flying or Taxiing

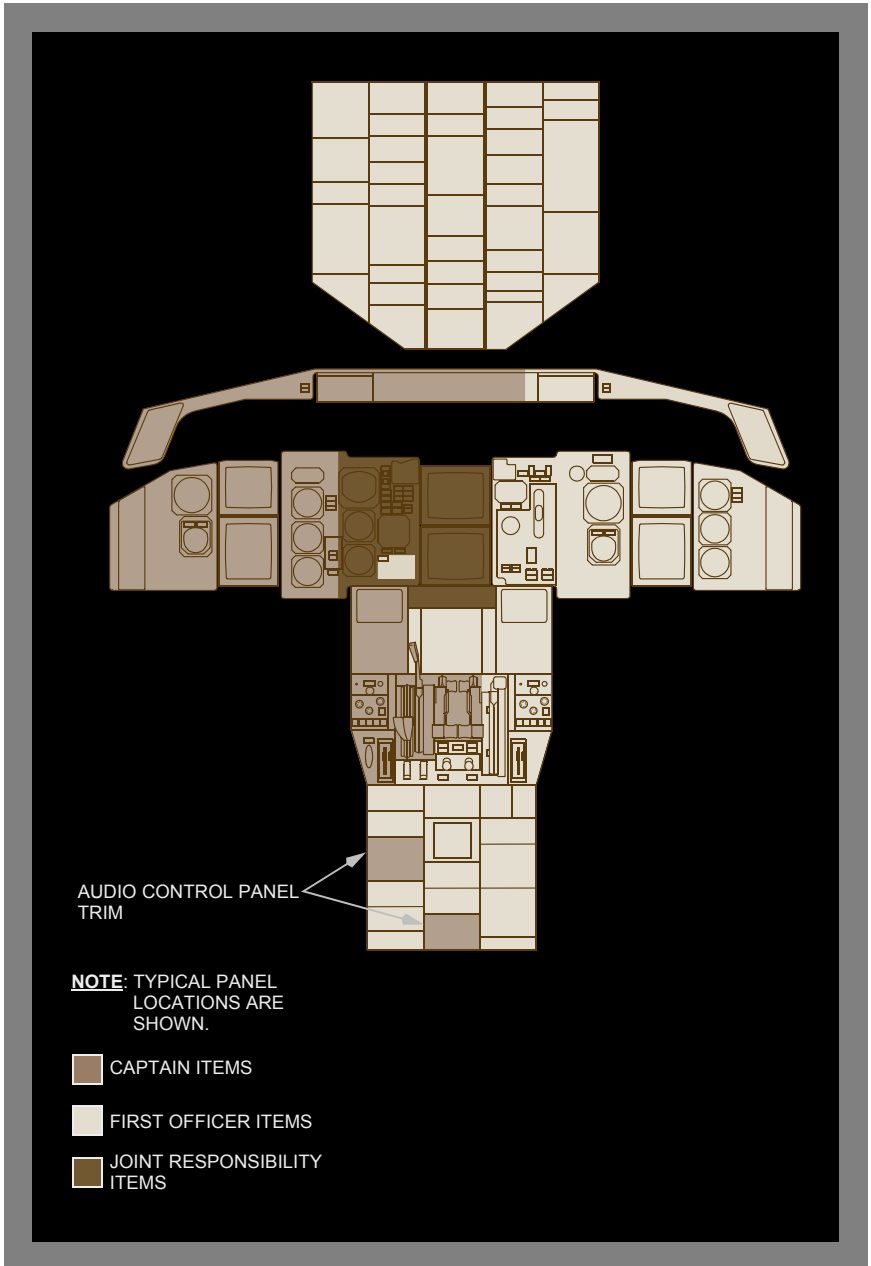

Areas of Responsibility - First Officer as Pilot Flying or Taxiing

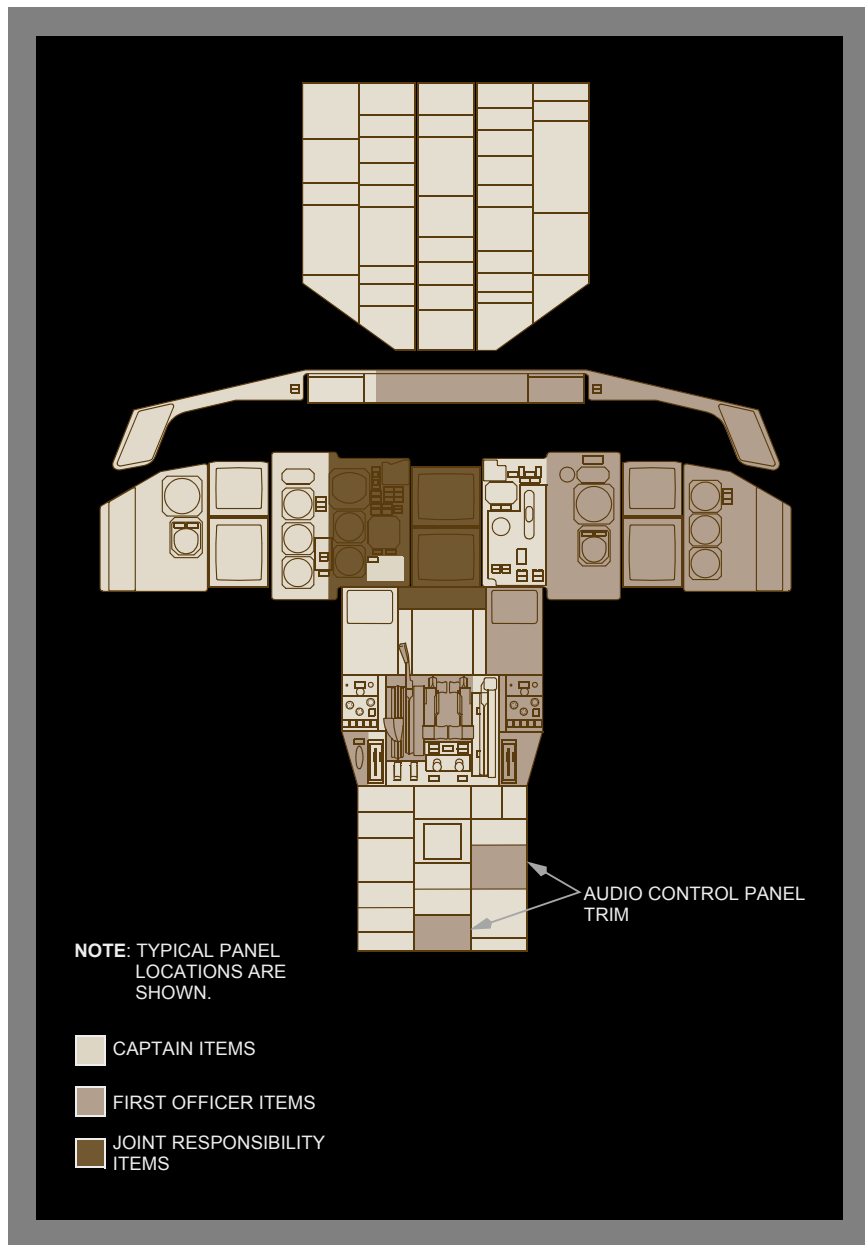

Preliminary Preflight Procedure – Captain or First Officer

The Preliminary Preflight Procedure assumes that the Electrical Power Up supplementary procedure is complete.

IRS mode selectorsOFF, then NAV

Verify that the ON DC lights illuminate then extinguish.

Verify that the ALIGN lights are illuminated.

STATUS display Check

Verify that only expected messages are shown.

Verify that the following are sufficient for flight:

- oxygen pressure
- hydraulic quantity
- engine oil quantity

Do the remaining actions after a crew change or maintenance action.

Maintenance documents Check

FLIGHT DECK ACCESS SYSTEM switch Guard closed

[Option]

BULK CARGO HEAT selector NORM or VENT

[Option]

BULK CARGO HEAT selector CARGO or ANIMAL

FLIGHT RECORDER switch NORM

SERVICE INTERPHONE switch OFF

RESERVE BRAKES and STEERING

RESET/DISABLE switch Guard closed

Verify that the ISLN light is extinguished.

Circuit breakers Check

Emergency equipment Check

Fire extinguisher – Checked and stowed

Crash axe – Stowed

Escape ropes – Stowed

Other needed equipment – Checked and stowed

Parking brake As needed

Set the parking brake if brake wear indicators will be checked during the exterior inspection.

CDU Preflight Procedure - Captain and First Officer

Start the CDU Preflight Procedure anytime after the Preliminary Preflight Procedure. The Initial Data and Navigation Data entries must be complete before the flight instrument check during the Preflight Procedure. The Performance Data entries must be complete before the Before Start Checklist.

The captain or first officer may make CDU entries. The other pilot must verify the entries.

Enter data in all the boxed items on the following CDU pages.

Enter data in the dashed items or modify small font items that are listed in this procedure. Enter or modify other items at pilot's discretion.

Failure to enter enroute winds can result in flight plan time and fuel burn errors.

Initial DataSet

IDENT page:

Verify that the MODEL is correct.

Verify that the navigation data base ACTIVE date range is current.

POS INIT page:

Verify that the time is correct.

Enter the present position on the SET IRS POS line. Use the most accurate latitude and longitude.

Navigation Data Set

RTE page:

Enter the route.

Enter the FLIGHT NUMBER.

Activate and execute the route.

DEPARTURES page:

Select the runway and departure routing.

Execute the runway and departure routing.

POS REF page:

Verify or enter the correct RNP for the departure.

Verify that the route is correct on the RTE pages. Check the LEGS pages as needed to ensure compliance with the flight plan.

Performance Data Set

PERF INIT page:

**CAUTION: Do not enter the ZFW into the GR WT boxes.
The FMC will calculate performance data with
significant errors.**

Enter the ZFW.

Verify that the FUEL on the CDU, the dispatch papers, and the fuel quantity indicator agree.

Verify that the fuel is sufficient for flight.

Verify that the GR WT on the CDU and the dispatch papers agree.

TAKEOFF REF page:

Enter the CG.

Enter the takeoff V speeds.

Exterior Inspection

Before each flight the captain, first officer, or maintenance crew must verify that the airplane is satisfactory for flight.

Items at each location may be checked in any sequence.

Use the detailed inspection route below to check that:

- the surfaces and structures are clear, not damaged, not missing parts and there are no fluid leaks
- the tires are not too worn, not damaged, and there is no tread separation
- the gear struts are not fully compressed
- the engine inlets and tailpipes are clear, the access panels are secured, the exterior is not damaged, and the reversers are stowed
- the doors and access panels that are not in use are latched
- the probes, vents, and static ports are clear and not damaged
- the skin area adjacent to the pitot probes and static ports is not wrinkled
- the antennas are not damaged
- the light lenses are clean and not damaged

For cold weather operations see the Supplementary Procedures.

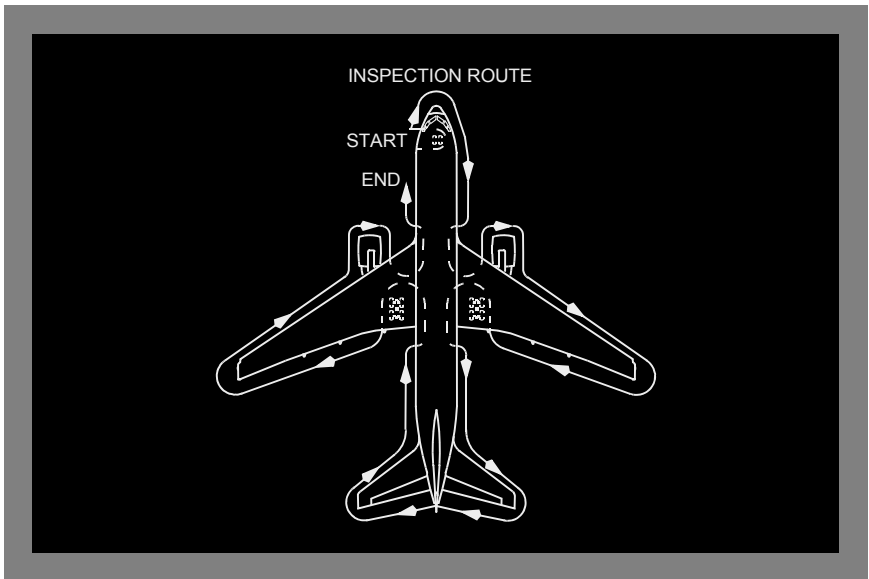

Left Forward Fuselage

Probes, sensors, ports, vents, and drains (as applicable)..... Check

Doors and access panels (not in use)..... Latched

Nose

Radome Check

 Diverter strips - Secure

Forward access door Secure

E/E access door Secure

Nose Wheel Well

Tires and wheels Check

Gear strut and doors Check

Nose wheel steering assembly Check

Nose gear steering lockout pin As needed

Gear pin As needed

Exterior lights Check

Nose wheel spin brake (snubbers)..... In place

Wheel well light switches As needed

Right Forward Fuselage

Probes, sensors, ports, vents, and drains (as applicable)..... Check

Doors and access panels (not in use)..... Latched

Oxygen pressure relief green disc In place

Negative pressure relief doors Closed

Right Wing Root, Pack, and Lower Fuselage

| | |
|---|------------------|
| Probes, sensors, ports, vents, and drains (as applicable) | Check |
| Exterior lights | Check |
| Pack inlet and pneumatic access doors | Secure |
| Leading edge slats | Check |
| Fuel sticks | Flush and secure |

Right Engine

| | |
|---|---------|
| Access panels | Latched |
| Probes, sensors, ports, vents, and drains (as applicable) | Check |
| Fan blades, probes, and spinner | Check |
| Thrust reverser | Stowed |
| Exhaust area and tailcone | Check |

Right Wing and Leading Edge

| | |
|--------------------------|------------------|
| Access panels | Latched |
| Leading edge slats | Check |
| Fuel sticks | Flush and secure |
| Wing Surfaces | Check |
| Fuel tank vent | Check |

Right Wing Tip and Trailing Edge

| | |
|--|-------|
| Position and anti-collision lights | Check |
| Static discharge wicks | Check |
| Fuel jettison nozzle | Check |
| Ailerons and trailing edge flaps | Check |

Right Main Gear

Tires, brakes and wheels Check

Verify that the wheel chocks are in place as needed.

If the parking brake is set, the brake wear indicator pins must extend out of the guides.

Gear strut, actuators, and doors Check

Hydraulic lines Secure

Gear pins As needed

Right Main Wheel Well

Wheel well Check

Right Aft Fuselage

Ram air turbine door Check

Doors and access panels (not in use)..... Latched

Probes, sensors, ports, vents, and drains (as applicable)..... Check

Negative pressure relief doors Closed

Tail

Vertical stabilizer and rudder Check

Tail skid Check

Verify that the tail skid is not damaged.

Horizontal stabilizer and elevator Check

Static discharge wicks Check

APU exhaust outlet Check

Left Aft Fuselage

Outflow valve Check

Doors and access panels (not in use)..... Latched

Probes, sensors, ports, vents, and drains (as applicable)..... Check

Left Main Wheel Well

Wheel well Check

Left Main Gear

Tires, brakes and wheels Check

Verify that the wheel chocks are in place as needed.

If the parking brake is set, the brake wear indicator pins must extend out of the guides.

Gear strut, actuators and doors Check

Hydraulic lines Secure

Gear pins As needed

Left Wing Tip and Trailing Edge

Position and anti-collision lights Check

Static discharge wicks Check

Ailerons and trailing edge flaps Check

Fuel jettison nozzle Check

Left Wing and Leading Edge

Wing Surfaces Check

Fuel sticks Flush and secure

Fuel tank vent Check

Leading edge slats Check

Access panels Latched

Left Engine

- Exhaust area and tailcone Check
- Thrust reverser Stowed
- Fan blades, probes, and spinner Check
- Probes, sensors, ports, vents, and drains (as applicable) Check
- Access panels Latched

Left Wing Root, Pack, and Lower Fuselage

- Fuel sticks Flush and secure
- Probes, sensors, ports, vents, and drains (as applicable) Check
- Exterior lights Check
- Pack inlet and pneumatic access doors Secure
- Negative and positive pressure relief doors Closed
- Leading edge slats Check

Preflight Procedure – First Officer

The first officer normally does this procedure. The captain may do this procedure as needed.

YAW DAMPER switches ON

The INOP lights stay illuminated until IRS alignment is complete.

ELECTRONIC ENGINE CONTROL switches NORM

HYDRAULIC panel Set

Verify that the SYS PRESS lights are illuminated.

Verify that the QTY lights are extinguished.

Left and Right ENGINE PRIMARY pump switches – ON

Verify that the PRESS lights are illuminated.

Center 1 and Center 2 ELECTRIC PRIMARY pump switches – Off

Verify that the PRESS lights are illuminated.

DEMAND pump selectors – OFF

Verify that the PRESS lights are illuminated.

[Option]

Evacuation signal command switch Guard closed

Left HF radio Set

BATTERY/STANDBY POWER CONTROL panel Set

BATTERY switch – ON

Verify that the DISCH light is extinguished.

STANDBY POWER selector – AUTO

Verify that the standby power bus OFF light is extinguished.

Electrical panel Set

APU GENERATOR switch – ON

BUS TIE switches – AUTO

Verify that the AC BUS OFF lights are extinguished.

UTILITY BUS switches – ON

Verify that the OFF lights are extinguished.

GENERATOR CONTROL switches – ON

Verify that the OFF lights are illuminated.

Verify that the DRIVE lights are illuminated.

APU selector (as needed) START, then ON

Do not allow the APU selector to spring back to the ON position.

Verify that the RUN light is illuminated.

Lighting panel Set

RUNWAY TURNOFF light switches – OFF

EMERGENCY LIGHTS switch Guard closed

Verify that the UNARMED light is extinguished.

Note: Do not push PASSENGER OXYGEN switch. The switch causes deployment of the passenger oxygen masks.

PASSENGER OXYGEN ON light Verify extinguished

WARNING: Do not push the RAM AIR TURBINE switch. The switch causes deployment of the ram air turbine.

Ram air turbine UNLKD light Verify extinguished

Engine control panel Set

Engine ignition selector – 1 or 2

Engine ignition selector – SINGLE

Engine start selectors – AUTO

| | |
|---|-----|
| FUEL JETTISON panel | Set |
| Fuel jettison NOZZLE switches – Off | |
| Fuel jettison selector – OFF | |
| FUEL panel | Set |
| CROSSFEED switches – Off | |
| Verify that the VALVE lights are extinguished. | |
| FUEL PUMP switches – Off | |
| Verify that the left forward pump PRESS light is extinguished if the APU is on or is illuminated if the APU is off. | |
| Verify that the other left and right pump PRESS lights are illuminated. | |
| Verify that both center pump PRESS lights are extinguished. | |
| ANTI-ICE panel | Set |
| WING anti-ice switch – Off | |
| ENGINE anti-ice switches – Off | |
| WIPER selector | OFF |
| Lighting panel | Set |
| POSITION light switch – As needed | |
| ANTI-COLLISION light switches – Off | |
| WING light switch – As needed | |
| LANDING light switches – OFF | |
| WINDOW HEAT switches | ON |
| Verify that the INOP lights are extinguished. | |
| Right HF radio | Set |
| PASSENGER SIGNS panel | Set |
| NO SMOKING selector – AUTO or ON | |
| SEATBELTS selector – AUTO or ON | |

CABIN ALTITUDE CONTROL panel Set

AUTO RATE control – Index

LANDING ALTITUDE selector – Destination airport elevation

MODE SELECTOR – AUTO 1 or AUTO 2

EQUIPMENT COOLING mode selector AUTO

CARGO HEAT switches ON

Air conditioning panel Set

CABIN compartment temperature controls – AUTO

Set as needed.

The INOP lights stay illuminated until the trim air switch is ON.

TRIM AIR switch – ON

RECIRCULATION FAN switches – ON

Verify that the INOP lights are extinguished.

[Option]

GASPER FAN switch – ON

FLIGHT DECK compartment temperature control – AUTO

Set as needed.

Verify that the INOP light is extinguished.

PACK CONTROL selectors – AUTO

The PACK OFF lights stay illuminated until bleed air or external air is supplied.

BLEED AIR panel Set

LEFT, CENTER and RIGHT ISOLATION switches – On

Verify that the VALVE lights are extinguished.

ENGINE bleed air switches – ON

Verify that the OFF lights are illuminated.

APU bleed air switch – ON

Verify that the VALVE light is extinguished.

FLIGHT DIRECTOR switch ON

VOR/DME switch AUTO

Oxygen Test and set

Select the status display.

Oxygen mask – Stowed and doors closed

TEST AND RESET switch – Push and hold

Verify that the yellow cross shows momentarily in the flow indicator.

EMERGENCY/TEST selector – Push and hold

Continue to hold the RESET/TEST switch and push the EMERGENCY/TEST selector for 10 seconds. Verify that the yellow cross shows continuously in the flow indicator.

Verify that the crew oxygen pressure does not decrease more than 100 psig.

If the oxygen cylinder valve is not in the full open position, pressure can:

- decrease rapidly, or
- decrease more than 100 psig, or
- increase slowly back to normal

Release the TEST AND RESET switch and the EMERGENCY/TEST selector. Verify that the yellow cross does not show in the flow indicator.

Normal/100% selector – 100%

Crew oxygen pressure – Check EICAS

Verify that the pressure is sufficient for dispatch.

INSTRUMENT SOURCE SELECT panel Set

FLIGHT DIRECTOR source selector – R

NAVIGATION instrument source selector – FMC R

ELECTRONIC FLIGHT INSTRUMENT switch – Off

INERTIAL REFERENCE SYSTEM switch – Off

AIR DATA source switch – Off

Do the Initial Data and Navigation Data steps from the CDU Preflight Procedure and verify that the IRS alignment is complete before checking the flight instruments.

Flight instruments Check

Set the altimeter.

Verify that the flight instrument indications are correct.

Verify that only these flags are shown:

- TCAS OFF

[Option - With speedtape only]

- V1 INOP until takeoff V-speeds are selected
- expected RDMI flags

Verify that the flight mode annunciations are correct:

- autothrottle mode is blank
- roll mode is TO
- pitch mode is TO
- AFDS status is FD

Select the map mode.

AUTOLAND STATUS annunciator Check

Verify that the indications are blank.

Landing gear panel Set

Landing gear lever – DN

ALTERNATE GEAR EXTEND switch – Guard closed

Ground proximity FLAP OVERRIDE switch Off

767 Flight Crew Operations Manual

| | |
|--|-------|
| Ground proximity GEAR OVERRIDE switch | Off |
| Ground proximity TERRAIN OVERRIDE switch | Off |
| HEADING REFERENCE switch | NORM |
| Alternate flaps panel | Set |
| ALTERNATE FLAPS selector – NORM | |
| Alternate flaps switches – Off | |
| EICAS display | Check |
| Upper EICAS display – Check | |
| Verify that the primary engine indications show existing conditions. | |
| Verify that no exceedance is shown. | |
| Lower EICAS display – Check | |
| Secondary ENGINE indications – Check | |
| Verify that the secondary engine indications show existing conditions. | |
| Verify that no exceedance is shown. | |
| Select the status display. | |
| Status messages – Check | |
| COMPUTER selector – AUTO | |
| THRUST REFERENCE SET selector – BOTH and in | |
| Verify that the TO mode is shown. | |

| | |
|--|-----------|
| EFIS control panel | Set |
| Decision height selector – As needed | |
| TERRAIN switch – As needed | |
| HSI RANGE selector – As needed | |
| HSI TRAFFIC switch – As needed | |
| HSI mode selector – MAP | |
| HSI CENTER switch – As needed | |
| WEATHER RADAR switch – Off | |
| Verify that weather radar indications are not shown on the HSI. | |
| MAP switches – As needed | |
| Weather radar panel | Set |
| Left VHF communications panel | Set |
| Center VHF communications panel | Set |
| Engine fire panel | Set |
| Verify that the ENG BTL 1 DISCH and ENG BTL 2 DISCH lights are extinguished. | |
| Engine fire switches – In | |
| Verify that the LEFT and RIGHT lights are extinguished. | |
| ADF panel | Set |
| Transponder panel | Set |
| ILS panel | As needed |
| CARGO FIRE panel | Set |
| CARGO FIRE ARM switches – Off | |
| Verify that the FWD and AFT lights are extinguished. | |
| Verify that the DISCH light is extinguished. | |
| APU fire panel | Set |
| Verify that the APU BTL DISCH light is extinguished. | |

APU fire switch – In

Verify that the APU light is extinguished.

Right VHF communications panelSet

First officer’s audio control panel As needed

WARNING: Do not put objects between the seat and the aisle stand. Injury can occur when the seat is adjusted.

Seat Adjust

Adjust the seat for optimum eye reference.

[Option - manual seat operation]

Verify a positive horizontal (fore and aft) seat lock.

Rudder pedals Adjust

Adjust the rudder pedals to allow full rudder pedal and brake pedal movement.

Seat belt and shoulder harness Adjust

Do the PREFLIGHT checklist on the captain’s command.

Preflight Procedure – Captain

The captain normally does this procedure. The first officer may do this procedure if needed.

VOR/DME switch AUTO

Mode control panel Set

FLIGHT DIRECTOR switch – ON

AUTOTHROTTLE ARM switch – ARM

BANK LIMIT selector – As needed

Autopilot DISENGAGE bar – UP

Oxygen Test and set

Select the status display.

Oxygen mask – Stowed and doors closed

TEST AND RESET switch – Push and hold

Verify that the yellow cross shows momentarily in the flow indicator.

EMERGENCY/TEST selector – Push and hold

Continue to hold the RESET/TEST switch and push the EMERGENCY/TEST selector for 10 seconds. Verify that the yellow cross shows continuously in the flow indicator.

Verify that the crew oxygen pressure does not decrease more than 100 psig.

If the oxygen cylinder valve is not in the full open position, pressure can:

- decrease rapidly, or
- decrease more than 100 psig, or
- increase slowly back to normal

Release the TEST AND RESET switch and the EMERGENCY/TEST selector. Verify that the yellow cross does not show in the flow indicator.

Normal/100% selector – 100%

Crew oxygen pressure – Check EICAS

Verify that the pressure is sufficient for dispatch.

INSTRUMENT SOURCE SELECT panelSet

FLIGHT DIRECTOR source selector – L

NAVIGATION instrument source selector – FMC L

ELECTRONIC FLIGHT INSTRUMENT switch – Off

INERTIAL REFERENCE SYSTEM switch – Off

AIR DATA source switch – Off

Do the Initial Data and Navigation Data steps from the CDU Preflight Procedure and verify that the IRS alignment is complete before checking the flight instruments.

Flight instruments Check

Set the altimeter.

Verify that the flight instrument indications are correct.

Verify that only these flags are shown:

- TCAS OFF

[Option - with speedtape only]

- V1 INOP until takeoff V-speeds are selected
- expected RDMI flags

Verify that the flight mode annunciations are correct:

- autothrottle mode is blank
- roll mode is TO
- pitch mode is TO
- AFDS status is FD

Select the map mode.

AUTOLAND STATUS annunciator Check

Verify that the indications are blank.

RESERVE BRAKES AND STEERING switch Off

Verify that the VALVE light is extinguished.

Standby instruments Check

Attitude indicator caging control – Pull, then release

ILS selector – OFF

Set the altimeter.

Verify that the flight instrument indications are correct.

Verify that no flags are shown.

Standby engine indicator selector AUTO

AUTOBRAKES selector RTO

EFIS control panel Set

Decision height selector – As needed

TERRAIN switch – As needed

HSI RANGE selector – As needed

HSI TRAFFIC switch – As needed

HSI mode selector – MAP

HSI CENTER switch – As needed

WEATHER RADAR switch – Off

Verify that weather radar indications are not shown on the HSI.

MAP switches – As needed

ALTERNATE STABILIZER TRIM switches Neutral

SPEEDBRAKE lever DOWN

Reverse thrust levers Down

Forward thrust levers Closed

Flap lever Set

Set the flap lever to agree with the flap position.

Parking brake Set

Verify that the PARK BRAKE light is illuminated.

Note: Do not assume that the parking brake will prevent airplane movement. Accumulator pressure can be insufficient.

STABILIZER TRIM cutout switches Guards closed

FUEL CONTROL switches CUTOFF

FUEL CONTROL switch fire warning lights Verify extinguished

Captain’s audio control panel As needed

WARNING: Do not put objects between the seat and the aisle stand. Injury can occur when the seat is adjusted.

Seat Adjust

Adjust the seat for optimum eye reference.

[Option - manual seat operation]

Verify a positive horizontal (fore and aft) seat lock.

Rudder pedals Adjust

Adjust the rudder pedals to allow full rudder pedal and brake pedal movement.

Seat belt and shoulder harness Adjust

Call “PREFLIGHT CHECKLIST.”

Before Start Procedure

Start the Before Start Procedure after papers are on board.

Flight deck door Closed and locked F/O

Verify that the LOCK FAIL light is extinguished.

Do the CDU Preflight Procedure – Performance Data steps before completing this procedure.

CDU displaySet C, F/O

Normally the PF selects the TAKEOFF REF page.

Normally the PM selects the LEGS page.

Takeoff thrust referenceSet C, F/O

Verify that the thrust reference mode is correct.

IAS bugsSet C, F/O

Set the bugs at V1, VR, VREF 30 + 40, and VREF 30 + 80.

MCPSet C

IAS/MACH selector – Set V2

Arm LNAV as needed.

Initial heading – Set

Initial altitude – Set

Taxi and Takeoff briefings Complete C, F/O

The pilot who will do the takeoff does the taxi and takeoff briefings.

Exterior doors Verify closed F/O

Flight deck windows Closed and locked C, F/O

Verify that the lock lever is in the forward, locked position.

Verify that the WINDOW NOT CLOSED decal does not show.

Start clearance Obtain C, F/O

Obtain a clearance to pressurize the hydraulic systems.

Obtain a clearance to start the engines.

If pushback is needed:

Verify that the nose gear steering is locked out. C, F/O

HYDRAULIC panel Set F/O

WARNING: If the tow bar is connected, do not pressurize the hydraulic systems until the nose gear steering is locked out. Unwanted tow bar movement can occur.

Note: Pressurize the right system first to prevent fluid transfer between systems.

Right ELECTRIC DEMAND pump selector – AUTO

Verify that the PRESS light is extinguished.

Center 1 and Center 2 ELECTRIC PRIMARY pump switches – ON

Verify that the center 1 PRESS light is extinguished.

The center 2 PRESS light stays illuminated until after the engine start due to load shedding.

Left ELECTRIC DEMAND pump selector – AUTO

Verify that the PRESS light is extinguished.

Center AIR DEMAND pump selector – AUTO

Verify that the PRESS light is extinguished.

Fuel panel Set F/O

LEFT and RIGHT FUEL PUMP switches – ON

Verify that the PRESS lights are extinguished.

If there is fuel in the center tank:

CENTER FUEL PUMP switches – ON

Verify both PRESS lights are illuminated and CTR L FUEL PUMP and CTR R FUEL PUMP messages are shown.

RED ANTI-COLLISION light switchON F/O

| | | |
|---|------|-----|
| RECALL switch | Push | F/O |
| Verify that only the expected alert messages are shown. | | |
| Trim | Set | C |
| Stabilizer trim – ___ UNITS | | |
| Set the trim for takeoff. | | |
| Verify that the trim is in the greenband. | | |
| Aileron trim – 0 units | | |
| Rudder trim – 0 units | | |
| Call “BEFORE START CHECKLIST.” | | C |
| Do the BEFORE START checklist. | | F/O |

Pushback or Towing Procedure

The Engine Start procedure may be done during pushback or towing.

Establish communications with ground handling personnel. C

CAUTION: Do not hold or turn the nose wheel tiller during pushback or towing. This can damage the nose gear or the tow bar.

CAUTION: Do not use airplane brakes to stop the airplane during pushback or towing. This can damage the nose gear or the tow bar.

TransponderAs needed F/O

At airports where ground tracking is not available, select STANDBY.
At airports equipped to track airplanes on the ground, select an active transponder setting, but not a TCAS mode.

Set or release the parking brake as directed by ground handling personnel. C or F/O

When pushback or towing is complete:

Verify that the tow bar is disconnected. C

Verify that the nose gear steering is not locked out. C

Engine Start Procedure

[Option - GE CF6-80 engines]

Select the secondary engine indications. F/O

PACK CONTROL selectors.....OFF F/O

Verify that the PACK OFF lights are illuminated.

CANCEL switch Push F/O

Verify that the messages are cancelled.

Start sequence.....Announce C

Call “START ___ ENGINE” C

Engine start selector GND F/O

Verify that the oil pressure increases. C, F/O

When N2 is at 20%, or (if 20% N2 is not possible), at maximum motoring and a minimum of 15% N2:

Note: Maximum motoring occurs when N2 acceleration is less than 1% in approximately 5 seconds.

FUEL CONTROL switchRUN C

Verify that the EGT increases and stays below the EGT limit. C, F/O

After the engine is stabilized at idle, start the other engine.

Do the ABORTED ENGINE START checklist for one or more of the following abort start conditions:

- the EGT does not increase by 25 seconds after the fuel control switch is moved to RUN
- there is no N1 rotation by 30 seconds after N2 is stabilized at idle
- the EGT quickly nears or exceeds the start limit
- the oil pressure indication is not normal by the time that the engine is stabilized at idle

Engine Start Procedure**[Option - PW 4000 series engines]**

| | |
|--|-----|
| Select the secondary engine indications. | F/O |
|--|-----|

| | | |
|------------------------------|-----|-----|
| PACK CONTROL selectors | OFF | F/O |
|------------------------------|-----|-----|

Verify that the PACK OFF lights are illuminated.

| | | |
|---------------------|------|-----|
| CANCEL switch | Push | F/O |
|---------------------|------|-----|

Verify that the messages are cancelled.

| | | |
|----------------------|----------|---|
| Start sequence | Announce | C |
|----------------------|----------|---|

| | |
|-------------------------|---|
| Call "START ___ ENGINE" | C |
|-------------------------|---|

| | | |
|-----------------------------|-----|-----|
| Engine start selector | GND | F/O |
|-----------------------------|-----|-----|

| | |
|---|--------|
| Verify that the oil pressure increases. | C, F/O |
|---|--------|

| | |
|---------------------|--------|
| Verify N2 rotation. | C, F/O |
|---------------------|--------|

At maximum motoring and a minimum of 15% N2:

Note: Maximum motoring occurs when N2 acceleration is less than 1% in approximately 5 seconds.

| | | |
|---------------------------|-----|---|
| FUEL CONTROL switch | RUN | C |
|---------------------------|-----|---|

| | |
|--|--------|
| Verify that the EGT increases and stays below the EGT limit. | C, F/O |
|--|--------|

Do not increase thrust above that needed to taxi until the oil temperature is a minimum of 50° C.

After the engine is stabilized at idle, start the other engine.

Do the ABORTED ENGINE START checklist for one or more of the following abort start conditions:

- the EGT does not increase by 20 seconds after the fuel control switch is moved to RUN
- there is no N1 rotation when the EGT increases
- the EGT quickly nears or exceeds the start limit
- the N2 is not at idle by 2 minutes after the fuel control switch is moved to RUN
- the oil pressure indication is not normal by the time that the engine is stabilized at idle

Before Taxi Procedure

| | | |
|--|-------------------|--------|
| APU selector | OFF | F/O |
| ENGINE ANTI-ICE switches | As needed | F/O |
| PACK selectors | AUTO | F/O |
| LEFT and RIGHT ISOLATION switches | Off | F/O |
| Select the status display. | | F/O |
| Verify that the ground equipment is clear. | | C, F/O |
| Call “FLAPS___” as needed for takeoff. | | C |
| Flap lever | Set takeoff flaps | F/O |
| Flight controls | Check | C |

Make slow and deliberate inputs, one direction at a time.

Move the control wheel and the control column to full travel in both directions and verify:

- freedom of movement
- that the controls return to center
- correct flight control movement on the EICAS display

Hold the nose wheel tiller during the rudder check to prevent nose wheel movement.

Move the rudder pedals to full travel in both directions and verify:

- freedom of movement
- that the rudder pedals return to center
- correct flight control movement on the EICAS display.

Select the secondary engine indications. F/O

Transponder

| | |
|-----------|-----|
| As needed | F/O |
|-----------|-----|

At airports where ground tracking is not available, select STANDBY.
At airports equipped to track airplanes on the ground, select an active transponder setting, but not a TCAS mode.

Recall

| | |
|-------|--------|
| Check | C, F/O |
|-------|--------|

Verify that only expected alert messages are shown.

767 Flight Crew Operations Manual

| | |
|---|---------|
| Update changes to the taxi briefing, as needed. | C or PF |
| Call “BEFORE TAXI CHECKLIST.” | C |
| Do the BEFORE TAXI checklist. | F/O |

Before Takeoff Procedure

[Option - PW 4000 series engines]

Engine warm up **requirements:**

- engine oil temperature must be above the lower amber band before takeoff.

[Option - PW 4000 series engines]

Engine warm up recommendations (there is no need to delay the takeoff for these recommendations):

- when the engines have been shut down more than 2 hours:
 - run the engines for 5 minutes
- when taxi time is expected to be less than 5 minutes, start the engines as early as feasible
- use a thrust setting normally used for taxi operations.

[Option - GE CF6-80 engines]

Engine warm up **requirements:**

- engine oil temperature must be above the bottom of the temperature scale.

Engine warm up recommendations:

- run the engines for at least 3 minutes
- use a thrust setting normally used for taxi operations.

| Pilot Flying | Pilot Monitoring |
|--|--|
| | Notify the cabin crew to prepare for takeoff. Verify that the cabin is secure. |
| The pilot who will do the takeoff updates changes to the takeoff briefing as needed. | |
| Set the weather radar display as needed. Set the terrain display as needed. | |
| Call "BEFORE TAKEOFF CHECKLIST." | Do the BEFORE TAKEOFF checklist. |

Takeoff Procedure

| Pilot Flying | Pilot Monitoring |
|--|---|
| Before entering the departure runway, verify that the runway and runway entry point are correct. | |
| | When entering the departure runway, set the WHITE ANTI COLLISION light switch to ON. Use other lights as needed. Set the transponder mode selector to TA/RA. |
| Verify that the brakes are released. Align the airplane with the runway. | |
| Verify that the airplane heading agrees with the assigned runway heading. | |
| | When cleared for takeoff, set the left and right WING LANDING light switches to ON. |
| Advance the thrust levers to approximately 70% N1. Advance the thrust levers to approximately 1.10 EPR. Allow the engines to stabilize | |
| Push the THR switch. | |

| Pilot Flying | Pilot Monitoring |
|--|---|
| Verify that the correct takeoff thrust is set. | |
| | <p>Monitor the engine instruments during the takeoff. Call out any abnormal indications.</p> <p>Adjust takeoff thrust before 80 knots as needed.</p> <p>During strong headwinds, if the thrust levers do not advance to the planned takeoff thrust by 80 knots, manually advance the thrust levers.</p> |
| After takeoff thrust is set, the captain's hand must be on the thrust levers until V1. | |
| <p>Monitor airspeed.</p> <p>Maintain light forward pressure on the control column.</p> | Monitor airspeed and call out any abnormal indications. |
| Verify 80 knots and call "CHECK." | Call "80 KNOTS." |
| Verify V1 speed. | Call "V1." |
| <p>At VR, rotate toward 15° pitch attitude.</p> <p>After liftoff, follow F/D commands.</p> | <p>At VR, call "ROTATE."</p> <p>Monitor airspeed and vertical speed.</p> |
| Establish a positive rate of climb. | |
| | Verify a positive rate of climb on the altimeter and call "POSITIVE RATE." |
| Verify a positive rate of climb on the altimeter and call "GEAR UP." | |
| | Set the landing gear lever to UP. |
| Above 400 feet radio altitude, call for a roll mode as needed. | Select or verify the roll mode. |
| At thrust reduction height, call "VNAV." | |
| | Push the VNAV switch. |
| Verify that climb thrust is set. | |

767 Flight Crew Operations Manual

| Pilot Flying | Pilot Monitoring |
|--|--|
| Verify acceleration. Call “FLAPS___” according to the flap retraction schedule. | |
| | Set the flap lever as directed. |
| Engage the autopilot after a roll mode and VNAV are engaged. | |
| | After flap retraction is complete: <ul style="list-style-type: none">• Set the landing gear lever to OFF after landing gear retraction is complete |
| Call “AFTER TAKEOFF CHECKLIST.” | |
| | Do the AFTER TAKEOFF checklist. |

Takeoff Flap Retraction Speed Schedule

| Takeoff Flaps | At Speed (knots) | Select Flaps |
|---------------|------------------|--------------|
| 20 or 15 | VREF 30 + 20 | 5 |
| | “F” | 1 |
| | VREF 30 + 40 | |
| | “F” | UP |
| 5 | VREF 30 + 60 | |
| | “F” | 1 |
| | VREF 30 + 40 | |
| | “F” | UP |
| | VREF 30 + 60 | |

“F” = Minimum flap retraction speed for next flap setting on speed tape display (as installed)

Climb and Cruise Procedure

Complete the After Takeoff Checklist before starting the Climb and Cruise Procedure.

| Pilot Flying | Pilot Monitoring |
|--|--|
| | At or above 10,000 feet MSL, set the LANDING light switches to OFF. |
| | Set the passenger signs as needed. |
| At transition altitude, set and crosscheck the altimeters to standard. | |
| | Refer to the Operating Instructions contained in Flight Crew Operations Manual Bulletin (FCOMB), Subject: "Center Tank Fuel Pumps." |
| | Before the top of descent, modify the active route as needed for the arrival and approach. Verify or enter the correct RNP for the arrival. |

Descent Procedure

Start the Descent Procedure before the airplane descends below the cruise altitude for arrival at destination.

Complete the Descent Procedure by 10,000 feet MSL.

| Pilot Flying | Pilot Monitoring |
|--|---|
| | Verify that pressurization is set to landing altitude. |
| Review all alert messages. | Recall and review all alert messages. |
| Verify VREF on the APPROACH REF page. | Enter VREF on the APPROACH REF page. |
| Set the bugs at VREF, VREF 30 + 40, and VREF 30 + 80. | |
| Set the RADIO/BARO minimums as needed for the approach. | |
| Set or verify the navigation radios and course for the approach. | |
| | Set the AUTOBRAKE selector to the needed brake setting. |
| Do the approach briefing. | |
| Call "DESCENT CHECKLIST." | Do the DESCENT checklist. |

Approach Procedure

The Approach Procedure is normally started at transition level.

Complete the Approach Procedure before:

- the initial approach fix, or
- the start of radar vectors to the final approach course, or
- the start of a visual approach

| Pilot Flying | Pilot Monitoring |
|--|--|
| | Set the passenger signs as needed. |
| | At or above 10,000 feet MSL, set the LEFT and RIGHT WING LANDING light switches to ON. |
| At transition level, set and crosscheck the altimeters. | |
| Update the arrival and approach, as needed. Update the RNP as needed. | |
| Update the approach briefing as needed. | |
| Call "APPROACH CHECKLIST." | Do the APPROACH checklist. |

Flap Extension Schedule

| Current Flap Position | At "Display" or Speed (knots) | Select Flaps | Command Speed for Selected Flaps |
|-----------------------|-------------------------------|--------------|--|
| UP | "Ref Bug" VREF30 + 80 | 1 | VREF30 + 60 |
| 1 | VREF30 + 60 | 5 | "Ref Bug" VREF30 + 40 |
| 5 | "Ref Bug" VREF30 + 40 | 20 | VREF30 + 20 |
| 20 | VREF30 + 20 | 25 or 30 | (VREF25 or VREF30) + wind additives |

Landing Procedure - ILS

| Pilot Flying | Pilot Monitoring |
|---|---|
| | [Passenger airplanes] Notify the cabin crew to prepare for landing. Verify that the cabin is secure. |
| Call “FLAPS___” according to the flap extension schedule. | Set the flap lever as directed. |
| When on localizer intercept heading: <ul style="list-style-type: none"> • verify that the ILS is tuned and identified • verify that the LOC and G/S pointers are shown | |
| Arm the APP mode. | |
| WARNING: When using LNAV to intercept the final approach course, LNAV might parallel the localizer without capturing it. The airplane can then descend on the glide slope with the localizer not captured. | |
| Use HDG SEL or HDG HOLD to intercept the final approach course, as needed. | |
| Verify that the localizer is captured. | |
| | Call “GLIDE SLOPE ALIVE.” |
| At glide slope alive, call: <ul style="list-style-type: none"> • “GEAR DOWN” • “FLAPS 20” | Set the landing gear lever to DN. Set the flap lever to 20. |
| Set the SPEEDBRAKE lever to ARMED. | |
| At glide slope capture, call “FLAPS___” as needed for landing. | Set the flap lever as directed. |
| Set the missed approach altitude on the MCP. | |
| Call “LANDING CHECKLIST.” | Do the LANDING checklist. |
| At the final approach fix or OM, verify the crossing altitude. | |
| Monitor the approach. Verify the autoland status at 500 feet radio altitude. | |

Landing Procedure - Instrument Approach Using VNAV

Use the autopilot during the approach to give:

- autopilot alerts and mode fail indications
- more accurate course and glide path tracking
- lower RNP limits.

This procedure is not authorized using QFE.

| Pilot Flying | Pilot Monitoring |
|--|---|
| | [Passenger airplanes] Notify the cabin crew to prepare for landing. Verify that the cabin is secure. |
| Call “FLAPS __” according to the flap extension schedule. | Set the flap lever as directed. |
| The recommended roll modes for the final approach are: <ul style="list-style-type: none"> • for a RNAV or GPS approach use LNAV • for a LOC-BC approach use LNAV or B/CRS • for a VOR or NDB approach use LNAV • for a LOC, SDF, or LDA approach use LNAV or LOC | |
| | Verify that the VNAV glide path angle is shown on the final approach segment of the LEGS page. |
| When on the final approach course intercept heading for LOC, LOC-BC, SDF, or LDA approaches: <ul style="list-style-type: none"> • verify that the localizer is tuned and identified • verify that the LOC pointer is shown | |
| Arm the LNAV or LOC mode. | |
| <p style="text-align: center;">WARNING: When using LNAV to intercept the localizer, LNAV might parallel the localizer without capturing it. The airplane can then descend on the VNAV path with the localizer not captured.</p> | |
| Use LNAV, HDG SEL or HDG HOLD to intercept the final approach course as needed. | |
| Verify that LNAV is engaged or that the localizer is captured. | |

| Pilot Flying | Pilot Monitoring |
|---|---|
| <p>Approximately 2 NM before the final approach fix and after ALT HOLD or VNAV PTH is annunciated:</p> <ul style="list-style-type: none"> • verify that the autopilot is engaged • set DA(H) or MDA(H) on the MCP • select or verify VNAV • select or verify speed intervention | <p>Call “APPROACHING GLIDE PATH.”</p> |
| <p>Approaching glide path, call: “GEAR DOWN” “FLAPS 20”</p> | <p>Set the landing gear lever to DN. Set the flap lever to 20</p> |
| <p>Set the SPEEDBRAKE lever to ARMED.</p> | |
| <p>Beginning the final approach descent, call “FLAPS __” as needed for landing.</p> | <p>Set the flap lever as directed.</p> |
| <p>Call “LANDING CHECKLIST.”</p> | <p>Do the LANDING checklist.</p> |
| <p>When at least 300 feet below the missed approach altitude, set the missed approach altitude on the MCP.</p> | |
| <p>At the final approach fix, verify the crossing altitude and crosscheck the altimeters.</p> | |
| <p>Monitor the approach.</p> | |
| <p>If suitable visual reference is established at MDA(H), DA(H), or the missed approach point, disengage the autopilot and disconnect the autothrottle. Maintain the glide path to landing.</p> | |

Go-Around and Missed Approach Procedure

| Pilot Flying | Pilot Monitoring |
|---|---|
| At the same time: <ul style="list-style-type: none"> • push the GA switch • call “FLAPS 20” | Position the flap lever to 20. |
| Verify: <ul style="list-style-type: none"> • the rotation to go-around attitude • that the thrust increases | |
| | Verify that the thrust is sufficient for the go-around or adjust as needed. |
| Verify a positive rate of climb on the altimeter and call “GEAR UP.” | Verify a positive rate of climb on the altimeter and call “POSITIVE RATE.” Set the landing gear lever to UP. |
| Above 400 feet radio altitude, select a roll mode. | Verify that the missed approach altitude is set. |
| Verify that the missed approach route is tracked. | |
| At acceleration height, set speed to the maneuver speed for the planned flap setting. Call “CLIMB THRUST.” | Select CLB thrust. |
| Call “FLAPS ___” according to the flap retraction schedule. | Set the flap lever as directed. |
| After flap retraction to the planned flap setting, select FLCH or VNAV as needed. | |
| Verify that climb thrust is set. | |
| Verify that the missed approach altitude is captured. | |
| | Set the landing gear lever to OFF after landing gear retraction is complete. |
| Call “AFTER TAKEOFF CHECKLIST.” | Do the AFTER TAKEOFF checklist. |

Landing Roll Procedure

| Pilot Flying | Pilot Monitoring |
|---|--|
| Verify that the thrust levers are closed. Verify that the SPEEDBRAKE lever is UP. | Verify that the SPEEDBRAKE lever is UP. Call "SPEEDBRAKES UP." If the SPEEDBRAKE lever is not UP, call "SPEEDBRAKES NOT UP." |
| Monitor the rollout progress. | |
| Verify correct autobrake operation. | |
| WARNING: After the reverse thrust levers are moved, a full stop landing must be made. If an engine stays in reverse, safe flight is not possible. | |
| Without delay, move the reverse thrust levers to the interlocks and hold light pressure until the interlocks release. Then apply reverse thrust as needed. | |
| By 60 knots, start movement of the reverse thrust levers to be at the reverse idle detent before taxi speed. | Call "60 KNOTS." |
| After the engines are at reverse idle, move the reverse thrust levers full down. | |
| Before taxi speed, disarm the autobrakes. Use manual braking as needed. | |
| Before turing off the runway, disconnect the autopilot. | |

After Landing Procedure

Start the After Landing Procedure when clear of the active runway.

[Option - PW 4000 series engines]

Engine cooldown **requirement:**

- Run the engines for at least 90 seconds
- Use a thrust setting no higher than that normally used for all engine taxi operations.

[Option - PW JT9D and 4000 series engines]

Engine cooldown recommendations:

- Run the engines for at least 5 minutes
- Use a thrust setting no higher than that normally used for all engine taxi operations.

[Option - GE CF6-80 engines]

Engine cooldown recommendations:

- Run the engines for at least 3 minutes
- Use a thrust setting normally used for taxi operations.

| Pilot Flying | Pilot Monitoring |
|--|--|
| The captain moves or verifies that the SPEEDBRAKE lever is DOWN. | |
| | Set the APU selector to START, then ON, as needed. Do not allow the APU selector to spring back to the ON position. |
| | Set the exterior lights as needed. |
| Set the weather radar to off. | |
| | Set the AUTOBRAKE selector to OFF. |
| | Set the flap lever to UP. |
| | Set the transponder mode selector as needed. At airports where ground tracking is not available, select STANDBY. At airports equipped to track airplanes on the ground, select an active transponder setting, but not a TCAS mode. |

Shutdown Procedure

Start the Shutdown Procedure after taxi is complete.

Parking brakeSet C or F/O

Verify that the PARK BRAKE light is illuminated.

Electrical powerSet F/O

If APU power is needed:

Verify that the APU RUN light is illuminated.

If external power is needed:

Verify that the EXTERNAL POWER AVAIL light is illuminated.

EXTERNAL POWER switch – Push

Verify that the ON light is illuminated.

ENGINE ANTI-ICE switches Off F/O

FUEL CONTROL switchesCUTOFF C

If towing is needed:

Establish communications with ground handling personnel C

WARNING: If the nose gear steering is not locked out, any change to hydraulic power with the tow bar connected may cause unwanted tow bar movement.

Verify that the nose gear steering is locked out C

CAUTION: Do not hold or turn the nose wheel tiller during pushback or towing. This can damage the nose gear or the tow bar.

CAUTION: Do not use airplane brakes to stop the airplane during pushback or towing. This can damage the nose gear or the tow bar.

Set or release the parking brake as directed by ground handling personnel C or F/O

SEATBELTS selectorOFF F/O

HYDRAULIC panel Set F/O

Note: Depressurize the right system last to prevent fluid transfer between systems.

Center AIR DEMAND pump selector – OFF

Left ELECTRIC DEMAND pump selector – OFF

Center 1 and Center 2 ELECTRIC PRIMARY pump switches – Off

Right ELECTRIC DEMAND pump selector – OFF

FUEL PUMP switches Off F/O

RED ANTI-COLLISION light switch Off F/O

LEFT and RIGHT ISOLATION switches On F/O

FLIGHT DIRECTOR switches OFF C, F/O

Status messages Check F/O

Record shown status messages in maintenance log.

TCAS mode selector STANDBY F/O

After wheel chocks are in place:

Parking brake – Release C or F/O

APU selector As needed F/O

Call “SHUTDOWN CHECKLIST.” C

Do the SHUTDOWN checklist. F/O

Secure Procedure

| | | |
|-------------------------------|-----|-----|
| IRS mode selectors | OFF | F/O |
| EMERGENCY LIGHTS switch | OFF | F/O |
| WINDOW HEAT switches | Off | F/O |
| CARGO HEAT switches | Off | F/O |
| PACK CONTROL selectors | OFF | F/O |
| Call “SECURE CHECKLIST.” | | C |
| Do the SECURE checklist. | | F/O |

Supplementary Procedures**Chapter SP****Table of Contents****Section 0**

| | |
|---|--------------|
| Introduction | SP.05 |
| General | SP.05.1 |
| Airplane General, Emer. Equip., Doors, Windows | SP.1 |
| Doors | SP.1.1 |
| Entry Door Closing | SP.1.1 |
| Entry Door Opening | SP.1.1 |
| Flight Deck Door Access System Test | SP.1.2 |
| Windows | SP.1.2 |
| Flight Deck Window Closing | SP.1.2 |
| Flight Deck Window Opening | SP.1.2 |
| Lights | SP.1.3 |
| Indicator Lights Test | SP.1.3 |
| Emergency Equipment | SP.1.3 |
| Oxygen Mask Microphone Test | SP.1.3 |
| Air Systems | SP.2 |
| Air Conditioning Packs | SP.2.1 |
| Ground Conditioned Air Use | SP.2.1 |
| Packs Off Takeoff | SP.2.1 |
| Anti-Ice, Rain | SP.3 |
| Ice Protection | SP.3.1 |
| Anti-Ice Use | SP.3.1 |
| Windshield Wiper Use | SP.3.1 |
| Automatic Flight | SP.4 |
| AFDS | SP.4.1 |
| AFDS Operation | SP.4.1 |
| Heading Hold | SP.4.1 |
| Heading Select | SP.4.2 |
| Altitude Hold | SP.4.2 |
| Flight Level Change, Climb or Descent | SP.4.2 |
| Vertical Speed, Climb or Descent | SP.4.3 |
| Intermediate Level Off | SP.4.4 |
| Speed Intervention | SP.4.4 |

| | |
|--|--------------|
| Autothrottle Operation | SP.4.5 |
| Instrument Approach Using (V/S) | SP.4.6 |
| Circling Approach | SP.4.7 |
| Autoland Status Annunciator Test | SP.4.8 |
| Autoland Status Annunciator Reset | SP.4.8 |
| Communications | SP.5 |
| Cockpit Voice Recorder Test | SP.5.1 |
| Aircraft Communications Addressing and Reporting System (ACARS) | SP.5.2 |
| Electrical | SP.6 |
| Electrical Power Up | SP.6.1 |
| Electrical Power Down | SP.6.2 |
| Operation With Less Than 90 KVA External Power Source | SP.6.2 |
| Before Start Procedure | SP.6.2 |
| Before Taxi Procedure | SP.6.3 |
| Shutdown Procedure | SP.6.3 |
| Standby Power Test | SP.6.4 |
| Transfer From External Power To APU Power | SP.6.4 |
| Hydraulic Generator Test | SP.6.4 |
| Engines, APU | SP.7 |
| Engines | SP.7.1 |
| Engine Crossbleed Start | SP.7.1 |
| Engine Ground Pneumatic Start | SP.7.1 |
| Reduced Thrust Selection Prior To Takeoff | SP.7.1 |
| Reduced Takeoff Thrust Change or Cancellation | SP.7.2 |
| Reduced Climb Thrust Change or Cancellation | SP.7.2 |
| Reduced Climb Thrust Selection In-flight | SP.7.2 |
| Fire Protection | SP.8 |
| Engine, APU and Cargo Fire/Overheat Test | SP.8.1 |
| Wheel Well Fire Detection Test | SP.8.1 |
| Flight Instruments, Displays | SP.10 |
| Flight Recorder Test | SP.10.1 |

767 Flight Crew Operations Manual

| | |
|---|--------------|
| Heading Reference Switch Operation | SP.10.1 |
| QFE Operation | SP.10.1 |
| Flight Management, Navigation | SP.11 |
| Transponder Test (TCAS equipped airplanes) | SP.11.1 |
| Weather Radar Test | SP.11.1 |
| IRS | SP.11.2 |
| Align Lights Flashing | SP.11.2 |
| Fast Realignment | SP.11.3 |
| High Latitude Alignment | SP.11.3 |
| Position Entry Using IRS Mode Selector Panel | SP.11.3 |
| Lateral Navigation | SP.11.4 |
| Alternate Route Entry/Activation | SP.11.4 |
| Direct To A Waypoint Using Overwrite | SP.11.4 |
| Estimate For Alternate | SP.11.4 |
| Holding Pattern Entry | SP.11.5 |
| Holding Pattern Exit | SP.11.5 |
| Intercept A Leg Or Course To A Waypoint Using Overwrite | SP.11.6 |
| Lateral Offset | SP.11.6 |
| Leg Modification | SP.11.7 |
| Route Removal | SP.11.7 |
| SID Change Or Runway Change | SP.11.8 |
| STAR, Profile Descent Or Approach Change | SP.11.8 |
| Vertical Navigation | SP.11.9 |
| Climb, Cruise Or Descent Speed Schedule Change | SP.11.9 |
| Climb Or Descent Direct To MCP Altitude | SP.11.9 |
| Cruise Altitude Change | SP.11.9 |
| Speed/Altitude Constraint At Waypoint | SP.11.10 |
| Speed/Altitude Transition And Restriction | SP.11.10 |
| Temporary Altitude Restriction | SP.11.10 |
| Temporary Speed Restriction | SP.11.11 |
| Performance Data Entries | SP.11.11 |
| Descent Forecast | SP.11.11 |
| Step Climb Evaluation | SP.11.11 |
| Waypoint Winds | SP.11.11 |
| Additional CDU Functions | SP.11.12 |
| Fix Page Entries | SP.11.12 |
| HSI Plan Mode Control | SP.11.12 |

| | |
|---|--------------|
| Navaid Inhibit | SP.11.12 |
| Update Active Navigation Database | SP.11.13 |
| Fuel | SP.12 |
| Fuel Balancing | SP.12.1 |
| Fuel Quantity Test | SP.12.1 |
| Warning Systems | SP.15 |
| EICAS Test | SP.15.1 |
| Event Record | SP.15.1 |
| Landing Configuration Warning Test | SP.15.1 |
| Stall Warning Test | SP.15.2 |
| Takeoff Configuration Warning Test | SP.15.2 |
| Adverse Weather | SP.16 |
| Introduction | SP.16.1 |
| Takeoff - Wet or Contaminated Runway Conditions | SP.16.1 |
| Cold Weather Operations | SP.16.2 |
| Exterior Inspection | SP.16.2 |
| Engine Start Procedure | SP.16.3 |
| Engine Anti-ice Operation - On the Ground | SP.16.3 |
| Before Taxi Procedure | SP.16.4 |
| Taxi-Out | SP.16.4 |
| De-icing / Anti-icing | SP.16.5 |
| Before Takeoff Procedure | SP.16.5 |
| Takeoff Procedure | SP.16.6 |
| Engine Anti-ice Operation - In-flight | SP.16.6 |
| Wing Anti-ice Operation - In-flight | SP.16.7 |
| Cold Temperature Altitude Corrections | SP.16.7 |
| After Landing Procedure | SP.16.9 |
| Secure Procedure | SP.16.11 |
| Hot Weather Operation | SP.16.12 |
| Moderate to Heavy Rain, Hail or Sleet | SP.16.12 |
| Turbulence | SP.16.13 |
| Severe Turbulence | SP.16.13 |
| Windshear | SP.16.14 |
| Avoidance | SP.16.14 |

DO NOT USE FOR FLIGHT

Supplementary Procedures -
Table of Contents

767 Flight Crew Operations Manual

Precautions SP.16.15

Intentionally
Blank

General

This chapter contains procedures (adverse weather operation, engine crossbleed start, and so on) that are accomplished as required rather than routinely performed on each flight. System tests which the flight crew are likely to perform are also included.

Procedures accomplished in flight, or those that are an alternate means of accomplishing normal procedures (such as selecting reduced T.O. thrust), are usually accomplished by memory. Infrequently used procedures, not normally accomplished (such as engine crossbleed start) are usually accomplished by reference.

Supplementary procedures are provided by section. Section titles correspond to the respective chapter title for the system being addressed except for the Adverse Weather section.

Intentionally
Blank

Doors

Entry Door Closing

Door Lower

Raise door slightly, push and hold uplatch release button, then lower door approximately 2 inches (5 centimeters). Then, release button and continue to lower door until closed.

The left forward door may be lowered electrically using the main door switch.

Door handle Down

Rotate to the down (flush) position.

Arming lever (interior only) SLIDE ARMED

While pushing arming lever release, position arming lever to SLIDE ARMED. Observe armed indicator in view and Direct Visual Indication of girt bar lockdown is completely yellow.

Entry Door Opening

Arming Lever (interior only) SLIDE DISARMED

Position arming lever to SLIDE DISARMED. Observe armed indicator out of view, arming lever release button extended and girt bar lockdown indications show blank.

Note: Slide disarms automatically when the door is opened from outside.

Door handle Up

Rotate aft to the up position.

Door Raise

Raise the door until the uplatch is engaged.

The left forward door may be raised electrically using the main door switch.

Flight Deck Door Access System Test

- Flight Deck Access System switch Norm
Flight Deck Door Open
Flight Deck Door Lock selector AUTO
Emergency access code Enter
ENT key Push
 Verify alert sounds.
 Verify AUTO UNLK light illuminates.
Flight Deck Door Lock selector DENY
 Verify AUTO UNLK light extinguishes.
Flight Deck Door Lock selector UNLKD
Flight Deck Access System switch OFF
 Verify LOCK FAIL light illuminates.
Flight Deck Access System switch NORM (guard down)
 Verify LOCK FAIL light extinguishes.

Windows

Flight Deck Window Closing

- Window crank Rotate
 Crank the window to the full closed position (the WINDOW NOT
 CLOSED placard not visible).
Window lock lever Rotate
 Rotate the window lock lever forward to the locked position.

Flight Deck Window Opening

- Window lock lever Rotate
 Rotate the window lock lever aft to the open position.
Window crank Rotate
 Crank the window to the full open position (the WINDOW NOT
 CLOSED placard is visible).

Lights

Indicator Lights Test

- INDICATOR LIGHTS TEST switch Push and hold
Verify all indicator lights in the flight deck, except lights in the fuel control and APU/engine fire switches illuminated.
- INDICATOR LIGHTS TEST switch Release

Emergency Equipment

Oxygen Mask Microphone Test

- BOOM/OXYGEN switch OXY
- RESET/TEST switch Push and hold
- EMERGENCY/TEST selector Push and hold
- Push to talk switch Push
Simultaneously push the push to talk switch, emergency/test selector, and reset/test switch.
Verify oxygen flow sound is heard through the flight deck loudspeaker.
- Push to talk switch Release
- EMERGENCY/TEST selector Release
- RESET/TEST switch Release

Intentionally
Blank

Air Conditioning Packs

Ground Conditioned Air Use

Before connecting ground conditioned air:

Pack Control selectors OFF
Prevents pack operation if bleed air is supplied to the airplane.

After disconnecting conditioned air:

Pack Control selectorsAUTO

Packs Off Takeoff

Before takeoff:

Pack Control selectors (both) OFF
Cabin Altitude Mode selector MAN
Position outflow valve approximately three-quarters open.
CABIN AUTO INOP message will be displayed.

After takeoff:

Note: If engine failure occurs, pack control selectors should remain OFF until reaching 1,500 feet or until obstacle clearance height has been attained, whichever is higher.

Pack Control selector (one only)AUTO
After engine thrust is reduced from takeoff, position one pack control selector to AUTO.

Cabin Altitude Mode selector AUTO 1 or AUTO 2

Pack Control selector (remaining pack)AUTO
When cabin pressurization stabilizes, position remaining pack control selector to AUTO.

Intentionally
Blank

Ice Protection

Ice protection is provided by the airplane anti-ice systems.

Anti-Ice Use

Requirements for use of anti-ice and operational procedures for engine and wing anti-ice are moved from SP.3 to Supplementary Procedures, Adverse Weather Section SP.16.

Windshield Wiper Use

CAUTION: Do not use windshield wipers on a dry window.

Windshield Wiper selector (as required) LOW/HIGH

Intentionally
Blank

AFDS

AFDS Operation

If Flight Director (F/D) operation is desired:

FLIGHT DIRECTOR switches ON

On ground, observe flight director command wings level and 8° pitch up and flight mode annunciations display TO, TO, FD.

In-flight, observe flight director command and flight mode annunciations display vertical speed (V/S) and heading hold (HDG HOLD) if no autopilot in command (CMD), or display existing autopilot modes if any autopilot in command (CMD).

Note: Command bars are not displayed if selected autopilot command mode and flight director source are the same.

AFDS Mode(s) Engage as desired

Observe flight director command and selected AFDS mode(s) is displayed.

If the autopilot is desired:

Command switch Engage

Observe flight mode annunciations display V/S and HDG HOLD, or existing AFDS modes if flight director on and not in takeoff or go-around mode.

Heading Hold

Rolls wings level and maintains the heading that exists at the time the wings become level.

Heading Hold switch Engage

Observe HDG HOLD displayed in the roll mode annunciator.

Heading Select

- Heading selector Set as desired
- Heading selector switch Push
Observe HDG SEL is displayed in the roll mode annunciator.
- Bank Limit selector Set as desired

Altitude Hold

- Altitude Hold switch Engage
Verify ALT HOLD is displayed in the pitch mode annunciator.

Flight Level Change, Climb or Descent

- Altitude selector Set
Set level off altitude in the altitude window.
- Flight Level Change switch Engage
Observe SPD in the pitch mode annunciator and FLCH displayed in the autothrottle mode annunciator.
- IAS/MACH selector Set
Set the desired speed in the speed window.
- Climb Thrust Reference Mode Select switch (if required) Select
If climb initiated, select climb reference N1.
- Climb Thrust Reference Mode Select switch (if required) Select
If climb initiated, select climb reference EPR.

Vertical Speed, Climb or Descent

Altitude selectorSet

Set level off altitude in the altitude window.

Vertical Speed switchEngage

Observe V/S displayed in the pitch mode annunciator.

Note: The vertical speed mode does not provide automatic low speed protection and permits flight away from selected altitude. For level-off protection, always select new level-off altitude prior to engaging vertical speed mode.

Vertical Speed selectorSet

Set desired rate in vertical speed window.

Climb Thrust Reference Mode Select switch (if required) Select

If climb initiated, select climb reference N1.

Climb Thrust Reference Mode Select switch (if required) Select

If climb initiated, select climb reference EPR.

Intermediate Level Off

Altitude selector Rotate
Set desired altitude in altitude window.

At MCP altitude:

Verify pitch mode annunciation is ALT HOLD.

To resume climb/descent:

Altitude selector Rotate
Set desired altitude in the altitude window.

If using VNAV:

VNAV switch Engage
Verify pitch mode annunciation is VNAV SPD or VNAV
PTH as appropriate.

If using Flight Level Change:

Flight Level Change switch Engage
Verify pitch mode annunciation is SPD and autothrottle
annunciation is FLCH.

IAS/MACH selector Rotate
Set the desired speed in the IAS/MACH window.

Speed Intervention

IAS/MACH selector Push
Verify IAS/MACH window opens.

IAS/MACH selector Rotate
Set the desired speed in the IAS/MACH window.

To resume FMC speed schedule:

IAS/MACH selector Push
Verify IAS/MACH window blanks.

Autothrottle Operation

Autothrottle switch A/T ARM

If EPR mode desired:

Thrust Reference Mode Select switch (As desired) Select
Select desired reference EPR.

THR switch Engage
Observe EPR displayed in the autothrottle mode annunciator.

If N1 mode desired:

Thrust Reference Mode Select switch (As desired) Select
Select desired reference N1.

THR switch Engage
Observe N1 displayed in the autothrottle mode annunciator.

If Speed mode desired:

Thrust Reference Mode Select switch (As desired) Select
Select desired reference N1.
Select desired reference EPR.

Speed switch Engage
Observe SPD displayed in the autothrottle mode annunciator.

IAS/MACH selector Set
Set the desired speed in the IAS/MACH window.

Instrument Approach Using (V/S)

Note: Autopilot use is recommended until suitable visual reference is established.

Note: If required to remain at or above the MDA(H) during the missed approach, missed approach must be initiated at least 50 feet above MDA(H).

Recommended roll modes for final approach:

- LOC-BC, VOR or NDB approach: LNAV or HDG SEL (B/CRS for LOC-BC approaches)
- LOC, SDF, or LDA approach: LOC or LNAV

Ensure appropriate nav aids (VOR, LOC or NDB) are tuned and identified prior to commencing the approach.

RNP appropriate for approach (if required) Verify/Enter
Allows appropriate alerting to occur if ANP exceeds RNP.

Before descent to MDA(H):

MCP altitude selector Set
Set the first intermediate altitude constraint or MDA(H). When the current constraint is assured, the next constraint may be set prior to ALT HOLD engaged to achieve continuous descent path.

If constraints or MDA(H) do not end in zero zero (00; for example, 1820), set MCP ALTITUDE window to the closest 100 foot increment below the constraint or MDA(H).

At descent point:

V/S switch Push
Verify V/S Mode annunciates.

Desired V/S Set
Set desired V/S to descend to MDA(H). Use a V/S that results in no level flight segment at MDA(H).

Approximately 300 feet above MDA(H):

MCP altitude selector Set Missed Approach Altitude

At MDA(H)/Missed Approach Point:

If suitable visual reference is not established, execute missed approach.

After suitable visual reference is established:

A/P Disengage Switch Push

Disengage autopilot before descending below
MDA(H)/DA(H)

A/T Disconnect Switch Push

Disconnect autothrottle before descending below
MDA(H)/DA(H)

Circling Approach

Note: Autopilot use is recommended until intercepting the landing profile.

MCP Altitude Selector Set

If the MDA(H) does not end in zero zero (00; for example, 1820), set MCP ALTITUDE window to the closest 100 foot increment below the MDA(H)

Accomplish an instrument approach and establish suitable visual reference.

At MDA(H):

ALT HOLD switch (if required) Push

Enables level off at MDA(H). Verify ALT HOLD mode annunciates.

MCP altitude selector Set Missed Approach Altitude

HDG SEL Switch Push

Verify HDG SEL mode annunciates.

Intercepting the landing profile:

Autopilot disengage switch Push

Autothrottle disconnect switch Push

Autoland Status Annunciator Test

AUTOLAND STATUS ANNUNCIATOR TEST switch 1 Push
Observe LAND 3 and NO LAND 3 in view.

AUTOLAND STATUS ANNUNCIATOR TEST switch 2 Push
Observe LAND 2 and NO AUTOLND in view.

Autoland Status Annunciator Reset

AUTOLAND STATUS ANNUNCIATOR
PUSH/RESET switch Push

Cockpit Voice Recorder Test

Voice Recorder Test switch.....Push

Push and observe monitor indicator needle to be in the green band.
A tone may be heard with headset plugged into headset jack. Test
will last approximately 5 seconds.

Aircraft Communications Addressing and Reporting System (ACARS)

The following procedures are applicable to the noted ACARS functions from the company pages.

Pre-Departure Clearance

The flight crew shall manually verify (compare) the filed flight plan versus the digital pre-departure clearance and shall initiate voice contact with Air Traffic Control if any question/confusion exists between the filed flight plan and the digital pre-departure clearance.

Digital-Automatic Information Service (D-ATIS)

The flight crew shall verify that the D-ATIS altimeter setting numeric value and alpha value are identical. If the D-ATIS altimeter setting numeric and alpha values are different, the flight crew must not accept the D-ATIS altimeter setting.

Oceanic Clearances

The flight crew shall manually verify (compare) the filed flight plan versus the digital oceanic clearance and shall initiate voice contact with Air Traffic Control if any question/confusion exists between the filed flight plan and the digital oceanic clearance.

Weight and Balance

The flight crew shall verify the Weight and Balance numeric and alphabetical values are identical. If the Weight and Balance numeric and alphabetical values are different, the flight crew must not accept the Weight and Balance data.

Takeoff Data

The flight crew shall verify the Takeoff Data numeric and alphabetic values are identical. If the Takeoff Data numeric and alphabetic values are different, the flight crew must not accept the Takeoff Data message.

Electrical Power Up

The following procedure is accomplished to permit safe application of electrical power.

Battery switch ON

Standby Power selector AUTO

Verify battery DISCH light illuminated and standby bus OFF light extinguishes.

Hydraulic Electric Primary Pump switches Off

Hydraulic Demand Pump switches Off

Landing Gear Lever DN

Alternate Flaps selector NORM

Electrical Power Establish

Bus Tie switches AUTO

If external power is desired:

If External Power AVAIL light is illuminated:

External Power switch Push

If APU power is desired:

APU Generator switch ON

APU selector START, then ON

Position the APU selector back to the ON position. Do not allow the APU selector to spring back to the ON position.

Electrical Power Down

The following flight deck procedures are accomplished to permit removal of electrical power from the airplane.

APU selector/External Power switch Off

When APU RUN light extinguishes:

Standby Power selector OFF

Battery switch OFF

Operation With Less Than 90 KVA External Power Source

When external power source is less than required (90 KVA), airplane electrical loads must be minimized by supplementing normal procedures as follows:

Before Start Procedure

Accomplish normal exterior Inspection, Preflight Procedure – First Officer, Preflight Procedure – Captain and Before Start Procedure through “Start Clearance.....Obtain”.

Confirm cargo loading complete.

Utility Bus switches OFF

Hydraulic System Set

Demand Pump selector (right) AUTO

Observe PRESS light extinguished.

Fuel Pump switches (one left and one right main wing) ON

Observe PRESS lights extinguished.

Note: Delay activation of the remaining hydraulic and fuel pumps, setting trim and checking flight controls until after engines are started.

Complete the normal Before Start and Engine Start procedures.

Before Taxi Procedure

| | |
|---|-------|
| Hydraulic System | Set |
| Electric Primary Pump switches (both) | ON |
| Demand Pump selectors (remaining pumps) | AUTO |
| Utility Bus switches | ON |
| Fuel Pump switches (remaining pumps) | ON |
| Position switches ON for all tanks containing fuel. | |
| Trim | Set |
| Flight controls | Check |

Displace control wheel and control column to full travel in both directions and verify:

- freedom of movement
- controls return to center
- proper flight control movement on EICAS status display.

Hold the nose wheel steering tiller during rudder check to prevent undesired nose wheel movement.

Displace rudder pedals to full travel in both directions and verify:

- freedom of movement
- rudder pedals return to center
- proper flight control movement on EICAS status display.

Complete normal Before Taxi procedure.

Shutdown Procedure

After park brake is set and prior to establishing external power:

| | |
|---|-----|
| Hydraulic System | Set |
| Electric Primary Pump switches (both) | OFF |
| Demand Pump selectors (All) | OFF |
| Fuel Pump switches | OFF |

Accomplish normal Shutdown procedure.

Standby Power Test

Airplane must be on ground with all busses powered.

Standby Power SelectorBAT

Observe battery DISCH light illuminates and standby power
OFF light remains extinguished.

Standby Power SelectorAUTO

Observe battery DISCH light extinguishes and standby power
OFF light remains extinguished.

Transfer From External Power To APU Power

Prior to disconnecting external power:

External Power switch Push

Observe ON light extinguish.

Hydraulic Generator Test

Electrical and pneumatic power must be established on the airplane.

Center 1/2 Electric Primary Pump Switches OFF

Center Air Demand Pump Selector AUTO

EICAS Status Display ON

Hydraulic Generator Test Switch HYD GEN

While holding the test switch in the HYD GEN position, verify the
HYD GEN ON and HYD GEN VAL Status messages appear on
EICAS, and Captain ADI and HSI are powered with no flags
displayed. The HYD GEN ON and HYD GEN VAL messages should
no longer be displayed when the test switch is released.

Engines

Engine Crossbleed Start

The APU must be shut down or the APU bleed air switch must be OFF

Check that the area behind the airplane is clear

Engine Bleed Air switch (operating engine) ON

Advance thrust on operating engine to approximately 70% N2 and accomplish normal Engine Start procedure

Engine Ground Pneumatic Start

Check duct pressure 30 psi or greater

Start engine using normal Engine Start procedure

Reduced Thrust Selection Prior To Takeoff

If reduced takeoff thrust desired:

Assumed Temperature Set

Rotate assumed temperature selector clockwise and set desired temperature value or enter required temperature on Takeoff Reference page

Observe D–TO displayed in green on the EICAS

If reduced climb thrust desired:

Thrust Reference Mode Select switch 1 or 2

Select desired climb thrust reference; 1 or 2

Observe TO 1 or TO 2 (D-TO 1 or D-TO 2 for an assumed temperature derated takeoff) displayed on the EICAS in green for the TO or D-TO and in white for the numerals 1 or 2

Reduced Takeoff Thrust Change or Cancellation

If change desired:

Assumed Temperature Set

Enter new temperature value on Takeoff Reference page

If cancellation desired:

Thrust Reference Mode Select switch As desired

Select desired thrust reference mode; TO/GA, CLB, CON or CRZ

Observe associated mode displayed

Note: If full takeoff thrust desired during takeoff following 80 knots (autothrottle in THR HOLD mode) thrust levers must be adjusted manually.

Reduced Climb Thrust Change or Cancellation

If change desired:

Thrust Reference Mode Select switch 1 or 2

Select desired climb thrust reference; 1 or 2

Observe CLB 1 or CLB 2 (TO 1 or TO 2; ground only) displayed

If cancellation desired:

Thrust Reference Mode Select switch 1 or 2

Push switch associated with current thrust reduction

Observe CLB or TO (ground only) displayed

Note: If preselected reduced climb thrust is changed or cancelled and reduced takeoff thrust is still desired, reduced takeoff thrust must be reselected.

Reduced Climb Thrust Selection In-flight

Thrust Reference Mode Select switch CLB

Observe CLB displayed

Thrust Reference Mode Select switch 1 or 2

Select desired thrust reference; 1 or 2

Observe CLB 1 or CLB 2 displayed

Engine, APU and Cargo Fire/Overheat Test

Engine/APU/Cargo Fire/Overheat Test switch Push

Observe the fire bell ring intermittently

Observe the following lights illuminate:

Discrete FIRE warning

Fuel control switches

L and R ENG OVHT

LEFT, RIGHT and APU fire switches

FWD and AFT cargo fire

Master Warning

Observe the following EICAS messages:

APU FIRE warning

FWD and AFT CARGO FIRE warning

L and R ENGINE FIRE warning

L and R ENG OVHT caution

Wheel Well Fire Detection Test

Wheel Well Fire Test switch Push

Observe the fire bell ring intermittently

Observe the following lights illuminate:

Discrete FIRE warning

WHL WELL FIRE

Master Warning

Observe the following EICAS message:

WHEEL WELL FIRE warning

Intentionally
Blank

Flight Recorder Test

Flight Recorder switch Test
Observe OFF light extinguish.

Heading Reference Switch Operation

Use TRUE when flying in regions where true referencing is required. Use NORM at other times.

Heading Reference switch NORM or TRUE

Note: The following information applies when using the Heading Reference switch:

- If the AFDS is in the HDG SEL mode and the Heading Reference switch position is changed, the AFDS mode changes to HDG HOLD; HDG SEL may be reselected.
- If making an ILS approach using true referencing, the localizer course referenced to true north must be set on the ILS control panel.
- VOR bearings are not available when the Heading Reference switch is in TRUE.

QFE Operation

Use this procedure when ATC altitude assignments are referenced to QFE altimeter settings, and QNH settings are not available.

Note: Do not use LNAV or VNAV below transition altitude/level. Altitudes in the navigation data base are not referenced to QFE. Use only raw data for navigation.

Altimeters Set
Set primary and standby altimeters to QFE below transition altitude/level.

Note: If the QFE altimeter setting is beyond the range of the altimeters, QNH procedures must be used with QNH set in the altimeters.

Landing Altitude Indicator Set at Zero

Intentionally
Blank

Transponder Test (TCAS equipped airplanes)

This procedure requires the IRSs to be aligned and in NAV mode.

Transponder Mode selector TEST
Verify "TCAS TEST" aural sounds, and "TCAS TEST PASS" aural sounds.

Weather Radar Test

Weather Radar Mode TEST
HSI Mode selector MAP
Weather Radar switch ON
Observe radar test pattern on HSI.

Note: If the airplane is on the ground and the thrust levers are not advanced for takeoff, the WXR tests the predictive windshear system (PWS) indications. These include the WINDSHEAR SYS EICAS advisory, the PWS caution, and PWS warning. Deactivating WXR on the EFIS control panel will not discontinue the test and can result in automatic WXR activation on both pilot displays. The PWS test lasts approximately 15 seconds.

Note: If the airplane is on the ground and the thrust levers are not advanced for takeoff, the WXR tests the predictive windshear system (PWS) indications. These include the WINDSHEAR SYS EICAS advisory, the PWS caution, and PWS warning. Deactivating WXR on the EFIS control panel will discontinue the test. The PWS test lasts approximately 15 seconds.

Weather Radar switch OFF
Select captain's and first officer's weather radar displays off.

Weather Radar Mode As desired

IRS

Align Lights Flashing

Do not move IRS Mode selector to OFF except where called for in procedure.

POS INIT page Select

Set IRS Position Enter Present Position

Enter present position using most accurate latitude and longitude available. If a position is already displayed on the SET IRS POS line, enter new position over displayed position.

If ALIGN light continues to flash:

Set IRS Position Enter Present Position

Re-enter same present position.

If ALIGN light continues to flash after re-entry:

IRS OFF

Rotate IRS Mode selector to OFF and verify ALIGN light extinguished.

Note: Light must be extinguished before continuing with procedure (approximately 30 seconds).

IRS NAV

Rotate IRS Mode selector to NAV and verify ALIGN light illuminated.

Set IRS Position Enter

Enter present position in boxes. If ALIGN light flashes, re-enter same present position over displayed position.

Note: Approximately ten minutes is required for realignment.

If ALIGN light continues to flash, maintenance action is required.

Fast Realignment

If the combined operating time from the last full IRS alignment to the expected next destination arrival time does not exceed 18 hours, a fast realignment may be accomplished.

IRS Mode selectors ALIGN

CDUSet

Enter present position on SET IRS POSITION line of Position Initialization page.

IRS Mode selectorsNAV

High Latitude Alignment

This procedure applies to alignment at latitudes greater than 70°12.0' and less than 78°15.0'.

IRS Mode selectors OFF, then ALIGN

POS INIT pageSet

Enter present position on SET IRS POS line using the most accurate latitude and longitude available.

IRS Mode selectorsNAV

Select NAV after remaining in ALIGN for 17 minutes minimum.
Verify ALIGN lights extinguished.

Position Entry Using IRS Mode Selector Panel

Latitude Enter

Begin with N or S, followed by latitude including trailing zeros, i.e., N003°30.0' entered as N3300.

Longitude Enter

Begin with E or W, followed by longitude including trailing zeros, i.e., E001°11.0' entered as E1110.

Lateral Navigation

Alternate Route Entry/Activation

Desired RTE page 1 Select

If desired route (1 or 2) not displayed, select desired route.

Route (if required) Enter

Enter route using preflight procedure.

ACTIVATE Select

If in-flight, use DIRECT TO or INTC LEG TO boxes to enter desired course from present position to new route.

EXEC key Push

Direct To A Waypoint Using Overwrite

RTE LEGS page Select

Desired Waypoint Enter

Enter the desired waypoint over the active waypoint.

Waypoint Sequence Check

Enter waypoints in desired sequence.

EXEC key Push

Estimate For Alternate

PROGRESS page 1 Select

Desired Destination Enter

Note: Estimates displayed are for present position direct.

Holding Pattern Entry

Holding fix must be a route waypoint or present position before accomplishing following steps.

HOLD key Push

NEXT HOLD (if displayed) Select

Holding Fix Enter

To hold at present position, select PPOS. To hold at waypoint, enter waypoint identifier in HOLD AT boxes.

HOLD page Check

EXEC key Push

Holding Pattern Exit

To exit holding accomplish the following procedure or refer to one of the "Direct to a Waypoint" procedures.

EXIT HOLD Select

EXEC key Push

Intercept A Leg Or Course To A Waypoint Using Overwrite

RTE LEGS page Select

Desired Waypoint Enter

Enter the desired waypoint over the active waypoint.

Note: If waypoint not previously in route, a discontinuity occurs.

If waypoint was previously in route, the inbound course is set to same inbound great circle course. For airways, displayed course may not be identical to charted value.

If inbound course not correct:

Intercept Course Enter

Enter course desired at waypoint in INTC CRS TO boxes (or over existing intercept course to value if waypoint was already in route).

EXEC key Push

Waypoint Sequence Check

Enter waypoints in desired sequence.

EXEC key Push

If necessary, use Heading Select mode to change intercept heading. Then, arm LNAV mode.

Lateral Offset

RTE page Select

Offset Enter

Enter desired offset direction and distance over OFFSET dashes.

EXEC key Push

To remove offset, accomplish Direct To procedure or enter "0" in OFFSET line.

Leg Modification

To modify active waypoint or leg, accomplish one of the Direct To or Intercept A Leg Or Course procedures except when entering along track waypoints.

RTE LEGS page Select

To change waypoint sequence:

Desired Waypoint Sequence Enter

Note: If waypoint not previously in route a discontinuity occurs except when entering along track waypoints.

EXEC key Push

To delete a waypoint at end of route:

DEL key Push

Waypoint Select

EXEC key Push

To enter along track waypoints:

Along Track Displacement Enter

Select reference waypoint to scratch pad and modify for desired displacement.

Reference Waypoint Select

The FMC will automatically position the created waypoint to the appropriate position.

EXEC key Push

Route Removal

RTE page 1 Select

Origin Enter

If EXEC key illuminates:

EXEC key Push

SID Change Or Runway Change

This entire procedure must be accomplished when a SID is used and the runway or SID is changed. This will prevent the possibility of incorrect routing or inadequate obstacle clearance.

- DEPARTURES page Select
- Runway Reselect
- SID Reselect
- Transition (if required) Reselect
- RTE LEGS page Select
- Waypoint Sequence and Altitudes Check
 Modify as necessary to agree with clearance.
- EXEC key Push

STAR, Profile Descent Or Approach Change

Associated airport must be entered as route origin or destination.

- ARRIVALS page Select
- STAR or Profile Descent (if required) Select
- Transition (if required) Select
- Approach Select
- Approach Transition (if required) Select
- RTE LEGS page Select
- Waypoint Sequence and Altitudes Check
 Modify as necessary to agree with clearance.
- EXEC key Push

Vertical Navigation

Climb, Cruise Or Descent Speed Schedule Change

CLB or CRZ or DES page Select

To change schedule:

Desired Schedule Select

To enter fixed speed schedule:

Desired Speed Enter

Enter speed on ECON/SEL SPD line (line 2L).

EXEC key Push

Climb Or Descent Direct To MCP Altitude

This procedure deletes all waypoint altitude constraints between current airplane altitude and altitude set in MCP.

Altitude Window Set

CLB or DES page Select

CLB DIR or DES DIR Select

EXEC key Push

Cruise Altitude Change

Altitude Window Set

CRZ page Select

Cruise Altitude Enter

EXEC key Push

Speed/Altitude Constraint At Waypoint

RTE LEGS page Select

To enter or modify constraint:

Speed/Altitude Enter

Note: Speed entry requires "/" mark and altitude.

EXEC key Push

To delete constraint:

DEL key Push

Speed/Altitude Select

Select undesired constraint and observe estimated values appear.

EXEC key Push

Speed/Altitude Transition And Restriction

CLB or DES page Select

To enter speed/altitude restriction:

Speed/Altitude Enter

EXEC key Push

To delete speed/altitude restriction or transition:

DEL key Push

Speed/Altitude Select

EXEC key Push

Temporary Altitude Restriction

Altitude Window Set

To resume climb or descent:

Altitude Window Set

VNAV Engage

Temporary Speed Restriction

- IAS/MACH selector Push
 - Speed Window Set
 - To resume FMC speed schedule:
 - IAS/MACH selector Push
-

Performance Data Entries

Descent Forecast

- DES page Select
- DESCENT FORECAST page Select
- Transition Level Check
- Thermal Anti-ice On Altitude (if required) Enter
- Wind Altitude Enter
 - Enter altitude over dashes on left.
- Wind Direction/Speed Enter

Step Climb Evaluation

- CRZ page Select
- Step to Altitude Enter
- Savings Check

Waypoint Winds

- RTE LEGS page Select
- RTE DATA page Select
- WINDS page Select
- Altitude and Wind Enter
- EXEC key Push

Additional CDU Functions

Fix Page Entries

FIX page Select

Fix IdentifierEnter

Bearing or Distance From FixEnter

Enter desired bearing or distance or select ABEAM.

Note: Bearing/distance from fix may be used as route waypoint.

HSI Plan Mode Control

HSI ModePLAN

RTE LEGS page Select

Map Center Step Select

Navaid Inhibit

To inhibit use of radio navigation aids from position updating:

INIT REF page Select

INDEX page Select

NAV DATA page Select

Navaid IdentifierEnter

To inhibit use of a VOR and DME:

NAVAID lineEnter

To inhibit use of a VOR only:

VOR ONLY lineEnter

To inhibit use of all VORs:

VOR/DME NAV OFF/ON prompt Select

ALL is displayed in the VOR ONLY inhibit line and OFF is displayed in large font.

Update Active Navigation Database

The navigation database can be changed only on the ground. Changing the database removes all previously entered route data.

INIT REF Select

IDENT page Enter

Inactive Date line Enter

Transfers inactive date range to scratchpad

Active Date line Enter

Transfers inactive database line to active database line. Transfers active database line to the inactive database line.

Intentionally
Blank

Fuel Balancing

If an engine fuel leak is suspected:

Accomplish the ENGINE FUEL LEAK checklist

Note: Fuel pump pressure should be supplied to the engines at all times. At high altitude, without fuel pump pressure, thrust deterioration or engine flameout may occur.

When the fuel quantities in left main and right main tanks differ by an appreciable amount:

- Crossfeed switches (both) ON
- Fuel pump switches (low quantity tank) OFF

When fuel load balanced:

- Fuel pump switches ON
- Crossfeed switches (both) OFF

Fuel Quantity Test

Fuel Quantity Test switch FUEL QTY

Observe FUEL CONFIG light illuminate and LOW FUEL message display

Observe fuel quantity indicators display all eights (8) except initial digit in total fuel quantity indicator which displays one (1). Observe fuel temperature indicator display -188 degrees Centigrade.

Intentionally
Blank

EICAS Test

This procedure requires the airplane to be on the ground and parking brake set.

EICAS Test switch Push

Wait 5 seconds and switch to L then R.

Observe TEST OK message displayed on CRTs in both positions.

Note: Standby engine indications will be displayed during test and siren aural will sound.

EICAS Test switch Push

Event Record

Event Record switch Push

Use as directed by Flight Operations for maintenance analysis or at the discretion of the captain to manually record parameters for a suspect condition.

Landing Configuration Warning Test

Configuration Test switch LDG

Observe CONFIG light illuminate and GEAR NOT DOWN message display.

Stall Warning Test

L Stall Warning Test switch STALL

Observe control columns vibrate.

R Stall Warning Test switch STALL

Observe control columns vibrate.

L and R Stall Warning Test switches STALL

Observe both stall warning systems vibrate control columns and also move control columns forward.

Note: A minimum of one hydraulic system must be pressurized for proper verification of the control column nudger.

Takeoff Configuration Warning Test

Establish one or more of the following conditions:

Flaps not in takeoff position

Speedbrakes not down

Stabilizer units set greater than green band

Park brake set

Configuration Test switch T/O

Observe CONFIG light illuminate, and appropriate configuration warning message(s) display.

Establish appropriate configuration.

Introduction

Airplane operation in adverse weather conditions may require additional considerations due to the effects of extreme temperatures, precipitation, turbulence, and windshear. Procedures in this section supplement normal procedures and should be observed when applicable.

Takeoff - Wet or Contaminated Runway Conditions

The following information applies to takeoffs on wet or contaminated runways:

- For wet runways, reduced thrust (assumed temperature method) is allowed provided suitable takeoff performance accountability is made for the increased stopping distance on a wet surface.
- For runways contaminated by slush, snow, standing water or ice, reduced thrust (assumed temperature method) is not allowed.
- V1 may be reduced to minimum V1 to provide increased stopping margin provided the field length required for a continued takeoff from the minimum V1 and obstacle clearance meet the regulatory requirements. The determination of such minimum V1 may require a real-time performance calculation tool or other performance information supplied by dispatch.
- Takeoffs are not recommended when slush, wet snow, or standing water depth is more than 1/2 inch (13 mm) or dry snow depth is more than 4 inches (102 mm).

Cold Weather Operations

Considerations associated with cold weather operation are primarily concerned with low temperatures and with ice, snow, slush and standing water on the airplane, ramps, taxiways, and runways.

Icing conditions exist when OAT (on the ground) or TAT (in-flight) is 10°C or below and any of the following exist:

- visible moisture (clouds, fog with visibility of one statute mile (1600 m) or less, due to metrological conditions such as rain, snow, sleet, ice crystals), or
- ice, snow, slush or standing water is present on the ramps, taxiways, or runways.

CAUTION: Do not use engine anti-ice when OAT (on the ground) is above 10°C. Do not use engine or wing anti-ice when TAT (in-flight) is above 10°C.

Exterior Inspection

Although removal of surface snow, ice and frost is normally a maintenance function, during preflight procedures, the captain or first officer should carefully inspect areas where surface snow, ice or frost could change or affect normal system operations.

Do the normal Exterior Inspection with the following additional steps:

Surfaces Check

Takeoff with light coatings of frost, up to 1/8 inch (3mm) in thickness, on lower wing surfaces due to cold fuel is allowable; however, all leading edge devices, all control surfaces, and upper wing surfaces must be free of snow, ice and frost.

Thin hoarfrost is acceptable on the upper surface of the fuselage provided all vents and ports are clear. Thin hoarfrost is a uniform white deposit of fine crystalline texture, which usually occurs on exposed surfaces on a cold and cloudless night, and which is thin enough to distinguish surface features underneath, such as paint lines, markings or lettering.

Pitot/static probes and static ports Check

Verify that all pitot/static probes and static ports are free of snow and ice. Water rundown after snow removal may freeze immediately forward of static ports and cause an ice buildup which disturbs airflow over the static ports resulting in erroneous static readings even when static ports are clear.

-
- Air conditioning inlets and exits Check
Verify that the air inlets and exits, including the outflow valve, are free of snow and ice.
- Engine inlets Check
Verify that the inlet cowling is free of snow and ice.
- Fuel tank vents Check
Verify that all traces of ice and frost are removed.
- Landing gear doors Check
Landing gear doors should be free of snow and ice.
- APU air inlets Check
The APU inlet door must be free of snow and ice before APU start.

Engine Start Procedure

Do the normal Engine Start Procedure with the following considerations:

- Oil pressure may be slow to rise
- Initial oil pressure rise may be higher than normal
- Additional warm-up time may be needed to allow oil temperature to reach the normal range

Engine Anti-ice Operation - On the Ground

Engine anti-ice must be selected ON immediately after both engines are started and remain on during all ground operations when icing conditions exist or are anticipated, except when the temperature is below -40°C OAT.

WARNING: Do not rely on airframe visual icing cues before activating engine anti-ice. Use the temperature and visible moisture criteria because late activation of engine anti-ice may allow excessive ingestion of ice and result in engine damage or failure.

CAUTION: Do not use engine anti-ice when OAT is above 10°C .

When engine anti-ice is needed:

ENGINE ANTI-ICE switches ON F/O

When engine anti-ice is no longer needed:

ENGINE ANTI-ICE switches OFF F/O

Before Taxi Procedure

Do the normal Before Taxi Procedure with the following modifications:

If taxi route is through ice, snow, slush or standing water in low temperatures or if precipitation is falling with temperatures below freezing, taxi out with the flaps up. Taxiing with the flaps extended subjects the flaps and flap drives to contamination. Leading edge devices are also susceptible to slush accumulations.

Call “FLAPS ___” as needed. C

Flap lever Set flaps, as needed F/O

Taxi-Out

CAUTION: Taxi at a reduced speed. Use smaller tiller and rudder inputs, and apply minimum thrust evenly and smoothly. Taxiing on slippery taxiways or runways at excessive speed or with high crosswinds may start a skid.

When engine anti-ice is required and the OAT is 3°C or below, do an engine run up, as needed, to minimize ice build-up. Use the following procedure: C

Check that the area behind the airplane is clear.

When the aircraft is equipped with GE 802C engines.

Run-up to a minimum of 60% N1 for approximately 30 seconds duration at intervals no greater than 30 minutes.

When the aircraft is equipped with PW4000 engines.

Run-up to a minimum of 50% N1 for approximately 1 second duration at intervals no greater than 15 minutes.

De-icing / Anti-icing

Testing of undiluted de-icing/anti-icing fluids has shown that some of the fluid remains on the wing during takeoff rotation and initial climb. The residual fluid causes a temporary decrease in lift and increase in drag, however, the effects are temporary. Use the normal takeoff rotation rate.

If de-icing / anti-icing is needed:

Call "FLAPS UP". C

Flaps UP F/O
Prevents ice and slush from accumulating in flap cavities during de-icing.

Thrust levers Idle C
Reduces the possibility of injury to personnel at inlet or exhaust areas.

Engine BLEED air switches OFF F/O
Reduces the possibility of fumes entering the air conditioning system.

APU BLEED air switch OFF F/O
Reduces the possibility of fumes entering the air conditioning system.

After de-icing / anti-icing is completed:

Wait approximately one minute after de-icing is completed to turn BLEED air switches on to ensure all de-icing fluid has been cleared:

Engine BLEED air switches ON F/O

APU BLEED air switch ON F/O

Before Takeoff Procedure

Do the normal Before Takeoff Procedure with the following modification:

Call "FLAPS ____" as needed for takeoff. PF

Flap lever Set takeoff flaps, as needed PM
Extend the flaps to the takeoff setting at this time if they have been held because of slush, standing water, or icing conditions, or because of exterior de-icing / anti-icing.

Takeoff Procedure

Do the normal Takeoff Procedure with the following modification:

When engine anti-ice is required and the OAT is 3°C or below, the takeoff must be preceded by a static engine run-up.

Use the following procedure: PF

When the aircraft is equipped with GE 80C2 engines.

Run-up to a minimum of 60% N1 for approximately 30 seconds duration and confirm stable engine operation before the start of the takeoff roll.

When the aircraft is equipped with PW4000 engines.

Run-up to a minimum of 50% N1 and confirm stable engine operation before the start of the takeoff roll.

Engine Anti-ice Operation - In-flight

Engine anti-ice must be ON during all flight operations when icing conditions exist or are anticipated, except when the temperature is below -40°C SAT.

WARNING: Do not rely on airframe visual icing cues before activating engine anti-ice. Use the temperature and visible moisture criteria because late activation of engine anti-ice may allow excessive ingestion of ice and result in engine damage or failure.

CAUTION: Do not use engine anti-ice when TAT is above 10°C.

When engine anti-ice is needed:

ENGINE ANTI-ICE switches ON PM

When engine anti-ice is no longer needed:

ENGINE ANTI-ICE switchesOFF PM

Fan Ice Removal

When the aircraft is equipped with GE 80C2 engines.

CAUTION: Avoid prolonged operation in moderate to severe icing conditions.

If moderate to severe icing conditions are encountered:

During flight in moderate to severe icing conditions for prolonged periods with N1 settings at or below 70%, or if fan icing is suspected due to high engine vibration, increase thrust on one engine at a time to a minimum of 70% N1 for 10 to 30 seconds every 10 minutes.

Wing Anti-ice Operation - In-flight

Ice accumulation on the flight deck window frames, windshield center post, or windshield wiper arm, or side windows may be used as an indication of structural icing conditions and the need to turn on wing anti-ice.

The wing anti-ice system may be used as a de-icer or anti-icer in flight only. The primary method is to use it as a de-icer by allowing ice to accumulate before turning wing anti-ice on. This procedure provides the cleanest airfoil surface, the least possible runback ice formation, and the least thrust and fuel penalty. Normally it is not necessary to shed ice periodically unless extended flight through icing conditions is necessary (holding).

The secondary method is to select the WING ANTI-ICE switch ON when wing icing is possible and use the system as an anti-icer.

CAUTION: Do not use wing anti-ice when TAT is above 10°C.

When wing anti-ice is needed:

WING ANTI-ICE switch ON PM

When wing anti-ice is no longer needed:

WING ANTI-ICE switch OFF PM

Cold Temperature Altitude Corrections

Extremely low temperatures create significant altimeter errors and greater potential for reduced terrain clearance. When the temperature is colder than ISA, true altitude will be lower than indicated altitude. Altimeter errors become significantly larger when the surface temperature approaches -30°C or colder, and also become larger with increasing height above the altimeter reference source.

Apply the altitude correction table when needed:

- no corrections are needed for reported temperatures above 0°C or if the airport temperature is at or above the minimum published temperature for the procedure being flown
- do not correct altimeter barometric reference settings
- ATC assigned altitudes or flight levels should not be adjusted for temperature when under radar control
- corrections apply to QNH and QFE operations
- apply corrections to all published minimum departure, en route and approach altitudes, including missed approach altitudes, according to the table below. Advise ATC of the corrections
- MDA/DA settings should be set at the corrected minimum altitudes for the approach
- subtract the elevation of the altimeter barometric reference setting source (normally the departure or destination airport elevation) from the published minimum altitude to be flown to determine “height above altimeter reference source”
- enter the table with Airport Temperature and with “height above altimeter reference source.” Read the correction where these two entries intersect. Add the correction to the published minimum altitude to be flown to determine the corrected indicated altitude to be flown. To correct an altitude above the altitude in the last column, use linear extrapolation (e.g., to correct 6000 feet or 1800 meters, use twice the correction for 3000 feet or 900 meters, respectively) The corrected altitude must always be greater than the published minimum altitude
- if the corrected indicated altitude to be flown is between 100 foot increments, set the MCP altitude to the closest 100 foot increment above the corrected indicated altitude to be flown.

Altitude Correction Table - Heights and Altitudes in Feet

| Airport Temp °C | Height Above Altimeter Source | | | | | | | | | | | |
|-----------------|-------------------------------|----------|----------|----------|----------|----------|----------|----------|-----------|-----------|-----------|-----------|
| | 200 feet | 300 feet | 400 feet | 500 feet | 600 feet | 700 feet | 800 feet | 900 feet | 1000 feet | 1500 feet | 2000 feet | 3000 feet |
| 0° | 20 | 20 | 30 | 30 | 40 | 40 | 50 | 50 | 60 | 90 | 120 | 170 |
| -10° | 20 | 30 | 40 | 50 | 60 | 70 | 80 | 90 | 100 | 150 | 200 | 290 |
| -20° | 30 | 50 | 60 | 70 | 90 | 100 | 120 | 130 | 140 | 210 | 280 | 420 |
| -30° | 40 | 60 | 80 | 100 | 120 | 140 | 150 | 170 | 190 | 280 | 380 | 570 |
| -40° | 50 | 80 | 100 | 120 | 150 | 170 | 190 | 220 | 240 | 360 | 480 | 720 |
| -50° | 60 | 90 | 120 | 150 | 180 | 210 | 240 | 270 | 300 | 450 | 590 | 890 |

767 Flight Crew Operations Manual

Altitude Correction Table - Heights and Altitudes in Meters

| Airport Temp °C | Height Above Altimeter Source | | | | | | | | | | | |
|-----------------------|-------------------------------|------------|-------------|-------------|-------------|-------------|-------------|-------------|-------------|-------------|-------------|-------------|
| | 60 MTRS | 90 MTRS | 120 MTRS | 150 MTRS | 180 MTRS | 210 MTRS | 240 MTRS | 270 MTRS | 300 MTRS | 450 MTRS | 600 MTRS | 900 MTRS |
| 0° | 5 | 5 | 10 | 10 | 10 | 15 | 15 | 15 | 20 | 25 | 35 | 50 |
| -10° | 10 | 10 | 15 | 15 | 20 | 20 | 25 | 30 | 30 | 45 | 60 | 90 |
| -20° | 10 | 15 | 20 | 25 | 25 | 30 | 35 | 40 | 45 | 65 | 85 | 130 |
| -30° | 15 | 20 | 25 | 30 | 35 | 40 | 45 | 55 | 60 | 85 | 115 | 170 |
| -40° | 15 | 25 | 30 | 40 | 45 | 50 | 60 | 65 | 75 | 110 | 145 | 220 |
| -50° | 20 | 30 | 40 | 45 | 55 | 65 | 75 | 80 | 90 | 135 | 180 | 270 |

After Landing Procedure

CAUTION: Taxi at a reduced speed. Use smaller tiller and rudder inputs, and apply minimum thrust evenly and smoothly. Taxiing on slippery taxiways or runways at excessive speed or with high crosswinds may start a skid.

Do the normal After Landing Procedure with the following modifications:

After prolonged operation in icing conditions with the flaps extended, or when an accumulation of airframe ice is observed, or when operating on a runway or taxiway contaminated with ice, snow, slush or standing water:

Do not retract the flaps to less than flaps 20 until the flap areas have been checked to be free of contaminants.

Engine anti-ice must be selected ON and remain on during all ground operations when icing conditions exist or are anticipated, except when the temperature is below -40°C OAT.

WARNING: Do not rely on airframe visual icing cues before activating engine anti-ice. Use the temperature and visible moisture criteria because late activation of engine anti-ice may allow excessive ingestion of ice and result in engine damage or failure.

CAUTION: Do not use engine anti-ice when OAT is above 10°C.

When engine anti-ice is needed:

ENGINE ANTI-ICE switches ON F/O

When engine anti-ice is no longer needed:

ENGINE ANTI-ICE switchesOFF F/O

When engine anti-ice is required and the OAT is 3°C or below, do an engine run up, as needed, to minimize ice build-up. Use the following procedure: C

Check that the area behind the airplane is clear.

When the aircraft is equipped with GE 80C2 engines.

Run-up to a minimum of 60% N1 for approximately 30 seconds duration at intervals no greater than 30 minutes.

When the aircraft is equipped with PW4000 engines.

Run-up to a minimum of 50% N1 for approximately 1 second duration at intervals no greater than 15 minutes.

Secure Procedure

Do the following steps after completing the normal Secure Procedure:

If the airplane will be attended, do the normal Secure Procedure with the following modification:

PACK CONTROL selectors AUTO F/O

If the airplane will not be attended, or if staying overnight at off-line stations or at airports where normal support is not available, the flight crew must arrange for or verify that the following steps are done:

Cabin altitude mode selector MAN F/O

Cabin altitude manual control DESCEND F/O

Position the outflow valve fully closed to inhibit the intake of snow or ice.

Wheel chocks Verify in place C or F/O

Parking brake Released C

Reduces the possibility of frozen brakes.

Cold weather maintenance procedures for securing the airplane may be required. These procedures are found in the approved Aircraft Maintenance Manual.

Hot Weather Operation

During ground operation the following considerations will help keep the airplane as cool as possible:

- If a ground source of conditioned air is available, the supply should be plugged in immediately after engine shutdown and should not be removed until either the APU or the engines are started.
- If a ground source of conditioned air is not available, use both air conditioning packs and recirculation fans.
- Keep all doors and windows, including cargo doors, closed as much as possible.
- Electronic components which contribute to a high temperature level in the flight deck should be turned off while not in use.
- Open all passenger cabin gasper outlets and close all window shades on the sun-exposed side of the passenger cabin.
- Open all flight deck air outlets.

Note: If only a ground source of conditioned air is supplied (no bleed air from the APU or ground external air), then TAT probes are not aspirated. Because of high TAT probe temperatures, the FMCs or TMSP may not accept an assumed temperature derate. Delay selecting an assumed temperature derate until after bleed air is available.

Moderate to Heavy Rain, Hail or Sleet

Flight should be conducted to avoid thunderstorms, hail activity or visible moisture over storm cells. To the maximum extent possible, moderate to heavy rain, hail or sleet should also be avoided.

When flight in or near heavy rain or hail is encountered or anticipated, accomplish the following:

Engine Start selectors CONT
[This selection maintains a minimum thrust setting of approach idle and provides continuous ignition.]

Turbulence

During flight in light to moderate turbulence, the autopilot may remain engaged unless airspeed, altitude or attitude deviations require use of manual control. The turbulent air penetration speed is 290 knots/.78 Mach. Below 10,000 feet a speed between 240 and 250 knots provides adequate buffet margin.

Passenger Signs ON

Advise passengers to fasten seat belts prior to entering areas of reported or anticipated turbulence. Instruct flight attendants to check all passengers' seat belts are fastened.

Severe Turbulence

Severe turbulence should be avoided if at all possible. If severe turbulence cannot be avoided, an increased buffet margin is recommended. This can be obtained by descending approximately 4,000 feet below optimum altitude. The autothrottle should be off in severe turbulence.

Windshear

Windshear is a change of wind speed and/or direction over a short distance along the flight path. Indications of windshear are listed in the Windshear non-normal maneuver in this manual.

Avoidance

The flight crew should search for any clues to the presence of windshear along the intended flight path. Presence of windshear may be indicated by:

- Thunderstorm activity
- Virga (rain that evaporates before reaching the ground)
- Pilot reports
- Low level windshear alerting system (LLWAS) warnings.

Stay clear of thunderstorm cells and heavy precipitation and areas of known windshear. If presence of windshear is confirmed, delay takeoff or do not continue an approach.

Precautions

If windshear is suspected, be especially alert to any of the danger signals and be prepared for the possibility of an inadvertent encounter. The following precautionary actions are recommended if windshear is suspected:

Takeoff

- Use maximum takeoff thrust instead of reduced thrust.
- For optimum takeoff performance, use Flaps 20 for takeoff unless limited by obstacle clearance and/or climb gradient. Flaps 15 may also be used as a precautionary setting and will provide nearly equivalent performance to Flaps 20.
- Use the longest suitable runway provided it is clear of areas of known windshear.
- Use the flight director after takeoff.
- Consider increasing V_r speed to the performance limited gross weight rotations speed, not to exceed actual gross weight V_r+20 knots. Set V speeds for the actual gross weight. Rotate at the adjusted (higher) rotation speed. This increased rotation speed results in an increased stall margin, and meets takeoff performance requirements. If windshear is encountered at or beyond the actual gross weight V_r , do not attempt to accelerate to the increased V_r , but rotate without hesitation.
- Be alert for any airspeed fluctuations during takeoff and initial climb. Such fluctuations may be the first indication of windshear.
- Know the all-engine initial climb pitch attitude. Rotate at the normal rate to this attitude for all non-engine failure takeoffs. Minimize reductions from the initial climb pitch attitude until terrain and obstruction clearance is assured, unless stick shaker activates.
- Crew coordination and awareness are very important. Develop an awareness of normal values of airspeed, attitude, vertical speed and airspeed build-up. Closely monitor vertical flight path instruments such as vertical speed and altimeters. The pilot monitoring should be especially aware of vertical path instruments and call out any deviations from normal.
- Should airspeed fall below the trim airspeed, unusual control column forces may be required to maintain the desired pitch attitude. Stick shaker must be respected at all times.

Approach and Landing

- Use either Flaps 25 or 30 for landing.
- Establish a stabilized approach no lower than 1000 feet above the airport to improve windshear recognition capability.
- Use the most suitable runway that avoids the areas of suspected windshear and is compatible with crosswind or tailwind limitations. Use ILS G/S, VNAV path or VASI/PAPI indications to detect flight path deviations and help with timely detection of windshear.
- If the autothrottle is disengaged, or is planned to be disengaged prior to landing, add an appropriate airspeed correction (correction applied in the same manner as gust), up to a maximum of 20 knots.
- Avoid large thrust reductions or trim changes in response to sudden airspeed increases as these may be followed by airspeed decreases.
- Crosscheck flight director commands using vertical flight path instruments.
- Crew coordination and awareness are very important, particularly at night or in marginal weather conditions. Closely monitor the vertical flight path instruments such as vertical speed, altimeters and glide slope displacement. The pilot monitoring should call out any deviations from normal. Use of the autopilot and autothrottle for the approach may provide more monitoring and recognition time.

Recovery

Accomplish the WINDSHEAR maneuver found in the Non-Normal Maneuvers section of this manual.

DO NOT USE FOR FLIGHT

767 Flight Crew Operations Manual

Performance Inflight

Chapter PI

Table of Contents

**767-300 CF6-80C2B6F LB FAA CATC CATD TO1-10%
TO2-20% ----- PI.10.1**

767-300 PW4060 LB FAA CATC CATD ----- PI.20.1

Intentionally
Blank

767-300 CF6-80C2B6F LB FAA CATC CATD TO1-10% TO2-20%

General PI.10.1

- Takeoff Speeds PI.10.1
- V1(MCG) PI.10.2
- Clearway and Stopway V1 Adjustments PI.10.2
- Stab Trim Setting PI.10.3
- VREF (KIAS) PI.10.4
- Flap Maneuver Speeds PI.10.5
- Slush/Standing Water Takeoff PI.10.6
- Slippery Runway Takeoff PI.10.10
- Takeoff %N1 PI.10.14
- Assumed Temperature Reduced Thrust PI.10.15
- TO1 Takeoff Speeds PI.10.17
- TO1 V1(MCG) PI.10.18
- TO1 Takeoff %N1 PI.10.18
- TO1 Stab Trim Setting PI.10.18
- TO2 Takeoff Speeds PI.10.19
- TO2 V1(MCG) PI.10.19
- TO2 Takeoff %N1 PI.10.20
- TO2 Stab Trim Setting PI.10.20
- Max Climb %N1 PI.10.21
- Go-around %N1 PI.10.22
- Flight With Unreliable Airspeed /
Turbulent Air Penetration PI.10.23

All Engine PI.11.1

- Long Range Cruise Maximum Operating Altitude PI.11.1
- Long Range Cruise Control PI.11.2
- Long Range Cruise Enroute Fuel and Time - Low
Altitudes PI.11.3
- Long Range Cruise Enroute Fuel and Time - High
Altitudes PI.11.4

| | |
|---|----------------|
| Long Range Cruise Wind-Altitude Trade | PI.11.5 |
| Descent at .78/290/250 | PI.11.5 |
| Holding | PI.11.6 |
| Advisory Information | PI.12.1 |
| Normal Configuration Landing Distance | PI.12.1 |
| Non-Normal Configuration Landing Distance | PI.12.3 |
| Recommended Brake Cooling Schedule | PI.12.11 |
| Engine Inoperative | PI.13.1 |
| Initial Max Continuous %N1 | PI.13.1 |
| Max Continuous %N1 | PI.13.2 |
| Driftdown Speed/Level Off Altitude | PI.13.5 |
| Driftdown/LRC Cruise Range Capability | PI.13.5 |
| Long Range Cruise Altitude Capability | PI.13.6 |
| Long Range Cruise Control | PI.13.7 |
| Long Range Cruise Diversion Fuel and Time | PI.13.8 |
| Holding | PI.13.9 |
| Gear Down | PI.14.1 |
| 200 KIAS Max Climb %N1 | PI.14.1 |
| Long Range Cruise Altitude Capability | PI.14.1 |
| Long Range Cruise Control | PI.14.2 |
| Long Range Cruise Enroute Fuel and Time | PI.14.3 |
| Descent at VREF30 + 70 | PI.14.3 |
| Holding | PI.14.4 |
| Gear Down, Engine Inoperative | PI.15.1 |
| Driftdown Speed/Level Off Altitude | PI.15.1 |
| Long Range Cruise Altitude Capability | PI.15.1 |
| Long Range Cruise Control | PI.15.2 |
| Long Range Cruise Diversion Fuel and Time | PI.15.3 |
| Holding | PI.15.4 |
| Text | PI.16.1 |
| Introduction | PI.16.1 |
| Takeoff Speeds | PI.16.1 |
| All Engines | PI.16.6 |
| Advisory Information | PI.16.7 |

DO NOT USE FOR FLIGHT

Performance Inflight -
Table of Contents

767 Flight Crew Operations Manual

| | |
|--------------------------|----------|
| Engine Inoperative | PI.16.9 |
| Gear Down | PI.16.11 |

Intentionally
Blank

**Performance Inflight -
 General**

**Chapter PI
 Section 10**

**Takeoff Speeds
 Max Takeoff Thrust**

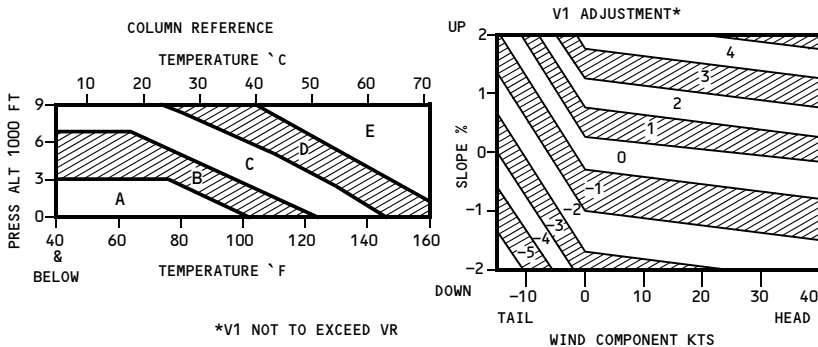

| FLAPS | WT 1000 LB | A | | | B | | | C | | | D | | | E | | |
|-------|------------------|----------------|----------------|----------------|----------------|----------------|----------------|----------------|----------------|----------------|----------------|----------------|----------------|----------------|----------------|----------------|
| | | V ₁ | V _R | V ₂ | V ₁ | V _R | V ₂ | V ₁ | V _R | V ₂ | V ₁ | V _R | V ₂ | V ₁ | V _R | V ₂ |
| 5 | 420 | 166 | 170 | 175 | 168 | 172 | 176 | | | | | | | | | |
| | 400 | 161 | 166 | 171 | 163 | 167 | 171 | | | | | | | | | |
| | 380 | 155 | 161 | 167 | 158 | 162 | 167 | 161 | 164 | 168 | | | | | | |
| | 360 | 150 | 156 | 163 | 153 | 157 | 162 | 155 | 159 | 163 | | | | | | |
| | 340 | 144 | 151 | 158 | 147 | 152 | 158 | 150 | 154 | 158 | | | | | | |
| | 320 | 138 | 145 | 153 | 141 | 147 | 153 | 144 | 148 | 153 | 147 | 150 | 153 | | | |
| | 300 | 132 | 140 | 148 | 135 | 141 | 148 | 138 | 143 | 148 | 141 | 144 | 148 | 145 | 146 | 149 |
| | 280 | 126 | 134 | 143 | 129 | 135 | 143 | 132 | 137 | 143 | 135 | 139 | 143 | 139 | 140 | 143 |
| | 260 | 120 | 127 | 138 | 122 | 129 | 138 | 125 | 131 | 138 | 128 | 133 | 138 | 132 | 134 | 138 |
| | 240 | 113 | 121 | 133 | 115 | 123 | 133 | 118 | 125 | 133 | 122 | 126 | 133 | 125 | 128 | 133 |
| 220 | 106 | 114 | 127 | 107 | 115 | 127 | 112 | 118 | 128 | 115 | 120 | 127 | 118 | 122 | 127 | |
| 15 | 420 | 160 | 163 | 169 | | | | | | | | | | | | |
| | 400 | 155 | 158 | 164 | | | | | | | | | | | | |
| | 380 | 150 | 154 | 160 | 152 | 155 | 160 | | | | | | | | | |
| | 360 | 145 | 149 | 156 | 147 | 151 | 156 | | | | | | | | | |
| | 340 | 139 | 144 | 151 | 142 | 146 | 151 | 144 | 147 | 152 | | | | | | |
| | 320 | 134 | 139 | 147 | 136 | 140 | 147 | 139 | 142 | 147 | | | | | | |
| | 300 | 128 | 133 | 142 | 131 | 135 | 142 | 133 | 137 | 142 | 137 | 138 | 142 | | | |
| | 280 | 122 | 128 | 138 | 125 | 129 | 138 | 127 | 131 | 137 | 131 | 133 | 137 | | | |
| | 260 | 116 | 122 | 133 | 119 | 123 | 133 | 121 | 125 | 132 | 125 | 127 | 132 | | | |
| | 240 | 110 | 116 | 127 | 110 | 117 | 127 | 115 | 119 | 127 | 117 | 121 | 127 | 122 | 123 | 127 |
| 220 | 104 | 109 | 122 | 106 | 111 | 122 | 108 | 113 | 122 | 112 | 115 | 122 | 115 | 117 | 122 | |
| 20 | 420 | 159 | 159 | 165 | 156 | 156 | 160 | | | | | | | | | |
| | 400 | 153 | 154 | 160 | 150 | 150 | 156 | | | | | | | | | |
| | 380 | 147 | 149 | 155 | 150 | 150 | 156 | | | | | | | | | |
| | 360 | 142 | 144 | 150 | 144 | 145 | 151 | | | | | | | | | |
| | 340 | 137 | 140 | 146 | 139 | 140 | 146 | 141 | 142 | 147 | | | | | | |
| | 320 | 130 | 134 | 142 | 134 | 135 | 142 | 136 | 137 | 142 | | | | | | |
| | 300 | 125 | 129 | 137 | 128 | 130 | 137 | 130 | 132 | 137 | | | | | | |
| | 280 | 119 | 123 | 133 | 122 | 125 | 133 | 124 | 126 | 133 | 133 | 133 | 138 | | | |
| | 260 | 112 | 117 | 128 | 115 | 119 | 128 | 118 | 121 | 128 | 122 | 123 | 128 | | | |
| | 240 | 106 | 112 | 123 | 109 | 113 | 123 | 112 | 115 | 123 | 116 | 117 | 123 | 124 | 124 | 128 |
| 220 | 99 | 105 | 118 | 102 | 107 | 118 | 105 | 109 | 118 | 109 | 111 | 118 | 113 | 113 | 118 | |

CHECK V1(MCG) IN BOXED AREA

V1(MCG)

Max Takeoff Thrust

| ACTUAL OAT | | PRESSURE ALTITUDE (FT) | | | | | | |
|------------|-----|------------------------|-----|------|------|------|------|------|
| °F | °C | -1000 | 0 | 2000 | 4000 | 6000 | 8000 | 9000 |
| 122 | 50 | 103 | 101 | 97 | | | | |
| 104 | 40 | 108 | 106 | 101 | 97 | 93 | 90 | |
| 86 | 30 | 111 | 109 | 105 | 101 | 97 | 94 | 92 |
| 68 | 20 | 111 | 110 | 107 | 104 | 100 | 96 | 95 |
| 50 | 10 | 111 | 110 | 107 | 104 | 101 | 98 | 96 |
| -58 | -50 | 113 | 111 | 108 | 105 | 102 | 98 | 97 |

Maximum Allowable Clearway

| FIELD LENGTH (FT) | MAX ALLOWABLE CLEARWAY FOR V1 REDUCTION (FT) |
|-------------------|--|
| 4000 | 350 |
| 6000 | 500 |
| 8000 | 600 |
| 10000 | 700 |
| 12000 | 800 |
| 14000 | 900 |

Clearway and Stopway V1 Adjustments

| CLEARWAY MINUS STOPWAY (FT) | NORMAL V1 (KIAS) | | |
|-----------------------------|------------------|-----|-----|
| | 120 | 140 | 160 |
| 800 | -5 | -3 | -2 |
| 600 | -3 | -2 | -2 |
| 400 | -2 | -1 | -1 |
| 200 | -1 | -1 | -1 |
| 0 | 0 | 0 | 0 |
| -200 | 1 | 1 | 1 |
| -400 | 2 | 1 | 1 |
| -600 | 3 | 2 | 2 |
| -800 | 5 | 3 | 2 |

**Stab Trim Setting
 Max Takeoff Thrust**

| WEIGHT (1000 LB) | C.G. %MAC | | | | | | |
|---------------------|-----------|-------|-------|-------|-------|-------|-------|
| | 12 | 16 | 20 | 24 | 28 | 32 | 36 |
| 420 | 7 | 7 | 6 | 4 1/2 | 3 1/2 | 3 | 2 |
| 400 | 7 | 6 | 5 1/2 | 4 1/2 | 3 1/2 | 3 | 2 |
| 380 | 7 | 6 | 5 | 4 1/2 | 3 1/2 | 2 1/2 | 1 1/2 |
| 360 | 6 1/2 | 5 1/2 | 5 | 4 | 3 | 2 1/2 | 1 1/2 |
| 340 | 6 | 5 1/2 | 4 1/2 | 3 1/2 | 3 | 2 | 1 1/2 |
| 320 | 6 | 5 | 4 | 3 1/2 | 2 1/2 | 2 | 1 |
| 300 | 5 | 4 1/2 | 3 1/2 | 3 | 2 | 1 1/2 | 1/2 |
| 280 | 4 1/2 | 4 | 3 | 2 1/2 | 1 1/2 | 1 | 1/2 |
| 260 | 4 | 3 1/2 | 2 1/2 | 2 | 1 | 1/2 | 1/2 |
| 240 | 3 1/2 | 3 | 2 | 1 1/2 | 1 | 1/2 | 1/2 |
| 220 | 3 | 2 1/2 | 2 | 1 | 1 | 1/2 | 1/2 |

VREF (KIAS)

| WEIGHT (1000 LB) | FLAPS | | |
|---------------------|-------|-----|-----|
| | 30 | 25 | 20 |
| 420 | 179 | 171 | 179 |
| 400 | 172 | 166 | 174 |
| 380 | 166 | 162 | 169 |
| 360 | 159 | 158 | 164 |
| 340 | 151 | 153 | 159 |
| 320 | 145 | 149 | 154 |
| 300 | 140 | 144 | 149 |
| 280 | 135 | 139 | 144 |
| 260 | 130 | 134 | 139 |
| 240 | 124 | 129 | 134 |
| 220 | 119 | 123 | 128 |

Flap Maneuver Speeds

| FLAP POSITION | MANEUVER SPEED |
|---------------|----------------|
| UP | VREF30 + 80 |
| 1 | VREF30 + 60 |
| 5 | VREF30 + 40 |
| 15 | VREF30 + 20 |
| 20 | VREF30 + 20 |
| 25 | VREF25 |
| 30 | VREF30 |

ADVISORY INFORMATION

**Slush/Standing Water Takeoff
Maximum Reverse Thrust
Weight Adjustment (1000 LB)**

| FIELD/OBSTACLE LIMIT WEIGHT (1000 LB) | SLUSH/STANDING WATER DEPTH | | | | | | | | |
|---|----------------------------|-------|-------|--------------------|-------|-------|---------------------|-------|-------|
| | 0.12 INCHES (3 mm) | | | 0.25 INCHES (6 mm) | | | 0.50 INCHES (13 mm) | | |
| | PRESS ALT (FT) | | | PRESS ALT (FT) | | | PRESS ALT (FT) | | |
| | S.L. | 4000 | 8000 | S.L. | 4000 | 8000 | S.L. | 4000 | 8000 |
| 420 | -42.1 | -51.3 | -60.5 | -49.2 | -58.4 | -67.6 | -66.3 | -75.5 | -84.7 |
| 400 | -40.8 | -50.0 | -59.2 | -47.5 | -56.7 | -65.9 | -62.6 | -71.8 | -81.0 |
| 380 | -38.9 | -48.1 | -57.3 | -44.9 | -54.1 | -63.3 | -58.3 | -67.5 | -76.7 |
| 360 | -36.4 | -45.6 | -54.8 | -41.7 | -50.9 | -60.1 | -53.5 | -62.7 | -71.9 |
| 340 | -33.5 | -42.7 | -51.9 | -37.9 | -47.1 | -56.3 | -48.1 | -57.3 | -66.5 |
| 320 | -30.1 | -39.3 | -48.5 | -33.7 | -42.9 | -52.1 | -42.3 | -51.5 | -60.7 |
| 300 | -26.2 | -35.4 | -44.6 | -29.3 | -38.5 | -47.7 | -36.2 | -45.4 | -54.6 |
| 280 | -22.1 | -31.3 | -40.5 | -24.8 | -34.0 | -43.2 | -29.8 | -39.0 | -48.2 |
| 260 | -17.6 | -26.8 | -36.0 | -20.3 | -29.5 | -38.7 | -23.2 | -32.4 | -41.6 |
| 240 | -12.8 | -22.0 | -31.2 | -16.0 | -25.2 | -34.4 | -16.6 | -25.8 | -35.0 |
| 220 | -7.8 | -17.0 | -26.2 | -11.9 | -21.1 | -30.3 | -9.8 | -19.0 | -28.2 |

V1(MCG) Limit Weight (1000 LB)

| ADJUSTED FIELD LENGTH (FT) | SLUSH/STANDING WATER DEPTH | | | | | | | | |
|-------------------------------------|----------------------------|-------|-------|--------------------|-------|-------|---------------------|-------|-------|
| | 0.12 INCHES (3 mm) | | | 0.25 INCHES (6 mm) | | | 0.50 INCHES (13 mm) | | |
| | PRESS ALT (FT) | | | PRESS ALT (FT) | | | PRESS ALT (FT) | | |
| | S.L. | 4000 | 8000 | S.L. | 4000 | 8000 | S.L. | 4000 | 8000 |
| 4600 | | | | | | | 193.2 | | |
| 5000 | 189.4 | | | 206.2 | | | 237.1 | 182.2 | |
| 5400 | 233.4 | | | 251.0 | 195.1 | | 282.2 | 226.2 | |
| 5800 | 280.2 | 222.2 | | 298.4 | 239.6 | 184.0 | 330.1 | 270.8 | 215.2 |
| 6200 | 330.3 | 268.1 | 211.3 | 348.8 | 286.2 | 228.4 | 380.3 | 318.0 | 259.4 |
| 6600 | 382.9 | 317.5 | 256.3 | 401.7 | 335.9 | 274.2 | 432.1 | 367.5 | 305.9 |
| 7000 | 438.4 | 369.4 | 304.9 | 455.8 | 388.4 | 323.3 | | 419.0 | 354.9 |
| 7400 | | 424.2 | 356.2 | | 442.2 | 375.1 | | | 406.0 |
| 7800 | | | 410.3 | | | 428.6 | | | 458.7 |

1. Enter Weight Adjustment table with slush/standing water depth and field/obstacle limit weight to obtain slush/standing water weight adjustment.
2. Adjust field length available by -120 ft/ + 120 ft for every 10°F above/below 40°F.
3. Find V1(MCG) limit weight for adjusted field length and pressure altitude.
4. Max allowable slush/standing water limited weight is lesser of weights from 1 and 3.

ADVISORY INFORMATION

Slush/Standing Water Takeoff

Maximum Reverse Thrust

V1 Adjustment (KIAS)

| WEIGHT (1000 LB) | SLUSH/STANDING WATER DEPTH | | | | | | | | |
|---------------------|----------------------------|------|------|--------------------|------|------|---------------------|------|------|
| | 0.12 INCHES (3 mm) | | | 0.25 INCHES (6 mm) | | | 0.50 INCHES (13 mm) | | |
| | PRESS ALT (FT) | | | PRESS ALT (FT) | | | PRESS ALT (FT) | | |
| | S.L. | 4000 | 8000 | S.L. | 4000 | 8000 | S.L. | 4000 | 8000 |
| 420 | -21 | -21 | -21 | -16 | -16 | -16 | -7 | -7 | -7 |
| 400 | -21 | -21 | -21 | -16 | -16 | -16 | -6 | -6 | -6 |
| 380 | -22 | -22 | -22 | -17 | -17 | -17 | -6 | -6 | -6 |
| 360 | -22 | -22 | -22 | -17 | -17 | -17 | -6 | -6 | -6 |
| 340 | -23 | -23 | -23 | -18 | -18 | -18 | -7 | -7 | -7 |
| 320 | -23 | -23 | -23 | -18 | -18 | -18 | -7 | -7 | -7 |
| 300 | -24 | -24 | -24 | -19 | -19 | -19 | -9 | -9 | -9 |
| 280 | -25 | -25 | -25 | -20 | -20 | -20 | -10 | -10 | -10 |
| 260 | -25 | -25 | -25 | -21 | -21 | -21 | -12 | -12 | -12 |
| 240 | -26 | -26 | -26 | -23 | -23 | -23 | -14 | -14 | -14 |
| 220 | -27 | -27 | -27 | -24 | -24 | -24 | -16 | -16 | -16 |

1. Obtain V1, VR and V2 for the actual weight.
2. If V1(MCG) limited, set V1 = V1(MCG). If not V1(MCG) limited, enter V1 Adjustment table with the actual weight to obtain V1 speed adjustment. If adjusted V1 is less than V1(MCG), set V1 = V1(MCG).

ADVISORY INFORMATION

Slush/Standing Water Takeoff

No Reverse Thrust

Weight Adjustment (1000 LB)

| FIELD/OBSTACLE LIMIT WEIGHT (1000 LB) | SLUSH/STANDING WATER DEPTH | | | | | | | | |
|---|----------------------------|-------|-------|--------------------|-------|-------|---------------------|-------|--------|
| | 0.12 INCHES (3 mm) | | | 0.25 INCHES (6 mm) | | | 0.50 INCHES (13 mm) | | |
| | PRESS ALT (FT) | | | PRESS ALT (FT) | | | PRESS ALT (FT) | | |
| | S.L. | 4000 | 8000 | S.L. | 4000 | 8000 | S.L. | 4000 | 8000 |
| 420 | -54.9 | -64.9 | -74.9 | -63.0 | -73.0 | -83.0 | -81.9 | -91.9 | -101.9 |
| 400 | -51.9 | -61.9 | -71.9 | -59.1 | -69.1 | -79.1 | -75.5 | -85.5 | -95.5 |
| 380 | -48.7 | -58.7 | -68.7 | -55.0 | -65.0 | -75.0 | -69.2 | -79.2 | -89.2 |
| 360 | -45.2 | -55.2 | -65.2 | -50.7 | -60.7 | -70.7 | -62.8 | -72.8 | -82.8 |
| 340 | -41.6 | -51.6 | -61.6 | -46.2 | -56.2 | -66.2 | -56.5 | -66.5 | -76.5 |
| 320 | -37.7 | -47.7 | -57.7 | -41.6 | -51.6 | -61.6 | -50.2 | -60.2 | -70.2 |
| 300 | -33.5 | -43.5 | -53.5 | -36.8 | -46.8 | -56.8 | -44.0 | -54.0 | -64.0 |
| 280 | -29.2 | -39.2 | -49.2 | -31.9 | -41.9 | -51.9 | -37.8 | -47.8 | -57.8 |
| 260 | -24.6 | -34.6 | -44.6 | -26.8 | -36.8 | -46.8 | -31.6 | -41.6 | -51.6 |
| 240 | -19.8 | -29.8 | -39.8 | -21.5 | -31.5 | -41.5 | -25.4 | -35.4 | -45.4 |
| 220 | -14.8 | -24.8 | -34.8 | -16.0 | -26.0 | -36.0 | -19.3 | -29.3 | -39.3 |

V1(MCG) Limit Weight (1000 LB)

| ADJUSTED FIELD LENGTH (FT) | SLUSH/STANDING WATER DEPTH | | | | | | | | |
|-------------------------------------|----------------------------|-------|-------|--------------------|-------|-------|---------------------|-------|-------|
| | 0.12 INCHES (3 mm) | | | 0.25 INCHES (6 mm) | | | 0.50 INCHES (13 mm) | | |
| | PRESS ALT (FT) | | | PRESS ALT (FT) | | | PRESS ALT (FT) | | |
| | S.L. | 4000 | 8000 | S.L. | 4000 | 8000 | S.L. | 4000 | 8000 |
| 6200 | | | | | | | 217.9 | | |
| 6600 | | | | 193.8 | | | 269.6 | 200.4 | |
| 7000 | 199.7 | | | 251.2 | | | 323.9 | 251.2 | 182.9 |
| 7400 | 261.7 | | | 311.5 | 230.8 | | 381.4 | 304.6 | 233.2 |
| 7800 | 327.3 | 239.6 | | 375.3 | 290.0 | 210.7 | 442.7 | 360.9 | 285.6 |
| 8200 | 397.6 | 303.8 | 218.1 | 443.3 | 352.5 | 268.9 | | 420.8 | 340.8 |
| 8600 | | 372.4 | 280.9 | | 418.9 | 330.2 | | | 399.4 |
| 9000 | | 446.2 | 347.8 | | | 395.2 | | | |
| 9400 | | | 419.8 | | | | | | |

1. Enter Weight Adjustment table with slush/standing water depth and field/obstacle limit weight to obtain slush/standing water weight adjustment.
2. Adjust field length available by -155 ft/+155 ft for every 10°F above/below 40°F.
3. Find V1(MCG) limit weight for adjusted field length and pressure altitude.
4. Max allowable slush/standing water limited weight is lesser of weights from 1 and 3.

ADVISORY INFORMATION

Slush/Standing Water Takeoff

No Reverse Thrust

V1 Adjustment (KIAS)

| WEIGHT (1000 LB) | SLUSH/STANDING WATER DEPTH | | | | | | | | |
|---------------------|----------------------------|------|------|--------------------|------|------|---------------------|------|------|
| | 0.12 INCHES (3 mm) | | | 0.25 INCHES (6 mm) | | | 0.50 INCHES (13 mm) | | |
| | PRESS ALT (FT) | | | PRESS ALT (FT) | | | PRESS ALT (FT) | | |
| | S.L. | 4000 | 8000 | S.L. | 4000 | 8000 | S.L. | 4000 | 8000 |
| 420 | -30 | -30 | -30 | -23 | -23 | -23 | -11 | -11 | -11 |
| 400 | -30 | -30 | -30 | -24 | -24 | -24 | -11 | -11 | -11 |
| 380 | -31 | -31 | -31 | -25 | -25 | -25 | -12 | -12 | -12 |
| 360 | -31 | -31 | -31 | -26 | -26 | -26 | -13 | -13 | -13 |
| 340 | -32 | -32 | -32 | -27 | -27 | -27 | -14 | -14 | -14 |
| 320 | -32 | -32 | -32 | -28 | -28 | -28 | -16 | -16 | -16 |
| 300 | -33 | -33 | -33 | -28 | -28 | -28 | -18 | -18 | -18 |
| 280 | -33 | -33 | -33 | -29 | -29 | -29 | -20 | -20 | -20 |
| 260 | -33 | -33 | -33 | -30 | -30 | -30 | -22 | -22 | -22 |
| 240 | -33 | -33 | -33 | -31 | -31 | -31 | -25 | -25 | -25 |
| 220 | -33 | -33 | -33 | -31 | -31 | -31 | -28 | -28 | -28 |

1. Obtain V1, VR and V2 for the actual weight.
2. If V1(MCG) limited, set V1 = V1(MCG). If not V1(MCG) limited, enter V1 Adjustment table with the actual weight to obtain V1 speed adjustment. If adjusted V1 is less than V1(MCG), set V1 = V1(MCG).

**Slippery Runway Takeoff
Maximum Reverse Thrust
Weight Adjustment (1000 LB)**

| FIELD/OBSTACLE LIMIT WEIGHT (1000 LB) | REPORTED BRAKING ACTION | | | | | | | | |
|---|-------------------------|------|------|----------------|-------|-------|----------------|-------|-------|
| | GOOD | | | MEDIUM | | | POOR | | |
| | PRESS ALT (FT) | | | PRESS ALT (FT) | | | PRESS ALT (FT) | | |
| | S.L. | 4000 | 8000 | S.L. | 4000 | 8000 | S.L. | 4000 | 8000 |
| 420 | -2.4 | -2.4 | -2.4 | -23.8 | -23.8 | -23.8 | -44.0 | -44.0 | -44.0 |
| 400 | -4.4 | -4.4 | -4.4 | -24.7 | -24.7 | -24.7 | -43.3 | -43.3 | -43.3 |
| 380 | -5.8 | -5.8 | -5.8 | -25.0 | -25.0 | -25.0 | -42.1 | -42.1 | -42.1 |
| 360 | -6.6 | -6.6 | -6.6 | -24.7 | -24.7 | -24.7 | -40.5 | -40.5 | -40.5 |
| 340 | -6.8 | -6.8 | -6.8 | -23.7 | -23.7 | -23.7 | -38.3 | -38.3 | -38.3 |
| 320 | -6.5 | -6.5 | -6.5 | -22.2 | -22.2 | -22.2 | -35.7 | -35.7 | -35.7 |
| 300 | -5.6 | -5.6 | -5.6 | -20.0 | -20.0 | -20.0 | -32.6 | -32.6 | -32.6 |
| 280 | -4.3 | -4.3 | -4.3 | -17.2 | -17.2 | -17.2 | -29.1 | -29.1 | -29.1 |
| 260 | -2.5 | -2.5 | -2.5 | -13.7 | -13.7 | -13.7 | -25.0 | -25.0 | -25.0 |
| 240 | -0.3 | -0.3 | -0.3 | -9.6 | -9.6 | -9.6 | -20.5 | -20.5 | -20.5 |
| 220 | 0.0 | 0.0 | 0.0 | -4.9 | -4.9 | -4.9 | -15.5 | -15.5 | -15.5 |

V1(MCG) Limit Weight (1000 LB)

| ADJUSTED FIELD LENGTH (FT) | REPORTED BRAKING ACTION | | | | | | | | |
|-------------------------------------|-------------------------|-------|-------|----------------|-------|-------|----------------|-------|-------|
| | GOOD | | | MEDIUM | | | POOR | | |
| | PRESS ALT (FT) | | | PRESS ALT (FT) | | | PRESS ALT (FT) | | |
| | S.L. | 4000 | 8000 | S.L. | 4000 | 8000 | S.L. | 4000 | 8000 |
| 3800 | 218.5 | | | | | | | | |
| 4200 | 304.5 | | | | | | | | |
| 4600 | 389.6 | 253.0 | | | | | | | |
| 5000 | | 338.7 | 201.2 | 206.8 | | | | | |
| 5400 | | 423.3 | 287.4 | 265.4 | | | | | |
| 5800 | | | 372.6 | 327.0 | 229.9 | | | | |
| 6200 | | | 456.9 | 392.0 | 289.6 | 195.3 | 182.5 | 182.5 | 182.5 |
| 6600 | | | | | 352.5 | 253.5 | 217.0 | 217.0 | 217.0 |
| 7000 | | | | | 419.2 | 314.4 | 252.6 | 252.6 | 252.6 |
| 7400 | | | | | | 378.7 | 289.9 | 289.9 | 289.9 |
| 7800 | | | | | | 447.1 | 329.2 | 329.2 | 329.2 |
| 8200 | | | | | | | 370.7 | 370.7 | 370.7 |
| 8600 | | | | | | | 414.9 | 414.9 | 414.9 |

1. Enter Weight Adjustment table with reported braking action and field/obstacle limit weight to obtain slippery runway weight adjustment.
2. Adjust "Good" field length available by -90 ft/+90 ft for every 10°F above/below 40°F.
Adjust "Medium" field length available by -90 ft/+90 ft for every 10°F above/below 40°F.
Adjust "Poor" field length available by -140 ft/+140 ft for every 10°F above/below 40°F.
3. Find V1(MCG) limit weight for adjusted field length and pressure altitude.
4. Max allowable slippery runway limited weight is lesser of weights from 1 and 3.

Slippery Runway Takeoff
Maximum Reverse Thrust
V1 Adjustment (KIAS)

| WEIGHT (1000 LB) | REPORTED BRAKING ACTION | | | | | | | | |
|---------------------|-------------------------|------|------|----------------|------|------|----------------|------|------|
| | GOOD | | | MEDIUM | | | POOR | | |
| | PRESS ALT (FT) | | | PRESS ALT (FT) | | | PRESS ALT (FT) | | |
| | S.L. | 4000 | 8000 | S.L. | 4000 | 8000 | S.L. | 4000 | 8000 |
| 420 | -7 | -7 | -7 | -17 | -17 | -17 | -29 | -29 | -29 |
| 400 | -8 | -8 | -8 | -18 | -18 | -18 | -30 | -30 | -30 |
| 380 | -9 | -9 | -9 | -19 | -19 | -19 | -31 | -31 | -31 |
| 360 | -9 | -9 | -9 | -20 | -20 | -20 | -33 | -33 | -33 |
| 340 | -10 | -10 | -10 | -21 | -21 | -21 | -34 | -34 | -34 |
| 320 | -11 | -11 | -11 | -22 | -22 | -22 | -36 | -36 | -36 |
| 300 | -11 | -11 | -11 | -23 | -23 | -23 | -37 | -37 | -37 |
| 280 | -12 | -12 | -12 | -24 | -24 | -24 | -38 | -38 | -38 |
| 260 | -12 | -12 | -12 | -25 | -25 | -25 | -40 | -40 | -40 |
| 240 | -12 | -12 | -12 | -26 | -26 | -26 | -42 | -42 | -42 |
| 220 | -12 | -12 | -12 | -27 | -27 | -27 | -43 | -43 | -43 |

1. Obtain V1, VR and V2 for the actual weight.
2. If V1(MCG) limited, set V1 = V1(MCG). If not V1(MCG) limited, enter V1 Adjustment table with the actual weight to obtain V1 speed adjustment. If adjusted V1 is less than V1(MCG), set V1 = V1(MCG).

Slippery Runway Takeoff

No Reverse Thrust

Weight Adjustment (1000 LB)

| FIELD/OBSTACLE LIMIT WEIGHT (1000 LB) | REPORTED BRAKING ACTION | | | | | | | | |
|---|-------------------------|-------|-------|----------------|-------|-------|----------------|-------|-------|
| | GOOD | | | MEDIUM | | | POOR | | |
| | PRESS ALT (FT) | | | PRESS ALT (FT) | | | PRESS ALT (FT) | | |
| | S.L. | 4000 | 8000 | S.L. | 4000 | 8000 | S.L. | 4000 | 8000 |
| 420 | -9.3 | -10.3 | -11.2 | -35.3 | -36.2 | -37.1 | -56.4 | -57.4 | -58.3 |
| 400 | -10.8 | -11.7 | -12.6 | -35.5 | -36.4 | -37.3 | -55.3 | -56.2 | -57.1 |
| 380 | -11.8 | -12.7 | -13.6 | -35.2 | -36.1 | -37.1 | -53.5 | -54.4 | -55.4 |
| 360 | -12.3 | -13.2 | -14.2 | -34.4 | -35.4 | -36.3 | -51.2 | -52.1 | -53.0 |
| 340 | -12.4 | -13.3 | -14.2 | -33.1 | -34.1 | -35.0 | -48.2 | -49.1 | -50.1 |
| 320 | -12.0 | -13.0 | -13.9 | -31.3 | -32.2 | -33.2 | -44.7 | -45.6 | -46.5 |
| 300 | -11.2 | -12.1 | -13.1 | -29.0 | -29.9 | -30.8 | -40.5 | -41.5 | -42.4 |
| 280 | -10.0 | -10.9 | -11.8 | -26.1 | -27.1 | -28.0 | -35.8 | -36.8 | -37.7 |
| 260 | -8.2 | -9.2 | -10.1 | -22.8 | -23.7 | -24.6 | -30.5 | -31.4 | -32.4 |
| 240 | -6.1 | -7.0 | -7.9 | -18.9 | -19.8 | -20.7 | -24.6 | -25.5 | -26.5 |
| 220 | -3.4 | -4.4 | -5.3 | -14.5 | -15.4 | -16.4 | -18.1 | -19.0 | -20.0 |

V1(MCG) Limit Weight (1000 LB)

| ADJUSTED FIELD LENGTH (FT) | REPORTED BRAKING ACTION | | | | | | | | |
|-------------------------------|-------------------------|-------|-------|------------------------|-------|-------|------------------------|-------|-------|
| | GOOD | | | MEDIUM | | | POOR | | |
| | PRESSURE ALTITUDE (FT) | | | PRESSURE ALTITUDE (FT) | | | PRESSURE ALTITUDE (FT) | | |
| | S.L. | 4000 | 8000 | S.L. | 4000 | 8000 | S.L. | 4000 | 8000 |
| 4200 | 185.3 | | | | | | | | |
| 4600 | 311.7 | | | | | | | | |
| 5000 | 414.0 | 246.1 | | | | | | | |
| 5400 | | 359.9 | | | | | | | |
| 5800 | | 455.1 | 300.3 | | | | | | |
| 6200 | | | 404.5 | | | | | | |
| 6600 | | | | 270.4 | | | | | |
| 7000 | | | | 368.5 | 212.6 | | | | |
| 7400 | | | | 459.3 | 315.6 | | | | |
| 7800 | | | | | 410.1 | 260.1 | | | |
| 8200 | | | | | | 359.0 | | | |
| 8600 | | | | | | 450.5 | | | |
| 9400 | | | | | | | 185.3 | | |
| 9800 | | | | | | | 240.2 | | |
| 10200 | | | | | | | 298.3 | 185.3 | |
| 10600 | | | | | | | 360.5 | 240.2 | |
| 11000 | | | | | | | 427.8 | 298.3 | 185.3 |
| 11400 | | | | | | | | 360.5 | 240.2 |
| 11800 | | | | | | | | 427.8 | 298.3 |
| 12200 | | | | | | | | | 360.5 |
| 12600 | | | | | | | | | 427.8 |

1. Enter Weight Adjustment table with reported braking action and dry field/obstacle limit weight to obtain slippery runway weight adjustment.
2. Adjust "Good" field length available by -100 ft/+100 ft for every 10°F above/below 40°F.
Adjust "Medium" field length available by -100 ft/+100 ft for every 10°F above/below 40°F.
Adjust "Poor" field length available by -175 ft/+175 ft for every 10°F above/below 40°F.
3. Find V1(MCG) limit weight for available field length and pressure altitude.
4. Max allowable slippery runway limited weight is lesser of weights from 1 and 3.

Slippery Runway Takeoff

No Reverse Thrust

V1 Adjustment (KIAS)

| WEIGHT (1000 LB) | REPORTED BRAKING ACTION | | | | | | | | |
|---------------------|-------------------------|------|------|----------------|------|------|----------------|------|------|
| | GOOD | | | MEDIUM | | | POOR | | |
| | PRESS ALT (FT) | | | PRESS ALT (FT) | | | PRESS ALT (FT) | | |
| | S.L. | 4000 | 8000 | S.L. | 4000 | 8000 | S.L. | 4000 | 8000 |
| 420 | -9 | -9 | -9 | -23 | -23 | -23 | -42 | -42 | -42 |
| 400 | -10 | -10 | -10 | -24 | -24 | -24 | -43 | -43 | -43 |
| 380 | -11 | -11 | -11 | -25 | -25 | -25 | -45 | -45 | -45 |
| 360 | -12 | -12 | -12 | -27 | -27 | -27 | -47 | -47 | -47 |
| 340 | -13 | -13 | -13 | -28 | -28 | -28 | -48 | -48 | -48 |
| 320 | -14 | -14 | -14 | -30 | -30 | -30 | -50 | -50 | -50 |
| 300 | -15 | -15 | -15 | -31 | -31 | -31 | -51 | -51 | -51 |
| 280 | -15 | -15 | -15 | -32 | -32 | -32 | -53 | -53 | -53 |
| 260 | -16 | -16 | -16 | -33 | -33 | -33 | -54 | -54 | -54 |
| 240 | -17 | -17 | -17 | -34 | -34 | -34 | -54 | -54 | -54 |
| 220 | -18 | -18 | -18 | -35 | -35 | -35 | -54 | -54 | -54 |

1. Obtain V1, VR and V2 for the actual weight.
2. If V1(MCG) limited, set V1 = V1(MCG). If not V1(MCG) limited, enter V1 Adjustment table with the actual weight to obtain V1 speed adjustment. If adjusted V1 is less than V1(MCG), set V1 = V1(MCG).

Takeoff %N1

Max Takeoff Thrust

Based on engine bleed for packs on, EEC NORM or ALTN and anti-ice on or off

| AIRPORT OAT | | TAT (°C) | AIRPORT PRESSURE ALTITUDE (FT) | | | | | | |
|-------------|-----|-------------|--------------------------------|-------|-------|-------|-------|-------|-------|
| °F | °C | | -1000 | 0 | 2000 | 4000 | 6000 | 8000 | 9000 |
| 131 | 55 | 58 | 106.1 | 106.1 | 105.9 | 105.5 | 105.1 | 104.9 | 104.7 |
| 122 | 50 | 53 | 106.8 | 106.9 | 106.8 | 106.5 | 106.1 | 105.9 | 105.7 |
| 113 | 45 | 48 | 107.5 | 107.5 | 107.5 | 107.3 | 107.0 | 106.9 | 106.6 |
| 104 | 40 | 43 | 108.2 | 108.2 | 108.2 | 108.0 | 107.9 | 107.8 | 107.7 |
| 95 | 35 | 38 | 109.0 | 108.9 | 109.0 | 108.8 | 108.7 | 108.7 | 108.6 |
| 86 | 30 | 33 | 109.1 | 109.8 | 109.8 | 109.7 | 109.6 | 109.7 | 109.6 |
| 77 | 25 | 28 | 108.2 | 108.9 | 110.3 | 110.6 | 110.5 | 110.6 | 110.6 |
| 68 | 20 | 23 | 107.3 | 108.0 | 109.4 | 110.6 | 111.3 | 111.4 | 111.3 |
| 59 | 15 | 18 | 106.4 | 107.1 | 108.5 | 109.7 | 111.0 | 112.0 | 112.1 |
| 50 | 10 | 13 | 105.5 | 106.2 | 107.5 | 108.8 | 110.0 | 111.3 | 112.1 |
| 32 | 0 | 3 | 103.6 | 104.3 | 105.7 | 106.9 | 108.1 | 109.4 | 110.1 |
| 14 | -10 | -7 | 101.7 | 102.4 | 103.8 | 104.9 | 106.1 | 107.4 | 108.1 |
| -4 | -20 | -17 | 99.8 | 100.4 | 101.8 | 103.0 | 104.2 | 105.4 | 106.1 |
| -22 | -30 | -27 | 97.9 | 98.5 | 99.8 | 101.0 | 102.2 | 103.4 | 104.0 |
| -40 | -40 | -37 | 95.9 | 96.4 | 97.8 | 99.0 | 100.1 | 101.3 | 102.0 |
| -58 | -50 | -47 | 93.8 | 94.4 | 95.8 | 96.9 | 98.0 | 99.2 | 99.8 |

%N1 Adjustments for Engine Bleeds

| BLEED CONFIGURATION | AIRPORT PRESSURE ALTITUDE (FT) | | | | | | |
|------------------------|--------------------------------|-----|------|------|------|------|------|
| | -1000 | 0 | 2000 | 4000 | 6000 | 8000 | 9000 |
| PACKS OFF | 0.3 | 0.3 | 0.3 | 0.4 | 0.5 | 0.5 | 0.5 |

Assumed Temperature Reduced Thrust

Minimum Assumed Temperature

| MINIMUM ASSUMED TEMP | PRESSURE ALTITUDE (FT) | | | | | | | | | |
|----------------------|------------------------|----|------|------|------|------|------|------|------|------|
| | -1000 | 0 | 1000 | 2000 | 3000 | 4000 | 5000 | 6000 | 7000 | 8000 |
| °F | 90 | 86 | 83 | 79 | 76 | 72 | 69 | 65 | 62 | 58 |
| °C | 32 | 30 | 28 | 26 | 24 | 22 | 20 | 18 | 16 | 14 |

Assumed Temperature Limit %N1

Based on engine bleed for packs on

| ACTUAL OAT (°C) | ASSUMED TEMPERATURE (°C) | | | | | | | | | | | |
|-----------------|--------------------------|-------|-------|-------|-------|-------|-------|-------|-------|-------|-------|-------|
| | 15 | 20 | 25 | 30 | 35 | 40 | 45 | 50 | 55 | 60 | 65 | 70 |
| 55 | | | | | | | | | | 104.3 | 102.5 | 100.9 |
| 50 | | | | | | | | | 105.3 | 103.5 | 101.8 | 100.1 |
| 45 | | | | | | | | 106.0 | 104.5 | 102.7 | 101.0 | 99.4 |
| 40 | | | | | | | 106.6 | 105.2 | 103.7 | 101.9 | 100.2 | 98.6 |
| 35 | | | | | | 107.3 | 105.8 | 104.3 | 102.8 | 101.1 | 99.4 | 97.8 |
| 30 | | | | | 108.0 | 106.5 | 104.9 | 103.5 | 102.0 | 100.3 | 98.6 | 97.0 |
| 25 | | | | 108.9 | 107.1 | 105.6 | 104.1 | 102.7 | 101.2 | 99.5 | 97.8 | 96.2 |
| 20 | | | 109.7 | 108.0 | 106.2 | 104.7 | 103.2 | 101.8 | 100.3 | 98.7 | 97.0 | 95.5 |
| 15 | | 110.6 | 108.8 | 107.1 | 105.4 | 103.9 | 102.4 | 101.0 | 99.5 | 97.9 | 96.2 | 94.7 |
| 10 | 111.2 | 109.6 | 107.9 | 106.1 | 104.4 | 103.0 | 101.5 | 100.1 | 98.6 | 97.0 | 95.4 | 93.8 |
| 5 | 110.2 | 108.6 | 106.9 | 105.2 | 103.5 | 102.1 | 100.6 | 99.2 | 97.8 | 96.2 | 94.5 | 93.0 |
| 0 | 109.2 | 107.7 | 106.0 | 104.3 | 102.6 | 101.2 | 99.7 | 98.3 | 96.9 | 95.3 | 93.7 | |
| -10 | 107.2 | 105.7 | 104.0 | 102.4 | 100.7 | 99.3 | 97.9 | 96.5 | 95.2 | 93.6 | 92.0 | |
| -20 | 105.2 | 103.7 | 102.1 | 100.4 | 98.8 | 97.4 | 96.0 | 94.7 | 93.4 | 91.8 | | |
| -30 | 103.2 | 101.7 | 100.1 | 98.5 | 96.9 | 95.5 | 94.2 | 92.9 | 91.5 | | | |
| -40 | 101.0 | 99.6 | 98.0 | 96.5 | 94.9 | 93.6 | 92.2 | | | | | |
| -50 | 98.9 | 97.5 | 95.9 | 94.4 | 92.9 | 91.6 | | | | | | |
| -60 | 96.7 | 95.3 | 93.8 | 92.3 | | | | | | | | |

%N1 Adjustment for Engine Bleeds

| BLEED CONFIGURATION | AIRPORT PRESSURE ALTITUDE (FT) | | | | | | | | | | | |
|---------------------|--------------------------------|-------|-----|------|------|------|------|------|------|------|------|-----|
| | -2000 | -1000 | 0 | 1000 | 2000 | 3000 | 4000 | 5000 | 6000 | 7000 | 8000 | |
| PACKS OFF | 0.3 | 0.3 | 0.3 | 0.3 | 0.3 | 0.3 | 0.3 | 0.4 | 0.5 | 0.5 | 0.5 | 0.5 |

%N1 Altitude Adjustment

| ASSUMED TEMP (°C) | PRESSURE ALTITUDE (FT) | | | | | | | | | | |
|-------------------|------------------------|-------|-----|------|------|------|------|------|------|------|------|
| | -2000 | -1000 | 0 | 1000 | 2000 | 3000 | 4000 | 5000 | 6000 | 7000 | 8000 |
| 70 | 0.2 | 0.1 | 0.0 | -0.2 | -0.3 | -0.5 | -0.6 | -0.8 | -1.0 | -1.2 | -1.3 |
| 60 | 0.1 | 0.1 | 0.0 | -0.2 | -0.3 | -0.5 | -0.6 | -0.8 | -1.0 | -1.2 | -1.3 |
| 50 | 0.0 | 0.0 | 0.0 | 0.0 | 0.0 | -0.1 | -0.2 | -0.5 | -0.7 | -0.9 | -1.0 |
| 40 | 0.0 | 0.0 | 0.0 | 0.0 | 0.0 | -0.1 | -0.2 | -0.3 | -0.4 | -0.4 | -0.4 |
| 32 & BELOW | 0.0 | 0.0 | 0.0 | 0.0 | 0.0 | -0.1 | -0.1 | -0.2 | -0.2 | -0.2 | -0.2 |

**Assumed Temperature Reduced Thrust
Assumed Temperature Minimum %N1
Based on 25% takeoff thrust reduction**

| ACTUAL OAT (°C) | PRESSURE ALTITUDE (FT) | | | | | | | | | | |
|--------------------|------------------------|-------|------|------|------|------|------|------|------|------|------|
| | -2000 | -1000 | 0 | 1000 | 2000 | 3000 | 4000 | 5000 | 6000 | 7000 | 8000 |
| 55 | 96.9 | 96.9 | 96.9 | 96.8 | 96.6 | 96.5 | 96.4 | 96.2 | 96.0 | 95.9 | 95.9 |
| 50 | 97.4 | 97.4 | 97.4 | 97.4 | 97.3 | 97.2 | 97.1 | 97.0 | 96.8 | 96.7 | 96.6 |
| 45 | 97.8 | 97.8 | 97.8 | 97.8 | 97.8 | 97.8 | 97.7 | 97.5 | 97.4 | 97.4 | 97.3 |
| 40 | 98.3 | 98.3 | 98.2 | 98.2 | 98.2 | 98.1 | 98.1 | 98.0 | 97.9 | 97.9 | 97.9 |
| 35 | 98.6 | 98.6 | 98.5 | 98.5 | 98.5 | 98.5 | 98.5 | 98.4 | 98.4 | 98.4 | 98.4 |
| 30 | 98.0 | 98.5 | 98.9 | 98.9 | 98.9 | 98.9 | 98.8 | 98.8 | 98.8 | 98.8 | 98.8 |
| 25 | 97.2 | 97.7 | 98.1 | 98.5 | 98.9 | 98.9 | 99.1 | 99.1 | 99.0 | 99.1 | 99.1 |
| 20 | 96.4 | 96.9 | 97.3 | 97.7 | 98.1 | 98.4 | 98.8 | 99.0 | 99.2 | 99.2 | 99.2 |
| 15 | 95.6 | 96.0 | 96.5 | 96.9 | 97.2 | 97.6 | 98.0 | 98.3 | 98.6 | 98.9 | 99.1 |
| 10 | 94.8 | 95.2 | 95.6 | 96.0 | 96.4 | 96.8 | 97.1 | 97.5 | 97.8 | 98.1 | 98.4 |
| 0 & BELOW | 93.1 | 93.6 | 94.0 | 94.3 | 94.7 | 95.1 | 95.4 | 95.8 | 96.1 | 96.4 | 96.7 |

1. Enter Minimum Assumed Temperature table with airport pressure altitude to determine minimum assumed temperature.
2. Enter Assumed Temperature Limit %N1 table with actual airport temperature and assumed temperature to determine assumed temperature limit %N1. If operating with packs off, apply the bleed adjustment shown in the %N1 Adjustment for Engine Bleeds table.
3. Enter %N1 Altitude Adjustment table with assumed temperature and airport pressure altitude to determine altitude adjustment to %N1 found in step 2.
4. Ensure Takeoff %N1 from step 3 is greater than or equal to minimum %N1 allowed for airport conditions from Assumed Temperature Minimum %N1 table.

TO1 Takeoff Speeds
10% Thrust Reduction

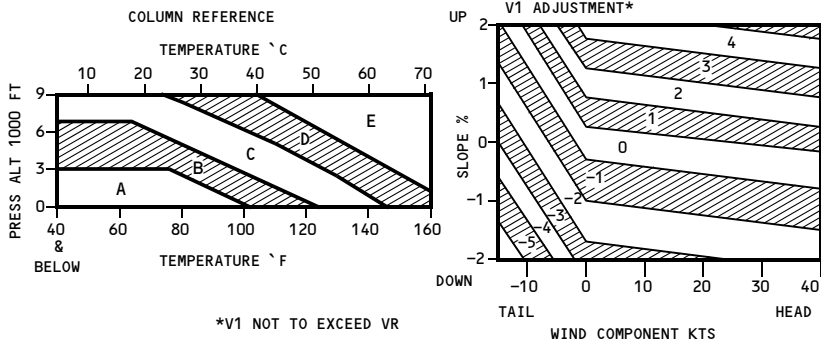

*V1 NOT TO EXCEED VR

| FLAPS | WT 1000 LB | A | | | B | | | C | | | D | | | E | | |
|-------|------------------|----------------|----------------|----------------|----------------|----------------|----------------|----------------|----------------|----------------|----------------|----------------|----------------|----------------|----------------|----------------|
| | | V ₁ | V _R | V ₂ | V ₁ | V _R | V ₂ | V ₁ | V _R | V ₂ | V ₁ | V _R | V ₂ | V ₁ | V _R | V ₂ |
| 5 | 420 | 169 | 172 | 175 | 171 | 174 | 176 | | | | | | | | | |
| | 400 | 164 | 168 | 171 | 166 | 169 | 171 | | | | | | | | | |
| | 380 | 158 | 163 | 167 | 161 | 164 | 167 | 164 | 166 | 168 | | | | | | |
| | 360 | 153 | 158 | 163 | 156 | 159 | 162 | 158 | 161 | 163 | | | | | | |
| | 340 | 147 | 153 | 158 | 150 | 154 | 158 | 153 | 156 | 158 | | | | | | |
| | 320 | 141 | 147 | 153 | 144 | 149 | 153 | 146 | 150 | 153 | 149 | 152 | 153 | | | |
| | 300 | 134 | 142 | 148 | 137 | 143 | 148 | 140 | 145 | 148 | 143 | 146 | 148 | 147 | 148 | 149 |
| | 280 | 128 | 136 | 143 | 131 | 137 | 143 | 134 | 139 | 143 | 137 | 141 | 143 | 141 | 142 | 143 |
| | 260 | 122 | 129 | 138 | 124 | 131 | 138 | 127 | 133 | 138 | 130 | 135 | 138 | 134 | 136 | 138 |
| 240 | 115 | 125 | 133 | 117 | 125 | 133 | 120 | 127 | 133 | 124 | 128 | 133 | 127 | 130 | 133 | |
| 220 | 108 | 116 | 127 | 109 | 117 | 127 | 114 | 120 | 128 | 117 | 122 | 127 | 120 | 124 | 127 | |
| 15 | 420 | 163 | 165 | 169 | | | | | | | | | | | | |
| | 400 | 158 | 160 | 164 | | | | | | | | | | | | |
| | 380 | 153 | 156 | 160 | 155 | 157 | 160 | | | | | | | | | |
| | 360 | 147 | 151 | 156 | 150 | 153 | 156 | | | | | | | | | |
| | 340 | 141 | 146 | 151 | 144 | 148 | 151 | 146 | 149 | 152 | | | | | | |
| | 320 | 136 | 141 | 147 | 138 | 142 | 147 | 141 | 144 | 147 | | | | | | |
| | 300 | 130 | 135 | 142 | 133 | 137 | 142 | 135 | 139 | 142 | 139 | 140 | 142 | | | |
| | 280 | 124 | 130 | 138 | 127 | 131 | 138 | 129 | 133 | 137 | 133 | 135 | 137 | | | |
| | 260 | 118 | 124 | 133 | 121 | 125 | 133 | 123 | 127 | 132 | 127 | 129 | 132 | | | |
| 240 | 112 | 118 | 127 | 112 | 119 | 127 | 117 | 121 | 127 | 119 | 123 | 127 | 124 | 125 | 127 | |
| 220 | 106 | 111 | 122 | 108 | 113 | 122 | 110 | 115 | 122 | 114 | 117 | 122 | 117 | 119 | 122 | |
| 20 | 420 | 161 | 161 | 165 | | | | | | | | | | | | |
| | 400 | 155 | 156 | 160 | 158 | 158 | 160 | | | | | | | | | |
| | 380 | 149 | 151 | 155 | 152 | 152 | 156 | | | | | | | | | |
| | 360 | 144 | 146 | 150 | 146 | 147 | 151 | | | | | | | | | |
| | 340 | 139 | 142 | 146 | 141 | 142 | 146 | 143 | 144 | 147 | | | | | | |
| | 320 | 132 | 136 | 142 | 136 | 137 | 142 | 138 | 139 | 142 | | | | | | |
| | 300 | 127 | 131 | 137 | 130 | 132 | 137 | 132 | 134 | 137 | 135 | 135 | 138 | | | |
| | 280 | 121 | 125 | 133 | 124 | 127 | 133 | 126 | 128 | 133 | 130 | 130 | 133 | | | |
| | 260 | 114 | 119 | 128 | 117 | 121 | 128 | 120 | 123 | 128 | 124 | 125 | 128 | 126 | 126 | 128 |
| 240 | 108 | 114 | 123 | 111 | 115 | 123 | 114 | 117 | 123 | 118 | 119 | 123 | 121 | 121 | 123 | |
| 220 | 101 | 107 | 118 | 104 | 109 | 118 | 107 | 111 | 118 | 111 | 113 | 118 | 115 | 115 | 118 | |

CHECK V1 (MCG) IN BOXED AREA

TO1 V1(MCG)

10% Thrust Reduction

| ACTUAL OAT | | PRESSURE ALTITUDE (FT) | | | | | |
|------------|-----|------------------------|-----|------|------|------|------|
| °F | °C | -1000 | 0 | 2000 | 4000 | 6000 | 8000 |
| 120 | 49 | 99 | 97 | 93 | | | |
| 100 | 38 | 104 | 102 | 98 | 94 | 90 | 87 |
| 80 | 27 | 106 | 105 | 102 | 98 | 94 | 91 |
| 60 | 16 | 107 | 105 | 103 | 100 | 97 | 94 |
| -60 | -51 | 108 | 107 | 104 | 101 | 98 | 95 |

TO1 Takeoff %N1

10% Thrust Reduction

Based on engine bleed for packs on, EEC NORM or ALTN and anti-ice on or off

| AIRPORT OAT | | AIRPORT PRESSURE ALTITUDE (FT) | | | | | |
|-------------|-----|--------------------------------|-------|-------|-------|-------|-------|
| °F | °C | -1000 | 0 | 2000 | 4000 | 6000 | 8000 |
| 131 | 55 | 103.6 | 103.6 | 103.4 | 103.0 | 102.7 | 102.5 |
| 122 | 50 | 104.4 | 104.4 | 104.4 | 104.0 | 103.6 | 103.4 |
| 113 | 45 | 105.0 | 105.0 | 105.0 | 104.8 | 104.6 | 104.4 |
| 104 | 40 | 105.5 | 105.4 | 105.5 | 105.3 | 105.2 | 105.1 |
| 95 | 35 | 105.8 | 105.8 | 105.8 | 105.7 | 105.6 | 105.6 |
| 86 | 30 | 105.7 | 106.2 | 106.2 | 106.1 | 106.1 | 106.1 |
| 77 | 25 | 104.8 | 105.3 | 106.4 | 106.6 | 106.5 | 106.6 |
| 68 | 20 | 103.9 | 104.4 | 105.5 | 106.4 | 106.9 | 106.9 |
| 59 | 15 | 103.1 | 103.6 | 104.6 | 105.5 | 106.4 | 107.1 |
| 50 | 10 | 102.2 | 102.7 | 103.7 | 104.6 | 105.5 | 106.4 |
| 32 | 0 | 100.4 | 100.9 | 101.9 | 102.8 | 103.7 | 104.5 |
| 14 | -10 | 98.6 | 99.0 | 100.1 | 100.9 | 101.8 | 102.6 |
| -4 | -20 | 96.7 | 97.2 | 98.2 | 99.1 | 99.9 | 100.7 |
| -22 | -30 | 94.8 | 95.3 | 96.3 | 97.1 | 98.0 | 98.8 |
| -40 | -40 | 92.9 | 93.3 | 94.3 | 95.2 | 96.0 | 96.8 |
| -58 | -50 | 90.9 | 91.3 | 92.3 | 93.2 | 94.0 | 94.7 |

%N1 Adjustments for Engine Bleeds

| BLEED CONFIGURATION | AIRPORT PRESSURE ALTITUDE (FT) | | | | | |
|---------------------|--------------------------------|-----|------|------|------|------|
| | -1000 | 0 | 2000 | 4000 | 6000 | 8000 |
| PACKS OFF | 0.3 | 0.3 | 0.3 | 0.4 | 0.5 | 0.5 |

TO1 Stab Trim Setting

10% Thrust Reduction

| WEIGHT (1000 LB) | C.G. %MAC | | | | | | |
|------------------|-----------|-------|-------|-------|-------|-------|-------|
| | 12 | 16 | 20 | 24 | 28 | 32 | 36 |
| 420 | 7 | 7 | 6 1/2 | 5 | 4 | 3 1/2 | 2 1/2 |
| 400 | 7 | 6 1/2 | 6 | 5 | 4 | 3 1/2 | 2 1/2 |
| 380 | 7 | 6 1/2 | 5 1/2 | 5 | 4 | 3 | 2 |
| 360 | 7 | 6 | 5 1/2 | 4 1/2 | 3 1/2 | 3 | 2 |
| 340 | 6 1/2 | 6 | 5 | 4 | 3 1/2 | 2 1/2 | 2 |
| 320 | 6 1/2 | 5 1/2 | 4 1/2 | 4 | 3 | 2 1/2 | 1 1/2 |
| 300 | 5 1/2 | 5 | 4 | 3 1/2 | 2 1/2 | 2 | 1 |
| 280 | 5 | 4 1/2 | 3 1/2 | 3 | 2 | 1 1/2 | 1 |
| 260 | 4 1/2 | 4 | 3 | 2 1/2 | 1 1/2 | 1 | 1 |
| 240 | 4 | 3 1/2 | 2 1/2 | 2 | 1 1/2 | 1 | 1 |
| 220 | 3 1/2 | 3 | 2 1/2 | 1 1/2 | 1 1/2 | 1 | 1 |

TO2 Takeoff Speeds
20% Thrust Reduction

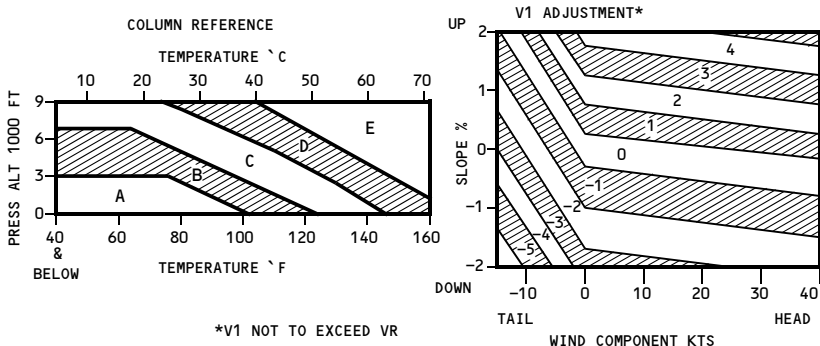

| FLAPS | WT 1000 LB | A | | | B | | | C | | | D | | | E | | |
|-------|------------------|----------------|----------------|----------------|----------------|----------------|----------------|----------------|----------------|----------------|----------------|----------------|----------------|----------------|----------------|----------------|
| | | V ₁ | V _R | V ₂ | V ₁ | V _R | V ₂ | V ₁ | V _R | V ₂ | V ₁ | V _R | V ₂ | V ₁ | V _R | V ₂ |
| 5 | 420 | 171 | 173 | 175 | 173 | 175 | 176 | | | | | | | | | |
| | 400 | 166 | 169 | 171 | 168 | 170 | 171 | | | | | | | | | |
| | 380 | 160 | 164 | 167 | 163 | 165 | 167 | 166 | 167 | 168 | | | | | | |
| | 360 | 155 | 159 | 163 | 158 | 160 | 162 | 160 | 162 | 163 | | | | | | |
| | 340 | 149 | 154 | 158 | 152 | 155 | 158 | 155 | 157 | 158 | | | | | | |
| | 320 | 143 | 148 | 153 | 146 | 150 | 153 | 149 | 151 | 153 | 152 | 153 | 153 | | | |
| | 300 | 137 | 143 | 148 | 140 | 144 | 148 | 143 | 146 | 148 | 146 | 147 | 148 | 149 | 149 | 149 |
| | 280 | 131 | 137 | 143 | 134 | 138 | 143 | 137 | 140 | 143 | 140 | 142 | 143 | 143 | 143 | 143 |
| | 260 | 125 | 130 | 138 | 127 | 132 | 138 | 130 | 134 | 138 | 133 | 136 | 138 | 136 | 137 | 138 |
| | 240 | 118 | 124 | 133 | 120 | 126 | 133 | 123 | 128 | 133 | 126 | 129 | 133 | 129 | 131 | 133 |
| 220 | 110 | 117 | 127 | 111 | 118 | 127 | 116 | 121 | 128 | 119 | 123 | 127 | 122 | 125 | 127 | |
| 15 | 420 | 165 | 166 | 169 | | | | | | | | | | | | |
| | 400 | 160 | 161 | 164 | | | | | | | | | | | | |
| | 380 | 155 | 157 | 160 | 157 | 158 | 160 | | | | | | | | | |
| | 360 | 150 | 152 | 156 | 152 | 154 | 156 | | | | | | | | | |
| | 340 | 144 | 147 | 151 | 147 | 149 | 151 | 149 | 150 | 152 | | | | | | |
| | 320 | 139 | 142 | 147 | 141 | 143 | 147 | 144 | 145 | 147 | | | | | | |
| | 300 | 133 | 136 | 142 | 136 | 138 | 142 | 138 | 140 | 142 | 141 | 141 | 142 | | | |
| | 280 | 127 | 131 | 138 | 129 | 132 | 138 | 132 | 134 | 137 | 135 | 136 | 137 | | | |
| | 260 | 120 | 125 | 133 | 123 | 126 | 133 | 125 | 128 | 132 | 129 | 130 | 132 | | | |
| | 240 | 114 | 119 | 127 | 114 | 120 | 127 | 119 | 122 | 127 | 121 | 124 | 127 | 126 | 126 | 127 |
| 220 | 108 | 112 | 122 | 110 | 114 | 122 | 112 | 116 | 122 | 116 | 118 | 122 | 119 | 120 | 122 | |
| 20 | 420 | 162 | 162 | 165 | | | | | | | | | | | | |
| | 400 | 157 | 157 | 160 | 159 | 159 | 160 | | | | | | | | | |
| | 380 | 152 | 152 | 155 | 153 | 153 | 156 | | | | | | | | | |
| | 360 | 147 | 147 | 150 | 148 | 148 | 151 | | | | | | | | | |
| | 340 | 142 | 143 | 146 | 143 | 143 | 146 | 145 | 145 | 147 | | | | | | |
| | 320 | 135 | 137 | 142 | 138 | 138 | 142 | 140 | 140 | 142 | | | | | | |
| | 300 | 129 | 132 | 137 | 132 | 133 | 137 | 134 | 135 | 137 | 136 | 136 | 138 | | | |
| | 280 | 123 | 126 | 133 | 126 | 128 | 133 | 128 | 129 | 133 | 131 | 131 | 133 | | | |
| | 260 | 116 | 120 | 128 | 119 | 122 | 128 | 122 | 124 | 128 | 126 | 126 | 128 | 127 | 127 | 128 |
| | 240 | 110 | 115 | 123 | 113 | 116 | 123 | 116 | 118 | 123 | 120 | 120 | 123 | 122 | 122 | 123 |
| 220 | 103 | 108 | 118 | 106 | 110 | 118 | 109 | 112 | 118 | 113 | 114 | 118 | 116 | 116 | 118 | |

TO2 V1(MCG)
20% Thrust Reduction

| ACTUAL OAT | | PRESSURE ALTITUDE (FT) | | | | | |
|------------|-----|------------------------|-----|------|------|------|------|
| °F | °C | -1000 | 0 | 2000 | 4000 | 6000 | 8000 |
| 120 | 49 | 94 | 92 | 89 | | | |
| 100 | 38 | 99 | 97 | 93 | 89 | 86 | 83 |
| 80 | 27 | 101 | 99 | 95 | 91 | 88 | 85 |
| 60 | 16 | 101 | 100 | 97 | 95 | 92 | 89 |
| -60 | -51 | 103 | 101 | 98 | 96 | 93 | 90 |

TO2 Takeoff %N1

20% Thrust Reduction

Based on engine bleed for packs on, EEC NORM or ALTN and anti-ice on or off

| AIRPORT OAT | | AIRPORT PRESSURE ALTITUDE (FT) | | | | | |
|-------------|-----|--------------------------------|-------|-------|-------|-------|-------|
| °F | °C | -1000 | 0 | 2000 | 4000 | 6000 | 8000 |
| 131 | 55 | 99.8 | 99.7 | 99.5 | 99.1 | 98.8 | 98.6 |
| 122 | 50 | 100.5 | 100.5 | 100.4 | 100.1 | 99.7 | 99.6 |
| 113 | 45 | 101.1 | 101.1 | 101.1 | 100.9 | 100.7 | 100.5 |
| 104 | 40 | 101.7 | 101.7 | 101.7 | 101.5 | 101.4 | 101.3 |
| 95 | 35 | 101.8 | 101.8 | 101.8 | 101.7 | 101.7 | 101.7 |
| 86 | 30 | 101.6 | 102.0 | 102.0 | 101.9 | 101.8 | 101.9 |
| 77 | 25 | 100.7 | 101.1 | 102.0 | 102.2 | 102.2 | 102.2 |
| 68 | 20 | 99.9 | 100.3 | 101.2 | 101.9 | 102.3 | 102.3 |
| 59 | 15 | 99.0 | 99.4 | 100.3 | 101.1 | 101.7 | 102.2 |
| 50 | 10 | 98.2 | 98.6 | 99.5 | 100.2 | 100.9 | 101.5 |
| 32 | 0 | 96.5 | 96.9 | 97.7 | 98.4 | 99.1 | 99.7 |
| 14 | -10 | 94.7 | 95.1 | 96.0 | 96.7 | 97.3 | 97.9 |
| -4 | -20 | 92.9 | 93.3 | 94.2 | 94.9 | 95.5 | 96.0 |
| -22 | -30 | 91.1 | 91.5 | 92.4 | 93.0 | 93.6 | 94.2 |
| -40 | -40 | 89.2 | 89.6 | 90.5 | 91.1 | 91.7 | 92.3 |
| -58 | -50 | 87.3 | 87.7 | 88.6 | 89.2 | 89.8 | 90.3 |

%N1 Adjustments for Engine Bleeds

| BLEED CONFIGURATION | AIRPORT PRESSURE ALTITUDE (FT) | | | | | |
|---------------------|--------------------------------|-----|------|------|------|------|
| | -1000 | 0 | 2000 | 4000 | 6000 | 8000 |
| PACKS OFF | 0.3 | 0.3 | 0.3 | 0.4 | 0.5 | 0.5 |

TO2 Stab Trim Setting

20% Thrust Reduction

| WEIGHT (1000 LB) | C.G. %MAC | | | | | | |
|------------------|-----------|-------|-------|-------|-------|-------|-------|
| | 12 | 16 | 20 | 24 | 28 | 32 | 36 |
| 420 | 7 | 7 | 7 | 5 1/2 | 4 1/2 | 4 | 3 |
| 400 | 7 | 7 | 6 1/2 | 5 1/2 | 4 1/2 | 4 | 3 |
| 380 | 7 | 7 | 6 | 5 1/2 | 4 1/2 | 3 1/2 | 2 1/2 |
| 360 | 7 | 6 1/2 | 6 | 5 | 4 | 3 1/2 | 2 1/2 |
| 340 | 7 | 6 1/2 | 5 1/2 | 4 1/2 | 4 | 3 | 2 1/2 |
| 320 | 7 | 6 | 5 | 4 1/2 | 3 1/2 | 3 | 2 |
| 300 | 6 | 5 1/2 | 4 1/2 | 4 | 3 | 2 1/2 | 1 1/2 |
| 280 | 5 1/2 | 5 | 4 | 3 1/2 | 2 1/2 | 2 | 1 1/2 |
| 260 | 5 | 4 1/2 | 3 1/2 | 3 | 2 | 1 1/2 | 1 1/2 |
| 240 | 4 1/2 | 4 | 3 | 2 1/2 | 2 | 1 1/2 | 1 1/2 |
| 220 | 4 | 3 1/2 | 3 | 2 | 2 | 1 1/2 | 1 1/2 |

Max Climb %N1

Based on engine bleed for packs on and anti-ice off

| TAT (°C) | PRESSURE ALTITUDE (1000 FT)/SPEED (KIAS OR MACH) | | | | | | | | |
|-------------|--|-------|-------|-------|-------|-------|-------|-------|-------|
| | 0 | 5 | 10 | 15 | 20 | 25 | 30 | 35 | 40 |
| | 250 | 250 | 250 | 290 | 290 | 290 | 290 | .78 | .78 |
| 60 | 96.5 | 97.2 | 97.0 | 97.4 | 96.7 | 95.1 | 96.1 | 95.1 | 94.7 |
| 50 | 97.6 | 98.7 | 99.0 | 99.6 | 98.9 | 97.3 | 98.2 | 95.0 | 93.8 |
| 40 | 98.8 | 99.8 | 100.4 | 101.2 | 101.0 | 99.3 | 100.1 | 97.0 | 95.8 |
| 30 | 99.1 | 101.1 | 101.6 | 102.4 | 102.5 | 101.2 | 101.9 | 98.8 | 97.7 |
| 20 | 97.5 | 101.3 | 103.3 | 103.8 | 104.1 | 102.8 | 103.4 | 100.5 | 99.4 |
| 10 | 95.8 | 99.6 | 102.9 | 104.4 | 105.6 | 104.6 | 104.7 | 102.6 | 100.9 |
| 0 | 94.2 | 97.8 | 101.1 | 102.6 | 105.0 | 106.9 | 106.5 | 104.3 | 102.4 |
| -10 | 92.5 | 96.1 | 99.4 | 100.8 | 103.2 | 105.3 | 107.1 | 106.3 | 104.3 |
| -20 | 90.8 | 94.3 | 97.6 | 99.0 | 101.5 | 103.4 | 105.1 | 106.5 | 106.4 |
| -30 | 89.1 | 92.4 | 95.7 | 97.1 | 99.7 | 101.5 | 103.2 | 104.4 | 104.4 |
| -40 | 87.3 | 90.5 | 93.9 | 95.2 | 97.8 | 99.5 | 101.2 | 102.2 | 102.2 |
| -50 | 85.5 | 88.6 | 91.9 | 93.3 | 95.8 | 97.5 | 99.1 | 100.1 | 100.1 |

%N1 Adjustments for Engine Bleeds

| BLEED CONFIGURATION | PRESSURE ALTITUDE (1000 FT) | | | | | | | | |
|---------------------------|-----------------------------|------|------|------|------|------|------|------|------|
| | 0 | 5 | 10 | 15 | 20 | 25 | 30 | 35 | 40 |
| PACKS OFF | 0.0 | 0.0 | 0.0 | 0.0 | 0.0 | 0.0 | 0.0 | 0.0 | 0.0 |
| ENGINE ANTI-ICE ON | -0.6 | -0.6 | -0.6 | -0.6 | -0.8 | -0.9 | -1.1 | -1.4 | -1.9 |
| ENGINE & WING ANTI-ICE ON | -0.9 | -0.9 | -1.0 | -1.1 | -1.3 | -1.4 | -1.7 | -2.2 | -2.4 |

Go-around %N1

Based on engine bleed for packs on, EEC NORM or ALTN and anti-ice on or off

| AIRPORT OAT | | TAT (°C) | AIRPORT PRESSURE ALTITUDE (FT) | | | | | | |
|-------------|-----|-------------|--------------------------------|-------|-------|-------|-------|-------|-------|
| °F | °C | | -1000 | 0 | 2000 | 4000 | 6000 | 8000 | 9000 |
| 131 | 55 | 58 | 106.1 | 106.1 | 105.9 | 105.5 | 105.1 | 104.9 | 104.7 |
| 122 | 50 | 53 | 106.8 | 106.9 | 106.8 | 106.5 | 106.1 | 105.9 | 105.7 |
| 113 | 45 | 48 | 107.5 | 107.5 | 107.5 | 107.3 | 107.0 | 106.9 | 106.6 |
| 104 | 40 | 43 | 108.2 | 108.2 | 108.2 | 108.0 | 107.9 | 107.8 | 107.7 |
| 95 | 35 | 38 | 109.0 | 108.9 | 109.0 | 108.8 | 108.7 | 108.7 | 108.6 |
| 86 | 30 | 33 | 109.1 | 109.8 | 109.8 | 109.7 | 109.6 | 109.7 | 109.6 |
| 77 | 25 | 28 | 108.2 | 108.9 | 110.3 | 110.6 | 110.5 | 110.6 | 110.6 |
| 68 | 20 | 23 | 107.3 | 108.0 | 109.4 | 110.6 | 111.3 | 111.4 | 111.3 |
| 59 | 15 | 18 | 106.4 | 107.1 | 108.5 | 109.7 | 111.0 | 112.0 | 112.1 |
| 50 | 10 | 13 | 105.5 | 106.2 | 107.5 | 108.8 | 110.0 | 111.3 | 112.1 |
| 32 | 0 | 3 | 103.6 | 104.3 | 105.7 | 106.9 | 108.1 | 109.4 | 110.1 |
| 14 | -10 | -7 | 101.7 | 102.4 | 103.8 | 104.9 | 106.1 | 107.4 | 108.1 |
| -4 | -20 | -17 | 99.8 | 100.4 | 101.8 | 103.0 | 104.2 | 105.4 | 106.1 |
| -22 | -30 | -27 | 97.9 | 98.5 | 99.8 | 101.0 | 102.2 | 103.4 | 104.0 |
| -40 | -40 | -37 | 95.9 | 96.4 | 97.8 | 99.0 | 100.1 | 101.3 | 102.0 |
| -58 | -50 | -47 | 93.8 | 94.4 | 95.8 | 96.9 | 98.0 | 99.2 | 99.8 |

%N1 Adjustments for Engine Bleeds

| BLEED CONFIGURATION | AIRPORT PRESSURE ALTITUDE (FT) | | | | | | |
|------------------------|--------------------------------|-----|------|------|------|------|------|
| | -1000 | 0 | 2000 | 4000 | 6000 | 8000 | 9000 |
| PACKS OFF | 0.3 | 0.3 | 0.3 | 0.4 | 0.5 | 0.5 | 0.5 |

Flight With Unreliable Airspeed / Turbulent Air Penetration
 Altitude and/or vertical speed indications may also be unreliable.

Climb (290/.78)

Flaps Up, Set Max Climb Thrust

| PRESSURE ALTITUDE (FT) | | WEIGHT (1000 LB) | | | | |
|---------------------------|--------------|------------------|------|------|------|------|
| | | 220 | 260 | 300 | 350 | 400 |
| 40000 | PITCH ATT | 4.0 | 4.0 | 4.0 | | |
| | V/S (FT/MIN) | 1700 | 1100 | 500 | | |
| 30000 | PITCH ATT | 4.5 | 4.0 | 4.0 | 4.0 | 4.0 |
| | V/S (FT/MIN) | 2700 | 2200 | 1800 | 1300 | 900 |
| 20000 | PITCH ATT | 7.0 | 6.5 | 6.0 | 6.0 | 5.5 |
| | V/S (FT/MIN) | 4200 | 3400 | 2900 | 2300 | 1800 |
| 10000 | PITCH ATT | 10.5 | 9.5 | 8.5 | 8.0 | 7.5 |
| | V/S (FT/MIN) | 5700 | 4700 | 4000 | 3200 | 2700 |
| SEA LEVEL | PITCH ATT | 13.0 | 11.5 | 10.5 | 9.5 | 9.0 |
| | V/S (FT/MIN) | 6300 | 5300 | 4500 | 3700 | 3100 |

Cruise (.78/290)

Flaps Up, %N1 for Level Flight

| PRESSURE ALTITUDE (FT) | | WEIGHT (1000 LB) | | | | |
|---------------------------|-----------|------------------|-----|-----|-----|-----|
| | | 220 | 260 | 300 | 350 | 400 |
| 40000 | PITCH ATT | 2.0 | 2.5 | 3.5 | 4.0 | |
| | %N1 | 88 | 92 | 97 | 107 | |
| 35000 | PITCH ATT | 1.5 | 2.0 | 2.5 | 3.0 | 3.5 |
| | %N1 | 85 | 87 | 89 | 93 | 98 |
| 30000 | PITCH ATT | 1.0 | 1.5 | 1.5 | 2.0 | 2.5 |
| | %N1 | 84 | 86 | 87 | 89 | 92 |

Descent (.78/290)

Flaps Up, Set Idle Thrust

| PRESSURE ALTITUDE (FT) | | WEIGHT (1000 LB) | | | | |
|---------------------------|--------------|------------------|-------|-------|-------|-------|
| | | 220 | 260 | 300 | 350 | 400 |
| 40000 | PITCH ATT | -1.5 | -0.5 | -0.0 | 0.5 | |
| | V/S (FT/MIN) | -2600 | -2600 | -2600 | -2800 | |
| 30000 | PITCH ATT | -2.5 | -2.0 | -1.0 | -0.5 | 0.0 |
| | V/S (FT/MIN) | -2700 | -2400 | -2200 | -2100 | -2000 |
| 20000 | PITCH ATT | -2.5 | -1.5 | -1.0 | -0.5 | 0.5 |
| | V/S (FT/MIN) | -2400 | -2100 | -2000 | -1900 | -1800 |
| 10000 | PITCH ATT | -2.5 | -2.0 | -1.0 | -0.5 | 0.5 |
| | V/S (FT/MIN) | -2100 | -1900 | -1800 | -1700 | -1600 |

Holding (VREF30+80)

Flaps Up, %N1 for Level Flight

| PRESSURE ALTITUDE (FT) | | WEIGHT (1000 LB) | | | | |
|---------------------------|-----------|------------------|-----|-----|-----|-----|
| | | 220 | 260 | 300 | 350 | 220 |
| 10000 | PITCH ATT | 4.5 | 5.0 | 5.0 | 5.5 | 5.5 |
| | %N1 | 60 | 64 | 67 | 72 | 76 |

Flight With Unreliable Airspeed / Turbulent Air Penetration
Altitude and/or vertical speed indications may also be unreliable.
Terminal Area (5000 FT)
Gear Up, %N1 for Level Flight

| FLAP POSITION (VREF + INCREMENT) | | WEIGHT (1000 LB) | | | | |
|-------------------------------------|------------------|------------------|------------|------------|------------|------------|
| | | 220 | 260 | 300 | 350 | 400 |
| FLAPS UP (VREF30 + 80) | PITCH ATT | 4.5 | 5.0 | 5.0 | 5.5 | 5.5 |
| | %N1 | 56 | 60 | 63 | 68 | 71 |
| FLAPS 1 (VREF30 + 60) | PITCH ATT | 6.0 | 6.5 | 7.0 | 7.0 | 7.0 |
| | %N1 | 56 | 61 | 65 | 70 | 73 |
| FLAPS 5 (VREF30 + 40) | PITCH ATT | 4.5 | 5.0 | 5.0 | 5.0 | 5.0 |
| | %N1 | 59 | 64 | 67 | 72 | 75 |
| FLAPS 15 (VREF30 + 20) | PITCH ATT | 6.0 | 6.0 | 6.5 | 6.0 | 5.5 |
| | %N1 | 60 | 65 | 69 | 74 | 77 |
| FLAPS 20 (VREF30 + 20) | PITCH ATT | 4.5 | 4.5 | 4.5 | 4.5 | 4.0 |
| | %N1 | 62 | 67 | 70 | 75 | 78 |

Final Approach (1500 FT)
Gear Down, %N1 for 3° Glideslope

| FLAP POSITION (VREF + INCREMENT) | | WEIGHT (1000 LB) | | | | |
|-------------------------------------|------------------|------------------|------------|------------|------------|-------------|
| | | 220 | 260 | 300 | 350 | 400 |
| FLAPS 25 (VREF25 + 10) | PITCH ATT | 0.5 | 1.0 | 1.0 | 1.0 | 1.0 |
| | %N1 | 54 | 59 | 62 | 67 | 70 |
| FLAPS 30 (VREF30 + 10) | PITCH ATT | 1.0 | 1.0 | 1.0 | 0.5 | -0.5 |
| | %N1 | 57 | 62 | 66 | 71 | 75 |

Performance Inflight - All Engine

Chapter PI Section 11

Long Range Cruise Maximum Operating Altitude

ISA + 10°C and Below

| WEIGHT (1000 LB) | OPTIMUM ALT (FT) | TAT (°C) | MARGIN TO INITIAL BUFFET 'G' (BANK ANGLE) | | | | |
|---------------------|---------------------|-------------|---|------------|------------|------------|------------|
| | | | 1.20 (33°) | 1.25 (36°) | 1.30 (39°) | 1.40 (44°) | 1.50 (48°) |
| 420 | 28800 | -1 | 34400 | 33500 | 32600 | 30900 | 29300 |
| 400 | 29900 | -3 | 35400 | 34500 | 33600 | 31900 | 30400 |
| 380 | 31000 | -6 | 36500 | 35600 | 34700 | 33000 | 31500 |
| 360 | 32200 | -8 | 37600 | 36700 | 35800 | 34200 | 32600 |
| 340 | 33400 | -11 | 38800 | 37900 | 37000 | 35400 | 33900 |
| 320 | 34700 | -14 | 40000 | 39100 | 38300 | 36700 | 35100 |
| 300 | 36000 | -17 | 41400 | 40500 | 39600 | 38000 | 36500 |
| 280 | 37500 | -17 | 42800 | 41900 | 41100 | 39400 | 37900 |
| 260 | 39000 | -17 | 43000 | 43000 | 42600 | 41000 | 39500 |
| 240 | 40700 | -17 | 43000 | 43000 | 43000 | 42600 | 41100 |
| 220 | 42500 | -17 | 43000 | 43000 | 43000 | 43000 | 42900 |

ISA + 15°C

| WEIGHT (1000 LB) | OPTIMUM ALT (FT) | TAT (°C) | MARGIN TO INITIAL BUFFET 'G' (BANK ANGLE) | | | | |
|---------------------|---------------------|-------------|---|------------|------------|------------|------------|
| | | | 1.20 (33°) | 1.25 (36°) | 1.30 (39°) | 1.40 (44°) | 1.50 (48°) |
| 420 | 28800 | 5 | 33700* | 33500 | 32600 | 30900 | 29300 |
| 400 | 29900 | 2 | 34900* | 34500 | 33600 | 31900 | 30400 |
| 380 | 31000 | 0 | 35900* | 35600 | 34700 | 33000 | 31500 |
| 360 | 32200 | -3 | 37000* | 36700 | 35800 | 34200 | 32600 |
| 340 | 33400 | -6 | 38100* | 37900 | 37000 | 35400 | 33900 |
| 320 | 34700 | -8 | 39300* | 39100 | 38300 | 36700 | 35100 |
| 300 | 36000 | -11 | 40600* | 40500 | 39600 | 38000 | 36500 |
| 280 | 37500 | -12 | 41900* | 41900 | 41100 | 39400 | 37900 |
| 260 | 39000 | -12 | 43000 | 43000 | 42600 | 41000 | 39500 |
| 240 | 40700 | -12 | 43000 | 43000 | 43000 | 42600 | 41100 |
| 220 | 42500 | -12 | 43000 | 43000 | 43000 | 43000 | 42900 |

ISA + 20°C

| WEIGHT (1000 LB) | OPTIMUM ALT (FT) | TAT (°C) | MARGIN TO INITIAL BUFFET 'G' (BANK ANGLE) | | | | |
|---------------------|---------------------|-------------|---|------------|------------|------------|------------|
| | | | 1.20 (33°) | 1.25 (36°) | 1.30 (39°) | 1.40 (44°) | 1.50 (48°) |
| 420 | 28800 | 10 | 32700* | 32700* | 32600 | 30900 | 29300 |
| 400 | 29900 | 8 | 33800* | 33800* | 33600 | 31900 | 30400 |
| 380 | 31000 | 5 | 35000* | 35000* | 34700 | 33000 | 31500 |
| 360 | 32200 | 3 | 36100* | 36100* | 35800 | 34200 | 32600 |
| 340 | 33400 | 0 | 37200* | 37200* | 37000 | 35400 | 33900 |
| 320 | 34700 | -3 | 38400* | 38400* | 38300 | 36700 | 35100 |
| 300 | 36000 | -6 | 39600* | 39600* | 39600 | 38000 | 36500 |
| 280 | 37500 | -6 | 41000* | 41000* | 41000* | 39400 | 37900 |
| 260 | 39000 | -6 | 42500* | 42500* | 42500* | 41000 | 39500 |
| 240 | 40700 | -6 | 43000 | 43000 | 43000 | 42600 | 41100 |
| 220 | 42500 | -6 | 43000 | 43000 | 43000 | 43000 | 42900 |

*Denotes altitude thrust limited in level flight.

Long Range Cruise Control

| WEIGHT (1000 LB) | | PRESSURE ALTITUDE (1000 FT) | | | | | | | | | | |
|---------------------|--------|-----------------------------|------|------|------|------|------|------|------|------|------|------|
| | | 23 | 25 | 27 | 29 | 31 | 33 | 35 | 37 | 39 | 41 | 43 |
| 420 | %N1 | 89.8 | 90.9 | 92.1 | 93.5 | 95.3 | 97.7 | | | | | |
| | MACH | .772 | .787 | .800 | .804 | .802 | .798 | | | | | |
| | KIAS | 338 | 332 | 324 | 312 | 298 | 284 | | | | | |
| | FF/ENG | 7229 | 7061 | 6950 | 6871 | 6889 | 7067 | | | | | |
| 400 | %N1 | 88.8 | 89.9 | 91.0 | 92.3 | 93.9 | 95.9 | 99.2 | | | | |
| | MACH | .764 | .778 | .793 | .803 | .803 | .800 | .797 | | | | |
| | KIAS | 334 | 328 | 321 | 312 | 299 | 285 | 271 | | | | |
| | FF/ENG | 6948 | 6777 | 6661 | 6566 | 6517 | 6573 | 6896 | | | | |
| 380 | %N1 | 87.9 | 88.9 | 90.0 | 91.2 | 92.6 | 94.3 | 96.7 | | | | |
| | MACH | .754 | .770 | .785 | .798 | .804 | .802 | .799 | | | | |
| | KIAS | 330 | 324 | 317 | 310 | 299 | 285 | 271 | | | | |
| | FF/ENG | 6654 | 6499 | 6371 | 6278 | 6192 | 6188 | 6327 | | | | |
| 360 | %N1 | 86.8 | 87.9 | 88.9 | 90.1 | 91.3 | 92.9 | 94.8 | 98.4 | | | |
| | MACH | .742 | .760 | .776 | .791 | .802 | .803 | .800 | .797 | | | |
| | KIAS | 324 | 319 | 313 | 307 | 298 | 286 | 272 | 259 | | | |
| | FF/ENG | 6352 | 6217 | 6090 | 5992 | 5898 | 5842 | 5868 | 6137 | | | |
| 340 | %N1 | 85.5 | 86.8 | 87.9 | 88.9 | 90.1 | 91.4 | 93.2 | 95.8 | | | |
| | MACH | .725 | .749 | .766 | .781 | .796 | .804 | .802 | .799 | | | |
| | KIAS | 316 | 314 | 309 | 302 | 296 | 286 | 273 | 259 | | | |
| | FF/ENG | 6001 | 5923 | 5815 | 5706 | 5619 | 5535 | 5511 | 5628 | | | |
| 320 | %N1 | 84.1 | 85.5 | 86.7 | 87.8 | 88.9 | 90.1 | 91.6 | 93.8 | 97.5 | | |
| | MACH | .703 | .733 | .754 | .771 | .786 | .800 | .804 | .801 | .798 | | |
| | KIAS | 306 | 307 | 304 | 298 | 292 | 284 | 273 | 260 | 247 | | |
| | FF/ENG | 5625 | 5600 | 5526 | 5429 | 5335 | 5251 | 5188 | 5224 | 5448 | | |
| 300 | %N1 | 82.6 | 84.0 | 85.5 | 86.6 | 87.6 | 88.8 | 90.0 | 92.1 | 94.9 | 99.3 | |
| | MACH | .683 | .711 | .740 | .759 | .775 | .791 | .802 | .803 | .800 | .797 | |
| | KIAS | 297 | 297 | 298 | 293 | 287 | 281 | 273 | 261 | 248 | 236 | |
| | FF/ENG | 5269 | 5236 | 5222 | 5149 | 5055 | 4972 | 4894 | 4880 | 4982 | 5266 | |
| 280 | %N1 | 80.8 | 82.4 | 83.9 | 85.3 | 86.4 | 87.5 | 88.6 | 90.4 | 92.9 | 96.0 | |
| | MACH | .661 | .688 | .718 | .745 | .763 | .779 | .795 | .804 | .802 | .799 | |
| | KIAS | 287 | 287 | 288 | 288 | 282 | 276 | 270 | 261 | 249 | 236 | |
| | FF/ENG | 4913 | 4882 | 4869 | 4858 | 4781 | 4691 | 4618 | 4575 | 4609 | 4740 | |
| 260 | %N1 | 79.0 | 80.6 | 82.2 | 83.7 | 85.0 | 86.1 | 87.2 | 88.8 | 91.0 | 93.6 | 97.1 |
| | MACH | .640 | .665 | .693 | .723 | .749 | .767 | .783 | .798 | .804 | .802 | .798 |
| | KIAS | 277 | 277 | 277 | 278 | 277 | 271 | 265 | 259 | 249 | 237 | 225 |
| | FF/ENG | 4575 | 4535 | 4512 | 4514 | 4493 | 4419 | 4337 | 4294 | 4286 | 4335 | 4491 |
| 240 | %N1 | 77.1 | 78.6 | 80.3 | 81.8 | 83.3 | 84.6 | 85.7 | 87.2 | 89.3 | 91.6 | 94.2 |
| | MACH | .618 | .642 | .667 | .696 | .727 | .751 | .769 | .786 | .800 | .804 | .801 |
| | KIAS | 267 | 267 | 266 | 267 | 268 | 266 | 260 | 254 | 248 | 238 | 226 |
| | FF/ENG | 4251 | 4208 | 4173 | 4155 | 4169 | 4138 | 4065 | 4015 | 3997 | 3996 | 4054 |
| 220 | %N1 | 75.2 | 76.6 | 78.1 | 79.8 | 81.4 | 82.9 | 84.1 | 85.6 | 87.5 | 89.6 | 92.0 |
| | MACH | .596 | .618 | .642 | .668 | .697 | .729 | .753 | .771 | .787 | .800 | .804 |
| | KIAS | 257 | 256 | 256 | 256 | 256 | 257 | 254 | 249 | 243 | 237 | 227 |
| | FF/ENG | 3930 | 3894 | 3850 | 3820 | 3813 | 3831 | 3789 | 3740 | 3718 | 3700 | 3703 |

Shaded area approximates optimum altitude.

Long Range Cruise Enroute Fuel and Time - Low Altitudes
Ground to Air Miles Conversion

| AIR DISTANCE (NM) | | | | | GROUND DISTANCE (NM) | AIR DISTANCE (NM) | | | | |
|--------------------------|------|------|------|------|----------------------|--------------------------|------|------|------|------|
| HEADWIND COMPONENT (KTS) | | | | | | TAILWIND COMPONENT (KTS) | | | | |
| 100 | 80 | 60 | 40 | 20 | | 20 | 40 | 60 | 80 | 100 |
| 283 | 262 | 243 | 226 | 213 | 200 | 191 | 182 | 174 | 167 | 161 |
| 566 | 523 | 485 | 453 | 425 | 400 | 382 | 366 | 351 | 337 | 324 |
| 851 | 786 | 729 | 680 | 638 | 600 | 574 | 550 | 527 | 506 | 487 |
| 1137 | 1051 | 974 | 908 | 851 | 800 | 765 | 732 | 702 | 675 | 650 |
| 1424 | 1315 | 1218 | 1136 | 1064 | 1000 | 957 | 916 | 879 | 844 | 813 |
| 1712 | 1581 | 1464 | 1364 | 1278 | 1200 | 1148 | 1099 | 1054 | 1013 | 975 |
| 2001 | 1847 | 1709 | 1592 | 1491 | 1400 | 1339 | 1282 | 1229 | 1181 | 1138 |
| 2292 | 2114 | 1956 | 1821 | 1705 | 1600 | 1530 | 1465 | 1405 | 1350 | 1300 |
| 2584 | 2382 | 2203 | 2051 | 1919 | 1800 | 1721 | 1648 | 1580 | 1518 | 1462 |
| 2878 | 2652 | 2451 | 2280 | 2132 | 2000 | 1912 | 1830 | 1755 | 1686 | 1623 |

Reference Fuel And Time Required at Check Point

| AIR DIST (NM) | PRESSURE ALTITUDE (1000 FT) | | | | | | | | | |
|---------------|-----------------------------|---------------|----------------|---------------|----------------|---------------|----------------|---------------|----------------|---------------|
| | 10 | | 14 | | 20 | | 24 | | 28 | |
| | FUEL (1000 LB) | TIME (HR:MIN) | FUEL (1000 LB) | TIME (HR:MIN) | FUEL (1000 LB) | TIME (HR:MIN) | FUEL (1000 LB) | TIME (HR:MIN) | FUEL (1000 LB) | TIME (HR:MIN) |
| 200 | 5.8 | 0:40 | 5.1 | 0:38 | 4.3 | 0:37 | 3.8 | 0:36 | 3.3 | 0:35 |
| 400 | 12.2 | 1:15 | 11.0 | 1:12 | 9.6 | 1:07 | 8.7 | 1:04 | 8.0 | 1:02 |
| 600 | 18.4 | 1:51 | 16.8 | 1:45 | 14.9 | 1:38 | 13.6 | 1:33 | 12.5 | 1:29 |
| 800 | 24.6 | 2:27 | 22.6 | 2:19 | 20.1 | 2:09 | 18.5 | 2:02 | 17.1 | 1:56 |
| 1000 | 30.7 | 3:03 | 28.3 | 2:53 | 25.2 | 2:40 | 23.3 | 2:32 | 21.6 | 2:24 |
| 1200 | 36.8 | 3:40 | 34.0 | 3:28 | 30.3 | 3:12 | 28.1 | 3:02 | 26.0 | 2:51 |
| 1400 | 42.8 | 4:17 | 39.6 | 4:03 | 35.4 | 3:44 | 32.8 | 3:31 | 30.4 | 3:19 |
| 1600 | 48.8 | 4:54 | 45.1 | 4:38 | 40.4 | 4:16 | 37.5 | 4:02 | 34.8 | 3:47 |
| 1800 | 54.7 | 5:32 | 50.6 | 5:13 | 45.4 | 4:48 | 42.1 | 4:32 | 39.2 | 4:16 |
| 2000 | 60.5 | 6:10 | 56.1 | 5:49 | 50.3 | 5:21 | 46.7 | 5:03 | 43.5 | 4:44 |

Fuel Required Adjustment (1000 LB)

| REFERENCE FUEL REQUIRED (1000 LB) | WEIGHT AT CHECK POINT (1000 LB) | | | | |
|-----------------------------------|---------------------------------|------|-----|-----|------|
| | 200 | 250 | 300 | 350 | 400 |
| 5 | -0.5 | -0.3 | 0.0 | 0.3 | 0.6 |
| 10 | -1.4 | -0.7 | 0.0 | 0.8 | 1.6 |
| 15 | -2.2 | -1.1 | 0.0 | 1.2 | 2.6 |
| 20 | -3.1 | -1.5 | 0.0 | 1.7 | 3.5 |
| 25 | -3.9 | -1.9 | 0.0 | 2.2 | 4.5 |
| 30 | -4.7 | -2.3 | 0.0 | 2.7 | 5.4 |
| 35 | -5.5 | -2.7 | 0.0 | 3.2 | 6.4 |
| 40 | -6.3 | -3.2 | 0.0 | 3.7 | 7.4 |
| 45 | -7.1 | -3.6 | 0.0 | 4.2 | 8.3 |
| 50 | -7.9 | -4.0 | 0.0 | 4.7 | 9.3 |
| 55 | -8.7 | -4.4 | 0.0 | 5.2 | 10.2 |
| 60 | -9.5 | -4.8 | 0.0 | 5.7 | 11.2 |
| 65 | -10.4 | -5.2 | 0.0 | 6.2 | 12.1 |

**Long Range Cruise Enroute Fuel and Time - High Altitudes
Ground to Air Miles Conversion**

| AIR DISTANCE (NM) | | | | | GROUND DISTANCE (NM) | AIR DISTANCE (NM) | | | | |
|--------------------------|------|------|------|------|----------------------|--------------------------|------|------|------|------|
| HEADWIND COMPONENT (KTS) | | | | | | TAILWIND COMPONENT (KTS) | | | | |
| 100 | 80 | 60 | 40 | 20 | | 20 | 40 | 60 | 80 | 100 |
| 1299 | 1227 | 1161 | 1102 | 1049 | 1000 | 957 | 918 | 881 | 848 | 818 |
| 1947 | 1839 | 1740 | 1652 | 1573 | 1500 | 1437 | 1378 | 1323 | 1273 | 1228 |
| 2598 | 2453 | 2321 | 2204 | 2098 | 2000 | 1916 | 1838 | 1766 | 1699 | 1639 |
| 3253 | 3071 | 2904 | 2756 | 2623 | 2500 | 2395 | 2298 | 2208 | 2125 | 2050 |
| 3912 | 3691 | 3489 | 3309 | 3148 | 3000 | 2875 | 2758 | 2650 | 2551 | 2461 |
| 4575 | 4314 | 4076 | 3865 | 3675 | 3500 | 3355 | 3219 | 3093 | 2977 | 2871 |
| 5243 | 4940 | 4665 | 4420 | 4201 | 4000 | 3834 | 3679 | 3536 | 3403 | 3282 |
| 5915 | 5570 | 5256 | 4978 | 4729 | 4500 | 4313 | 4139 | 3978 | 3829 | 3693 |
| 6591 | 6203 | 5849 | 5537 | 5257 | 5000 | 4792 | 4598 | 4419 | 4254 | 4103 |
| 7273 | 6839 | 6445 | 6097 | 5785 | 5500 | 5272 | 5059 | 4861 | 4679 | 4513 |
| 7959 | 7479 | 7043 | 6659 | 6315 | 6000 | 5750 | 5518 | 5302 | 5104 | 4923 |

Reference Fuel And Time Required at Check Point

| AIR DIST (NM) | PRESSURE ALTITUDE (1000 FT) | | | | | | | | | |
|---------------|-----------------------------|---------------|----------------|---------------|----------------|---------------|----------------|---------------|----------------|---------------|
| | 29 | | 31 | | 33 | | 35 | | 37 | |
| | FUEL (1000 LB) | TIME (HR:MIN) | FUEL (1000 LB) | TIME (HR:MIN) | FUEL (1000 LB) | TIME (HR:MIN) | FUEL (1000 LB) | TIME (HR:MIN) | FUEL (1000 LB) | TIME (HR:MIN) |
| 1000 | 21.2 | 2:23 | 20.5 | 2:21 | 19.8 | 2:19 | 19.3 | 2:18 | 19.1 | 2:18 |
| 1500 | 32.1 | 3:31 | 31.1 | 3:28 | 30.1 | 3:26 | 29.4 | 3:24 | 29.0 | 3:24 |
| 2000 | 42.8 | 4:41 | 41.4 | 4:36 | 40.2 | 4:33 | 39.1 | 4:30 | 38.6 | 4:29 |
| 2500 | 53.2 | 5:52 | 51.6 | 5:45 | 50.0 | 5:40 | 48.7 | 5:37 | 47.9 | 5:34 |
| 3000 | 63.4 | 7:04 | 61.5 | 6:54 | 59.7 | 6:48 | 58.1 | 6:44 | 57.1 | 6:40 |
| 3500 | 73.3 | 8:18 | 71.2 | 8:05 | 69.1 | 7:57 | 67.2 | 7:52 | 66.0 | 7:47 |
| 4000 | 83.1 | 9:33 | 80.6 | 9:18 | 78.3 | 9:07 | 76.2 | 9:00 | 74.7 | 8:54 |
| 4500 | 92.6 | 10:50 | 89.9 | 10:32 | 87.4 | 10:18 | 85.0 | 10:09 | 83.2 | 10:02 |
| 5000 | 101.9 | 12:09 | 98.9 | 11:47 | 96.2 | 11:30 | 93.6 | 11:19 | 91.6 | 11:10 |
| 5500 | 111.1 | 13:29 | 107.8 | 13:04 | 104.8 | 12:44 | 102.0 | 12:30 | 99.8 | 12:19 |
| 6000 | 120.0 | 14:51 | 116.5 | 14:23 | 113.3 | 14:00 | 110.2 | 13:42 | 107.8 | 13:29 |

Fuel Required Adjustment (1000 LB)

| REFERENCE FUEL REQUIRED (1000 LB) | WEIGHT AT CHECK POINT (1000 LB) | | | | |
|-----------------------------------|---------------------------------|-------|-----|------|------|
| | 200 | 250 | 300 | 350 | 400 |
| 10 | -1.6 | -0.8 | 0.0 | 2.8 | 5.3 |
| 20 | -3.4 | -1.8 | 0.0 | 5.6 | 11.5 |
| 30 | -5.3 | -2.7 | 0.0 | 8.2 | 17.2 |
| 40 | -7.2 | -3.7 | 0.0 | 10.5 | 22.5 |
| 50 | -9.1 | -4.7 | 0.0 | 12.6 | 27.2 |
| 60 | -11.1 | -5.6 | 0.0 | 14.5 | 31.5 |
| 70 | -13.1 | -6.6 | 0.0 | 16.2 | 35.3 |
| 80 | -15.1 | -7.5 | 0.0 | 17.6 | 38.6 |
| 90 | -17.1 | -8.5 | 0.0 | 18.8 | 41.4 |
| 100 | -19.2 | -9.4 | 0.0 | 19.8 | 43.7 |
| 110 | -21.3 | -10.4 | 0.0 | 20.6 | 45.5 |
| 120 | -23.5 | -11.3 | 0.0 | 21.1 | 46.9 |
| 130 | -25.6 | -12.3 | 0.0 | 21.4 | 47.8 |

Long Range Cruise Wind-Altitude Trade

| PRESSURE ALTITUDE (1000 FT) | CRUISE WEIGHT (1000 LB) | | | | | | | | | | | | | |
|-----------------------------|-------------------------|-----|-----|-----|-----|-----|-----|-----|-----|-----|-----|-----|-----|-----|
| | 420 | 400 | 380 | 360 | 340 | 320 | 300 | 290 | 280 | 270 | 260 | 250 | 240 | 230 |
| 43 | | | | | | | | | | 37 | 25 | 15 | 8 | 3 |
| 41 | | | | | | | 41 | 29 | 19 | 11 | 6 | 2 | 1 | 2 |
| 39 | | | | | | 29 | 13 | 7 | 4 | 2 | 1 | 2 | 5 | 8 |
| 37 | | | | 37 | 19 | 8 | 2 | 1 | 2 | 3 | 6 | 10 | 14 | 20 |
| 35 | | 41 | 23 | 11 | 4 | 1 | 3 | 5 | 8 | 12 | 16 | 22 | 28 | 34 |
| 33 | 25 | 13 | 5 | 2 | 1 | 4 | 10 | 14 | 19 | 24 | 30 | 36 | 43 | 50 |
| 31 | 6 | 2 | 1 | 3 | 7 | 14 | 22 | 27 | 33 | 39 | 45 | 51 | 58 | 65 |
| 29 | 1 | 2 | 5 | 11 | 18 | 26 | 36 | 42 | 47 | 54 | 60 | 66 | 73 | 80 |
| 27 | 5 | 9 | 15 | 22 | 31 | 40 | 51 | 57 | 62 | 68 | 75 | 81 | 87 | 94 |
| 25 | 13 | 20 | 27 | 35 | 45 | 55 | 66 | 71 | 77 | 83 | 89 | 95 | 101 | 107 |
| 23 | 25 | 32 | 41 | 50 | 59 | 69 | 80 | 85 | 90 | 96 | 102 | 107 | 113 | 119 |

The above wind factor table is for calculation of wind required to maintain present range capability at new pressure altitude, i.e., break-even wind.

Method:

1. Read wind factors for present and new altitudes from table.
2. Determine difference (new altitude wind factor minus present altitude wind factor); This difference may be negative or positive.
3. Break-even wind at new altitude is present altitude wind plus difference from step 2.

Descent at .78/290/250

| PRESSURE ALT (1000 FT) | 17 | 19 | 21 | 23 | 25 | 27 | 29 | 31 | 33 | 35 | 37 | 39 | 41 | 43 |
|------------------------|----|----|----|----|----|-----|-----|-----|-----|-----|-----|-----|-----|-----|
| DISTANCE (NM) | 66 | 72 | 79 | 86 | 93 | 100 | 107 | 114 | 119 | 125 | 130 | 136 | 141 | 146 |
| TIME (MINUTES) | 16 | 17 | 18 | 19 | 20 | 21 | 22 | 23 | 24 | 25 | 25 | 26 | 27 | 27 |

**Holding
Flaps Up**

| WEIGHT (1000 LB) | | PRESSURE ALTITUDE (FT) | | | | | | | | |
|---------------------|--------|------------------------|------|-------|-------|-------|-------|-------|-------|-------|
| | | 1500 | 5000 | 10000 | 15000 | 20000 | 25000 | 30000 | 35000 | 40000 |
| 420 | %N1 | 68.8 | 71.5 | 76.1 | 80.3 | 84.3 | 88.6 | 93.3 | | |
| | KIAS | 259 | 259 | 259 | 259 | 259 | 259 | 261 | | |
| | FF/ENG | 6500 | 6440 | 6380 | 6340 | 6340 | 6430 | 6550 | | |
| 400 | %N1 | 67.4 | 70.1 | 74.7 | 78.9 | 83.0 | 87.3 | 91.8 | | |
| | KIAS | 252 | 252 | 252 | 252 | 252 | 252 | 255 | | |
| | FF/ENG | 6200 | 6130 | 6080 | 6030 | 6010 | 6090 | 6190 | | |
| 380 | %N1 | 66.1 | 68.8 | 73.1 | 77.5 | 81.7 | 85.9 | 90.3 | 96.1 | |
| | KIAS | 246 | 246 | 246 | 246 | 246 | 246 | 248 | 263 | |
| | FF/ENG | 5900 | 5830 | 5770 | 5720 | 5700 | 5750 | 5840 | 6380 | |
| 360 | %N1 | 64.5 | 67.3 | 71.5 | 76.0 | 80.4 | 84.5 | 88.8 | 94.0 | |
| | KIAS | 239 | 239 | 239 | 239 | 239 | 239 | 241 | 244 | |
| | FF/ENG | 5610 | 5530 | 5470 | 5410 | 5380 | 5410 | 5490 | 5710 | |
| 340 | %N1 | 62.8 | 65.8 | 69.8 | 74.4 | 78.8 | 82.9 | 87.3 | 92.1 | |
| | KIAS | 231 | 231 | 231 | 231 | 231 | 231 | 233 | 236 | |
| | FF/ENG | 5320 | 5230 | 5160 | 5110 | 5070 | 5080 | 5150 | 5280 | |
| 320 | %N1 | 61.0 | 64.2 | 68.2 | 72.7 | 77.1 | 81.3 | 85.7 | 90.3 | |
| | KIAS | 225 | 225 | 225 | 225 | 225 | 225 | 226 | 229 | |
| | FF/ENG | 5040 | 4950 | 4870 | 4810 | 4770 | 4760 | 4810 | 4910 | |
| 300 | %N1 | 59.3 | 62.3 | 66.6 | 70.8 | 75.3 | 79.7 | 83.9 | 88.5 | 96.2 |
| | KIAS | 220 | 220 | 220 | 220 | 220 | 220 | 220 | 221 | 236 |
| | FF/ENG | 4760 | 4680 | 4580 | 4520 | 4480 | 4450 | 4480 | 4570 | 5190 |
| 280 | %N1 | 57.6 | 60.4 | 64.9 | 68.9 | 73.6 | 77.9 | 82.1 | 86.6 | 93.5 |
| | KIAS | 215 | 215 | 215 | 215 | 215 | 215 | 215 | 215 | 216 |
| | FF/ENG | 4490 | 4410 | 4310 | 4240 | 4190 | 4170 | 4170 | 4220 | 4510 |
| 260 | %N1 | 55.8 | 58.6 | 63.0 | 67.0 | 71.6 | 76.0 | 80.2 | 84.6 | 91.0 |
| | KIAS | 210 | 210 | 210 | 210 | 210 | 210 | 210 | 210 | 210 |
| | FF/ENG | 4230 | 4150 | 4040 | 3970 | 3920 | 3900 | 3870 | 3900 | 4090 |
| 240 | %N1 | 54.1 | 56.6 | 60.8 | 65.1 | 69.3 | 74.0 | 78.3 | 82.6 | 88.7 |
| | KIAS | 204 | 204 | 204 | 204 | 204 | 204 | 204 | 204 | 204 |
| | FF/ENG | 3960 | 3890 | 3780 | 3700 | 3650 | 3620 | 3590 | 3600 | 3740 |
| 220 | %N1 | 52.3 | 54.7 | 58.7 | 63.2 | 67.2 | 71.9 | 76.2 | 80.5 | 86.5 |
| | KIAS | 199 | 199 | 199 | 199 | 199 | 199 | 199 | 199 | 199 |
| | FF/ENG | 3700 | 3630 | 3530 | 3450 | 3380 | 3350 | 3310 | 3330 | 3420 |

This table includes 5% additional fuel for holding in a racetrack pattern.

Performance Inflight - Advisory Information

Chapter PI Section 12

ADVISORY INFORMATION

Normal Configuration Landing Distance

Flaps 25

Dry Runway

| BRAKING CONFIGURATION | LANDING DISTANCE AND ADJUSTMENT (FT) | | | | | | | | | | | |
|-----------------------|--------------------------------------|--------------------------------|-----------------------------|---------------------|-----------|------------------|---------|-------------------|---------|-------------------------|--------------------|--------|
| | REF DIST | WT ADJ | ALT ADJ | WIND ADJ PER 10 KTS | | SLOPE ADJ PER 1% | | TEMP ADJ PER 10°C | | APP SPD ADJ | REVERSE THRUST ADJ | |
| | 340000 LB LANDING WEIGHT | PER 10000 LB ABV/BLW 340000 LB | PER 1000 FT ABOVE SEA LEVEL | HEAD WIND | TAIL WIND | DOWN HILL | UP HILL | ABV ISA | BLW ISA | PER 10 KTS ABOVE VREF25 | ONE REV | NO REV |
| MAX MANUAL | 3260 | 110/-60 | 80 | -130 | 440 | 50 | -40 | 80 | -70 | 250 | 80 | 170 |
| MAX AUTO | 5490 | 130/-130 | 150 | -250 | 840 | 0 | 0 | 160 | -160 | 600 | 0 | 0 |
| AUTOBRAKE 4 | 5670 | 140/-140 | 160 | -260 | 880 | 0 | 0 | 160 | -160 | 630 | 0 | 0 |
| AUTOBRAKE 3 | 6520 | 160/-160 | 190 | -300 | 1040 | 0 | -20 | 190 | -190 | 710 | 0 | 0 |
| AUTOBRAKE 2 | 7270 | 190/-190 | 220 | -350 | 1190 | 50 | -120 | 220 | -210 | 630 | 110 | 110 |
| AUTOBRAKE 1 | 7950 | 220/-220 | 250 | -390 | 1360 | 170 | -220 | 250 | -230 | 580 | 480 | 620 |

Good Reported Braking Action

| | | | | | | | | | | | | |
|-------------|------|----------|-----|------|------|-----|------|-----|------|-----|-----|-----|
| MAX MANUAL | 4500 | 110/-100 | 120 | -210 | 720 | 120 | -110 | 120 | -110 | 340 | 260 | 580 |
| MAX AUTO | 5500 | 130/-130 | 150 | -250 | 860 | 20 | 0 | 160 | -160 | 600 | 20 | 80 |
| AUTOBRAKE 4 | 5670 | 140/-140 | 160 | -260 | 880 | 10 | 0 | 160 | -160 | 630 | 10 | 50 |
| AUTOBRAKE 3 | 6520 | 160/-160 | 190 | -300 | 1040 | 0 | -20 | 190 | -190 | 710 | 0 | 0 |

Medium Reported Braking Action

| | | | | | | | | | | | | |
|-------------|------|----------|-----|------|------|-----|------|-----|------|-----|-----|------|
| MAX MANUAL | 6190 | 170/-160 | 190 | -330 | 1190 | 300 | -230 | 180 | -170 | 440 | 690 | 1660 |
| MAX AUTO | 6210 | 170/-160 | 190 | -330 | 1190 | 260 | -160 | 190 | -170 | 570 | 600 | 1580 |
| AUTOBRAKE 4 | 6280 | 170/-160 | 190 | -330 | 1200 | 240 | -140 | 190 | -180 | 610 | 530 | 1510 |
| AUTOBRAKE 3 | 6840 | 180/-170 | 200 | -350 | 1260 | 160 | -100 | 200 | -200 | 710 | 350 | 1100 |

Poor Reported Braking Action

| | | | | | | | | | | | | |
|-------------|------|----------|-----|------|------|-----|------|-----|------|-----|------|------|
| MAX MANUAL | 8010 | 240/-230 | 260 | -480 | 1830 | 660 | -440 | 250 | -220 | 520 | 1450 | 3870 |
| MAX AUTO | 8010 | 240/-230 | 260 | -480 | 1820 | 660 | -440 | 250 | -220 | 510 | 1460 | 3890 |
| AUTOBRAKE 4 | 8010 | 240/-230 | 260 | -480 | 1820 | 670 | -430 | 250 | -220 | 520 | 1460 | 3890 |
| AUTOBRAKE 3 | 8080 | 240/-220 | 260 | -480 | 1840 | 610 | -360 | 250 | -230 | 660 | 1330 | 3760 |

Reference distance assumes sea level, standard day, no wind or slope, VREF25 approach speed and 2 engine reverse thrust.

Reference distance for manual braking is applicable for auto spoilers only, for manual spoilers operation increase landing distance by 400 ft.

Reference distance for auto braking is applicable for auto or manual spoilers.

Includes distance from 50 ft above threshold (1000 ft of air distance).

Actual (unfactored) distances are shown.

ADVISORY INFORMATION

Normal Configuration Landing Distance

Flaps 30

Dry Runway

| | LANDING DISTANCE AND ADJUSTMENT (FT) | | | | | | | | | | | |
|-----------------------|--------------------------------------|--------------------------------|---------------------------|---------------------|-----------|------------------|---------|-------------------|---------|--------------------------|--------------------|--------|
| | REF DIST | WT ADJ | ALT ADJ | WIND ADJ PER 10 KTS | | SLOPE ADJ PER 1% | | TEMP ADJ PER 10°C | | APP SPD ADJ | REVERSE THRUST ADJ | |
| BRAKING CONFIGURATION | 340000 LB LANDING WEIGHT | PER 10000 LB ABV/BLW 340000 LB | PER 1000 FT ABV SEA LEVEL | HEAD WIND | TAIL WIND | DOWN HILL | UP HILL | ABV ISA | BLW ISA | PER 10 KTS ABOVE VREF 30 | ONE REV | NO REV |
| MAX MANUAL | 3230 | 140/-70 | 80 | -130 | 440 | 50 | -40 | 80 | -70 | 250 | 80 | 160 |
| MAX AUTO | 5380 | 210/-140 | 150 | -240 | 830 | 0 | 0 | 150 | -150 | 600 | 0 | 0 |
| AUTOBRAKE 4 | 5550 | 220/-140 | 150 | -250 | 870 | 0 | 0 | 160 | -160 | 620 | 0 | 0 |
| AUTOBRAKE 3 | 6380 | 260/-170 | 180 | -300 | 1020 | 0 | -10 | 190 | -190 | 720 | 0 | 0 |
| AUTOBRAKE 2 | 7150 | 280/-200 | 210 | -340 | 1180 | 40 | -110 | 210 | -210 | 640 | 80 | 80 |
| AUTOBRAKE 1 | 7830 | 300/-220 | 240 | -390 | 1350 | 160 | -210 | 240 | -230 | 580 | 410 | 540 |

Good Reported Braking Action

| | | | | | | | | | | | | |
|-------------|------|----------|-----|------|------|-----|------|-----|------|-----|-----|-----|
| MAX MANUAL | 4470 | 160/-110 | 120 | -210 | 720 | 120 | -110 | 120 | -110 | 350 | 240 | 540 |
| MAX AUTO | 5390 | 210/-140 | 150 | -250 | 850 | 20 | 0 | 150 | -150 | 600 | 20 | 80 |
| AUTOBRAKE 4 | 5550 | 220/-140 | 150 | -250 | 870 | 10 | 0 | 160 | -160 | 620 | 10 | 50 |
| AUTOBRAKE 3 | 6380 | 260/-170 | 180 | -300 | 1020 | 0 | -10 | 190 | -190 | 720 | 0 | 0 |

Medium Reported Braking Action

| | | | | | | | | | | | | |
|-------------|------|----------|-----|------|------|-----|------|-----|------|-----|-----|------|
| MAX MANUAL | 6140 | 230/-170 | 190 | -330 | 1190 | 300 | -240 | 180 | -170 | 450 | 650 | 1540 |
| MAX AUTO | 6150 | 250/-170 | 190 | -330 | 1190 | 280 | -170 | 180 | -170 | 560 | 600 | 1500 |
| AUTOBRAKE 4 | 6210 | 250/-170 | 190 | -330 | 1200 | 260 | -150 | 190 | -180 | 600 | 540 | 1430 |
| AUTOBRAKE 3 | 6720 | 280/-180 | 200 | -350 | 1250 | 170 | -100 | 200 | -190 | 720 | 360 | 1060 |

Poor Reported Braking Action

| | | | | | | | | | | | | |
|-------------|------|----------|-----|------|------|-----|------|-----|------|-----|------|------|
| MAX MANUAL | 7970 | 310/-230 | 260 | -480 | 1830 | 680 | -440 | 250 | -220 | 520 | 1370 | 3600 |
| MAX AUTO | 7970 | 310/-230 | 260 | -480 | 1830 | 680 | -440 | 250 | -220 | 520 | 1380 | 3610 |
| AUTOBRAKE 4 | 7970 | 310/-230 | 260 | -480 | 1830 | 680 | -440 | 250 | -220 | 520 | 1380 | 3610 |
| AUTOBRAKE 3 | 8010 | 330/-230 | 260 | -480 | 1840 | 640 | -360 | 250 | -230 | 670 | 1290 | 3520 |

Reference distance assumes sea level, standard day, no wind or slope, VREF30 approach speed and 2 engine reverse thrust.

Reference distance for manual braking is applicable for auto spoilers only, for manual spoilers operation increase landing distance by 400 ft.

Reference distance for auto braking is applicable for both auto and manual spoilers.

Includes distance from 50 ft above threshold (1000 ft of air distance).

Actual (unfactored) distances are shown.

ADVISORY INFORMATION

**Non-Normal Configuration Landing Distance
 Dry Runway**

| | | LANDING DISTANCES AND ADJUSTMENTS (FT) | | | | | | | | | |
|------------------------------------|-----------|--|--------------------------------|----------------------|----------------------------|----------------------|-----------------------|---------------------|--------------------|--------|--|
| | | REF DIST | WT ADJ | ALT ADJ | WIND ADJ | SLOPE ADJ | TEMP ADJ | APP SPD ADJ | REVERSE THRUST ADJ | | |
| LANDING CONFIGURATION | VREF | 340000 LB LDG WT | PER 10000 LB ABV/BLW 340000 LB | PER 1000 FT ABV S.L. | PER 10 KTS HEAD/ TAIL WIND | PER 1% DOWN/ UP HILL | PER 10°C ABV/ BLW ISA | PER 10 KTS ABV VREF | ONE REV | NO REV | |
| AIR/GRD SYS (FLAPS 25) | VREF25 | 4290 | 80/-90 | 100 | -170/570 | 90/-80 | 110/-110 | 420 | 0 | 0 | |
| AIR/GRD SYS (FLAPS 30) | VREF30 | 4260 | 150/-90 | 100 | -170/570 | 90/-80 | 110/-110 | 440 | 0 | 0 | |
| ALL FLAPS AND SLATS UP LANDING | VREF30+50 | 4730 | 240/-100 | 130 | -170/570 | 80/-70 | 130/-120 | 320 | 200 | 440 | |
| ANTI-SKID OFF (FLAPS 25) | VREF25 | 6060 | 140/-140 | 160 | -290/1010 | 190/-160 | 160/-150 | 440 | 410 | 960 | |
| ANTI-SKID OFF (FLAPS 30) | VREF30 | 5970 | 200/-140 | 160 | -290/1010 | 190/-160 | 160/-150 | 450 | 380 | 880 | |
| ENGINE FAILURE (FLAPS 20) | VREF20 | 3530 | 130/-70 | 90 | -140/470 | 60/-50 | 90/-90 | 280 | 0 | 110 | |
| HYD SYS PRESS (C ONLY) (FLAPS 20) | VREF20 | 4220 | 100/-90 | 100 | -160/530 | 70/-60 | 100/-100 | 380 | 140 | 300 | |
| HYD SYS PRESS (L ONLY) (FLAPS 25) | VREF25 | 3420 | 80/-70 | 80 | -130/460 | 50/-50 | 80/-80 | 290 | 100 | 200 | |
| HYD SYS PRESS (L ONLY) (FLAPS 30) | VREF30 | 3400 | 110/-70 | 80 | -130/460 | 60/-50 | 80/-80 | 300 | 90 | 190 | |
| HYD SYS PRESS (R ONLY) (FLAPS 25) | VREF25 | 3760 | 80/-80 | 90 | -150/530 | 70/-60 | 90/-90 | 310 | 140 | 300 | |
| HYD SYS PRESS (R ONLY) (FLAPS 30) | VREF30 | 3740 | 130/-80 | 90 | -150/530 | 70/-70 | 90/-90 | 330 | 130 | 280 | |
| HYD SYS PRESS (L AND C) (FLAPS 20) | VREF30+20 | 5050 | 170/-100 | 130 | -180/600 | 100/-90 | 130/-130 | 510 | 230 | 510 | |
| HYD SYS PRESS (L AND R) (FLAPS 20) | VREF30+20 | 4720 | 160/-100 | 130 | -180/610 | 110/-90 | 130/-120 | 420 | 260 | 570 | |
| HYD SYS PRESS (R AND C) (FLAPS 20) | VREF30+20 | 6000 | 220/-130 | 170 | -230/780 | 160/-140 | 170/-160 | 580 | 430 | 990 | |

*Reference distance assumes sea level, standard day with no wind or slope.
 Actual (unfactored) distances are shown.
 Includes distance from 50 ft above runway threshold (1000 ft of air distance).
 Assumes max manual braking and maximum reverse thrust when available on operating engine(s).

ADVISORY INFORMATION

**Non-Normal Configuration Landing Distance
Dry Runway**

| | | LANDING DISTANCES AND ADJUSTMENTS (FT) | | | | | | | | |
|---|-----------|--|--------------------------------|----------------------|----------------------------|----------------------|-----------------------|---------------------|--------------------|--------|
| | | REF DIST | WT ADJ | ALT ADJ | WIND ADJ | SLOPE ADJ | TEMP ADJ | APP SPD ADJ | REVERSE THRUST ADJ | |
| LANDING CONFIGURATION | VREF | 340000 LB LDG WT | PER 10000 LB ABV/BLW 340000 LB | PER 1000 FT ABV S.L. | PER 10 KTS HEAD/ TAIL WIND | PER 1% DOWN/ UP HILL | PER 10°C ABV/ BLW ISA | PER 10 KTS ABV VREF | ONE REV | NO REV |
| LE SLAT ASYM (FLAPS > 20) | VREF30+20 | 3780 | 160/-80 | 90 | -140/480 | 60/-50 | 90/-90 | 270 | 120 | 260 |
| LE SLAT ASYM (FLAPS = 20) | VREF30+30 | 4260 | 150/-90 | 110 | -150/520 | 70/-60 | 110/-110 | 310 | 160 | 340 |
| LE SLAT ASYM (5 < FLAPS < 20) | VREF30+40 | 4570 | 160/-90 | 120 | -160/540 | 80/-70 | 120/-120 | 320 | 180 | 390 |
| LE SLAT DIS-AGREE (FLAPS > 20) | VREF20 | 3460 | 130/-70 | 80 | -130/450 | 50/-50 | 80/-80 | 260 | 100 | 220 |
| LE SLAT DISAGREE - ALTN FLAP EXT ACOMPLISHED (FLAPS = 20) | VREF20 | 3460 | 130/-70 | 80 | -130/450 | 50/-50 | 80/-80 | 260 | 100 | 220 |
| LE SLAT DISAGREE - ALTN FLAP EXT FAILED (FLAPS = 20) | VREF30+30 | 4050 | 170/-80 | 100 | -150/500 | 60/-60 | 100/-100 | 280 | 140 | 290 |
| REVERSER UNLOCKED (FLAPS 20) | VREF30+30 | 4380 | 160/-90 | 110 | -160/540 | 80/-70 | 120/-110 | 330 | 0 | 180 |
| TE FLAP ASYM (FLAPS ≥ 20) | VREF20 | 3460 | 130/-70 | 80 | -130/450 | 50/-50 | 80/-80 | 260 | 100 | 220 |
| TE FLAP ASYM (5 < FLAPS < 20) | VREF30+20 | 3780 | 160/-80 | 90 | -140/480 | 60/-50 | 90/-90 | 270 | 120 | 260 |
| TE FLAP ASYM (FLAPS ≤ 5) | VREF30+30 | 4000 | 190/-80 | 100 | -150/490 | 60/-50 | 100/-100 | 270 | 130 | 290 |
| TE FLAP DISAGREE (FLAPS ≥ 20) | VREF20 | 3460 | 130/-70 | 80 | -130/450 | 50/-50 | 80/-80 | 260 | 100 | 220 |
| TE FLAP DISAGREE (5 < FLAPS < 20) | VREF30+20 | 3780 | 160/-80 | 90 | -140/480 | 60/-50 | 90/-90 | 270 | 120 | 260 |
| TE FLAP DISAGREE (FLAPS ≤ 5) | VREF30+30 | 4000 | 190/-80 | 100 | -150/490 | 60/-50 | 100/-100 | 270 | 130 | 290 |

*Reference distance assumes sea level, standard day with no wind or slope.

Actual (unfactored) distances are shown.

Includes distance from 50 ft above runway threshold (1000 ft of air distance).

Assumes max manual braking and maximum reverse thrust when available on operating engine(s).

ADVISORY INFORMATION

**Non-Normal Configuration Landing Distance
 Good Reported Braking Action**

| | | LANDING DISTANCES AND ADJUSTMENTS (FT) | | | | | | | | | |
|------------------------------------|-----------|--|--------------------------------|----------------------|----------------------------|----------------------|-----------------------|---------------------|--------------------|--------|--|
| | | REF DIST | WT ADJ | ALT ADJ | WIND ADJ | SLOPE ADJ | TEMP ADJ | APP SPD ADJ | REVERSE THRUST ADJ | | |
| LANDING CONFIGURATION | VREF | 340000 LB LDG WT | PER 10000 LB ABV/BLW 340000 LB | PER 1000 FT ABV S.L. | PER 10 KTS HEAD/ TAIL WIND | PER 1% DOWN/ UP HILL | PER 10°C ABV/ BLW ISA | PER 10 KTS ABV VREF | ONE REV | NO REV | |
| AIR/GRD SYS (FLAPS 25) | VREF25 | 6360 | 140/-140 | 180 | -300/1010 | 270/-220 | 180/-180 | 620 | 0 | 0 | |
| AIR/GRD SYS (FLAPS 30) | VREF30 | 6300 | 230/-140 | 180 | -300/1010 | 280/-230 | 180/-180 | 640 | 0 | 0 | |
| ALL FLAPS AND SLATS UP LANDING | VREF30+50 | 6400 | 200/-140 | 190 | -250/860 | 160/-150 | 190/-180 | 380 | 530 | 1220 | |
| ANTI-SKID OFF (FLAPS 25) | VREF25 | 6820 | 170/-170 | 190 | -350/1240 | 290/-230 | 190/-180 | 490 | 630 | 1530 | |
| ANTI-SKID OFF (FLAPS 30) | VREF30 | 6720 | 240/-170 | 190 | -350/1240 | 290/-230 | 190/-180 | 490 | 590 | 1410 | |
| ENGINE FAILURE (FLAPS 20) | VREF20 | 5100 | 140/-120 | 140 | -230/800 | 160/-140 | 140/-140 | 410 | 0 | 410 | |
| HYD SYS PRESS (C ONLY) (FLAPS 20) | VREF20 | 5730 | 160/-140 | 160 | -250/840 | 170/-150 | 160/-150 | 510 | 430 | 1010 | |
| HYD SYS PRESS (L ONLY) (FLAPS 25) | VREF25 | 4730 | 110/-110 | 130 | -220/750 | 140/-120 | 130/-120 | 390 | 300 | 680 | |
| HYD SYS PRESS (L ONLY) (FLAPS 30) | VREF30 | 4710 | 170/-110 | 130 | -220/750 | 140/-120 | 130/-120 | 400 | 280 | 640 | |
| HYD SYS PRESS (R ONLY) (FLAPS 25) | VREF25 | 4730 | 110/-110 | 130 | -220/750 | 140/-120 | 130/-120 | 390 | 300 | 680 | |
| HYD SYS PRESS (R ONLY) (FLAPS 30) | VREF30 | 4710 | 170/-110 | 130 | -220/750 | 140/-120 | 130/-120 | 400 | 280 | 640 | |
| HYD SYS PRESS (L AND C) (FLAPS 20) | VREF30+20 | 6810 | 250/-160 | 200 | -280/940 | 230/-190 | 200/-190 | 640 | 650 | 1560 | |
| HYD SYS PRESS (L AND R) (FLAPS 20) | VREF30+20 | 5960 | 220/-140 | 180 | -250/860 | 190/-170 | 180/-170 | 510 | 530 | 1250 | |
| HYD SYS PRESS (R AND C) (FLAPS 20) | VREF30+20 | 6810 | 250/-160 | 200 | -280/940 | 230/-190 | 200/-190 | 640 | 650 | 1560 | |

*Reference distance assumes sea level, standard day with no wind or slope.
 Actual (unfactored) distances are shown.
 Includes distance from 50 ft above runway threshold (1000 ft of air distance).
 Assumes max manual braking and maximum reverse thrust when available on operating engine(s).

ADVISORY INFORMATION

Non-Normal Configuration Landing Distance

Good Reported Braking Action

| | | LANDING DISTANCES AND ADJUSTMENTS (FT) | | | | | | | | |
|---|-----------|--|--------------------------------|----------------------|----------------------------|----------------------|-----------------------|---------------------|--------------------|--------|
| | | REF DIST | WT ADJ | ALT ADJ | WIND ADJ | SLOPE ADJ | TEMP ADJ | APP SPD ADJ | REVERSE THRUST ADJ | |
| LANDING CONFIGURATION | VREF | 340000 LB LDG WT | PER 10000 LB ABV/BLW 340000 LB | PER 1000 FT ABV S.L. | PER 10 KTS HEAD/ TAIL WIND | PER 1% DOWN/ UP HILL | PER 10°C ABV/ BLW ISA | PER 10 KTS ABV VREF | ONE REV | NO REV |
| LE SLAT ASYM (FLAPS > 20) | VREF30+20 | 5290 | 180/-120 | 150 | -230/790 | 150/-130 | 150/-140 | 380 | 380 | 860 |
| LE SLAT ASYM (FLAPS = 20) | VREF30+30 | 5950 | 200/-140 | 170 | -250/840 | 170/-150 | 170/-170 | 420 | 470 | 1080 |
| LE SLAT ASYM (5 < FLAPS < 20) | VREF30+40 | 6380 | 210/-150 | 190 | -260/870 | 180/-160 | 190/-180 | 430 | 520 | 1190 |
| LE SLAT DIS-AGREE (FLAPS > 20) | VREF20 | 4830 | 130/-110 | 130 | -220/750 | 130/-120 | 130/-130 | 370 | 330 | 750 |
| LE SLAT DISAGREE - ALTN FLAP EXT ACOMPLISHED (FLAPS = 20) | VREF20 | 4830 | 130/-110 | 130 | -220/750 | 130/-120 | 130/-130 | 370 | 330 | 750 |
| LE SLAT DISAGREE - ALTN FLAP EXT FAILED (FLAPS = 20) | VREF30+30 | 5670 | 180/-130 | 160 | -240/810 | 150/-140 | 160/-160 | 380 | 420 | 950 |
| REVERSER UNLOCKED (FLAPS 20) | VREF30+30 | 6350 | 210/-150 | 180 | -270/900 | 210/-180 | 190/-180 | 470 | 0 | 590 |
| TE FLAP ASYM (FLAPS ≥ 20) | VREF20 | 4830 | 130/-110 | 130 | -220/750 | 130/-120 | 130/-130 | 370 | 330 | 750 |
| TE FLAP ASYM (5 < FLAPS < 20) | VREF30+20 | 5310 | 180/-120 | 150 | -230/790 | 140/-130 | 150/-140 | 380 | 380 | 880 |
| TE FLAP ASYM (FLAPS ≤ 5) | VREF30+30 | 5640 | 180/-130 | 160 | -230/810 | 150/-130 | 160/-150 | 370 | 430 | 980 |
| TE FLAP DISAGREE (FLAPS ≥ 20) | VREF20 | 4830 | 130/-110 | 130 | -220/750 | 130/-120 | 130/-130 | 370 | 330 | 750 |
| TE FLAP DISAGREE (5 < FLAPS < 20) | VREF30+20 | 5310 | 180/-120 | 150 | -230/790 | 140/-130 | 150/-140 | 380 | 380 | 880 |
| TE FLAP DISAGREE (FLAPS ≤ 5) | VREF30+30 | 5640 | 180/-130 | 160 | -230/810 | 150/-130 | 160/-150 | 370 | 430 | 980 |

*Reference distance assumes sea level, standard day with no wind or slope.

Actual (unfactored) distances are shown.

Includes distance from 50 ft above runway threshold (1000 ft of air distance).

Assumes max manual braking and maximum reverse thrust when available on operating engine(s).

ADVISORY INFORMATION

**Non-Normal Configuration Landing Distance
 Medium Reported Braking Action**

| LANDING CONFIGURATION | VREF | LANDING DISTANCES AND ADJUSTMENTS (FT) | | | | | | | | |
|------------------------------------|-----------|--|--------------------------------|---------------------|----------------------------|----------------------|-----------------------|---------------------|--------------------|--------|
| | | REF DIST | WT ADJ | ALT ADJ | WIND ADJ | SLOPE ADJ | TEMP ADJ | APP SPD ADJ | REVERSE THRUST ADJ | |
| | | 340000 LB LDG WT | PER 10000 LB ABV/BLW 340000 LB | PER 1000FT ABV S.L. | PER 10 KTS HEAD/ TAIL WIND | PER 1% DOWN/ UP HILL | PER 10°C ABV/ BLW ISA | PER 10 KTS ABV VREF | ONE REV | NO REV |
| AIR/GRD SYS (FLAPS 25) | VREF25 | 10140 | 210/-210 | 310 | -560/1950 | 1000/-670 | 320/-320 | 870 | 0 | 0 |
| AIR/GRD SYS (FLAPS 30) | VREF30 | 9970 | 340/-210 | 310 | -550/1940 | 1000/-670 | 320/-320 | 870 | 0 | 0 |
| ALL FLAPS AND SLATS UP LANDING | VREF30+50 | 9110 | 310/-230 | 300 | -400/1400 | 410/-330 | 300/-270 | 520 | 1430 | 3670 |
| ANTI-SKID OFF (FLAPS 25) | VREF25 | 8580 | 240/-230 | 260 | -500/1870 | 640/-440 | 250/-230 | 560 | 1370 | 3680 |
| ANTI-SKID OFF (FLAPS 30) | VREF30 | 8480 | 320/-230 | 260 | -500/1870 | 650/-440 | 250/-230 | 560 | 1290 | 3390 |
| ENGINE FAILURE (FLAPS 20) | VREF20 | 7440 | 220/-200 | 230 | -390/1360 | 440/-340 | 230/-220 | 560 | 0 | 1250 |
| HYD SYS PRESS (C ONLY) (FLAPS 20) | VREF20 | 7720 | 240/-210 | 240 | -380/1340 | 400/-310 | 240/-220 | 630 | 1120 | 2890 |
| HYD SYS PRESS (L ONLY) (FLAPS 25) | VREF25 | 6480 | 180/-170 | 200 | -340/1220 | 330/-260 | 200/-180 | 490 | 780 | 1900 |
| HYD SYS PRESS (L ONLY) (FLAPS 30) | VREF30 | 6450 | 250/-170 | 200 | -340/1220 | 340/-260 | 200/-180 | 500 | 740 | 1780 |
| HYD SYS PRESS (R ONLY) (FLAPS 25) | VREF25 | 6480 | 180/-170 | 200 | -340/1220 | 330/-260 | 200/-180 | 490 | 780 | 1900 |
| HYD SYS PRESS (R ONLY) (FLAPS 30) | VREF30 | 6450 | 250/-170 | 200 | -340/1220 | 340/-260 | 200/-180 | 500 | 740 | 1780 |
| HYD SYS PRESS (L AND C) (FLAPS 20) | VREF30+20 | 9040 | 350/-240 | 290 | -420/1460 | 500/-390 | 290/-260 | 740 | 1530 | 4090 |
| HYD SYS PRESS (L AND R) (FLAPS 20) | VREF30+20 | 8140 | 310/-220 | 270 | -390/1370 | 430/-340 | 260/-240 | 620 | 1300 | 3370 |
| HYD SYS PRESS (R AND C) (FLAPS 20) | VREF30+20 | 9040 | 350/-240 | 290 | -420/1460 | 500/-390 | 290/-260 | 740 | 1530 | 4090 |

*Reference distance assumes sea level, standard day with no wind or slope.

Actual (unfactored) distances are shown.

Includes distance from 50 ft above runway threshold (1000 ft of air distance).

Assumes max manual braking and maximum reverse thrust when available on operating engine(s).

ADVISORY INFORMATION

Non-Normal Configuration Landing Distance

Medium Reported Braking Action

| | | LANDING DISTANCES AND ADJUSTMENTS (FT) | | | | | | | | |
|---|-----------|--|--------------------------------|----------------------|----------------------------|----------------------|-----------------------|---------------------|--------------------|--------|
| | | REF DIST | WT ADJ | ALT ADJ | WIND ADJ | SLOPE ADJ | TEMP ADJ | APP SPD ADJ | REVERSE THRUST ADJ | |
| LANDING CONFIGURATION | VREF | 340000 LB LDG WT | PER 10000 LB ABV/BLW 340000 LB | PER 1000 FT ABV S.L. | PER 10 KTS HEAD/ TAIL WIND | PER 1% DOWN/ UP HILL | PER 10°C ABV/ BLW ISA | PER 10 KTS ABV VREF | ONE REV | NO REV |
| LE SLAT ASYM (FLAPS > 20) | VREF30+20 | 7310 | 270/-190 | 230 | -360/1280 | 350/-280 | 230/-210 | 490 | 980 | 2430 |
| LE SLAT ASYM (FLAPS = 20) | VREF30+30 | 8170 | 290/-210 | 260 | -380/1350 | 390/-320 | 260/-240 | 530 | 1170 | 2930 |
| LE SLAT ASYM (5 < FLAPS < 20) | VREF30+40 | 8720 | 300/-220 | 290 | -400/1380 | 410/-330 | 280/-260 | 540 | 1340 | 3430 |
| LE SLAT DIS-AGREE (FLAPS > 20) | VREF20 | 6710 | 200/-180 | 210 | -340/1230 | 330/-260 | 200/-190 | 490 | 880 | 2200 |
| LE SLAT DISAGREE - ALTN FLAP EXT ACOMPLISHED (FLAPS = 20) | VREF20 | 6710 | 200/-180 | 210 | -340/1230 | 330/-260 | 200/-190 | 490 | 880 | 2200 |
| LE SLAT DISAGREE - ALTN FLAP EXT FAILED (FLAPS = 20) | VREF30+30 | 7800 | 270/-200 | 250 | -370/1310 | 360/-290 | 250/-230 | 490 | 1050 | 2620 |
| REVERSER UNLOCKED (FLAPS 20) | VREF30+30 | 9160 | 320/-230 | 290 | -430/1510 | 530/-420 | 290/-280 | 610 | 0 | 1680 |
| TE FLAP ASYM (FLAPS ≥ 20) | VREF20 | 6710 | 200/-180 | 210 | -340/1230 | 330/-260 | 200/-190 | 490 | 880 | 2200 |
| TE FLAP ASYM (5 < FLAPS < 20) | VREF30+20 | 7370 | 270/-190 | 230 | -360/1280 | 350/-280 | 230/-210 | 490 | 1010 | 2540 |
| TE FLAP ASYM (FLAPS ≤ 5) | VREF30+30 | 7850 | 280/-200 | 250 | -370/1310 | 360/-290 | 250/-230 | 490 | 1110 | 2810 |
| TE FLAP DISAGREE (FLAPS ≥ 20) | VREF20 | 6710 | 200/-180 | 210 | -340/1230 | 330/-260 | 200/-190 | 490 | 880 | 2200 |
| TE FLAP DISAGREE (5 < FLAPS < 20) | VREF30+20 | 7370 | 270/-190 | 230 | -360/1280 | 350/-280 | 230/-210 | 490 | 1010 | 2540 |
| TE FLAP DISAGREE (FLAPS ≤ 5) | VREF30+30 | 7850 | 280/-200 | 250 | -370/1310 | 360/-290 | 250/-230 | 490 | 1110 | 2810 |

*Reference distance assumes sea level, standard day with no wind or slope.

Actual (unfactored) distances are shown.

Includes distance from 50 ft above runway threshold (1000 ft of air distance).

Assumes max manual braking and maximum reverse thrust when available on operating engine(s).

ADVISORY INFORMATION

**Non-Normal Configuration Landing Distance
 Poor Reported Braking Action**

| | | LANDING DISTANCES AND ADJUSTMENTS (FT) | | | | | | | | | |
|--|-----------|--|--|----------------------------------|------------------------------------|-------------------------------|--------------------------------|---------------------------------|--------------------------|-----------|--|
| | | REF DIST | WT ADJ | ALT ADJ | WIND ADJ | SLOPE ADJ | TEMP ADJ | APP SPD ADJ | REVERSE THRUST ADJ | | |
| LANDING CONFIGURATION | VREF | 340000 LB LDG WT | PER 10000 LB ABV/ BLW 340000 LB | PER 1000 FT ABV S.L. | PER 10KTS HEAD/ TAIL WIND | PER 1% DOWN/ UP HILL | PER 10°C ABV/ BLW ISA | PER 10 KTS ABV VREF | ONE REV | NO REV | |
| AIR/GRD SYS (FLAPS 25) | VREF25 | 16740 | 290/-180 | 570 | -1120/4230 | 6080/-2020 | 600/-590 | 1090 | 0 | 0 | |
| AIR/GRD SYS (FLAPS 30) | VREF30 | 16320 | 440/-180 | 550 | -1100/4180 | 5960/-1970 | 580/-570 | 1080 | 0 | 0 | |
| ALL FLAPS AND SLATS UP LANDING | VREF30+50 | 12000 | 440/-330 | 430 | -590/2140 | 900/-630 | 410/-370 | 640 | 3020 | 8970 | |
| ANTI-SKID OFF (FLAPS 25) | VREF25 | 11270 | 350/-330 | 370 | -800/3310 | 3040/-940 | 350/-310 | 630 | 3540 | 14250 | |
| ANTI-SKID OFF (FLAPS 30) | VREF30 | 11160 | 440/-330 | 360 | -800/3310 | 3040/-950 | 350/-310 | 630 | 3380 | 13380 | |
| ENGINE FAILURE (FLAPS 20) | VREF20 | 10240 | 330/-290 | 340 | -600/2200 | 1100/-700 | 330/-310 | 690 | 0 | 3070 | |
| HYD SYS PRESS (C ONLY) (FLAPS 20) | VREF20 | 9840 | 330/-290 | 330 | -550/2030 | 840/-570 | 320/-290 | 710 | 2280 | 6740 | |
| HYD SYS PRESS (L ONLY) (FLAPS 25) | VREF25 | 8360 | 250/-240 | 280 | -500/1870 | 710/-480 | 270/-240 | 560 | 1610 | 4380 | |
| HYD SYS PRESS (L ONLY) (FLAPS 30) | VREF30 | 8340 | 340/-240 | 280 | -500/1870 | 730/-490 | 270/-240 | 570 | 1530 | 4080 | |
| HYD SYS PRESS (R ONLY) (FLAPS 25) | VREF25 | 8360 | 250/-240 | 280 | -500/1870 | 710/-480 | 270/-240 | 560 | 1610 | 4380 | |
| HYD SYS PRESS (R ONLY) (FLAPS 30) | VREF30 | 8340 | 340/-240 | 280 | -500/1870 | 730/-490 | 270/-240 | 570 | 1530 | 4080 | |
| HYD SYS PRESS (L AND C) (FLAPS 20) | VREF30+20 | 11330 | 460/-320 | 400 | -600/2160 | 990/-670 | 380/-340 | 800 | 2910 | 8920 | |
| HYD SYS PRESS (L AND R) (FLAPS 20) | VREF30+20 | 10390 | 420/-300 | 360 | -560/2060 | 890/-610 | 350/-310 | 690 | 2540 | 7490 | |
| HYD SYS PRESS (R AND C) (FLAPS 20) | VREF30+20 | 11330 | 460/-320 | 400 | -600/2160 | 990/-670 | 380/-340 | 800 | 2910 | 8920 | |

*Reference distance assumes sea level, standard day with no wind or slope.
 Actual (unfactored) distances are shown.
 Includes distance from 50 ft above runway threshold (1000 ft of air distance).
 Assumes max manual braking and maximum reverse thrust when available on operating engine(s).

ADVISORY INFORMATION

Non-Normal Configuration Landing Distance

Poor Reported Braking Action

| | | LANDING DISTANCES AND ADJUSTMENTS (FT) | | | | | | | | |
|---|-----------|--|--------------------------------|----------------------|----------------------------|----------------------|-----------------------|---------------------|--------------------|--------|
| | | REF DIST | WT ADJ | ALT ADJ | WIND ADJ | SLOPE ADJ | TEMP ADJ | APP SPD ADJ | REVERSE THRUST ADJ | |
| LANDING CONFIGURATION | VREF | 340000 LB LDG WT | PER 10000 LB ABV/BLW 340000 LB | PER 1000 FT ABV S.L. | PER 10 KTS HEAD/ TAIL WIND | PER 1% DOWN/ UP HILL | PER 10°C ABV/ BLW ISA | PER 10 KTS ABV VREF | ONE REV | NO REV |
| LE SLAT ASYM (FLAPS > 20) | VREF30+20 | 9460 | 360/-270 | 320 | -530/1950 | 760/-520 | 310/-280 | 570 | 2010 | 5610 |
| LE SLAT ASYM (FLAPS = 20) | VREF30+30 | 10460 | 390/-290 | 360 | -560/2040 | 820/-570 | 350/-320 | 600 | 2310 | 6530 |
| LE SLAT ASYM (5 < FLAPS < 20) | VREF30+40 | 11270 | 420/-310 | 400 | -570/2100 | 870/-610 | 380/-340 | 630 | 2700 | 7890 |
| LE SLAT DIS-AGREE (FLAPS > 20) | VREF20 | 8750 | 290/-250 | 290 | -510/1900 | 730/-500 | 280/-260 | 580 | 1860 | 5230 |
| LE SLAT DISAGREE - ALTN FLAP EXT ACOMPLISHED (FLAPS = 20) | VREF20 | 8750 | 290/-250 | 290 | -510/1900 | 730/-500 | 280/-260 | 580 | 1860 | 5230 |
| LE SLAT DISAGREE - ALTN FLAP EXT FAILED (FLAPS = 20) | VREF30+30 | 10020 | 370/-280 | 340 | -540/1990 | 780/-540 | 330/-300 | 560 | 2120 | 5910 |
| REVERSER UNLOCKED (FLAPS 20) | VREF30+30 | 12380 | 450/-340 | 420 | -660/2380 | 1260/-830 | 410/-390 | 730 | 0 | 3880 |
| TE FLAP ASYM (FLAPS ≥ 20) | VREF20 | 8750 | 290/-250 | 290 | -510/1900 | 730/-500 | 280/-260 | 580 | 1860 | 5230 |
| TE FLAP ASYM (5 < FLAPS < 20) | VREF30+20 | 9590 | 370/-270 | 330 | -530/1960 | 760/-520 | 320/-280 | 590 | 2160 | 6210 |
| TE FLAP ASYM (FLAPS ≤ 5) | VREF30+30 | 10170 | 380/-280 | 350 | -540/2000 | 780/-540 | 340/-300 | 580 | 2290 | 6540 |
| TE FLAP DISAGREE (FLAPS ≥ 20) | VREF20 | 8750 | 290/-250 | 290 | -510/1900 | 730/-500 | 280/-260 | 580 | 1860 | 5230 |
| TE FLAP DISAGREE (5 < FLAPS < 20) | VREF30+20 | 9590 | 370/-270 | 330 | -530/1960 | 760/-520 | 320/-280 | 590 | 2160 | 6210 |
| TE FLAP DISAGREE (FLAPS ≤ 5) | VREF30+30 | 10170 | 380/-280 | 350 | -540/2000 | 780/-540 | 340/-300 | 580 | 2290 | 6540 |

*Reference distance assumes sea level, standard day with no wind or slope.

Actual (unfactored) distances are shown.

Includes distance from 50 ft above runway threshold (1000 ft of air distance).

Assumes max manual braking and maximum reverse thrust when available on operating engine(s).

ADVISORY INFORMATION

**Recommended Brake Cooling Schedule
 Reference Brake Energy Per Brake (Millions of Foot Pounds)**

| WEIGHT (1000 LB) | | OAT °F °C | | BRAKES ON SPEED (KIAS)* | | | | | | | | | | | | | | | | | |
|---------------------|-----|--------------|------|-----------------------------|------|------|------|------|------|------|------|------|------|------|------|------|------|------|------|------|--|
| | | | | 80 | | | 100 | | | 120 | | | 140 | | | 160 | | | 180 | | |
| | | | | PRESSURE ALTITUDE (1000 FT) | | | | | | | | | | | | | | | | | |
| | | 0 | 2 | 4 | 0 | 2 | 4 | 0 | 2 | 4 | 0 | 2 | 4 | 0 | 2 | 4 | 0 | 2 | 4 | | |
| 420 | 40 | 4 | 16.2 | 17.2 | 18.2 | 24.4 | 26.0 | 27.5 | 34.0 | 36.2 | 38.5 | 44.7 | 47.7 | 50.7 | 56.4 | 60.2 | 64.1 | | | | |
| | 60 | 16 | 16.8 | 17.8 | 18.8 | 25.3 | 26.9 | 28.6 | 35.2 | 37.6 | 39.9 | 46.4 | 49.5 | 52.7 | 58.5 | 62.6 | 66.6 | | | | |
| | 80 | 27 | 17.4 | 18.4 | 19.5 | 26.2 | 27.9 | 29.6 | 36.5 | 39.0 | 41.4 | 48.1 | 51.4 | 54.6 | 60.7 | 64.9 | 69.1 | | | | |
| | 100 | 38 | 17.8 | 18.9 | 20.0 | 26.9 | 28.6 | 30.4 | 37.5 | 40.0 | 42.5 | 49.4 | 52.8 | 56.2 | 62.5 | 66.8 | 71.2 | | | | |
| | 120 | 49 | 18.0 | 19.2 | 20.3 | 27.4 | 29.2 | 31.0 | 38.3 | 40.9 | 43.5 | 50.6 | 54.1 | 57.6 | 64.1 | 68.6 | 73.0 | | | | |
| 380 | 40 | 4 | 14.8 | 15.7 | 16.6 | 22.3 | 23.7 | 25.2 | 31.0 | 33.0 | 35.1 | 40.8 | 43.5 | 46.2 | 51.4 | 54.9 | 58.5 | | | | |
| | 60 | 16 | 15.4 | 16.3 | 17.2 | 23.1 | 24.6 | 26.1 | 32.2 | 34.3 | 36.4 | 42.3 | 45.2 | 48.0 | 53.4 | 57.0 | 60.7 | | | | |
| | 80 | 27 | 15.9 | 16.9 | 17.9 | 24.0 | 25.5 | 27.0 | 33.4 | 35.6 | 37.8 | 43.9 | 46.8 | 49.8 | 55.4 | 59.2 | 63.0 | | | | |
| | 100 | 38 | 16.3 | 17.3 | 18.3 | 24.6 | 26.2 | 27.7 | 34.2 | 36.5 | 38.8 | 45.1 | 48.1 | 51.2 | 57.0 | 60.9 | 64.8 | | | | |
| | 120 | 49 | 16.5 | 17.5 | 18.6 | 25.0 | 26.6 | 28.3 | 34.9 | 37.3 | 39.6 | 46.1 | 49.3 | 52.4 | 58.4 | 62.4 | 66.5 | | | | |
| 340 | 40 | 4 | 13.5 | 14.3 | 15.1 | 20.2 | 21.5 | 22.8 | 28.0 | 29.9 | 31.7 | 36.8 | 39.2 | 41.7 | 46.3 | 49.4 | 52.6 | 56.5 | 60.4 | 64.3 | |
| | 60 | 16 | 14.0 | 14.8 | 15.7 | 21.0 | 22.3 | 23.6 | 29.1 | 31.0 | 32.9 | 38.2 | 40.7 | 43.3 | 48.1 | 51.3 | 54.6 | 58.7 | 62.7 | 66.8 | |
| | 80 | 27 | 14.5 | 15.3 | 16.2 | 21.7 | 23.1 | 24.5 | 30.2 | 32.1 | 34.1 | 39.6 | 42.2 | 44.9 | 49.8 | 53.2 | 56.6 | 60.8 | 65.0 | 69.3 | |
| | 100 | 38 | 14.8 | 15.7 | 16.6 | 22.3 | 23.7 | 25.1 | 30.9 | 33.0 | 35.0 | 40.7 | 43.4 | 46.1 | 51.3 | 54.8 | 58.3 | 62.6 | 67.0 | 71.3 | |
| | 120 | 49 | 15.0 | 15.9 | 16.8 | 22.6 | 24.1 | 25.6 | 31.5 | 33.6 | 35.7 | 41.5 | 44.4 | 47.2 | 52.5 | 56.1 | 59.7 | 64.2 | 68.7 | 73.2 | |
| 300 | 40 | 4 | 12.1 | 12.9 | 13.6 | 18.1 | 19.3 | 20.4 | 25.0 | 26.6 | 28.3 | 32.7 | 34.9 | 37.0 | 41.0 | 43.8 | 46.6 | 49.9 | 53.4 | 56.8 | |
| | 60 | 16 | 12.6 | 13.3 | 14.1 | 18.8 | 20.0 | 21.2 | 26.0 | 27.6 | 29.3 | 33.9 | 36.2 | 38.4 | 42.6 | 45.5 | 48.4 | 51.9 | 55.4 | 59.0 | |
| | 80 | 27 | 13.0 | 13.8 | 14.6 | 19.5 | 20.7 | 21.9 | 26.9 | 28.7 | 30.4 | 35.2 | 37.5 | 39.8 | 44.2 | 47.2 | 50.1 | 53.8 | 57.5 | 61.1 | |
| | 100 | 38 | 13.3 | 14.1 | 14.9 | 19.9 | 21.2 | 22.5 | 27.6 | 29.4 | 31.2 | 36.1 | 38.5 | 40.9 | 45.4 | 48.5 | 51.6 | 55.3 | 59.1 | 63.0 | |
| | 120 | 49 | 13.5 | 14.3 | 15.1 | 20.3 | 21.6 | 22.9 | 28.1 | 30.0 | 31.8 | 36.9 | 39.4 | 41.8 | 46.4 | 49.6 | 52.8 | 56.7 | 60.6 | 64.6 | |
| 260 | 40 | 4 | 10.8 | 11.5 | 12.1 | 16.0 | 17.0 | 18.0 | 22.0 | 23.4 | 24.8 | 28.6 | 30.4 | 32.3 | 35.6 | 38.0 | 40.4 | 43.2 | 46.1 | 49.0 | |
| | 60 | 16 | 11.2 | 11.9 | 12.6 | 16.6 | 17.7 | 18.7 | 22.8 | 24.3 | 25.7 | 29.6 | 31.6 | 33.5 | 37.0 | 39.5 | 41.9 | 44.8 | 47.8 | 50.9 | |
| | 80 | 27 | 11.6 | 12.3 | 13.0 | 17.2 | 18.3 | 19.4 | 23.6 | 25.2 | 26.7 | 30.7 | 32.7 | 34.7 | 38.3 | 40.9 | 43.5 | 46.5 | 49.6 | 52.8 | |
| | 100 | 38 | 11.9 | 12.6 | 13.3 | 17.6 | 18.7 | 19.8 | 24.2 | 25.8 | 27.3 | 31.5 | 33.6 | 35.6 | 39.4 | 42.0 | 44.7 | 47.8 | 51.0 | 54.3 | |
| | 120 | 49 | 12.0 | 12.7 | 13.5 | 17.9 | 19.0 | 20.2 | 24.7 | 26.3 | 27.9 | 32.1 | 34.3 | 36.4 | 40.2 | 43.0 | 45.7 | 48.9 | 52.2 | 55.6 | |
| 220 | 40 | 4 | 9.6 | 10.1 | 10.7 | 14.0 | 14.8 | 15.7 | 18.9 | 20.1 | 21.3 | 24.3 | 25.9 | 27.4 | 30.1 | 32.1 | 34.0 | 36.1 | 38.6 | 41.0 | |
| | 60 | 16 | 9.9 | 10.5 | 11.1 | 14.5 | 15.4 | 16.3 | 19.6 | 20.9 | 22.1 | 25.2 | 26.9 | 28.5 | 31.2 | 33.3 | 35.3 | 37.5 | 40.0 | 42.5 | |
| | 80 | 27 | 10.3 | 10.9 | 11.5 | 15.0 | 15.9 | 16.8 | 20.3 | 21.6 | 22.9 | 26.2 | 27.8 | 29.5 | 32.4 | 34.5 | 36.6 | 38.9 | 41.5 | 44.1 | |
| | 100 | 38 | 10.5 | 11.1 | 11.7 | 15.3 | 16.3 | 17.2 | 20.8 | 22.1 | 23.5 | 26.8 | 28.5 | 30.3 | 33.2 | 35.4 | 37.6 | 40.0 | 42.6 | 45.3 | |
| | 120 | 49 | 10.6 | 11.2 | 11.8 | 15.6 | 16.5 | 17.5 | 21.2 | 22.5 | 23.9 | 27.3 | 29.1 | 30.9 | 33.9 | 36.1 | 38.4 | 40.8 | 43.6 | 46.3 | |

*To correct for wind, enter table with the brakes on speed minus one half the headwind or plus 1.5 times the tailwind.

If ground speed is used for brakes on speed, ignore wind, altitude, and OAT effects.

**Adjusted Brake Energy Per Brake (Millions of Foot Pounds)
 No Reverse Thrust**

| EVENT | | REFERENCE BRAKE ENERGY PER BRAKE (MILLIONS OF FOOT POUNDS) | | | | | | | | | | | |
|-------------|-------------|--|------|------|------|------|------|------|------|------|------|------|------|
| | | 5 | 10 | 15 | 20 | 25 | 30 | 35 | 40 | 45 | 50 | 55 | 60 |
| LANDING | RTO MAX MAN | 5.0 | 10.0 | 15.0 | 20.0 | 25.0 | 30.0 | 35.0 | 40.0 | 45.0 | 50.0 | 55.0 | 60.0 |
| | MAX MAN | 1.0 | 6.1 | 11.2 | 16.1 | 21.0 | 25.8 | 30.5 | 35.2 | 39.8 | 44.5 | 49.1 | 53.8 |
| | MAX AUTO | 1.7 | 6.1 | 10.4 | 14.7 | 18.9 | 23.1 | 27.3 | 31.5 | 35.8 | 40.0 | 44.3 | 48.7 |
| | AUTOBRAKE 4 | 1.9 | 6.0 | 10.1 | 14.1 | 18.1 | 22.0 | 26.0 | 29.9 | 33.8 | 37.8 | 41.8 | 45.8 |
| | AUTOBRAKE 3 | 1.8 | 5.7 | 9.5 | 13.2 | 17.0 | 20.7 | 24.3 | 28.0 | 31.6 | 35.3 | 39.0 | 42.8 |
| | AUTOBRAKE 2 | 1.7 | 5.4 | 9.0 | 12.5 | 15.9 | 19.3 | 22.7 | 26.1 | 29.4 | 32.8 | 36.2 | 39.7 |
| AUTOBRAKE 1 | 1.7 | 5.0 | 8.2 | 11.3 | 14.4 | 17.4 | 20.3 | 23.3 | 26.2 | 29.1 | 32.1 | 35.0 | |

ADVISORY INFORMATION

**Recommended Brake Cooling Schedule
Two Engines Reverse Thrust**

| EVENT | | REFERENCE BRAKE ENERGY PER BRAKE (MILLIONS OF FOOT POUNDS) | | | | | | | | | | | |
|---------|-------------|--|-----|-----|------|------|------|------|------|------|------|------|------|
| | | 5 | 10 | 15 | 20 | 25 | 30 | 35 | 40 | 45 | 50 | 55 | 60 |
| LANDING | MAX MAN | 0.0 | 5.0 | 9.9 | 14.6 | 19.2 | 23.8 | 28.2 | 32.6 | 37.0 | 41.3 | 45.6 | 49.9 |
| | MAX AUTO | 0.2 | 3.7 | 7.3 | 10.8 | 14.3 | 17.9 | 21.5 | 25.1 | 28.7 | 32.4 | 36.2 | 40.0 |
| | AUTOBRAKE 4 | 0.0 | 2.9 | 6.0 | 9.0 | 12.1 | 15.1 | 18.2 | 21.3 | 24.5 | 27.7 | 30.9 | 34.2 |
| | AUTOBRAKE 3 | 0.0 | 1.8 | 4.3 | 6.9 | 9.5 | 12.1 | 14.8 | 17.4 | 20.1 | 23.9 | 25.7 | 28.6 |
| | AUTOBRAKE 2 | 0.0 | 0.7 | 2.8 | 4.8 | 6.9 | 8.9 | 11.0 | 13.1 | 15.3 | 17.6 | 19.9 | 22.2 |
| | AUTOBRAKE 1 | 0.0 | 0.4 | 1.8 | 3.2 | 4.6 | 6.0 | 7.5 | 9.0 | 10.5 | 12.1 | 13.8 | 15.5 |

**Cooling Time (Minutes)
Category "C" and "D" Brakes**

| | | ADJUSTED BRAKE ENERGY PER BRAKE (MILLIONS OF FOOT POUNDS) | | | | | | | | | | | | | | |
|-----------------------|-------------------------------------|---|----|----|----|----|----|----|---------|----------|------------|--|------------------------|--|-----------|--|
| | | 14 & BELOW | 15 | 16 | 18 | 20 | 24 | 28 | 34 | 35 TO 42 | 43 & ABOVE | | | | | |
| | | BRAKE TEMPERATURE MONITOR SYSTEM INDICATION ON EICAS | | | | | | | | | | | | | | |
| | | UP TO 1 | | | 2 | | | 3 | | | 4 | | 5 TO 6 | | 7 & ABOVE | |
| INFLIGHT GEAR DOWN | NO SPECIAL PROCEDURE REQUIRED | 1 | 1 | 2 | 2 | 3 | 4 | 6 | CAUTION | | | | FUSE PLUG MELT ZONE | | | |
| GROUND | | 11 | 15 | 19 | 24 | 34 | 44 | 59 | | | | | | | | |

Observe maximum quick turnaround limit.

Table shows energy per brake added by a single stop with all brakes operating. Energy is assumed to be equally distributed among the operating brakes. Total energy is the sum of residual energy plus energy added.

Add 1.0 million foot pounds per brake for each taxi mile.

For one brake deactivated, increase brake energy by 15 percent.

When in caution zone, wheel fuse plugs may melt. Delay takeoff and inspect after one hour. If overheat occurs after takeoff, extend gear soon for at least 6 minutes.

When in fuse plug melt zone, clear runway immediately. Unless required, do not set parking brake. Do not approach gear or attempt to taxi for one hour. Tire, wheel and brake replacement may be required.

If overheat occurs after takeoff, extend gear soon for at least 10 minutes.

Brake temperature monitor system (BTMS) indication on EICAS may be used 10 to 15 minutes after airplane has come to a complete stop, or inflight with gear retracted, to determine recommended cooling schedule.

**Performance Inflight -
Engine Inoperative****Chapter PI
Section 13****ENGINE INOP****Initial Max Continuous %N1****Based on .80M, packs on or off and APU on**

| TAT (°C) | PRESSURE ALTITUDE (1000 FT) | | | | | | | |
|-------------|-----------------------------|-------|-------|-------|-------|-------|-------|-------|
| | 29 | 31 | 33 | 35 | 37 | 39 | 41 | 43 |
| 20 | 103.8 | 103.4 | 102.5 | | | | | |
| 15 | 104.4 | 104.0 | 103.3 | 102.3 | 101.1 | 100.8 | 100.8 | 100.8 |
| 10 | 105.2 | 104.6 | 104.0 | 103.2 | 101.9 | 101.4 | 101.4 | 101.4 |
| 5 | 106.1 | 105.5 | 104.7 | 103.9 | 102.6 | 102.1 | 102.2 | 102.2 |
| 0 | 107.1 | 106.4 | 105.6 | 104.7 | 103.3 | 102.9 | 102.9 | 102.9 |
| -5 | 106.9 | 107.5 | 106.6 | 105.7 | 104.3 | 103.9 | 103.9 | 103.9 |
| -10 | 106.0 | 107.1 | 107.7 | 106.7 | 105.3 | 104.9 | 104.9 | 104.9 |
| -15 | 105.1 | 106.2 | 107.1 | 107.8 | 106.5 | 106.2 | 106.2 | 106.2 |
| -20 | 104.2 | 105.3 | 106.2 | 106.9 | 106.6 | 106.4 | 106.4 | 106.4 |
| -25 | 103.2 | 104.3 | 105.3 | 105.8 | 105.8 | 105.6 | 105.6 | 105.6 |
| -30 | 102.3 | 103.3 | 104.3 | 104.7 | 104.7 | 104.7 | 104.7 | 104.7 |
| -35 | 101.3 | 102.4 | 103.3 | 103.6 | 103.6 | 103.6 | 103.6 | 103.6 |
| -40 | 100.3 | 101.3 | 102.3 | 102.6 | 102.6 | 102.6 | 102.6 | 102.6 |

ENGINE INOP

Max Continuous %N1

37000 FT to 27000 FT Pressure Altitudes

Based on engine bleed for packs on or off and anti-ice off

| 37000 FT PRESS ALT | | | | | | | | | | | | | TAT (°C) | | | |
|--------------------|-----|-------|-------|-------|-------|-------|-------|-------|-------|-------|-------|-------|----------|-------|--|--|
| CIAS | M | -40 | -35 | -30 | -25 | -20 | -15 | -10 | -5 | 0 | 5 | 10 | 15 | 20 | | |
| 200 | .63 | 102.6 | 103.6 | 104.7 | 105.8 | 106.9 | 105.8 | 104.8 | 104.1 | 103.3 | 101.8 | 98.8 | 95.7 | | | |
| 220 | .69 | 102.6 | 103.6 | 104.7 | 105.8 | 106.9 | 105.9 | 104.8 | 104.0 | 103.3 | 102.4 | 100.4 | 97.5 | | | |
| 240 | .74 | 102.6 | 103.6 | 104.7 | 105.8 | 106.9 | 106.1 | 105.0 | 104.0 | 103.3 | 102.5 | 101.7 | 99.4 | | | |
| 260 | .80 | 102.6 | 103.6 | 104.7 | 105.8 | 106.6 | 106.5 | 105.3 | 104.3 | 103.3 | 102.6 | 101.9 | 101.1 | | | |
| 35000 FT PRESS ALT | | | | | | | | | | | | | TAT (°C) | | | |
| CIAS | M | -40 | -35 | -30 | -25 | -20 | -15 | -10 | -5 | 0 | 5 | 10 | 15 | 20 | | |
| 200 | .60 | 102.6 | 103.6 | 104.7 | 105.8 | 106.9 | 107.2 | 106.2 | 105.5 | 104.7 | 103.2 | 100.2 | 97.1 | | | |
| 220 | .66 | 102.6 | 103.6 | 104.7 | 105.8 | 106.9 | 107.3 | 106.2 | 105.4 | 104.7 | 103.8 | 101.8 | 98.8 | | | |
| 240 | .71 | 102.6 | 103.6 | 104.7 | 105.8 | 106.9 | 107.5 | 106.4 | 105.3 | 104.6 | 104.0 | 102.9 | 100.5 | | | |
| 260 | .77 | 102.6 | 103.6 | 104.7 | 105.8 | 106.9 | 107.7 | 106.6 | 105.6 | 104.5 | 103.9 | 103.2 | 102.1 | | | |
| 33000 FT PRESS ALT | | | | | | | | | | | | | TAT (°C) | | | |
| CIAS | M | -40 | -35 | -30 | -25 | -20 | -15 | -10 | -5 | 0 | 5 | 10 | 15 | 20 | | |
| 200 | .58 | 102.6 | 103.6 | 104.7 | 105.8 | 106.9 | 107.9 | 107.2 | 106.5 | 105.8 | 104.9 | 102.6 | 99.6 | | | |
| 220 | .63 | 102.6 | 103.6 | 104.7 | 105.8 | 106.9 | 107.9 | 107.3 | 106.3 | 105.7 | 105.0 | 104.1 | 101.2 | | | |
| 240 | .68 | 102.6 | 103.6 | 104.7 | 105.8 | 106.9 | 107.9 | 107.4 | 106.4 | 105.5 | 104.9 | 104.1 | 102.7 | | | |
| 260 | .74 | 102.6 | 103.6 | 104.7 | 105.8 | 106.9 | 107.9 | 107.4 | 106.5 | 105.5 | 104.7 | 104.1 | 103.3 | | | |
| 31000 FT PRESS ALT | | | | | | | | | | | | | TAT (°C) | | | |
| CIAS | M | -40 | -35 | -30 | -25 | -20 | -15 | -10 | -5 | 0 | 5 | 10 | 15 | 20 | | |
| 200 | .55 | 102.6 | 103.6 | 104.7 | 105.8 | 106.8 | 107.9 | 108.1 | 107.2 | 106.6 | 106.0 | 105.0 | 102.0 | | | |
| 220 | .61 | 102.6 | 103.6 | 104.7 | 105.8 | 106.9 | 107.9 | 108.2 | 107.3 | 106.6 | 106.0 | 105.3 | 103.5 | | | |
| 240 | .66 | 102.6 | 103.6 | 104.7 | 105.8 | 106.9 | 107.9 | 108.2 | 107.3 | 106.4 | 105.7 | 105.1 | 104.4 | | | |
| 260 | .71 | 102.6 | 103.6 | 104.7 | 105.8 | 106.9 | 107.9 | 108.3 | 107.3 | 106.4 | 105.5 | 104.9 | 104.3 | | | |
| 29000 FT PRESS ALT | | | | | | | | | | | | | TAT (°C) | | | |
| CIAS | M | -40 | -35 | -30 | -25 | -20 | -15 | -10 | -5 | 0 | 5 | 10 | 15 | 20 | | |
| 200 | .53 | 102.6 | 103.6 | 104.7 | 105.8 | 106.8 | 107.9 | 108.4 | 107.5 | 106.8 | 106.1 | 105.5 | 103.6 | 100.7 | | |
| 220 | .58 | 102.6 | 103.6 | 104.7 | 105.8 | 106.9 | 107.9 | 108.5 | 107.7 | 106.7 | 106.1 | 105.5 | 104.9 | 102.1 | | |
| 240 | .63 | 102.6 | 103.6 | 104.7 | 105.8 | 106.9 | 107.9 | 108.7 | 107.7 | 106.8 | 106.0 | 105.4 | 104.8 | 103.5 | | |
| 260 | .68 | 102.6 | 103.6 | 104.7 | 105.8 | 106.9 | 107.9 | 108.8 | 107.7 | 106.8 | 105.9 | 105.3 | 104.7 | 104.0 | | |
| 27000 FT PRESS ALT | | | | | | | | | | | | | TAT (°C) | | | |
| CIAS | M | -40 | -35 | -30 | -25 | -20 | -15 | -10 | -5 | 0 | 5 | 10 | 15 | 20 | | |
| 200 | .51 | 102.6 | 103.6 | 104.7 | 105.8 | 106.8 | 107.9 | 108.2 | 107.2 | 106.3 | 105.6 | 104.8 | 104.1 | 101.4 | | |
| 220 | .56 | 102.6 | 103.6 | 104.7 | 105.8 | 106.8 | 107.9 | 108.4 | 107.4 | 106.4 | 105.6 | 104.9 | 104.2 | 102.7 | | |
| 240 | .60 | 102.6 | 103.6 | 104.7 | 105.8 | 106.9 | 107.9 | 108.6 | 107.6 | 106.7 | 105.7 | 105.0 | 104.3 | 103.6 | | |
| 260 | .65 | 102.2 | 103.2 | 104.2 | 105.1 | 106.1 | 107.0 | 107.9 | 107.8 | 106.8 | 105.9 | 105.0 | 104.3 | 103.6 | | |

%N1 Adjustments for Engine Bleed

| BLEED CONFIGURATION | PRESSURE ALTITUDE (1000 FT) | | | | | |
|---------------------------|-----------------------------|------|------|------|------|------|
| | 27 | 29 | 31 | 33 | 35 | 37 |
| ENGINE ANTI-ICE ON | -0.8 | -0.9 | -1.0 | -1.1 | -1.2 | -1.4 |
| ENGINE & WING ANTI-ICE ON | -1.7 | -1.9 | -2.1 | -2.3 | -2.5 | -2.9 |

ENGINE INOP

Max Continuous %N1

25000 FT to 16000 FT Pressure Altitudes

Based on engine bleed for packs on or off and anti-ice off

| 25000 FT PRESS ALT | | TAT (°C) | | | | | | | | | | | | | | |
|--------------------|-----|----------|-------|-------|-------|-------|-------|-------|-------|-------|-------|-------|-------|-------|-------|-------|
| KIAS | M | -40 | -35 | -30 | -25 | -20 | -15 | -10 | -5 | 0 | 5 | 10 | 15 | 20 | 25 | 30 |
| 200 | .49 | 102.6 | 103.6 | 104.7 | 105.8 | 106.8 | 107.8 | 107.8 | 106.9 | 105.9 | 104.9 | 104.1 | 103.3 | 101.8 | 99.0 | |
| 220 | .53 | 102.3 | 103.3 | 104.3 | 105.3 | 106.2 | 107.1 | 107.9 | 107.1 | 106.1 | 105.0 | 104.2 | 103.4 | 102.7 | 100.3 | |
| 240 | .58 | 101.6 | 102.6 | 103.6 | 104.5 | 105.5 | 106.4 | 107.2 | 107.2 | 106.3 | 105.3 | 104.3 | 103.6 | 102.8 | 101.5 | |
| 260 | .63 | 100.8 | 101.8 | 102.8 | 103.8 | 104.7 | 105.6 | 106.5 | 107.3 | 106.6 | 105.6 | 104.6 | 103.8 | 103.0 | 102.2 | |
| 24000 FT PRESS ALT | | TAT (°C) | | | | | | | | | | | | | | |
| KIAS | M | -40 | -35 | -30 | -25 | -20 | -15 | -10 | -5 | 0 | 5 | 10 | 15 | 20 | 25 | 30 |
| 200 | .48 | 102.6 | 103.6 | 104.7 | 105.8 | 106.8 | 107.9 | 108.4 | 107.6 | 106.6 | 105.6 | 104.9 | 104.1 | 103.2 | 100.5 | |
| 220 | .52 | 102.3 | 103.3 | 104.3 | 105.3 | 106.2 | 107.2 | 108.0 | 107.7 | 106.8 | 105.8 | 104.9 | 104.1 | 103.4 | 101.6 | |
| 240 | .57 | 101.6 | 102.6 | 103.6 | 104.5 | 105.5 | 106.4 | 107.3 | 107.8 | 107.0 | 106.0 | 105.0 | 104.2 | 103.5 | 102.7 | |
| 260 | .61 | 100.8 | 101.8 | 102.8 | 103.7 | 104.7 | 105.6 | 106.5 | 107.4 | 107.1 | 106.2 | 105.2 | 104.4 | 103.6 | 102.8 | |
| 22000 FT PRESS ALT | | TAT (°C) | | | | | | | | | | | | | | |
| KIAS | M | -40 | -35 | -30 | -25 | -20 | -15 | -10 | -5 | 0 | 5 | 10 | 15 | 20 | 25 | 30 |
| 200 | .46 | 102.6 | 103.6 | 104.7 | 105.8 | 106.8 | 107.9 | 108.9 | 109.8 | 108.9 | 107.9 | 106.9 | 106.1 | 105.2 | 103.7 | |
| 220 | .50 | 102.6 | 103.6 | 104.7 | 105.8 | 106.8 | 107.9 | 108.9 | 109.8 | 109.0 | 108.0 | 107.0 | 106.1 | 105.3 | 104.4 | |
| 240 | .55 | 102.6 | 103.6 | 104.7 | 105.7 | 106.6 | 107.6 | 108.5 | 109.4 | 109.2 | 108.2 | 107.2 | 106.3 | 105.4 | 104.6 | |
| 260 | .59 | 102.0 | 103.0 | 104.0 | 105.0 | 105.9 | 106.9 | 107.8 | 108.7 | 109.3 | 108.5 | 107.5 | 106.5 | 105.6 | 104.8 | |
| 20000 FT PRESS ALT | | TAT (°C) | | | | | | | | | | | | | | |
| KIAS | M | -40 | -35 | -30 | -25 | -20 | -15 | -10 | -5 | 0 | 5 | 10 | 15 | 20 | 25 | 30 |
| 200 | .44 | 102.6 | 103.6 | 104.7 | 105.8 | 106.8 | 107.9 | 108.9 | 109.9 | 110.8 | 109.8 | 108.8 | 107.9 | 106.9 | 106.1 | 104.0 |
| 220 | .48 | 102.6 | 103.6 | 104.7 | 105.8 | 106.8 | 107.9 | 108.9 | 109.9 | 110.8 | 109.9 | 108.9 | 108.0 | 107.0 | 106.1 | 104.8 |
| 240 | .53 | 102.6 | 103.6 | 104.7 | 105.8 | 106.8 | 107.9 | 108.9 | 109.9 | 110.8 | 110.1 | 109.1 | 108.1 | 107.2 | 106.2 | 105.4 |
| 260 | .57 | 102.4 | 103.4 | 104.4 | 105.4 | 106.4 | 107.4 | 108.3 | 109.3 | 110.2 | 110.1 | 109.3 | 108.3 | 107.4 | 106.4 | 105.6 |
| 18000 FT PRESS ALT | | TAT (°C) | | | | | | | | | | | | | | |
| KIAS | M | -40 | -35 | -30 | -25 | -20 | -15 | -10 | -5 | 0 | 5 | 10 | 15 | 20 | 25 | 30 |
| 200 | .42 | 102.6 | 103.6 | 104.7 | 105.8 | 106.8 | 107.9 | 108.9 | 109.9 | 110.9 | 110.4 | 109.4 | 108.4 | 107.5 | 106.7 | 105.6 |
| 220 | .46 | 102.6 | 103.6 | 104.7 | 105.8 | 106.8 | 107.9 | 108.9 | 109.9 | 110.9 | 110.3 | 109.3 | 108.3 | 107.4 | 106.6 | 105.7 |
| 240 | .51 | 102.3 | 103.3 | 104.3 | 105.3 | 106.3 | 107.2 | 108.2 | 109.1 | 110.1 | 110.2 | 109.4 | 108.4 | 107.4 | 106.6 | 105.7 |
| 260 | .55 | 101.6 | 102.6 | 103.6 | 104.6 | 105.6 | 106.6 | 107.5 | 108.5 | 109.4 | 110.3 | 109.5 | 108.6 | 107.6 | 106.7 | 105.8 |
| 16000 FT PRESS ALT | | TAT (°C) | | | | | | | | | | | | | | |
| KIAS | M | -40 | -35 | -30 | -25 | -20 | -15 | -10 | -5 | 0 | 5 | 10 | 15 | 20 | 25 | 30 |
| 200 | .41 | 100.9 | 102.0 | 103.0 | 104.1 | 105.1 | 106.2 | 107.2 | 108.2 | 109.1 | 110.1 | 109.5 | 108.6 | 107.7 | 106.9 | 106.1 |
| 220 | .45 | 100.6 | 101.7 | 102.7 | 103.7 | 104.8 | 105.8 | 106.8 | 107.8 | 108.8 | 109.8 | 109.4 | 108.5 | 107.6 | 106.8 | 105.9 |
| 240 | .49 | 100.3 | 101.3 | 102.3 | 103.4 | 104.4 | 105.4 | 106.4 | 107.4 | 108.4 | 109.4 | 109.4 | 108.5 | 107.5 | 106.7 | 105.9 |
| 260 | .53 | 99.9 | 101.0 | 102.0 | 103.0 | 104.0 | 105.0 | 106.1 | 107.1 | 108.0 | 109.0 | 109.5 | 108.6 | 107.7 | 106.8 | 106.0 |

%N1 Adjustments for Engine Bleed

| BLEED CONFIGURATION | PRESSURE ALTITUDE (1000 FT) | | | | | |
|---------------------------|-----------------------------|------|------|------|------|------|
| | 16 | 18 | 20 | 22 | 24 | 25 |
| ENGINE ANTI-ICE ON | -0.4 | -0.4 | -0.5 | -0.6 | -0.7 | -0.7 |
| ENGINE & WING ANTI-ICE ON | -1.1 | -1.1 | -1.2 | -1.4 | -1.5 | -1.5 |

ENGINE INOP

Max Continuous %N1

14000 FT to 5000 FT Pressure Altitudes

Based on engine bleed for packs on or off and anti-ice off

| 14000 FT PRESS ALT | | TAT (°C) | | | | | | | | | | | | | | |
|--------------------|-----|----------|-------|-------|-------|-------|-------|-------|-------|-------|-------|-------|-------|-------|-------|-------|
| KLAS | M | -40 | -35 | -30 | -25 | -20 | -15 | -10 | -5 | 0 | 5 | 10 | 15 | 20 | 25 | 30 |
| 200 | .39 | 101.1 | 102.1 | 103.1 | 104.2 | 105.2 | 106.3 | 107.3 | 108.3 | 109.3 | 110.2 | 109.4 | 108.5 | 107.6 | 106.8 | 106.1 |
| 220 | .43 | 100.8 | 101.8 | 102.8 | 103.9 | 104.8 | 105.8 | 106.8 | 107.7 | 108.6 | 109.6 | 109.4 | 108.4 | 107.6 | 106.7 | 106.0 |
| 240 | .47 | 100.2 | 101.2 | 102.2 | 103.2 | 104.1 | 105.1 | 106.0 | 107.0 | 107.9 | 108.9 | 109.4 | 108.4 | 107.5 | 106.6 | 105.9 |
| 260 | .51 | 99.5 | 100.5 | 101.5 | 102.5 | 103.4 | 104.4 | 105.3 | 106.2 | 107.2 | 108.1 | 109.1 | 108.4 | 107.5 | 106.7 | 105.9 |
| 12000 FT PRESS ALT | | TAT (°C) | | | | | | | | | | | | | | |
| KLAS | M | -40 | -35 | -30 | -25 | -20 | -15 | -10 | -5 | 0 | 5 | 10 | 15 | 20 | 25 | 30 |
| 200 | .38 | 100.0 | 101.0 | 101.9 | 102.9 | 103.9 | 104.8 | 105.8 | 106.7 | 107.7 | 108.6 | 109.2 | 108.2 | 107.4 | 106.6 | 105.8 |
| 220 | .41 | 99.4 | 100.4 | 101.4 | 102.4 | 103.4 | 104.3 | 105.3 | 106.2 | 107.1 | 108.1 | 109.0 | 108.3 | 107.4 | 106.6 | 105.8 |
| 240 | .45 | 98.9 | 99.9 | 100.9 | 101.9 | 102.8 | 103.8 | 104.7 | 105.6 | 106.6 | 107.5 | 108.4 | 108.4 | 107.5 | 106.7 | 105.9 |
| 260 | .49 | 98.4 | 99.4 | 100.3 | 101.3 | 102.3 | 103.2 | 104.1 | 105.1 | 106.0 | 106.9 | 107.8 | 108.5 | 107.6 | 106.8 | 105.9 |
| 10000 FT PRESS ALT | | TAT (°C) | | | | | | | | | | | | | | |
| KLAS | M | -40 | -35 | -30 | -25 | -20 | -15 | -10 | -5 | 0 | 5 | 10 | 15 | 20 | 25 | 30 |
| 200 | .36 | 98.2 | 99.2 | 100.2 | 101.2 | 102.1 | 103.1 | 104.0 | 104.9 | 105.8 | 106.8 | 107.7 | 107.8 | 107.0 | 106.2 | 105.4 |
| 220 | .40 | 97.7 | 98.7 | 99.7 | 100.7 | 101.6 | 102.6 | 103.5 | 104.4 | 105.4 | 106.3 | 107.2 | 107.8 | 107.0 | 106.2 | 105.4 |
| 240 | .43 | 97.4 | 98.4 | 99.3 | 100.3 | 101.3 | 102.2 | 103.1 | 104.1 | 105.0 | 105.9 | 106.8 | 107.7 | 107.2 | 106.4 | 105.6 |
| 260 | .47 | 97.0 | 98.0 | 99.0 | 99.9 | 100.9 | 101.8 | 102.7 | 103.7 | 104.6 | 105.5 | 106.4 | 107.3 | 107.4 | 106.6 | 105.8 |
| 5000 FT PRESS ALT | | TAT (°C) | | | | | | | | | | | | | | |
| KLAS | M | -40 | -35 | -30 | -25 | -20 | -15 | -10 | -5 | 0 | 5 | 10 | 15 | 20 | 25 | 30 |
| 200 | .33 | 95.5 | 96.5 | 97.5 | 98.4 | 99.4 | 100.3 | 101.2 | 102.1 | 103.1 | 104.0 | 104.8 | 105.7 | 106.6 | 106.4 | 105.7 |
| 220 | .36 | 95.1 | 96.1 | 97.1 | 98.0 | 99.0 | 99.9 | 100.8 | 101.7 | 102.7 | 103.6 | 104.4 | 105.3 | 106.2 | 106.4 | 105.7 |
| 240 | .40 | 94.7 | 95.7 | 96.7 | 97.6 | 98.6 | 99.5 | 100.4 | 101.3 | 102.2 | 103.1 | 104.0 | 104.9 | 105.8 | 106.4 | 105.7 |
| 260 | .43 | 94.4 | 95.4 | 96.4 | 97.3 | 98.3 | 99.2 | 100.1 | 101.0 | 101.9 | 102.8 | 103.7 | 104.6 | 105.5 | 106.3 | 105.9 |

%N1 Adjustments for Engine Bleed

| BLEED CONFIGURATION | PRESSURE ALTITUDE (1000 FT) | | | |
|---------------------------|-----------------------------|------|------|------|
| | 5 | 10 | 12 | 14 |
| ENGINE ANTI-ICE ON | -0.6 | -0.5 | -0.5 | -0.6 |
| ENGINE & WING ANTI-ICE ON | -1.2 | -1.1 | -1.2 | -1.2 |

ENGINE INOP

MAX CONTINUOUS THRUST

Driftdown Speed/Level Off Altitude
100 ft/min residual rate of climb

| WEIGHT (1000 LB) | | OPTIMUM DRIFTDOWN SPEED (KIAS) | LEVEL OFF ALTITUDE (FT) | | |
|------------------|-----------|--------------------------------|-------------------------|------------|------------|
| START DRIFT DOWN | LEVEL OFF | | ISA + 10°C & BELOW | ISA + 15°C | ISA + 20°C |
| 420 | 406 | 276 | 18300 | 17300 | 15500 |
| 400 | 388 | 270 | 19700 | 18800 | 17400 |
| 380 | 369 | 263 | 20900 | 20200 | 19200 |
| 360 | 349 | 256 | 22100 | 21400 | 20600 |
| 340 | 330 | 249 | 23300 | 22600 | 21700 |
| 320 | 310 | 242 | 24700 | 23900 | 23000 |
| 300 | 291 | 235 | 26100 | 25400 | 24300 |
| 280 | 271 | 227 | 27800 | 27300 | 26200 |
| 260 | 252 | 219 | 29400 | 29300 | 28600 |
| 240 | 233 | 211 | 31100 | 31100 | 30800 |
| 220 | 213 | 202 | 32900 | 32900 | 32700 |

Includes APU fuel burn.

Driftdown/LRC Cruise Range Capability
Ground to Air Miles Conversion

| AIR DISTANCE (NM) | | | | | GROUND DISTANCE (NM) | AIR DISTANCE (NM) | | | | |
|--------------------------|------|------|------|------|----------------------|--------------------------|------|------|------|------|
| HEADWIND COMPONENT (KTS) | | | | | | TAILWIND COMPONENT (KTS) | | | | |
| 100 | 80 | 60 | 40 | 20 | | 20 | 40 | 60 | 80 | 100 |
| 265 | 249 | 234 | 222 | 210 | 200 | 191 | 182 | 174 | 167 | 161 |
| 533 | 500 | 470 | 444 | 421 | 400 | 381 | 364 | 348 | 333 | 320 |
| 803 | 752 | 707 | 667 | 632 | 600 | 571 | 545 | 521 | 499 | 479 |
| 1074 | 1005 | 945 | 891 | 843 | 800 | 761 | 726 | 694 | 664 | 637 |
| 1346 | 1259 | 1182 | 1115 | 1054 | 1000 | 951 | 907 | 866 | 829 | 796 |
| 1618 | 1513 | 1420 | 1338 | 1265 | 1200 | 1141 | 1088 | 1039 | 994 | 953 |
| 1892 | 1767 | 1659 | 1562 | 1477 | 1400 | 1331 | 1268 | 1211 | 1159 | 1111 |
| 2165 | 2022 | 1897 | 1786 | 1688 | 1600 | 1521 | 1449 | 1383 | 1324 | 1269 |
| 2438 | 2277 | 2135 | 2010 | 1899 | 1800 | 1710 | 1629 | 1556 | 1488 | 1427 |

Driftdown/Cruise Fuel and Time

| AIR DIST (NM) | FUEL REQUIRED (1000 LB) | | | | | | | | | | | TIME (HR:MIN) |
|---------------|--|------|------|------|------|------|------|------|------|------|------|---------------|
| | WEIGHT AT START OF DRIFTDOWN (1000 LB) | | | | | | | | | | | |
| | 220 | 240 | 260 | 280 | 300 | 320 | 340 | 360 | 380 | 400 | 420 | |
| 200 | 3.5 | 3.7 | 4.0 | 4.2 | 4.4 | 4.7 | 4.9 | 5.2 | 5.6 | 5.9 | 6.0 | 0:29 |
| 400 | 7.5 | 8.0 | 8.7 | 9.2 | 9.8 | 10.4 | 10.9 | 11.6 | 12.2 | 12.9 | 13.4 | 0:60 |
| 600 | 11.3 | 12.2 | 13.2 | 14.0 | 15.0 | 15.9 | 16.7 | 17.7 | 18.7 | 19.7 | 20.4 | 1:31 |
| 800 | 15.1 | 16.3 | 17.6 | 18.8 | 20.0 | 21.3 | 22.4 | 23.7 | 25.0 | 26.3 | 27.4 | 2:02 |
| 1000 | 18.9 | 20.4 | 22.0 | 23.5 | 25.0 | 26.6 | 28.0 | 29.6 | 31.2 | 32.8 | 34.3 | 2:34 |
| 1200 | 22.5 | 24.3 | 26.3 | 28.1 | 30.0 | 31.8 | 33.5 | 35.4 | 37.3 | 39.3 | 41.0 | 3:06 |
| 1400 | 26.1 | 28.3 | 30.5 | 32.6 | 34.8 | 37.0 | 39.0 | 41.2 | 43.4 | 45.6 | 47.7 | 3:38 |
| 1600 | 29.7 | 32.1 | 34.7 | 37.1 | 39.6 | 42.0 | 44.4 | 46.8 | 49.3 | 51.9 | 54.3 | 4:10 |
| 1800 | 33.2 | 35.9 | 38.8 | 41.5 | 44.3 | 47.1 | 49.7 | 52.4 | 55.2 | 58.1 | 60.8 | 4:43 |

Includes APU fuel burn.

Driftdown at optimum driftdown speed and cruise at Long Range Cruise speed.

ENGINE INOP

MAX CONTINUOUS THRUST

**Long Range Cruise Altitude Capability
100 ft/min residual rate of climb and APU on**

| WEIGHT (1000 LB) | PRESSURE ALTITUDE (FT) | | |
|---------------------|------------------------|------------|------------|
| | ISA + 10°C & BELOW | ISA + 15°C | ISA + 20°C |
| 420 | 15300 | 12900 | 10100 |
| 410 | 16100 | 13900 | 11200 |
| 400 | 17000 | 15000 | 12300 |
| 390 | 17800 | 16000 | 13500 |
| 380 | 18700 | 17100 | 14600 |
| 370 | 19500 | 18100 | 15700 |
| 360 | 20300 | 19000 | 16900 |
| 350 | 20900 | 20000 | 18100 |
| 340 | 21500 | 20600 | 19300 |
| 330 | 22100 | 21200 | 20300 |
| 320 | 22800 | 21900 | 20900 |
| 310 | 23500 | 22500 | 21500 |
| 300 | 24100 | 23200 | 22100 |
| 290 | 24900 | 23900 | 22800 |
| 280 | 25700 | 24600 | 23400 |
| 270 | 26700 | 25500 | 24100 |
| 260 | 27600 | 26800 | 24800 |
| 250 | 28600 | 28000 | 26200 |
| 240 | 29600 | 29300 | 27700 |
| 230 | 30600 | 30400 | 29300 |
| 220 | 31500 | 31400 | 30600 |

With engine anti-ice on, decrease altitude capability by 1800 ft.

With engine and wing anti-ice on, decrease altitude capability by 3800 ft.

ENGINE INOP

MAX CONTINUOUS THRUST

Long Range Cruise Control

| WEIGHT (1000 LB) | | PRESSURE ALTITUDE (1000 FT) | | | | | | | | |
|---------------------|--------|-----------------------------|-------|-------|-------|-------|-------|-------|-------|------|
| | | 10 | 14 | 18 | 21 | 23 | 25 | 27 | 29 | 31 |
| 420 | %N1 | 98.9 | 102.5 | | | | | | | |
| | MACH | .584 | .617 | | | | | | | |
| | KIAS | 324 | 319 | | | | | | | |
| | FF/ENG | 14058 | 14193 | | | | | | | |
| 400 | %N1 | 97.5 | 100.9 | 105.3 | | | | | | |
| | MACH | .573 | .606 | .643 | | | | | | |
| | KIAS | 318 | 313 | 308 | | | | | | |
| | FF/ENG | 13339 | 13421 | 13752 | | | | | | |
| 380 | %N1 | 96.0 | 99.4 | 103.3 | | | | | | |
| | MACH | .563 | .596 | .631 | | | | | | |
| | KIAS | 312 | 307 | 302 | | | | | | |
| | FF/ENG | 12635 | 12695 | 12923 | | | | | | |
| 360 | %N1 | 94.4 | 97.8 | 101.5 | 105.2 | | | | | |
| | MACH | .550 | .585 | .619 | .647 | | | | | |
| | KIAS | 305 | 301 | 296 | 292 | | | | | |
| | FF/ENG | 11912 | 11976 | 12117 | 12403 | | | | | |
| 340 | %N1 | 92.9 | 96.1 | 99.6 | 102.9 | | | | | |
| | MACH | .538 | .572 | .606 | .634 | | | | | |
| | KIAS | 298 | 295 | 290 | 286 | | | | | |
| | FF/ENG | 11215 | 11267 | 11346 | 11549 | | | | | |
| 320 | %N1 | 91.2 | 94.4 | 97.8 | 100.8 | 103.2 | | | | |
| | MACH | .525 | .559 | .594 | .621 | .640 | | | | |
| | KIAS | 291 | 288 | 284 | 279 | 277 | | | | |
| | FF/ENG | 10540 | 10566 | 10625 | 10739 | 10905 | | | | |
| 300 | %N1 | 89.6 | 92.6 | 96.0 | 98.7 | 100.8 | 103.5 | | | |
| | MACH | .512 | .545 | .580 | .606 | .625 | .645 | | | |
| | KIAS | 283 | 280 | 277 | 273 | 270 | 268 | | | |
| | FF/ENG | 9873 | 9852 | 9903 | 9966 | 10078 | 10257 | | | |
| 280 | %N1 | 87.8 | 90.8 | 94.0 | 96.7 | 98.5 | 100.8 | 103.7 | | |
| | MACH | .498 | .530 | .566 | .593 | .610 | .629 | .649 | | |
| | KIAS | 276 | 272 | 270 | 266 | 263 | 261 | 259 | | |
| | FF/ENG | 9219 | 9175 | 9209 | 9251 | 9288 | 9413 | 9597 | | |
| 260 | %N1 | 85.8 | 88.8 | 91.9 | 94.5 | 96.3 | 98.3 | 100.6 | 103.9 | |
| | MACH | .484 | .515 | .549 | .576 | .595 | .612 | .632 | .653 | |
| | KIAS | 268 | 264 | 261 | 259 | 257 | 254 | 252 | 249 | |
| | FF/ENG | 8574 | 8506 | 8497 | 8536 | 8571 | 8611 | 8740 | 8925 | |
| 240 | %N1 | 83.8 | 86.8 | 89.8 | 92.3 | 94.0 | 95.9 | 97.9 | 100.3 | |
| | MACH | .468 | .499 | .532 | .559 | .578 | .596 | .614 | .635 | |
| | KIAS | 259 | 256 | 253 | 251 | 249 | 247 | 244 | 242 | |
| | FF/ENG | 7928 | 7855 | 7819 | 7842 | 7862 | 7889 | 7932 | 8059 | |
| 220 | %N1 | 81.5 | 84.5 | 87.6 | 89.9 | 91.6 | 93.4 | 95.2 | 97.3 | 99.8 |
| | MACH | .449 | .482 | .514 | .540 | .559 | .577 | .596 | .615 | .635 |
| | KIAS | 248 | 247 | 244 | 242 | 240 | 239 | 236 | 234 | 232 |
| | FF/ENG | 7259 | 7214 | 7156 | 7144 | 7170 | 7187 | 7208 | 7250 | 7367 |

ENGINE INOP

MAX CONTINUOUS THRUST

**Long Range Cruise Diversion Fuel and Time
Ground to Air Miles Conversion**

| AIR DISTANCE (NM) | | | | | GROUND DISTANCE (NM) | AIR DISTANCE (NM) | | | | |
|--------------------------|------|------|------|------|----------------------------|--------------------------|------|------|------|------|
| HEADWIND COMPONENT (KTS) | | | | | | TAILWIND COMPONENT (KTS) | | | | |
| 100 | 80 | 60 | 40 | 20 | | 20 | 40 | 60 | 80 | 100 |
| 288 | 265 | 245 | 228 | 213 | 200 | 190 | 181 | 173 | 166 | 159 |
| 578 | 532 | 490 | 456 | 427 | 400 | 380 | 362 | 346 | 331 | 318 |
| 869 | 799 | 737 | 685 | 640 | 600 | 571 | 544 | 519 | 497 | 477 |
| 1160 | 1067 | 984 | 914 | 854 | 800 | 761 | 725 | 692 | 662 | 636 |
| 1453 | 1335 | 1231 | 1143 | 1068 | 1000 | 951 | 906 | 865 | 828 | 794 |
| 1747 | 1605 | 1479 | 1373 | 1282 | 1200 | 1141 | 1087 | 1038 | 993 | 953 |
| 2042 | 1875 | 1728 | 1603 | 1496 | 1400 | 1332 | 1269 | 1211 | 1158 | 1111 |
| 2339 | 2147 | 1977 | 1833 | 1710 | 1600 | 1521 | 1449 | 1383 | 1323 | 1269 |
| 2637 | 2419 | 2226 | 2064 | 1924 | 1800 | 1711 | 1629 | 1555 | 1487 | 1427 |

Reference Fuel and Time Required at Check Point

| AIR DIST (NM) | PRESSURE ALTITUDE (1000 FT) | | | | | | | | | |
|---------------------|-----------------------------|------------------|-------------------|------------------|-------------------|------------------|-------------------|------------------|-------------------|------------------|
| | 10 | | 14 | | 18 | | 22 | | 26 | |
| | FUEL (1000 LB) | TIME (HR:MIN) | FUEL (1000 LB) | TIME (HR:MIN) | FUEL (1000 LB) | TIME (HR:MIN) | FUEL (1000 LB) | TIME (HR:MIN) | FUEL (1000 LB) | TIME (HR:MIN) |
| 200 | 5.6 | 0:41 | 4.9 | 0:40 | 4.4 | 0:39 | 4.0 | 0:38 | 3.7 | 0:37 |
| 400 | 11.6 | 1:18 | 10.7 | 1:15 | 10.0 | 1:12 | 9.4 | 1:10 | 9.0 | 1:07 |
| 600 | 17.6 | 1:56 | 16.4 | 1:51 | 15.4 | 1:46 | 14.6 | 1:42 | 14.2 | 1:38 |
| 800 | 23.5 | 2:33 | 22.0 | 2:27 | 20.8 | 2:20 | 19.8 | 2:15 | 19.3 | 2:09 |
| 1000 | 29.4 | 3:11 | 27.6 | 3:03 | 26.1 | 2:55 | 24.9 | 2:48 | 24.3 | 2:41 |
| 1200 | 35.1 | 3:50 | 33.1 | 3:39 | 31.4 | 3:29 | 30.0 | 3:21 | 29.2 | 3:12 |
| 1400 | 40.9 | 4:29 | 38.5 | 4:16 | 36.5 | 4:04 | 35.0 | 3:54 | 34.1 | 3:44 |
| 1600 | 46.5 | 5:08 | 43.8 | 4:53 | 41.7 | 4:39 | 39.9 | 4:27 | 38.9 | 4:16 |
| 1800 | 52.1 | 5:47 | 49.1 | 5:31 | 46.7 | 5:15 | 44.8 | 5:01 | 43.6 | 4:48 |

Fuel Required Adjustment (1000 LB)

| REFERENCE FUEL REQUIRED (1000 LB) | WEIGHT AT CHECK POINT (1000 LB) | | | | |
|--------------------------------------|---------------------------------|------|-----|-----|------|
| | 200 | 250 | 300 | 350 | 400 |
| 5 | -0.8 | -0.4 | 0.0 | 0.6 | 1.1 |
| 10 | -1.8 | -0.9 | 0.0 | 1.4 | 2.6 |
| 15 | -2.8 | -1.4 | 0.0 | 2.2 | 4.2 |
| 20 | -3.8 | -1.9 | 0.0 | 3.0 | 5.7 |
| 25 | -4.8 | -2.4 | 0.0 | 3.7 | 7.3 |
| 30 | -5.8 | -2.8 | 0.0 | 4.5 | 8.8 |
| 35 | -6.8 | -3.3 | 0.0 | 5.3 | 10.4 |
| 40 | -7.8 | -3.8 | 0.0 | 6.0 | 11.9 |
| 45 | -8.8 | -4.3 | 0.0 | 6.7 | 13.5 |
| 50 | -9.8 | -4.8 | 0.0 | 7.5 | 15.1 |
| 55 | -10.8 | -5.3 | 0.0 | 8.2 | 16.7 |

Includes APU fuel burn.

ENGINE INOP
MAX CONTINUOUS THRUST

**Holding
 Flaps Up**

| WEIGHT (1000 LB) | | PRESSURE ALTITUDE (FT) | | | | | | |
|---------------------|--------|------------------------|-------|-------|-------|-------|-------|-------|
| | | 1500 | 5000 | 10000 | 15000 | 20000 | 25000 | 30000 |
| 420 | %N1 | 87.4 | 90.4 | 95.0 | 100.3 | | | |
| | KIAS | 259 | 259 | 259 | 259 | | | |
| | FF/ENG | 12060 | 12150 | 12380 | 12850 | | | |
| 400 | %N1 | 85.8 | 88.9 | 93.4 | 98.5 | 105.8 | | |
| | KIAS | 252 | 252 | 252 | 252 | 252 | | |
| | FF/ENG | 11430 | 11490 | 11680 | 12050 | 12880 | | |
| 380 | %N1 | 84.2 | 87.4 | 91.8 | 96.7 | 103.1 | | |
| | KIAS | 246 | 246 | 246 | 246 | 246 | | |
| | FF/ENG | 10820 | 10860 | 11010 | 11300 | 11940 | | |
| 360 | %N1 | 82.6 | 85.6 | 90.1 | 94.9 | 100.7 | | |
| | KIAS | 239 | 239 | 239 | 239 | 239 | | |
| | FF/ENG | 10210 | 10230 | 10340 | 10580 | 11080 | | |
| 340 | %N1 | 80.7 | 83.8 | 88.3 | 93.0 | 98.5 | | |
| | KIAS | 231 | 231 | 231 | 231 | 231 | | |
| | FF/ENG | 9610 | 9620 | 9690 | 9870 | 10260 | | |
| 320 | %N1 | 78.8 | 82.1 | 86.5 | 91.1 | 96.2 | 103.7 | |
| | KIAS | 225 | 225 | 225 | 225 | 225 | 225 | |
| | FF/ENG | 9020 | 9020 | 9060 | 9200 | 9490 | 10170 | |
| 300 | %N1 | 76.8 | 80.1 | 84.6 | 89.1 | 94.0 | 100.3 | |
| | KIAS | 220 | 220 | 220 | 220 | 220 | 220 | |
| | FF/ENG | 8440 | 8430 | 8450 | 8550 | 8770 | 9250 | |
| 280 | %N1 | 74.8 | 77.9 | 82.5 | 87.0 | 91.8 | 97.4 | |
| | KIAS | 215 | 215 | 215 | 215 | 215 | 215 | |
| | FF/ENG | 7880 | 7860 | 7870 | 7930 | 8090 | 8440 | |
| 260 | %N1 | 72.7 | 75.8 | 80.5 | 85.0 | 89.6 | 94.8 | 102.6 |
| | KIAS | 210 | 210 | 210 | 210 | 210 | 210 | 210 |
| | FF/ENG | 7340 | 7310 | 7300 | 7330 | 7450 | 7700 | 8290 |
| 240 | %N1 | 70.2 | 73.6 | 78.1 | 82.7 | 87.3 | 92.2 | 98.6 |
| | KIAS | 204 | 204 | 204 | 204 | 204 | 204 | 204 |
| | FF/ENG | 6800 | 6770 | 6750 | 6760 | 6840 | 7000 | 7400 |
| 220 | %N1 | 67.8 | 71.1 | 75.6 | 80.4 | 84.9 | 89.6 | 95.2 |
| | KIAS | 199 | 199 | 199 | 199 | 199 | 199 | 199 |
| | FF/ENG | 6280 | 6240 | 6220 | 6210 | 6250 | 6360 | 6640 |

This table includes 5% additional fuel for holding in a racetrack pattern.

Intentionally
Blank

Performance Inflight - Gear Down

Chapter PI Section 14

GEAR DOWN

200 KIAS Max Climb %N1

Based on engine bleed for packs on and anti-ice off

| TAT (°C) | PRESSURE ALTITUDE (1000 FT) | | | | | | | | | | | | |
|-------------|-----------------------------|-------|-------|-------|-------|-------|-------|-------|-------|-------|-------|-------|-------|
| | 0 | 5 | 10 | 12 | 14 | 16 | 18 | 20 | 22 | 24 | 26 | 28 | 30 |
| 55 | 96.7 | 97.4 | 97.0 | 97.0 | 96.6 | 96.7 | 97.0 | 97.1 | 96.1 | 95.2 | 96.3 | 98.2 | 99.9 |
| 50 | 97.2 | 98.3 | 98.1 | 98.1 | 97.8 | 97.9 | 98.3 | 98.3 | 97.3 | 96.2 | 96.2 | 97.5 | 99.2 |
| 45 | 97.9 | 98.8 | 99.1 | 99.1 | 98.9 | 99.0 | 99.5 | 99.5 | 98.5 | 97.4 | 97.4 | 98.1 | 98.8 |
| 40 | 98.5 | 99.3 | 99.9 | 100.1 | 99.9 | 100.2 | 100.6 | 100.7 | 99.6 | 98.6 | 98.5 | 99.3 | 99.9 |
| 35 | 99.1 | 100.0 | 100.4 | 100.7 | 100.9 | 101.2 | 101.7 | 101.8 | 100.7 | 99.7 | 99.6 | 100.4 | 101.0 |
| 30 | 99.6 | 100.6 | 101.1 | 101.2 | 101.4 | 102.1 | 102.8 | 102.9 | 101.8 | 100.8 | 100.7 | 101.4 | 102.1 |
| 25 | 98.7 | 101.4 | 101.7 | 101.9 | 102.0 | 102.6 | 103.5 | 103.9 | 102.9 | 101.8 | 101.7 | 102.5 | 103.1 |
| 20 | 97.9 | 101.9 | 102.5 | 102.6 | 102.7 | 103.3 | 104.1 | 104.6 | 103.7 | 102.8 | 102.7 | 103.4 | 104.1 |
| 15 | 97.1 | 101.0 | 103.5 | 103.4 | 103.4 | 104.0 | 104.9 | 105.3 | 104.5 | 103.6 | 103.6 | 104.4 | 105.0 |
| 10 | 96.3 | 100.2 | 103.6 | 104.4 | 104.2 | 104.8 | 105.7 | 106.2 | 105.3 | 104.5 | 104.4 | 105.2 | 105.9 |
| 5 | 95.5 | 99.3 | 102.7 | 103.9 | 104.9 | 105.6 | 106.5 | 107.0 | 106.2 | 105.4 | 105.3 | 105.9 | 106.6 |
| 0 | 94.7 | 98.4 | 101.8 | 103.0 | 104.0 | 105.6 | 107.3 | 107.8 | 107.2 | 106.3 | 106.2 | 106.7 | 107.2 |
| -5 | 93.8 | 97.5 | 100.9 | 102.1 | 103.0 | 104.7 | 106.7 | 108.3 | 108.2 | 107.6 | 107.1 | 107.5 | 108.0 |
| -10 | 93.0 | 96.6 | 100.0 | 101.2 | 102.2 | 103.7 | 105.8 | 107.3 | 108.2 | 108.5 | 108.5 | 108.5 | 108.5 |
| -15 | 92.1 | 95.7 | 99.1 | 100.3 | 101.2 | 102.8 | 104.8 | 106.4 | 107.3 | 107.5 | 107.5 | 107.5 | 107.5 |
| -20 | 91.3 | 94.8 | 98.2 | 99.3 | 100.3 | 102.0 | 103.9 | 105.5 | 106.3 | 106.5 | 106.5 | 106.5 | 106.5 |
| -25 | 90.4 | 93.9 | 97.3 | 98.4 | 99.4 | 101.0 | 103.0 | 104.6 | 105.4 | 105.4 | 105.4 | 105.4 | 105.4 |
| -30 | 89.5 | 93.0 | 96.4 | 97.5 | 98.5 | 100.0 | 102.0 | 103.7 | 104.4 | 104.4 | 104.4 | 104.4 | 104.4 |
| -35 | 88.6 | 92.0 | 95.4 | 96.5 | 97.5 | 99.0 | 101.1 | 102.7 | 103.3 | 103.3 | 103.3 | 103.3 | 103.3 |
| -40 | 87.7 | 91.1 | 94.5 | 95.6 | 96.5 | 98.1 | 100.1 | 101.8 | 102.2 | 102.2 | 102.2 | 102.2 | 102.2 |

%N1 Adjustments for Engine Bleeds

| BLEED CONFIGURATION | PRESSURE ALTITUDE (1000 FT) | | | | | | | | | | | | |
|---------------------------|-----------------------------|------|------|------|------|------|------|------|------|------|------|------|------|
| | 0 | 5 | 10 | 12 | 14 | 16 | 18 | 20 | 22 | 24 | 26 | 28 | 30 |
| PACKS OFF | 0.0 | 0.0 | 0.0 | 0.0 | 0.0 | 0.0 | 0.0 | 0.0 | 0.0 | 0.0 | 0.0 | 0.0 | 0.0 |
| ENGINE ANTI-ICE ON | -0.6 | -0.6 | -0.6 | -0.6 | -0.6 | -0.6 | -0.7 | -0.8 | -0.8 | -0.9 | -1.0 | -1.0 | -1.1 |
| ENGINE & WING ANTI-ICE ON | -0.9 | -0.9 | -1.0 | -1.0 | -1.1 | -1.1 | -1.2 | -1.3 | -1.3 | -1.4 | -1.5 | -1.5 | -1.7 |

Long Range Cruise Altitude Capability

| WEIGHT (1000 LB) | PRESSURE ALTITUDE (FT) | | |
|---------------------|------------------------|------------|------------|
| | ISA + 10°C & BELOW | ISA + 15°C | ISA + 20°C |
| 400 | 21400 | 20000 | 18300 |
| 380 | 23200 | 21700 | 20300 |
| 360 | 25100 | 23500 | 22100 |
| 340 | 27000 | 25400 | 23900 |
| 320 | 28400 | 27700 | 26100 |
| 300 | 29900 | 29800 | 28700 |
| 280 | 31200 | 31100 | 30600 |
| 260 | 32500 | 32400 | 32000 |
| 240 | 33900 | 33800 | 33500 |
| 220 | 35300 | 35300 | 35000 |

GEAR DOWN

Long Range Cruise Control

| WEIGHT (1000 LB) | | PRESSURE ALTITUDE (1000 FT) | | | | | | | | | | |
|---------------------|--------|-----------------------------|-------|-------|-------|-------|-------|-------|-------|-------|-------|-------|
| | | 10 | 14 | 18 | 21 | 23 | 25 | 27 | 29 | 31 | 33 | 35 |
| 420 | %N1 | 91.7 | 95.2 | 99.2 | | | | | | | | |
| | MACH | .473 | .508 | .547 | | | | | | | | |
| | KIAS | 262 | 261 | 260 | | | | | | | | |
| | FF/ENG | 10536 | 10639 | 10900 | | | | | | | | |
| 400 | %N1 | 90.2 | 93.7 | 97.6 | 100.9 | | | | | | | |
| | MACH | .462 | .497 | .536 | .565 | | | | | | | |
| | KIAS | 256 | 255 | 255 | 254 | | | | | | | |
| | FF/ENG | 9983 | 10059 | 10267 | 10508 | | | | | | | |
| 380 | %N1 | 88.8 | 92.1 | 95.8 | 99.0 | 101.6 | | | | | | |
| | MACH | .452 | .486 | .523 | .553 | .574 | | | | | | |
| | KIAS | 250 | 249 | 249 | 248 | 247 | | | | | | |
| | FF/ENG | 9452 | 9498 | 9633 | 9835 | 10042 | | | | | | |
| 360 | %N1 | 87.3 | 90.5 | 94.1 | 97.1 | 99.4 | 102.3 | | | | | |
| | MACH | .441 | .474 | .510 | .540 | .560 | .582 | | | | | |
| | KIAS | 244 | 243 | 242 | 242 | 241 | 241 | | | | | |
| | FF/ENG | 8927 | 8935 | 9028 | 9201 | 9336 | 9566 | | | | | |
| 340 | %N1 | 85.6 | 88.8 | 92.4 | 95.3 | 97.4 | 99.8 | 103.0 | | | | |
| | MACH | .430 | .461 | .497 | .527 | .547 | .568 | .589 | | | | |
| | KIAS | 237 | 236 | 236 | 236 | 235 | 234 | 233 | | | | |
| | FF/ENG | 8407 | 8388 | 8453 | 8577 | 8692 | 8853 | 9071 | | | | |
| 320 | %N1 | 83.9 | 87.2 | 90.6 | 93.3 | 95.4 | 97.5 | 100.2 | 103.7 | | | |
| | MACH | .418 | .449 | .484 | .512 | .533 | .553 | .575 | .595 | | | |
| | KIAS | 231 | 230 | 229 | 229 | 229 | 228 | 228 | 226 | | | |
| | FF/ENG | 7885 | 7864 | 7899 | 7967 | 8075 | 8179 | 8365 | 8564 | | | |
| 300 | %N1 | 82.1 | 85.4 | 88.7 | 91.3 | 93.2 | 95.3 | 97.6 | 100.5 | | | |
| | MACH | .405 | .436 | .469 | .497 | .517 | .538 | .558 | .581 | | | |
| | KIAS | 224 | 223 | 222 | 222 | 222 | 222 | 221 | 220 | | | |
| | FF/ENG | 7380 | 7347 | 7344 | 7395 | 7455 | 7562 | 7668 | 7863 | | | |
| 280 | %N1 | 80.4 | 83.4 | 86.7 | 89.3 | 91.1 | 93.1 | 95.2 | 97.6 | 100.8 | | |
| | MACH | .394 | .422 | .455 | .482 | .501 | .521 | .542 | .563 | .586 | | |
| | KIAS | 218 | 216 | 215 | 215 | 215 | 214 | 214 | 213 | 213 | | |
| | FF/ENG | 6918 | 6832 | 6817 | 6845 | 6878 | 6945 | 7041 | 7159 | 7348 | | |
| 260 | %N1 | 78.2 | 81.3 | 84.7 | 87.2 | 89.0 | 90.8 | 92.8 | 95.0 | 97.5 | 100.9 | |
| | MACH | .382 | .408 | .440 | .465 | .484 | .504 | .525 | .546 | .568 | .590 | |
| | KIAS | 210 | 209 | 208 | 207 | 207 | 207 | 206 | 206 | 206 | 205 | |
| | FF/ENG | 6445 | 6323 | 6304 | 6300 | 6329 | 6361 | 6432 | 6522 | 6654 | 6817 | |
| 240 | %N1 | 75.8 | 79.4 | 82.5 | 85.0 | 86.7 | 88.5 | 90.4 | 92.4 | 94.6 | 97.3 | 100.9 |
| | MACH | .367 | .395 | .424 | .449 | .467 | .486 | .506 | .527 | .548 | .571 | .593 |
| | KIAS | 202 | 202 | 200 | 200 | 199 | 199 | 199 | 199 | 198 | 198 | 196 |
| | FF/ENG | 5948 | 5864 | 5796 | 5785 | 5785 | 5813 | 5843 | 5914 | 6005 | 6136 | 6293 |
| 220 | %N1 | 73.4 | 76.8 | 80.1 | 82.6 | 84.3 | 86.0 | 87.8 | 89.7 | 91.8 | 94.0 | 96.8 |
| | MACH | .353 | .380 | .407 | .432 | .449 | .466 | .486 | .506 | .528 | .550 | .573 |
| | KIAS | 194 | 194 | 192 | 192 | 192 | 191 | 191 | 191 | 191 | 190 | 190 |
| | FF/ENG | 5476 | 5399 | 5295 | 5280 | 5272 | 5272 | 5296 | 5325 | 5397 | 5486 | 5613 |

GEAR DOWN

**Long Range Cruise Enroute Fuel and Time
 Ground to Air Miles Conversion**

| AIR DISTANCE (NM) | | | | | GROUND DISTANCE (NM) | AIR DISTANCE (NM) | | | | |
|--------------------------|------|------|------|------|----------------------|--------------------------|------|------|------|------|
| HEADWIND COMPONENT (KTS) | | | | | | TAILWIND COMPONENT (KTS) | | | | |
| 100 | 80 | 60 | 40 | 20 | 20 | 40 | 60 | 80 | 100 | |
| 324 | 290 | 260 | 236 | 217 | 200 | 189 | 179 | 170 | 161 | 154 |
| 655 | 584 | 523 | 474 | 435 | 400 | 377 | 356 | 338 | 322 | 308 |
| 989 | 880 | 787 | 713 | 653 | 600 | 566 | 535 | 507 | 483 | 461 |
| 1327 | 1180 | 1053 | 953 | 871 | 800 | 754 | 713 | 676 | 643 | 614 |
| 1670 | 1482 | 1320 | 1193 | 1090 | 1000 | 943 | 891 | 844 | 803 | 766 |
| 2018 | 1787 | 1590 | 1435 | 1309 | 1200 | 1131 | 1069 | 1013 | 962 | 918 |
| 2371 | 2096 | 1862 | 1678 | 1529 | 1400 | 1319 | 1246 | 1180 | 1121 | 1069 |
| 2729 | 2409 | 2136 | 1922 | 1750 | 1600 | 1507 | 1423 | 1347 | 1279 | 1219 |
| 3093 | 2725 | 2411 | 2167 | 1970 | 1800 | 1695 | 1599 | 1513 | 1437 | 1370 |
| 3462 | 3044 | 2688 | 2412 | 2191 | 2000 | 1882 | 1775 | 1679 | 1594 | 1519 |

Reference Fuel and Time Required at Check Point

| AIR DIST (NM) | PRESSURE ALTITUDE (1000 FT) | | | | | | | | | |
|---------------|-----------------------------|---------------|----------------|---------------|----------------|---------------|----------------|---------------|----------------|---------------|
| | 10 | | 14 | | 18 | | 22 | | 28 | |
| | FUEL (1000 LB) | TIME (HR:MIN) | FUEL (1000 LB) | TIME (HR:MIN) | FUEL (1000 LB) | TIME (HR:MIN) | FUEL (1000 LB) | TIME (HR:MIN) | FUEL (1000 LB) | TIME (HR:MIN) |
| 200 | 10.4 | 0:50 | 9.5 | 0:48 | 8.7 | 0:46 | 8.0 | 0:44 | 7.2 | 0:42 |
| 400 | 21.5 | 1:37 | 19.9 | 1:33 | 18.5 | 1:28 | 17.3 | 1:24 | 16.0 | 1:18 |
| 600 | 32.4 | 2:26 | 30.1 | 2:18 | 28.2 | 2:11 | 26.5 | 2:04 | 24.7 | 1:55 |
| 800 | 43.1 | 3:15 | 40.1 | 3:05 | 37.6 | 2:55 | 35.4 | 2:45 | 33.2 | 2:32 |
| 1000 | 53.5 | 4:05 | 49.9 | 3:52 | 46.8 | 3:39 | 44.2 | 3:26 | 41.4 | 3:09 |
| 1200 | 63.7 | 4:56 | 59.5 | 4:40 | 55.9 | 4:24 | 52.8 | 4:09 | 49.4 | 3:47 |
| 1400 | 73.7 | 5:48 | 68.9 | 5:29 | 64.7 | 5:10 | 61.1 | 4:51 | 57.3 | 4:26 |
| 1600 | 83.5 | 6:41 | 78.1 | 6:18 | 73.4 | 5:56 | 69.4 | 5:35 | 64.9 | 5:05 |
| 1800 | 93.0 | 7:35 | 87.1 | 7:09 | 81.9 | 6:44 | 77.4 | 6:19 | 72.4 | 5:45 |
| 2000 | 102.4 | 8:31 | 95.9 | 8:00 | 90.2 | 7:32 | 85.3 | 7:04 | 79.8 | 6:26 |

Fuel Required Adjustment (1000 LB)

| REFERENCE FUEL REQUIRED (1000 LB) | WEIGHT AT CHECK POINT (1000 LB) | | | | |
|-----------------------------------|---------------------------------|-------|-----|------|------|
| | 200 | 250 | 300 | 350 | 400 |
| 10 | -1.7 | -0.8 | 0.0 | 1.4 | 3.0 |
| 20 | -3.6 | -1.8 | 0.0 | 2.9 | 6.2 |
| 30 | -5.5 | -2.7 | 0.0 | 4.4 | 9.3 |
| 40 | -7.3 | -3.6 | 0.0 | 5.8 | 12.3 |
| 50 | -9.2 | -4.6 | 0.0 | 7.2 | 15.2 |
| 60 | -11.1 | -5.5 | 0.0 | 8.6 | 18.1 |
| 70 | -12.9 | -6.5 | 0.0 | 9.9 | 20.8 |
| 80 | -14.8 | -7.4 | 0.0 | 11.1 | 23.4 |
| 90 | -16.6 | -8.4 | 0.0 | 12.3 | 25.9 |
| 100 | -18.4 | -9.3 | 0.0 | 13.5 | 28.4 |
| 110 | -20.3 | -10.3 | 0.0 | 14.6 | 30.7 |

Descent at VREF30 + 70

| PRESSURE ALTITUDE (1000 FT) | 5 | 10 | 15 | 17 | 19 | 21 | 23 | 25 | 27 | 29 | 31 | 33 | 35 |
|-----------------------------|----|----|----|----|----|----|----|----|----|----|----|----|----|
| DISTANCE (NM) | 16 | 26 | 36 | 40 | 44 | 48 | 52 | 56 | 60 | 64 | 67 | 71 | 74 |
| TIME (MINUTES) | 7 | 10 | 12 | 13 | 14 | 15 | 16 | 16 | 17 | 18 | 19 | 19 | 20 |

GEAR DOWN

**Holding
Flaps Up**

| WEIGHT (1000 LB) | | PRESSURE ALTITUDE (FT) | | | | | | |
|---------------------|--------|------------------------|-------|-------|-------|-------|-------|-------|
| | | 1500 | 5000 | 10000 | 15000 | 20000 | 25000 | 30000 |
| 420 | %N1 | 83.2 | 86.0 | 90.2 | 94.7 | 100.1 | | |
| | KIAS | 249 | 249 | 249 | 249 | 249 | | |
| | FF/ENG | 10410 | 10380 | 10420 | 10590 | 11030 | | |
| 400 | %N1 | 81.5 | 84.4 | 88.6 | 93.0 | 98.2 | | |
| | KIAS | 242 | 242 | 242 | 242 | 242 | | |
| | FF/ENG | 9860 | 9810 | 9830 | 9950 | 10280 | | |
| 380 | %N1 | 79.8 | 82.9 | 87.1 | 91.4 | 96.4 | | |
| | KIAS | 236 | 236 | 236 | 236 | 236 | | |
| | FF/ENG | 9360 | 9300 | 9290 | 9370 | 9620 | | |
| 360 | %N1 | 78.1 | 81.3 | 85.4 | 89.7 | 94.5 | 100.5 | |
| | KIAS | 229 | 229 | 229 | 229 | 229 | 229 | |
| | FF/ENG | 8830 | 8770 | 8720 | 8780 | 8960 | 9420 | |
| 340 | %N1 | 76.2 | 79.2 | 83.5 | 87.8 | 92.4 | 98.0 | |
| | KIAS | 221 | 221 | 221 | 221 | 221 | 221 | |
| | FF/ENG | 8280 | 8220 | 8150 | 8180 | 8310 | 8640 | |
| 320 | %N1 | 74.5 | 77.4 | 81.8 | 86.1 | 90.5 | 95.7 | 104.1 |
| | KIAS | 215 | 215 | 215 | 215 | 215 | 215 | 215 |
| | FF/ENG | 7790 | 7730 | 7660 | 7650 | 7740 | 7980 | 8610 |
| 300 | %N1 | 72.8 | 75.7 | 80.2 | 84.4 | 88.8 | 93.8 | 100.6 |
| | KIAS | 210 | 210 | 210 | 210 | 210 | 210 | 210 |
| | FF/ENG | 7360 | 7300 | 7220 | 7190 | 7250 | 7430 | 7890 |
| 280 | %N1 | 70.9 | 74.0 | 78.3 | 82.6 | 87.0 | 91.8 | 97.7 |
| | KIAS | 205 | 205 | 205 | 205 | 205 | 205 | 205 |
| | FF/ENG | 6940 | 6870 | 6790 | 6740 | 6770 | 6890 | 7230 |
| 260 | %N1 | 69.0 | 72.2 | 76.4 | 80.8 | 85.2 | 89.7 | 95.2 |
| | KIAS | 200 | 200 | 200 | 200 | 200 | 200 | 200 |
| | FF/ENG | 6520 | 6450 | 6370 | 6300 | 6310 | 6390 | 6630 |
| 240 | %N1 | 67.0 | 70.0 | 74.4 | 79.0 | 83.3 | 87.7 | 92.8 |
| | KIAS | 194 | 194 | 194 | 194 | 194 | 194 | 194 |
| | FF/ENG | 6110 | 6040 | 5950 | 5880 | 5860 | 5910 | 6070 |
| 220 | %N1 | 65.1 | 67.9 | 72.5 | 76.8 | 81.2 | 85.6 | 90.4 |
| | KIAS | 189 | 189 | 189 | 189 | 189 | 189 | 189 |
| | FF/ENG | 5710 | 5640 | 5550 | 5470 | 5430 | 5450 | 5550 |

Performance Inflight - Gear Down, Engine Inop

Chapter PI Section 15

GEAR DOWN

ENGINE INOP

MAX CONTINUOUS THRUST

Driftdown Speed/Level Off Altitude

100 ft/min residual rate of climb

| WEIGHT (1000 LB) | | OPTIMUM DRIFTDOWN SPEED (KIAS) | LEVEL OFF ALTITUDE (FT) | | |
|------------------------|--------------|---|-------------------------|------------|------------|
| START DRIFT DOWN | LEVEL OFF | | ISA + 10°C & BELOW | ISA + 15°C | ISA + 20°C |
| 380 | 363 | 233 | 4900 | 3100 | |
| 360 | 345 | 226 | 7400 | 5700 | 3700 |
| 340 | 326 | 218 | 9700 | 8200 | 6400 |
| 320 | 307 | 213 | 11700 | 10500 | 8900 |
| 300 | 288 | 208 | 13600 | 12800 | 11200 |
| 280 | 270 | 203 | 15500 | 15100 | 13800 |
| 260 | 250 | 198 | 17100 | 17000 | 16100 |
| 240 | 231 | 193 | 19100 | 19000 | 18400 |
| 220 | 212 | 187 | 21000 | 20900 | 20400 |

Includes APU fuel burn.

Long Range Cruise Altitude Capability

100 ft/min residual rate of climb

| WEIGHT (1000 LB) | PRESSURE ALTITUDE (FT) | | |
|---------------------|------------------------|------------|------------|
| | ISA + 10°C & BELOW | ISA + 15°C | ISA + 20°C |
| 370 | 1800 | | |
| 360 | 3300 | | |
| 350 | 4700 | 2100 | |
| 340 | 6100 | 3600 | |
| 330 | 7500 | 5100 | 2600 |
| 320 | 8800 | 6700 | 4100 |
| 310 | 10100 | 8200 | 5700 |
| 300 | 11400 | 9600 | 7400 |
| 290 | 12700 | 11200 | 9000 |
| 280 | 14000 | 12800 | 10600 |
| 270 | 15200 | 14500 | 12400 |
| 260 | 16100 | 15800 | 14200 |
| 250 | 17100 | 17000 | 15800 |
| 240 | 18200 | 18100 | 17400 |
| 230 | 19300 | 19200 | 18500 |
| 220 | 20300 | 20200 | 19700 |

With engine anti-ice on, decrease altitude capability by 1200 ft.

With engine and wing anti-ice on, decrease altitude capability by 2500 ft.

GEAR DOWN

ENGINE INOP

MAX CONTINUOUS THRUST

Long Range Cruise Control

| WEIGHT (1000 LB) | | PRESSURE ALTITUDE (1000 FT) | | | | | | | |
|---------------------|--------|-----------------------------|-------|-------|-------|-------|-------|-------|-------|
| | | 6 | 8 | 10 | 12 | 14 | 16 | 18 | 20 |
| 340 | %N1 | 102.0 | 104.2 | | | | | | |
| | MACH | .393 | .404 | | | | | | |
| | KIAS | 234 | 231 | | | | | | |
| | FF/ENG | 16362 | 16453 | | | | | | |
| 320 | %N1 | 99.8 | 101.8 | 104.2 | | | | | |
| | MACH | .384 | .395 | .406 | | | | | |
| | KIAS | 228 | 226 | 224 | | | | | |
| | FF/ENG | 15297 | 15345 | 15441 | | | | | |
| 300 | %N1 | 97.7 | 99.6 | 101.6 | 104.1 | | | | |
| | MACH | .374 | .386 | .397 | .408 | | | | |
| | KIAS | 222 | 221 | 219 | 217 | | | | |
| | FF/ENG | 14271 | 14281 | 14327 | 14419 | | | | |
| 280 | %N1 | 95.5 | 97.3 | 99.2 | 101.3 | 103.8 | | | |
| | MACH | .364 | .375 | .387 | .398 | .409 | | | |
| | KIAS | 216 | 215 | 214 | 212 | 209 | | | |
| | FF/ENG | 13262 | 13254 | 13268 | 13307 | 13398 | | | |
| 260 | %N1 | 93.2 | 94.9 | 96.7 | 98.6 | 100.8 | 103.4 | | |
| | MACH | .353 | .364 | .376 | .388 | .399 | .410 | | |
| | KIAS | 209 | 208 | 207 | 206 | 204 | 202 | | |
| | FF/ENG | 12280 | 12250 | 12244 | 12256 | 12287 | 12388 | | |
| 240 | %N1 | 90.9 | 92.5 | 94.2 | 96.0 | 97.9 | 100.1 | 102.9 | |
| | MACH | .341 | .352 | .364 | .376 | .388 | .399 | .412 | |
| | KIAS | 202 | 201 | 200 | 199 | 198 | 196 | 194 | |
| | FF/ENG | 11318 | 11274 | 11245 | 11241 | 11247 | 11277 | 11435 | |
| 220 | %N1 | 88.3 | 90.0 | 91.6 | 93.3 | 95.1 | 97.0 | 99.4 | 102.7 |
| | MACH | .328 | .339 | .350 | .362 | .374 | .387 | .400 | .416 |
| | KIAS | 194 | 194 | 193 | 192 | 191 | 190 | 189 | 189 |
| | FF/ENG | 10333 | 10314 | 10276 | 10249 | 10244 | 10247 | 10337 | 10638 |

GEAR DOWN

ENGINE INOP

MAX CONTINUOUS THRUST

**Long Range Cruise Diversion Fuel and Time
 Ground to Air Miles Conversion**

| AIR DISTANCE (NM) | | | | | GROUND DISTANCE (NM) | AIR DISTANCE (NM) | | | | |
|--------------------------|------|------|------|------|----------------------|--------------------------|-----|-----|-----|-----|
| HEADWIND COMPONENT (KTS) | | | | | | TAILWIND COMPONENT (KTS) | | | | |
| 100 | 80 | 60 | 40 | 20 | 20 | 40 | 60 | 80 | 100 | |
| 165 | 147 | 131 | 119 | 109 | 100 | 93 | 88 | 83 | 78 | 75 |
| 337 | 298 | 264 | 239 | 218 | 200 | 187 | 175 | 165 | 156 | 148 |
| 509 | 450 | 399 | 359 | 328 | 300 | 280 | 262 | 246 | 233 | 221 |
| 683 | 602 | 534 | 480 | 437 | 400 | 374 | 350 | 329 | 310 | 294 |
| 858 | 756 | 669 | 601 | 547 | 500 | 467 | 437 | 410 | 387 | 367 |
| 1034 | 910 | 805 | 723 | 657 | 600 | 560 | 524 | 491 | 463 | 439 |
| 1211 | 1064 | 940 | 844 | 767 | 700 | 653 | 610 | 573 | 540 | 512 |
| 1389 | 1220 | 1076 | 965 | 877 | 800 | 746 | 697 | 654 | 616 | 584 |
| 1569 | 1377 | 1214 | 1088 | 987 | 900 | 839 | 784 | 735 | 693 | 657 |
| 1749 | 1534 | 1351 | 1210 | 1097 | 1000 | 932 | 871 | 817 | 769 | 729 |

Reference Fuel and Time Required at Check Point

| AIR DIST (NM) | PRESSURE ALTITUDE (1000 FT) | | | | | | | |
|---------------|-----------------------------|---------------|----------------|---------------|----------------|---------------|----------------|---------------|
| | 6 | | 10 | | 14 | | 18 | |
| | FUEL (1000 LB) | TIME (HR:MIN) | FUEL (1000 LB) | TIME (HR:MIN) | FUEL (1000 LB) | TIME (HR:MIN) | FUEL (1000 LB) | TIME (HR:MIN) |
| 100 | 5.3 | 0:28 | 4.8 | 0:27 | 4.3 | 0:26 | 3.9 | 0:26 |
| 200 | 11.2 | 0:53 | 10.4 | 0:51 | 9.8 | 0:49 | 9.5 | 0:48 |
| 300 | 17.0 | 1:18 | 15.9 | 1:15 | 15.2 | 1:12 | 14.9 | 1:10 |
| 400 | 22.7 | 1:43 | 21.4 | 1:39 | 20.5 | 1:36 | 20.3 | 1:32 |
| 500 | 28.4 | 2:09 | 26.8 | 2:04 | 25.8 | 1:59 | 25.5 | 1:55 |
| 600 | 34.0 | 2:35 | 32.1 | 2:28 | 30.9 | 2:23 | 30.7 | 2:17 |
| 700 | 39.5 | 3:01 | 37.4 | 2:53 | 36.0 | 2:47 | 35.7 | 2:40 |
| 800 | 44.9 | 3:27 | 42.6 | 3:18 | 41.0 | 3:10 | 40.7 | 3:03 |
| 900 | 50.3 | 3:54 | 47.7 | 3:43 | 45.9 | 3:34 | 45.5 | 3:26 |
| 1000 | 55.6 | 4:21 | 52.7 | 4:09 | 50.7 | 3:59 | 50.3 | 3:49 |

Fuel Required Adjustment (1000 LB)

| REFERENCE FUEL REQUIRED (1000 LB) | WEIGHT AT CHECK POINT (1000 LB) | | | | |
|-----------------------------------|---------------------------------|------|-----|------|------|
| | 200 | 250 | 300 | 350 | 400 |
| 5 | -0.9 | -0.5 | 0.0 | 0.7 | 1.5 |
| 10 | -2.0 | -1.0 | 0.0 | 1.6 | 3.2 |
| 15 | -3.1 | -1.5 | 0.0 | 2.4 | 4.9 |
| 20 | -4.1 | -2.0 | 0.0 | 3.3 | 6.6 |
| 25 | -5.2 | -2.5 | 0.0 | 4.1 | 8.3 |
| 30 | -6.2 | -3.1 | 0.0 | 5.0 | 10.1 |
| 35 | -7.3 | -3.6 | 0.0 | 5.8 | 11.8 |
| 40 | -8.3 | -4.1 | 0.0 | 6.6 | 13.5 |
| 45 | -9.4 | -4.6 | 0.0 | 7.5 | 15.1 |
| 50 | -10.4 | -5.2 | 0.0 | 8.3 | 16.8 |
| 55 | -11.5 | -5.7 | 0.0 | 9.1 | 18.5 |
| 60 | -12.5 | -6.2 | 0.0 | 10.0 | 20.2 |
| 65 | -13.6 | -6.8 | 0.0 | 10.8 | 21.9 |
| 70 | -14.6 | -7.3 | 0.0 | 11.6 | 23.5 |

Includes APU fuel burn.

GEAR DOWN

ENGINE INOP

MAX CONTINUOUS THRUST

**Holding
Flaps Up**

| WEIGHT (1000 LB) | | PRESSURE ALTITUDE (FT) | | | | |
|---------------------|--------|------------------------|-------|-------|-------|-------|
| | | 1500 | 5000 | 10000 | 15000 | 20000 |
| 400 | %N1 | 101.6 | | | | |
| | KIAS | 242 | | | | |
| | FF/ENG | 19390 | | | | |
| 380 | %N1 | 99.7 | | | | |
| | KIAS | 236 | | | | |
| | FF/ENG | 18220 | | | | |
| 360 | %N1 | 97.6 | 101.3 | | | |
| | KIAS | 229 | 229 | | | |
| | FF/ENG | 17050 | 17320 | | | |
| 340 | %N1 | 95.5 | 98.9 | | | |
| | KIAS | 221 | 221 | | | |
| | FF/ENG | 15860 | 16020 | | | |
| 320 | %N1 | 93.5 | 96.7 | 102.4 | | |
| | KIAS | 215 | 215 | 215 | | |
| | FF/ENG | 14830 | 14940 | 15390 | | |
| 300 | %N1 | 91.7 | 94.8 | 100.0 | | |
| | KIAS | 210 | 210 | 210 | | |
| | FF/ENG | 13920 | 13990 | 14290 | | |
| 280 | %N1 | 89.8 | 92.8 | 97.7 | 104.6 | |
| | KIAS | 205 | 205 | 205 | 205 | |
| | FF/ENG | 13020 | 13070 | 13260 | 13890 | |
| 260 | %N1 | 87.8 | 90.8 | 95.4 | 101.3 | |
| | KIAS | 200 | 200 | 200 | 200 | |
| | FF/ENG | 12150 | 12180 | 12300 | 12690 | |
| 240 | %N1 | 85.7 | 88.6 | 93.1 | 98.4 | |
| | KIAS | 194 | 194 | 194 | 194 | |
| | FF/ENG | 11280 | 11290 | 11360 | 11600 | |
| 220 | %N1 | 83.4 | 86.4 | 90.8 | 95.7 | 102.7 |
| | KIAS | 189 | 189 | 189 | 189 | 189 |
| | FF/ENG | 10450 | 10440 | 10480 | 10630 | 11170 |

This table includes 5% additional fuel for holding in a racetrack pattern.

**Performance Inflight -
Text****Chapter PI
Section 16**

Introduction

This chapter contains information to supplement performance data from the Flight Management Computer (FMC). In addition, sufficient inflight data is provided to complete a flight with the FMC inoperative. In the event of conflict between data presented in this chapter and that contained in the approved Airplane Flight Manual, the Flight Manual shall always take precedence.

Takeoff Speeds

The speeds presented in the Takeoff Speeds table can be used for all performance conditions except where adjustments must be made to V1 for clearway, stopway, anti-skid inoperative, brakes deactivated, improved climb, contaminated runway situations, brake energy limits, or obstacle clearance with unbalanced V1. These speeds may be used for weights less than or equal to the performance limited weight.

Normal takeoff speeds, V1, VR, and V2, with anti-skid on and all brakes operative, are read from the table by entering with takeoff flap setting, brake release weight and appropriate column. The appropriate column is obtained by entering the Column Reference chart with the airport pressure altitude and the actual temperature or assumed temperature for reduced thrust takeoffs. Slope and wind adjustments to V1 are obtained by entering the V1 Adjustment chart. Adjusted V1 must not exceed VR. These takeoff speeds are not valid when the brake release weight is based on clearway, stopway, improved climb or is limited by tire speed or brake energy.

V1(MCG)

Regulations prohibit scheduling takeoff with a V1 less than minimum V1 for control on the ground, V1(MCG). Therefore compare the adjusted V1 to the V1(MCG). To find V1(MCG) enter the V1(MCG) table with the airport pressure altitude and actual OAT. If the adjusted V1 is less than V1(MCG), set V1 equal to V1(MCG). If VR is less than V1(MCG), set VR equal to V1(MCG), and determine a new V2 by adding the difference between the normal VR and V1(MCG) to the normal V2. No takeoff weight adjustment is necessary provided that the actual field length exceeds the minimum field length.

Clearway and Stopway V1 Adjustments

Takeoff speed adjustments are to be applied to V1 speed when using takeoff weights based on the use of clearway and stopway.

Adjust V1 speed by the amount shown in the table. The adjusted V1 speed must not exceed VR.

Maximum allowable clearway limits are provided for guidance when more precise data is not available.

Stab Trim

To find takeoff stabilizer trim setting, enter Stab Trim Setting table with anticipated brake release weight and center of gravity (C.G. % MAC) and read required stabilizer trim units.

VREF

This table contains flaps 30, 25 and 20 reference speeds for a given weight.

Flap Maneuver Speeds

This table provides the flap speed schedule for recommended maneuver speeds. Using VREF as the basis for the schedule makes it variable as a function of weight and will provide adequate maneuver margin above stall at all weights.

During flap retraction/extension, movement of the flap to the next position should be initiated when within 20 knots of the recommended speed for that position.

Slush/Standing Water Takeoff

Experience has shown that aircraft performance may deteriorate significantly on runways covered with snow, slush, standing water or ice. Therefore, reductions in runway/obstacle limited takeoff weight and revised takeoff speeds are necessary. The tables are intended for guidance in accordance with advisory material and assumes an engine failure at the critical point during the takeoff.

The entire runway is assumed to be completely covered by a contaminant of uniform thickness and density. Therefore this information is conservative when operating under typical colder weather conditions where patches of slush exist and some degree of sanding is common. Takeoffs in slush depths greater than 0.5 inches (13 mm) are not recommended because of possible airplane damage as a result of slush impingement on the airplane structure. The use of assumed temperature for reduced thrust is not allowed on contaminated runways. Interpolation for slush/standing water depths between the values shown is permitted.

Takeoff weight is determined as follows:

1. Determine the field/obstacle limit weight for the takeoff flap setting.
2. Enter the Weight Adjustment table with the field/obstacle limit weight to obtain the weight reduction for the slush/standing water depth and airport pressure altitude.
3. Adjust field length available for temperature by amount shown on chart.
4. Enter the V1(MCG) Limit Weight table with the adjusted field length and pressure altitude to obtain the slush/standing water limit weight with respect to minimum field length required for V1(MCG) speed.

The maximum allowable takeoff weight in slush/standing water is the lesser of the limit weights found in steps 2 and 4.

Takeoff speed determination:

1. Determine takeoff speeds V1, VR and V2 for actual brake release weight using the Takeoff Speeds table in this section.
2. If V1(MCG) limited, set $V1=V1(MCG)$. If not limited by V1(MCG) considerations, enter the V1 Adjustment table with actual brake release weight to determine the V1 reduction to apply to V1 speed. If the adjusted V1 is less than V1(MCG), set $V1=V1(MCG)$.

Slippery Runway Takeoff

Airplane braking action is reported as good, medium or poor, depending on existing runway conditions. If braking action is reported as good, conditions should not be expected to be as good as on clean, dry runways. The value “good” is comparative and is intended to mean that airplanes should not experience braking or directional control difficulties when stopping. Good reported braking action denotes wet runway conditions or runways covered by compact snow. Similarly, poor braking action denotes runways covered with wet ice. Performance is based on reversers operating and a 15 ft. screen height at the end of the runway. The tables provided are used in the same manner as the Slush/Standing Water tables.

Anti-Skid Inoperative

When operating with anti-skid inoperative, the field limit weight and V1 must be reduced to account for the effect on accelerate-stop performance. A simplified method which conservatively accounts for the effects of anti-

skid inoperative is to reduce the normal runway/obstacle limited weight and the V1 associated with the reduced weight by the amount shown in the table below.

| ANTI-SKID INOPERATIVE ADJUSTMENT | | |
|----------------------------------|------------------|---------------------|
| FIELD LENGTH (FT) | WEIGHT (1000 LB) | V1 ADJUSTMENT (KTS) |
| 6000 | -102.6 | -44 |
| 7000 | -102.6 | -42 |
| 8000 | -102.6 | -39 |
| 9000 | -83.5 | -37 |
| 10000 | -59.6 | -34 |
| 12000 | -50.0 | -31 |
| 14000 | -50.0 | -29 |

If the resulting V1 is less than V1(MCG), takeoff is permitted with V1 set equal to V1(MCG) provided the accelerate-stop distance adjusted for wind and slope exceeds approximately 8200 ft.

Detailed analysis for the specific case from the Airplane Flight Manual may yield a less restrictive penalty.

Brakes Deactivated

When operating with brakes deactivated, the field and brake energy limit weights and the V1 and VMBE must be reduced to allow for reduced braking capability. A simplified method which conservatively accounts for the reduced braking capability of one brake deactivated is to reduce the normal runway/obstacle limited weight by 7000 lb and the V1 associated with the reduced weight by the amount shown in the table below.

| ONE BRAKE DEACTIVATED SPEED ADJUSTMENT | |
|--|---------------------|
| FIELD LENGTH (FT) | V1 ADJUSTMENT (KTS) |
| 4000 | -2 |
| 6000 | -2 |
| 8000 | -2 |
| 10000 | -2 |
| 12000 | -2 |
| 14000 | -2 |

If the resulting V1 is less than V1(MCG), takeoff is permitted with V1 set equal to V1(MCG) provided the accelerate-stop distance exceeds approximately 3800 ft for one brake deactivated.

Takeoff %N1

To find Max Takeoff %N1 based on normal engine bleed for air conditioning packs on, enter Takeoff %N1 table with airport pressure altitude and airport OAT and read %N1. %N1 adjustments are shown for packs off operation.

Assumed Temperature Reduced Thrust

Regulations permit the use of up to 25% takeoff thrust reduction for operation with assumed temperature reduced thrust. Use of reduced thrust is not allowed on runways contaminated with water, ice, slush or snow. Use of assumed temperature reduced thrust is not recommended if potential windshear conditions exist.

Enter the Minimum Assumed Temperature table with airport pressure altitude and read minimum assumed temperature. If assumed temperature is below this value, use the Takeoff %N1 table to set takeoff thrust. To find assumed temperature reduced thrust, obtain the assumed temperature %N1 by entering the Assumed Temperature Limit %N1 table with actual airport temperature and assumed temperature and apply the altitude adjustment shown in the %N1 Altitude Adjustment table. Check this value by entering the Minimum Assumed Temperature Limit %N1 table with actual airport temperature and pressure altitude. Use the greater of assumed temperature limit %N1 or minimum %N1 as the assumed temperature reduced thrust %N1. If limited by %N1, re-enter the Assumed Temperature Limit %N1 table to estimate the new assumed temperature corresponding to the minimum %N1. Determine takeoff speeds using the actual takeoff weight and assumed temperature.

Max Climb %N1

This table shows Max Climb %N1 for a 250/290/.78 climb speed schedule, normal engine bleed for packs on and anti-ice off. Enter the table with airport pressure altitude and TAT and read %N1. %N1 adjustments are shown for packs off and anti-ice operation.

Go-around %N1

To find Max Go-around %N1 based on normal engine bleed for packs on, enter the Go-around %N1 table with airport pressure altitude and reported OAT or TAT and read %N1. %N1 adjustments are shown for packs off and anti-ice operation.

Flight with Unreliable Airspeed / Turbulent Air Penetration

Pitch attitude and average %N1 information is provided for use in all phases of flight in the event of unreliable airspeed/Mach indications resulting from blocking or freezing of the pitot system. Loss of radome or turbulent air may also cause unreliable airspeed/Mach indications. The cruise table in this section may also be used for turbulent air penetration.

Pitch attitude is shown in bold type for emphasis since altitude and/or vertical speed indications may also be unreliable.

All Engines

Long Range Cruise Maximum Operating Altitude

These tables provide the maximum operating altitude in the same manner as the FMC. Maximum altitudes are shown for a given cruise weight and maneuver capability. Note that these tables consider both thrust and buffet limits, providing the more limiting of the two. Any data that is thrust limited is denoted by an asterisk and represents only a thrust limited condition in level flight with maximum cruise thrust at 0 ft/min residual rate of climb or maximum climb thrust at 100 ft/min residual rate of climb. Flying above these altitudes with sustained banks in excess of approximately 12° may cause the airplane to lose speed and/or altitude.

Note that optimum altitudes shown in the tables result in buffet related maneuver margins of 1.5g (48° bank) or more. The altitudes shown in the table are limited to the maximum certified altitude of 43100 ft.

Long Range Cruise Control

These tables provide target %N1, Long Range Cruise Mach number, IAS and standard day fuel flow per engine for the airplane weight and pressure altitude. As indicated by the shaded area, at optimum altitude .80M approximates the Long Range Cruise Mach schedule.

APU Operation During Flight

For APU operation during flight, increase fuel flow according to the table in the Engine Inoperative text section.

Long Range Cruise Enroute Fuel and Time

Long Range Cruise Enroute Fuel and Time tables are provided to determine remaining time and fuel required to destination. The data is based on Long Range Cruise and .78/290/250 descent. Tables are presented for low altitudes and high altitudes.

To determine remaining fuel and time required, first enter the Ground to Air Miles Conversion table to convert ground distance and enroute wind to an equivalent still air distance for use with the Reference Fuel and Time tables. Next, enter the Reference Fuel and Time table with air distance from the Ground to Air Miles Conversion table and the desired altitude and read Reference Fuel and Time Required. Lastly, enter the Fuel Required Adjustment Table with the Reference Fuel and the actual weight at checkpoint to obtain fuel required to destination.

Long Range Cruise Wind-Altitude Trade

Wind is a factor which may justify operations considerably below optimum altitude. For example, a favorable wind component may have an effect on ground speed which more than compensates for the loss in air range.

Using this table, it is possible to determine the break-even wind (advantage necessary or disadvantage that can be tolerated) to maintain the same range at another altitude and long range cruise speed. The table makes no allowance for climb or descent time, fuel or distance, and are based on comparing ground fuel mileage.

Descent

Distance and time for descent are shown for a .78/290/250 descent speed schedule. Enter the table with top of descent pressure altitude and read distance in nautical miles and time in minutes. Data is based on flight idle thrust descent in zero wind. Allowances are included for a straight-in approach with gear down and landing flaps at the outer marker.

Holding

Target %N1, indicated airspeed and fuel flow per engine information is tabulated for holding with flaps up based on the FMC optimum holding speed schedule. This is the higher of the maximum endurance speed and the maneuvering speed. Small variations in airspeed will not appreciably affect the overall endurance time. Enter the table with weight and pressure altitude to read %N1, IAS and fuel flow per engine.

Advisory Information

Normal Configuration Landing Distance

Tables are provided as advisory information for normal configuration landing distances on dry runways and slippery runways with good, medium, and poor reported braking action. These values are actual landing distances and do not include the 1.67 regulatory factor. Therefore, they cannot be used to determine the dispatch required landing field length.

To use these tables, determine the reference landing distance for the selected braking configuration. Then adjust the reference distance for landing weight, altitude, wind, slope, temperature, approach speed, and the number of operative thrust reversers to obtain the actual landing distance.

When landing on slippery runways or runways contaminated with ice, snow, slush, or standing water, the reported braking action must be considered. If the surface is affected by water, snow, or ice, and the braking action is reported as "good", conditions should not be expected to

be as good as on clean, dry runways. The value "good" is comparative and is intended to mean that airplanes should not experience braking or directional control difficulties when landing. The performance level used to calculate the "good" data is consistent with wet runway testing done on early Boeing jets. The performance level used to calculate "poor" data reflects runways covered with wet ice.

Use of the autobrake system commands the airplane to a constant deceleration rate. In some conditions, such as a runway with "poor" braking action, the airplane may not be able to achieve these deceleration rates. In these cases, runway slope and inoperative reversers influence the stopping distance. Since it cannot be determined quickly when this becomes a factor, it is appropriate to add the effects of slope and inoperative reversers when using the autobrake system.

Non-normal Configuration Landing Distance

Advisory information is provided to support non-normal configurations that affect the landing performance of the airplane. Landing distances and adjustments are provided for dry runways and runways with good, medium, and poor reported braking action.

Enter the table with the applicable non-normal configuration and read the normal approach speed. The reference landing distance is a reference distance from 50 ft above the threshold to stop based on a reference landing weight and speed at sea level, zero wind, and zero slope. Subsequent columns provide adjustments for off-reference landing weight, altitude, wind, slope, temperature, and speed conditions as well as thrust reverser configuration. Each adjustment is independently added to the reference landing distance. Landing distance includes the effects of max manual braking and reverse thrust.

Recommended Brake Cooling Schedule

Advisory information is provided to assist in avoiding the problems associated with hot brakes. For normal operation, most landings are at weights below the AFM quick turnaround limit weight.

Use of the recommended cooling schedule will help avoid brake overheat and fuse plug problems that could result from repeated landing at short time intervals or a rejected takeoff.

Enter the Recommended Brake Cooling Schedule table with the airplane weight, the brakes on speed adjusted for wind and the appropriate temperature and altitude condition. Instructions for applying wind adjustments are included below the table. Linear interpolation may be used

to obtain intermediate values. The resulting number is the reference brake energy per brake in millions of foot-pounds, and represents the amount of energy absorbed by each brake during a rejected takeoff.

To determine the energy per brake absorbed during landing, enter the appropriate Adjusted Brake Energy Per Brake table (No Reverse Thrust or 2 Engine Reverse Thrust) with the reference brake energy per brake and the type of braking used during landing (Max Manual, Max Auto, or Autobrake). The resulting number is the adjusted brake energy per brake and represents the energy absorbed in each brake during the landing.

The recommended cooling time is found in the final table by entering with the adjusted brake energy per brake or brake temperature monitor system (BTMS) indication on EICAS. Times are provided for ground cooling and inflight gear down cooling.

If brake temperature monitor indication on EICAS is available, the hottest brake indication 10 to 15 minutes after the airplane has come to a complete stop, or inflight with gear retracted, may be used to determine the recommended cooling schedule by entering at the bottom of the chart. The brake temperature light illuminates when the hottest brake is registering 5 on the EICAS indication and extinguishes as the hottest brake cools with an EICAS indication of 4.

Engine Inoperative

Initial Max Continuous %N1

The Initial Max Continuous %N1 setting for use following an engine failure is shown. The table is based on the typical all engine cruise speed of .80M to provide a target %N1 setting at the start of driftdown. Once driftdown is established, the Max Continuous %N1 table should be used to determine %N1 for the given conditions.

Max Continuous %N1

Power setting is based on one engine operating with packs on or off and all anti-ice bleeds off. Enter the table with pressure altitude and IAS or Mach to read %N1.

It is desirable to maintain engine thrust level within the limits of the Max Cruise Thrust rating. However, where thrust level in excess of Max Cruise rating is required, such as for meeting terrain clearance, ATC altitude assignments, or to attain maximum range capability, it is permissible to use the thrust needed up to the Max Continuous Thrust rating. The Max

Continuous Thrust rating is intended primarily for emergency use at the discretion of the pilot and is the maximum thrust that may be used continuously.

Driftdown Speed/Level Off Altitude

The table shows optimum driftdown speed as a function of cruise weight at start of driftdown. Also shown are the approximate weight and pressure altitude at which the airplane will level off considering 100 ft/min residual rate of climb.

The level off altitude is dependent on air temperature (ISA deviation).

Driftdown/LRC Range Capability

This table shows the range capability from the start of driftdown. Driftdown is continued to level off altitude. As weight decreases due to fuel burn, the airplane is accelerated to Long Range Cruise speed. The cruise segment is at a level off altitude which is based on 100 ft/min residual rate of climb.

To determine fuel required, enter the Ground to Air Miles Conversion table with the desired ground distance and adjust for anticipated winds to obtain air distance to destination. Then enter the Driftdown/Cruise Fuel and Time table with air distance and weight at start of driftdown to determine fuel and time required. If altitudes other than the level off altitude are used, fuel and time required may be obtained by using the Engine Inoperative Long Range Cruise Enroute Fuel and Time table.

Long Range Cruise Altitude Capability

The table shows the maximum altitude that can be maintained at a given weight and air temperature (ISA deviation), based on Long Range Cruise speed, Max Continuous thrust, and 100 ft/min residual rate of climb.

Long Range Cruise Control

The table provides target %N1, engine inoperative Long Range Cruise Mach number, IAS and fuel flow for the airplane weight and pressure altitude. The fuel flow values in this table reflect single engine fuel burn.

APU Operation During Flight

For APU operation during flight, increase fuel flow according to the following table. These increments include the APU fuel flow and the effect of increased drag from the APU door.

| PRESSURE ALTITUDE (1000 FT) | APU FUEL FLOW PENALTY (LB/HR) | | | | | |
|-----------------------------------|-------------------------------|-----|-----|-----|-----|-----|
| | GROSS WEIGHT (1000 LB) | | | | | |
| | 420 | 380 | 340 | 300 | 260 | 220 |
| 43 | | | | | 135 | 125 |
| 39 | | | | 140 | 135 | 130 |
| 35 | | 160 | 155 | 150 | 145 | 140 |
| 31 | 170 | 165 | 165 | 160 | 155 | 150 |
| 27 | 185 | 180 | 175 | 170 | 165 | 155 |
| 25 | 190 | 185 | 180 | 180 | 165 | 160 |
| 20 | 205 | 200 | 195 | 185 | 175 | 170 |
| 15 | 235 | 225 | 215 | 205 | 200 | 195 |
| 10 | 255 | 250 | 240 | 230 | 225 | 215 |
| 5 | 275 | 275 | 260 | 255 | 250 | 245 |

Long Range Cruise Diversion Fuel and Time

Tables are provided for crews to determine the fuel and time required to proceed to an alternate airfield with one engine inoperative. The data is based on single engine Long Range Cruise speed and .78/290/250 descent. Enter with Air Distance as determined from the Ground to Air Miles Conversion table and read Fuel and Time required at the cruise pressure altitude. Adjust the fuel obtained for deviation from the reference weight at checkpoint as required by entering the Fuel Required Adjustment table with the fuel required for the reference weight and the actual weight at checkpoint. Read fuel and time required for the actual weight.

Holding

Single engine holding data is provided in the same format as the all engine holding data and is based on the same assumptions.

Gear Down

This section contains performance for airplane operation with the landing gear extended for all phases of flight. The data is based on engine bleeds for normal air conditioning.

NOTE: The Flight Management Computer System (FMCS) does not contain special provisions for operation with landing gear extended. As a result, the FMCS will generate inaccurate enroute speed schedules, display non-conservative predictions of fuel burn, estimated time of arrival (ETA), maximum altitude, and compute overly shallow descent path. To obtain accurate ETA predictions, gear down cruise speed and altitude should be entered on the CLB and CRZ pages. Gear down cruise speed should also

be entered on the DES page and a STEP SIZE of zero should be entered on the PERF INIT or CRZ page. Use of the VNAV during descent under these circumstances is not recommended.

Tables for gear down performance in this section are identical in format and used in the same manner as tables for the gear up configuration previously described.

767-300 PW4060 LB FAA CATC CATD

General PI.20.1

- Takeoff Speeds PI.20.1
- V1(MCG) PI.20.2
- Clearway and Stopway V1 Adjustments PI.20.2
- Stab Trim Setting PI.20.3
- VREF (KIAS) PI.20.4
- Flap Maneuver Speeds PI.20.5
- Slush/Standing Water Takeoff PI.20.6
- Takeoff EPR PI.20.7
- Assumed Temperature Reduced Thrust PI.20.8
- Max Climb EPR PI.20.9
- Go-around EPR PI.20.10
- Flight With Unreliable Airspeed /
Turbulent Air Penetration PI.20.11

All Engine PI.21.1

- Long Range Cruise Maximum Operating Altitude PI.21.1
- Long Range Cruise Control PI.21.2
- Long Range Cruise Enroute Fuel and Time - Low
Altitudes PI.21.3
- Long Range Cruise Enroute Fuel and Time - High
Altitudes PI.21.4
- Long Range Cruise Wind-Altitude Trade PI.21.5
- Descent at .78/290/250 PI.21.5
- Holding PI.21.6

Advisory Information PI.22.1

- Normal Configuration Landing Distance PI.22.1
- Non-Normal Configuration Landing Distance PI.22.3
- Recommended Brake Cooling Schedule PI.22.11

| | |
|---|----------------|
| Engine Inoperative | PI.23.1 |
| Initial Max Continuous EPR | PI.23.1 |
| Max Continuous EPR | PI.23.2 |
| Driftdown Speed/Level Off Altitude | PI.23.4 |
| Driftdown/LRC Cruise Range Capability | PI.23.4 |
| Long Range Cruise Altitude Capability | PI.23.5 |
| Long Range Cruise Control | PI.23.6 |
| Long Range Cruise Diversion Fuel and Time | PI.23.7 |
| Holding | PI.23.8 |
| Alternate EEC Mode | PI.24.1 |
| Takeoff Performance | PI.24.1 |
| Takeoff Speeds Adjustment | PI.24.1 |
| Landing Performance | PI.24.1 |
| Takeoff EPR | PI.24.1 |
| Go-around EPR | PI.24.2 |
| Go-around %N1 | PI.24.3 |
| Alternate EEC Mode, Engine Inoperative | PI.24.4 |
| Initial Max Continuous %N1 | PI.24.4 |
| Max Continuous %N1 | PI.24.5 |
| Gear Down | PI.25.1 |
| 200 KIAS Max Climb EPR | PI.25.1 |
| Long Range Cruise Altitude Capability | PI.25.2 |
| Long Range Cruise Control | PI.25.3 |
| Long Range Cruise Enroute Fuel and Time | PI.25.4 |
| Descent at VREF30 + 70 | PI.25.4 |
| Holding | PI.25.5 |
| Gear Down, Engine Inoperative | PI.26.1 |
| Initial Max Continuous EPR | PI.26.1 |
| Driftdown Speed/Level Off Altitude | PI.26.2 |
| Long Range Cruise Altitude Capability | PI.26.2 |
| Long Range Cruise Control | PI.26.3 |
| Long Range Cruise Diversion Fuel and Time | PI.26.4 |
| Holding | PI.26.5 |

767 Flight Crew Operations Manual

| | |
|--|----------------|
| Text | PI.27.1 |
| Introduction | PI.27.1 |
| Takeoff Speeds | PI.27.1 |
| All Engines | PI.27.5 |
| Advisory Information | PI.27.6 |
| Engine Inoperative | PI.27.8 |
| Alternate EEC Mode | PI.27.10 |
| Alternate EEC Mode, Engine Inoperative | PI.27.12 |
| Gear Down | PI.27.12 |

Intentionally
Blank

**Performance Inflight -
General**

**Chapter PI
Section 20**

**Takeoff Speeds
Max Takeoff Thrust**

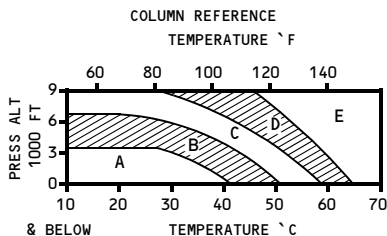

SLOPE/WIND V1 ADJUSTMENT*

| WEIGHT 1000 LB | SLOPE % | | | | WIND KTS | | | | | | HEAD | | |
|-------------------|---------|----|------|------|----------|----|----|----|----|----|------|---|---|
| | DN | UP | TAIL | TAIL | -5 | 0 | 10 | 20 | 30 | 40 | | | |
| 420 | -3 | -2 | 0 | 2 | -2 | -1 | 0 | 0 | 0 | 0 | 0 | 1 | 1 |
| 380 | -3 | -1 | 0 | 2 | -2 | -1 | 0 | 0 | 0 | 0 | 1 | 1 | 1 |
| 340 | -2 | -1 | 0 | 2 | 3 | -3 | -2 | -1 | 0 | 0 | 1 | 1 | 1 |
| 300 | -2 | -1 | 0 | 2 | 3 | -3 | -2 | -1 | 0 | 0 | 1 | 1 | 2 |
| 260 | -1 | -1 | 0 | 1 | 3 | -4 | -3 | -1 | 0 | 0 | 1 | 1 | 2 |
| 220 | -1 | 0 | 0 | 1 | 2 | -4 | -3 | -1 | 0 | 0 | 1 | 2 | 3 |

*V1 NOT TO EXCEED VR

| FLAPS | WT 1000 LB | A | | | B | | | C | | | D | | | E | | |
|-------|------------------|----------------|----------------|----------------|----------------|----------------|----------------|----------------|----------------|----------------|----------------|----------------|----------------|----------------|----------------|----------------|
| | | V ₁ | V _R | V ₂ | V ₁ | V _R | V ₂ | V ₁ | V _R | V ₂ | V ₁ | V _R | V ₂ | V ₁ | V _R | V ₂ |
| 5 | 420 | 166 | 171 | 176 | 169 | 172 | 176 | | | | | | | | | |
| | 400 | 161 | 166 | 171 | 164 | 167 | 172 | | | | | | | | | |
| | 380 | 156 | 161 | 167 | 159 | 162 | 167 | 161 | 164 | 168 | | | | | | |
| | 360 | 151 | 156 | 163 | 154 | 157 | 163 | 156 | 159 | 163 | | | | | | |
| | 340 | 145 | 151 | 158 | 148 | 152 | 158 | 150 | 154 | 158 | 154 | 155 | 159 | | | |
| | 320 | 139 | 145 | 153 | 142 | 147 | 153 | 145 | 148 | 153 | 148 | 150 | 154 | | | |
| | 300 | 133 | 140 | 149 | 136 | 141 | 148 | 139 | 143 | 148 | 143 | 144 | 148 | | | |
| | 280 | 127 | 134 | 144 | 130 | 135 | 143 | 133 | 137 | 143 | 136 | 139 | 143 | 145 | 146 | 149 |
| | 260 | 121 | 128 | 138 | 124 | 129 | 138 | 126 | 131 | 138 | 130 | 133 | 138 | 133 | 135 | 138 |
| | 240 | 114 | 121 | 133 | 117 | 123 | 133 | 120 | 125 | 133 | 123 | 127 | 133 | 126 | 129 | 133 |
| 220 | 108 | 114 | 127 | 110 | 116 | 127 | 113 | 118 | 127 | 116 | 120 | 127 | 119 | 122 | 127 | |
| 15 | 420 | 161 | 163 | 169 | 159 | 160 | 165 | | | | | | | | | |
| | 400 | 156 | 159 | 164 | 156 | 159 | 164 | | | | | | | | | |
| | 380 | 151 | 154 | 160 | 154 | 155 | 160 | | | | | | | | | |
| | 360 | 146 | 149 | 156 | 149 | 151 | 156 | 151 | 152 | 156 | | | | | | |
| | 340 | 140 | 144 | 152 | 143 | 146 | 152 | 146 | 147 | 152 | 143 | 144 | 147 | | | |
| | 320 | 135 | 139 | 147 | 138 | 141 | 147 | 140 | 142 | 147 | 138 | 138 | 142 | 140 | 140 | 143 |
| | 300 | 129 | 134 | 142 | 132 | 135 | 142 | 134 | 137 | 142 | 138 | 138 | 142 | 134 | 135 | 138 |
| | 280 | 124 | 128 | 138 | 126 | 130 | 138 | 128 | 131 | 137 | 132 | 133 | 137 | 128 | 129 | 133 |
| | 260 | 118 | 122 | 133 | 120 | 124 | 133 | 122 | 126 | 133 | 125 | 127 | 132 | 128 | 129 | 133 |
| | 240 | 112 | 116 | 128 | 114 | 118 | 127 | 116 | 120 | 127 | 119 | 121 | 127 | 122 | 123 | 127 |
| 220 | 105 | 110 | 122 | 107 | 111 | 122 | 109 | 113 | 122 | 112 | 115 | 122 | 115 | 117 | 122 | |
| 20 | 420 | 159 | 160 | 165 | | | | | | | | | | | | |
| | 400 | 153 | 154 | 160 | | | | | | | | | | | | |
| | 380 | 148 | 149 | 155 | 150 | 151 | 156 | 146 | 147 | 151 | | | | | | |
| | 360 | 143 | 144 | 151 | 145 | 145 | 151 | 141 | 142 | 147 | | | | | | |
| | 340 | 138 | 139 | 147 | 140 | 141 | 146 | 136 | 137 | 142 | 138 | 139 | 143 | | | |
| | 320 | 132 | 134 | 142 | 134 | 136 | 142 | 136 | 137 | 142 | 133 | 133 | 138 | | | |
| | 300 | 126 | 129 | 138 | 129 | 130 | 138 | 131 | 132 | 138 | 128 | 128 | 133 | 130 | 130 | 133 |
| | 280 | 120 | 123 | 133 | 123 | 125 | 133 | 125 | 127 | 133 | 128 | 128 | 133 | 130 | 130 | 133 |
| | 260 | 114 | 118 | 128 | 117 | 119 | 128 | 119 | 121 | 128 | 122 | 123 | 128 | 124 | 124 | 128 |
| | 240 | 108 | 112 | 123 | 110 | 114 | 123 | 113 | 115 | 123 | 116 | 117 | 123 | 119 | 119 | 123 |
| 220 | 101 | 106 | 118 | 104 | 107 | 118 | 107 | 109 | 118 | 109 | 111 | 118 | 113 | 113 | 118 | |

CHECK V1(MCG) IN BOXED AREA

V1(MCG)

Max Takeoff Thrust

| ACTUAL OAT | | PRESSURE ALTITUDE (FT) | | | | | | |
|------------|-----|------------------------|-----|------|------|------|------|------|
| °F | °C | -1000 | 0 | 2000 | 4000 | 6000 | 8000 | 9000 |
| 131 | 55 | 99 | 97 | 93 | | | | |
| 122 | 50 | 103 | 100 | 96 | 93 | | | |
| 113 | 45 | 106 | 103 | 99 | 95 | 92 | | |
| 104 | 40 | 109 | 106 | 102 | 98 | 94 | 90 | 89 |
| 95 | 35 | 110 | 109 | 104 | 100 | 96 | 92 | 90 |
| 86 | 30 | 111 | 110 | 106 | 102 | 98 | 94 | 92 |
| 77 | 25 | 111 | 110 | 106 | 103 | 99 | 95 | 93 |
| 68 | 20 | 111 | 110 | 106 | 103 | 100 | 96 | 94 |
| 59 | 15 | 111 | 110 | 106 | 103 | 100 | 96 | 95 |
| -58 | -50 | 111 | 111 | 107 | 104 | 100 | 97 | 95 |

Maximum Allowable Clearway

| FIELD LENGTH (FT) | MAX ALLOWABLE CLEARWAY FOR V1 REDUCTION (FT) |
|-------------------|--|
| 4000 | 350 |
| 6000 | 450 |
| 8000 | 550 |
| 10000 | 650 |
| 12000 | 750 |
| 14000 | 800 |

Clearway and Stopway V1 Adjustments

| CLEARWAY MINUS STOPWAY (FT) | NORMAL V1 (KIAS) | | |
|-----------------------------|------------------|-----|-----|
| | 120 | 140 | 160 |
| 800 | -5 | -3 | -2 |
| 600 | -3 | -2 | -2 |
| 400 | -2 | -1 | -1 |
| 200 | -1 | -1 | -1 |
| 0 | 0 | 0 | 0 |
| -200 | 1 | 1 | 1 |
| -400 | 2 | 1 | 1 |
| -600 | 3 | 2 | 2 |
| -800 | 5 | 3 | 2 |

**Stab Trim Setting
Max Takeoff Thrust**

| WEIGHT (1000 LB) | C.G. %MAC | | | | | | |
|---------------------|-----------|-------|-------|-------|-------|-------|-------|
| | 12 | 16 | 20 | 24 | 28 | 32 | 36 |
| 420 | 7 | 6 1/2 | 5 1/2 | 4 1/2 | 4 | 3 | 2 |
| 400 | 7 | 6 | 5 1/2 | 4 1/2 | 3 1/2 | 3 | 1 1/2 |
| 380 | 7 | 6 | 5 | 4 1/2 | 3 1/2 | 2 1/2 | 1 1/2 |
| 360 | 6 1/2 | 6 | 5 | 4 | 3 1/2 | 2 1/2 | 1 1/2 |
| 340 | 6 | 5 1/2 | 4 1/2 | 3 1/2 | 3 | 2 | 1 |
| 320 | 5 1/2 | 5 | 4 | 3 1/2 | 2 1/2 | 1 1/2 | 1/2 |
| 300 | 5 | 4 1/2 | 3 1/2 | 3 | 2 | 1 1/2 | 1/2 |
| 280 | 4 1/2 | 4 | 3 | 2 1/2 | 1 1/2 | 1 | 1/2 |
| 260 | 4 | 3 1/2 | 2 1/2 | 2 | 1 | 1/2 | 1/2 |
| 240 | 3 1/2 | 3 | 2 | 1 1/2 | 1 | 1/2 | 1/2 |
| 220 | 3 1/2 | 2 1/2 | 2 | 1 | 1/2 | 1/2 | 1/2 |

VREF (KIAS)

| WEIGHT (1000 LB) | FLAPS | | |
|---------------------|-------|-----|-----|
| | 30 | 25 | 20 |
| 420 | 179 | 171 | 179 |
| 400 | 172 | 166 | 174 |
| 380 | 166 | 162 | 169 |
| 360 | 159 | 158 | 164 |
| 340 | 151 | 153 | 159 |
| 320 | 145 | 149 | 154 |
| 300 | 140 | 144 | 149 |
| 280 | 135 | 139 | 144 |
| 260 | 130 | 134 | 139 |
| 240 | 124 | 129 | 134 |
| 220 | 119 | 123 | 128 |

Flap Maneuver Speeds

| FLAP POSITION | MANEUVER SPEED |
|---------------|----------------|
| UP | VREF30 + 80 |
| 1 | VREF30 + 60 |
| 5 | VREF30 + 40 |
| 15 | VREF30 + 20 |
| 20 | VREF30 + 20 |
| 25 | VREF25 |
| 30 | VREF30 |

ALL ENGINES

ADVISORY INFORMATION

**Slush/Standing Water Takeoff
Weight Adjustment (1000 LB)**

| FIELD/OBSTACLE LIMIT WEIGHT (1000 LB) | SLUSH/STANDING WATER DEPTH | | | | | |
|---|----------------------------|------|-------|---------------------|-------|-------|
| | 0.25 INCHES (6 mm) | | | 0.50 INCHES (13 mm) | | |
| | PRESS ALT (FT) | | | PRESS ALT (FT) | | |
| | S.L. | 4000 | 8000 | S.L. | 4000 | 8000 |
| 420 | 0.0 | -4.8 | -9.6 | -10.3 | -15.1 | -19.9 |
| 400 | 0.0 | -4.8 | -9.6 | -11.2 | -16.0 | -20.8 |
| 380 | -0.9 | -5.7 | -10.5 | -11.3 | -16.1 | -20.9 |
| 360 | -1.7 | -6.5 | -11.3 | -10.8 | -15.6 | -20.4 |
| 340 | -2.0 | -6.8 | -11.6 | -9.8 | -14.6 | -19.4 |
| 320 | -1.8 | -6.6 | -11.4 | -8.3 | -13.1 | -17.9 |
| 300 | -1.3 | -6.1 | -10.9 | -6.6 | -11.4 | -16.2 |
| 280 | -0.5 | -5.3 | -10.1 | -4.7 | -9.5 | -14.3 |
| 260 | 0.0 | -4.8 | -9.6 | -2.8 | -7.6 | -12.4 |
| 240 | 0.0 | -4.8 | -9.6 | -1.1 | -5.9 | -10.7 |
| 220 | 0.0 | -4.8 | -9.6 | 0.0 | -4.8 | -9.6 |

Interpolate as required using dry runway as zero slush/standing water depth.

Takeoff EPR**Max Takeoff Thrust****Based on engine bleed for packs on and anti-ice on or off**

| AIRPORT OAT | | AIRPORT PRESSURE ALTITUDE (FT) | | | | | |
|---------------|---------------|--------------------------------|------|------|------|------|------|
| °F | °C | -1000 | 0 | 2000 | 4000 | 6000 | 8000 |
| 158 | 70 | 1.24 | 1.23 | 1.25 | 1.25 | 1.25 | 1.25 |
| 149 | 65 | 1.29 | 1.28 | 1.27 | 1.27 | 1.27 | 1.27 |
| 140 | 60 | 1.34 | 1.33 | 1.33 | 1.32 | 1.32 | 1.32 |
| 131 | 55 | 1.39 | 1.38 | 1.38 | 1.37 | 1.37 | 1.37 |
| 122 | 50 | 1.43 | 1.42 | 1.42 | 1.42 | 1.42 | 1.42 |
| 113 | 45 | 1.46 | 1.46 | 1.46 | 1.46 | 1.46 | 1.46 |
| 104 | 40 | 1.51 | 1.51 | 1.51 | 1.51 | 1.50 | 1.51 |
| 95 | 35 | 1.53 | 1.55 | 1.55 | 1.54 | 1.54 | 1.54 |
| 86 | 30 | 1.53 | 1.56 | 1.58 | 1.58 | 1.58 | 1.58 |
| 77 | 25 | 1.53 | 1.56 | 1.58 | 1.60 | 1.60 | 1.60 |
| 68 | 20 | 1.53 | 1.56 | 1.58 | 1.60 | 1.61 | 1.62 |
| 59 | 15 | 1.53 | 1.56 | 1.58 | 1.60 | 1.61 | 1.64 |
| 50 & BELOW | 10 & BELOW | 1.53 | 1.56 | 1.58 | 1.60 | 1.61 | 1.64 |

EPR Adjustments for Engine Bleeds

| BLEED CONFIGURATION | AIRPORT PRESSURE ALTITUDE (FT) | | | | | | | |
|------------------------|--------------------------------|------|------|------|------|------|------|------|
| | -1000 | 0 | 2000 | 4000 | 4500 | 4501 | 6000 | 8000 |
| PACKS OFF | 0.01 | 0.01 | 0.01 | 0.01 | 0.01 | 0.02 | 0.02 | 0.02 |

**Assumed Temperature Reduced Thrust
Based on 25% thrust reduction**

| MINIMUM ALLOWABLE EPR FOR REDUCED THRUST | |
|--|-------------------------|
| MAX TAKEOFF EPR FOR ACTUAL OAT | MIN TAKEOFF EPR ALLOWED |
| 1.75 | 1.44 |
| 1.70 | 1.42 |
| 1.65 | 1.40 |
| 1.60 | 1.38 |
| 1.55 | 1.35 |
| 1.50 | 1.33 |
| 1.45 | 1.30 |
| 1.40 | 1.27 |
| 1.35 | 1.24 |
| 1.31 | 1.21 |
| 1.25 | 1.21 |

Max Climb EPR**Based on engine bleed for packs on and anti-ice off**

| TAT (°C) | PRESSURE ALTITUDE (1000 FT)/SPEED (KIAS OR MACH) | | | | | | | | |
|----------------|--|------|------|------|------|------|------|------|------|
| | 0 | 5 | 10 | 15 | 20 | 25 | 30 | 35 | 40 |
| | 250 | 250 | 250 | 290 | 290 | 290 | 290 | .78 | .78 |
| 60 | 1.24 | 1.25 | 1.25 | 1.21 | 1.20 | 1.18 | 1.14 | 1.08 | 1.05 |
| 50 | 1.28 | 1.29 | 1.29 | 1.26 | 1.24 | 1.23 | 1.21 | 1.15 | 1.11 |
| 40 | 1.32 | 1.34 | 1.34 | 1.31 | 1.30 | 1.29 | 1.27 | 1.21 | 1.18 |
| 30 | 1.33 | 1.40 | 1.40 | 1.38 | 1.37 | 1.36 | 1.35 | 1.29 | 1.25 |
| 20 | 1.33 | 1.40 | 1.46 | 1.46 | 1.45 | 1.44 | 1.43 | 1.37 | 1.34 |
| 10 | 1.33 | 1.40 | 1.46 | 1.47 | 1.53 | 1.53 | 1.53 | 1.47 | 1.44 |
| 0 | 1.33 | 1.40 | 1.46 | 1.47 | 1.53 | 1.57 | 1.63 | 1.57 | 1.54 |
| -10 | 1.33 | 1.40 | 1.46 | 1.47 | 1.53 | 1.57 | 1.64 | 1.67 | 1.63 |
| -20 & BELOW | 1.33 | 1.40 | 1.46 | 1.47 | 1.53 | 1.57 | 1.64 | 1.68 | 1.66 |

EPR Adjustments for Engine Bleeds

| BLEED CONFIGURATION | PRESSURE ALTITUDE (1000 FT) | | | | | | | | |
|---------------------------|-----------------------------|-------|-------|-------|-------|-------|-------|-------|-------|
| | 0 | 5 | 10 | 15 | 20 | 25 | 30 | 35 | 40 |
| PACKS OFF | 0.01 | 0.01 | 0.01 | 0.01 | 0.01 | 0.01 | 0.02 | 0.02 | 0.03 |
| ENGINE ANTI-ICE ON | -0.01 | -0.02 | -0.02 | -0.03 | -0.03 | -0.03 | -0.04 | -0.04 | -0.05 |
| ENGINE & WING ANTI-ICE ON | -0.02 | -0.03 | -0.04 | -0.05 | -0.05 | -0.05 | -0.07 | -0.07 | -0.08 |

Go-around EPR

Based on engine bleed for packs on, engine anti-ice on or off and wing anti-ice off

| REPORTED OAT | | TAT (°C) | AIRPORT PRESSURE ALTITUDE (FT) | | | | | |
|--------------|------------|------------|--------------------------------|------|------|------|------|------|
| °F | °C | | -1000 | 0 | 2000 | 4000 | 6000 | 8000 |
| 131 | 55 | 58 | 1.38 | 1.38 | 1.37 | 1.37 | 1.36 | 1.37 |
| 122 | 50 | 53 | 1.42 | 1.42 | 1.42 | 1.42 | 1.41 | 1.42 |
| 113 | 45 | 48 | 1.46 | 1.46 | 1.47 | 1.46 | 1.46 | 1.46 |
| 104 | 40 | 43 | 1.51 | 1.51 | 1.51 | 1.51 | 1.51 | 1.51 |
| 95 | 35 | 38 | 1.54 | 1.56 | 1.55 | 1.55 | 1.55 | 1.55 |
| 86 | 30 | 33 | 1.54 | 1.57 | 1.59 | 1.59 | 1.59 | 1.59 |
| 77 | 25 | 28 | 1.54 | 1.57 | 1.60 | 1.62 | 1.61 | 1.62 |
| 68 | 20 | 23 | 1.54 | 1.57 | 1.60 | 1.62 | 1.63 | 1.64 |
| 59 | 15 | 18 | 1.54 | 1.57 | 1.60 | 1.62 | 1.63 | 1.66 |
| 50 & BELOW | 10 & BELOW | 13 & BELOW | 1.54 | 1.57 | 1.60 | 1.62 | 1.63 | 1.66 |

EPR Adjustments for Engine Bleeds

| BLEED CONFIGURATION | AIRPORT PRESSURE ALTITUDE (FT) | | | | | | | |
|---------------------|--------------------------------|-------|-------|-------|-------|-------|-------|-------|
| | -1000 | 0 | 2000 | 4000 | 4500 | 4501 | 6000 | 8000 |
| PACKS OFF | 0.01 | 0.01 | 0.01 | 0.01 | 0.01 | 0.02 | 0.02 | 0.02 |
| WING ANTI-ICE ON | -0.01 | -0.01 | -0.01 | -0.01 | -0.01 | -0.02 | -0.02 | -0.02 |

Flight With Unreliable Airspeed / Turbulent Air Penetration

Altitude and/or vertical speed indications may also be unreliable.

Climb (290/.78)**Flaps Up, Set Max Climb Thrust**

| PRESSURE ALTITUDE (FT) | | WEIGHT (1000 LB) | | | | |
|---------------------------|--------------|------------------|------|------|------|------|
| | | 220 | 260 | 300 | 350 | 400 |
| 40000 | PITCH ATT | 4.0 | 4.0 | 3.5 | | |
| | V/S (FT/MIN) | 1500 | 1000 | 300 | | |
| 30000 | PITCH ATT | 4.0 | 4.0 | 3.5 | 3.5 | 4.0 |
| | V/S (FT/MIN) | 2600 | 2100 | 1700 | 1200 | 900 |
| 20000 | PITCH ATT | 6.5 | 6.0 | 6.0 | 5.5 | 5.5 |
| | V/S (FT/MIN) | 4000 | 3100 | 2700 | 2100 | 1700 |
| 10000 | PITCH ATT | 10.0 | 9.0 | 8.0 | 7.5 | 7.5 |
| | V/S (FT/MIN) | 5300 | 4400 | 3700 | 3000 | 2500 |
| SEA LEVEL | PITCH ATT | 12.5 | 11.0 | 10.0 | 9.5 | 9.0 |
| | V/S (FT/MIN) | 6000 | 5000 | 4300 | 3500 | 3000 |

Cruise (.78/290)**Flaps Up, EPR for Level Flight**

| PRESSURE ALTITUDE (FT) | | WEIGHT (1000 LB) | | | | |
|---------------------------|-----------|------------------|------|------|------|------|
| | | 220 | 260 | 300 | 350 | 400 |
| 40000 | PITCH ATT | 2.0 | 2.5 | 3.5 | 4.0 | |
| | EPR | 1.22 | 1.33 | 1.53 | 1.87 | |
| 35000 | PITCH ATT | 1.5 | 1.5 | 2.5 | 3.0 | 3.5 |
| | EPR | 1.13 | 1.17 | 1.24 | 1.37 | 1.59 |
| 30000 | PITCH ATT | 1.0 | 1.0 | 1.5 | 2.0 | 2.5 |
| | EPR | 1.08 | 1.11 | 1.14 | 1.20 | 1.26 |

Descent (.78/290)**Flaps Up, Set Idle Thrust**

| PRESSURE ALTITUDE (FT) | | WEIGHT (1000 LB) | | | | |
|---------------------------|--------------|------------------|-------|-------|-------|-------|
| | | 220 | 260 | 300 | 350 | 400 |
| 40000 | PITCH ATT | -1.0 | 0.0 | 0.0 | 0.5 | |
| | V/S (FT/MIN) | -2200 | -2200 | -2400 | -2900 | |
| 30000 | PITCH ATT | -2.5 | -1.5 | -1.5 | -0.5 | 0.0 |
| | V/S (FT/MIN) | -2500 | -2300 | -2100 | -2000 | -2000 |
| 20000 | PITCH ATT | -2.5 | -1.5 | -1.0 | 0.0 | 0.5 |
| | V/S (FT/MIN) | -2300 | -2100 | -1900 | -1800 | -1800 |
| 10000 | PITCH ATT | -2.5 | -2.0 | -1.0 | 0.0 | 0.5 |
| | V/S (FT/MIN) | -2100 | -1900 | -1700 | -1600 | -1600 |

Holding (VREF30 + 80)**Flaps Up, EPR for Level Flight**

| PRESSURE ALTITUDE (FT) | | WEIGHT (1000 LB) | | | | |
|---------------------------|-----------|------------------|------|------|------|------|
| | | 220 | 260 | 300 | 350 | 400 |
| 10000 | PITCH ATT | 4.5 | 5.0 | 5.0 | 5.5 | 5.5 |
| | EPR | 1.02 | 1.03 | 1.05 | 1.06 | 1.07 |

Flight With Unreliable Airspeed / Turbulent Air Penetration
Altitude and/or vertical speed indications may also be unreliable.
Terminal Area (5000 FT)
Gear Up, EPR for Level Flight

| FLAP POSITION (VREF + INCREMENT) | | WEIGHT (1000 LB) | | | | |
|-------------------------------------|------------------|------------------|------------|------------|------------|------------|
| | | 220 | 260 | 300 | 350 | 400 |
| FLAPS UP (VREF30 + 80) | PITCH ATT | 4.5 | 5.0 | 5.0 | 5.5 | 5.5 |
| | EPR | 1.01 | 1.01 | 1.03 | 1.04 | 1.05 |
| FLAPS 1 (VREF30 + 60) | PITCH ATT | 6.0 | 6.5 | 7.0 | 7.0 | 7.0 |
| | EPR | 1.03 | 1.04 | 1.05 | 1.07 | 1.08 |
| FLAPS 5 (VREF30 + 40) | PITCH ATT | 4.5 | 5.0 | 5.0 | 5.0 | 5.0 |
| | EPR | 1.05 | 1.07 | 1.08 | 1.10 | 1.11 |
| FLAPS 15 (VREF30 + 20) | PITCH ATT | 6.0 | 6.0 | 6.5 | 6.0 | 5.5 |
| | EPR | 1.07 | 1.08 | 1.10 | 1.12 | 1.14 |
| FLAPS 20 (VREF30 + 20) | PITCH ATT | 4.5 | 4.5 | 4.5 | 4.5 | 4.0 |
| | EPR | 1.07 | 1.09 | 1.11 | 1.13 | 1.16 |

Final Approach (1500 FT)
Gear Down, EPR for 3° Glideslope

| FLAP POSITION (VREF + INCREMENT) | | WEIGHT (1000 LB) | | | | |
|-------------------------------------|------------------|------------------|------------|------------|------------|-------------|
| | | 220 | 260 | 300 | 350 | 400 |
| FLAPS 25 (VREF25 + 10) | PITCH ATT | 0.5 | 1.0 | 1.0 | 1.0 | 1.0 |
| | EPR | 1.05 | 1.06 | 1.07 | 1.08 | 1.10 |
| FLAPS 30 (VREF30 + 10) | PITCH ATT | 1.0 | 1.0 | 1.0 | 0.5 | -0.5 |
| | EPR | 1.06 | 1.08 | 1.09 | 1.11 | 1.13 |

Performance Inflight - All Engine

Chapter PI Section 21

Long Range Cruise Maximum Operating Altitude

ISA + 10°C and Below

| WEIGHT (1000 LB) | OPTIMUM ALT (FT) | TAT (°C) | MARGIN TO INITIAL BUFFET 'G' (BANK ANGLE) | | | | |
|---------------------|---------------------|-------------|---|------------|------------|------------|------------|
| | | | 1.20 (33°) | 1.25 (36°) | 1.30 (39°) | 1.40 (44°) | 1.50 (48°) |
| 420 | 29000 | -1 | 34000* | 33600 | 32600 | 30900 | 29400 |
| 400 | 30000 | -4 | 35000* | 34600 | 33700 | 31900 | 30400 |
| 380 | 31200 | -6 | 36000* | 35700 | 34800 | 33000 | 31500 |
| 360 | 32300 | -9 | 37000* | 36800 | 35900 | 34200 | 32700 |
| 340 | 33600 | -12 | 38200* | 38000 | 37100 | 35400 | 33900 |
| 320 | 34800 | -15 | 39400* | 39300 | 38300 | 36600 | 35200 |
| 300 | 36200 | -17 | 40700* | 40600 | 39700 | 38000 | 36600 |
| 280 | 37600 | -17 | 42000* | 42000 | 41100 | 39400 | 38000 |
| 260 | 39200 | -17 | 43100 | 43100 | 42700 | 41000 | 39500 |
| 240 | 40800 | -17 | 43100 | 43100 | 43100 | 42600 | 41200 |
| 220 | 42600 | -17 | 43100 | 43100 | 43100 | 43100 | 43000 |

ISA + 15°C

| WEIGHT (1000 LB) | OPTIMUM ALT (FT) | TAT (°C) | MARGIN TO INITIAL BUFFET 'G' (BANK ANGLE) | | | | |
|---------------------|---------------------|-------------|---|------------|------------|------------|------------|
| | | | 1.20 (33°) | 1.25 (36°) | 1.30 (39°) | 1.40 (44°) | 1.50 (48°) |
| 420 | 29000 | 4 | 33900* | 33600 | 32600 | 30900 | 29400 |
| 400 | 30000 | 2 | 34900* | 34600 | 33700 | 31900 | 30400 |
| 380 | 31200 | -1 | 35900* | 35700 | 34800 | 33000 | 31500 |
| 360 | 32300 | -3 | 37000* | 36800 | 35900 | 34200 | 32700 |
| 340 | 33600 | -6 | 38200* | 38000 | 37100 | 35400 | 33900 |
| 320 | 34800 | -9 | 39400* | 39300 | 38300 | 36600 | 35200 |
| 300 | 36200 | -12 | 40600* | 40600 | 39700 | 38000 | 36600 |
| 280 | 37600 | -12 | 42000* | 42000 | 41100 | 39400 | 38000 |
| 260 | 39200 | -12 | 43100 | 43100 | 42700 | 41000 | 39500 |
| 240 | 40800 | -12 | 43100 | 43100 | 43100 | 42600 | 41200 |
| 220 | 42600 | -12 | 43100 | 43100 | 43100 | 43100 | 43000 |

*Denotes altitude thrust limited in level flight.

ISA + 20°C

| WEIGHT (1000 LB) | OPTIMUM ALT (FT) | TAT (°C) | MARGIN TO INITIAL BUFFET 'G' (BANK ANGLE) | | | | |
|---------------------|---------------------|-------------|---|------------|------------|------------|------------|
| | | | 1.20 (33°) | 1.25 (36°) | 1.30 (39°) | 1.40 (44°) | 1.50 (48°) |
| 420 | 29000 | 10 | 33400* | 33400* | 32600 | 30900 | 29400 |
| 400 | 30000 | 7 | 34400* | 34400* | 33700 | 31900 | 30400 |
| 380 | 31200 | 5 | 35400* | 35400* | 34800 | 33000 | 31500 |
| 360 | 32300 | 2 | 36500* | 36500* | 35900 | 34200 | 32700 |
| 340 | 33600 | 0 | 37600* | 37600* | 37100 | 35400 | 33900 |
| 320 | 34800 | -3 | 38800* | 38800* | 38300 | 36600 | 35200 |
| 300 | 36200 | -6 | 40100* | 40100* | 39700 | 38000 | 36600 |
| 280 | 37600 | -6 | 41400* | 41400* | 41100 | 39400 | 38000 |
| 260 | 39200 | -6 | 42900* | 42900* | 42700 | 41000 | 39500 |
| 240 | 40800 | -6 | 43100 | 43100 | 43100 | 42600 | 41200 |
| 220 | 42600 | -6 | 43100 | 43100 | 43100 | 43100 | 43000 |

*Denotes altitude thrust limited in level flight.

Long Range Cruise Control

| WEIGHT (1000 LB) | | PRESSURE ALTITUDE (1000 FT) | | | | | | | | | | |
|---------------------|--------|-----------------------------|------|------|------|------|------|------|------|------|------|------|
| | | 23 | 25 | 27 | 29 | 31 | 33 | 35 | 37 | 39 | 41 | 43 |
| 420 | EPR | 1.12 | 1.15 | 1.19 | 1.25 | 1.33 | 1.46 | | | | | |
| | MACH | .777 | .791 | .797 | .802 | .802 | .796 | | | | | |
| | KIAS | 341 | 333 | 323 | 311 | 298 | 283 | | | | | |
| | FF/ENG | 7307 | 7199 | 7072 | 6990 | 7023 | 7252 | | | | | |
| 400 | EPR | 1.11 | 1.14 | 1.17 | 1.22 | 1.29 | 1.39 | 1.56 | | | | |
| | MACH | .766 | .783 | .795 | .800 | .802 | .799 | .791 | | | | |
| | KIAS | 336 | 330 | 322 | 310 | 298 | 284 | 269 | | | | |
| | FF/ENG | 6986 | 6913 | 6794 | 6676 | 6635 | 6750 | 7197 | | | | |
| 380 | EPR | 1.09 | 1.12 | 1.15 | 1.19 | 1.24 | 1.33 | 1.46 | | | | |
| | MACH | .755 | .774 | .789 | .797 | .801 | .802 | .796 | | | | |
| | KIAS | 330 | 326 | 319 | 309 | 298 | 285 | 271 | | | | |
| | FF/ENG | 6676 | 6613 | 6508 | 6390 | 6305 | 6325 | 6519 | | | | |
| 360 | EPR | 1.08 | 1.10 | 1.13 | 1.17 | 1.21 | 1.28 | 1.38 | 1.54 | | | |
| | MACH | .742 | .762 | .780 | .793 | .799 | .802 | .800 | .792 | | | |
| | KIAS | 324 | 320 | 315 | 308 | 297 | 285 | 272 | 257 | | | |
| | FF/ENG | 6361 | 6301 | 6222 | 6118 | 5996 | 5956 | 6030 | 6429 | | | |
| 340 | EPR | 1.07 | 1.09 | 1.11 | 1.15 | 1.19 | 1.24 | 1.32 | 1.44 | | | |
| | MACH | .727 | .749 | .769 | .786 | .796 | .801 | .802 | .797 | | | |
| | KIAS | 317 | 315 | 310 | 305 | 296 | 285 | 273 | 259 | | | |
| | FF/ENG | 6026 | 5990 | 5916 | 5834 | 5726 | 5635 | 5629 | 5809 | | | |
| 320 | EPR | 1.06 | 1.08 | 1.10 | 1.13 | 1.16 | 1.20 | 1.26 | 1.36 | 1.50 | | |
| | MACH | .711 | .734 | .755 | .775 | .790 | .798 | .802 | .801 | .794 | | |
| | KIAS | 310 | 308 | 304 | 300 | 293 | 284 | 273 | 260 | 246 | | |
| | FF/ENG | 5675 | 5665 | 5610 | 5539 | 5453 | 5338 | 5286 | 5347 | 5653 | | |
| 300 | EPR | 1.04 | 1.06 | 1.08 | 1.11 | 1.14 | 1.18 | 1.22 | 1.29 | 1.41 | | |
| | MACH | .693 | .717 | .740 | .761 | .780 | .793 | .799 | .802 | .799 | | |
| | KIAS | 302 | 300 | 298 | 294 | 289 | 282 | 272 | 260 | 248 | | |
| | FF/ENG | 5326 | 5322 | 5297 | 5232 | 5168 | 5075 | 4975 | 4972 | 5119 | | |
| 280 | EPR | 1.03 | 1.05 | 1.07 | 1.09 | 1.12 | 1.15 | 1.19 | 1.24 | 1.32 | 1.45 | |
| | MACH | .675 | .698 | .722 | .745 | .766 | .784 | .796 | .801 | .802 | .798 | |
| | KIAS | 293 | 292 | 290 | 287 | 283 | 278 | 270 | 260 | 249 | 236 | |
| | FF/ENG | 4997 | 4975 | 4958 | 4930 | 4863 | 4799 | 4705 | 4658 | 4709 | 4878 | |
| 260 | EPR | 1.03 | 1.04 | 1.05 | 1.07 | 1.10 | 1.12 | 1.16 | 1.20 | 1.26 | 1.35 | 1.49 |
| | MACH | .654 | .678 | .702 | .726 | .749 | .770 | .787 | .797 | .801 | .802 | .796 |
| | KIAS | 284 | 283 | 281 | 279 | 277 | 273 | 267 | 259 | 248 | 237 | 225 |
| | FF/ENG | 4687 | 4650 | 4612 | 4600 | 4564 | 4503 | 4438 | 4377 | 4375 | 4428 | 4622 |
| 240 | EPR | 1.02 | 1.03 | 1.04 | 1.06 | 1.08 | 1.10 | 1.13 | 1.17 | 1.21 | 1.28 | 1.38 |
| | MACH | .632 | .656 | .680 | .704 | .729 | .752 | .773 | .790 | .797 | .802 | .801 |
| | KIAS | 274 | 273 | 272 | 270 | 269 | 266 | 262 | 256 | 247 | 237 | 226 |
| | FF/ENG | 4405 | 4341 | 4301 | 4254 | 4247 | 4206 | 4149 | 4111 | 4085 | 4073 | 4132 |
| 220 | EPR | 1.01 | 1.02 | 1.03 | 1.04 | 1.06 | 1.08 | 1.11 | 1.14 | 1.18 | 1.22 | 1.29 |
| | MACH | .609 | .632 | .656 | .681 | .706 | .731 | .754 | .775 | .791 | .798 | .802 |
| | KIAS | 263 | 262 | 262 | 261 | 259 | 258 | 255 | 251 | 245 | 236 | 226 |
| | FF/ENG | 4118 | 4060 | 4002 | 3957 | 3918 | 3889 | 3854 | 3825 | 3818 | 3777 | 3760 |

Shaded area approximates optimum altitude.

Long Range Cruise Enroute Fuel and Time - Low Altitudes
Ground to Air Miles Conversion

| AIR DISTANCE (NM) | | | | | GROUND DISTANCE (NM) | AIR DISTANCE (NM) | | | | |
|--------------------------|------|------|------|------|----------------------------|--------------------------|------|------|------|------|
| HEADWIND COMPONENT (KTS) | | | | | | TAILWIND COMPONENT (KTS) | | | | |
| 100 | 80 | 60 | 40 | 20 | | 20 | 40 | 60 | 80 | 100 |
| 282 | 261 | 242 | 226 | 213 | 200 | 191 | 182 | 174 | 167 | 161 |
| 564 | 522 | 485 | 453 | 425 | 400 | 382 | 366 | 351 | 337 | 324 |
| 848 | 784 | 728 | 680 | 638 | 600 | 574 | 550 | 527 | 506 | 487 |
| 1133 | 1048 | 972 | 908 | 851 | 800 | 765 | 732 | 702 | 675 | 650 |
| 1420 | 1312 | 1216 | 1135 | 1064 | 1000 | 957 | 916 | 879 | 844 | 813 |
| 1708 | 1578 | 1462 | 1363 | 1277 | 1200 | 1148 | 1099 | 1054 | 1013 | 976 |
| 1998 | 1844 | 1708 | 1592 | 1491 | 1400 | 1339 | 1282 | 1229 | 1181 | 1138 |
| 2290 | 2112 | 1954 | 1820 | 1704 | 1600 | 1530 | 1465 | 1405 | 1350 | 1300 |
| 2583 | 2381 | 2202 | 2050 | 1918 | 1800 | 1721 | 1648 | 1580 | 1518 | 1462 |
| 2878 | 2652 | 2451 | 2280 | 2132 | 2000 | 1912 | 1830 | 1755 | 1686 | 1624 |

Reference Fuel And Time Required at Check Point

| AIR DIST (NM) | PRESSURE ALTITUDE (1000 FT) | | | | | | | | | |
|---------------------|-----------------------------|------------------|-------------------|------------------|-------------------|------------------|-------------------|------------------|-------------------|------------------|
| | 10 | | 14 | | 20 | | 24 | | 28 | |
| | FUEL (1000 LB) | TIME (HR:MIN) | FUEL (1000 LB) | TIME (HR:MIN) | FUEL (1000 LB) | TIME (HR:MIN) | FUEL (1000 LB) | TIME (HR:MIN) | FUEL (1000 LB) | TIME (HR:MIN) |
| 200 | 6.0 | 0:39 | 5.3 | 0:38 | 4.2 | 0:36 | 3.8 | 0:35 | 3.4 | 0:35 |
| 400 | 12.6 | 1:14 | 11.4 | 1:10 | 9.5 | 1:06 | 8.7 | 1:04 | 8.1 | 1:02 |
| 600 | 19.1 | 1:50 | 17.6 | 1:44 | 14.8 | 1:36 | 13.6 | 1:32 | 12.7 | 1:29 |
| 800 | 25.5 | 2:25 | 23.6 | 2:17 | 20.0 | 2:07 | 18.5 | 2:01 | 17.3 | 1:56 |
| 1000 | 31.9 | 3:02 | 29.6 | 2:51 | 25.2 | 2:37 | 23.3 | 2:30 | 21.9 | 2:24 |
| 1200 | 38.1 | 3:39 | 35.5 | 3:25 | 30.4 | 3:08 | 28.1 | 2:59 | 26.4 | 2:51 |
| 1400 | 44.3 | 4:16 | 41.4 | 3:59 | 35.5 | 3:39 | 32.8 | 3:28 | 30.9 | 3:19 |
| 1600 | 50.4 | 4:54 | 47.2 | 4:34 | 40.6 | 4:11 | 37.5 | 3:58 | 35.3 | 3:47 |
| 1800 | 56.5 | 5:32 | 52.9 | 5:09 | 45.6 | 4:42 | 42.2 | 4:27 | 39.7 | 4:15 |
| 2000 | 62.4 | 6:10 | 58.6 | 5:45 | 50.6 | 5:14 | 46.8 | 4:57 | 44.0 | 4:43 |

Fuel Required Adjustment (1000 LB)

| REFERENCE FUEL REQUIRED (1000 LB) | WEIGHT AT CHECK POINT (1000 LB) | | | | |
|--------------------------------------|---------------------------------|------|-----|-----|------|
| | 200 | 250 | 300 | 350 | 400 |
| 5 | -0.5 | -0.3 | 0.0 | 0.3 | 0.7 |
| 10 | -1.4 | -0.8 | 0.0 | 0.8 | 1.6 |
| 15 | -2.3 | -1.3 | 0.0 | 1.2 | 2.6 |
| 20 | -3.2 | -1.7 | 0.0 | 1.7 | 3.6 |
| 25 | -4.0 | -2.2 | 0.0 | 2.2 | 4.6 |
| 30 | -4.9 | -2.6 | 0.0 | 2.7 | 5.6 |
| 35 | -5.7 | -3.1 | 0.0 | 3.2 | 6.5 |
| 40 | -6.6 | -3.5 | 0.0 | 3.7 | 7.5 |
| 45 | -7.4 | -4.0 | 0.0 | 4.2 | 8.5 |
| 50 | -8.2 | -4.4 | 0.0 | 4.7 | 9.5 |
| 55 | -9.0 | -4.8 | 0.0 | 5.2 | 10.4 |
| 60 | -9.8 | -5.2 | 0.0 | 5.7 | 11.4 |
| 65 | -10.6 | -5.7 | 0.0 | 6.2 | 12.4 |

**Long Range Cruise Enroute Fuel and Time - High Altitudes
Ground to Air Miles Conversion**

| AIR DISTANCE (NM) | | | | | GROUND DISTANCE (NM) | AIR DISTANCE (NM) | | | | |
|--------------------------|------|------|------|------|----------------------|-------------------|------|------|------|------|
| HEADWIND COMPONENT (KTS) | | | | | | 20 | 40 | 60 | 80 | 100 |
| 100 | 80 | 60 | 40 | 20 | | | | | | |
| 1299 | 1226 | 1160 | 1101 | 1048 | 1000 | 958 | 919 | 882 | 849 | 818 |
| 1946 | 1838 | 1740 | 1652 | 1573 | 1500 | 1437 | 1379 | 1324 | 1275 | 1229 |
| 2597 | 2452 | 2320 | 2203 | 2097 | 2000 | 1917 | 1839 | 1767 | 1700 | 1639 |
| 3251 | 3069 | 2903 | 2755 | 2622 | 2500 | 2395 | 2298 | 2208 | 2125 | 2050 |
| 3907 | 3688 | 3487 | 3309 | 3148 | 3000 | 2875 | 2758 | 2650 | 2551 | 2460 |
| 4568 | 4309 | 4073 | 3863 | 3674 | 3500 | 3354 | 3217 | 3091 | 2975 | 2869 |
| 5232 | 4932 | 4660 | 4417 | 4200 | 4000 | 3833 | 3677 | 3532 | 3399 | 3278 |
| 5900 | 5559 | 5249 | 4974 | 4727 | 4500 | 4312 | 4136 | 3973 | 3823 | 3686 |
| 6572 | 6189 | 5840 | 5532 | 5254 | 5000 | 4790 | 4594 | 4413 | 4246 | 4094 |
| 7249 | 6822 | 6434 | 6090 | 5782 | 5500 | 5268 | 5052 | 4852 | 4668 | 4500 |
| 7931 | 7459 | 7029 | 6650 | 6311 | 6000 | 5746 | 5510 | 5291 | 5090 | 4906 |

Reference Fuel And Time Required at Check Point

| AIR DIST (NM) | PRESSURE ALTITUDE (1000 FT) | | | | | | | | | |
|---------------|-----------------------------|---------------|----------------|---------------|----------------|---------------|----------------|---------------|----------------|---------------|
| | 29 | | 31 | | 33 | | 35 | | 37 | |
| | FUEL (1000 LB) | TIME (HR:MIN) | FUEL (1000 LB) | TIME (HR:MIN) | FUEL (1000 LB) | TIME (HR:MIN) | FUEL (1000 LB) | TIME (HR:MIN) | FUEL (1000 LB) | TIME (HR:MIN) |
| 1000 | 21.5 | 2:22 | 20.8 | 2:20 | 20.2 | 2:19 | 19.7 | 2:19 | 19.5 | 2:19 |
| 1500 | 32.5 | 3:31 | 31.5 | 3:27 | 30.6 | 3:25 | 29.9 | 3:24 | 29.5 | 3:24 |
| 2000 | 43.4 | 4:40 | 42.0 | 4:35 | 40.8 | 4:31 | 39.8 | 4:30 | 39.3 | 4:29 |
| 2500 | 53.9 | 5:51 | 52.3 | 5:44 | 50.8 | 5:39 | 49.5 | 5:36 | 48.8 | 5:35 |
| 3000 | 64.2 | 7:02 | 62.3 | 6:53 | 60.6 | 6:47 | 59.0 | 6:43 | 58.1 | 6:41 |
| 3500 | 74.2 | 8:15 | 72.1 | 8:04 | 70.1 | 7:56 | 68.3 | 7:50 | 67.2 | 7:47 |
| 4000 | 84.1 | 9:29 | 81.7 | 9:16 | 79.4 | 9:05 | 77.4 | 8:59 | 76.1 | 8:54 |
| 4500 | 93.8 | 10:45 | 91.1 | 10:29 | 88.5 | 10:16 | 86.3 | 10:08 | 84.7 | 10:01 |
| 5000 | 103.4 | 12:02 | 100.3 | 11:44 | 97.5 | 11:28 | 94.9 | 11:18 | 93.2 | 11:09 |
| 5500 | 112.7 | 13:21 | 109.3 | 12:59 | 106.3 | 12:42 | 103.5 | 12:29 | 101.4 | 12:18 |
| 6000 | 121.9 | 14:41 | 118.2 | 14:17 | 114.9 | 13:56 | 111.8 | 13:41 | 109.5 | 13:28 |

Fuel Required Adjustment (1000 LB)

| REFERENCE FUEL REQUIRED (1000 LB) | WEIGHT AT CHECK POINT (1000 LB) | | | | |
|-----------------------------------|---------------------------------|-------|-----|------|------|
| | 200 | 250 | 300 | 350 | 400 |
| 10 | -1.9 | -1.1 | 0.0 | 2.2 | 7.7 |
| 20 | -3.4 | -2.0 | 0.0 | 3.9 | 11.7 |
| 30 | -5.0 | -2.8 | 0.0 | 5.4 | 15.5 |
| 40 | -6.7 | -3.7 | 0.0 | 6.8 | 18.9 |
| 50 | -8.4 | -4.6 | 0.0 | 8.2 | 22.1 |
| 60 | -10.1 | -5.4 | 0.0 | 9.5 | 25.0 |
| 70 | -11.9 | -6.3 | 0.0 | 10.7 | 27.7 |
| 80 | -13.8 | -7.1 | 0.0 | 11.8 | 30.0 |
| 90 | -15.7 | -8.0 | 0.0 | 12.9 | 32.1 |
| 100 | -17.6 | -8.8 | 0.0 | 13.8 | 33.9 |
| 110 | -19.7 | -9.6 | 0.0 | 14.7 | 35.4 |
| 120 | -21.7 | -10.4 | 0.0 | 15.5 | 36.6 |
| 130 | -23.8 | -11.2 | 0.0 | 16.2 | 37.6 |

Long Range Cruise Wind-Altitude Trade

| PRESSURE ALTITUDE (1000 FT) | CRUISE WEIGHT (1000 LB) | | | | | | | | | | | | | |
|-----------------------------|-------------------------|-----|-----|-----|-----|-----|-----|-----|-----|-----|-----|-----|-----|-----|
| | 420 | 400 | 380 | 360 | 340 | 320 | 300 | 290 | 280 | 270 | 260 | 250 | 240 | 230 |
| 43 | | | | | | | | | | | 30 | 18 | 10 | 4 |
| 41 | | | | | | | | | 23 | 14 | 7 | 3 | 0 | 0 |
| 39 | | | | | | | 16 | 9 | 4 | 1 | 0 | 0 | 2 | 5 |
| 37 | | | | | 24 | 10 | 2 | 0 | 0 | 1 | 3 | 7 | 11 | 16 |
| 35 | | | | 14 | 5 | 0 | 1 | 2 | 5 | 9 | 13 | 18 | 24 | 30 |
| 33 | | 16 | 7 | 1 | 0 | 2 | 7 | 11 | 15 | 20 | 26 | 32 | 39 | 46 |
| 31 | 8 | 2 | 0 | 1 | 4 | 10 | 19 | 24 | 29 | 35 | 41 | 47 | 54 | 61 |
| 29 | 0 | 0 | 3 | 7 | 14 | 22 | 32 | 38 | 44 | 50 | 56 | 62 | 69 | 76 |
| 27 | 2 | 6 | 11 | 18 | 27 | 36 | 47 | 53 | 58 | 64 | 71 | 77 | 83 | 90 |
| 25 | 10 | 16 | 23 | 32 | 41 | 51 | 62 | 67 | 73 | 79 | 85 | 91 | 97 | 103 |

The above wind factor table is for calculation of wind required to maintain present range capability at new pressure altitude, i.e., break-even wind.

Method:

1. Read wind factors for present and new altitudes from table.
2. Determine difference (new altitude wind factor minus present altitude wind factor); This difference may be negative or positive.
3. Break-even wind at new altitude is present altitude wind plus difference from step 2.

Descent at .78/290/250

| PRESSURE ALT (1000 FT) | 5 | 10 | 15 | 17 | 19 | 21 | 23 | 25 | 27 | 29 | 31 | 33 | 35 | 37 | 39 | 41 | 43 |
|------------------------|----|----|----|----|----|----|----|----|----|-----|-----|-----|-----|-----|-----|-----|-----|
| DISTANCE (NM) | 21 | 38 | 58 | 64 | 70 | 77 | 83 | 90 | 96 | 103 | 110 | 115 | 120 | 126 | 131 | 137 | 143 |
| TIME (MINUTES) | 8 | 11 | 15 | 16 | 17 | 18 | 19 | 20 | 21 | 22 | 23 | 23 | 24 | 25 | 26 | 26 | 27 |

**Holding
Flaps Up**

| WEIGHT (1000 LB) | | PRESSURE ALTITUDE (FT) | | | | | | | | |
|---------------------|--------|------------------------|------|-------|-------|-------|-------|-------|-------|-------|
| | | 1500 | 5000 | 10000 | 15000 | 20000 | 25000 | 30000 | 35000 | 40000 |
| 420 | EPR | 1.03 | 1.04 | 1.06 | 1.09 | 1.13 | 1.20 | 1.30 | | |
| | KIAS | 259 | 259 | 259 | 259 | 262 | 264 | 267 | | |
| | FF/ENG | 6770 | 6740 | 6690 | 6580 | 6410 | 6510 | 6690 | | |
| 400 | EPR | 1.03 | 1.04 | 1.05 | 1.08 | 1.12 | 1.18 | 1.27 | | |
| | KIAS | 252 | 252 | 252 | 253 | 255 | 257 | 260 | | |
| | FF/ENG | 6450 | 6410 | 6370 | 6270 | 6090 | 6150 | 6300 | | |
| 380 | EPR | 1.03 | 1.04 | 1.05 | 1.07 | 1.11 | 1.17 | 1.25 | 1.45 | |
| | KIAS | 246 | 246 | 246 | 247 | 248 | 250 | 253 | 263 | |
| | FF/ENG | 6140 | 6080 | 6040 | 5960 | 5790 | 5810 | 5940 | 6600 | |
| 360 | EPR | 1.02 | 1.03 | 1.05 | 1.07 | 1.10 | 1.15 | 1.23 | 1.38 | |
| | KIAS | 239 | 239 | 239 | 240 | 241 | 243 | 246 | 249 | |
| | FF/ENG | 5840 | 5760 | 5710 | 5650 | 5490 | 5470 | 5580 | 5890 | |
| 340 | EPR | 1.02 | 1.03 | 1.04 | 1.06 | 1.09 | 1.14 | 1.20 | 1.33 | |
| | KIAS | 231 | 231 | 232 | 233 | 234 | 236 | 239 | 241 | |
| | FF/ENG | 5540 | 5450 | 5400 | 5340 | 5180 | 5150 | 5230 | 5410 | |
| 320 | EPR | 1.02 | 1.03 | 1.04 | 1.05 | 1.08 | 1.12 | 1.19 | 1.29 | |
| | KIAS | 225 | 225 | 225 | 226 | 227 | 229 | 231 | 234 | |
| | FF/ENG | 5240 | 5150 | 5090 | 5030 | 4880 | 4840 | 4880 | 5010 | |
| 300 | EPR | 1.01 | 1.02 | 1.03 | 1.05 | 1.07 | 1.11 | 1.17 | 1.25 | 1.47 |
| | KIAS | 220 | 220 | 220 | 220 | 220 | 221 | 223 | 226 | 236 |
| | FF/ENG | 4950 | 4850 | 4800 | 4730 | 4580 | 4550 | 4550 | 4660 | 5360 |
| 280 | EPR | 1.01 | 1.02 | 1.03 | 1.04 | 1.06 | 1.09 | 1.15 | 1.22 | 1.38 |
| | KIAS | 215 | 215 | 215 | 215 | 215 | 215 | 215 | 217 | 220 |
| | FF/ENG | 4670 | 4570 | 4510 | 4440 | 4290 | 4280 | 4240 | 4310 | 4630 |
| 260 | EPR | 1.01 | 1.01 | 1.02 | 1.03 | 1.05 | 1.08 | 1.12 | 1.20 | 1.31 |
| | KIAS | 210 | 210 | 210 | 210 | 210 | 210 | 210 | 210 | 212 |
| | FF/ENG | 4380 | 4280 | 4230 | 4150 | 4000 | 4020 | 3980 | 3970 | 4180 |
| 240 | EPR | 1.01 | 1.01 | 1.02 | 1.03 | 1.04 | 1.06 | 1.10 | 1.17 | 1.27 |
| | KIAS | 204 | 204 | 204 | 204 | 204 | 204 | 204 | 204 | 204 |
| | FF/ENG | 4100 | 4010 | 3960 | 3870 | 3720 | 3740 | 3700 | 3680 | 3810 |
| 220 | EPR | 1.00 | 1.01 | 1.01 | 1.02 | 1.03 | 1.05 | 1.08 | 1.14 | 1.22 |
| | KIAS | 199 | 199 | 199 | 199 | 199 | 199 | 199 | 199 | 199 |
| | FF/ENG | 3830 | 3740 | 3700 | 3600 | 3450 | 3460 | 3420 | 3390 | 3510 |

This table includes 5% additional fuel for holding in a racetrack pattern.

Performance Inflight - Advisory Information

Chapter PI Section 22

ADVISORY INFORMATION

Normal Configuration Landing Distance

Flaps 25

Dry Runway

| BRAKING CONFIGURATION | LANDING DISTANCE AND ADJUSTMENT (FT) | | | | | | | | | | | |
|-----------------------|--------------------------------------|--------------------------------|-----------------------------|---------------------|-----------|------------------|---------|-------------------|---------|-------------------------|--------------------|--------|
| | REF DIST | WT ADJ | ALT ADJ | WIND ADJ PER 10 KTS | | SLOPE ADJ PER 1% | | TEMP ADJ PER 10°C | | APP SPD ADJ | REVERSE THRUST ADJ | |
| | 340000 LB LANDING WEIGHT | PER 10000 LB ABV/BLW 340000 LB | PER 1000 FT ABOVE SEA LEVEL | HEAD WIND | TAIL WIND | DOWN HILL | UP HILL | ABV ISA | BLW ISA | PER 10 KTS ABOVE VREF25 | ONE REV | NO REV |
| MAX MANUAL | 3280 | 110/-70 | 80 | -130 | 440 | 50 | -40 | 80 | -80 | 250 | 70 | 140 |
| MAX AUTO | 5490 | 130/-130 | 150 | -250 | 840 | 0 | 0 | 160 | -160 | 600 | 0 | 0 |
| AUTOBRAKE 4 | 5670 | 140/-140 | 160 | -260 | 880 | 0 | 0 | 160 | -160 | 630 | 0 | 0 |
| AUTOBRAKE 3 | 6520 | 160/-160 | 190 | -300 | 1040 | 0 | 0 | 190 | -190 | 740 | 0 | 0 |
| AUTOBRAKE 2 | 7330 | 190/-190 | 220 | -350 | 1190 | 30 | -110 | 230 | -210 | 660 | 60 | 60 |
| AUTOBRAKE 1 | 8040 | 220/-220 | 260 | -400 | 1370 | 170 | -220 | 270 | -230 | 580 | 430 | 520 |

Good Reported Braking Action

| | | | | | | | | | | | | |
|-------------|------|----------|-----|------|------|-----|------|-----|------|-----|-----|-----|
| MAX MANUAL | 4550 | 110/-100 | 130 | -210 | 740 | 130 | -110 | 130 | -120 | 350 | 230 | 520 |
| MAX AUTO | 5500 | 130/-130 | 150 | -250 | 860 | 20 | -10 | 160 | -160 | 600 | 20 | 80 |
| AUTOBRAKE 4 | 5670 | 140/-140 | 160 | -260 | 880 | 10 | 0 | 160 | -160 | 630 | 10 | 50 |
| AUTOBRAKE 3 | 6520 | 160/-160 | 190 | -300 | 1040 | 0 | 0 | 190 | -190 | 740 | 0 | 0 |

Medium Reported Braking Action

| | | | | | | | | | | | | |
|-------------|------|----------|-----|------|------|-----|------|-----|------|-----|-----|------|
| MAX MANUAL | 6300 | 170/-160 | 200 | -330 | 1220 | 310 | -240 | 210 | -180 | 450 | 640 | 1540 |
| MAX AUTO | 6300 | 170/-160 | 200 | -330 | 1220 | 300 | -170 | 210 | -180 | 570 | 610 | 1510 |
| AUTOBRAKE 4 | 6340 | 170/-160 | 200 | -340 | 1220 | 270 | -150 | 210 | -190 | 620 | 550 | 1450 |
| AUTOBRAKE 3 | 6880 | 180/-180 | 210 | -360 | 1280 | 170 | -90 | 220 | -210 | 740 | 350 | 1080 |

Poor Reported Braking Action

| | | | | | | | | | | | | |
|-------------|------|----------|-----|------|------|-----|------|-----|------|-----|------|------|
| MAX MANUAL | 8220 | 240/-230 | 280 | -500 | 1910 | 720 | -460 | 310 | -250 | 520 | 1400 | 3700 |
| MAX AUTO | 8220 | 240/-230 | 280 | -500 | 1910 | 720 | -460 | 310 | -250 | 510 | 1400 | 3710 |
| AUTOBRAKE 4 | 8220 | 240/-230 | 280 | -500 | 1910 | 720 | -460 | 310 | -250 | 510 | 1400 | 3710 |
| AUTOBRAKE 3 | 8230 | 240/-230 | 280 | -500 | 1920 | 690 | -370 | 300 | -260 | 680 | 1340 | 3640 |

Reference distance assumes sea level, standard day, no wind or slope, VREF25 approach speed and 2 engine reverse thrust.

Reference distance for manual braking is applicable for auto spoilers only, for manual spoilers operation increase landing distance by 400 ft.

Reference distance for auto braking is applicable for auto or manual spoilers.

Includes distance from 50 ft above threshold (1000 ft of air distance).

Actual (unfactored) distances are shown.

ADVISORY INFORMATION

Normal Configuration Landing Distance

Flaps 30

Dry Runway

| BRAKING CONFIGURATION | LANDING DISTANCE AND ADJUSTMENT (FT) | | | | | | | | | | | |
|-----------------------|--------------------------------------|--------------------------------|-----------------------------|---------------------|-----------|------------------|---------|-------------------|-----------|-------------------------|--------------------|--------|
| | REF DIST | WT ADJ | ALT ADJ | WIND ADJ PER 10 KTS | | SLOPE ADJ PER 1% | | TEMP ADJ PER 10°C | | APP SPD ADJ | REVERSE THRUST ADJ | |
| | 340000 LB LANDING WEIGHT | PER 10000 LB ABV/BLW 340000 LB | PER 1000 FT ABOVE SEA LEVEL | HEAD WIND | TAIL WIND | DOWN HILL | UP HILL | ABOVE ISA | BELOW ISA | PER 10 KTS ABOVE VREF30 | ONE REV | NO REV |
| MAX MANUAL | 3250 | 140/-70 | 80 | -130 | 440 | 50 | -50 | 80 | -80 | 260 | 60 | 130 |
| MAX AUTO | 5380 | 210/-140 | 150 | -240 | 830 | 0 | 0 | 150 | -150 | 600 | 0 | 0 |
| AUTOBRAKE 4 | 5550 | 220/-140 | 150 | -250 | 870 | 0 | 0 | 160 | -160 | 620 | 0 | 0 |
| AUTOBRAKE 3 | 6380 | 260/-170 | 180 | -300 | 1020 | 0 | 0 | 190 | -190 | 730 | 0 | 0 |
| AUTOBRAKE 2 | 7200 | 280/-200 | 210 | -350 | 1180 | 10 | -100 | 220 | -210 | 670 | 30 | 30 |
| AUTOBRAKE 1 | 7920 | 300/-220 | 250 | -400 | 1360 | 160 | -210 | 260 | -230 | 580 | 350 | 440 |

Good Reported Braking Action

| | | | | | | | | | | | | |
|-------------|------|----------|-----|------|------|-----|------|-----|------|-----|-----|-----|
| MAX MANUAL | 4520 | 160/-110 | 120 | -210 | 740 | 130 | -110 | 130 | -120 | 350 | 220 | 480 |
| MAX AUTO | 5390 | 210/-140 | 150 | -250 | 850 | 20 | -10 | 150 | -150 | 600 | 20 | 80 |
| AUTOBRAKE 4 | 5560 | 220/-140 | 160 | -250 | 870 | 10 | 0 | 160 | -160 | 620 | 10 | 50 |
| AUTOBRAKE 3 | 6380 | 260/-170 | 180 | -300 | 1020 | 0 | 0 | 190 | -190 | 730 | 0 | 0 |

Medium Reported Braking Action

| | | | | | | | | | | | | |
|-------------|------|----------|-----|------|------|-----|------|-----|------|-----|-----|------|
| MAX MANUAL | 6260 | 230/-170 | 200 | -330 | 1220 | 320 | -250 | 210 | -180 | 450 | 600 | 1430 |
| MAX AUTO | 6260 | 250/-170 | 190 | -330 | 1220 | 310 | -190 | 210 | -180 | 550 | 600 | 1420 |
| AUTOBRAKE 4 | 6270 | 250/-170 | 200 | -330 | 1220 | 290 | -160 | 200 | -190 | 600 | 550 | 1380 |
| AUTOBRAKE 3 | 6760 | 280/-190 | 210 | -350 | 1280 | 180 | -100 | 210 | -200 | 730 | 360 | 1030 |

Poor Reported Braking Action

| | | | | | | | | | | | | |
|-------------|------|----------|-----|------|------|-----|------|-----|------|-----|------|------|
| MAX MANUAL | 8180 | 310/-240 | 280 | -500 | 1920 | 730 | -470 | 300 | -250 | 520 | 1320 | 3420 |
| MAX AUTO | 8180 | 310/-240 | 280 | -500 | 1910 | 730 | -470 | 300 | -250 | 520 | 1320 | 3430 |
| AUTOBRAKE 4 | 8180 | 310/-240 | 280 | -500 | 1910 | 730 | -470 | 300 | -250 | 520 | 1320 | 3430 |
| AUTOBRAKE 3 | 8180 | 330/-240 | 280 | -500 | 1920 | 720 | -380 | 300 | -260 | 670 | 1290 | 3390 |

Reference distance assumes sea level, standard day, no wind or slope, VREF30 approach speed and 2 engine reverse thrust.

Reference distance for manual braking is applicable for auto spoilers only, for manual spoilers operation increase landing distance by 400 ft.

Reference distance for auto braking is applicable for both auto and manual spoilers.

Includes distance from 50 ft above threshold (1000 ft of air distance).

Actual (unfactored) distances are shown.

ADVISORY INFORMATION**Non-Normal Configuration Landing Distance
Dry Runway**

| | | LANDING DISTANCES AND ADJUSTMENTS (FT) | | | | | | | | | |
|--|-----------|--|---|-------------------------------|--|-------------------------------|--------------------------------|------------------------------|--------------------------|-----------|--|
| | | REF DIST | WT ADJ | ALT ADJ | WIND ADJ | SLOPE ADJ | TEMP ADJ | APP SPD ADJ | REVERSE THRUST ADJ | | |
| LANDING CONFIGURATION | VREF | 340000 LB LDG WT | PER 10000 LB ABV/BLW 340000 LB | PER 1000 FT ABV S.L. | PER 10 KTS HEAD/ TAIL WIND | PER 1% DOWN/ UP HILL | PER 10°C ABV/ BLW ISA | PER 10 KTS ABV VREF | ONE REV | NO REV | |
| AIR/GRD SYS (FLAPS 25) | VREF25 | 4260 | 80/-90 | 110 | -170/560 | 80/-70 | 100/-100 | 420 | 0 | 0 | |
| AIR/GRD SYS (FLAPS 30) | VREF30 | 4230 | 150/-90 | 110 | -170/570 | 90/-80 | 100/-100 | 440 | 0 | 0 | |
| ALL FLAPS AND SLATS UP LANDING | VREF30+50 | 4780 | 240/-100 | 130 | -170/570 | 80/-70 | 130/-130 | 330 | 180 | 390 | |
| ANTI-SKID OFF (FLAPS 25) | VREF25 | 6150 | 140/-140 | 170 | -300/1040 | 200/-170 | 170/-160 | 450 | 380 | 870 | |
| ANTI-SKID OFF (FLAPS 30) | VREF30 | 6060 | 210/-140 | 160 | -290/1030 | 200/-170 | 170/-160 | 450 | 350 | 800 | |
| ENGINE FAILURE (FLAPS 20) | VREF20 | 3550 | 130/-70 | 90 | -140/470 | 60/-50 | 90/-90 | 280 | 0 | 90 | |
| HYD SYS PRESS (C ONLY) (FLAPS 20) | VREF20 | 4260 | 100/-90 | 100 | -160/540 | 70/-60 | 110/-100 | 390 | 120 | 260 | |
| HYD SYS PRESS (L ONLY) (FLAPS 25) | VREF25 | 3530 | 80/-70 | 90 | -140/480 | 60/-60 | 90/-80 | 300 | 0 | 90 | |
| HYD SYS PRESS (L ONLY) (FLAPS 30) | VREF30 | 3510 | 120/-70 | 90 | -140/480 | 60/-60 | 90/-80 | 310 | 0 | 80 | |
| HYD SYS PRESS (R ONLY) (FLAPS 25) | VREF25 | 3910 | 80/-80 | 100 | -160/560 | 80/-70 | 100/-100 | 340 | 0 | 130 | |
| HYD SYS PRESS (R ONLY) (FLAPS 30) | VREF30 | 3890 | 130/-80 | 100 | -160/560 | 80/-80 | 100/-100 | 350 | 0 | 130 | |
| HYD SYS PRESS (L AND C) (FLAPS 20) | VREF30+20 | 5310 | 180/-110 | 140 | -190/640 | 120/-110 | 140/-140 | 570 | 0 | 250 | |
| HYD SYS PRESS (L AND R) (FLAPS 20) | VREF30+20 | 5280 | 180/-110 | 140 | -210/700 | 150/-130 | 150/-140 | 520 | 0 | 0 | |
| HYD SYS PRESS (R AND C) (FLAPS 20) | VREF30+20 | 6470 | 230/-140 | 180 | -250/850 | 210/-180 | 190/-180 | 670 | 0 | 510 | |

*Reference distance assumes sea level, standard day with no wind or slope.

Actual (unfactored) distances are shown.

Includes distance from 50 ft above runway threshold (1000 ft of air distance).

Assumes max manual braking and maximum reverse thrust when available on operating engine(s).

ADVISORY INFORMATION

**Non-Normal Configuration Landing Distance
Dry Runway**

| | | LANDING DISTANCES AND ADJUSTMENTS (FT) | | | | | | | | |
|---|-----------|--|--------------------------------|----------------------|----------------------------|----------------------|-----------------------|---------------------|--------------------|--------|
| LANDING CONFIGURATION | VREF | REF DIST | WT ADJ | ALT ADJ | WIND ADJ | SLOPE ADJ | TEMP ADJ | APP SPD ADJ | REVERSE THRUST ADJ | |
| | | 340000 LB LDG WT | PER 10000 LB ABV/BLW 340000 LB | PER 1000 FT ABV S.L. | PER 10 KTS HEAD/ TAIL WIND | PER 1% DOWN/ UP HILL | PER 10°C ABV/ BLW ISA | PER 10 KTS ABV VREF | ONE REV | NO REV |
| LE SLAT ASYM (FLAPS > 20) | VREF30+20 | 3820 | 160/-80 | 100 | -140/490 | 60/-50 | 100/-90 | 280 | 100 | 220 |
| LE SLAT ASYM (FLAPS = 20) | VREF30+30 | 4300 | 150/-90 | 110 | -160/520 | 70/-60 | 120/-110 | 310 | 140 | 290 |
| LE SLAT ASYM (5 < FLAPS < 20) | VREF30+40 | 4610 | 160/-90 | 120 | -160/540 | 80/-70 | 130/-120 | 320 | 160 | 340 |
| LE SLAT DISAGREE (FLAPS > 20) | VREF20 | 3490 | 130/-70 | 80 | -130/460 | 50/-50 | 90/-80 | 270 | 80 | 180 |
| LE SLAT DISAGREE - ALTN FLAP EXT ACOMPLISHED (FLAPS = 20) | VREF20 | 3490 | 130/-70 | 80 | -130/460 | 50/-50 | 90/-80 | 270 | 80 | 180 |
| LE SLAT DISAGREE - ALTN FLAP EXT FAILED (FLAPS = 20) | VREF30+30 | 4090 | 170/-80 | 100 | -150/500 | 60/-60 | 110/-100 | 280 | 120 | 250 |
| REVERSER UNLOCKED (FLAPS 20) | VREF30+30 | 4410 | 160/-90 | 110 | -160/540 | 80/-70 | 120/-110 | 330 | 0 | 150 |
| TE FLAP ASYM (FLAPS ≥ 20) | VREF20 | 3490 | 130/-70 | 80 | -130/460 | 50/-50 | 90/-80 | 270 | 80 | 180 |
| TE FLAP ASYM (5 < FLAPS < 20) | VREF30+20 | 3820 | 160/-80 | 100 | -140/490 | 60/-50 | 100/-90 | 280 | 100 | 220 |
| TE FLAP ASYM (FLAPS ≤ 5) | VREF30+30 | 4040 | 200/-80 | 100 | -150/500 | 60/-60 | 110/-100 | 270 | 110 | 250 |
| TE FLAP DISAGREE (FLAPS ≥ 20) | VREF20 | 3490 | 130/-70 | 80 | -130/460 | 50/-50 | 90/-80 | 270 | 80 | 180 |
| TE FLAP DISAGREE (5 < FLAPS < 20) | VREF30+20 | 3820 | 160/-80 | 100 | -140/490 | 60/-50 | 100/-90 | 280 | 100 | 220 |
| TE FLAP DISAGREE (FLAPS ≤ 5) | VREF30+30 | 4040 | 200/-80 | 100 | -150/500 | 60/-60 | 110/-100 | 270 | 110 | 250 |

*Reference distance assumes sea level, standard day with no wind or slope.

Actual (unfactored) distances are shown.

Includes distance from 50 ft above runway threshold (1000 ft of air distance).

Assumes max manual braking and maximum reverse thrust when available on operating engine(s).

ADVISORY INFORMATION**Non-Normal Configuration Landing Distance****Good Reported Braking Action**

| LANDING CONFIGURATION | VREF | LANDING DISTANCES AND ADJUSTMENTS (FT) | | | | | | | | | |
|------------------------------------|-----------|--|--------------------------------|----------------------|----------------------------|----------------------|-----------------------|---------------------|--------------------|--------|--|
| | | REF DIST | WT ADJ | ALT ADJ | WIND ADJ | SLOPE ADJ | TEMP ADJ | APP SPD ADJ | REVERSE THRUST ADJ | | |
| | | 340000 LB LDG WT | PER 10000 LB ABV/BLW 340000 LB | PER 1000 FT ABV S.L. | PER 10 KTS HEAD/ TAIL WIND | PER 1% DOWN/ UP HILL | PER 10°C ABV/ BLW ISA | PER 10 KTS ABV VREF | ONE REV | NO REV | |
| AIR/GRD SYS (FLAPS 25) | VREF25 | 6270 | 140/-140 | 180 | -290/990 | 260/-220 | 170/-170 | 620 | 0 | 0 | |
| AIR/GRD SYS (FLAPS 30) | VREF30 | 6210 | 230/-140 | 180 | -290/990 | 270/-220 | 170/-170 | 630 | 0 | 0 | |
| ALL FLAPS AND SLATS UP LANDING | VREF30+50 | 6500 | 200/-140 | 200 | -260/870 | 170/-150 | 210/-180 | 380 | 490 | 1120 | |
| ANTI-SKID OFF (FLAPS 25) | VREF25 | 6960 | 170/-170 | 200 | -360/1280 | 300/-240 | 210/-190 | 490 | 590 | 1410 | |
| ANTI-SKID OFF (FLAPS 30) | VREF30 | 6860 | 240/-170 | 200 | -360/1280 | 310/-240 | 200/-180 | 490 | 550 | 1290 | |
| ENGINE FAILURE (FLAPS 20) | VREF20 | 5140 | 140/-120 | 140 | -230/810 | 160/-140 | 150/-140 | 410 | 0 | 360 | |
| HYD SYS PRESS (C ONLY) (FLAPS 20) | VREF20 | 5820 | 160/-140 | 170 | -250/860 | 180/-150 | 170/-150 | 510 | 400 | 920 | |
| HYD SYS PRESS (L ONLY) (FLAPS 25) | VREF25 | 5060 | 120/-120 | 140 | -240/820 | 170/-140 | 140/-140 | 430 | 0 | 330 | |
| HYD SYS PRESS (L ONLY) (FLAPS 30) | VREF30 | 5030 | 180/-120 | 140 | -240/820 | 170/-150 | 140/-140 | 440 | 0 | 310 | |
| HYD SYS PRESS (R ONLY) (FLAPS 25) | VREF25 | 5060 | 120/-120 | 140 | -240/820 | 170/-140 | 140/-140 | 430 | 0 | 330 | |
| HYD SYS PRESS (R ONLY) (FLAPS 30) | VREF30 | 5030 | 180/-120 | 140 | -240/820 | 170/-150 | 140/-140 | 440 | 0 | 310 | |
| HYD SYS PRESS (L AND C) (FLAPS 20) | VREF30+20 | 7530 | 280/-170 | 220 | -310/1050 | 310/-260 | 230/-210 | 750 | 0 | 850 | |
| HYD SYS PRESS (L AND R) (FLAPS 20) | VREF30+20 | 7210 | 250/-160 | 210 | -310/1050 | 330/-270 | 210/-210 | 690 | 0 | 0 | |
| HYD SYS PRESS (R AND C) (FLAPS 20) | VREF30+20 | 7530 | 280/-170 | 220 | -310/1050 | 310/-260 | 230/-210 | 750 | 0 | 850 | |

*Reference distance assumes sea level, standard day with no wind or slope.

Actual (unfactored) distances are shown.

Includes distance from 50 ft above runway threshold (1000 ft of air distance).

Assumes max manual braking and maximum reverse thrust when available on operating engine(s).

ADVISORY INFORMATION

Non-Normal Configuration Landing Distance

Good Reported Braking Action

| | | LANDING DISTANCES AND ADJUSTMENTS (FT) | | | | | | | | |
|---|-----------|--|--------------------------------|----------------------|----------------------------|----------------------|-----------------------|---------------------|--------------------|--------|
| | | REF DIST | WT ADJ | ALT ADJ | WIND ADJ | SLOPE ADJ | TEMP ADJ | APP SPD ADJ | REVERSE THRUST ADJ | |
| LANDING CONFIGURATION | VREF | 340000 LB LDG WT | PER 10000 LB ABV/BLW 340000 LB | PER 1000 FT ABV S.L. | PER 10 KTS HEAD/ TAIL WIND | PER 1% DOWN/ UP HILL | PER 10°C ABV/ BLW ISA | PER 10 KTS ABV VREF | ONE REV | NO REV |
| LE SLAT ASYM (FLAPS > 20) | VREF30+20 | 5370 | 180/-120 | 160 | -230/800 | 150/-130 | 160/-150 | 380 | 340 | 770 |
| LE SLAT ASYM (FLAPS = 20) | VREF30+30 | 6040 | 200/-140 | 180 | -250/860 | 180/-150 | 190/-170 | 430 | 430 | 990 |
| LE SLAT ASYM (5 < FLAPS < 20) | VREF30+40 | 6470 | 210/-140 | 200 | -260/890 | 190/-160 | 210/-180 | 430 | 480 | 1100 |
| LE SLAT DISAGREE (FLAPS > 20) | VREF20 | 4910 | 130/-110 | 140 | -220/770 | 140/-120 | 140/-130 | 380 | 290 | 670 |
| LE SLAT DISAGREE - ALTN FLAP EXT ACOMPLISHED (FLAPS = 20) | VREF20 | 4910 | 130/-110 | 140 | -220/770 | 140/-120 | 140/-130 | 380 | 290 | 670 |
| LE SLAT DISAGREE - ALTN FLAP EXT FAILED (FLAPS = 20) | VREF30+30 | 5760 | 180/-130 | 170 | -240/830 | 160/-140 | 180/-160 | 390 | 380 | 860 |
| REVERSER UNLOCKED (FLAPS 20) | VREF30+30 | 6400 | 210/-150 | 190 | -270/910 | 210/-180 | 200/-180 | 470 | 0 | 540 |
| TE FLAP ASYM (FLAPS ≥ 20) | VREF20 | 4910 | 130/-110 | 140 | -220/770 | 140/-120 | 140/-130 | 380 | 290 | 670 |
| TE FLAP ASYM (5 < FLAPS < 20) | VREF30+20 | 5390 | 180/-120 | 160 | -230/800 | 150/-130 | 160/-150 | 380 | 350 | 790 |
| TE FLAP ASYM (FLAPS ≤ 5) | VREF30+30 | 5730 | 180/-130 | 170 | -240/820 | 150/-140 | 180/-160 | 380 | 390 | 890 |
| TE FLAP DISAGREE (FLAPS ≥ 20) | VREF20 | 4910 | 130/-110 | 140 | -220/770 | 140/-120 | 140/-130 | 380 | 290 | 670 |
| TE FLAP DISAGREE (5 < FLAPS < 20) | VREF30+20 | 5390 | 180/-120 | 160 | -230/800 | 150/-130 | 160/-150 | 380 | 350 | 790 |
| TE FLAP DISAGREE (FLAPS ≤ 5) | VREF30+30 | 5730 | 180/-130 | 170 | -240/820 | 150/-140 | 180/-160 | 380 | 390 | 890 |

*Reference distance assumes sea level, standard day with no wind or slope.

Actual (unfactored) distances are shown.

Includes distance from 50 ft above runway threshold (1000 ft of air distance).

Assumes max manual braking and maximum reverse thrust when available on operating engine(s).

ADVISORY INFORMATION**Non-Normal Configuration Landing Distance****Medium Reported Braking Action**

| LANDING CONFIGURATION | VREF | LANDING DISTANCES AND ADJUSTMENTS (FT) | | | | | | | | | |
|------------------------------------|-----------|--|--------------------------------|----------------------|----------------------------|----------------------|-----------------------|---------------------|--------------------|--------|--|
| | | REF DIST | WT ADJ | ALT ADJ | WIND ADJ | SLOPE ADJ | TEMP ADJ | APP SPD ADJ | REVERSE THRUST ADJ | | |
| | | 340000 LB LDG WT | PER 10000 LB ABV/BLW 340000 LB | PER 1000 FT ABV S.L. | PER 10 KTS HEAD/ TAIL WIND | PER 1% DOWN/ UP HILL | PER 10°C ABV/ BLW ISA | PER 10 KTS ABV VREF | ONE REV | NO REV | |
| AIR/GRD SYS (FLAPS 25) | VREF25 | 9830 | 220/-210 | 330 | -530/1860 | 920/-630 | 290/-300 | 850 | 0 | 0 | |
| AIR/GRD SYS (FLAPS 30) | VREF30 | 9660 | 340/-220 | 330 | -530/1850 | 910/-620 | 290/-290 | 860 | 0 | 0 | |
| ALL FLAPS AND SLATS UP LANDING | VREF30+50 | 9300 | 310/-230 | 320 | -410/1450 | 430/-350 | 340/-280 | 520 | 1370 | 3500 | |
| ANTI-SKID OFF (FLAPS 25) | VREF25 | 8860 | 240/-230 | 280 | -530/1980 | 720/-470 | 290/-260 | 560 | 1310 | 3460 | |
| ANTI-SKID OFF (FLAPS 30) | VREF30 | 8750 | 320/-230 | 280 | -530/1980 | 730/-480 | 290/-260 | 570 | 1230 | 3170 | |
| ENGINE FAILURE (FLAPS 20) | VREF20 | 7540 | 220/-200 | 240 | -390/1390 | 450/-350 | 250/-220 | 570 | 0 | 1150 | |
| HYD SYS PRESS (C ONLY) (FLAPS 20) | VREF20 | 7910 | 240/-210 | 260 | -390/1390 | 420/-330 | 270/-230 | 630 | 1060 | 2730 | |
| HYD SYS PRESS (L ONLY) (FLAPS 25) | VREF25 | 7350 | 190/-180 | 230 | -400/1410 | 470/-350 | 240/-210 | 560 | 0 | 1030 | |
| HYD SYS PRESS (L ONLY) (FLAPS 30) | VREF30 | 7280 | 270/-190 | 230 | -400/1410 | 470/-360 | 230/-210 | 570 | 0 | 950 | |
| HYD SYS PRESS (R ONLY) (FLAPS 25) | VREF25 | 7350 | 190/-180 | 230 | -400/1410 | 470/-350 | 240/-210 | 560 | 0 | 1030 | |
| HYD SYS PRESS (R ONLY) (FLAPS 30) | VREF30 | 7280 | 270/-190 | 230 | -400/1410 | 470/-360 | 230/-210 | 570 | 0 | 950 | |
| HYD SYS PRESS (L AND C) (FLAPS 20) | VREF30+20 | 10730 | 400/-270 | 350 | -510/1750 | 790/-580 | 370/-320 | 920 | 0 | 2440 | |
| HYD SYS PRESS (L AND R) (FLAPS 20) | VREF30+20 | 11520 | 400/-260 | 350 | -570/1950 | 1090/-760 | 360/-350 | 960 | 0 | 0 | |
| HYD SYS PRESS (R AND C) (FLAPS 20) | VREF30+20 | 10730 | 400/-270 | 350 | -510/1750 | 790/-580 | 370/-320 | 920 | 0 | 2440 | |

*Reference distance assumes sea level, standard day with no wind or slope.

Actual (unfactored) distances are shown.

Includes distance from 50 ft above runway threshold (1000 ft of air distance).

Assumes max manual braking and maximum reverse thrust when available on operating engine(s).

ADVISORY INFORMATION

Non-Normal Configuration Landing Distance

Medium Reported Braking Action

| | | LANDING DISTANCES AND ADJUSTMENTS (FT) | | | | | | | | |
|---|-----------|--|--------------------------------|----------------------|----------------------------|----------------------|-----------------------|---------------------|--------------------|--------|
| | | REF DIST | WT ADJ | ALT ADJ | WIND ADJ | SLOPE ADJ | TEMP ADJ | APP SPD ADJ | REVERSE THRUST ADJ | |
| LANDING CONFIGURATION | VREF | 340000 LB LDG WT | PER 10000 LB ABV/BLW 340000 LB | PER 1000 FT ABV S.L. | PER 10 KTS HEAD/ TAIL WIND | PER 1% DOWN/ UP HILL | PER 10°C ABV/ BLW ISA | PER 10 KTS ABV VREF | ONE REV | NO REV |
| LE SLAT ASYM (FLAPS > 20) | VREF30+20 | 7480 | 270/-190 | 250 | -370/1320 | 370/-290 | 260/-220 | 490 | 920 | 2270 |
| LE SLAT ASYM (FLAPS = 20) | VREF30+30 | 8340 | 290/-210 | 280 | -400/1390 | 410/-330 | 300/-250 | 530 | 1110 | 2770 |
| LE SLAT ASYM (5 < FLAPS < 20) | VREF30+40 | 8920 | 300/-220 | 310 | -410/1430 | 430/-350 | 320/-270 | 540 | 1280 | 3250 |
| LE SLAT DISAGREE (FLAPS > 20) | VREF20 | 6870 | 200/-180 | 220 | -360/1270 | 350/-280 | 230/-200 | 490 | 830 | 2040 |
| LE SLAT DISAGREE - ALTN FLAP EXT ACOMPLISHED (FLAPS = 20) | VREF20 | 6870 | 200/-180 | 220 | -360/1270 | 350/-280 | 230/-200 | 490 | 830 | 2040 |
| LE SLAT DISAGREE - ALTN FLAP EXT FAILED (FLAPS = 20) | VREF30+30 | 7970 | 270/-200 | 260 | -380/1360 | 380/-310 | 280/-240 | 490 | 1000 | 2460 |
| REVERSER UNLOCKED (FLAPS 20) | VREF30+30 | 9270 | 320/-230 | 300 | -440/1530 | 550/-430 | 320/-280 | 620 | 0 | 1580 |
| TE FLAP ASYM (FLAPS ≥ 20) | VREF20 | 6870 | 200/-180 | 220 | -360/1270 | 350/-280 | 230/-200 | 490 | 830 | 2040 |
| TE FLAP ASYM (5 < FLAPS < 20) | VREF30+20 | 7540 | 270/-190 | 250 | -370/1320 | 370/-290 | 260/-220 | 490 | 950 | 2370 |
| TE FLAP ASYM (FLAPS ≤ 5) | VREF30+30 | 8030 | 280/-200 | 270 | -380/1360 | 380/-310 | 280/-240 | 490 | 1050 | 2640 |
| TE FLAP DISAGREE (FLAPS ≥ 20) | VREF20 | 6870 | 200/-180 | 220 | -360/1270 | 350/-280 | 230/-200 | 490 | 830 | 2040 |
| TE FLAP DISAGREE (5 < FLAPS < 20) | VREF30+20 | 7540 | 270/-190 | 250 | -370/1320 | 370/-290 | 260/-220 | 490 | 950 | 2370 |
| TE FLAP DISAGREE (FLAPS ≤ 5) | VREF30+30 | 8030 | 280/-200 | 270 | -380/1360 | 380/-310 | 280/-240 | 490 | 1050 | 2640 |

*Reference distance assumes sea level, standard day with no wind or slope.

Actual (unfactored) distances are shown.

Includes distance from 50 ft above runway threshold (1000 ft of air distance).

Assumes max manual braking and maximum reverse thrust when available on operating engine(s).

ADVISORY INFORMATION**Non-Normal Configuration Landing Distance****Poor Reported Braking Action**

| | | LANDING DISTANCES AND ADJUSTMENTS (FT) | | | | | | | | |
|------------------------------------|-----------|--|--------------------------------|---------------------|----------------------------|----------------------|-----------------------|---------------------|--------------------|--------|
| LANDING CONFIGURATION | VREF | REF DIST | WT ADJ | ALT ADJ | WIND ADJ | SLOPE ADJ | TEMP ADJ | APP SPD ADJ | REVERSE THRUST ADJ | |
| | | 340000 LB LDG WT | PER 10000 LB ABV/BLW 340000 LB | PER 1000FT ABV S.L. | PER 10 KTS HEAD/ TAIL WIND | PER 1% DOWN/ UP HILL | PER 10°C ABV/ BLW ISA | PER 10 KTS ABV VREF | ONE REV | NO REV |
| AIR/GRD SYS (FLAPS 25) | VREF25 | 15630 | 310/-270 | 640 | -1010/3750 | 4210/-1740 | 490/-490 | 1060 | 0 | 0 |
| AIR/GRD SYS (FLAPS 30) | VREF30 | 15230 | 460/-270 | 620 | -990/3710 | 4120/-1700 | 480/-480 | 1050 | 0 | 0 |
| ALL FLAPS AND SLATS UP LANDING | VREF30+50 | 12380 | 440/-330 | 470 | -620/2260 | 990/-680 | 500/-390 | 640 | 2960 | 8700 |
| ANTI-SKID OFF (FLAPS 25) | VREF25 | 11990 | 350/-340 | 420 | -890/3770 | 4840/-1110 | 430/-410 | 630 | 3680 | 14100 |
| ANTI-SKID OFF (FLAPS 30) | VREF30 | 11880 | 440/-340 | 410 | -890/3770 | 4800/-1120 | 420/-410 | 630 | 3500 | 13210 |
| ENGINE FAILURE (FLAPS 20) | VREF20 | 10460 | 330/-290 | 360 | -620/2270 | 1170/-740 | 370/-330 | 700 | 0 | 2870 |
| HYD SYS PRESS (C ONLY) (FLAPS 20) | VREF20 | 10190 | 330/-290 | 370 | -580/2140 | 950/-620 | 380/-310 | 720 | 2220 | 6470 |
| HYD SYS PRESS (L ONLY) (FLAPS 25) | VREF25 | 10200 | 280/-270 | 340 | -640/2380 | 1280/-760 | 360/-310 | 670 | 0 | 2580 |
| HYD SYS PRESS (L ONLY) (FLAPS 30) | VREF30 | 10090 | 370/-270 | 340 | -640/2380 | 1290/-760 | 350/-310 | 670 | 0 | 2360 |
| HYD SYS PRESS (R ONLY) (FLAPS 25) | VREF25 | 10200 | 280/-270 | 340 | -640/2380 | 1280/-760 | 360/-310 | 670 | 0 | 2580 |
| HYD SYS PRESS (R ONLY) (FLAPS 30) | VREF30 | 10090 | 370/-270 | 340 | -640/2380 | 1290/-760 | 350/-310 | 670 | 0 | 2360 |
| HYD SYS PRESS (L AND C) (FLAPS 20) | VREF30+20 | 14580 | 550/-390 | 520 | -800/2860 | 1980/-1170 | 550/-450 | 1040 | 0 | 5800 |
| HYD SYS PRESS (L AND R) (FLAPS 20) | VREF30+20 | 17950 | 570/-390 | 550 | -1020/3640 | 3920/-1910 | 580/-540 | 1190 | 0 | 0 |
| HYD SYS PRESS (R AND C) (FLAPS 20) | VREF30+20 | 14580 | 550/-390 | 520 | -800/2860 | 1980/-1170 | 550/-450 | 1040 | 0 | 5800 |

*Reference distance assumes sea level, standard day with no wind or slope.

Actual (unfactored) distances are shown.

Includes distance from 50 ft above runway threshold (1000 ft of air distance).

Assumes max manual braking and maximum reverse thrust when available on operating engine(s).

ADVISORY INFORMATION

Non-Normal Configuration Landing Distance

Poor Reported Braking Action

| LANDING CONFIGURATION | VREF | LANDING DISTANCES AND ADJUSTMENTS (FT) | | | | | | | | |
|---|-----------|--|--------------------------------|---------------------|----------------------------|----------------------|-----------------------|---------------------|--------------------|--------|
| | | REF DIST | WT ADJ | ALT ADJ | WIND ADJ | SLOPE ADJ | TEMP ADJ | APP SPD ADJ | REVERSE THRUST ADJ | |
| | | 340000 LB LDG WT | PER 10000 LB ABV/BLW 340000 LB | PER 1000FT ABV S.L. | PER 10 KTS HEAD/ TAIL WIND | PER 1% DOWN/ UP HILL | PER 10°C ABV/ BLW ISA | PER 10 KTS ABV VREF | ONE REV | NO REV |
| LE SLAT ASYM (FLAPS > 20) | VREF30+20 | 9770 | 360/-270 | 350 | -550/2060 | 850/-560 | 370/-310 | 570 | 1940 | 5350 |
| LE SLAT ASYM (FLAPS = 20) | VREF30+30 | 10790 | 390/-290 | 400 | -580/2150 | 920/-620 | 420/-340 | 610 | 2250 | 6270 |
| LE SLAT ASYM (5 < FLAPS < 20) | VREF30+40 | 11640 | 420/-320 | 440 | -610/2210 | 970/-650 | 460/-370 | 630 | 2640 | 7610 |
| LE SLAT DISAGREE (FLAPS > 20) | VREF20 | 9060 | 290/-250 | 320 | -540/2010 | 820/-540 | 340/-280 | 580 | 1800 | 4970 |
| LE SLAT DISAGREE - ALTN FLAP EXT ACOMPLISHED (FLAPS = 20) | VREF20 | 9060 | 290/-250 | 320 | -540/2010 | 820/-540 | 340/-280 | 580 | 1800 | 4970 |
| LE SLAT DISAGREE - ALTN FLAP EXT FAILED (FLAPS = 20) | VREF30+30 | 10340 | 370/-280 | 370 | -570/2100 | 870/-580 | 390/-330 | 560 | 2050 | 5650 |
| REVERSER UNLOCKED (FLAPS 20) | VREF30+30 | 12610 | 450/-340 | 440 | -680/2450 | 1340/-860 | 470/-400 | 730 | 0 | 3680 |
| TE FLAP ASYM (FLAPS ≥ 20) | VREF20 | 9060 | 290/-250 | 320 | -540/2010 | 820/-540 | 340/-280 | 580 | 1800 | 4970 |
| TE FLAP ASYM (5 < FLAPS < 20) | VREF30+20 | 9930 | 370/-270 | 360 | -560/2070 | 850/-570 | 380/-310 | 590 | 2100 | 5920 |
| TE FLAP ASYM (FLAPS ≤ 5) | VREF30+30 | 10520 | 380/-280 | 380 | -570/2120 | 870/-590 | 410/-330 | 580 | 2220 | 6260 |
| TE FLAP DISAGREE (FLAPS ≥ 20) | VREF20 | 9060 | 290/-250 | 320 | -540/2010 | 820/-540 | 340/-280 | 580 | 1800 | 4970 |
| TE FLAP DISAGREE (5 < FLAPS < 20) | VREF30+20 | 9930 | 370/-270 | 360 | -560/2070 | 850/-570 | 380/-310 | 590 | 2100 | 5920 |
| TE FLAP DISAGREE (FLAPS ≤ 5) | VREF30+30 | 10520 | 380/-280 | 380 | -570/2120 | 870/-590 | 410/-330 | 580 | 2220 | 6260 |

*Reference distance assumes sea level, standard day with no wind or slope.

Actual (unfactored) distances are shown.

Includes distance from 50 ft above runway threshold (1000 ft of air distance).

Assumes max manual braking and maximum reverse thrust when available on operating engine(s).

ADVISORY INFORMATION

Recommended Brake Cooling Schedule

Reference Brake Energy Per Brake (Millions of Foot Pounds)

| WEIGHT (1000 LB) | | OAT °F °C | | BRAKES ON SPEED (KIAS)* | | | | | | | | | | | | | | | | | | | | | | | | | | | | | | | | | | | |
|---------------------|-----|--------------|------|-----------------------------|------|------|------|------|------|------|------|------|------|------|------|------|------|------|------|------|---|-----|---|---|---|--|--|-----|--|--|--|--|--|-----|--|--|--|--|--|
| | | | | 80 | | | | | | 100 | | | | | | 120 | | | | | | 140 | | | | | | 160 | | | | | | 180 | | | | | |
| | | | | PRESSURE ALTITUDE (1000 FT) | | | | | | | | | | | | | | | | | | | | | | | | | | | | | | | | | | | |
| | | 0 | 2 | 4 | 0 | 2 | 4 | 0 | 2 | 4 | 0 | 2 | 4 | 0 | 2 | 4 | 0 | 2 | 4 | 0 | 2 | 4 | 0 | 2 | 4 | | | | | | | | | | | | | | |
| 420 | 40 | 4 | 15.9 | 16.9 | 17.9 | 24.0 | 25.5 | 27.1 | 33.4 | 35.7 | 37.9 | 44.0 | 47.1 | 50.1 | 55.6 | 59.5 | 63.4 | | | | | | | | | | | | | | | | | | | | | | |
| | 60 | 16 | 16.5 | 17.5 | 18.5 | 24.9 | 26.5 | 28.1 | 34.7 | 37.0 | 39.4 | 45.7 | 48.9 | 52.0 | 57.7 | 61.8 | 65.9 | | | | | | | | | | | | | | | | | | | | | | |
| | 80 | 27 | 17.0 | 18.1 | 19.2 | 25.8 | 27.5 | 29.2 | 36.0 | 38.4 | 40.8 | 47.4 | 50.7 | 53.9 | 59.9 | 64.1 | 68.3 | | | | | | | | | | | | | | | | | | | | | | |
| | 100 | 38 | 17.5 | 18.6 | 19.7 | 26.5 | 28.2 | 30.0 | 37.0 | 39.5 | 42.0 | 48.8 | 52.2 | 55.6 | 61.7 | 66.1 | 70.5 | | | | | | | | | | | | | | | | | | | | | | |
| | 120 | 49 | 17.7 | 18.9 | 20.0 | 27.0 | 28.8 | 30.6 | 37.8 | 40.4 | 42.9 | 50.0 | 53.5 | 57.0 | 63.3 | 67.8 | 72.3 | | | | | | | | | | | | | | | | | | | | | | |
| 380 | 40 | 4 | 14.5 | 15.5 | 16.4 | 21.9 | 23.4 | 24.8 | 30.5 | 32.6 | 34.6 | 40.2 | 42.9 | 45.7 | 50.7 | 54.2 | 57.8 | 62.0 | 66.4 | | | | | | | | | | | | | | | | | | | | |
| | 60 | 16 | 15.1 | 16.0 | 17.0 | 22.8 | 24.2 | 25.7 | 31.7 | 33.8 | 35.9 | 41.7 | 44.6 | 47.4 | 52.7 | 56.3 | 60.0 | 64.4 | 68.9 | | | | | | | | | | | | | | | | | | | | |
| | 80 | 27 | 15.6 | 16.6 | 17.6 | 23.6 | 25.1 | 26.7 | 32.8 | 35.0 | 37.2 | 43.2 | 46.2 | 49.2 | 54.6 | 58.4 | 62.2 | 66.8 | 71.5 | | | | | | | | | | | | | | | | | | | | |
| | 100 | 38 | 16.0 | 17.0 | 18.0 | 24.2 | 25.8 | 27.4 | 33.8 | 36.0 | 38.3 | 44.5 | 47.6 | 50.6 | 56.3 | 60.2 | 64.2 | 68.9 | 73.8 | | | | | | | | | | | | | | | | | | | | |
| | 120 | 49 | 16.2 | 17.3 | 18.3 | 24.6 | 26.3 | 27.9 | 34.4 | 36.8 | 39.1 | 45.5 | 48.7 | 51.9 | 57.7 | 61.7 | 65.8 | 70.7 | 75.7 | | | | | | | | | | | | | | | | | | | | |
| 340 | 40 | 4 | 13.2 | 14.0 | 14.9 | 19.9 | 21.2 | 22.4 | 27.6 | 29.4 | 31.2 | 36.2 | 38.7 | 41.1 | 45.6 | 48.8 | 52.0 | 55.7 | 59.6 | 63.5 | | | | | | | | | | | | | | | | | | | |
| | 60 | 16 | 13.7 | 14.6 | 15.4 | 20.6 | 21.9 | 23.3 | 28.6 | 30.5 | 32.4 | 37.6 | 40.2 | 42.7 | 47.4 | 50.7 | 54.0 | 57.9 | 61.9 | 66.0 | | | | | | | | | | | | | | | | | | | |
| | 80 | 27 | 14.2 | 15.1 | 16.0 | 21.4 | 22.7 | 24.1 | 29.7 | 31.6 | 33.6 | 39.0 | 41.6 | 44.3 | 49.1 | 52.6 | 56.0 | 60.0 | 64.2 | 68.5 | | | | | | | | | | | | | | | | | | | |
| | 100 | 38 | 14.5 | 15.4 | 16.3 | 21.9 | 23.3 | 24.8 | 30.5 | 32.5 | 34.6 | 40.1 | 42.8 | 45.6 | 50.6 | 54.1 | 57.7 | 61.9 | 66.2 | 70.6 | | | | | | | | | | | | | | | | | | | |
| | 120 | 49 | 14.7 | 15.7 | 16.6 | 22.3 | 23.7 | 25.2 | 31.1 | 33.2 | 35.3 | 41.0 | 43.8 | 46.6 | 51.8 | 55.5 | 59.1 | 63.5 | 68.0 | 72.5 | | | | | | | | | | | | | | | | | | | |
| 300 | 40 | 4 | 11.9 | 12.6 | 13.4 | 17.8 | 18.9 | 20.1 | 24.6 | 26.2 | 27.8 | 32.2 | 34.3 | 36.5 | 40.4 | 43.2 | 46.0 | 49.2 | 52.6 | 56.1 | | | | | | | | | | | | | | | | | | | |
| | 60 | 16 | 12.4 | 13.1 | 13.9 | 18.5 | 19.6 | 20.8 | 25.5 | 27.2 | 28.9 | 33.4 | 35.6 | 37.9 | 42.0 | 44.8 | 47.7 | 51.1 | 54.7 | 58.2 | | | | | | | | | | | | | | | | | | | |
| | 80 | 27 | 12.8 | 13.6 | 14.4 | 19.1 | 20.4 | 21.6 | 26.4 | 28.2 | 29.9 | 34.6 | 37.0 | 39.3 | 43.5 | 46.5 | 49.5 | 53.0 | 56.7 | 60.4 | | | | | | | | | | | | | | | | | | | |
| | 100 | 38 | 13.1 | 13.9 | 14.7 | 19.6 | 20.9 | 22.1 | 27.2 | 29.0 | 30.8 | 35.6 | 38.0 | 40.4 | 44.8 | 47.9 | 51.0 | 54.6 | 58.4 | 62.3 | | | | | | | | | | | | | | | | | | | |
| | 120 | 49 | 13.2 | 14.1 | 14.9 | 19.9 | 21.2 | 22.5 | 27.7 | 29.5 | 31.4 | 36.3 | 38.8 | 41.3 | 45.8 | 49.0 | 52.2 | 55.9 | 59.9 | 63.8 | | | | | | | | | | | | | | | | | | | |
| 260 | 40 | 4 | 10.6 | 11.2 | 11.9 | 15.7 | 16.7 | 17.7 | 21.6 | 23.0 | 24.4 | 28.0 | 29.9 | 31.8 | 35.0 | 37.4 | 39.8 | 42.5 | 45.4 | 48.3 | | | | | | | | | | | | | | | | | | | |
| | 60 | 16 | 11.0 | 11.7 | 12.3 | 16.3 | 17.3 | 18.4 | 22.4 | 23.8 | 25.3 | 29.1 | 31.0 | 33.0 | 36.4 | 38.8 | 41.1 | 44.1 | 47.1 | 50.2 | | | | | | | | | | | | | | | | | | | |
| | 80 | 27 | 11.4 | 12.1 | 12.8 | 16.9 | 17.9 | 19.0 | 23.2 | 24.7 | 26.2 | 30.2 | 32.2 | 34.2 | 37.7 | 40.3 | 42.8 | 45.7 | 48.9 | 52.0 | | | | | | | | | | | | | | | | | | | |
| | 100 | 38 | 11.6 | 12.3 | 13.0 | 17.3 | 18.4 | 19.5 | 23.8 | 25.3 | 26.9 | 31.0 | 33.1 | 35.1 | 38.8 | 41.4 | 44.1 | 47.1 | 50.3 | 53.6 | | | | | | | | | | | | | | | | | | | |
| | 120 | 49 | 11.8 | 12.5 | 13.2 | 17.5 | 18.7 | 19.8 | 24.2 | 25.8 | 27.4 | 31.6 | 33.7 | 35.9 | 39.6 | 42.3 | 45.1 | 48.2 | 51.5 | 54.9 | | | | | | | | | | | | | | | | | | | |
| 220 | 40 | 4 | 9.3 | 9.9 | 10.4 | 13.6 | 14.5 | 15.3 | 18.5 | 19.7 | 20.8 | 23.8 | 25.4 | 26.9 | 29.5 | 31.4 | 33.4 | 35.5 | 37.9 | 40.3 | | | | | | | | | | | | | | | | | | | |
| | 60 | 16 | 9.6 | 10.2 | 10.8 | 14.1 | 15.0 | 15.9 | 19.2 | 20.4 | 21.6 | 24.7 | 26.3 | 27.9 | 30.6 | 32.6 | 34.7 | 36.8 | 39.3 | 41.8 | | | | | | | | | | | | | | | | | | | |
| | 80 | 27 | 10.0 | 10.6 | 11.2 | 14.6 | 15.5 | 16.4 | 19.9 | 21.1 | 22.4 | 25.6 | 27.3 | 28.9 | 31.7 | 33.8 | 36.0 | 38.2 | 40.8 | 43.3 | | | | | | | | | | | | | | | | | | | |
| | 100 | 38 | 10.2 | 10.8 | 11.4 | 15.0 | 15.9 | 16.8 | 20.4 | 21.7 | 23.0 | 26.3 | 28.0 | 29.7 | 32.6 | 34.8 | 37.0 | 39.3 | 41.9 | 44.6 | | | | | | | | | | | | | | | | | | | |
| | 120 | 49 | 10.3 | 10.9 | 11.5 | 15.2 | 16.1 | 17.1 | 20.7 | 22.0 | 23.4 | 26.7 | 28.5 | 30.3 | 33.2 | 35.5 | 37.8 | 40.1 | 42.9 | 45.6 | | | | | | | | | | | | | | | | | | | |

*To correct for wind, enter table with the brakes on speed minus one half the headwind or plus 1.5 times the tailwind.

If ground speed is used for brakes on speed, ignore wind, altitude, and OAT effects.

Adjusted Brake Energy Per Brake (Millions of Foot Pounds)

No Reverse Thrust

| EVENT | | REFERENCE BRAKE ENERGY PER BRAKE (MILLIONS OF FOOT POUNDS) | | | | | | | | | | | |
|---------|-------------|--|------|------|------|------|------|------|------|------|------|------|------|
| | | 5 | 10 | 15 | 20 | 25 | 30 | 35 | 40 | 45 | 50 | 55 | 60 |
| LANDING | RTO MAX MAN | 5.0 | 10.0 | 15.0 | 20.0 | 25.0 | 30.0 | 35.0 | 40.0 | 45.0 | 50.0 | 55.0 | 60.0 |
| | MAX MAN | 1.6 | 6.6 | 11.6 | 16.5 | 21.3 | 26.1 | 30.8 | 35.5 | 40.2 | 44.8 | 49.5 | 54.2 |
| | MAX AUTO | 2.3 | 6.6 | 10.7 | 14.9 | 19.1 | 23.3 | 27.5 | 31.8 | 36.0 | 40.3 | 44.7 | 49.0 |
| | AUTOBRAKE 4 | 2.5 | 6.4 | 10.4 | 14.3 | 18.3 | 22.2 | 26.1 | 30.1 | 34.0 | 38.0 | 42.0 | 46.1 |
| | AUTOBRAKE 3 | 2.4 | 6.1 | 9.8 | 13.5 | 17.1 | 20.8 | 24.5 | 28.1 | 31.8 | 35.5 | 39.2 | 43.0 |
| | AUTOBRAKE 2 | 2.4 | 5.8 | 9.3 | 12.7 | 16.0 | 19.4 | 22.8 | 26.2 | 29.6 | 33.0 | 36.4 | 39.9 |
| | AUTOBRAKE 1 | 2.3 | 5.4 | 8.4 | 11.5 | 14.4 | 17.4 | 20.3 | 23.3 | 26.2 | 29.2 | 32.2 | 35.2 |

ADVISORY INFORMATION

**Recommended Brake Cooling Schedule
Two Engines Reverse Thrust**

| EVENT | | REFERENCE BRAKE ENERGY PER BRAKE (MILLIONS OF FOOT POUNDS) | | | | | | | | | | | |
|---------|-------------|--|-----|------|------|------|------|------|------|------|------|------|------|
| | | 5 | 10 | 15 | 20 | 25 | 30 | 35 | 40 | 45 | 50 | 55 | 60 |
| LANDING | MAX MAN | 0.7 | 5.7 | 10.5 | 15.3 | 19.9 | 24.5 | 29.0 | 33.5 | 37.9 | 42.3 | 46.6 | 51.0 |
| | MAX AUTO | 1.0 | 4.6 | 8.2 | 11.8 | 15.4 | 19.0 | 22.7 | 26.4 | 30.1 | 33.9 | 37.8 | 41.7 |
| | AUTOBRAKE 4 | 0.6 | 3.8 | 6.9 | 10.0 | 13.2 | 16.3 | 19.5 | 22.7 | 26.0 | 29.3 | 32.6 | 36.0 |
| | AUTOBRAKE 3 | 0.0 | 2.6 | 5.3 | 8.0 | 10.7 | 13.5 | 16.2 | 19.0 | 21.8 | 24.7 | 27.6 | 30.6 |
| | AUTOBRAKE 2 | 0.0 | 1.2 | 3.5 | 5.7 | 8.0 | 10.3 | 12.6 | 15.0 | 17.3 | 19.8 | 22.2 | 24.8 |
| | AUTOBRAKE 1 | 0.0 | 0.7 | 2.2 | 3.8 | 5.3 | 6.9 | 8.4 | 10.0 | 11.7 | 13.4 | 15.1 | 16.9 |

**Cooling Time (Minutes)
Category "C" and "D" Brakes**

| | | ADJUSTED BRAKE ENERGY PER BRAKE (MILLIONS OF FOOT POUNDS) | | | | | | | | | | |
|-----------------------|-------------------------------------|---|----|----|----|----|----|----|---------|----------|------------------------|--|
| | | 14 & BELOW | 15 | 16 | 18 | 20 | 24 | 28 | 34 | 35 TO 42 | 43 & ABOVE | |
| | | BRAKE TEMPERATURE MONITOR SYSTEM INDICATION ON EICAS | | | | | | | | | | |
| | | UP TO 1 | 1 | 1 | 2 | 2 | 3 | 4 | 5 | 5 TO 6 | 7 & ABOVE | |
| INFLIGHT GEAR DOWN | NO SPECIAL PROCEDURE REQUIRED | 1 | 1 | 2 | 2 | 3 | 4 | 6 | CAUTION | | FUSE PLUG MELT ZONE | |
| GROUND | | 11 | 15 | 19 | 24 | 34 | 44 | 59 | | | | |

Observe maximum quick turnaround limit.

Table shows energy per brake added by a single stop with all brakes operating. Energy is assumed to be equally distributed among the operating brakes. Total energy is the sum of residual energy plus energy added.

Add 1.0 million foot pounds per brake for each taxi mile.

For one brake deactivated, increase brake energy by 15 percent.

When in caution zone, wheel fuse plugs may melt. Delay takeoff and inspect after one hour. If overheat occurs after takeoff, extend gear soon for at least 6 minutes.

When in fuse plug melt zone, clear runway immediately. Unless required, do not set parking brake. Do not approach gear or attempt to taxi for one hour. Tire, wheel and brake replacement may be required.

If overheat occurs after takeoff, extend gear soon for at least 10 minutes.

Brake temperature monitor system (BTMS) indication on EICAS may be used 10 to 15 minutes after airplane has come to a complete stop, or inflight with gear retracted, to determine recommended cooling schedule.

**Performance Inflight -
Engine Inoperative****Chapter PI
Section 23****ENGINE INOP****Initial Max Continuous EPR****Based on engine bleed for one pack on and APU off**

| PRESSURE ALTITUDE (FT) | | CRUISE MACH NUMBER | | |
|---------------------------|----------|--------------------|------|------|
| | | .72 | .76 | .80 |
| 39000 | EPR | 1.69 | 1.69 | 1.69 |
| | MAX TAT | -14 | -11 | -10 |
| | EPR CORR | 0.09 | 0.09 | 0.10 |
| 37000 | EPR | 1.70 | 1.69 | 1.69 |
| | MAX TAT | -14 | -11 | -10 |
| | EPR CORR | 0.09 | 0.09 | 0.10 |
| 35000 | EPR | 1.70 | 1.69 | 1.69 |
| | MAX TAT | -13 | -11 | -9 |
| | EPR CORR | 0.09 | 0.09 | 0.10 |
| 33000 | EPR | 1.70 | 1.70 | 1.69 |
| | MAX TAT | -9 | -8 | -5 |
| | EPR CORR | 0.09 | 0.09 | 0.10 |
| 31000 | EPR | 1.70 | 1.70 | 1.68 |
| | MAX TAT | -5 | -4 | 0 |
| | EPR CORR | 0.10 | 0.10 | 0.11 |
| 29000 | EPR | 1.70 | 1.69 | 1.68 |
| | MAX TAT | -2 | 1 | 3 |
| | EPR CORR | 0.09 | 0.10 | 0.10 |
| 27000 | EPR | 1.71 | 1.70 | 1.68 |
| | MAX TAT | 1 | 3 | 7 |
| | EPR CORR | 0.10 | 0.10 | 0.10 |

Decrease EPR by the EPR CORR for every 10°C above the MAX TAT shown.

ENGINE INOP

Max Continuous EPR

39000 FT to 22000 FT Pressure Altitudes

Based on engine bleed for one pack on and anti-ice off

| PRESSURE ALTITUDE (FT) | | KIAS | | | | MACH NUMBER | | | | | |
|---------------------------|----------|------|------|------|------|-------------|------|------|------|------|------|
| | | 150 | 200 | 250 | 300 | .70 | .72 | .74 | .76 | .78 | .80 |
| 39000 | EPR | | 1.72 | 1.68 | | 1.70 | 1.69 | 1.69 | 1.69 | 1.69 | 1.69 |
| | MAX TAT | | -17 | -9 | | -14 | -14 | -12 | -11 | -10 | -10 |
| | EPR CORR | | 0.09 | 0.10 | | 0.09 | 0.09 | 0.09 | 0.09 | 0.10 | 0.10 |
| 37000 | EPR | | 1.73 | 1.69 | | 1.70 | 1.70 | 1.69 | 1.69 | 1.69 | 1.69 |
| | MAX TAT | | -18 | -10 | | -14 | -14 | -12 | -11 | -10 | -10 |
| | EPR CORR | | 0.08 | 0.10 | | 0.09 | 0.09 | 0.09 | 0.09 | 0.10 | 0.10 |
| 35000 | EPR | 1.76 | 1.75 | 1.70 | | 1.70 | 1.70 | 1.70 | 1.69 | 1.69 | 1.69 |
| | MAX TAT | -21 | -20 | -13 | | -14 | -13 | -13 | -11 | -10 | -9 |
| | EPR CORR | 0.07 | 0.08 | 0.09 | | 0.09 | 0.09 | 0.09 | 0.09 | 0.10 | 0.10 |
| 33000 | EPR | 1.74 | 1.76 | 1.70 | 1.66 | 1.70 | 1.70 | 1.70 | 1.70 | 1.69 | 1.69 |
| | MAX TAT | -12 | -18 | -10 | -2 | -10 | -9 | -8 | -8 | -6 | -5 |
| | EPR CORR | 0.09 | 0.08 | 0.09 | 0.11 | 0.09 | 0.09 | 0.10 | 0.09 | 0.10 | 0.10 |
| 31000 | EPR | 1.75 | 1.76 | 1.71 | 1.68 | 1.70 | 1.70 | 1.70 | 1.70 | 1.69 | 1.68 |
| | MAX TAT | -11 | -14 | -7 | 0 | -6 | -5 | -5 | -4 | -2 | 0 |
| | EPR CORR | 0.09 | 0.09 | 0.09 | 0.10 | 0.09 | 0.10 | 0.10 | 0.10 | 0.10 | 0.11 |
| 29000 | EPR | 1.75 | 1.77 | 1.73 | 1.69 | 1.71 | 1.70 | 1.70 | 1.69 | 1.69 | 1.68 |
| | MAX TAT | -10 | -13 | -6 | 1 | -4 | -2 | -1 | 1 | 2 | 3 |
| | EPR CORR | 0.09 | 0.09 | 0.09 | 0.10 | 0.09 | 0.09 | 0.10 | 0.10 | 0.11 | 0.10 |
| 27000 | EPR | 1.75 | 1.78 | 1.74 | 1.70 | 1.71 | 1.71 | 1.70 | 1.70 | 1.69 | 1.68 |
| | MAX TAT | -10 | -12 | -4 | 3 | 0 | 1 | 3 | 3 | 5 | 7 |
| | EPR CORR | 0.09 | 0.09 | 0.09 | 0.10 | 0.10 | 0.10 | 0.10 | 0.10 | 0.10 | 0.10 |
| 25000 | EPR | 1.75 | 1.77 | 1.76 | 1.71 | 1.71 | 1.71 | 1.71 | 1.70 | 1.69 | 1.68 |
| | MAX TAT | -10 | -11 | -3 | 4 | 3 | 4 | 5 | 7 | 9 | 10 |
| | EPR CORR | 0.09 | 0.09 | 0.10 | 0.09 | 0.09 | 0.09 | 0.10 | 0.10 | 0.10 | 0.10 |
| 24000 | EPR | 1.75 | 1.75 | 1.76 | 1.71 | 1.71 | 1.71 | 1.70 | 1.69 | 1.68 | 1.67 |
| | MAX TAT | -10 | -8 | -2 | 4 | 4 | 5 | 7 | 9 | 10 | 12 |
| | EPR CORR | 0.09 | 0.09 | 0.10 | 0.09 | 0.09 | 0.09 | 0.10 | 0.10 | 0.10 | 0.10 |
| 22000 | EPR | 1.75 | 1.74 | 1.77 | 1.71 | 1.70 | 1.69 | 1.68 | 1.67 | 1.66 | 1.65 |
| | MAX TAT | -11 | -7 | -1 | 6 | 7 | 9 | 11 | 12 | 14 | 16 |
| | EPR CORR | 0.08 | 0.09 | 0.10 | 0.09 | 0.09 | 0.09 | 0.09 | 0.09 | 0.09 | 0.10 |

Decrease EPR by the EPR CORR for every 10°C above the MAX TAT shown.

EPR Adjustments for Engine Bleed

| BLEED CONFIGURATION | PRESSURE ALTITUDE (FT) | | | | |
|---------------------------|------------------------|-------|-------|-------|-------|
| | 0 | 10000 | 20000 | 30000 | 40000 |
| PACKS OFF | 0.01 | 0.01 | 0.01 | 0.01 | 0.02 |
| ENGINE ANTI-ICE ON | -0.01 | -0.02 | -0.03 | -0.04 | -0.05 |
| ENGINE & WING ANTI-ICE ON | -0.04 | -0.06 | -0.09 | -0.10 | -0.13 |

ENGINE INOP**Max Continuous EPR****20000 FT to Sea Level Pressure Altitudes****Based on engine bleed for one pack on and anti-ice off**

| PRESSURE ALTITUDE (FT) | | KIAS | | | | MACH NUMBER | | | | | |
|---------------------------|----------|------|------|------|------|-------------|------|------|------|------|------|
| | | 150 | 200 | 250 | 300 | .70 | .72 | .74 | .76 | .78 | .80 |
| 20000 | EPR | 1.75 | 1.73 | 1.77 | 1.72 | 1.69 | 1.68 | 1.67 | 1.66 | 1.65 | 1.63 |
| | MAX TAT | -9 | -5 | 1 | 7 | 10 | 12 | 14 | 15 | 17 | 19 |
| | EPR CORR | 0.09 | 0.09 | 0.10 | 0.09 | 0.09 | 0.09 | 0.09 | 0.09 | 0.09 | 0.09 |
| 18000 | EPR | 1.72 | 1.70 | 1.77 | 1.72 | 1.66 | 1.65 | 1.64 | 1.63 | 1.61 | |
| | MAX TAT | -6 | -1 | 4 | 10 | 15 | 17 | 18 | 20 | 22 | |
| | EPR CORR | 0.09 | 0.09 | 0.09 | 0.09 | 0.08 | 0.08 | 0.08 | 0.08 | 0.08 | |
| 16000 | EPR | 1.68 | 1.66 | 1.76 | 1.71 | 1.64 | 1.62 | 1.61 | 1.60 | | |
| | MAX TAT | -1 | 2 | 7 | 13 | 19 | 22 | 23 | 24 | | |
| | EPR CORR | 0.09 | 0.09 | 0.09 | 0.09 | 0.08 | 0.08 | 0.08 | 0.08 | | |
| 14000 | EPR | 1.65 | 1.62 | 1.70 | 1.68 | 1.59 | 1.58 | 1.56 | | | |
| | MAX TAT | 2 | 5 | 10 | 16 | 24 | 25 | 27 | | | |
| | EPR CORR | 0.09 | 0.09 | 0.09 | 0.09 | 0.07 | 0.07 | 0.07 | | | |
| 12000 | EPR | 1.62 | 1.58 | 1.62 | 1.63 | 1.53 | | | | | |
| | MAX TAT | 5 | 9 | 13 | 18 | 28 | | | | | |
| | EPR CORR | 0.08 | 0.09 | 0.08 | 0.08 | 0.07 | | | | | |
| 10000 | EPR | 1.58 | 1.55 | 1.56 | 1.57 | | | | | | |
| | MAX TAT | 10 | 13 | 16 | 22 | | | | | | |
| | EPR CORR | 0.08 | 0.08 | 0.08 | 0.08 | | | | | | |
| 5000 | EPR | 1.51 | 1.48 | 1.45 | 1.44 | | | | | | |
| | MAX TAT | 18 | 22 | 25 | 29 | | | | | | |
| | EPR CORR | 0.07 | 0.07 | 0.07 | 0.06 | | | | | | |
| 1500 | EPR | 1.45 | 1.43 | 1.40 | 1.36 | | | | | | |
| | MAX TAT | 26 | 29 | 31 | 35 | | | | | | |
| | EPR CORR | 0.06 | 0.06 | 0.06 | 0.06 | | | | | | |
| 0 | EPR | 1.41 | 1.39 | 1.36 | 1.32 | | | | | | |
| | MAX TAT | 28 | 31 | 34 | 38 | | | | | | |
| | EPR CORR | 0.06 | 0.06 | 0.05 | 0.05 | | | | | | |

Decrease EPR by the EPR CORR for every 10°C above the MAX TAT shown.

EPR Adjustments for Engine Bleed

| BLEED CONFIGURATION | PRESSURE ALTITUDE (FT) | | | | |
|---------------------------|------------------------|-------|-------|-------|-------|
| | 0 | 10000 | 20000 | 30000 | 40000 |
| PACKS OFF | 0.01 | 0.01 | 0.01 | 0.01 | 0.02 |
| ENGINE ANTI-ICE ON | -0.01 | -0.02 | -0.03 | -0.04 | -0.05 |
| ENGINE & WING ANTI-ICE ON | -0.04 | -0.06 | -0.09 | -0.10 | -0.13 |

ENGINE INOP

MAX CONTINUOUS THRUST

Driftdown Speed/Level Off Altitude

100 ft/min residual rate of climb

| WEIGHT (1000 LB) | | OPTIMUM DRIFTDOWN SPEED (KIAS) | LEVEL OFF ALTITUDE (FT) | | |
|------------------------|--------------|---|-------------------------|------------|------------|
| START DRIFT DOWN | LEVEL OFF | | ISA + 10°C & BELOW | ISA + 15°C | ISA + 20°C |
| 420 | 406 | 276 | 18600 | 17700 | 16900 |
| 400 | 387 | 270 | 19800 | 18900 | 18100 |
| 380 | 368 | 264 | 21000 | 20200 | 19400 |
| 360 | 349 | 257 | 22200 | 21600 | 20700 |
| 340 | 330 | 250 | 23500 | 23000 | 22100 |
| 320 | 310 | 243 | 24900 | 24500 | 23600 |
| 300 | 291 | 235 | 26300 | 26000 | 25200 |
| 280 | 271 | 227 | 27800 | 27600 | 26800 |
| 260 | 252 | 219 | 29300 | 29300 | 28500 |
| 240 | 233 | 211 | 31000 | 30900 | 30300 |
| 220 | 213 | 202 | 32700 | 32700 | 32100 |

Includes APU fuel burn.

Driftdown/LRC Cruise Range Capability

Ground to Air Miles Conversion

| AIR DISTANCE (NM) | | | | | GROUND DISTANCE (NM) | AIR DISTANCE (NM) | | | | |
|--------------------------|------|------|------|------|----------------------------|--------------------------|------|------|------|------|
| HEADWIND COMPONENT (KTS) | | | | | | TAILWIND COMPONENT (KTS) | | | | |
| 100 | 80 | 60 | 40 | 20 | 20 | 40 | 60 | 80 | 100 | |
| 274 | 255 | 239 | 224 | 211 | 200 | 190 | 180 | 172 | 164 | 157 |
| 546 | 509 | 477 | 448 | 423 | 400 | 380 | 361 | 345 | 329 | 315 |
| 817 | 762 | 714 | 671 | 634 | 600 | 570 | 542 | 518 | 495 | 474 |
| 1086 | 1014 | 950 | 894 | 845 | 800 | 760 | 724 | 691 | 661 | 633 |
| 1356 | 1266 | 1187 | 1117 | 1055 | 1000 | 950 | 905 | 864 | 827 | 792 |
| 1625 | 1518 | 1423 | 1340 | 1266 | 1200 | 1140 | 1086 | 1037 | 992 | 951 |
| 1896 | 1771 | 1661 | 1564 | 1477 | 1400 | 1330 | 1267 | 1210 | 1158 | 1110 |
| 2168 | 2025 | 1899 | 1787 | 1689 | 1600 | 1520 | 1448 | 1383 | 1323 | 1268 |
| 2444 | 2280 | 2138 | 2012 | 1900 | 1800 | 1710 | 1628 | 1554 | 1487 | 1425 |

Driftdown/Cruise Fuel and Time

| AIR DIST (NM) | FUEL REQUIRED (1000 LB) | | | | | | | | | | | TIME (HR:MIN) |
|---------------------|--|------|------|------|------|------|------|------|------|------|------|------------------|
| | WEIGHT AT START OF DRIFTDOWN (1000 LB) | | | | | | | | | | | |
| | 220 | 240 | 260 | 280 | 300 | 320 | 340 | 360 | 380 | 400 | 420 | |
| 200 | 3.8 | 4.0 | 4.3 | 4.5 | 4.9 | 5.1 | 5.4 | 5.8 | 5.9 | 6.3 | 6.7 | 0:33 |
| 400 | 8.3 | 8.9 | 9.7 | 10.3 | 11.0 | 11.6 | 12.3 | 13.0 | 13.6 | 14.4 | 15.1 | 1:04 |
| 600 | 12.6 | 13.6 | 14.6 | 15.6 | 16.7 | 17.6 | 18.7 | 19.8 | 20.7 | 21.8 | 23.0 | 1:36 |
| 800 | 16.8 | 18.1 | 19.5 | 20.8 | 22.3 | 23.6 | 25.0 | 26.4 | 27.6 | 29.1 | 30.7 | 2:07 |
| 1000 | 20.9 | 22.5 | 24.3 | 25.9 | 27.7 | 29.4 | 31.1 | 32.8 | 34.4 | 36.3 | 38.2 | 2:37 |
| 1200 | 24.9 | 26.9 | 29.0 | 31.0 | 33.1 | 35.0 | 37.1 | 39.2 | 41.1 | 43.3 | 45.6 | 3:08 |
| 1400 | 28.8 | 31.1 | 33.6 | 35.9 | 38.3 | 40.6 | 43.0 | 45.4 | 47.7 | 50.2 | 52.9 | 3:40 |
| 1600 | 32.6 | 35.3 | 38.1 | 40.7 | 43.5 | 46.1 | 48.8 | 51.5 | 54.1 | 57.0 | 60.0 | 4:12 |
| 1800 | 36.4 | 39.4 | 42.5 | 45.5 | 48.5 | 51.5 | 54.5 | 57.5 | 60.4 | 63.6 | 67.0 | 4:44 |

Includes APU fuel burn.

Driftdown at optimum driftdown speed and cruise at Long Range Cruise speed.

ENGINE INOP

MAX CONTINUOUS THRUST

**Long Range Cruise Altitude Capability
 100 ft/min residual rate of climb and APU on**

| WEIGHT (1000 LB) | PRESSURE ALTITUDE (FT) | | |
|---------------------|------------------------|------------|------------|
| | ISA + 10°C & BELOW | ISA + 15°C | ISA + 20°C |
| 420 | 15700 | 14600 | 13300 |
| 410 | 16400 | 15400 | 14500 |
| 400 | 17100 | 16200 | 15400 |
| 390 | 17700 | 16900 | 16100 |
| 380 | 18400 | 17600 | 16800 |
| 370 | 19100 | 18300 | 17500 |
| 360 | 19900 | 19000 | 18200 |
| 350 | 20500 | 19700 | 19000 |
| 340 | 21200 | 20500 | 19700 |
| 330 | 21900 | 21300 | 20500 |
| 320 | 22600 | 22100 | 21200 |
| 310 | 23400 | 22900 | 22100 |
| 300 | 24100 | 23700 | 22900 |
| 290 | 24900 | 24600 | 23700 |
| 280 | 25700 | 25400 | 24600 |
| 270 | 26500 | 26200 | 25500 |
| 260 | 27300 | 27100 | 26300 |
| 250 | 28100 | 28000 | 27200 |
| 240 | 29000 | 28900 | 28100 |
| 230 | 29800 | 29800 | 29100 |
| 220 | 30800 | 30700 | 30100 |

With engine anti-ice on, decrease altitude capability by 1400 ft.

With engine and wing anti-ice on, decrease altitude capability by 3200 ft.

ENGINE INOP

MAX CONTINUOUS THRUST

Long Range Cruise Control

| WEIGHT (1000 LB) | | PRESSURE ALTITUDE (1000 FT) | | | | | | | | |
|---------------------|--------|-----------------------------|-------|-------|-------|-------|-------|------|------|------|
| | | 10 | 14 | 18 | 21 | 23 | 25 | 27 | 29 | 31 |
| 420 | EPR | 1.35 | 1.49 | | | | | | | |
| | MACH | .560 | .608 | | | | | | | |
| | KIAS | 310 | 314 | | | | | | | |
| | FF/ENG | 14754 | 15755 | | | | | | | |
| 400 | EPR | 1.32 | 1.45 | 1.65 | | | | | | |
| | MACH | .549 | .590 | .657 | | | | | | |
| | KIAS | 305 | 304 | 315 | | | | | | |
| | FF/ENG | 13913 | 14542 | 15791 | | | | | | |
| 380 | EPR | 1.30 | 1.40 | 1.58 | | | | | | |
| | MACH | .540 | .574 | .634 | | | | | | |
| | KIAS | 299 | 296 | 303 | | | | | | |
| | FF/ENG | 13151 | 13481 | 14504 | | | | | | |
| 360 | EPR | 1.27 | 1.36 | 1.51 | | | | | | |
| | MACH | .531 | .560 | .611 | | | | | | |
| | KIAS | 294 | 288 | 292 | | | | | | |
| | FF/ENG | 12433 | 12543 | 13214 | | | | | | |
| 340 | EPR | 1.25 | 1.32 | 1.45 | 1.60 | | | | | |
| | MACH | .521 | .548 | .590 | .640 | | | | | |
| | KIAS | 289 | 282 | 282 | 289 | | | | | |
| | FF/ENG | 11719 | 11706 | 12089 | 12883 | | | | | |
| 320 | EPR | 1.22 | 1.29 | 1.40 | 1.53 | 1.64 | | | | |
| | MACH | .511 | .538 | .572 | .614 | .651 | | | | |
| | KIAS | 283 | 276 | 272 | 276 | 282 | | | | |
| | FF/ENG | 11020 | 10943 | 11076 | 11614 | 12287 | | | | |
| 300 | EPR | 1.20 | 1.26 | 1.35 | 1.46 | 1.56 | 1.68 | | | |
| | MACH | .500 | .527 | .556 | .590 | .622 | .662 | | | |
| | KIAS | 277 | 271 | 265 | 265 | 269 | 276 | | | |
| | FF/ENG | 10340 | 10232 | 10169 | 10511 | 11012 | 11691 | | | |
| 280 | EPR | 1.18 | 1.24 | 1.31 | 1.40 | 1.48 | 1.59 | | | |
| | MACH | .489 | .515 | .543 | .569 | .596 | .630 | | | |
| | KIAS | 271 | 265 | 258 | 255 | 257 | 262 | | | |
| | FF/ENG | 9692 | 9528 | 9372 | 9515 | 9867 | 10367 | | | |
| 260 | EPR | 1.16 | 1.21 | 1.28 | 1.35 | 1.41 | 1.50 | 1.61 | | |
| | MACH | .478 | .502 | .530 | .552 | .572 | .600 | .636 | | |
| | KIAS | 264 | 258 | 252 | 247 | 247 | 248 | 253 | | |
| | FF/ENG | 9074 | 8837 | 8648 | 8639 | 8857 | 9206 | 9697 | | |
| 240 | EPR | 1.14 | 1.19 | 1.24 | 1.30 | 1.35 | 1.42 | 1.51 | 1.63 | |
| | MACH | .465 | .489 | .517 | .538 | .553 | .574 | .603 | .640 | |
| | KIAS | 257 | 251 | 245 | 241 | 238 | 237 | 239 | 244 | |
| | FF/ENG | 8440 | 8199 | 7955 | 7858 | 7952 | 8190 | 8519 | 9004 | |
| 220 | EPR | 1.13 | 1.16 | 1.21 | 1.26 | 1.30 | 1.36 | 1.42 | 1.52 | 1.64 |
| | MACH | .447 | .476 | .502 | .523 | .537 | .553 | .574 | .604 | .642 |
| | KIAS | 247 | 244 | 238 | 234 | 231 | 228 | 227 | 230 | 234 |
| | FF/ENG | 7715 | 7605 | 7300 | 7176 | 7173 | 7268 | 7484 | 7805 | 8258 |

ENGINE INOP

MAX CONTINUOUS THRUST

**Long Range Cruise Diversion Fuel and Time
 Ground to Air Miles Conversion**

| AIR DISTANCE (NM) | | | | | GROUND DISTANCE (NM) | AIR DISTANCE (NM) | | | | |
|--------------------------|------|------|------|------|----------------------------|--------------------------|------|------|------|------|
| HEADWIND COMPONENT (KTS) | | | | | | TAILWIND COMPONENT (KTS) | | | | |
| 100 | 80 | 60 | 40 | 20 | | 20 | 40 | 60 | 80 | 100 |
| 291 | 267 | 246 | 229 | 213 | 200 | 190 | 181 | 173 | 166 | 160 |
| 583 | 535 | 493 | 458 | 427 | 400 | 381 | 363 | 347 | 333 | 320 |
| 877 | 805 | 741 | 687 | 641 | 600 | 572 | 545 | 521 | 500 | 480 |
| 1171 | 1074 | 989 | 917 | 855 | 800 | 762 | 726 | 694 | 665 | 639 |
| 1467 | 1345 | 1237 | 1147 | 1069 | 1000 | 953 | 909 | 868 | 831 | 798 |
| 1763 | 1616 | 1486 | 1377 | 1284 | 1200 | 1142 | 1089 | 1040 | 996 | 956 |
| 2061 | 1888 | 1736 | 1608 | 1498 | 1400 | 1333 | 1270 | 1213 | 1161 | 1114 |
| 2359 | 2160 | 1985 | 1838 | 1712 | 1600 | 1522 | 1451 | 1385 | 1325 | 1272 |
| 2659 | 2434 | 2235 | 2069 | 1927 | 1800 | 1712 | 1631 | 1557 | 1489 | 1429 |

Reference Fuel and Time Required at Check Point

| AIR DIST (NM) | PRESSURE ALTITUDE (1000 FT) | | | | | | | |
|---------------------|-----------------------------|------------------|-------------------|------------------|-------------------|------------------|-------------------|------------------|
| | 10 | | 14 | | 18 | | 22 | |
| | FUEL (1000 LB) | TIME (HR:MIN) | FUEL (1000 LB) | TIME (HR:MIN) | FUEL (1000 LB) | TIME (HR:MIN) | FUEL (1000 LB) | TIME (HR:MIN) |
| 200 | 5.9 | 0:42 | 5.3 | 0:41 | 4.8 | 0:40 | 4.4 | 0:38 |
| 400 | 12.4 | 1:20 | 11.4 | 1:17 | 10.6 | 1:15 | 10.2 | 1:11 |
| 600 | 18.8 | 1:58 | 17.5 | 1:54 | 16.4 | 1:50 | 15.9 | 1:44 |
| 800 | 25.1 | 2:36 | 23.5 | 2:31 | 22.1 | 2:26 | 21.4 | 2:18 |
| 1000 | 31.3 | 3:15 | 29.4 | 3:08 | 27.7 | 3:02 | 26.9 | 2:52 |
| 1200 | 37.5 | 3:54 | 35.2 | 3:46 | 33.3 | 3:38 | 32.3 | 3:26 |
| 1400 | 43.6 | 4:34 | 41.0 | 4:24 | 38.7 | 4:14 | 37.6 | 4:01 |
| 1600 | 49.6 | 5:13 | 46.6 | 5:02 | 44.0 | 4:51 | 42.8 | 4:36 |
| 1800 | 55.5 | 5:53 | 52.2 | 5:40 | 49.3 | 5:28 | 47.9 | 5:12 |

Fuel Required Adjustment (1000 LB)

| REFERENCE FUEL REQUIRED (1000 LB) | WEIGHT AT CHECK POINT (1000 LB) | | | | |
|--------------------------------------|---------------------------------|------|-----|-----|------|
| | 200 | 250 | 300 | 350 | 400 |
| 5 | -0.9 | -0.4 | 0.0 | 0.7 | 1.3 |
| 10 | -1.9 | -0.9 | 0.0 | 1.6 | 3.0 |
| 15 | -3.0 | -1.4 | 0.0 | 2.5 | 4.8 |
| 20 | -4.1 | -1.9 | 0.0 | 3.4 | 6.6 |
| 25 | -5.2 | -2.4 | 0.0 | 4.3 | 8.3 |
| 30 | -6.3 | -2.9 | 0.0 | 5.1 | 10.1 |
| 35 | -7.4 | -3.4 | 0.0 | 6.0 | 11.9 |
| 40 | -8.5 | -3.9 | 0.0 | 6.8 | 13.7 |
| 45 | -9.6 | -4.4 | 0.0 | 7.6 | 15.5 |
| 50 | -10.8 | -4.9 | 0.0 | 8.4 | 17.2 |
| 55 | -11.9 | -5.5 | 0.0 | 9.2 | 19.0 |
| 60 | -13.1 | -6.0 | 0.0 | 9.9 | 20.8 |

Includes APU fuel burn.

ENGINE INOP

MAX CONTINUOUS THRUST

**Holding
Flaps Up**

| WEIGHT (1000 LB) | | PRESSURE ALTITUDE (FT) | | | | | | |
|---------------------|--------|------------------------|-------|-------|-------|-------|-------|-------|
| | | 1500 | 5000 | 10000 | 15000 | 20000 | 25000 | 30000 |
| 420 | EPR | 1.19 | 1.24 | 1.33 | 1.49 | | | |
| | KIAS | 259 | 259 | 259 | 259 | | | |
| | FF/ENG | 12870 | 12960 | 13360 | 14350 | | | |
| 400 | EPR | 1.18 | 1.22 | 1.30 | 1.45 | 1.70 | | |
| | KIAS | 252 | 252 | 252 | 253 | 255 | | |
| | FF/ENG | 12200 | 12240 | 12530 | 13340 | 14490 | | |
| 380 | EPR | 1.16 | 1.20 | 1.28 | 1.40 | 1.63 | | |
| | KIAS | 246 | 246 | 246 | 247 | 248 | | |
| | FF/ENG | 11550 | 11550 | 11750 | 12360 | 13320 | | |
| 360 | EPR | 1.15 | 1.19 | 1.25 | 1.36 | 1.56 | | |
| | KIAS | 239 | 239 | 239 | 240 | 241 | | |
| | FF/ENG | 10890 | 10880 | 11010 | 11420 | 12200 | | |
| 340 | EPR | 1.14 | 1.17 | 1.23 | 1.33 | 1.50 | | |
| | KIAS | 231 | 231 | 232 | 233 | 234 | | |
| | FF/ENG | 10250 | 10220 | 10300 | 10540 | 11190 | | |
| 320 | EPR | 1.13 | 1.16 | 1.21 | 1.29 | 1.44 | 1.70 | |
| | KIAS | 225 | 225 | 225 | 226 | 227 | 229 | |
| | FF/ENG | 9620 | 9580 | 9620 | 9720 | 10230 | 11350 | |
| 300 | EPR | 1.11 | 1.14 | 1.19 | 1.26 | 1.39 | 1.61 | |
| | KIAS | 220 | 220 | 220 | 220 | 220 | 221 | |
| | FF/ENG | 9000 | 8960 | 8980 | 8990 | 9320 | 10240 | |
| 280 | EPR | 1.10 | 1.13 | 1.17 | 1.23 | 1.34 | 1.52 | |
| | KIAS | 215 | 215 | 215 | 215 | 215 | 215 | |
| | FF/ENG | 8400 | 8350 | 8370 | 8330 | 8460 | 9260 | |
| 260 | EPR | 1.09 | 1.11 | 1.15 | 1.21 | 1.30 | 1.45 | 1.73 |
| | KIAS | 210 | 210 | 210 | 210 | 210 | 210 | 210 |
| | FF/ENG | 7800 | 7760 | 7770 | 7710 | 7700 | 8330 | 9290 |
| 240 | EPR | 1.08 | 1.10 | 1.13 | 1.18 | 1.26 | 1.38 | 1.62 |
| | KIAS | 204 | 204 | 204 | 204 | 204 | 204 | 204 |
| | FF/ENG | 7200 | 7180 | 7180 | 7130 | 7030 | 7450 | 8220 |
| 220 | EPR | 1.07 | 1.08 | 1.12 | 1.16 | 1.22 | 1.33 | 1.51 |
| | KIAS | 199 | 199 | 199 | 199 | 199 | 199 | 199 |
| | FF/ENG | 6630 | 6590 | 6600 | 6560 | 6430 | 6650 | 7300 |

This table includes 5% additional fuel for holding in a racetrack pattern.

Performance Inflight - Alternate EEC Mode

Chapter PI Section 24

ALTERNATE EEC MODE

Takeoff Performance

| PERFORMANCE LIMIT | WEIGHT ADJUSTMENT (1000 LB) | | | | | | |
|-------------------|-----------------------------|------------|-------|-------|-------|------------|-------|
| | AIRPORT OAT | | | | | | |
| | °F | 59 & BELOW | 68 | 77 | 86 | 91 & ABOVE | |
| FIELD | °C | 15 & BELOW | 20 | 25 | 30 | 33 & ABOVE | |
| | | | -27.6 | -32.4 | -37.7 | -43.0 | -45.2 |
| CLIMB | | | -44.1 | -46.7 | -58.9 | -66.6 | -68.8 |
| OBSTACLE | | | -44.5 | -52.0 | -60.6 | -69.2 | -73.8 |

Takeoff Speeds Adjustment

| TAKEOFF SPEEDS | TAKEOFF SPEEDS ADJUSTMENTS (KTS) | | | |
|----------------|----------------------------------|------------|----|------------|
| | AIRPORT OAT | | | |
| | °F | 50 & BELOW | 68 | 86 & ABOVE |
| | °C | 10 & BELOW | 20 | 30 & ABOVE |
| V1 (FLAPS 5) | | 3 | 4 | 6 |
| V1 (FLAPS 15) | | 3 | 4 | 6 |
| V1 (FLAPS 20) | | 2 | 3 | 5 |
| VR | | 2 | 2 | 2 |
| V2 | | 1 | 1 | 1 |

Landing Performance

| PERFORMANCE LIMIT | WEIGHT ADJUSTMENT (1000 LB) | | | | | | |
|-------------------|-----------------------------|------------|-------|-------|-------|------------|-------|
| | AIRPORT OAT | | | | | | |
| | °F | 59 & BELOW | 68 | 77 | 86 | 91 & ABOVE | |
| | °C | 15 & BELOW | 20 | 25 | 30 | 33 & ABOVE | |
| LANDING CLIMB | | | -43.0 | -50.9 | -60.4 | -69.0 | -73.0 |

Takeoff EPR

Based on engine bleed for packs on, engine anti-ice on or off and wing anti-ice off

| AIRPORT OAT | | AIRPORT PRESSURE ALTITUDE (FT) | | | | | |
|-------------|----|--------------------------------|------|------|------|------|------|
| °F | °C | -1000 | 0 | 2000 | 4000 | 6000 | 8000 |
| 131 | 55 | 1.37 | 1.37 | 1.36 | 1.36 | 1.35 | 1.36 |
| 122 | 50 | 1.41 | 1.41 | 1.41 | 1.40 | 1.40 | 1.40 |
| 113 | 45 | 1.43 | 1.43 | 1.43 | 1.43 | 1.43 | 1.43 |
| 104 | 40 | 1.46 | 1.46 | 1.46 | 1.46 | 1.46 | 1.46 |
| 95 | 35 | 1.49 | 1.49 | 1.48 | 1.48 | 1.48 | 1.48 |
| 86 | 30 | 1.51 | 1.51 | 1.51 | 1.51 | 1.51 | 1.51 |
| 77 | 25 | 1.53 | 1.54 | 1.54 | 1.53 | 1.53 | 1.54 |
| 68 | 20 | 1.53 | 1.56 | 1.57 | 1.56 | 1.56 | 1.56 |
| 59 | 15 | 1.53 | 1.56 | 1.58 | 1.59 | 1.59 | 1.59 |
| 50 | 10 | 1.53 | 1.56 | 1.58 | 1.60 | 1.62 | 1.62 |
| 41 | 5 | 1.53 | 1.56 | 1.58 | 1.60 | 1.62 | 1.64 |
| 32 | 0 | 1.53 | 1.56 | 1.58 | 1.60 | 1.62 | 1.64 |

EPR Adjustments for Engine Bleeds

| BLEED CONFIGURATION | AIRPORT PRESSURE ALTITUDE (FT) | | | | | |
|---------------------|--------------------------------|-------|-------|-------|-------|-------|
| | -1000 | 0 | 2000 | 4000 | 6000 | 8000 |
| PACKS OFF | 0.01 | 0.01 | 0.01 | 0.01 | 0.01 | 0.01 |
| WING ANTI-ICE ON | -0.01 | -0.01 | -0.01 | -0.01 | -0.01 | -0.01 |

ALTERNATE EEC MODE

Go-around EPR

Based on engine bleed for packs on, engine anti-ice on or off and wing anti-ice off

| AIRPORT OAT | | TAT (°C) | AIRPORT PRESSURE ALTITUDE (FT) | | | | | |
|---------------|--------------|-------------|--------------------------------|------|------|------|------|------|
| °F | °C | | -1000 | 0 | 2000 | 4000 | 6000 | 8000 |
| 131 | 55 | 58 | 1.37 | 1.36 | 1.35 | 1.35 | 1.35 | 1.35 |
| 122 | 50 | 53 | 1.41 | 1.40 | 1.40 | 1.40 | 1.40 | 1.40 |
| 113 | 45 | 48 | 1.43 | 1.43 | 1.43 | 1.43 | 1.43 | 1.43 |
| 104 | 40 | 43 | 1.46 | 1.46 | 1.46 | 1.46 | 1.46 | 1.46 |
| 95 | 35 | 38 | 1.49 | 1.49 | 1.48 | 1.48 | 1.48 | 1.48 |
| 86 | 30 | 33 | 1.52 | 1.52 | 1.51 | 1.51 | 1.51 | 1.51 |
| 77 | 25 | 28 | 1.54 | 1.55 | 1.54 | 1.54 | 1.54 | 1.54 |
| 68 | 20 | 23 | 1.54 | 1.57 | 1.57 | 1.57 | 1.57 | 1.57 |
| 59 | 15 | 18 | 1.54 | 1.57 | 1.60 | 1.61 | 1.60 | 1.60 |
| 50 | 10 | 13 | 1.54 | 1.57 | 1.60 | 1.62 | 1.63 | 1.63 |
| 41 | 5 | 8 | 1.54 | 1.57 | 1.60 | 1.62 | 1.63 | 1.66 |
| 32 & BELOW | 0 & BELOW | 3 | 1.54 | 1.57 | 1.60 | 1.62 | 1.63 | 1.66 |

EPR Adjustments for Engine Bleeds

| BLEED CONFIGURATION | AIRPORT PRESSURE ALTITUDE (FT) | | | | | |
|------------------------|--------------------------------|-------|-------|-------|-------|-------|
| | -1000 | 0 | 2000 | 4000 | 6000 | 8000 |
| PACKS OFF | 0.01 | 0.01 | 0.01 | 0.01 | 0.02 | 0.02 |
| WING ANTI-ICE ON | -0.01 | -0.01 | -0.01 | -0.01 | -0.02 | -0.02 |

ALTERNATE EEC MODE**Go-around %N1****No EPR available****Based on engine bleed for packs on, engine anti-ice on or off and wing anti-ice off**

| AIRPORT OAT | | TAT (°C) | AIRPORT PRESSURE ALTITUDE (FT) | | | | | |
|-------------|-----|-------------|--------------------------------|-------|-------|-------|-------|-------|
| °F | °C | | -1000 | 0 | 2000 | 4000 | 6000 | 8000 |
| 131 | 55 | 58 | 94.6 | 94.6 | 94.5 | 94.5 | 94.4 | 94.4 |
| 122 | 50 | 53 | 96.3 | 96.3 | 96.2 | 96.1 | 96.1 | 96.0 |
| 113 | 45 | 48 | 97.2 | 97.1 | 97.0 | 97.0 | 96.9 | 96.9 |
| 104 | 40 | 43 | 97.8 | 97.8 | 97.7 | 97.6 | 97.6 | 97.5 |
| 95 | 35 | 38 | 98.4 | 98.3 | 98.2 | 98.2 | 98.1 | 98.1 |
| 86 | 30 | 33 | 99.0 | 98.9 | 98.8 | 98.8 | 98.7 | 98.7 |
| 77 | 25 | 28 | 99.3 | 99.5 | 99.4 | 99.4 | 99.3 | 99.3 |
| 68 | 20 | 23 | 98.2 | 100.1 | 100.0 | 100.0 | 99.9 | 99.9 |
| 59 | 15 | 18 | 97.4 | 99.2 | 100.4 | 100.8 | 100.5 | 100.5 |
| 50 | 10 | 13 | 96.6 | 98.4 | 99.4 | 100.5 | 101.1 | 101.1 |
| 41 | 5 | 8 | 95.7 | 97.5 | 98.6 | 99.5 | 100.2 | 101.5 |
| 32 | 0 | 3 | 94.9 | 96.6 | 97.7 | 98.6 | 99.3 | 100.4 |
| 23 | -5 | -2 | 94.0 | 95.7 | 96.8 | 97.7 | 98.4 | 99.5 |
| 14 | -10 | -7 | 93.1 | 94.8 | 95.9 | 96.8 | 97.5 | 98.6 |
| 5 | -15 | -13 | 92.1 | 93.8 | 94.8 | 95.7 | 96.4 | 97.4 |
| -4 | -20 | -18 | 91.2 | 92.9 | 93.9 | 94.7 | 95.4 | 96.5 |
| -13 | -25 | -23 | 90.3 | 91.9 | 92.9 | 93.8 | 94.5 | 95.5 |
| -22 | -30 | -28 | 89.4 | 91.0 | 92.0 | 92.9 | 93.6 | 94.6 |
| -31 | -35 | -33 | 88.5 | 90.1 | 91.1 | 91.9 | 92.6 | 93.6 |
| -40 | -40 | -38 | 87.5 | 89.2 | 90.1 | 90.9 | 91.7 | 92.6 |
| -49 | -45 | -43 | 86.6 | 88.1 | 89.1 | 90.0 | 90.7 | 91.6 |
| -58 | -50 | -48 | 85.7 | 87.2 | 88.2 | 89.0 | 89.7 | 90.6 |

%N1 Adjustments for Engine Bleeds

| BLEED CONFIGURATION | AIRPORT PRESSURE ALTITUDE (FT) | | | | | |
|------------------------|--------------------------------|------|------|------|------|------|
| | -1000 | 0 | 2000 | 4000 | 6000 | 8000 |
| PACKS OFF | 0.5 | 0.5 | 0.6 | 0.6 | 0.7 | 0.7 |
| WING ANTI-ICE ON | -0.5 | -0.5 | -0.6 | -0.6 | -0.7 | -0.7 |

ALTERNATE EEC MODE
ENGINE INOP

Initial Max Continuous %N1

No EPR available

Based on engine bleed for one pack on and anti-ice off

| TAT (°C) | PRESSURE ALTITUDE (1000 FT) | | | | | | | | |
|-------------|-----------------------------|-------|-------|-------|-------|-------|-------|-------|-------|
| | 27 | 29 | 31 | 33 | 35 | 37 | 39 | 41 | 43 |
| 20 | 101.3 | 99.7 | 98.2 | 96.6 | 95.0 | 94.9 | 94.8 | 94.8 | 94.7 |
| 15 | 102.6 | 101.1 | 99.6 | 98.0 | 96.4 | 96.4 | 96.3 | 96.2 | 96.1 |
| 10 | 104.2 | 102.5 | 100.9 | 99.4 | 97.8 | 97.8 | 97.7 | 97.6 | 97.5 |
| 5 | 104.7 | 104.0 | 102.3 | 100.7 | 99.2 | 99.1 | 99.0 | 99.0 | 98.9 |
| 0 | 103.5 | 103.7 | 103.6 | 102.0 | 100.5 | 100.4 | 100.3 | 100.3 | 100.2 |
| -5 | 102.6 | 102.6 | 102.7 | 102.8 | 101.4 | 101.3 | 101.2 | 101.1 | 101.1 |
| -10 | 101.6 | 101.6 | 101.8 | 101.9 | 102.1 | 102.1 | 102.0 | 102.0 | 101.9 |
| -15 | 100.7 | 100.6 | 100.8 | 100.9 | 101.0 | 101.1 | 101.0 | 101.0 | 100.9 |
| -20 | 99.7 | 99.7 | 99.8 | 99.9 | 100.0 | 100.1 | 100.1 | 100.0 | 99.9 |
| -25 | 98.7 | 98.7 | 98.8 | 98.9 | 99.0 | 99.1 | 99.1 | 99.0 | 98.9 |
| -30 | 97.7 | 97.7 | 97.8 | 97.9 | 98.0 | 98.1 | 98.1 | 98.0 | 97.9 |
| -35 | 96.7 | 96.7 | 96.8 | 96.9 | 97.0 | 97.1 | 97.0 | 97.0 | 96.9 |
| -40 | 95.7 | 95.6 | 95.8 | 95.9 | 96.0 | 96.1 | 96.0 | 96.0 | 95.9 |

%N1 Adjustments for Engine Bleed

| BLEED CONFIGURATION | PRESSURE ALTITUDE (1000 FT) | | | | | | | | |
|---------------------------|-----------------------------|------|------|------|------|------|------|------|------|
| | 27 | 29 | 31 | 33 | 35 | 37 | 39 | 41 | 43 |
| PACKS OFF | 0.6 | 0.6 | 0.7 | 0.7 | 0.8 | 0.8 | 0.9 | 1.0 | 1.1 |
| ENGINE ANTI-ICE ON | -1.2 | -1.2 | -1.3 | -1.3 | -1.3 | -1.4 | -1.4 | -1.5 | -1.6 |
| ENGINE & WING ANTI-ICE ON | -2.9 | -2.9 | -3.1 | -3.1 | -3.1 | -3.3 | -3.4 | -3.6 | -3.9 |

ALTERNATE EEC MODE**ENGINE INOP****Max Continuous %N1****No EPR available****Based on engine bleed for one pack on and anti-ice off****37000 FT to 20000 FT Pressure Altitudes**

| 37000 FT PRESS ALT | | TAT (°C) | | | | | | | | | | | |
|--------------------|-----|----------|-------|-------|-------|-------|-------|-------|-------|-------|-------|-------|-------|
| CIAS | M | -40 | -35 | -30 | -25 | -20 | -15 | -10 | -5 | 0 | 5 | 10 | 15 |
| 200 | .63 | 97.3 | 98.3 | 99.4 | 100.4 | 101.5 | 101.6 | 100.6 | 99.2 | 98.1 | 97.0 | 95.9 | 94.6 |
| 220 | .69 | 96.3 | 97.3 | 98.3 | 99.3 | 100.3 | 101.3 | 100.6 | 99.8 | 98.9 | 97.8 | 96.7 | 95.2 |
| 240 | .75 | 96.1 | 97.1 | 98.1 | 99.1 | 100.1 | 101.3 | 101.5 | 100.6 | 99.6 | 98.5 | 97.3 | 95.8 |
| 260 | .80 | 96.1 | 97.1 | 98.1 | 99.1 | 100.1 | 101.1 | 102.1 | 101.3 | 100.4 | 99.1 | 97.8 | 96.4 |
| 33000 FT PRESS ALT | | TAT (°C) | | | | | | | | | | | |
| CIAS | M | -40 | -35 | -30 | -25 | -20 | -15 | -10 | -5 | 0 | 5 | 10 | 15 |
| 200 | .58 | 98.1 | 99.2 | 100.2 | 101.2 | 102.2 | 102.5 | 101.4 | 99.6 | 98.5 | 97.4 | 96.4 | 95.3 |
| 220 | .63 | 97.4 | 98.4 | 99.5 | 100.5 | 101.5 | 102.6 | 102.0 | 100.4 | 99.3 | 98.3 | 97.2 | 95.9 |
| 240 | .68 | 96.5 | 97.5 | 98.5 | 99.5 | 100.5 | 101.6 | 102.2 | 101.1 | 100.2 | 99.1 | 98.0 | 96.6 |
| 260 | .74 | 96.2 | 97.2 | 98.2 | 99.2 | 100.2 | 101.2 | 102.3 | 102.1 | 101.0 | 99.9 | 98.7 | 97.3 |
| 29000 FT PRESS ALT | | TAT (°C) | | | | | | | | | | | |
| CIAS | M | -40 | -35 | -30 | -25 | -20 | -15 | -10 | -5 | 0 | 5 | 10 | 15 |
| 200 | .53 | 97.8 | 98.9 | 99.9 | 100.9 | 101.9 | 103.1 | 102.1 | 100.7 | 99.7 | 98.7 | 97.8 | 97.0 |
| 220 | .58 | 98.0 | 99.1 | 100.1 | 101.1 | 102.1 | 103.3 | 103.6 | 101.8 | 100.7 | 99.6 | 98.6 | 97.5 |
| 240 | .63 | 97.3 | 98.4 | 99.4 | 100.4 | 101.4 | 102.4 | 103.6 | 102.9 | 101.6 | 100.6 | 99.5 | 98.3 |
| 260 | .68 | 96.6 | 97.7 | 98.7 | 99.7 | 100.7 | 101.7 | 102.7 | 103.6 | 102.6 | 101.6 | 100.5 | 99.1 |
| 25000 FT PRESS ALT | | TAT (°C) | | | | | | | | | | | |
| CIAS | M | -40 | -35 | -30 | -25 | -20 | -15 | -10 | -5 | 0 | 5 | 10 | 15 |
| 200 | .49 | 96.5 | 97.6 | 98.6 | 99.6 | 100.6 | 101.6 | 102.5 | 101.4 | 100.5 | 99.6 | 98.7 | 98.0 |
| 220 | .53 | 96.8 | 97.8 | 98.9 | 99.9 | 100.9 | 101.9 | 103.1 | 102.9 | 101.7 | 100.8 | 99.8 | 99.0 |
| 240 | .58 | 96.9 | 97.9 | 99.0 | 100.0 | 101.0 | 102.0 | 102.9 | 103.9 | 102.8 | 101.8 | 100.7 | 99.7 |
| 260 | .63 | 96.8 | 97.8 | 98.8 | 99.9 | 100.9 | 101.9 | 102.8 | 104.0 | 104.1 | 102.9 | 101.8 | 100.6 |
| 22000 FT PRESS ALT | | TAT (°C) | | | | | | | | | | | |
| CIAS | M | -15 | -10 | -5 | 0 | 5 | 10 | 15 | 20 | 25 | 30 | 35 | |
| 200 | .46 | 101.0 | 102.1 | 102.4 | 101.3 | 100.3 | 99.4 | 98.5 | 97.6 | 96.7 | 95.9 | 95.1 | |
| 240 | .55 | 101.6 | 102.6 | 103.7 | 103.8 | 102.6 | 101.7 | 100.8 | 100.0 | 99.2 | 98.4 | 97.7 | |
| 280 | .63 | 101.3 | 102.3 | 103.3 | 104.4 | 104.5 | 103.3 | 102.1 | 101.0 | 100.2 | 99.4 | 98.7 | |
| 20000 FT PRESS ALT | | TAT (°C) | | | | | | | | | | | |
| CIAS | M | -15 | -10 | -5 | 0 | 5 | 10 | 15 | 20 | 25 | 30 | 35 | |
| 200 | .44 | 101.0 | 101.9 | 103.0 | 102.1 | 101.1 | 100.2 | 99.2 | 98.2 | 97.3 | 96.4 | 95.6 | |
| 240 | .53 | 101.5 | 102.5 | 103.5 | 104.4 | 103.4 | 102.5 | 101.7 | 101.0 | 100.2 | 99.4 | 98.7 | |
| 280 | .61 | 101.1 | 102.1 | 103.1 | 104.0 | 104.9 | 103.7 | 102.6 | 101.7 | 100.8 | 100.0 | 99.3 | |

%N1 Adjustments for Engine Bleed

| BLEED CONFIGURATION | PRESSURE ALTITUDE (1000 FT) | | | | | |
|---------------------------|-----------------------------|------|------|------|------|------|
| | 20 | 22 | 25 | 29 | 33 | 37 |
| PACKS OFF | 0.5 | 0.5 | 0.5 | 0.6 | 0.7 | 0.8 |
| ENGINE ANTI-ICE ON | -1.2 | -1.2 | -1.2 | -1.2 | -1.3 | -1.4 |
| ENGINE & WING ANTI-ICE ON | -2.9 | -2.9 | -2.9 | -2.9 | -3.1 | -3.3 |

ALTERNATE EEC MODE
ENGINE INOP

Max Continuous %N1

No EPR available

Based on engine bleed for one pack on and anti-ice off

18000 FT to 8000 FT Pressure Altitudes

| 18000 FT PRESS ALT | | | | | | | | | | | | |
|--------------------|-----|----------|-------|-------|-------|-------|-------|-------|-------|-------|-------|-------|
| | | TAT (°C) | | | | | | | | | | |
| CIAS | M | -15 | -10 | -5 | 0 | 5 | 10 | 15 | 20 | 25 | 30 | 35 |
| 200 | .42 | 100.2 | 101.1 | 102.3 | 102.7 | 101.6 | 100.6 | 99.6 | 98.5 | 97.5 | 96.6 | 95.8 |
| 240 | .51 | 101.4 | 102.4 | 103.4 | 104.5 | 104.7 | 103.6 | 103.0 | 102.3 | 101.6 | 100.9 | 100.1 |
| 280 | .59 | 100.7 | 101.7 | 102.7 | 103.6 | 104.8 | 104.7 | 103.5 | 102.6 | 101.8 | 100.9 | 100.3 |
| 16000 FT PRESS ALT | | | | | | | | | | | | |
| | | TAT (°C) | | | | | | | | | | |
| CIAS | M | -15 | -10 | -5 | 0 | 5 | 10 | 15 | 20 | 25 | 30 | 35 |
| 200 | .41 | 98.7 | 99.6 | 100.6 | 101.7 | 101.6 | 100.3 | 99.2 | 98.0 | 97.0 | 96.1 | 95.3 |
| 240 | .49 | 100.4 | 101.3 | 102.3 | 103.2 | 104.3 | 103.8 | 103.0 | 102.3 | 101.5 | 100.8 | 100.0 |
| 280 | .57 | 100.3 | 101.3 | 102.3 | 103.2 | 104.2 | 105.2 | 104.3 | 103.5 | 102.7 | 101.9 | 101.2 |
| 14000 FT PRESS ALT | | | | | | | | | | | | |
| | | TAT (°C) | | | | | | | | | | |
| CIAS | M | -15 | -10 | -5 | 0 | 5 | 10 | 15 | 20 | 25 | 30 | 35 |
| 200 | .39 | 97.2 | 98.1 | 99.0 | 99.9 | 100.9 | 100.0 | 98.9 | 97.6 | 96.6 | 95.7 | 94.9 |
| 240 | .47 | 98.0 | 99.0 | 99.9 | 100.8 | 101.7 | 102.5 | 101.6 | 100.7 | 99.9 | 99.1 | 98.3 |
| 280 | .54 | 99.0 | 99.9 | 100.9 | 101.8 | 102.7 | 103.8 | 104.2 | 103.2 | 102.5 | 101.7 | 100.9 |
| 12000 FT PRESS ALT | | | | | | | | | | | | |
| | | TAT (°C) | | | | | | | | | | |
| CIAS | M | -10 | -5 | 0 | 5 | 10 | 15 | 20 | 25 | 30 | 35 | 40 |
| 200 | .38 | 96.7 | 97.6 | 98.5 | 99.5 | 100.1 | 98.8 | 97.6 | 96.5 | 95.6 | 94.8 | 94.2 |
| 240 | .45 | 96.8 | 97.7 | 98.6 | 99.5 | 100.6 | 100.6 | 99.4 | 98.5 | 97.7 | 96.9 | 96.2 |
| 10000 FT PRESS ALT | | | | | | | | | | | | |
| | | TAT (°C) | | | | | | | | | | |
| CIAS | M | -10 | -5 | 0 | 5 | 10 | 15 | 20 | 25 | 30 | 35 | 40 |
| 200 | .36 | 95.3 | 96.2 | 97.1 | 98.0 | 99.1 | 98.9 | 97.6 | 96.5 | 95.6 | 94.8 | 94.1 |
| 240 | .43 | 94.9 | 95.8 | 96.7 | 97.5 | 98.4 | 99.4 | 98.5 | 97.5 | 96.7 | 95.9 | 95.2 |
| 8000 FT PRESS ALT | | | | | | | | | | | | |
| | | TAT (°C) | | | | | | | | | | |
| CIAS | M | -10 | -5 | 0 | 5 | 10 | 15 | 20 | 25 | 30 | 35 | 40 |
| 200 | .35 | 93.9 | 94.8 | 95.6 | 96.5 | 97.4 | 98.4 | 97.6 | 96.4 | 95.5 | 94.7 | 94.0 |
| 240 | .42 | 93.1 | 94.0 | 94.8 | 95.7 | 96.6 | 97.5 | 98.0 | 96.9 | 96.0 | 95.2 | 94.5 |

%N1 Adjustments for Engine Bleed

| BLEED CONFIGURATION | PRESSURE ALTITUDE (1000 FT) | | | | | |
|---------------------------|-----------------------------|------|------|------|------|------|
| | 8 | 10 | 12 | 14 | 16 | 18 |
| PACKS OFF | 0.5 | 0.5 | 0.5 | 0.5 | 0.5 | 0.5 |
| ENGINE ANTI-ICE ON | -0.9 | -0.9 | -1.0 | -1.0 | -1.1 | -1.2 |
| ENGINE & WING ANTI-ICE ON | -2.1 | -2.1 | -2.3 | -2.4 | -2.6 | -2.8 |

ALTERNATE EEC MODE**ENGINE INOP****Max Continuous %N1****No EPR available****Based on engine bleed for one pack on and anti-ice off****6000 FT to Sea Level Pressure Altitudes**

| 6000 FT PRESS ALT | | TAT (°C) | | | | | | | | | | |
|-------------------|-----|----------|------|------|------|------|------|------|------|------|------|------|
| CIAS | M | -10 | -5 | 0 | 5 | 10 | 15 | 20 | 25 | 30 | 35 | 40 |
| 200 | .34 | 92.5 | 93.4 | 94.2 | 95.1 | 95.9 | 96.8 | 97.5 | 96.4 | 95.5 | 94.6 | 93.9 |
| 240 | .40 | 91.6 | 92.5 | 93.3 | 94.2 | 95.0 | 95.9 | 96.9 | 96.8 | 95.6 | 94.9 | 94.2 |
| 4000 FT PRESS ALT | | TAT (°C) | | | | | | | | | | |
| CIAS | M | -10 | -5 | 0 | 5 | 10 | 15 | 20 | 25 | 30 | 35 | 40 |
| 200 | .32 | 91.2 | 92.0 | 92.9 | 93.7 | 94.6 | 95.4 | 96.4 | 96.6 | 95.4 | 94.6 | 93.9 |
| 240 | .39 | 90.4 | 91.2 | 92.1 | 92.9 | 93.7 | 94.6 | 95.4 | 96.3 | 95.6 | 94.8 | 94.2 |
| 2000 FT PRESS ALT | | TAT (°C) | | | | | | | | | | |
| CIAS | M | -10 | -5 | 0 | 5 | 10 | 15 | 20 | 25 | 30 | 35 | 40 |
| 200 | .31 | 89.9 | 90.8 | 91.6 | 92.5 | 93.3 | 94.1 | 94.9 | 95.9 | 95.6 | 94.5 | 93.8 |
| 240 | .38 | 89.2 | 90.1 | 90.9 | 91.8 | 92.6 | 93.4 | 94.2 | 95.0 | 95.7 | 94.8 | 94.1 |
| 0 FT PRESS ALT | | TAT (°C) | | | | | | | | | | |
| CIAS | M | -10 | -5 | 0 | 5 | 10 | 15 | 20 | 25 | 30 | 35 | 40 |
| 200 | .30 | 87.4 | 88.2 | 89.1 | 89.9 | 90.7 | 91.5 | 92.3 | 93.1 | 93.9 | 93.1 | 92.4 |
| 240 | .36 | 86.9 | 87.7 | 88.5 | 89.3 | 90.1 | 90.9 | 91.7 | 92.5 | 93.4 | 93.5 | 92.6 |

%N1 Adjustments for Engine Bleed

| BLEED CONFIGURATION | PRESSURE ALTITUDE (1000 FT) | | | |
|---------------------------|-----------------------------|------|------|------|
| | 0 | 2 | 4 | 6 |
| PACKS OFF | 0.4 | 0.5 | 0.5 | 0.5 |
| ENGINE ANTI-ICE ON | -0.6 | -0.7 | -0.8 | -0.9 |
| ENGINE & WING ANTI-ICE ON | -1.5 | -1.7 | -1.9 | -2.0 |

Intentionally
Blank

Performance Inflight - Gear Down

Chapter PI Section 25

GEAR DOWN

200 KIAS Max Climb EPR

Based on engine bleed for packs on and anti-ice off

| TAT (°C) | PRESSURE ALTITUDE (1000 FT) | | | | | | | | | | | | | | |
|-------------|-----------------------------|------|------|------|------|------|------|------|------|------|------|------|------|------|------|
| | 0 | 5 | 10 | 12 | 14 | 16 | 18 | 20 | 22 | 24 | 26 | 28 | 30 | 32 | 34 |
| 55 | 1.27 | | | | | | | | | | | | | | |
| 50 | 1.29 | 1.31 | | | | | | | | | | | | | |
| 45 | 1.31 | 1.33 | 1.33 | | | | | | | | | | | | |
| 40 | 1.34 | 1.36 | 1.35 | 1.35 | 1.35 | | | | | | | | | | |
| 35 | 1.36 | 1.38 | 1.38 | 1.38 | 1.38 | 1.38 | | | | | | | | | |
| 30 | 1.36 | 1.42 | 1.41 | 1.41 | 1.41 | 1.41 | 1.41 | | | | | | | | |
| 25 | 1.36 | 1.44 | 1.45 | 1.45 | 1.45 | 1.45 | 1.44 | 1.44 | 1.44 | | | | | | |
| 20 | 1.36 | 1.44 | 1.49 | 1.49 | 1.49 | 1.49 | 1.48 | 1.48 | 1.48 | 1.48 | | | | | |
| 15 | 1.36 | 1.44 | 1.51 | 1.53 | 1.53 | 1.53 | 1.53 | 1.52 | 1.52 | 1.52 | 1.51 | | | | |
| 10 | 1.36 | 1.44 | 1.51 | 1.54 | 1.57 | 1.57 | 1.57 | 1.57 | 1.57 | 1.57 | 1.56 | 1.55 | | | |
| 5 | 1.36 | 1.44 | 1.51 | 1.54 | 1.57 | 1.60 | 1.62 | 1.62 | 1.61 | 1.61 | 1.61 | 1.60 | 1.59 | 1.57 | |
| 0 | 1.36 | 1.44 | 1.51 | 1.54 | 1.57 | 1.60 | 1.63 | 1.66 | 1.66 | 1.66 | 1.65 | 1.64 | 1.63 | 1.62 | 1.59 |
| -5 | 1.36 | 1.44 | 1.51 | 1.54 | 1.57 | 1.60 | 1.63 | 1.66 | 1.69 | 1.70 | 1.70 | 1.69 | 1.68 | 1.66 | 1.64 |
| -10 | 1.36 | 1.44 | 1.51 | 1.54 | 1.57 | 1.60 | 1.63 | 1.66 | 1.69 | 1.71 | 1.73 | 1.73 | 1.72 | 1.71 | 1.68 |
| -15 | 1.36 | 1.44 | 1.51 | 1.54 | 1.57 | 1.60 | 1.63 | 1.66 | 1.69 | 1.71 | 1.73 | 1.75 | 1.76 | 1.75 | 1.72 |
| -20 | 1.36 | 1.44 | 1.51 | 1.54 | 1.57 | 1.60 | 1.63 | 1.66 | 1.69 | 1.71 | 1.73 | 1.75 | 1.76 | 1.76 | 1.75 |

EPR Adjustments for Engine Bleeds

| BLEED CONFIGURATION | PRESSURE ALTITUDE (1000 FT) | | | | | | | | | | | | | | |
|---------------------------|-----------------------------|-------|-------|-------|-------|-------|-------|-------|-------|-------|-------|-------|-------|-------|-------|
| | 0 | 5 | 10 | 12 | 14 | 18 | 20 | 22 | 24 | 26 | 28 | 30 | 34 | | |
| PACKS OFF | 0.01 | 0.01 | 0.01 | 0.01 | 0.01 | 0.01 | 0.01 | 0.01 | 0.01 | 0.01 | 0.01 | 0.02 | 0.02 | 0.02 | 0.02 |
| ENGINE ANTI-ICE ON | -0.01 | -0.02 | -0.02 | -0.02 | -0.03 | -0.03 | -0.03 | -0.03 | -0.03 | -0.03 | -0.03 | -0.04 | -0.04 | -0.04 | -0.04 |
| ENGINE & WING ANTI-ICE ON | -0.02 | -0.03 | -0.04 | -0.04 | -0.05 | -0.05 | -0.05 | -0.05 | -0.05 | -0.05 | -0.05 | -0.06 | -0.07 | -0.07 | -0.07 |

GEAR DOWN

Long Range Cruise Altitude Capability

| WEIGHT (1000 LB) | PRESSURE ALTITUDE (FT) | | |
|---------------------|------------------------|------------|------------|
| | ISA + 10°C & BELOW | ISA + 15°C | ISA + 20°C |
| 420 | 18400 | 18400 | 16500 |
| 400 | 20200 | 20200 | 18400 |
| 380 | 21800 | 21800 | 20300 |
| 360 | 23500 | 23500 | 22000 |
| 340 | 25200 | 25200 | 23800 |
| 320 | 26900 | 26900 | 25700 |
| 300 | 28700 | 28700 | 27500 |
| 280 | 30300 | 30300 | 29200 |
| 260 | 32100 | 32000 | 31000 |
| 240 | 33700 | 33700 | 33000 |
| 220 | 35200 | 35200 | 34600 |

GEAR DOWN**Long Range Cruise Control**

| WEIGHT (1000 LB) | | PRESSURE ALTITUDE (1000 FT) | | | | | | | | | | |
|---------------------|--------|-----------------------------|-------|-------|-------|------|------|------|------|------|------|------|
| | | 10 | 14 | 18 | 21 | 23 | 25 | 27 | 29 | 31 | 33 | 35 |
| 420 | EPR | 1.25 | 1.32 | 1.44 | | | | | | | | |
| | MACH | .473 | .507 | .546 | | | | | | | | |
| | KIAS | 261 | 260 | 260 | | | | | | | | |
| | FF/ENG | 10970 | 11061 | 11319 | | | | | | | | |
| 400 | EPR | 1.23 | 1.30 | 1.40 | | | | | | | | |
| | MACH | .463 | .496 | .534 | | | | | | | | |
| | KIAS | 256 | 255 | 254 | | | | | | | | |
| | FF/ENG | 10409 | 10438 | 10609 | | | | | | | | |
| 380 | EPR | 1.21 | 1.27 | 1.36 | 1.46 | | | | | | | |
| | MACH | .454 | .485 | .521 | .552 | | | | | | | |
| | KIAS | 251 | 249 | 248 | 247 | | | | | | | |
| | FF/ENG | 9880 | 9825 | 9898 | 10129 | | | | | | | |
| 360 | EPR | 1.20 | 1.25 | 1.33 | 1.42 | 1.49 | | | | | | |
| | MACH | .444 | .473 | .509 | .539 | .560 | | | | | | |
| | KIAS | 245 | 243 | 241 | 241 | 241 | | | | | | |
| | FF/ENG | 9357 | 9234 | 9222 | 9426 | 9649 | | | | | | |
| 340 | EPR | 1.18 | 1.23 | 1.30 | 1.38 | 1.44 | 1.52 | | | | | |
| | MACH | .434 | .462 | .496 | .525 | .546 | .567 | | | | | |
| | KIAS | 240 | 237 | 235 | 235 | 235 | 234 | | | | | |
| | FF/ENG | 8839 | 8678 | 8596 | 8731 | 8944 | 9178 | | | | | |
| 320 | EPR | 1.17 | 1.21 | 1.27 | 1.34 | 1.39 | 1.46 | | | | | |
| | MACH | .422 | .451 | .483 | .510 | .531 | .552 | | | | | |
| | KIAS | 233 | 231 | 229 | 228 | 228 | 228 | | | | | |
| | FF/ENG | 8299 | 8170 | 7990 | 8034 | 8239 | 8461 | | | | | |
| 300 | EPR | 1.15 | 1.19 | 1.25 | 1.30 | 1.35 | 1.41 | 1.49 | | | | |
| | MACH | .409 | .440 | .469 | .496 | .515 | .536 | .558 | | | | |
| | KIAS | 226 | 225 | 222 | 222 | 221 | 221 | 220 | | | | |
| | FF/ENG | 7763 | 7671 | 7440 | 7414 | 7536 | 7749 | 7946 | | | | |
| 280 | EPR | 1.14 | 1.17 | 1.22 | 1.27 | 1.31 | 1.36 | 1.43 | 1.51 | | | |
| | MACH | .398 | .427 | .456 | .481 | .500 | .519 | .541 | .563 | | | |
| | KIAS | 220 | 218 | 216 | 215 | 214 | 213 | 214 | 213 | | | |
| | FF/ENG | 7263 | 7163 | 6937 | 6845 | 6900 | 7038 | 7238 | 7431 | | | |
| 260 | EPR | 1.12 | 1.16 | 1.20 | 1.24 | 1.28 | 1.32 | 1.37 | 1.44 | 1.53 | | |
| | MACH | .385 | .412 | .443 | .466 | .483 | .503 | .523 | .545 | .568 | | |
| | KIAS | 212 | 211 | 210 | 208 | 207 | 206 | 206 | 206 | 206 | | |
| | FF/ENG | 6753 | 6633 | 6450 | 6316 | 6324 | 6397 | 6527 | 6716 | 6908 | | |
| 240 | EPR | 1.11 | 1.14 | 1.18 | 1.21 | 1.24 | 1.28 | 1.32 | 1.38 | 1.45 | 1.55 | |
| | MACH | .370 | .398 | .428 | .451 | .467 | .485 | .504 | .525 | .547 | .571 | |
| | KIAS | 204 | 204 | 202 | 201 | 200 | 199 | 198 | 198 | 198 | 198 | |
| | FF/ENG | 6217 | 6145 | 5971 | 5837 | 5797 | 5815 | 5875 | 6011 | 6189 | 6365 | |
| 220 | EPR | 1.10 | 1.12 | 1.16 | 1.19 | 1.21 | 1.24 | 1.28 | 1.33 | 1.39 | 1.46 | 1.56 |
| | MACH | .355 | .383 | .411 | .436 | .451 | .467 | .485 | .505 | .526 | .549 | .573 |
| | KIAS | 196 | 196 | 194 | 194 | 193 | 191 | 191 | 190 | 190 | 190 | 189 |
| | FF/ENG | 5722 | 5651 | 5473 | 5377 | 5327 | 5294 | 5300 | 5354 | 5490 | 5653 | 5817 |

GEAR DOWN

**Long Range Cruise Enroute Fuel and Time
Ground to Air Miles Conversion**

| AIR DISTANCE (NM) | | | | | GROUND DISTANCE (NM) | AIR DISTANCE (NM) | | | | |
|--------------------------|------|------|------|------|----------------------------|--------------------------|------|------|------|------|
| HEADWIND COMPONENT (KTS) | | | | | | TAILWIND COMPONENT (KTS) | | | | |
| 100 | 80 | 60 | 40 | 20 | | 20 | 40 | 60 | 80 | 100 |
| 322 | 288 | 259 | 236 | 217 | 200 | 189 | 179 | 170 | 161 | 154 |
| 651 | 581 | 521 | 474 | 434 | 400 | 377 | 357 | 338 | 321 | 307 |
| 984 | 877 | 785 | 712 | 652 | 600 | 566 | 535 | 507 | 483 | 461 |
| 1321 | 1176 | 1051 | 952 | 871 | 800 | 755 | 713 | 676 | 642 | 613 |
| 1663 | 1477 | 1318 | 1192 | 1089 | 1000 | 943 | 891 | 844 | 802 | 765 |
| 2010 | 1782 | 1587 | 1433 | 1309 | 1200 | 1131 | 1068 | 1011 | 961 | 917 |
| 2363 | 2091 | 1858 | 1676 | 1528 | 1400 | 1319 | 1245 | 1179 | 1120 | 1068 |
| 2720 | 2403 | 2132 | 1920 | 1749 | 1600 | 1507 | 1422 | 1346 | 1278 | 1218 |
| 3083 | 2718 | 2407 | 2165 | 1969 | 1800 | 1694 | 1598 | 1512 | 1435 | 1368 |
| 3451 | 3037 | 2685 | 2411 | 2190 | 2000 | 1882 | 1775 | 1678 | 1593 | 1518 |

Reference Fuel and Time Required at Check Point

| AIR DIST (NM) | PRESSURE ALTITUDE (1000 FT) | | | | | | | | | |
|---------------------|-----------------------------|------------------|-------------------|------------------|-------------------|------------------|-------------------|------------------|-------------------|------------------|
| | 10 | | 14 | | 18 | | 22 | | 28 | |
| | FUEL (1000 LB) | TIME (HR:MIN) | FUEL (1000 LB) | TIME (HR:MIN) | FUEL (1000 LB) | TIME (HR:MIN) | FUEL (1000 LB) | TIME (HR:MIN) | FUEL (1000 LB) | TIME (HR:MIN) |
| 200 | 10.8 | 0:50 | 9.8 | 0:48 | 8.8 | 0:46 | 8.0 | 0:44 | 7.4 | 0:42 |
| 400 | 22.4 | 1:37 | 20.6 | 1:32 | 18.7 | 1:28 | 17.4 | 1:24 | 16.6 | 1:18 |
| 600 | 33.7 | 2:25 | 31.2 | 2:17 | 28.5 | 2:11 | 26.5 | 2:04 | 25.5 | 1:55 |
| 800 | 44.7 | 3:13 | 41.5 | 3:03 | 38.1 | 2:54 | 35.5 | 2:45 | 34.2 | 2:32 |
| 1000 | 55.5 | 4:03 | 51.7 | 3:50 | 47.5 | 3:38 | 44.3 | 3:27 | 42.7 | 3:10 |
| 1200 | 66.0 | 4:54 | 61.6 | 4:38 | 56.6 | 4:23 | 52.8 | 4:09 | 50.8 | 3:48 |
| 1400 | 76.3 | 5:46 | 71.3 | 5:26 | 65.6 | 5:08 | 61.2 | 4:52 | 58.8 | 4:27 |
| 1600 | 86.4 | 6:39 | 80.8 | 6:16 | 74.5 | 5:54 | 69.5 | 5:35 | 66.5 | 5:07 |
| 1800 | 96.3 | 7:33 | 90.0 | 7:06 | 83.1 | 6:41 | 77.5 | 6:19 | 74.0 | 5:47 |
| 2000 | 105.9 | 8:28 | 99.1 | 7:58 | 91.6 | 7:29 | 85.5 | 7:04 | 81.3 | 6:27 |

Fuel Required Adjustment (1000 LB)

| REFERENCE FUEL REQUIRED (1000 LB) | WEIGHT AT CHECK POINT (1000 LB) | | | | |
|--------------------------------------|---------------------------------|-------|-----|------|------|
| | 200 | 250 | 300 | 350 | 400 |
| 10 | -1.7 | -0.8 | 0.0 | 1.4 | 2.8 |
| 20 | -3.6 | -1.8 | 0.0 | 2.9 | 6.0 |
| 30 | -5.5 | -2.8 | 0.0 | 4.5 | 9.1 |
| 40 | -7.4 | -3.7 | 0.0 | 6.0 | 12.2 |
| 50 | -9.3 | -4.7 | 0.0 | 7.5 | 15.3 |
| 60 | -11.1 | -5.6 | 0.0 | 9.1 | 18.4 |
| 70 | -12.9 | -6.6 | 0.0 | 10.6 | 21.4 |
| 80 | -14.7 | -7.5 | 0.0 | 12.1 | 24.5 |
| 90 | -16.4 | -8.4 | 0.0 | 13.7 | 27.5 |
| 100 | -18.2 | -9.3 | 0.0 | 15.2 | 30.5 |
| 110 | -19.9 | -10.3 | 0.0 | 16.7 | 33.5 |

Descent at VREF30 + 70

| PRESSURE ALTITUDE (1000 FT) | 5 | 10 | 15 | 17 | 19 | 21 | 23 | 25 | 27 | 29 | 31 | 33 | 35 |
|-----------------------------|----|----|----|----|----|----|----|----|----|----|----|----|----|
| DISTANCE (NM) | 16 | 26 | 36 | 40 | 44 | 48 | 52 | 56 | 60 | 65 | 68 | 72 | 76 |
| TIME (MINUTES) | 7 | 10 | 12 | 13 | 14 | 15 | 16 | 17 | 17 | 18 | 19 | 20 | 20 |

GEAR DOWN

**Holding
 Flaps Up**

| WEIGHT (1000 LB) | | PRESSURE ALTITUDE (FT) | | | | | | |
|---------------------|--------|------------------------|-------|-------|-------|-------|-------|-------|
| | | 1500 | 5000 | 10000 | 15000 | 20000 | 25000 | 30000 |
| 420 | EPR | 1.14 | 1.18 | 1.24 | 1.33 | | | |
| | KIAS | 249 | 249 | 249 | 249 | | | |
| | FF/ENG | 10890 | 10820 | 10860 | 11030 | | | |
| 400 | EPR | 1.13 | 1.16 | 1.22 | 1.30 | 1.44 | | |
| | KIAS | 242 | 242 | 242 | 242 | 242 | | |
| | FF/ENG | 10320 | 10230 | 10240 | 10320 | 10640 | | |
| 380 | EPR | 1.12 | 1.15 | 1.20 | 1.28 | 1.40 | | |
| | KIAS | 236 | 236 | 236 | 236 | 236 | | |
| | FF/ENG | 9750 | 9660 | 9640 | 9640 | 9880 | | |
| 360 | EPR | 1.11 | 1.14 | 1.18 | 1.25 | 1.36 | | |
| | KIAS | 229 | 229 | 229 | 229 | 229 | | |
| | FF/ENG | 9200 | 9110 | 9060 | 9000 | 9140 | | |
| 340 | EPR | 1.10 | 1.13 | 1.17 | 1.23 | 1.32 | 1.49 | |
| | KIAS | 221 | 221 | 221 | 221 | 221 | 221 | |
| | FF/ENG | 8620 | 8540 | 8470 | 8390 | 8390 | 8980 | |
| 320 | EPR | 1.09 | 1.12 | 1.16 | 1.21 | 1.29 | 1.43 | |
| | KIAS | 215 | 215 | 215 | 215 | 215 | 215 | |
| | FF/ENG | 8110 | 8030 | 7980 | 7870 | 7790 | 8260 | |
| 300 | EPR | 1.09 | 1.11 | 1.14 | 1.19 | 1.27 | 1.39 | |
| | KIAS | 210 | 210 | 210 | 210 | 210 | 210 | |
| | FF/ENG | 7640 | 7580 | 7530 | 7410 | 7290 | 7620 | |
| 280 | EPR | 1.08 | 1.10 | 1.13 | 1.17 | 1.24 | 1.34 | 1.53 |
| | KIAS | 205 | 205 | 205 | 205 | 205 | 205 | 205 |
| | FF/ENG | 7180 | 7130 | 7070 | 6960 | 6810 | 7000 | 7540 |
| 260 | EPR | 1.07 | 1.09 | 1.12 | 1.16 | 1.22 | 1.31 | 1.46 |
| | KIAS | 200 | 200 | 200 | 200 | 200 | 200 | 200 |
| | FF/ENG | 6720 | 6660 | 6620 | 6510 | 6340 | 6430 | 6870 |
| 240 | EPR | 1.06 | 1.08 | 1.10 | 1.14 | 1.19 | 1.27 | 1.40 |
| | KIAS | 194 | 194 | 194 | 194 | 194 | 194 | 194 |
| | FF/ENG | 6300 | 6210 | 6180 | 6080 | 5910 | 5930 | 6230 |
| 220 | EPR | 1.06 | 1.07 | 1.09 | 1.13 | 1.17 | 1.24 | 1.35 |
| | KIAS | 189 | 189 | 189 | 189 | 189 | 189 | 189 |
| | FF/ENG | 5890 | 5780 | 5750 | 5660 | 5490 | 5470 | 5630 |

This table includes 5% additional fuel for holding in a racetrack pattern.

Intentionally
Blank

**Performance Inflight -
Gear Down, Engine Inop****Chapter PI
Section 26****GEAR DOWN****ENGINE INOP****Initial Max Continuous EPR****Based on engine bleed for one pack on and APU off**

| PRESSURE ALTITUDE (FT) | | CRUISE MACH NUMBER | | |
|---------------------------|----------|--------------------|------|------|
| | | .40 | .50 | .60 |
| 29000 | EPR | 1.75 | 1.78 | 1.75 |
| | MAX TAT | -10 | -15 | -8 |
| | EPR CORR | 0.09 | 0.09 | 0.09 |
| 27000 | EPR | 1.75 | 1.78 | 1.76 |
| | MAX TAT | -10 | -12 | -6 |
| | EPR CORR | 0.09 | 0.09 | 0.09 |
| 25000 | EPR | 1.75 | 1.78 | 1.76 |
| | MAX TAT | -10 | -10 | -3 |
| | EPR CORR | 0.09 | 0.09 | 0.09 |
| 23000 | EPR | 1.75 | 1.78 | 1.76 |
| | MAX TAT | -11 | -6 | -1 |
| | EPR CORR | 0.08 | 0.09 | 0.09 |
| 21000 | EPR | 1.73 | 1.78 | 1.75 |
| | MAX TAT | -7 | -3 | 3 |
| | EPR CORR | 0.09 | 0.09 | 0.09 |
| 19000 | EPR | 1.71 | 1.78 | 1.74 |
| | MAX TAT | -4 | 0 | 7 |
| | EPR CORR | 0.10 | 0.09 | 0.09 |
| 15000 | EPR | 1.63 | 1.76 | 1.70 |
| | MAX TAT | 4 | 9 | 15 |
| | EPR CORR | 0.09 | 0.09 | 0.09 |
| 10000 | EPR | 1.54 | 1.59 | 1.54 |
| | MAX TAT | 14 | 20 | 25 |
| | EPR CORR | 0.08 | 0.08 | 0.07 |

Decrease EPR by the EPR CORR for every 10°C above the MAX TAT shown.

GEAR DOWN

ENGINE INOP

MAX CONTINUOUS THRUST

Driftdown Speed/Level Off Altitude

100 ft/min residual rate of climb

| WEIGHT (1000 LB) | | OPTIMUM DRIFTDOWN SPEED (KIAS) | LEVEL OFF ALTITUDE (FT) | | |
|------------------------|--------------|---|-------------------------|------------|------------|
| START DRIFT DOWN | LEVEL OFF | | ISA + 10°C & BELOW | ISA + 15°C | ISA + 20°C |
| 380 | 362 | 233 | 4900 | 3100 | |
| 360 | 344 | 226 | 7400 | 5700 | 3700 |
| 340 | 326 | 218 | 9700 | 8200 | 6400 |
| 320 | 306 | 213 | 11700 | 10500 | 8900 |
| 300 | 288 | 208 | 13600 | 12800 | 11200 |
| 280 | 270 | 203 | 15500 | 15100 | 13800 |
| 260 | 250 | 198 | 17100 | 17000 | 16100 |
| 240 | 231 | 193 | 19100 | 19000 | 18400 |
| 220 | 212 | 187 | 21000 | 20900 | 20400 |

Includes APU fuel burn.

Long Range Cruise Altitude Capability

100 ft/min residual rate of climb

| WEIGHT (1000 LB) | PRESSURE ALTITUDE (FT) | | |
|---------------------|------------------------|------------|------------|
| | ISA + 10°C & BELOW | ISA + 15°C | ISA + 20°C |
| 340 | 3300 | | |
| 330 | 4800 | | |
| 320 | 6400 | 3700 | |
| 310 | 7900 | 5500 | 2700 |
| 300 | 9400 | 7100 | 4500 |
| 290 | 10900 | 8800 | 6300 |
| 280 | 12300 | 10500 | 8100 |
| 270 | 13700 | 12100 | 9800 |
| 260 | 15100 | 13600 | 11600 |
| 250 | 16500 | 15000 | 13400 |
| 240 | 17800 | 16300 | 14900 |
| 230 | 19000 | 17800 | 16300 |
| 220 | 20200 | 19100 | 17700 |

GEAR DOWN

ENGINE INOP

MAX CONTINUOUS THRUST

Long Range Cruise Control

| WEIGHT (1000 LB) | | PRESSURE ALTITUDE (1000 FT) | | | | | | | |
|---------------------|--------|-----------------------------|-------|-------|-------|-------|-------|-------|-------|
| | | 6 | 8 | 10 | 12 | 14 | 16 | 18 | 20 |
| 320 | EPR | 1.42 | 1.48 | | | | | | |
| | MACH | .379 | .388 | | | | | | |
| | KIAS | 225 | 222 | | | | | | |
| | FF/ENG | 16096 | 16186 | | | | | | |
| 300 | EPR | 1.39 | 1.43 | 1.50 | | | | | |
| | MACH | .371 | .381 | .390 | | | | | |
| | KIAS | 220 | 218 | 215 | | | | | |
| | FF/ENG | 14960 | 15019 | 15130 | | | | | |
| 280 | EPR | 1.35 | 1.39 | 1.44 | 1.51 | 1.60 | | | |
| | MACH | .362 | .372 | .381 | .391 | .405 | | | |
| | KIAS | 215 | 213 | 210 | 208 | 207 | | | |
| | FF/ENG | 13914 | 13887 | 13939 | 14085 | 14556 | | | |
| 260 | EPR | 1.32 | 1.36 | 1.40 | 1.44 | 1.51 | 1.61 | | |
| | MACH | .352 | .363 | .372 | .382 | .392 | .407 | | |
| | KIAS | 209 | 208 | 205 | 203 | 200 | 200 | | |
| | FF/ENG | 12889 | 12845 | 12824 | 12896 | 13012 | 13438 | | |
| 240 | EPR | 1.29 | 1.32 | 1.35 | 1.40 | 1.45 | 1.52 | 1.62 | |
| | MACH | .341 | .351 | .362 | .372 | .382 | .396 | .412 | |
| | KIAS | 202 | 201 | 200 | 197 | 195 | 194 | 194 | |
| | FF/ENG | 11880 | 11827 | 11789 | 11788 | 11798 | 12047 | 12471 | |
| 220 | EPR | 1.25 | 1.28 | 1.32 | 1.35 | 1.39 | 1.45 | 1.53 | 1.64 |
| | MACH | .328 | .339 | .350 | .361 | .371 | .385 | .400 | .416 |
| | KIAS | 195 | 194 | 193 | 191 | 189 | 189 | 189 | 189 |
| | FF/ENG | 10861 | 10825 | 10779 | 10757 | 10685 | 10819 | 11087 | 11527 |

GEAR DOWN

ENGINE INOP

MAX CONTINUOUS THRUST

**Long Range Cruise Diversion Fuel and Time
Ground to Air Miles Conversion**

| AIR DISTANCE (NM) | | | | | GROUND DISTANCE (NM) | AIR DISTANCE (NM) | | | | |
|--------------------------|------|------|------|------|----------------------|--------------------------|-----|-----|-----|-----|
| HEADWIND COMPONENT (KTS) | | | | | | TAILWIND COMPONENT (KTS) | | | | |
| 100 | 80 | 60 | 40 | 20 | 20 | 40 | 60 | 80 | 100 | |
| 166 | 147 | 131 | 119 | 109 | 100 | 94 | 89 | 84 | 79 | 75 |
| 338 | 299 | 266 | 239 | 218 | 200 | 187 | 175 | 165 | 156 | 148 |
| 512 | 452 | 400 | 360 | 328 | 300 | 280 | 262 | 246 | 233 | 221 |
| 686 | 604 | 535 | 481 | 438 | 400 | 374 | 350 | 329 | 310 | 294 |
| 862 | 758 | 670 | 602 | 547 | 500 | 467 | 437 | 410 | 387 | 367 |
| 1038 | 913 | 806 | 724 | 657 | 600 | 560 | 524 | 491 | 463 | 439 |
| 1216 | 1068 | 942 | 845 | 767 | 700 | 653 | 610 | 573 | 540 | 512 |
| 1395 | 1224 | 1079 | 967 | 877 | 800 | 746 | 697 | 654 | 616 | 584 |
| 1575 | 1381 | 1216 | 1089 | 988 | 900 | 839 | 784 | 735 | 693 | 656 |
| 1757 | 1539 | 1354 | 1211 | 1098 | 1000 | 932 | 870 | 816 | 768 | 728 |

Reference Fuel and Time Required at Check Point

| AIR DIST (NM) | PRESSURE ALTITUDE (1000 FT) | | | | | | | |
|---------------|-----------------------------|---------------|----------------|---------------|----------------|---------------|----------------|---------------|
| | 6 | | 10 | | 14 | | 18 | |
| | FUEL (1000 LB) | TIME (HR:MIN) | FUEL (1000 LB) | TIME (HR:MIN) | FUEL (1000 LB) | TIME (HR:MIN) | FUEL (1000 LB) | TIME (HR:MIN) |
| 100 | 5.6 | 0:28 | 5.1 | 0:27 | 4.7 | 0:26 | 4.3 | 0:26 |
| 200 | 11.8 | 0:53 | 11.1 | 0:52 | 10.8 | 0:50 | 10.5 | 0:48 |
| 300 | 17.9 | 1:18 | 17.0 | 1:16 | 16.7 | 1:13 | 16.5 | 1:10 |
| 400 | 23.9 | 1:44 | 22.8 | 1:41 | 22.5 | 1:37 | 22.4 | 1:32 |
| 500 | 29.8 | 2:10 | 28.5 | 2:06 | 28.2 | 2:00 | 28.2 | 1:55 |
| 600 | 35.7 | 2:36 | 34.1 | 2:30 | 33.7 | 2:24 | 33.9 | 2:17 |
| 700 | 41.4 | 3:02 | 39.7 | 2:56 | 39.2 | 2:49 | 39.4 | 2:40 |
| 800 | 47.1 | 3:29 | 45.1 | 3:21 | 44.5 | 3:13 | 44.8 | 3:03 |
| 900 | 52.8 | 3:55 | 50.5 | 3:47 | 49.7 | 3:38 | 50.0 | 3:27 |
| 1000 | 58.3 | 4:22 | 55.8 | 4:12 | 54.8 | 4:02 | 55.2 | 3:50 |

Fuel Required Adjustment (1000 LB)

| REFERENCE FUEL REQUIRED (1000 LB) | WEIGHT AT CHECK POINT (1000 LB) | | | | |
|-----------------------------------|---------------------------------|------|-----|------|------|
| | 200 | 250 | 300 | 350 | 400 |
| 5 | -1.0 | -0.5 | 0.0 | 0.7 | 1.3 |
| 10 | -2.0 | -1.0 | 0.0 | 1.5 | 2.9 |
| 15 | -3.1 | -1.6 | 0.0 | 2.3 | 4.4 |
| 20 | -4.2 | -2.1 | 0.0 | 3.1 | 6.0 |
| 25 | -5.3 | -2.7 | 0.0 | 4.0 | 7.6 |
| 30 | -6.3 | -3.2 | 0.0 | 4.8 | 9.2 |
| 35 | -7.4 | -3.7 | 0.0 | 5.7 | 10.9 |
| 40 | -8.5 | -4.3 | 0.0 | 6.5 | 12.6 |
| 45 | -9.5 | -4.8 | 0.0 | 7.4 | 14.3 |
| 50 | -10.6 | -5.3 | 0.0 | 8.3 | 16.0 |
| 55 | -11.6 | -5.8 | 0.0 | 9.2 | 17.7 |
| 60 | -12.7 | -6.4 | 0.0 | 10.1 | 19.5 |

Includes APU fuel burn.

GEAR DOWN

ENGINE INOP

MAX CONTINUOUS THRUST

**Holding
 Flaps Up**

| WEIGHT (1000 LB) | | PRESSURE ALTITUDE (FT) | | | | |
|---------------------|--------|------------------------|-------|-------|-------|-------|
| | | 1500 | 5000 | 10000 | 15000 | 20000 |
| 360 | EPR | 1.37 | | | | |
| | KIAS | 229 | | | | |
| | FF/ENG | 18020 | | | | |
| 340 | EPR | 1.34 | 1.42 | | | |
| | KIAS | 221 | 221 | | | |
| | FF/ENG | 16760 | 17100 | | | |
| 320 | EPR | 1.31 | 1.38 | | | |
| | KIAS | 215 | 215 | | | |
| | FF/ENG | 15670 | 15850 | | | |
| 300 | EPR | 1.28 | 1.34 | 1.48 | | |
| | KIAS | 210 | 210 | 210 | | |
| | FF/ENG | 14690 | 14780 | 15420 | | |
| 280 | EPR | 1.26 | 1.31 | 1.42 | | |
| | KIAS | 205 | 205 | 205 | | |
| | FF/ENG | 13730 | 13770 | 14180 | | |
| 260 | EPR | 1.23 | 1.28 | 1.38 | 1.55 | |
| | KIAS | 200 | 200 | 200 | 200 | |
| | FF/ENG | 12790 | 12790 | 13000 | 13860 | |
| 240 | EPR | 1.21 | 1.26 | 1.34 | 1.48 | |
| | KIAS | 194 | 194 | 194 | 194 | |
| | FF/ENG | 11890 | 11850 | 11960 | 12470 | |
| 220 | EPR | 1.19 | 1.23 | 1.30 | 1.42 | 1.64 |
| | KIAS | 189 | 189 | 189 | 189 | 189 |
| | FF/ENG | 11010 | 10960 | 11000 | 11250 | 12100 |

This table includes 5% additional fuel for holding in a racetrack pattern.

Intentionally
Blank

**Performance Inflight -
Text****Chapter PI
Section 27**

Introduction

This chapter contains information to supplement performance data from the Flight Management Computer (FMC). In addition, sufficient inflight data is provided to complete a flight with the FMC inoperative. In the event of conflict between data presented in this chapter and that contained in the approved Airplane Flight Manual, the Flight Manual shall always take precedence.

Takeoff Speeds

The speeds presented in the Takeoff Speeds table can be used for all performance conditions except where adjustments must be made to V1 for clearway, stopway, anti-skid inoperative, brakes deactivated, improved climb, contaminated runway situations, brake energy limits, or obstacle clearance with unbalanced V1. These speeds may be used for weights less than or equal to the performance limited weight.

Normal takeoff speeds, V1, VR, and V2, with anti-skid on and all brakes operative, are read from the table by entering with takeoff flap setting, brake release weight and appropriate column. The appropriate column is obtained by entering the Column Reference chart with the airport pressure altitude and the actual temperature or assumed temperature for reduced thrust takeoffs. Slope and wind adjustments to V1 are obtained by entering the V1 Adjustment chart. Adjusted V1 must not exceed VR. These takeoff speeds are not valid when the brake release weight is based on clearway, stopway, improved climb or is limited by tire speed or brake energy.

V1(MCG)

Regulations prohibit scheduling takeoff with a V1 less than minimum V1 for control on the ground, V1(MCG). Therefore compare the adjusted V1 to the V1(MCG). To find V1(MCG) enter the V1(MCG) table with the airport pressure altitude and actual OAT. If the adjusted V1 is less than V1(MCG), set V1 equal to V1(MCG). If VR is less than V1(MCG), set VR equal to V1(MCG), and determine a new V2 by adding the difference between the normal VR and V1(MCG) to the normal V2. No takeoff weight adjustment is necessary provided that the actual field length exceeds the minimum field length.

Clearway and Stopway V1 Adjustments

Takeoff speed adjustments are to be applied to V1 speed when using takeoff weights based on the use of clearway and stopway.

Adjust V1 speed by the amount shown in the table. The adjusted V1 speed must not exceed VR.

Maximum allowable clearway limits are provided for guidance when more precise data is not available.

Stab Trim

To find takeoff stabilizer trim setting, enter Stab Trim Setting table with anticipated brake release weight and center of gravity (C.G. % MAC) and read required stabilizer trim units.

VREF

This table contains flaps 30, 25 and 20 reference speeds for a given weight.

Flap Maneuver Speeds

This table provides the flap speed schedule for recommended maneuver speeds. Using VREF as the basis for the schedule makes it variable as a function of weight and will provide adequate maneuver margin above stall at all weights.

During flap retraction/extension, movement of the flap to the next position should be initiated when within 20 knots of the recommended speed for that position.

Slush/Standing Water Takeoff

Experience has shown that aircraft performance may deteriorate significantly on runways covered with snow, slush, standing water or ice. Therefore a reduction in runway/obstacle limited takeoff weight and revised takeoff speeds are necessary. The following information is intended for guidance in accordance with advisory material and is based on all engines operating throughout the takeoff.

The entire runway is assumed to be completely covered by a contaminant of uniform thickness and density. Therefore this information is conservative when operating under typical colder weather conditions where patches of slush exist and some degree of sanding is common. Takeoffs in slush depths greater than 0.5 inches (13 mm) are not recommended because of possible airplane damage as a result of slush impingement on the airplane structure. The use of assumed temperature for reduced thrust is not allowed on contaminated runways. Interpolation for slush/standing water depths between the values shown is permitted.

Takeoff weight is determined as follows:

1. Determine the field/obstacle limit weight for the takeoff flap setting.
2. Enter the Weight Adjustment table with the field/obstacle limit weight to obtain the weight reduction for the slush/standing water depth and airport pressure altitude.
3. Determine takeoff speeds VR and V2 for the actual brake release weight from the Takeoff Speeds chart.

Interpolate for intermediate slush depths as required using the dry runway conditions as zero slush depth.

Anti-Skid Inoperative

When operating with anti-skid inoperative, the field limit weight and V1 must be reduced to account for the effect on accelerate-stop performance. A simplified method which conservatively accounts for the effects of anti-skid inoperative is to reduce the normal runway/obstacle limited weight and the V1 associated with the reduced weight by the amount shown in the table below.

| ANTI-SKID INOPERATIVE ADJUSTMENT | | |
|----------------------------------|------------------|---------------------|
| FIELD LENGTH (FT) | WEIGHT (1000 LB) | V1 ADJUSTMENT (KTS) |
| 8000 | -131.6 | -40 |
| 8100 | -131.6 | -40 |
| 8900 | -98.3 | -38 |
| 10000 | -71.0 | -35 |
| 12000 | -53.6 | -31 |
| 14000 | -53.6 | -27 |

If the resulting V1 is less than V1(MCG), takeoff is permitted with V1 set equal to V1(MCG) provided the accelerate-stop distance adjusted for wind and slope exceeds approximately 8100 ft.

Detailed analysis for the specific case from the Airplane Flight Manual may yield a less restrictive penalty.

Brakes Deactivated

When operating with brakes deactivated, the field and brake energy limit weights and the V1 and VMBE must be reduced to allow for reduced braking capability. A simplified method which conservatively accounts for

the reduced braking capability of one brake deactivated is to reduce the normal runway/obstacle limited weight by 6400 lb and the V1 associated with the reduced weight by the amount shown in the table below.

| ONE BRAKE DEACTIVATED SPEED ADJUSTMENT | |
|--|---------------------|
| FIELD LENGTH (FT) | V1 ADJUSTMENT (KTS) |
| 4000 | -4 |
| 6000 | -3 |
| 8000 | -3 |
| 10000 | -2 |
| 12000 | -2 |
| 14000 | -2 |

If the resulting V1 is less than V1(MCG), takeoff is permitted with V1 set equal to V1(MCG) provided the accelerate-stop distance exceeds approximately 3800 ft for one brake deactivated.

Assumed Temperature Reduced Thrust

Regulations permit the use of up to 25% takeoff thrust reduction for operation with assumed temperature reduced thrust. Use of reduced thrust is not allowed on runways contaminated with water, ice, slush or snow. Use of assumed temperature reduced thrust is not recommended if potential windshear conditions exist. The assumed temperature reduced takeoff EPR is read from the Takeoff EPR table at the assumed temperature. The minimum allowable EPR for reduced thrust, based on 25% takeoff thrust reduction, is also shown. It is not recommended to set takeoff EPR lower than the scheduled climb EPR.

Max Climb EPR

This table shows Max Climb EPR for a 250/290/.78 climb speed schedule, normal engine bleed for packs on and anti-ice off. Enter the table with airport pressure altitude and TAT and read EPR. EPR adjustments are shown for packs off and anti-ice operation.

Go-around EPR

To find Max Go-around EPR based on normal engine bleed for packs on, enter the Go-around EPR table with airport pressure altitude and reported OAT or TAT and read EPR. EPR adjustments are shown for packs off and wing anti-ice on.

Flight with Unreliable Airspeed / Turbulent Air Penetration

Pitch attitude and average EPR information is provided for use in all phases of flight in the event of unreliable airspeed/Mach indications resulting from blocking or freezing of the pitot system. Loss of radome or turbulent air may also cause unreliable airspeed/Mach indications. The cruise table in this section may also be used for turbulent air penetration.

Pitch attitude is shown in bold type for emphasis since altitude and/or vertical speed indications may also be unreliable.

All Engines

Long Range Cruise Maximum Operating Altitude

These tables provide the maximum operating altitude in the same manner as the FMC. Maximum altitudes are shown for a given cruise weight and maneuver capability. Note that these tables consider both thrust and buffet limits, providing the more limiting of the two. Any data that is thrust limited is denoted by an asterisk and represents only a thrust limited condition in level flight with maximum cruise thrust at 0 ft/min residual rate of climb or maximum climb thrust at 100 ft/min residual rate of climb. Flying above these altitudes with sustained banks in excess of approximately 12° may cause the airplane to lose speed and/or altitude.

Note that optimum altitudes shown in the tables result in buffet related maneuver margins of 1.5g (48° bank) or more. The altitudes shown in the table are limited to the maximum certified altitude of 43100 ft.

Long Range Cruise Control

These tables provide target EPR, Long Range Cruise Mach number, IAS and standard day fuel flow per engine for the airplane weight and pressure altitude. As indicated by the shaded area, at optimum altitude .80M approximates the Long Range Cruise Mach schedule.

APU Operation During Flight

For APU operation during flight, increase fuel flow according to the table in the Engine Inoperative text section.

Long Range Cruise Enroute Fuel and Time

Long Range Cruise Enroute Fuel and Time tables are provided to determine remaining time and fuel required to destination. The data is based on Long Range Cruise and .78/290/250 descent. Tables are presented for low altitudes and high altitudes.

To determine remaining fuel and time required, first enter the Ground to Air Miles Conversion table to convert ground distance and enroute wind to an equivalent still air distance for use with the Reference Fuel and Time tables. Next, enter the Reference Fuel and Time table with air distance from the Ground to Air Miles Conversion table and the desired altitude and read Reference Fuel and Time Required. Lastly, enter the Fuel Required Adjustment Table with the Reference Fuel and the actual weight at checkpoint to obtain fuel required to destination.

Long Range Cruise Wind-Altitude Trade

Wind is a factor which may justify operations considerably below optimum altitude. For example, a favorable wind component may have an effect on ground speed which more than compensates for the loss in air range.

Using this table, it is possible to determine the break-even wind (advantage necessary or disadvantage that can be tolerated) to maintain the same range at another altitude and long range cruise speed. The table makes no allowance for climb or descent time, fuel or distance, and are based on comparing ground fuel mileage.

Descent

Distance and time for descent are shown for a .78/290/250 descent speed schedule. Enter the table with top of descent pressure altitude and read distance in nautical miles and time in minutes. Data is based on flight idle thrust descent in zero wind. Allowances are included for a straight-in approach with gear down and landing flaps at the outer marker.

Holding

Target EPR, indicated airspeed and fuel flow per engine information is tabulated for holding with flaps up based on the FMC optimum holding speed schedule. This is the higher of the maximum endurance speed and the maneuvering speed. Small variations in airspeed will not appreciably affect the overall endurance time. Enter the table with weight and pressure altitude to read EPR, IAS and fuel flow per engine.

Advisory Information

Normal Configuration Landing Distance

Tables are provided as advisory information for normal configuration landing distances on dry runways and slippery runways with good, medium, and poor reported braking action. These values are actual landing distances and do not include the 1.67 regulatory factor. Therefore, they cannot be used to determine the dispatch required landing field length.

To use these tables, determine the reference landing distance for the selected braking configuration. Then adjust the reference distance for landing weight, altitude, wind, slope, temperature, approach speed, and the number of operative thrust reversers to obtain the actual landing distance.

When landing on slippery runways or runways contaminated with ice, snow, slush, or standing water, the reported braking action must be considered. If the surface is affected by water, snow, or ice, and the braking action is reported as "good", conditions should not be expected to

be as good as on clean, dry runways. The value "good" is comparative and is intended to mean that airplanes should not experience braking or directional control difficulties when landing. The performance level used to calculate the "good" data is consistent with wet runway testing done on early Boeing jets. The performance level used to calculate "poor" data reflects runways covered with wet ice.

Use of the autobrake system commands the airplane to a constant deceleration rate. In some conditions, such as a runway with "poor" braking action, the airplane may not be able to achieve these deceleration rates. In these cases, runway slope and inoperative reversers influence the stopping distance. Since it cannot be determined quickly when this becomes a factor, it is appropriate to add the effects of slope and inoperative reversers when using the autobrake system.

Non-normal Configuration Landing Distance

Advisory information is provided to support non-normal configurations that affect the landing performance of the airplane. Landing distances and adjustments are provided for dry runways and runways with good, medium, and poor reported braking action.

Enter the table with the applicable non-normal configuration and read the normal approach speed. The reference landing distance is a reference distance from 50 ft above the threshold to stop based on a reference landing weight and speed at sea level, zero wind, and zero slope. Subsequent columns provide adjustments for off-reference landing weight, altitude, wind, slope, temperature, and speed conditions as well as thrust reverser configuration. Each adjustment is independently added to the reference landing distance. Landing distance includes the effects of max manual braking and reverse thrust.

Recommended Brake Cooling Schedule

Advisory information is provided to assist in avoiding the problems associated with hot brakes. For normal operation, most landings are at weights below the AFM quick turnaround limit weight.

Use of the recommended cooling schedule will help avoid brake overheat and fuse plug problems that could result from repeated landing at short time intervals or a rejected takeoff.

Enter the Recommended Brake Cooling Schedule table with the airplane weight, the brakes on speed adjusted for wind and the appropriate temperature and altitude condition. Instructions for applying wind adjustments are included below the table. Linear interpolation may be used

to obtain intermediate values. The resulting number is the reference brake energy per brake in millions of foot-pounds, and represents the amount of energy absorbed by each brake during a rejected takeoff.

To determine the energy per brake absorbed during landing, enter the appropriate Adjusted Brake Energy Per Brake table (No Reverse Thrust or 2 Engine Reverse Thrust) with the reference brake energy per brake and the type of braking used during landing (Max Manual, Max Auto, or Autobrake). The resulting number is the adjusted brake energy per brake and represents the energy absorbed in each brake during the landing.

The recommended cooling time is found in the final table by entering with the adjusted brake energy per brake or brake temperature monitor system (BTMS) indication on EICAS. Times are provided for ground cooling and inflight gear down cooling.

If brake temperature monitor indication on EICAS is available, the hottest brake indication 10 to 15 minutes after the airplane has come to a complete stop, or inflight with gear retracted, may be used to determine the recommended cooling schedule by entering at the bottom of the chart. The brake temperature light illuminates when the hottest brake is registering 5 on the EICAS indication and extinguishes as the hottest brake cools with an EICAS indication of 4.

Engine Inoperative

Initial Max Continuous EPR

The Initial Max Continuous EPR setting for use following an engine failure is shown. The table shows a range of Cruise Mach numbers to provide a target EPR setting at the start of driftdown. Also shown is the maximum TAT at which the limit EPR can be set. Once driftdown is established, the Max Continuous EPR table should be used to determine EPR for the given conditions.

Max Continuous EPR

Power setting is based on one engine operating with one A/C pack operating and all anti-ice bleeds off. Enter the table with pressure altitude and IAS or Mach to read EPR.

It is desirable to maintain engine thrust level within the limits of the Max Cruise Thrust rating. However, where thrust level in excess of Max Cruise rating is required, such as for meeting terrain clearance, ATC altitude assignments, or to attain maximum range capability, it is permissible to use the thrust needed up to the Max Continuous Thrust rating. The Max

Continuous Thrust rating is intended primarily for emergency use at the discretion of the pilot and is the maximum thrust that may be used continuously.

Driftdown Speed/Level Off Altitude

The table shows optimum driftdown speed as a function of cruise weight at start of driftdown. Also shown are the approximate weight and pressure altitude at which the airplane will level off considering 100 ft/min residual rate of climb.

The level off altitude is dependent on air temperature (ISA deviation).

Driftdown/LRC Range Capability

This table shows the range capability from the start of driftdown. Driftdown is continued to level off altitude. As weight decreases due to fuel burn, the airplane is accelerated to Long Range Cruise speed. The cruise segment is at a level off altitude which is based on 100 ft/min residual rate of climb.

To determine fuel required, enter the Ground to Air Miles Conversion table with the desired ground distance and adjust for anticipated winds to obtain air distance to destination. Then enter the Driftdown/Cruise Fuel and Time table with air distance and weight at start of driftdown to determine fuel and time required. If altitudes other than the level off altitude are used, fuel and time required may be obtained by using the Engine Inoperative Long Range Cruise Enroute Fuel and Time table.

Long Range Cruise Altitude Capability

The table shows the maximum altitude that can be maintained at a given weight and air temperature (ISA deviation), based on Long Range Cruise speed, Max Continuous thrust, and 100 ft/min residual rate of climb.

Long Range Cruise Control

The table provides target EPR, engine inoperative Long Range Cruise Mach number, IAS and fuel flow for the airplane weight and pressure altitude. The fuel flow values in this table reflect single engine fuel burn.

APU Operation During Flight

For APU operation during flight, increase fuel flow according to the following table. These increments include the APU fuel flow and the effect of increased drag from the APU door.

| PRESSURE ALTITUDE (1000 FT) | APU FUEL FLOW PENALTY (LB/HR) | | | | | |
|-----------------------------------|-------------------------------|-----|-----|-----|-----|-----|
| | GROSS WEIGHT (1000 LB) | | | | | |
| | 420 | 380 | 340 | 300 | 260 | 220 |
| 43 | | | | | 135 | 125 |
| 39 | | | | 140 | 135 | 130 |
| 35 | | 160 | 155 | 150 | 145 | 140 |
| 31 | 170 | 165 | 165 | 160 | 155 | 150 |
| 27 | 185 | 180 | 175 | 170 | 165 | 155 |
| 25 | 190 | 185 | 180 | 180 | 165 | 160 |
| 20 | 205 | 200 | 195 | 185 | 175 | 170 |
| 15 | 235 | 225 | 215 | 205 | 200 | 195 |
| 10 | 255 | 250 | 240 | 230 | 225 | 215 |
| 5 | 275 | 275 | 260 | 255 | 250 | 245 |

Long Range Cruise Diversion Fuel and Time

Tables are provided for crews to determine the fuel and time required to proceed to an alternate airfield with one engine inoperative. The data is based on single engine Long Range Cruise speed and .78/290/250 descent. Enter with Air Distance as determined from the Ground to Air Miles Conversion table and read Fuel and Time required at the cruise pressure altitude. Adjust the fuel obtained for deviation from the reference weight at checkpoint as required by entering the Fuel Required Adjustment table with the fuel required for the reference weight and the actual weight at checkpoint. Read fuel and time required for the actual weight.

Holding

Single engine holding data is provided in the same format as the all engine holding data and is based on the same assumptions.

Alternate EEC Mode

Introduction

This section contains performance data for airplane operation using with the Electronic Engine Controls (EEC) in the ALTERNATE Mode. The data includes engine bleed effects for normal air conditioning operation; i.e., two packs on at normal flow all engines operating, and one pack on at normal flow with engine inoperative.

Takeoff thrust setting with EEC's in ALTERNATE Mode is achieved by advancing both throttles together and setting the target EPR on the engine with EPR available. During takeoff roll, minor adjustments to the non-EPR engine throttle may be made prior to 80 kts to match %N1 to the %N1 on the engine set to EPR.

Takeoff Performance

A simplified method which conservatively accounts for the effects of EEC in the ALTERNATE Mode is to reduce the normal limit weights. The Takeoff Performance table provides takeoff field, climb and obstacle limit weight adjustments. To determine limit weight for operations enter the table with airport OAT and apply the weight reduction to the normal full rate limit weight. The most limiting of the takeoff weights must be used.

Improved climb performance procedure and reduced thrust operation using assumed temperature method is not permitted. Derate 1 and Derate 2 operation is not permitted. Use of autothrottle is not permitted.

Takeoff Speeds

Takeoff speeds for the reduced weights should be adjusted by the amount shown in the Takeoff Speeds table. The adjusted V1 should not exceed the adjusted VR.

NOTE: The FMC does not incorporate Alternate EEC Mode performance in its takeoff speeds calculations.

Landing Performance

The Landing Performance table provides the weight adjustment that must be applied to the Approach/Landing Climb limit weight. Enter the table with airport OAT and apply the weight reduction to the normal full rate limit weight. The ALTERNATE Mode EEC Approach/Landing Climb limit must be compared to the Landing Field Length limit and the most limiting of the two be used as the landing limit weight.

Takeoff EPR/Go-around EPR/Go-around %N1

Takeoff and Go-around power setting are presented for normal air conditioning bleed. Max Takeoff or Go-around EPR may be read directly from the tables for the desired pressure altitude and airport OAT. Go-around %N1 is provided in the event that EPR becomes unavailable during the flight.

Thrust protection is not provided in the Alternate EEC Mode and maximum rated thrust is reached at a thrust lever position less than full forward. As a result, thrust overboost can occur at full forward thrust lever positions.

Alternate EEC Mode, Engine Inoperative

Initial Max Continuous %N1

The Initial Max Continuous %N1 setting, with normal engine bleed for packs on and anti-ice off, following engine failure in cruise is shown for a range of altitudes and TAT.

Max Continuous %N1

Max Continuous %N1 which can be set during engine out cruise conditions is presented. Enter the appropriate table with pressure altitude, TAT, and KIAS to obtain Maximum Continuous %N1. Intermediate airspeeds may be interpolated. Appropriate bleed adjustments are shown.

Gear Down

This section contains performance for airplane operation with the landing gear extended for all phases of flight. The data is based on engine bleeds for normal air conditioning.

NOTE: The Flight Management Computer System (FMCS) does not contain special provisions for operation with landing gear extended. As a result, the FMCS will generate inaccurate enroute speed schedules, display non-conservative predictions of fuel burn, estimated time of arrival (ETA), maximum altitude, and compute overly shallow descent path. To obtain accurate ETA predictions, gear down cruise speed and altitude should be entered on the CLB and CRZ pages. Gear down cruise speed should also be entered on the DES page and a STEP SIZE of zero should be entered on the PERF INIT or CRZ page. Use of the VNAV during descent under these circumstances is not recommended.

Tables for gear down performance in this section are identical in format and used in the same manner as tables for the gear up configuration previously described.

**Airplane General, Emergency
Equipment, Doors, Windows**

Chapter 1

Table of Contents

Section 0

Dimensions 1.10

Principal Dimensions 1.10.1

Turning Radius 1.10.3

Instrument Panels. 1.20

Flight Deck Panels 1.20.1

Left Overhead Panel 1.20.2

Right Overhead Panel 1.20.3

Instrument Panels. 1.21

Left Forward Panel 1.21.1

Right Forward Panel 1.21.2

Glareshield Panel 1.21.3

Center Forward Panel 1.21.4

Forward Aisle Stand 1.21.5

Instrument Panels. 1.22

Control Stand 1.22.1

Aft Aisle Stand. 1.22.2

Right Sidewall, Accessory Panel 1.22.3

Left, Right Sidewall, and Observer Panels 1.22.4

Controls and Indicators 1.30

Push-Button Switches 1.30.1

 Alternate Action Switches 1.30.1

 Momentary Action Switches 1.30.2

Passenger Cabin Signs 1.30.2

 Passenger Sign Selectors 1.30.2

Lighting 1.30.3

 Flight Deck Lighting 1.30.3

 Exterior Lighting 1.30.7

| | |
|--|-------------|
| Emergency Lighting Controls | 1.30.9 |
| Doors and Windows | 1.30.10 |
| Exterior Door Annunciator Lights | 1.30.10 |
| Exterior Door Locations | 1.30.11 |
| Passenger Entry Doors | 1.30.13 |
| Passenger Door Control and Mode Select Panel | 1.30.14 |
| Interior Entry Door Electric Assist Controls | 1.30.15 |
| Exterior Entry Door Controls | 1.30.16 |
| Overwing Emergency Exit Doors | 1.30.17 |
| Emergency Doors | 1.30.18 |
| Flight Deck Security Door | 1.30.19 |
| Flight Deck Number Two Window | 1.30.22 |
| Oxygen Systems | 1.30.23 |
| Oxygen Indications | 1.30.23 |
| Passenger Oxygen Switch | 1.30.23 |
| Oxygen Mask Panel | 1.30.24 |
| Oxygen Mask and Regulator | 1.30.26 |
| Emergency Evacuation Panel | 1.30.27 |
| Systems Description | 1.40 |
| Introduction | 1.40.1 |
| Lighting Systems | 1.40.1 |
| Exterior Lighting | 1.40.1 |
| Exterior Lighting Locations | 1.40.2 |
| Flight Deck Lighting | 1.40.3 |
| Indicator Lights | 1.40.3 |
| Passenger Cabin Signs | 1.40.3 |
| Emergency Lighting | 1.40.4 |
| Oxygen Systems | 1.40.5 |
| Flight Crew Oxygen System | 1.40.5 |
| Passenger Oxygen System | 1.40.5 |
| Portable Oxygen Bottles | 1.40.5 |
| Doors and Windows | 1.40.5 |
| Flight Deck Security Door | 1.40.6 |

| | |
|---|-------------|
| Flight Deck Number Two Windows | 1.40.7 |
| Passenger Entry Doors | 1.40.8 |
| Passenger Entry Door and Slide Operation | 1.40.9 |
| Escape Slide/Raft Deployed | 1.40.10 |
| Emergency Doors | 1.40.10 |
| Overwing Emergency Exit Doors. | 1.40.11 |
| Evacuation Slides | 1.40.13 |
| Cargo Doors | 1.40.14 |
| Flight Deck Seats | 1.40.14 |
| Pilot Seat Adjustment | 1.40.15 |
| Emergency Equipment. | 1.45 |
| Introduction | 1.45.1 |
| Emergency Equipment. | 1.45.1 |
| Fire Extinguishers. | 1.45.1 |
| Miscellaneous Emergency Equipment | 1.45.2 |
| Emergency Evacuation Signal System. | 1.45.2 |
| Emergency Equipment Symbols | 1.45.3 |
| Emergency Equipment Locations | 1.45.4 |
| EICAS Messages. | 1.50 |
| Airplane General, Emergency Equipment, Doors, Windows EICAS Messages | 1.50.1 |
| Access Doors | 1.50.1 |
| Cargo Doors | 1.50.1 |
| Entry Doors. | 1.50.2 |
| Emergency Exit Doors | 1.50.2 |
| Overwing Emergency Exit Doors. | 1.50.2 |
| Emergency Lights. | 1.50.3 |
| Oxygen System. | 1.50.3 |

Intentionally
Blank

Principal Dimensions

767-300 Passenger with 4 entry doors and 4 overwing emergency doors.

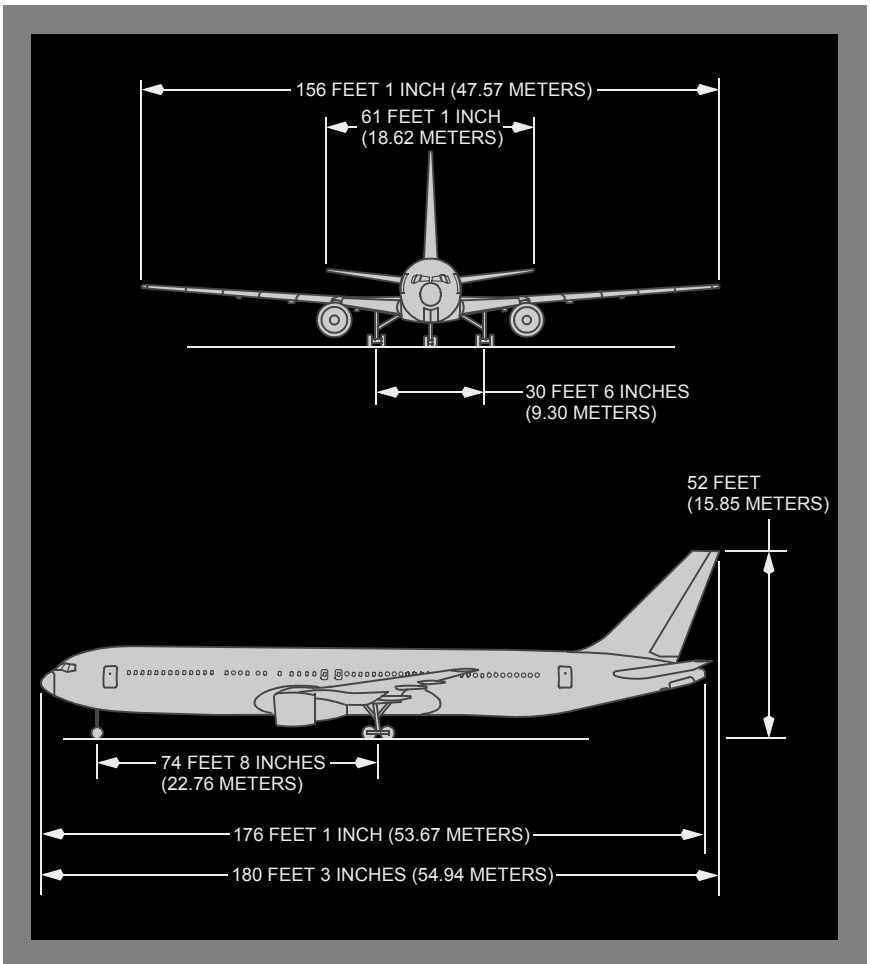

767-300 Passenger with 6 entry doors and 2 emergency doors.

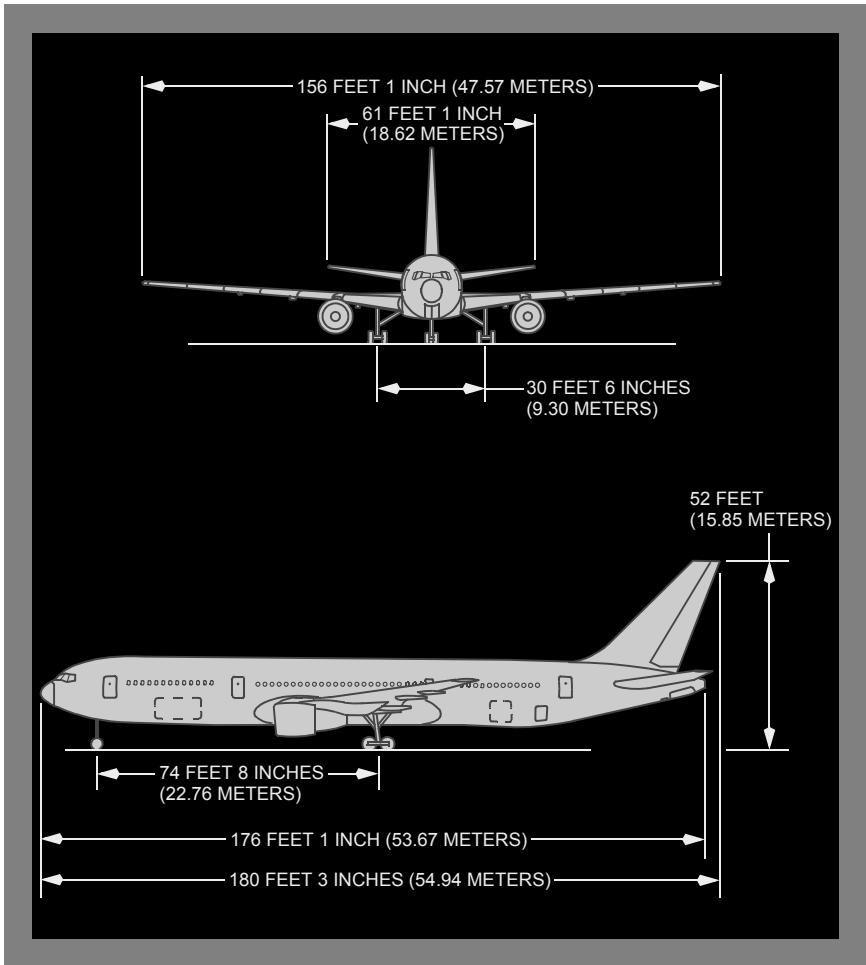

Turning Radius

The wing tip swings the largest arc while turning and determines the minimum obstruction clearance path. All other portions of the airplane structure remain within this arc.

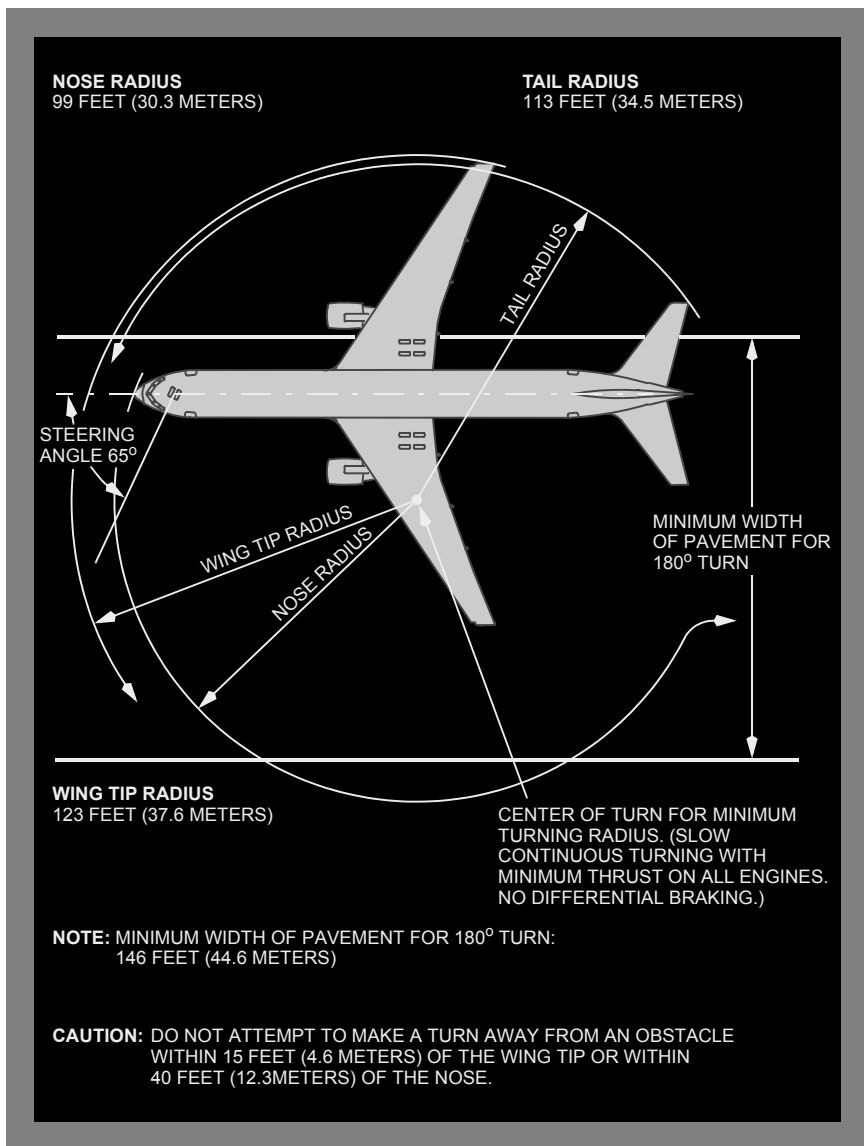

Intentionally
Blank

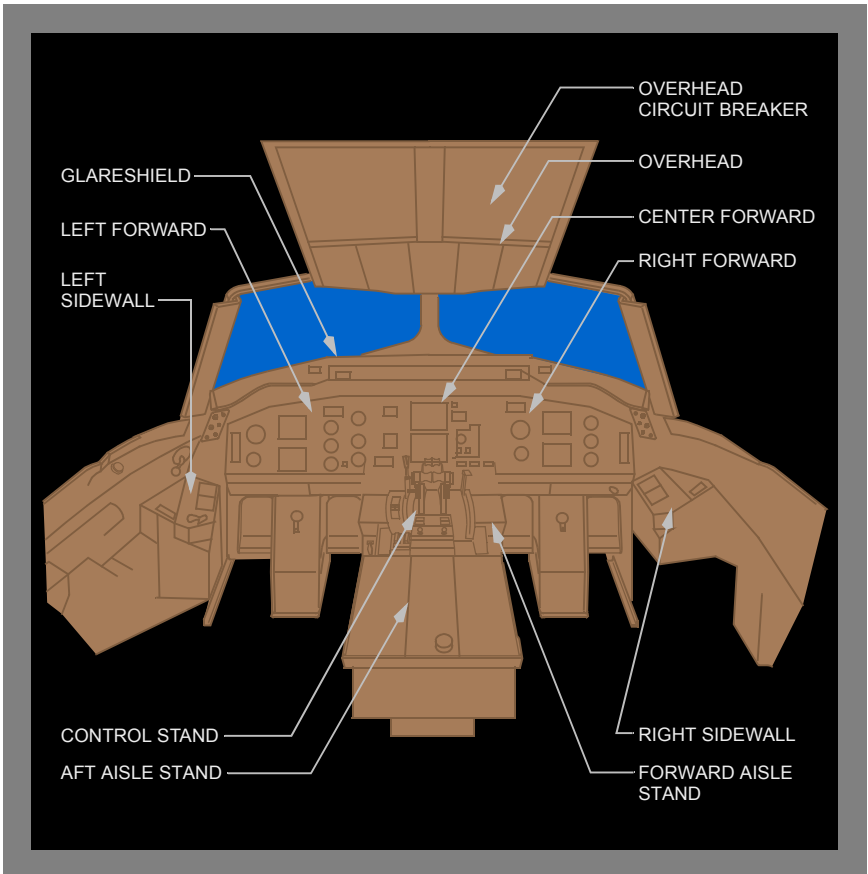
Flight Deck Panels

On the following pages, circled numbers refer to chapters where information on the item may be found.

The panels, controls, and indicators shown in this chapter are representative of installed units and may not exactly match the latest configuration. Refer to the appropriate chapter system descriptions for current information.

Left Overhead Panel

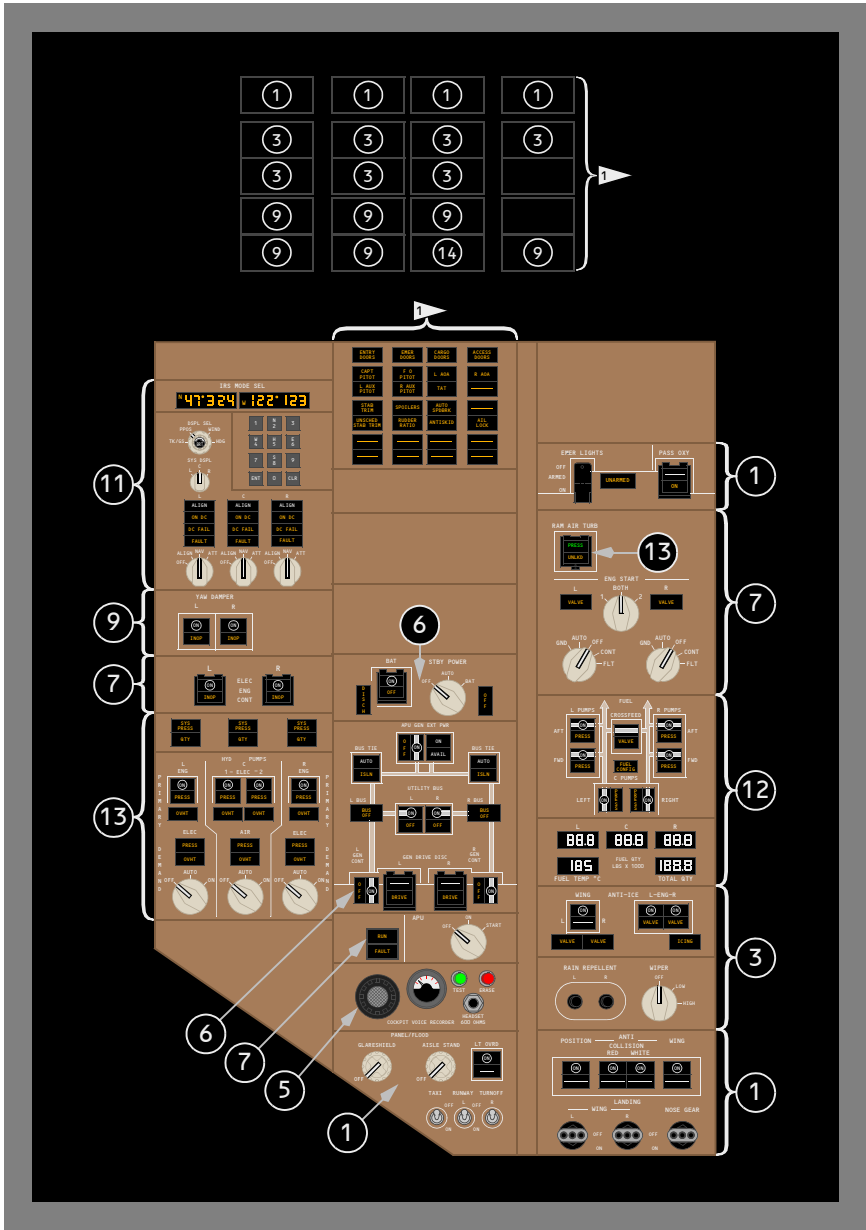

Right Overhead Panel

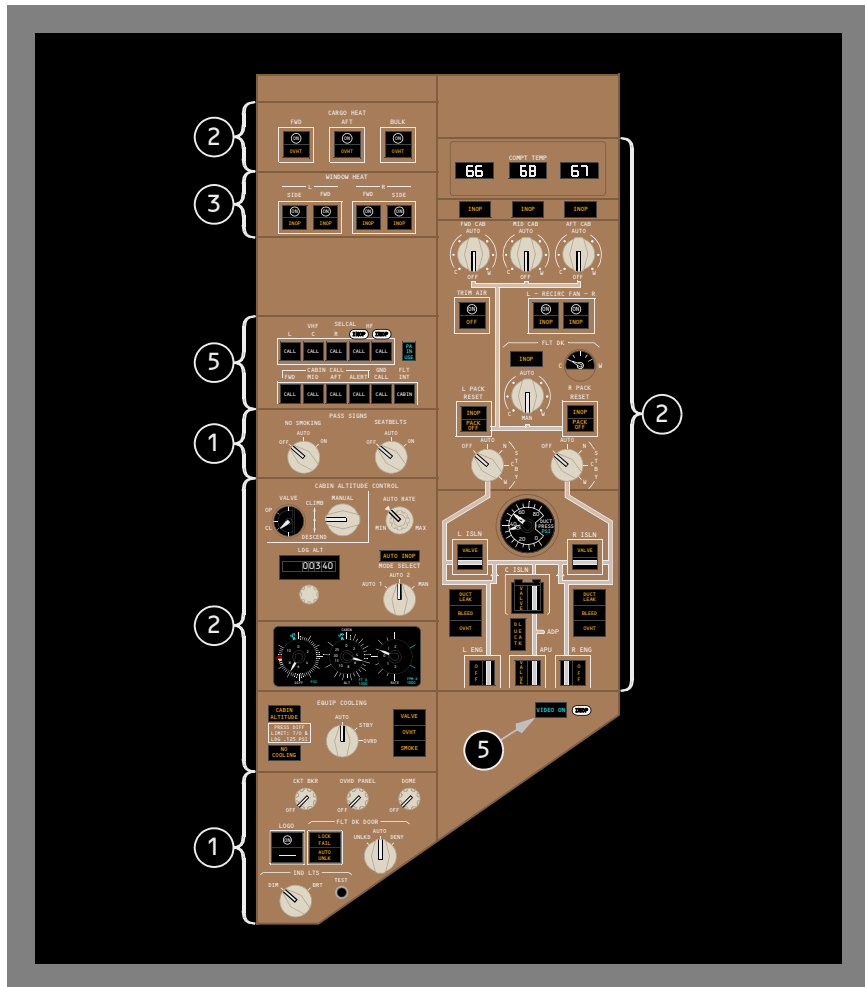

Intentionally
Blank

DO NOT USE FOR FLIGHT

767 Flight Crew Operations Manual

**Airplane General, Emergency
Equipment, Doors, Windows
Instrument Panels**

Chapter 1

Section 21

Left Forward Panel

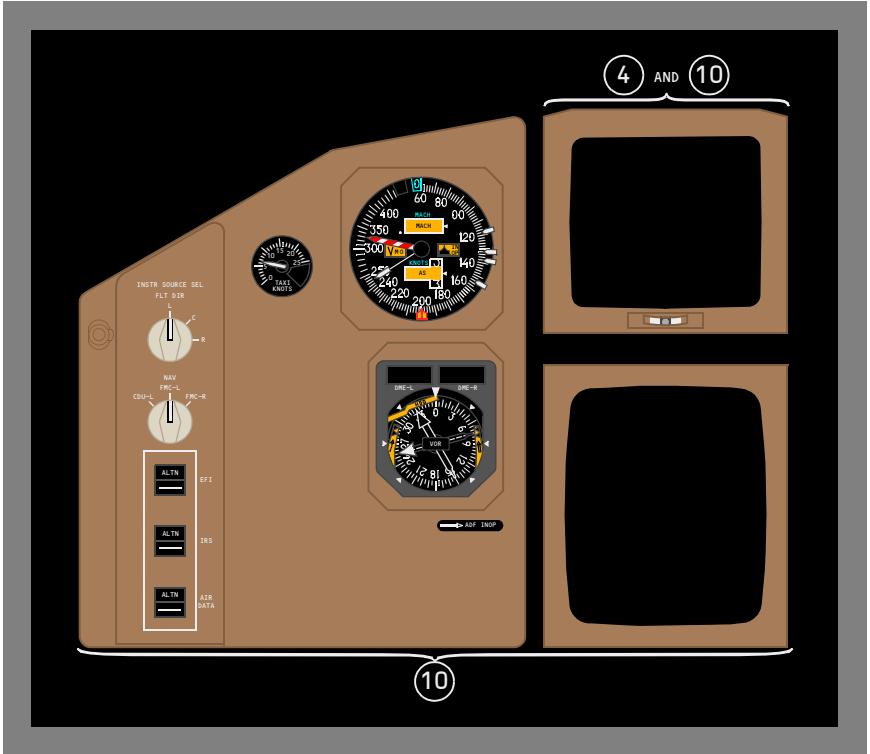

Right Forward Panel

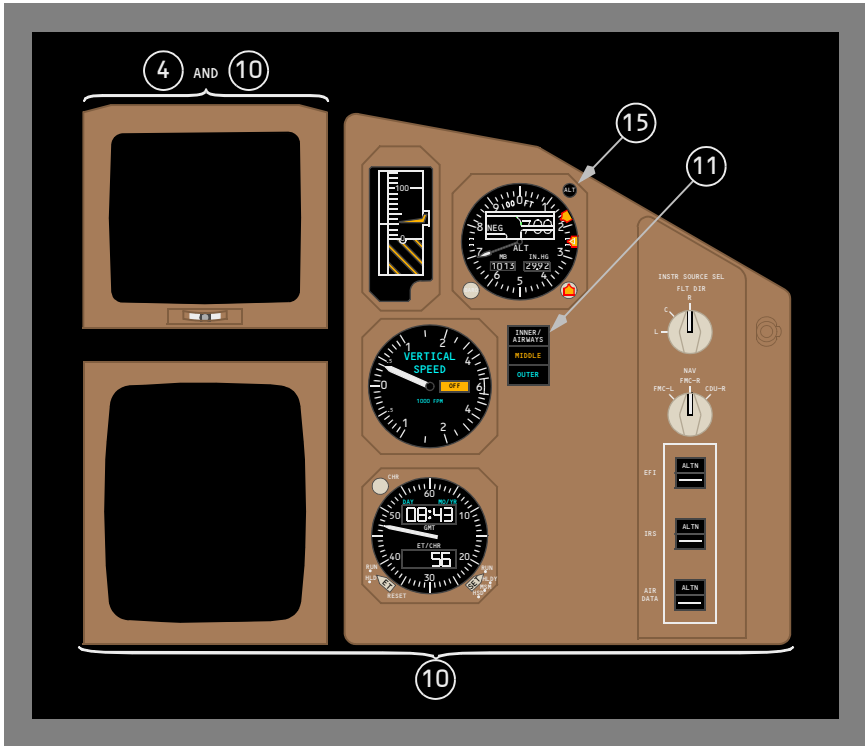

Glareshield Panel

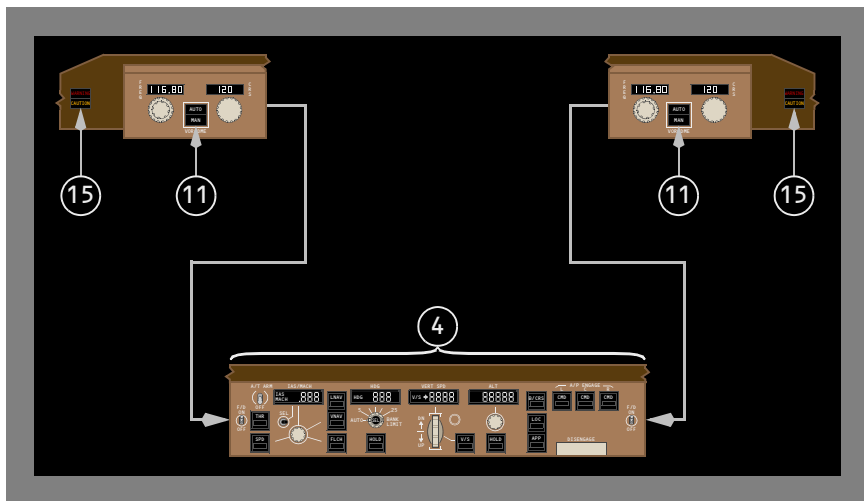

Center Forward Panel

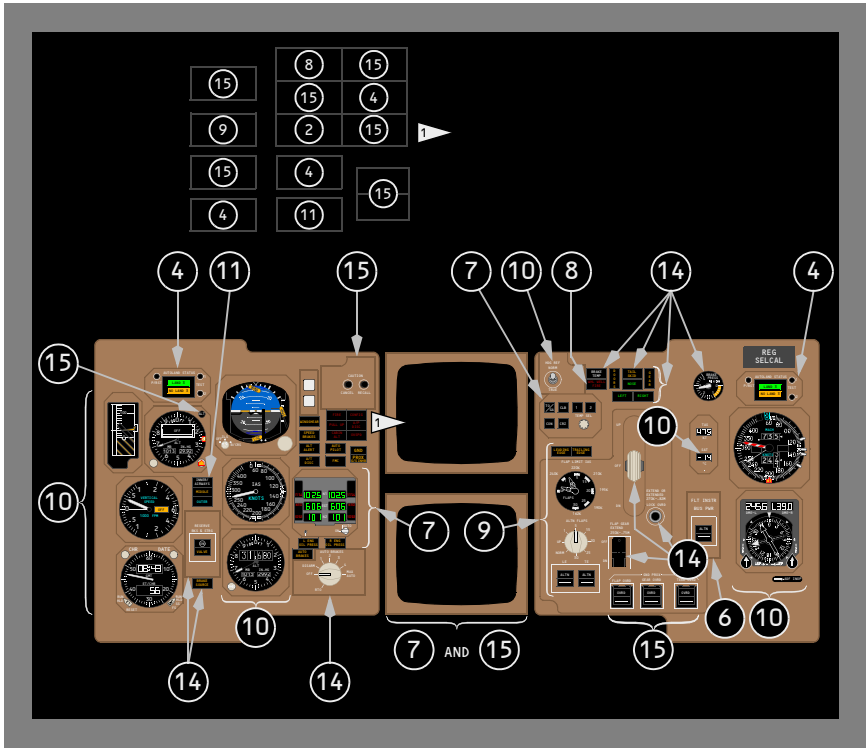

Forward Aisle Stand

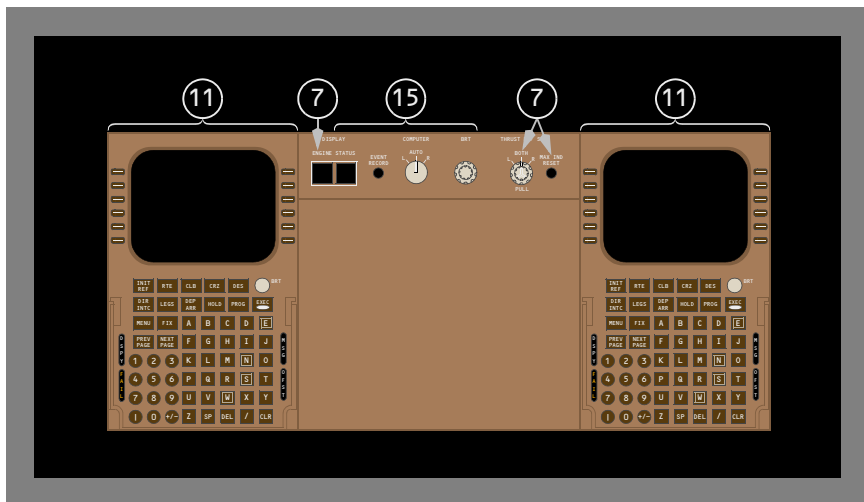

Intentionally
Blank

Control Stand

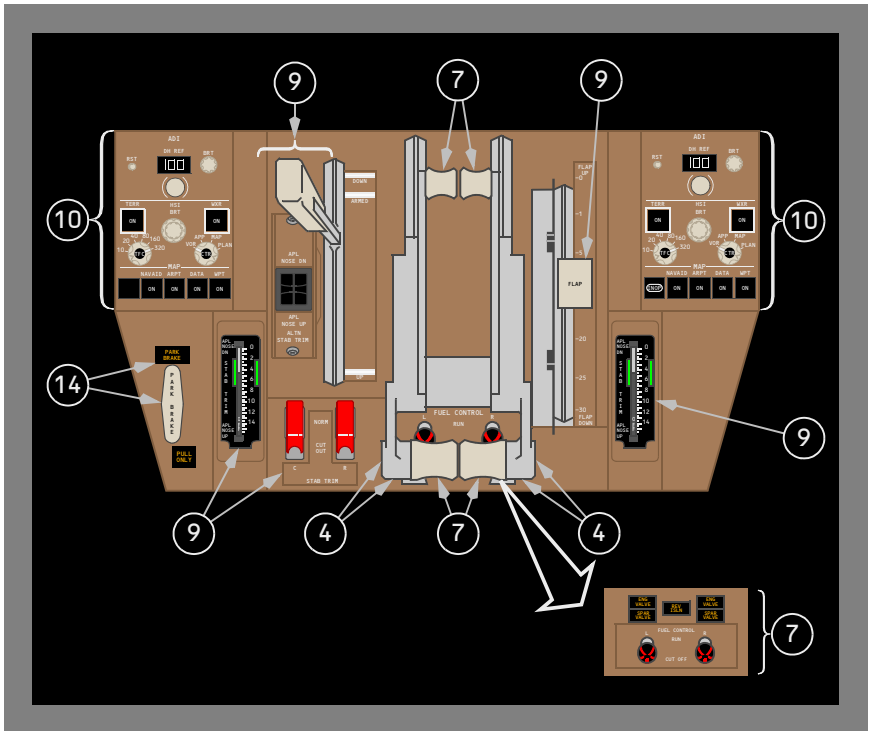

Aft Aisle Stand

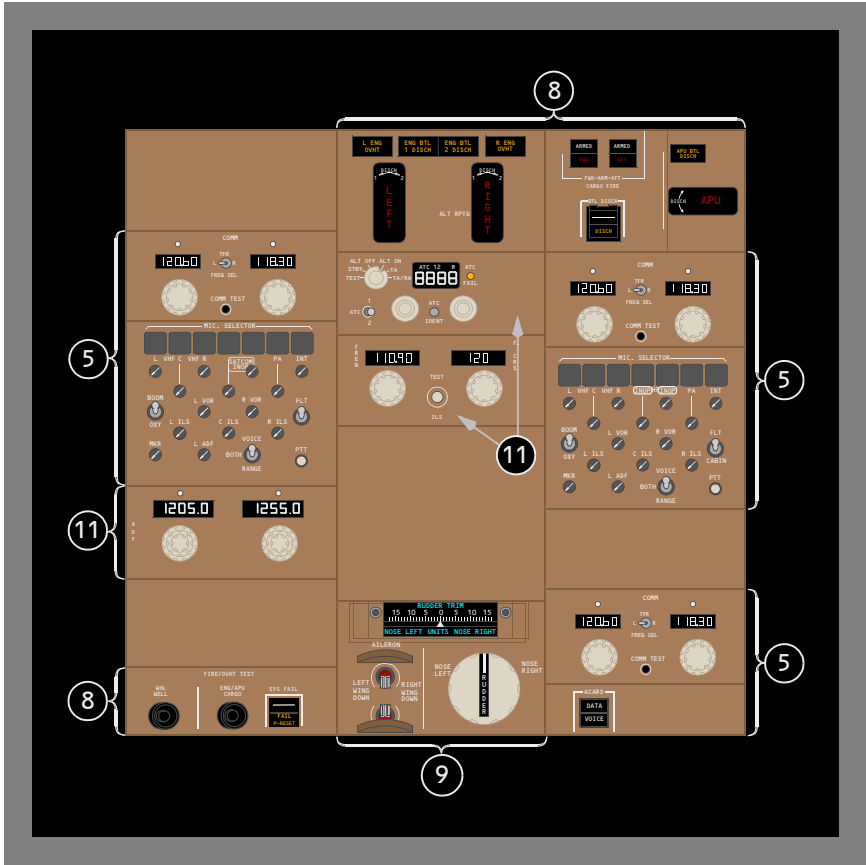

Left, Right Sidewall, and Observer Panels

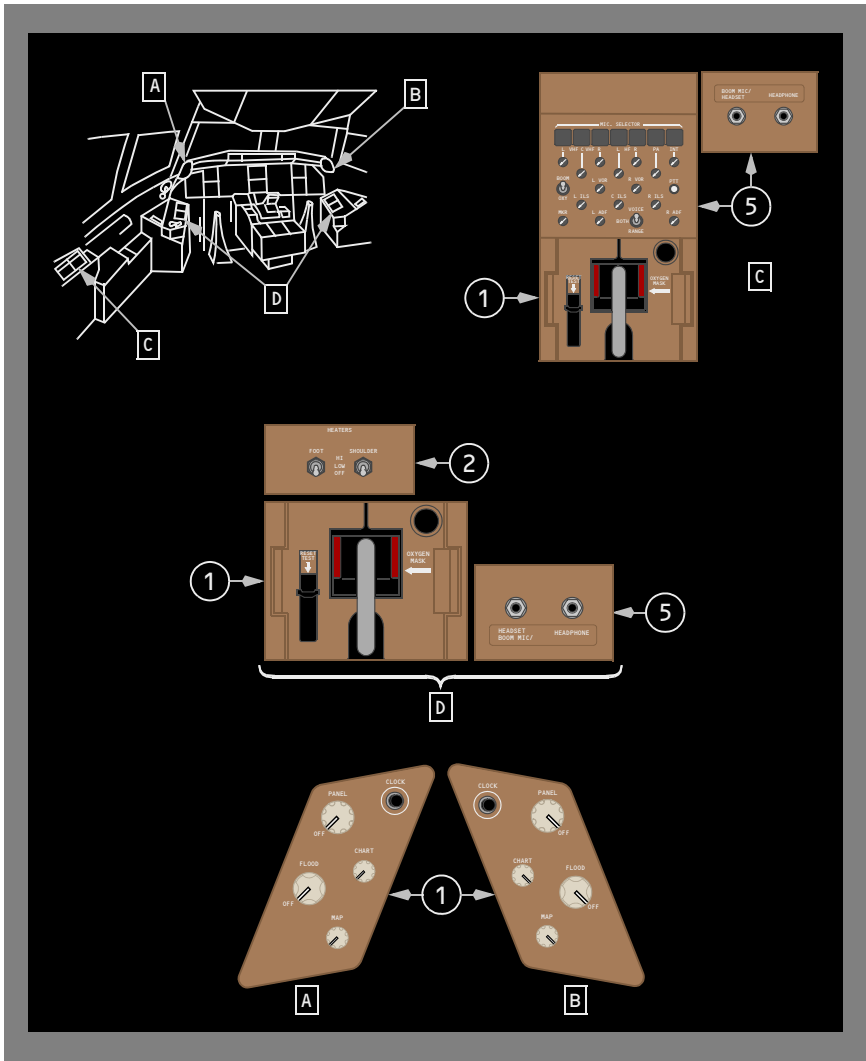

Push–Button Switches

The airplane has two types of push–button switches: alternate action and momentary action. The switch may contain an indicator light that illuminates to indicate system status or faults. A line indicates there is no label for that portion of the switch.

Note: Maintenance personnel should be contacted for all relamping operations. Unintentional system operation can result from improper relamping.

Alternate Action Switches

Alternate action switches have two positions: on and off.

When pushed in and flush with the panel, the switch is on. The switch indicates the system is on by displaying a word or flow bar.

When pushed out and extended, the switch is off. The switch indicates the system is off by not displaying a word or not displaying the flow bar.

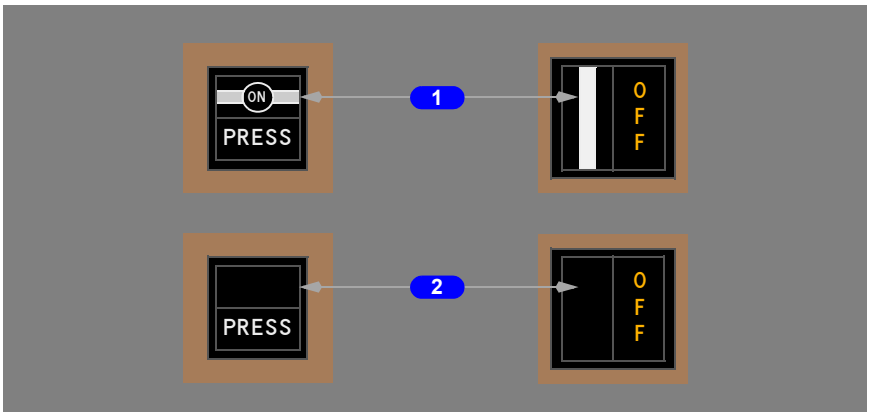

1 Switch is ON

A mechanical shutter opens and a word, symbol or combination is visible. For some switches, system status may be shown in half of the switch.

2 Switch is OFF

A mechanical shutter closes and the ON indication is not visible.

Momentary Action Switches

Momentary action switches are spring loaded to the extended position. They are used to activate or deactivate systems or to reset system logic. The switch display indicates system status.

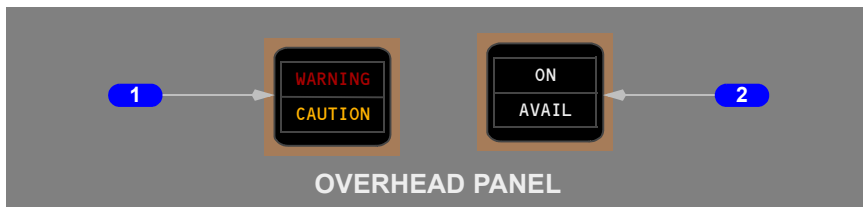

1 Push to Reset

Push – the switch resets the master lights and aural alerts.

2 System Operation

Push – activates or deactivates the system.

Passenger Cabin Signs

Passenger Sign Selectors



1 NO SMOKING Selector

OFF – the no smoking signs are extinguished.

AUTO – the no smoking signs illuminate or extinguish with reference to landing gear position (refer to Lighting System Description section).

ON – the no smoking signs illuminate.

2 SEAT BELTS Selector

OFF – the fasten seat belts and return to seats signs are extinguished.

AUTO – the fasten seat belts and return to seats signs illuminate or extinguish with reference to landing gear or flap position (refer to Lighting System Description section).

ON –the fasten seat belts and return to seats signs illuminate.

Note: Anytime passenger oxygen is deployed, the cabin signs revert to the following (regardless of selector position):

- No Smoking Illuminated
- Fasten Seat Belts Illuminated
- Return to seats extinguish if the cabin altitude is above 10,000 ft. and passenger oxygen is on

Lighting

Flight Deck Lighting

Light Override Switch

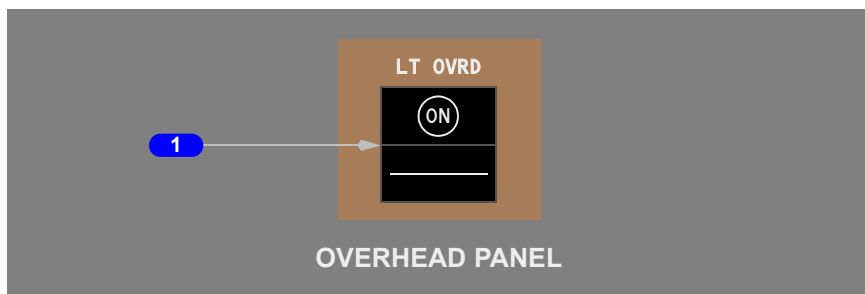

1 Light Override (LT OVRD) Switch

ON – overrides normal controls and illuminates the following lights at maximum brightness:

- forward panel flood lights
- illuminated indicator lights
- glareshield flood lights
- aisle stand flood lights
- dome lights

Circuit Breaker/Overhead Panel and Dome Lights Control

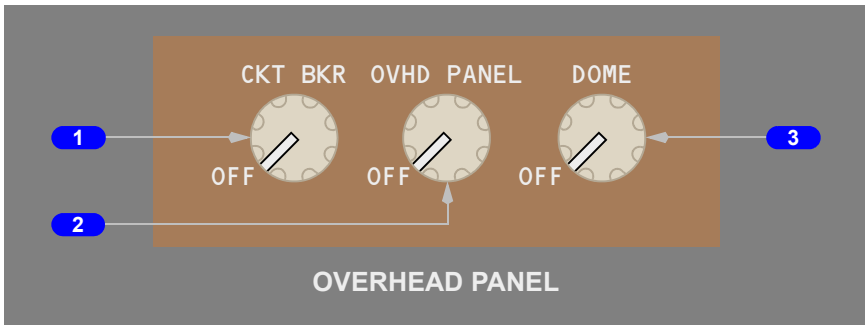

1 Circuit Breaker (CKT BKR) Panel Light Control

Rotate – controls circuit breaker panel light brightness.

2 Overhead (OVHD) Panel Lights Control

Rotate – controls overhead panel light brightness.

3 DOME Lights Control

Rotate – controls dome light brightness.

Note: Control is overridden with the Light Override Switch in the ON position.

Glareshield Panel/Flood Lights Control

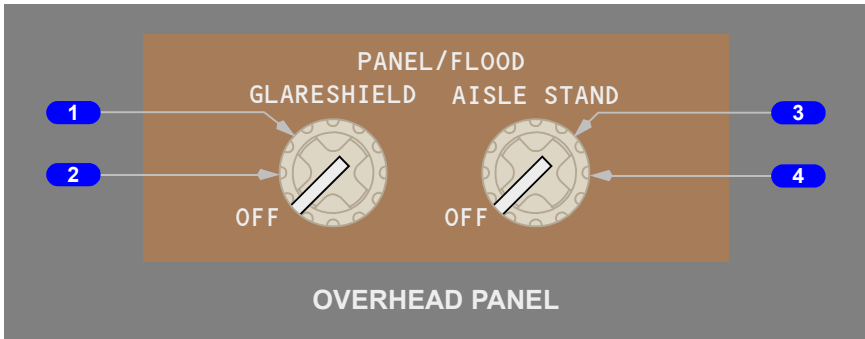

1 GLARESHIELD FLOOD Light Control (inner)

Rotate – controls glareshield flood light brightness.

2 GLARESHIELD PANEL Light Control (outer)

Rotate – controls glareshield panel light brightness.

3 AISLE STAND FLOOD Light Control (inner)

Rotate – controls the aisle stand flood light brightness.

4 AISLE STAND PANEL Light Control (outer)

Rotate – controls the aisle stand instrument panel light brightness.

Indicator Lights Switch

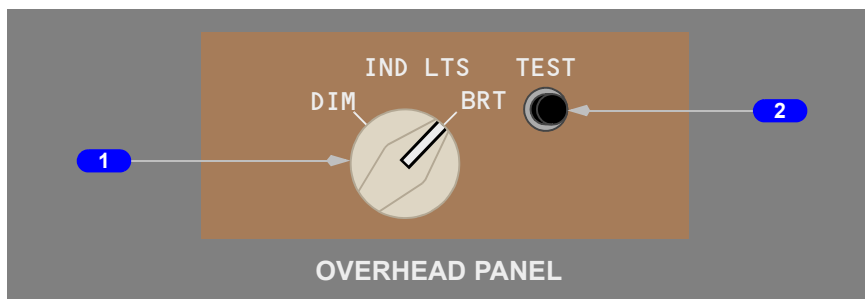

1 Indicator Lights (IND LTS) Switch

BRT – sets all illuminated annunciator lights to full brightness.

DIM – sets all illuminated annunciator lights to low brightness.

2 Indicator Lights (IND LTS) TEST Switch

Push and hold –

- Initiates an indicator lights test
- Lights illuminate at the intensity selected by the Indicator Lights selector
- Tests the ADI and HSI displays if the airplane is on the ground
- Illuminates the IRS data display characters

Pilot's Lighting Control Panel

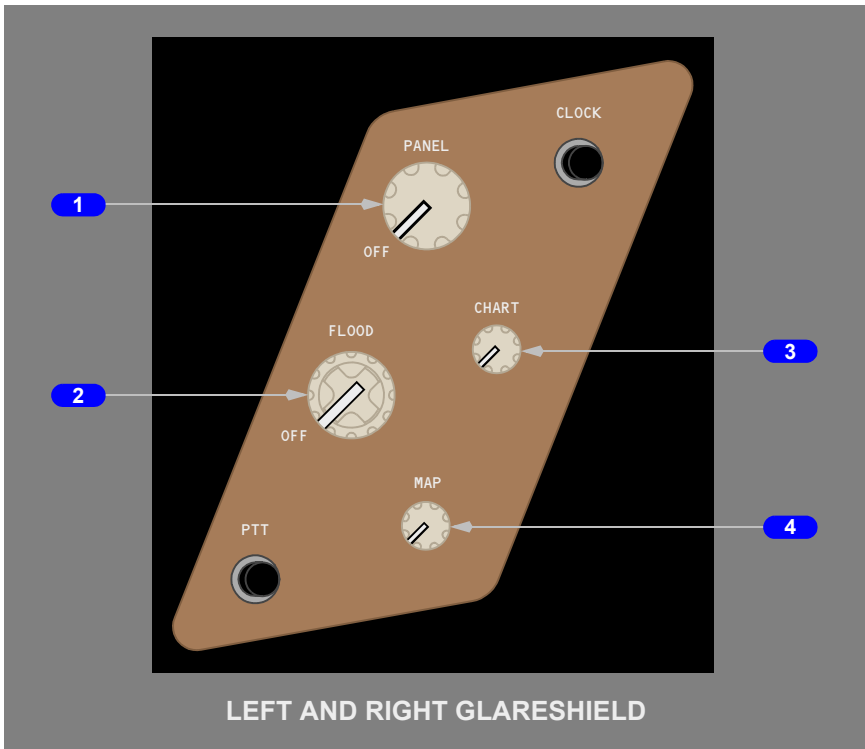

1 PANEL Light Control

Rotate –

- left controls left forward and center forward instrument panel lights and standby magnetic compass brightness
- right controls right forward panel lights brightness

2 FLOOD Light Control

Rotate –

- left controls left forward and center forward instrument panel flood lights brightness
- right controls right forward instrument panel flood lights brightness

3 CHART Light Control

Pull – on.

Push – off.

Rotate – adjusts chart light brightness.

4 MAP Light Control

Pull – on.

Push –off.

Rotate – adjusts map light brightness.

Exterior Lighting

Lighting Control Panel

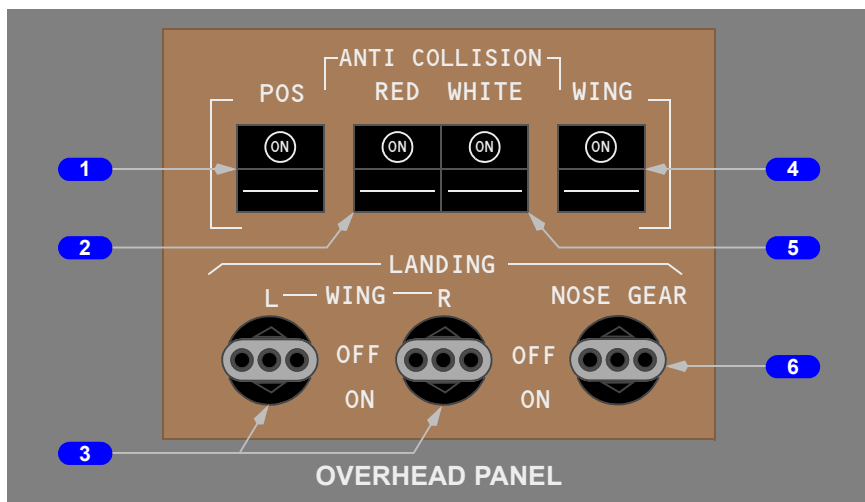

1 Position (POS) Light Switch

ON – the red, green, and white position lights illuminate.

OFF (ON not visible) – the red, green, and white position lights extinguish.

2 ANTI-COLLISION RED Light Switch

ON – the red anti-collision strobe lights on the top and bottom of the fuselage operate.

OFF (ON not visible) – the red anti-collision strobe lights on the top and bottom of the fuselage do not operate.

3 WING LANDING Light Switches

ON – the landing light illuminates.

OFF – the landing light extinguishes.

4 WING Light Switch

ON – the wing leading edge illumination lights illuminate.

OFF – the wing leading edge illumination lights extinguish.

5 ANTI-COLLISION WHITE Light Switch

ON – the white anti-collision strobe lights on tips of each wing operate.

OFF (ON not visible) – the white anti-collision strobe lights on tips of each wing do not operate.

6 NOSE GEAR LANDING Light Switch

ON – the landing lights illuminate.

OFF – the landing lights extinguish.

Note: The nose gear landing lights do not illuminate when the nose landing gear is not down and locked.

Runway Turnoff Light Switches

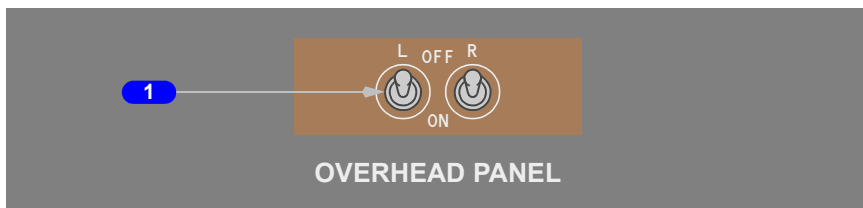

1 RUNWAY TURNOFF Light Switches

ON – the runway turnoff light illuminates.

OFF – the runway turnoff light extinguishes.

LOGO Lights

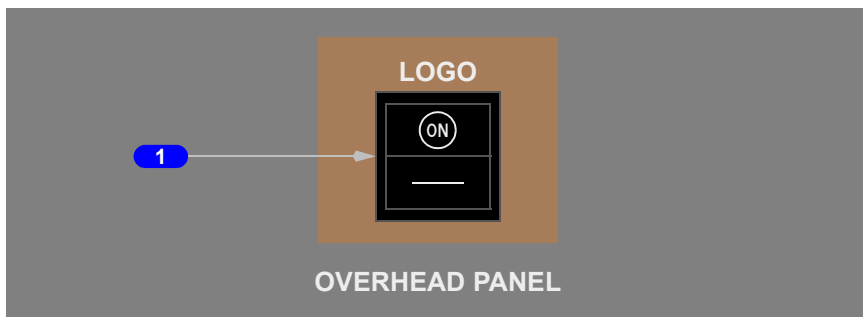

1 LOGO Light Switch

ON – the stabilizer mounted logo lights illuminate the vertical tail surface.

Emergency Lighting Controls

Flight Deck Emergency Lights Switch

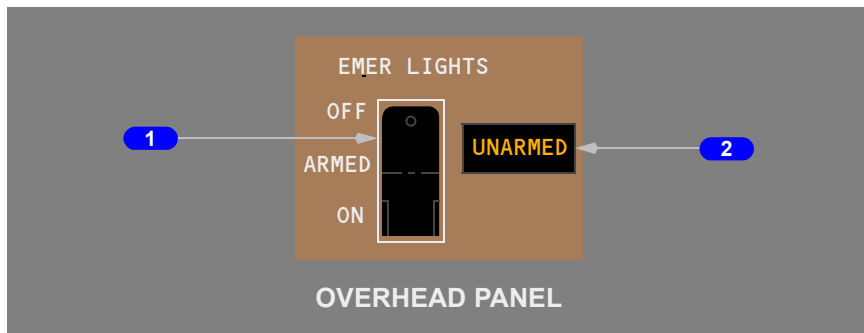

1 Emergency (EMER) LIGHTS Switch

OFF – prevents emergency lights system operation if airplane electrical power fails or is turned off.

ARMED – all emergency lights illuminate if airplane electrical power fails or is turned off.

ON – all emergency lights illuminate.

2 Emergency Lights UNARMED Light

Illuminated (amber) – the emergency lighting system has been manually actuated or the emergency lights switch is OFF.

Passenger Cabin Emergency Lights Switch

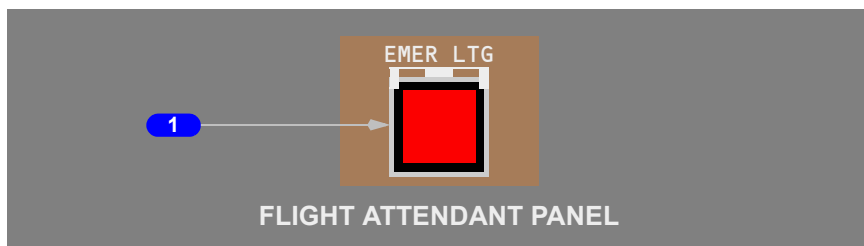

1 Passenger Cabin EMERGENCY LIGHTS Switch

Push –

- Illuminated (red):
 - all passenger cabin and exterior emergency lights illuminate
 - bypasses the flight deck emergency lights switch
- Extinguished: all passenger cabin and exterior emergency lights extinguish

Doors and Windows

Exterior Door Annunciator Lights

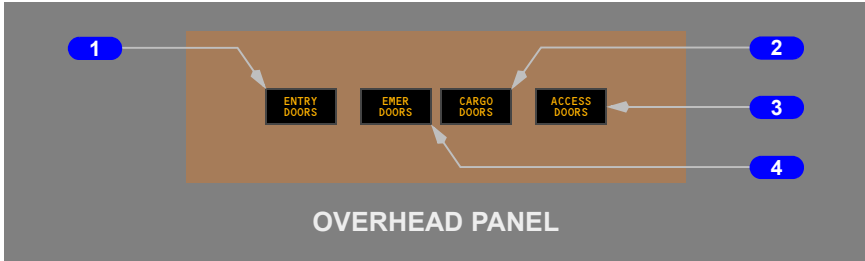

1 ENTRY DOORS Light

Illuminated (amber) – an entry door is not closed, and latched and locked.

2 CARGO DOORS Light

Illuminated (amber) – the forward, aft, or bulk cargo door is not closed and latched and locked.

3 ACCESS DOORS Light

Illuminated (amber) – the forward equipment bay or the electrical equipment compartment door is not closed and latched and locked.

4 Emergency (EMER) DOORS Light

Illuminated (amber) – a forward or aft overwing emergency exit door, or a wing slide door is not closed and latched and locked.

Illuminated (amber) – an emergency door is not closed and latched and locked.

Exterior Door Locations

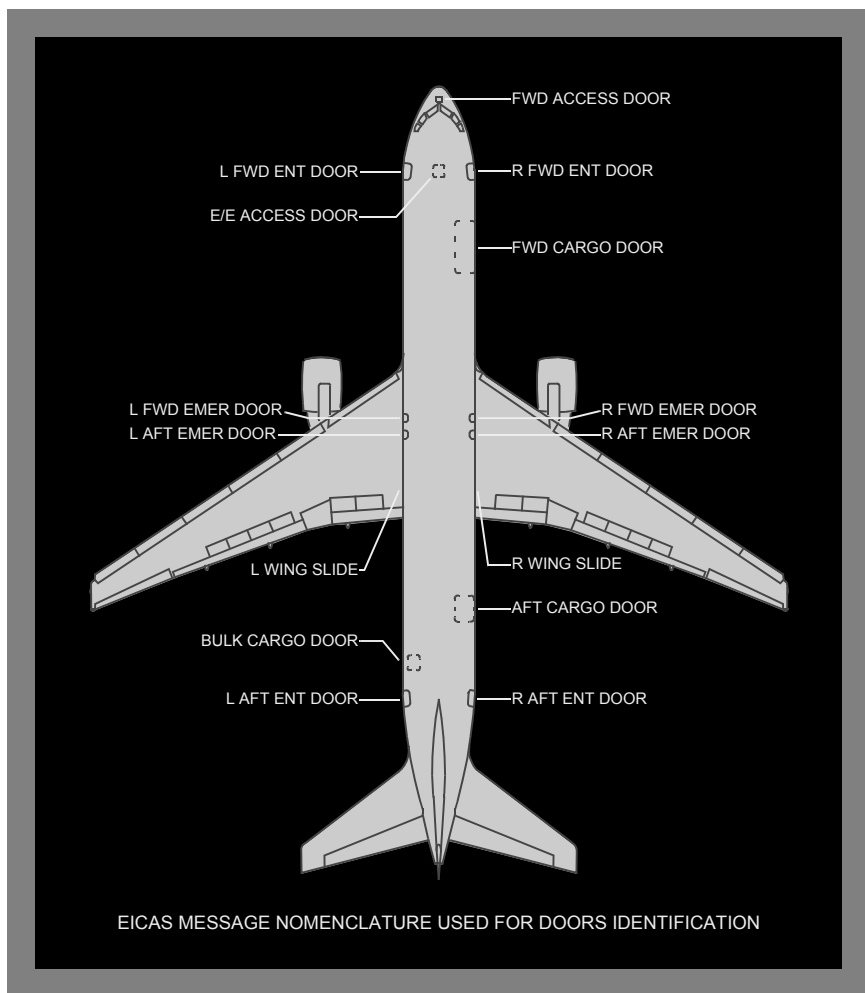

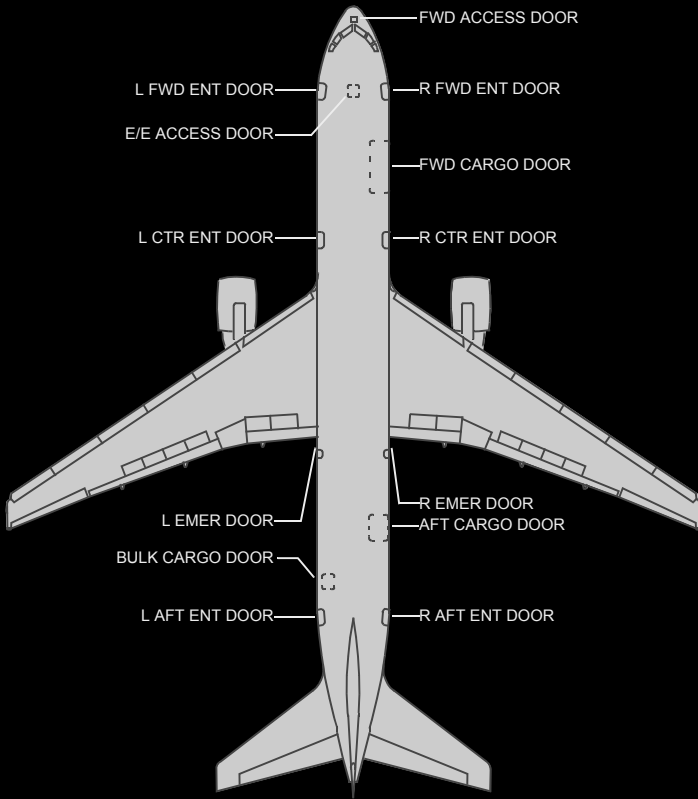

EICAS MESSAGE NOMENCLATURE USED FOR DOORS IDENTIFICATION

Passenger Entry Doors

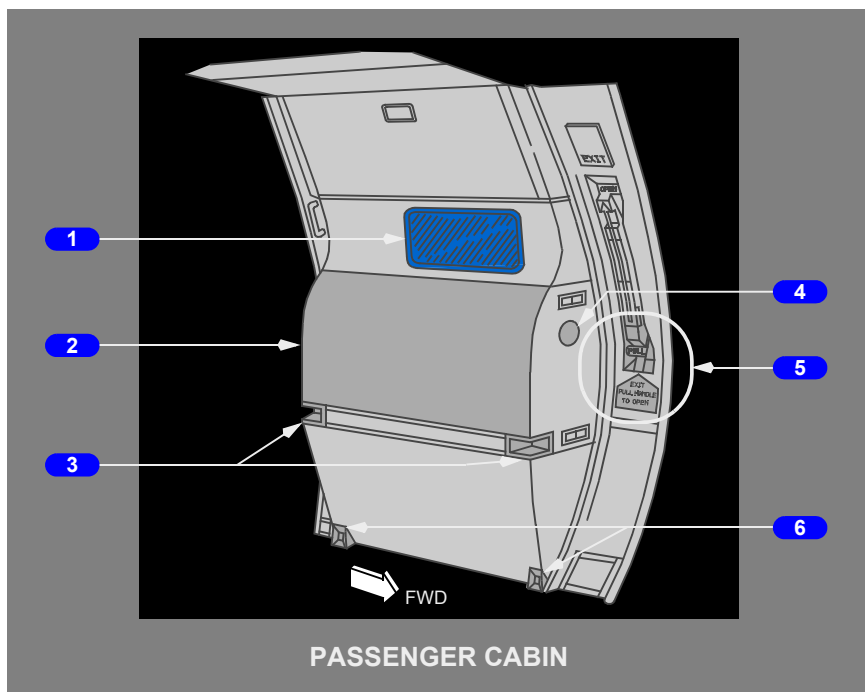

1 Viewing Window

Allows observation outside the airplane.

2 Slide

The bustle contains the slide.

Note: The slide is also configured as a raft.

3 Recessed Door Assist Handles

Used to assist in raising/lowering the door.

4 Slide Gas Bottle Pressure Gage

Maintenance use only.

5 Door Control and Mode Select Panel

See following illustration.

6 Direct Visual Indication—Girt Bar Lockdown

Indicator in view (yellow) – slide is armed.

Indicator not in view – slide is disarmed.

Passenger Door Control and Mode Select Panel

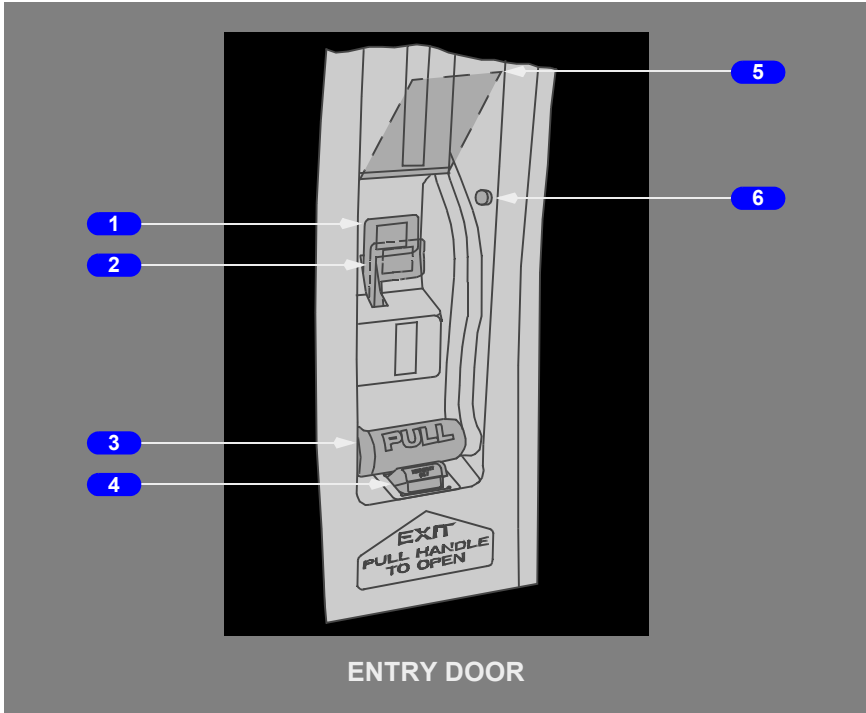

1 Slide Arming Lever

ARMED – if the door handle is moved to open, the slide deploys.

Note: If the door is opened from the outside, the slide is disarmed.

2 Slide Arming Lever

DISARMED – if the door handle is moved to open, the slide will not deploy.

3 Door Operating Handle

To open the door – pull up in the direction of the arrow.

To close the door – push down in the opposite direction of the arrow.

4 Armed Indicator

In view – slide is armed.

Not in view– slide is disarmed.

5 Slide Arming Lever Cover

Protects against inadvertent movement of the slide arming lever.

6 Slide Arming Lever Release

Push – releases slide arming lever from the slide disarmed position.

Interior Entry Door Electric Assist Controls

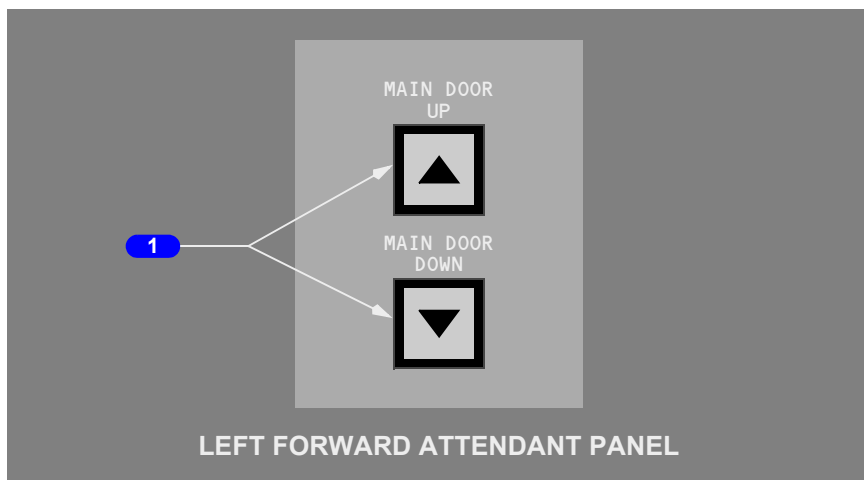

1 Main Door Switch

MAIN DOOR UP – powers electrical assist to raise the entry door.

MAIN DOOR DOWN – powers electrical assist to release the uplatch and lower the entry door.

Note: The switch must be held in position during door operation.

DO NOT USE FOR FLIGHT

Exterior Entry Door Controls

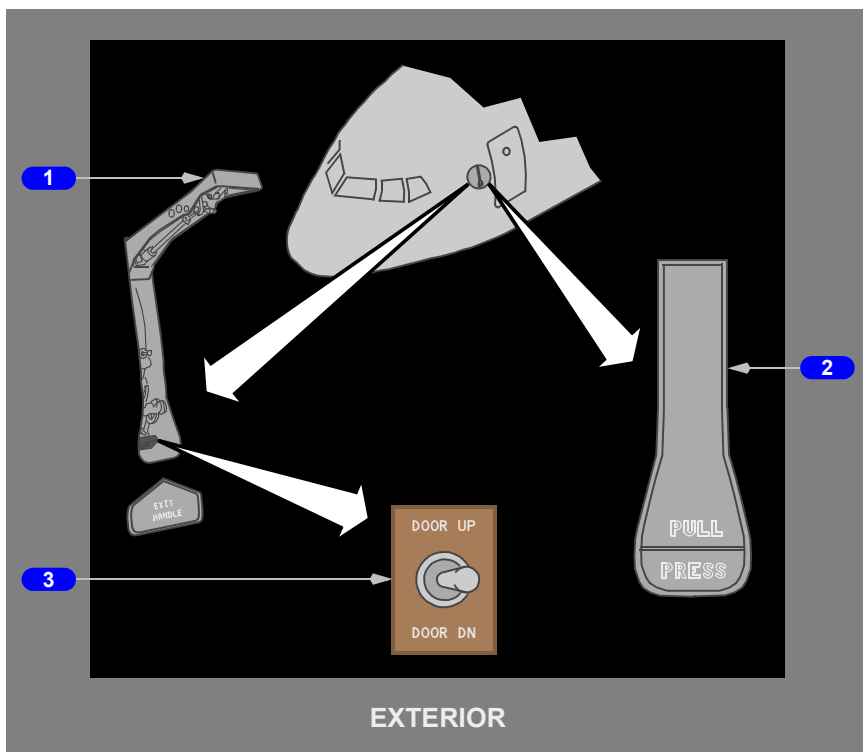

1 Exterior Door Handle, Open - Door Unlocked

2 Exterior Door Handle, Closed - Door Locked

PRESS – disarms escape slide.

PULL - unlocks door.

3 Door Switch

DOOR UP – powers electrical assist to raise the entry door.

DOOR DOWN (DN) – powers electrical assist to release the uplatch and lower the entry door.

Note: The switch must be held in position during door operation.

Overwing Emergency Exit Doors

[Option-Overwing Emergency Exit Doors installed]

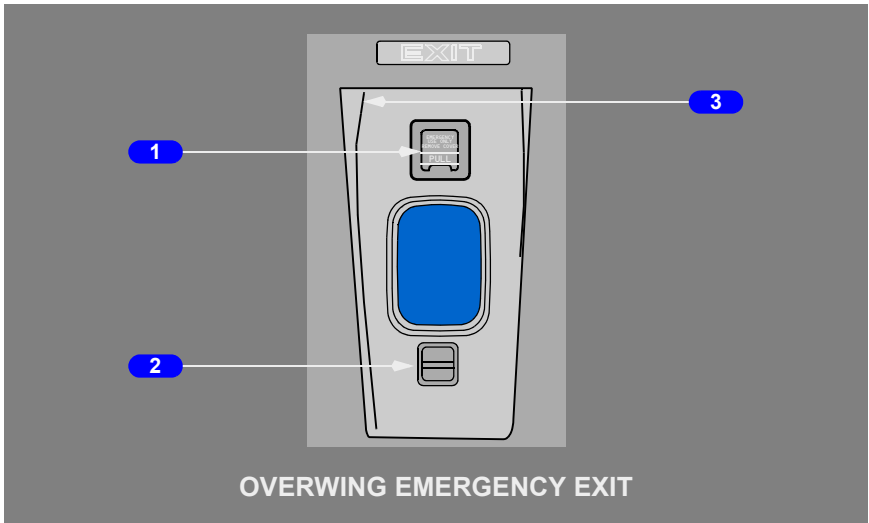

1 Emergency Handle

Note: Cover must be removed to access emergency handle.

To open the door and deploy the ramp slide – pull the handle.

2 Door Assist Handle

Used to assist in removing the door from the opening.

3 Alternate Slide Deployment Handle

Note: Door must be removed to access.

To manually deploy ramp slide in the event the normal system fails – remove the cover and pull the handle.

Emergency Doors

[Option-Emergency Doors installed]

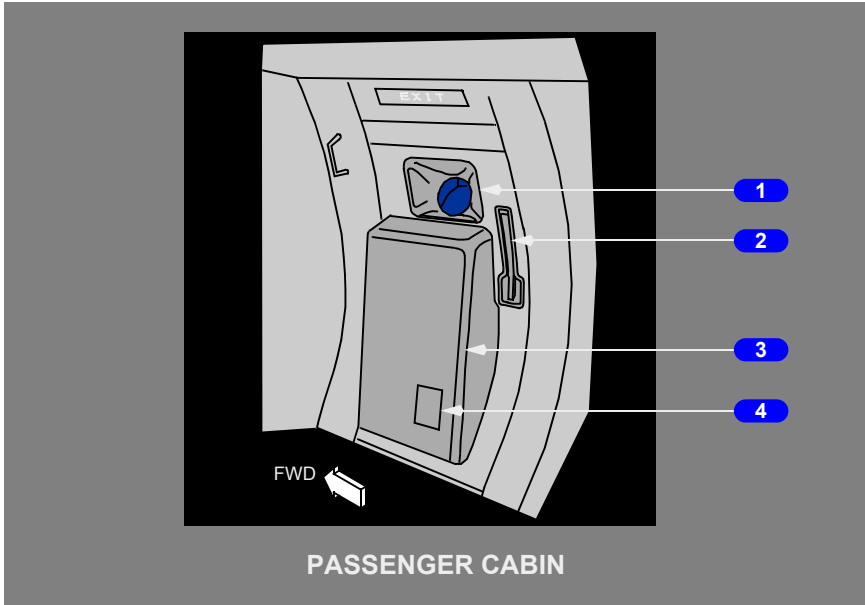

1 Viewing Window

Allows observation outside the airplane.

2 Door Operating Handle

Pull – opens door and deploys slide.

3 Slide

The bustle contains the slide.

4 Slide Gas Bottle Pressure Gage

Maintenance use only.

Flight Deck Security Door

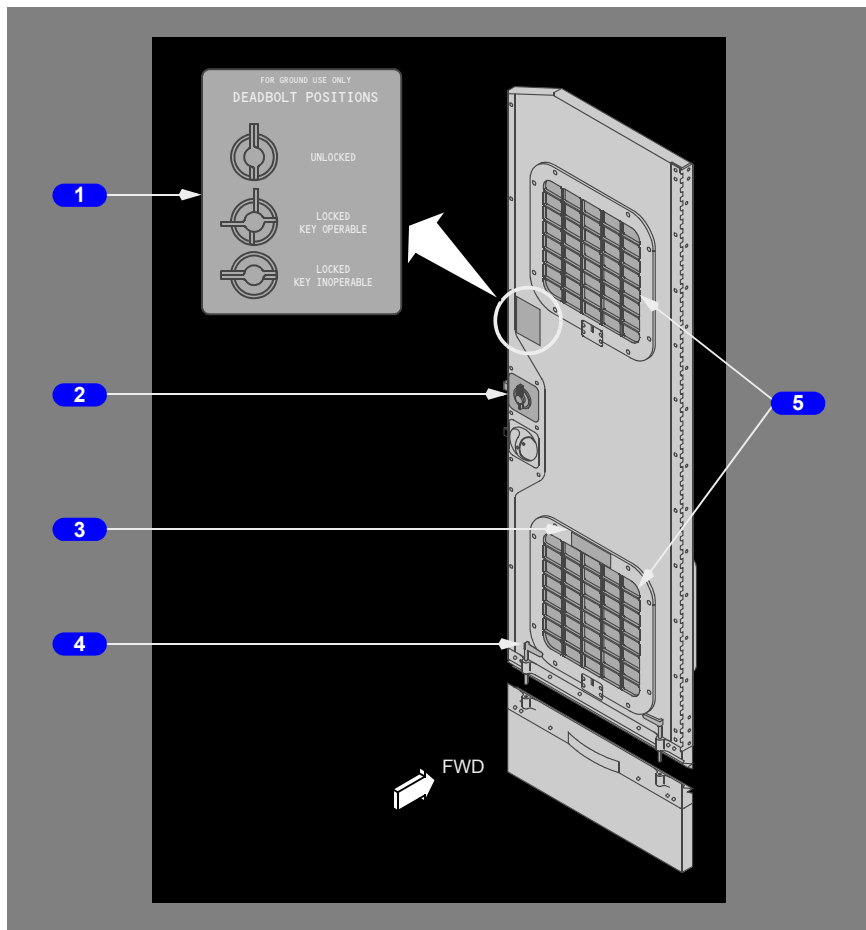

1 Deadbolt Positions Placard

2 Deadbolt Levers

3 Emergency Egress Placard

Describes how to separate lower break-away panel from a jammed door to allow door opening and egress.

4 Shear Pins

Retract out of lower break-away panel when shear pin levers rotate down.

5 Security Grill

Prevents intrusion into flight deck if decompression panels open due to cabin depressurization.

Flight Deck Emergency Access Panel

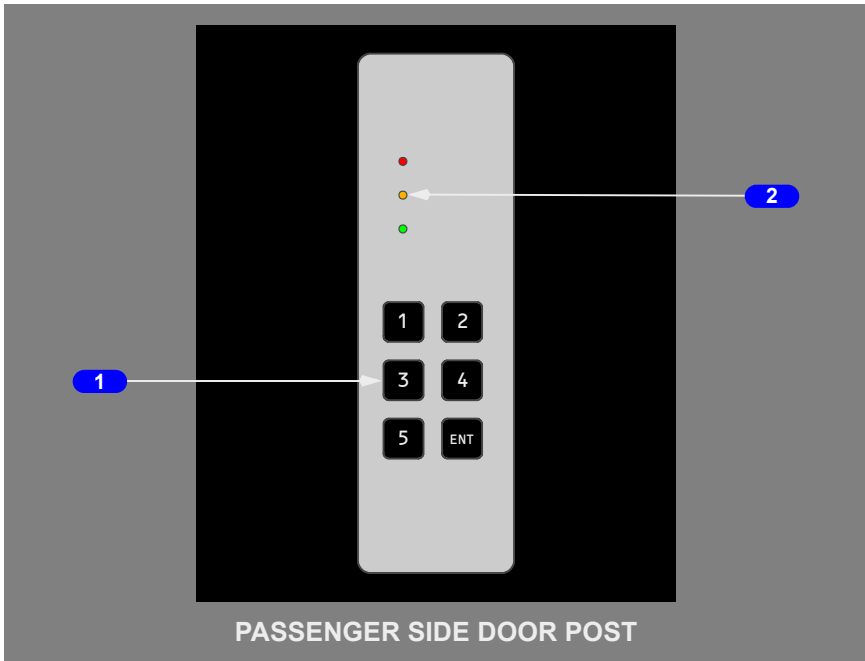

1 Keypad

Push - enters 3 to 8 digit emergency access code by pressing numeric then "ENT" keys. Entry of correct emergency access code sounds flight deck chime.

2 Access Lights

Illuminated (red) - door locked or Flight Deck Access System switch OFF..

Illuminated (amber) - correct emergency access code entered.

Illuminated (green) - door unlocked.

Flight Deck Access System Switch

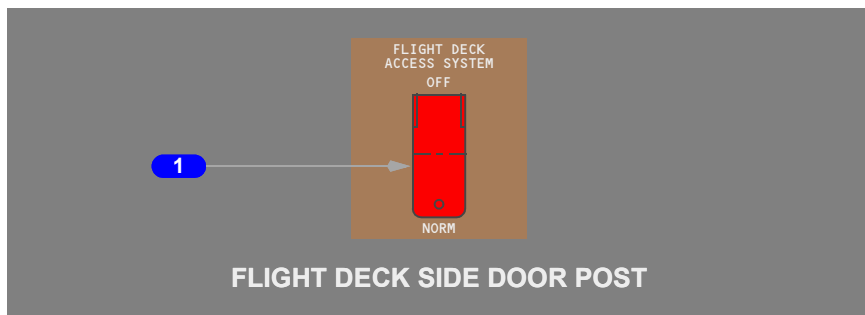

1 Flight Deck Access System Switch

OFF - removes electrical power from door lock.

NORM (Normal) - flight deck access system configured for flight.

Flight Deck Door Lock Panel

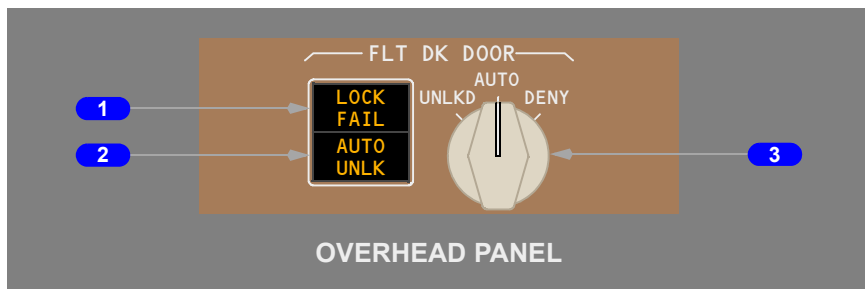

1 LOCK FAIL Light

Illuminated (amber) - door lock selector in AUTO position and door lock has failed or the Flight Deck Access System Switch in OFF.

2 AUTO UNLOCK (UNLK) Light

Illuminated (amber) - correct emergency access code entered in keypad. AUTO UNLK light flashes and continuous chime sounds before timer expires and door unlocks.

3 Flight Deck Door (FLT DK DOOR) Lock Selector

Spring loaded to AUTO. Selector must be pushed in to rotate from AUTO to UNLKD position. Selector must not be pushed in to rotate from AUTO to DENY position.

UNLKD - door unlocked while selector in UNLKD.

AUTO - door locked. Allows door to unlock after entry of emergency access code and expiration of timer, unless crew takes action.

DENY - rejects keypad entry request and prevents further emergency access code entry for a time period.

Flight Deck Number Two Window

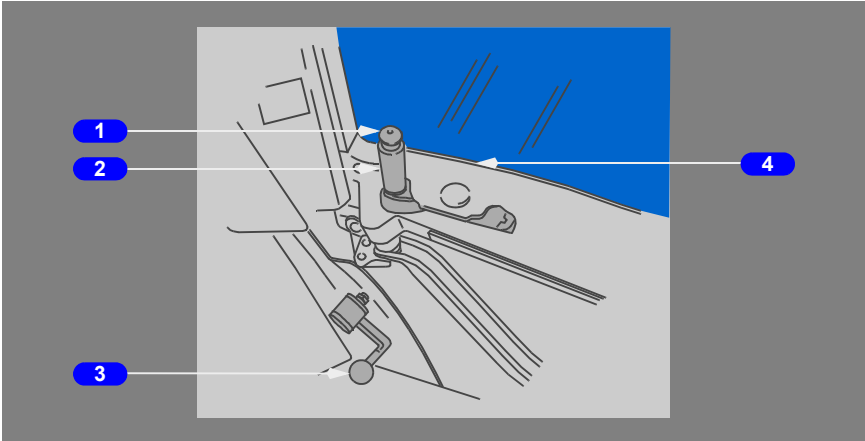

1 Window Lock Release Button

Button must be depressed to free the Window Lock Lever from the Forward Position.

2 Window Lock Lever

Forward Position– with the window fully closed (WINDOW NOT CLOSED decal not visible), locks the window.

Aft Position– unlocks the window so it can be cranked open.

3 Window Crank

Used to position the window open or closed when the window lock lever is unlocked.

4 WINDOW NOT CLOSED Decal

Visual indication the window is not fully closed.

Oxygen Systems

Oxygen Indications

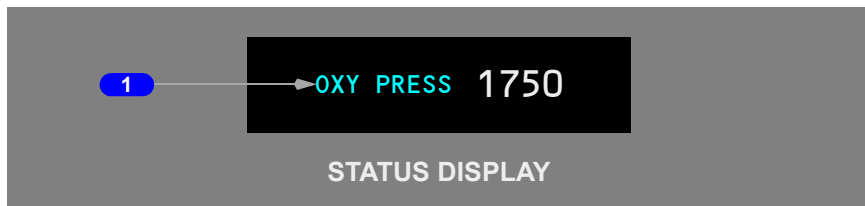

1 Oxygen Pressure (OXY PRESS) Display

Displays crew oxygen cylinder pressure (psi).

Passenger Oxygen Switch

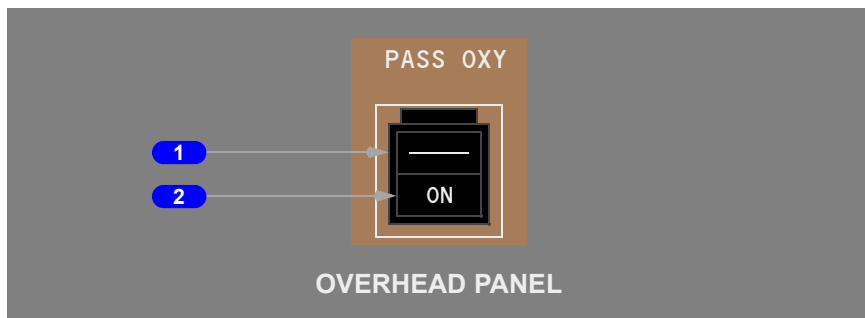

1 Passenger Oxygen (PASS OXY) Switch

Push – the passenger cabin oxygen masks drop.

2 Passenger Oxygen ON Light

Illuminated (amber) – the passenger oxygen system is operating and the masks have dropped.

DO NOT USE FOR FLIGHT

Oxygen Mask Panel

[Option-Scott EROS Oxygen Masks with Vent valve Installed]

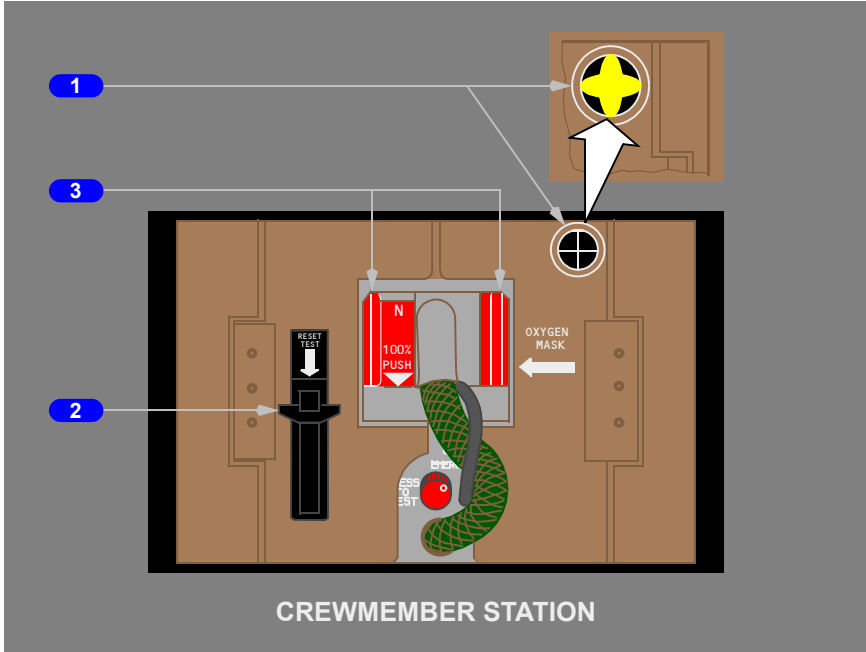

[Option-Scott Full Face Oxygen Masks installed]

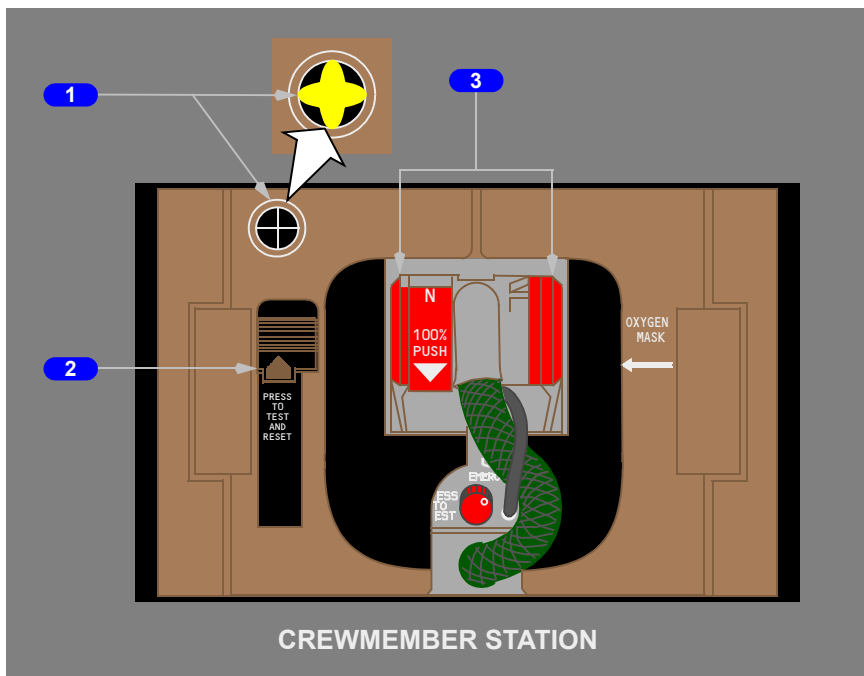

1 Oxygen Flow Indicator

Shows a yellow cross when oxygen flowing.

2 RESET/TEST Switch

Push –

- with the left oxygen panel door closed and OXY ON flag not displayed, turns oxygen on momentarily to test the regulator
- with the left oxygen panel door closed and the OXY ON flag displayed, turns oxygen off

3 Oxygen Mask Release Levers

Squeeze and pull –

- unlocks the oxygen panel doors
- releases the mask
- oxygen turns on when the oxygen panel doors open

Squeeze (right lever) – inflates the mask harness.

Release – deflates the mask harness into position on the head and face.

Oxygen Mask and Regulator

[Option-Scott Full Face Oxygen Masks installed]

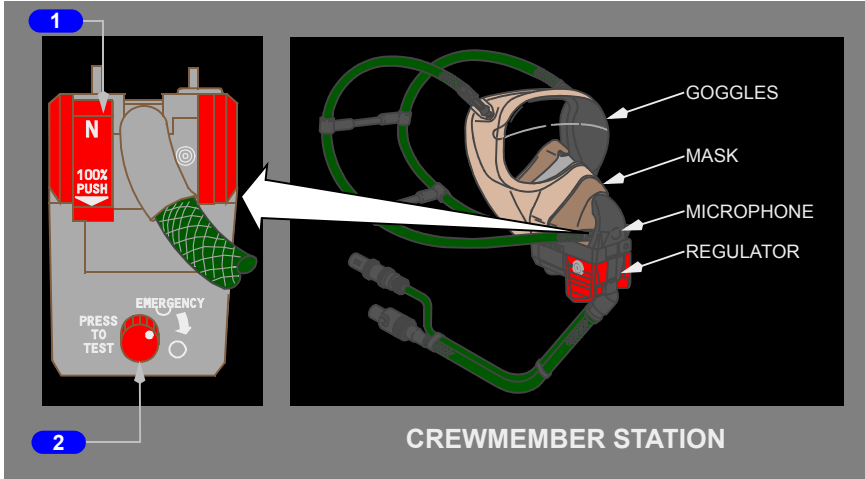

[Option-Scott EROS Oxygen Masks with Vent valve installed]

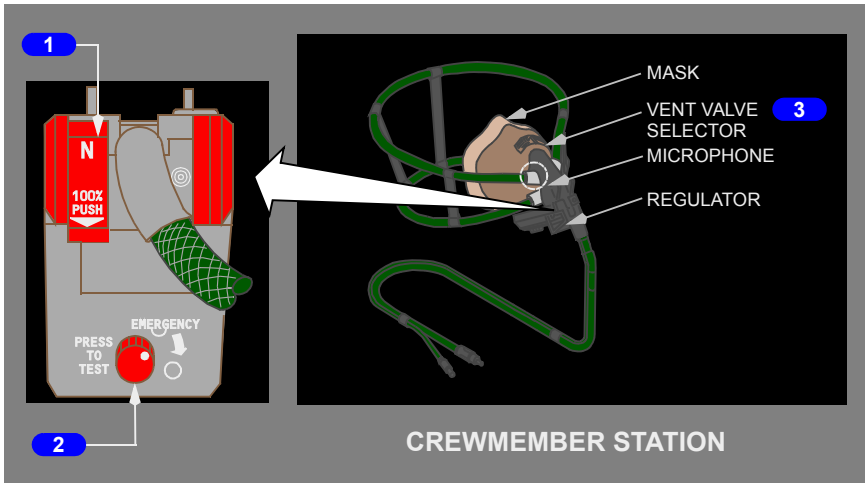

1 Normal (N)/100% Switch

N – supplies an air/oxygen mixture on demand (the ratio depends on cabin altitude).

100% – supplies 100% oxygen on demand (not an air/oxygen mixture).

2 Oxygen Mask Emergency/Test Selector

Rotate (in the direction of the arrow) – supplies 100% oxygen under positive pressure at all cabin altitudes (protects against smoke and harmful vapors).

PRESS TO TEST – tests the positive pressure supply to the regulator.

3 Smoke Vent Valve Selector

Up – vent valve closed

Down – vent valve open, allowing oxygen flow to smoke goggles.

Emergency Evacuation Panel

[Option-Gables Emergency Evacuation Panel installed]

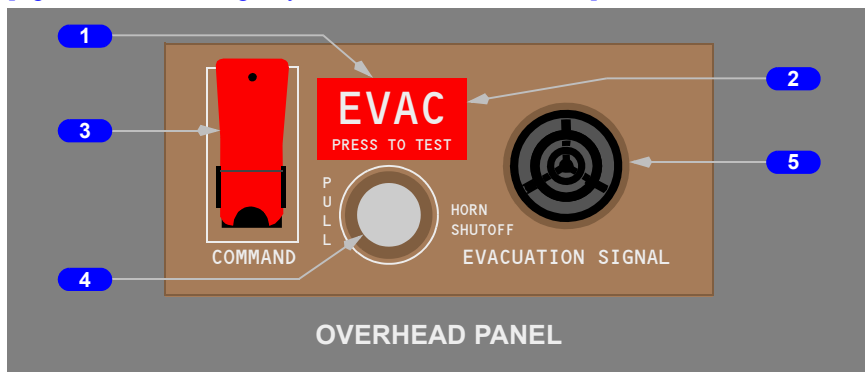

1 Evacuation (EVAC) PRESS TO TEST Switch

Push – tests the EVAC light.

2 Evacuation (EVAC) Light

Illuminated (red) – a command switch is in the ON position.

3 Evacuation COMMAND Switch

ON –

- activates evacuation signal system
- EVAC lights (flight deck and attendant panels) flash
- audio horn sounds at each panel

OFF – prevents activation of emergency evacuation COMMAND signal at all flight attendant panels.

4 Evacuation HORN SHUTOFF Switch

Pull – silences flight deck evacuation audio horn.

5 EVACUATION SIGNAL Horn

Sounds an audio signal.

Introduction

This chapter describes miscellaneous airplane systems, including:

- lighting systems
- oxygen systems
- doors and windows
- flight deck seats

Lighting Systems

Lighting systems described in this chapter include:

- exterior lighting
- flight deck lighting
- emergency lighting

Exterior Lighting

Exterior lighting consists of these lights:

- landing
- runway turnoff
- anti-collision
- navigation (position)
- wing leading edge illumination
- logo

Landing Lights

The landing lights consist of the left, right, and nose gear landing lights. The left and right landing lights are located in the left and right wing root and are optimized for flare and ground roll. The two nose gear–located landing lights are optimized for approach.

The nose gear landing lights are inoperative when the nose landing gear is not down and locked.

Runway Turnoff Lights

Two runway turnoff lights are located in the left and right wing root.

White Anti–collision Lights

The white anti–collision lights are strobe lights located on each wing tip.

Red Anti-collision Lights

The red anti-collision lights are strobe lights located on the top and bottom of the fuselage.

Navigation Lights

The navigation lights are standard red (left forward wingtip), green (right forward wingtip), and white (aft tip of both wings) position lights.

Wing Lights

Wing lights are installed on the fuselage and illuminate the leading edge of the wing.

Logo Lights

Logo lights are located on the stabilizer to illuminate the logo on the vertical tail surface.

Exterior Lighting Locations

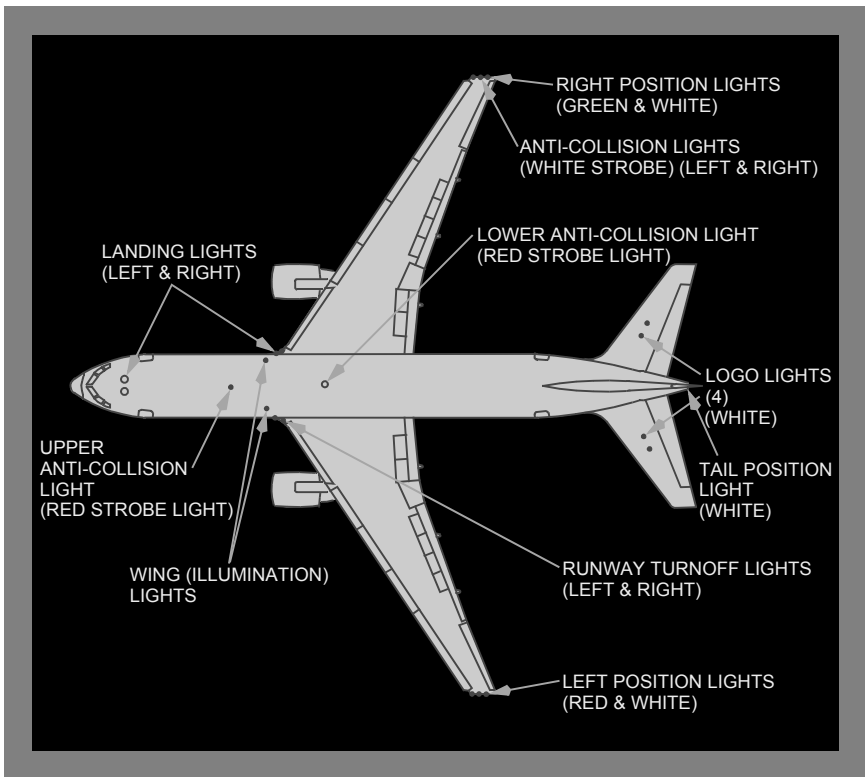

Flight Deck Lighting

Flight deck lighting is provided for panel illumination, area lighting, and localized illumination. Flood lights and light plates provide panel illumination. Dome lights provide flight deck area lighting. Map lights, chart lights, and utility lights provide localized illumination.

Panel and flood lights illuminate the forward panels, glareshield, and aisle stand panels. When the light override switch is ON, the forward panel flood lights, glareshield flood lights, dome lights, aisle stand flood lights, and all illuminated annunciator lights illuminate at full brightness.

If normal electrical power is lost, the standby magnetic compass light, forward panel flood lights, and integral lights for essential instruments on the left forward, center forward, and overhead panels are automatically switched to the Standby AC bus.

Indicator Lights

Indicator Light brightness can be set to DIM or BRT with the indicator lights selector. The system automatically overrides the DIM position and illuminates the indicator lights full bright if the ambient flight deck light level increases to a preset crossover light value as detected by system sensors located on the center forward panel.

Passenger Cabin Signs

The passenger cabin signs are controlled by overhead panel selectors. The passenger signs illuminate when any of the following conditions are satisfied:

FASTEN SEAT BELTS signs (AUTO selected):

- cabin altitude above 10,000 feet
- landing gear not up and locked
- flap lever not up
- passenger oxygen on

NO SMOKING signs (AUTO selected):

- cabin altitude above 10,000 feet
- landing gear not up and locked
- passenger oxygen on

All passenger signs can be controlled manually by positioning the respective selector to ON or OFF. When the FASTEN SEAT BELTS and NO SMOKING selectors are in the OFF position, and cabin altitude is above 10,000 feet or passenger oxygen is on, the FASTEN SEAT BELTS and NO SMOKING signs illuminate.

RETURN TO SEAT signs are illuminated with the FASTEN SEAT BELTS signs and extinguish when the passenger oxygen is on either automatically or manually.

When the passenger signs illuminate or extinguish, a low tone sounds over the PA system.

Emergency Lighting

The emergency lighting consists of :

- passenger cabin interior emergency lights
- passenger exterior emergency lights
- aft flight deck dome light (one bulb only)

These lights are powered by the emergency lighting system. These lights provide illumination for evacuating the airplane. The system is controlled by the emergency lights switch on the overhead panel. The switch can be used to manually activate or arm the system for automatic operation. Automatic operation occurs if DC power fails or is turned off when the system is armed. The emergency lighting system can also be controlled by the emergency lights switch on the flight attendant switch panel.

When the emergency lights switch on the flight deck is armed, and the slide arming lever is in the SLIDE ARMED position, moving the door handle to the open position will cause the exterior emergency lights on that side of the airplane to illuminate.

In addition, when the emergency lights switch on the flight deck is armed, moving an overwing emergency exit door handle to the open position will cause the exterior emergency lights on that side of the airplane to illuminate.

The emergency lighting system is powered by remote batteries. Battery charge is maintained by the airplane electrical system. A fully charged battery provides at least 15 minutes of operation.

The UNARMED light illuminates and the EICAS advisory message EMER LIGHTS displays if the emergency lights switch is not in the ARMED position.

Interior Emergency Lighting

Interior emergency lighting consists of door, aisle, escape path, and lighted exit signs.

Battery powered exit lights are located at each cabin exit.

Exterior Emergency Lighting

Exterior emergency lights are located at each entry door and emergency door. Lights are also installed in each slide to illuminate the ground at the end of the slide.

Exterior emergency lights are located at each entry door and overwing emergency exit door. Lights are also installed in each slide to illuminate the ground at the end of the slide.

Oxygen Systems

Two independent oxygen systems are provided, one for the flight crew and one for the passengers. Portable oxygen cylinders are located throughout the airplane for emergency use.

Flight Crew Oxygen System

The flight crew oxygen system uses quick-donning masks and regulators located at each crew station. Oxygen pressure is displayed on the lower EICAS status display.

Flight crew and observer masks and regulators are installed in oxygen mask panels near each seat. Squeezing the red oxygen mask release levers releases the mask from stowage. Removing the mask:

- inflates the mask harness
- momentarily displays the yellow oxygen flow indicator

Passenger Oxygen System

The passenger oxygen system is supplied by individual chemical oxygen generators. The oxygen system provides oxygen to the passenger, attendant stations, and lavatory service units. The passenger oxygen masks and chemical oxygen generators are located above the passenger seats in passenger service units (PSUs). Oxygen flows from a PSU generator when any mask hanging from that PSU is pulled. The masks automatically drop from the PSUs if cabin altitude exceeds 14,000 feet. The passenger masks can be manually deployed from the flight deck by pushing the passenger oxygen switch. The passenger oxygen ON light illuminates and EICAS advisory message PASS OXYGEN ON displays when the system is activated.

Portable Oxygen Bottles

Portable oxygen bottles are stowed in various locations in the passenger cabin. The bottles are fitted with disposable masks and are used for first aid purposes or as walk-around units.

Doors and Windows

The airplane has six passenger entry doors, four overwing emergency exit doors, one flight deck door (the flight deck/passenger cabin entry), and three cargo doors. It also has electrical equipment and forward equipment bay access doors.

The airplane has four passenger entry doors, four overwing emergency exit doors, one flight deck door (the flight deck/passenger cabin entry), and three cargo doors. It also has electrical equipment and forward equipment bay access doors.

The airplane has six passenger entry doors, two emergency doors, one flight deck door (the flight deck/passenger cabin entry), and three cargo doors. It also has electrical equipment and forward equipment bay access doors.

The airplane has four passenger entry doors, two emergency doors, one flight deck door (the flight deck/passenger cabin entry), and three cargo doors. It also has electrical equipment and forward equipment bay access doors.

The flight deck number two windows, one on the left and one on the right, can be opened by the flight crew.

An EICAS message is displayed when a passenger entry door, overwing emergency exit door, cargo door or access door is not closed and latched, and locked.

An EICAS message is displayed when a passenger entry door, emergency door, cargo door or access door is not closed and latched and locked.

Flight Deck Security Door

The flight deck security door meets requirements for resistance to ballistic penetration and intruder entrance. The door opens into the flight deck. There is a step between the flight deck and the cabin. When closed, the door locks when electrical power is available and unlocks when electrical power is removed. A viewing lens in the door allows observation of the passenger cabin. The door can be manually opened from the flight deck by turning the door handle.

The door incorporates a deadbolt with a key lock. Rotating both concentric deadbolt levers to the locked (horizontal) position prevents the passenger cabin key from unlocking the door. Rotating only the forward deadbolt lever to locked allows the key to unlock the door.

The flight deck access system consists of an emergency access panel, chime module, Door Lock selector, two indicator lights, and an Access System switch. The emergency access panel includes a six button keypad for entering the numeric access code along with red, amber, and green lights. The red light illuminates to indicate the door is locked. When the correct emergency access code is entered, the amber light illuminates. The green light illuminates to indicate the door is unlocked.

Two indicator lights and a three position rotary Door Lock selector are located on the overhead panel. Illumination of the amber LOCK FAIL light indicates the door lock has failed or the Access System switch is in the off position.

The emergency access code is used to gain access to the flight deck in case of pilot incapacitation. Annunciation of a flight deck chime and illumination of the amber AUTO UNLK light indicates the correct emergency access code has been entered and the door is programmed to unlock after a time delay. Selecting the DENY position on the Door Lock selector denies entry and prevents further keypad entry for several minutes. To allow entry, the selector is turned to the UNLKD position which unlocks the door while held in that position. If the emergency access code is entered and the pilot takes no action, the door unlocks after expiration of the time delay. Before the door unlocks, the chime sounds continuously and the AUTO UNLK light flashes.

By pressing "1" then "ENT" keys on the emergency access panel, the flight deck chime will sound (if programmed).

The door latch system incorporates a pressure rate-sensor that unlocks the door in the event of flight deck depressurization. Two hinged decompression panels open to equalize pressure in the event of cabin depressurization. Each panel opening has a security grill on the flight deck side.

Features are included to prevent a jammed door due to structural deformation. A lower break-away panel is attached to the main door section by interlocking extrusions and two shear pins. If sufficient upward force occurs, the pins will shear and the break-away panel will separate from the door. If the pins fail to shear, they can be retracted manually to aid in egress. An angled door jamb aids in forcing the door open into the flight deck in case of surrounding bulkhead deformation.

Flight Deck Number Two Windows

The flight deck number two windows can be opened on the ground or in flight. The flight deck number two windows can be used for emergency evacuation. Pressing the Window Lock Release Button frees the Window Lock Lever. The Window Lock Lever locks or unlocks the window. Rotating the window crank opens and closes the window.

A WINDOW NOT CLOSED placard is visible when the window is open.

The windows can be opened or closed in flight with minor flight deck consequences if the airplane is unpressurized. The force required to move the crank increases with airspeed. With the window open, voice, interphone, and radio audio may not be heard due to high noise levels. Prior communications arrangements with the controlling agency should be established before opening the window. The design provides an area of relatively calm air over the open window. Forward visibility can be maintained by looking out of the open window.

Flight Deck Window Emergency Egress

If the flight deck number two windows must be used for emergency evacuation, exit in accordance with the following illustration.

CAUTION: Ensure the rope is securely fastened to the airplane.

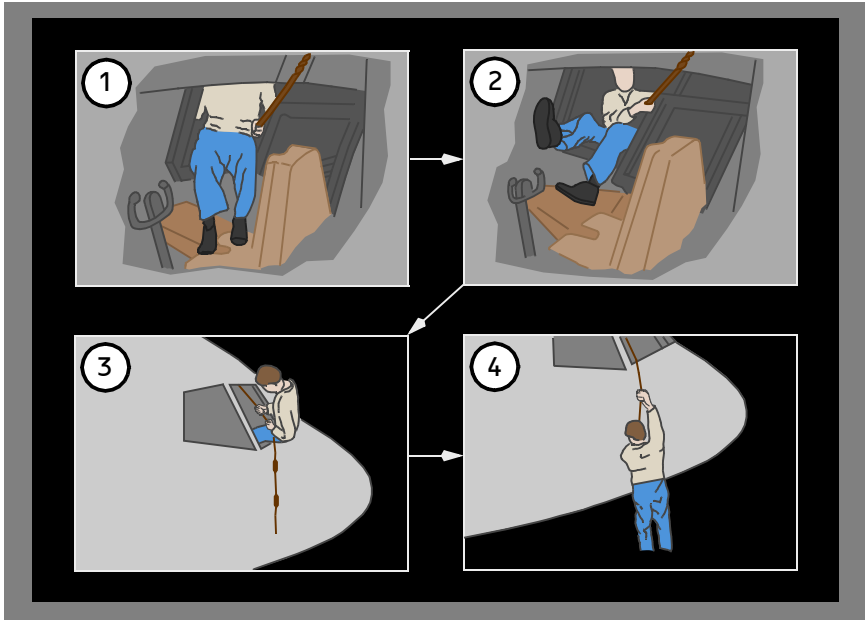

Passenger Entry Doors

The passenger entry doors are used to enter and exit the airplane, and also serve as emergency exits. The passenger entry doors are paired along the airplane fuselage. The doors can be opened or closed manually from inside or outside of the airplane.

Door 1L may be opened or closed electrically through the electrical control panel located adjacent to the door.

The entry doors are plug-type doors. During opening, the door first moves inward, then upward into the ceiling. The weight of the door is counterbalanced so that very little effort is required for operation. The door is held open by a latch in the upper part of the door frame. In order to close the door it must initially be raised slightly, push and hold the uplatch release button, lower the door approximately 2 inches (5 centimeters). Release button and continue to lower the door.

WARNING: Stand clear of the door handle, the handle may move as the door is lowered.

A window in each door allows observation outside of the airplane.

The ENTRY DOORS light illuminates and the EICAS advisory message L AFT, L FWD, R AFT, or R FWD ENT DOOR displays when a passenger entry door is not closed and latched and locked. If two doors on the same side of the airplane are not closed and latched and locked, the EICAS advisory message L or R ENTRY DOORS displays.

The ENTRY DOORS light illuminates and the EICAS advisory message L AFT, L CTR, L FWD, R AFT, R CTR or R FWD ENT DOOR displays when a passenger entry door is not closed and latched and locked. If two or more doors on the same side of the airplane are not closed and latched and locked, the EICAS advisory message L or R ENTRY DOORS displays.

Passenger Entry Door and Slide Operation

Emergency evacuation slide and door opening systems are provided for each passenger entry door. A cover in the lower face of the door contains the slide.

For normal operations, the slide must be disarmed before opening the door. Moving the arming lever to the SLIDE DISARMED position causes the door girt bar to detach from the floor, the girt bar visual indication window to completely blank, and the yellow armed indicator to be removed from view. Pulling the Door Handle up will unlock and unseat the door.

The emergency door opening system is armed by first pressing the arming lever release and then positioning the arming lever to the SLIDE ARMED position. This engages the door girt bar, the girt bar visual indication window will be completely yellow, and armed indicator will be in view. Once armed, rotating the door handle up to the OPEN position unlocks the door and causes the slide to deploy. The door will retract to the full open position, and the slide will inflate automatically.

A manual inflation handle can be pulled if the slide has not automatically inflated.

The emergency door opening system and the slide are automatically disarmed when the door is opened from the outside. If the arming lever is in the ARMED position and the door is opened using the exterior door handle, the arming lever automatically moves to DISARMED and the door opens without slide deployment.

The passenger door evacuation slides are also configured as rafts.

Escape Slide/Raft Deployed

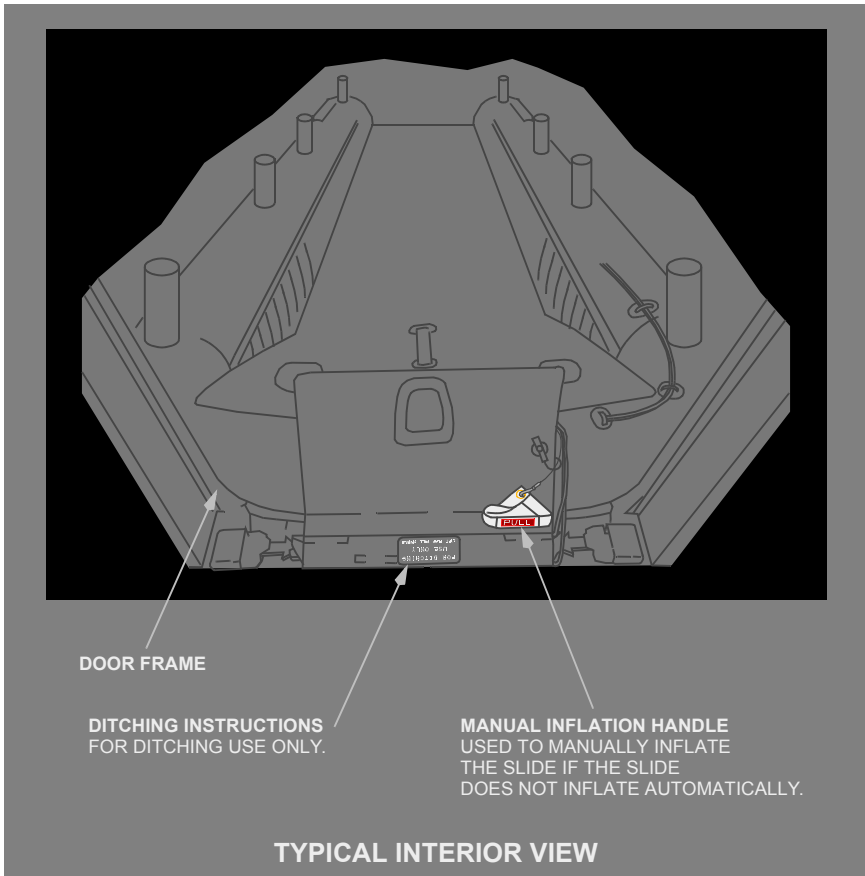

Emergency Doors

An emergency door is located aft of the wing on each side of the airplane. The emergency door is only used as an emergency exit. A slide bustle in the lower face of the door contains an evacuation slide. A window in the door allows observation outside of the airplane.

The emergency door is a plug-type door and is hinged on the bottom. Pulling the door operating handle up lifts the door inward and upward. The door can then be pushed out through the door frame and the slide automatically deploys and inflates.

A manual inflation handle can be pulled if the slide has not automatically inflated.

The EMER DOORS light illuminates and the EICAS advisory message L or R EMER DOOR displays when an emergency door is not closed and latched and locked. If both doors are not closed and latched and locked, the EICAS advisory message EMER DOORS displays.

The emergency door evacuation slides are not configured as rafts, however they may be used as auxiliary flotation devices.

Overwing Emergency Exit Doors

Overwing emergency exit doors are located over the wing on each side of the airplane. The overwing emergency exit doors are only used as emergency exits. An overwing evacuation ramp and slide assembly is contained within each wing body fairing. A window in the door allows observation outside of the airplane.

The overwing emergency exit door is a plug-type hatch. The emergency PULL handle opens the door. The door can then be removed from the opening. Opening the overwing emergency exit door automatically deploys and inflates the ramp and slide. Simultaneously, on that side of the airplane, the inboard spoiler is retracted and the exterior emergency lights illuminate.

A manual inflation handle can be pulled if the ramp and slide has not automatically inflated.

The overwing emergency exit door ramp and slide is automatically disarmed when the door is opened from the outside.

The EMER DOORS light illuminates and the EICAS advisory message L AFT, L FWD, R AFT or R FWD EMER DOOR displays when an overwing emergency exit door is not closed and latched and locked. The EICAS advisory message EMER DOORS displays if two or more, overwing emergency exit doors are not closed and latched and locked.

The overwing emergency exit door ramps and slides are not configured as raft and they may not be used as auxiliary flotation devices.

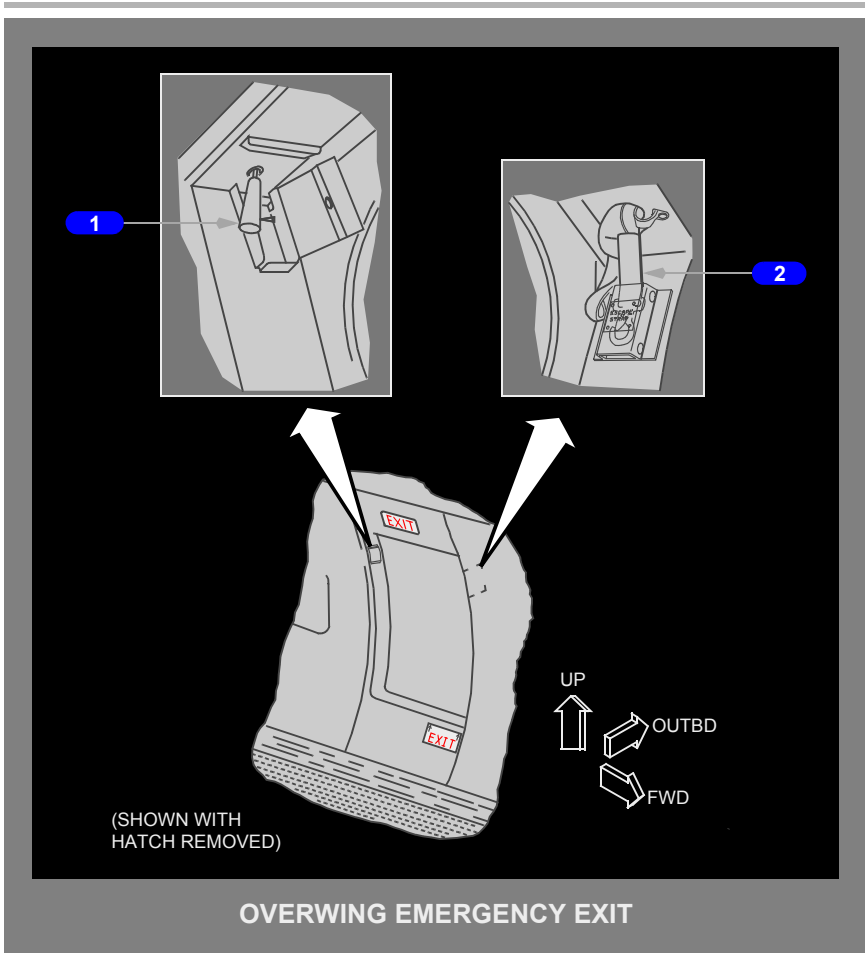

1 Manual Inflation Handle

Pull – Deploys ramp slide in the event normal system fails.

- one per exit

2 Escape Strap (FWD Door only)

Remove Cover – Pull out and attach hook to wing fitting.

- installed on forward door only

Evacuation Slides

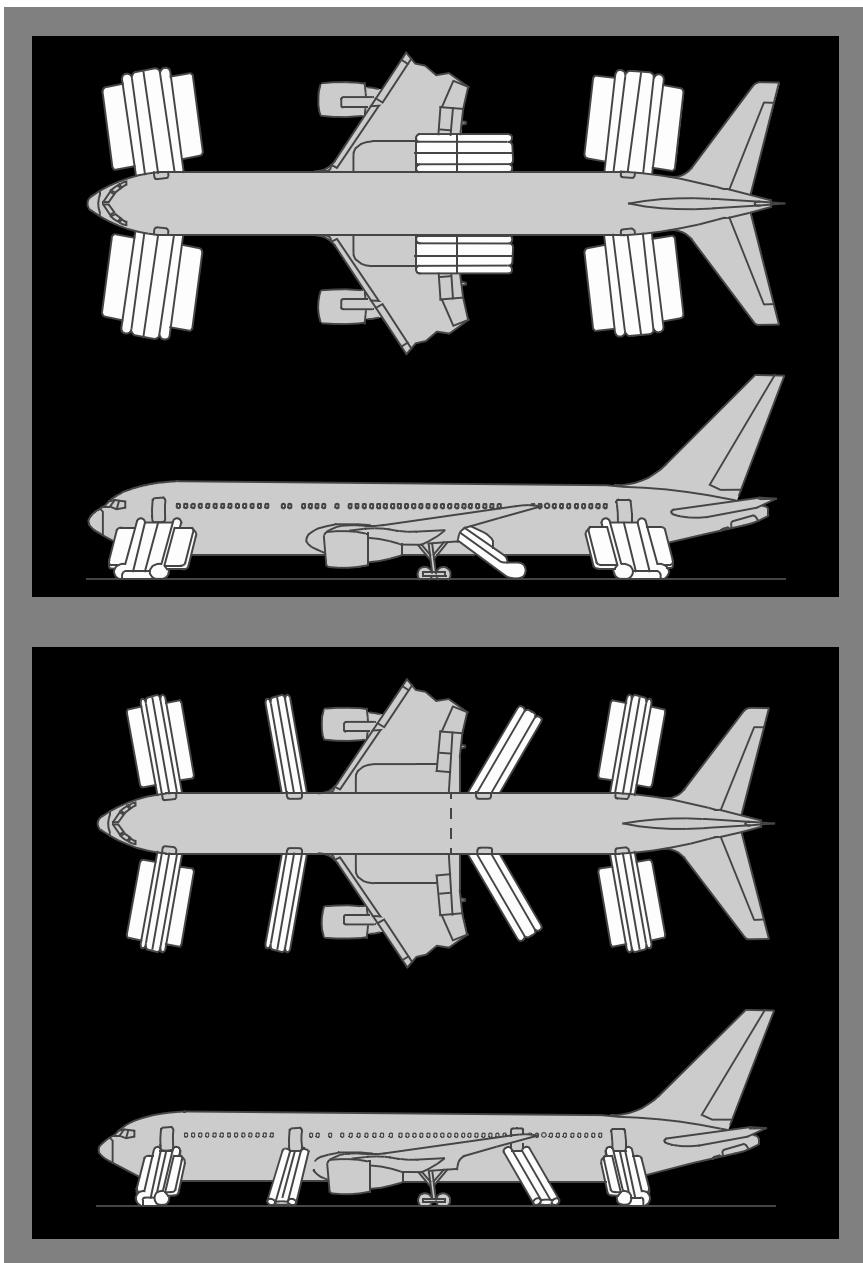

Cargo Doors

There are three cargo doors: one AFT, one BULK, and one FWD. The AFT, and FWD doors are located on the right side of the airplane and open upward and outward. The BULK cargo door is on the left side of the airplane.

Both AFT and FWD cargo doors are normally operated electrically from an exterior or interior fuselage-mounted control panel located with each door. Forward cargo door locking is accomplished manually. If necessary, the forward and aft cargo doors may be operated manually.

CAUTION: Do not operate the cargo doors with winds at the door of more than 40 knots. Do not keep the door open when wind gusts are more than 65 knots. Strong winds can cause damage to the structure of the airplane.

The CARGO DOORS light illuminates. The EICAS caution message FWD CARGO DOOR displays when the forward cargo door is not closed and latched and locked. The EICAS advisory message AFT or BULK CARGO DOOR displays when either cargo door is not closed and latched and locked. The EICAS advisory message CARGO DOORS displays if two or more of these cargo doors are not closed and latched and locked.

Flight Deck Seats

The pilot seats:

- recline
- adjust vertically
- adjust forward and aft
- adjust for thigh support
- adjust for the lumbar region of the back

The seats also have:

- adjustable armrests
- crotch straps
- inertial-reel shoulder harnesses with manual locks
- lap belts
- adjustable headrests

The seats move outboard during the last four inches of travel. Manual controls provide forward, aft, and vertical adjustment.

[Aircraft with electrical controlled pilots seat.](#)

Electrical controls provide forward, aft, and vertical adjustment.

Lumbar and thigh pad support can be adjusted using the adjustment hand wheels. Armrest pitch can be adjusted using the control knob under the armrest. The armrests can be stowed vertically for easier seat access.

Adjust the seat to obtain the optimum eye position as shown on the following illustration.

Pilot Seat Adjustment

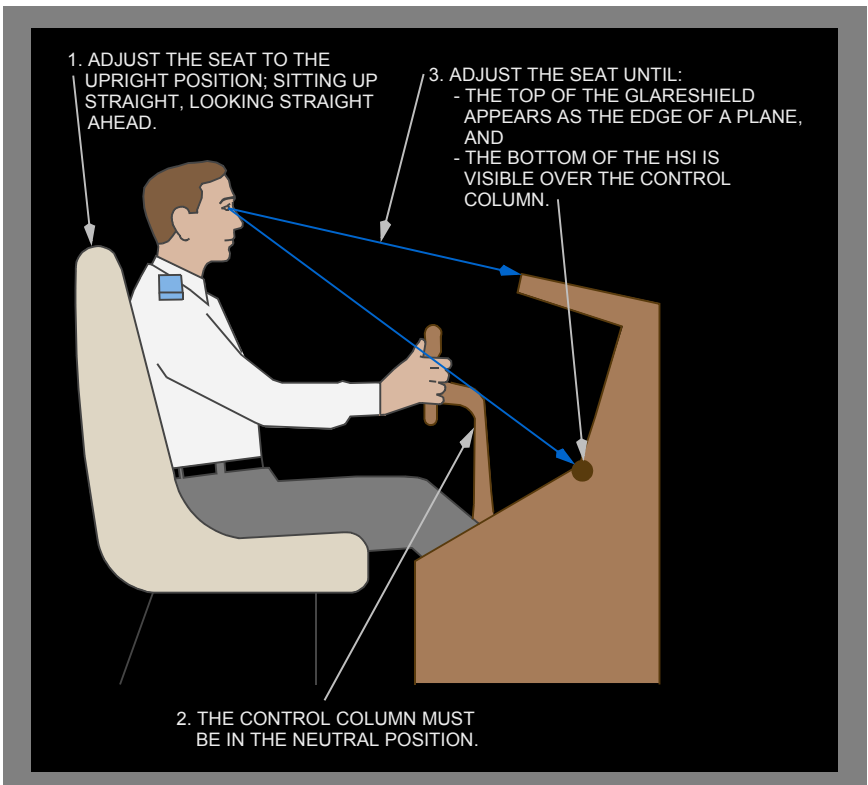

Intentionally
Blank

Introduction

This chapter describes miscellaneous airplane systems, including:

- emergency equipment
- emergency equipment locations

Emergency Equipment

Emergency equipment described in this section includes:

- fire extinguishers
- miscellaneous emergency equipment
- emergency evacuation signal system

Fire Extinguishers

Fire extinguishers are located throughout the aircraft. See emergency equipment diagram for location.

The type of fire extinguishers are as follows:

- Halon (BCF)
- Water (H₂O)

WARNING: If a fire extinguisher is to be discharged in the flight deck area, all flight crew members must wear oxygen masks and use 100% oxygen with emergency selected.

CAUTION: For electrical fires, remove the power source as soon as possible. Avoid discharging directly on persons due to possibility of suffocating effects. Do not discharge too close to fire as the discharge stream may scatter the fire. As with any fire, keep away from the fuel source. Avoid breathing vapors, fumes, and heated smoke as much as possible.

Halon Fire Extinguishers

Halon fire extinguishers contain a liquefied gas agent under pressure. The extinguisher pressure indicator shows three pressure ranges:

- acceptable
- recharge
- overcharged

A safety pin with a pull ring prevents accidental trigger movement. When released, the liquefied gas agent vaporizes and extinguishes the fire. The extinguisher is effective on all types of fires, but is used primarily on electrical, fuel, and grease fires.

Direction for use of the fire extinguisher is printed on the extinguisher.

Water (H₂O) Fire Extinguishers

Water fire extinguishers contain a solution of water mixed with anti-freeze. The container is pressurized by a CO₂ cartridge. The extinguisher should be used on fabric, paper or wood fires only.

CAUTION: Do not use on electrical or grease type fires.

To use the Water fire extinguisher, hold the extinguisher upright and rotate the handle fully clockwise. Aim the extinguisher at the base of the flame and pull the trigger.

Miscellaneous Emergency Equipment

Additional equipment is stowed at strategic locations throughout the airplane. This may include a crash axe, megaphones, flashlights and first aid kits. Life vests are stowed at each crew member station and at each passenger seat.

Emergency Locator Transmitters (ELTs)

ELTs are installed in slide/raft busters. The ELTs automatically transmit when submerged in water.

Portable ELTs may be installed in the passenger cabin, as shown in the Emergency Equipment Locations diagram.







































Escape Ropes

Escape ropes are attached to the airplane structure above both number two flight deck windows. The ropes are stowed in compartments above the pilot seats. Prior to dropping the rope out of the window, ensure the rope is attached by pulling down.

Emergency Evacuation Signal System

The emergency evacuation signal system alerts the flight attendants to evacuate the passenger cabin. Evacuation command switches are located on the flight deck and at selected flight attendant panels.

Emergency Equipment Symbols

| | | | | | | | | | | | | | | | | | | | | |
|---|---|---|---|---|---|---|---|-------------------|--------------------|---|--------------------|------------|--|--|--------------|--|--|------------|--|--|
|  |  |  |  |  | | | | | | | | | | | | | | | | |
| CO ₂ EXTINGUISHER | WATER EXTINGUISHER | HALON EXTINGUISHER | PRY BAR | FLARE KIT | | | | | | | | | | | | | | | | |
|  |  |  |  |  |  | | | | | | | | | | | | | | | |
| PORTABLE OXYGEN BOTTLE | PORTABLE OXYGEN BOTTLE WITH MASK | DUAL O ₂ GENERATOR | PORTABLE BREATHING EQUIPMENT (PBE) | SMOKE HOOD | SLIDE/RAFT SURVIVAL KIT | | | | | | | | | | | | | | | |
|  |  |  |  |  | | | | | | | | | | | | | | | | |
| EMERGENCY EXIT PATH | EXIT PATH WITH ESCAPE ROPE | EXIT PATH WITH ESCAPE SLIDE | EXIT PATH WITH ESCAPE SLIDE AND ROPE | EXIT PATH WITH SLIDE/RAFT | | | | | | | | | | | | | | | | |
|  |  |  |  |  |  |  | | | | | | | | | | | | | | |
| LIFE RAFT | ELT | LIFE VEST | PROTECTIVE GLOVES | SMOKE GOGGLES | CRASH AXE | MEGAPHONE | | | | | | | | | | | | | | |
|  |  |  |  |  |  | | | | | | | | | | | | | | | |
| BATON | HANDCUFFS | FLASHLIGHT | EMERGENCY MEDICAL KIT | FIRST AID KIT | Defibrillator | | | | | | | | | | | | | | | |
|  |  |  |  | <table border="1" style="width: 100%; border-collapse: collapse;"> <tbody> <tr> <td>A = ATTENDANT STATION</td> <td></td> <td>= CEILING STORAGE</td> </tr> <tr> <td>P = PURSER STATION</td> <td></td> <td>= OVERHEAD STORAGE</td> </tr> <tr> <td>G = GALLEY</td> <td></td> <td></td> </tr> <tr> <td>L = LAVATORY</td> <td></td> <td></td> </tr> <tr> <td>C = CLOSET</td> <td></td> <td></td> </tr> </tbody> </table> | | A = ATTENDANT STATION |  | = CEILING STORAGE | P = PURSER STATION |  | = OVERHEAD STORAGE | G = GALLEY | | | L = LAVATORY | | | C = CLOSET | | |
| A = ATTENDANT STATION |  | = CEILING STORAGE | | | | | | | | | | | | | | | | | | |
| P = PURSER STATION |  | = OVERHEAD STORAGE | | | | | | | | | | | | | | | | | | |
| G = GALLEY | | | | | | | | | | | | | | | | | | | | |
| L = LAVATORY | | | | | | | | | | | | | | | | | | | | |
| C = CLOSET | | | | | | | | | | | | | | | | | | | | |
| AIR VIVA KIT | TRACHEOTOMY MASK | RESUSCITATOR | WHEEL CHAIR | <p>NOTE: Some symbols do not apply to all configurations.</p> <p>NOTE: ("n") below symbol means quantity greater than one.</p> | | | | | | | | | | | | | | | | |

Emergency Equipment Locations

[Option-Typical Diagram with two overwing exits and four entry doors]

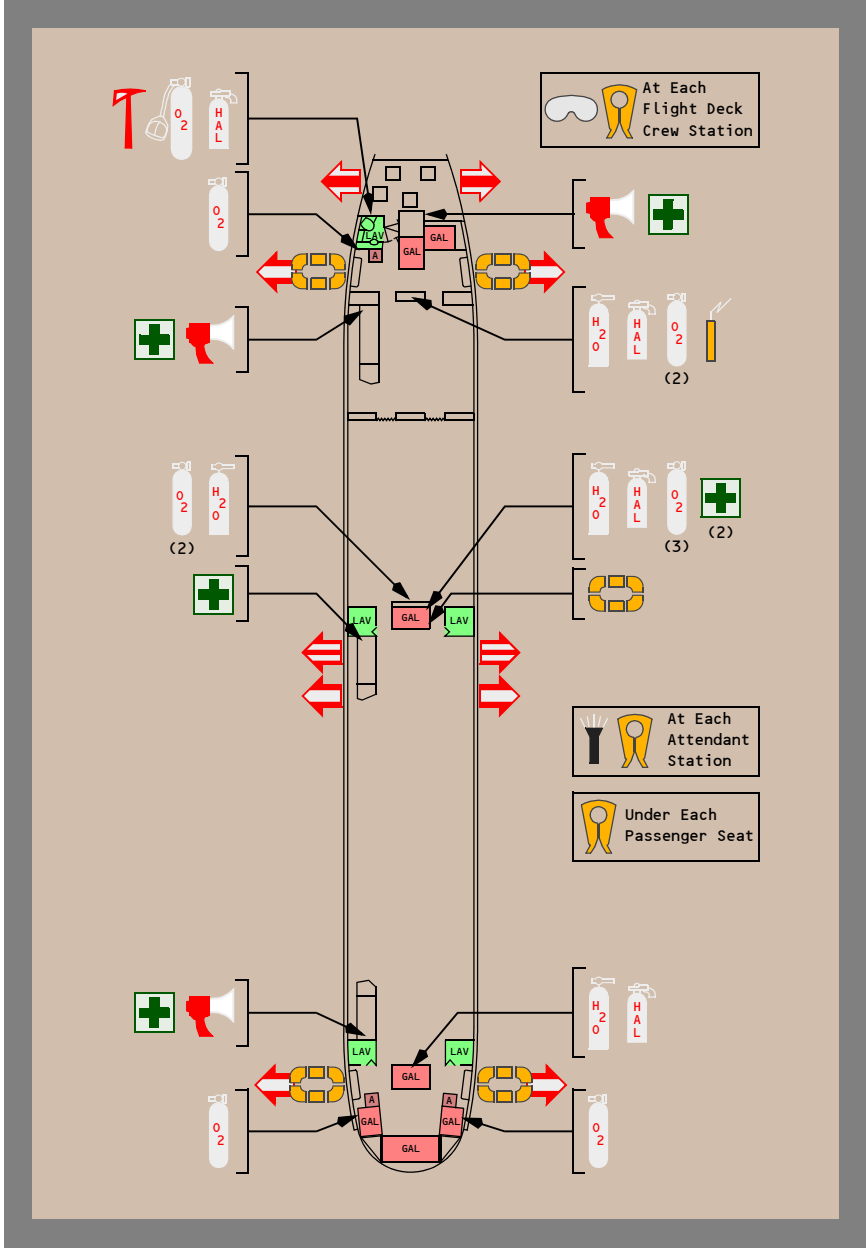

DO NOT USE FOR FLIGHT Airplane General, Emergency
Equipment, Doors, Windows -
767 Flight Crew Operations Manual Emergency Equipment

[Option-non Typical Diagram with two emergency exits and six entry doors]

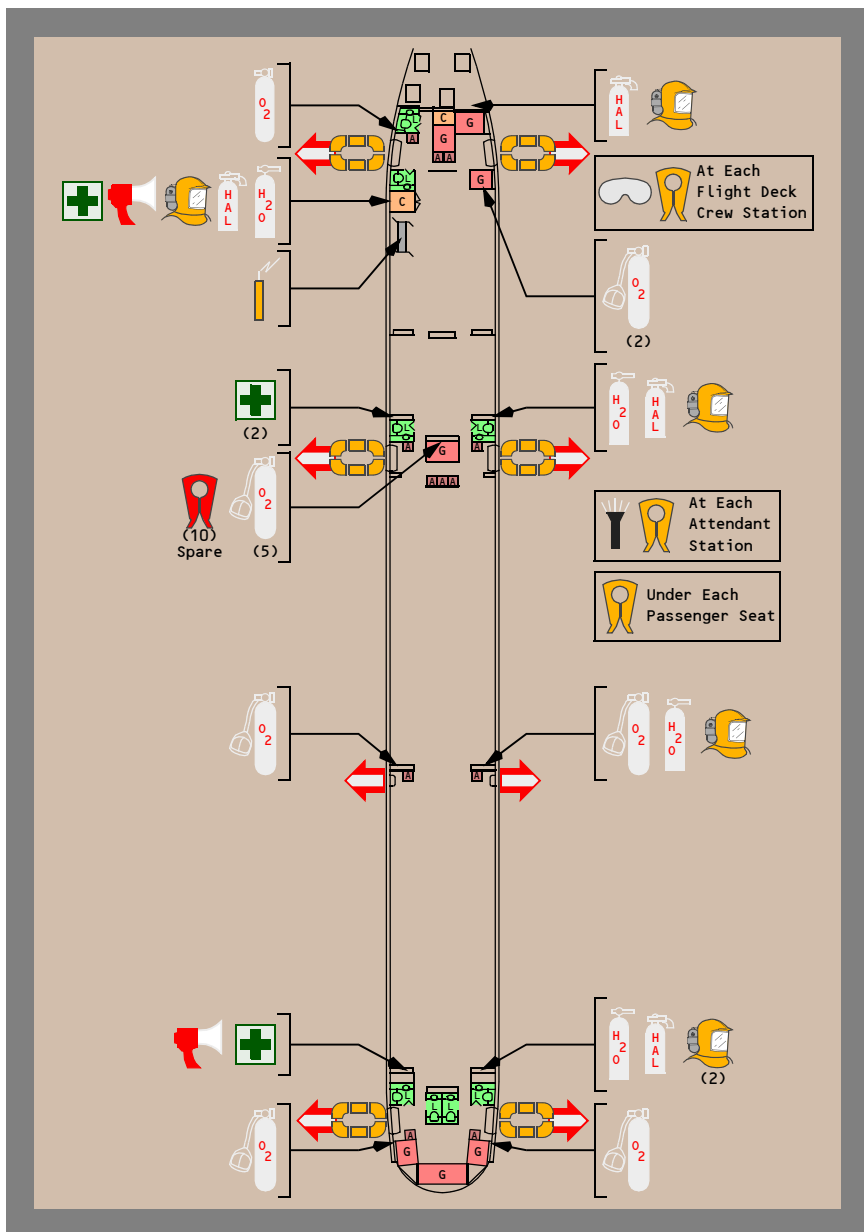

Intentionally
Blank

**Airplane General, Emergency
Equipment, Doors, Windows
EICAS Messages****Chapter 1****Section 50****Airplane General, Emergency Equipment, Doors, Windows
EICAS Messages**

The following EICAS messages may be displayed.

Access Doors

| Message | Level | Light | Aural | Condition |
|-----------------|----------|--------------|-------|--|
| ACCESS DOORS | Advisory | ACCESS DOORS | | Forward equipment bay and electrical equipment compartment access doors are not closed, latched, and locked. |
| E/E ACCESS DOOR | Advisory | ACCESS DOORS | | Electrical equipment access door is not closed, latched, and locked. |
| FWD ACCESS DOOR | Advisory | ACCESS DOORS | | The forward equipment bay access door is not closed, latched, and locked. |

Cargo Doors

| Message | Level | Light | Aural | Condition |
|-----------------|----------|-------------|-------|--|
| CARGO DOORS | Advisory | CARGO DOORS | | Two or more cargo doors are not closed, latched, and locked. |
| AFT CARGO DOOR | Advisory | CARGO DOORS | | Cargo door is not closed, latched, and locked. |
| BULK CARGO DOOR | Advisory | CARGO DOORS | | Cargo door is not closed, latched, and locked. |
| FWD CARGO DOOR | Caution | CARGO DOORS | | Cargo door is not closed, latched, and locked. |

Entry Doors

| Message | Level | Light | Aural | Condition |
|----------------------------------|----------|-------------|-------|---|
| L ENTRY DOORS R ENTRY DOORS | Advisory | ENTRY DOORS | | Two or more entry doors on the same side are not closed, latched, and locked. |
| L AFT ENT DOOR R AFT ENT DOOR | Advisory | ENTRY DOORS | | Entry door is not closed, latched, and locked. |
| L CTR ENT DOOR R CTR ENT DOOR | Advisory | ENTRY DOORS | | Entry door is not closed, latched, and locked. |
| L FWD ENT DOOR R FWD ENT DOOR | Advisory | ENTRY DOORS | | Entry door is not closed, latched, and locked. |

Emergency Exit Doors

[Option- Type 1 Emergency Exit Doors installed]

| Message | Level | Light | Aural | Condition |
|----------------------------|----------|------------|-------|--|
| EMER DOORS | Advisory | EMER DOORS | | Both emergency doors are not closed, latched, and locked |
| L EMER DOOR R EMER DOOR | Advisory | EMER DOORS | | Emergency door is not closed, latched, and locked. |

Overwing Emergency Exit Doors

[Option-Overwing Emergency Exit Doors installed]

| Message | Level | Light | Aural | Condition |
|------------------------------------|----------|------------|-------|--|
| EMER DOORS | Advisory | EMER DOORS | | Two or more emergency doors are not closed, latched, and locked (overwing emergency exit door) . |
| L AFT EMER DOOR R AFT EMER DOOR | Advisory | EMER DOORS | | An overwing emergency exit door is not closed, latched, and locked. |
| L FWD EMER DOOR R FWD EMER DOOR | Advisory | EMER DOORS | | An overwing emergency exit door is not closed, latched, and locked. |

Emergency Lights

| Message | Level | Light | Aural | Condition |
|-------------|----------|----------|-------|---|
| EMER LIGHTS | Advisory | UN-ARMED | | The emergency lights switch is not in the Armed position. |

Oxygen System

| Message | Level | Light | Aural | Condition |
|----------------|----------|-------|-------|---------------------------------------|
| PASS OXYGEN ON | Advisory | ON | | Passenger oxygen system is activated. |

Intentionally
Blank

Air Systems**Chapter 2****Table of Contents****Section 0**

| | |
|--|-------------|
| Controls and Indicators | 2.10 |
| Air Conditioning System | 2.10.1 |
| Air Conditioning Control Panel | 2.10.1 |
| Shoulder and Foot Heaters | 2.10.5 |
| Equipment Cooling Panel | 2.10.5 |
| Cargo Heating | 2.10.6 |
| Pressurization System | 2.10.9 |
| Cabin Altitude Controls | 2.10.9 |
| Cabin Altitude Indicators | 2.10.10 |
| Bleed Air System | 2.10.12 |
| Bleed Air Control Panel | 2.10.12 |
| Air Conditioning System Description | 2.20 |
| Introduction | 2.20.1 |
| Air Conditioning Packs | 2.20.1 |
| Air Conditioning Automatic Mode | 2.20.1 |
| Air Conditioning Standby Mode | 2.20.1 |
| Ground Conditioned Air Operation | 2.20.1 |
| Pack Non-Normal Operation | 2.20.2 |
| Air Distribution | 2.20.2 |
| Temperature Control | 2.20.2 |
| Temperature Control With Loss of Trim Air System | 2.20.3 |
| Gasper System | 2.20.3 |
| Air Conditioning System Schematic | 2.20.4 |
| Shoulder and Foot Heaters | 2.20.4 |
| Equipment Cooling System | 2.20.5 |
| Forward Equipment Cooling | 2.20.5 |
| Non-Normal Operation | 2.20.5 |
| Cargo Heat System | 2.20.5 |
| Normal Operation | 2.20.6 |
| Non-Normal Operation | 2.20.6 |

| | |
|---|-------------|
| Pressurization System Description | 2.30 |
| Introduction | 2.30.1 |
| Pressurization System Automatic Operation | 2.30.1 |
| Takeoff | 2.30.1 |
| Climb | 2.30.1 |
| Cruise | 2.30.1 |
| Descent and Landing | 2.30.2 |
| Non-Normal Indications | 2.30.2 |
| Bleed Air System Description | 2.40 |
| Introduction | 2.40.1 |
| Engine Bleed Air Supply | 2.40.1 |
| APU Bleed Air Supply | 2.40.2 |
| Ground Pneumatic Air Supply | 2.40.2 |
| Bleed Air Duct System | 2.40.2 |
| Bleed Air System Non-normal Operations | 2.40.2 |
| Bleed Air System Schematic | 2.40.3 |
| Air Systems EICAS Messages | 2.50 |
| Air Systems EICAS Messages | 2.50.1 |

Air Conditioning System

Air Conditioning Control Panel

[Air Conditioning Control Panel shown without the Gasper Fan Switch option.]

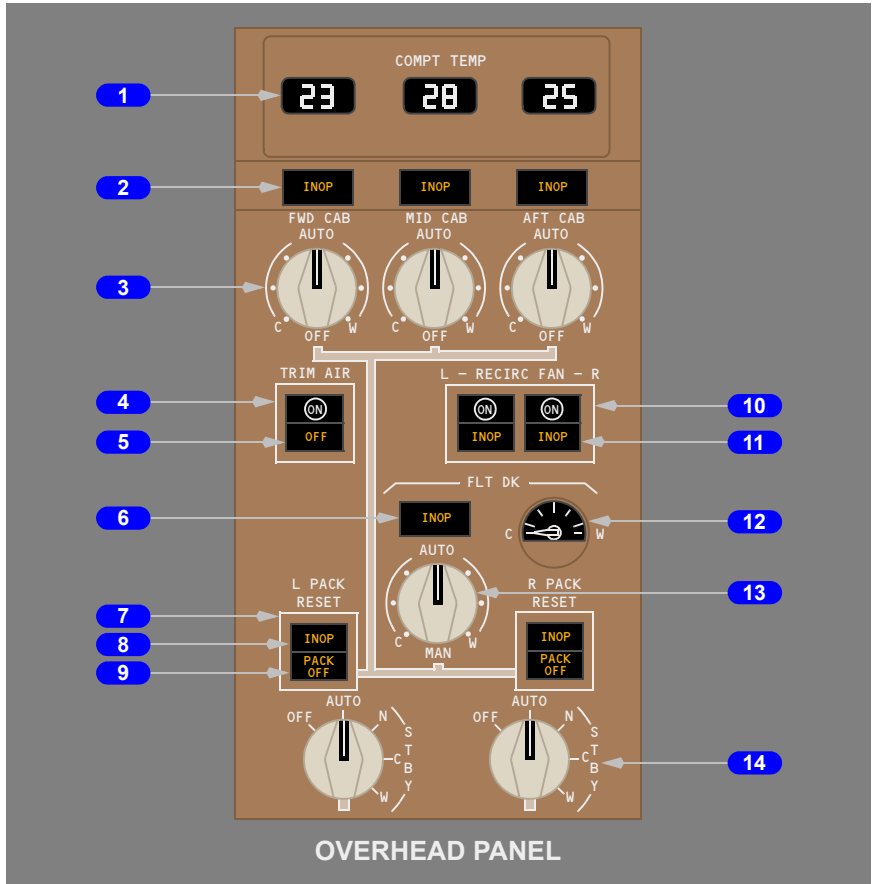

[Air Conditioning Control Panel shown with the Gasper Fan Switch option.]

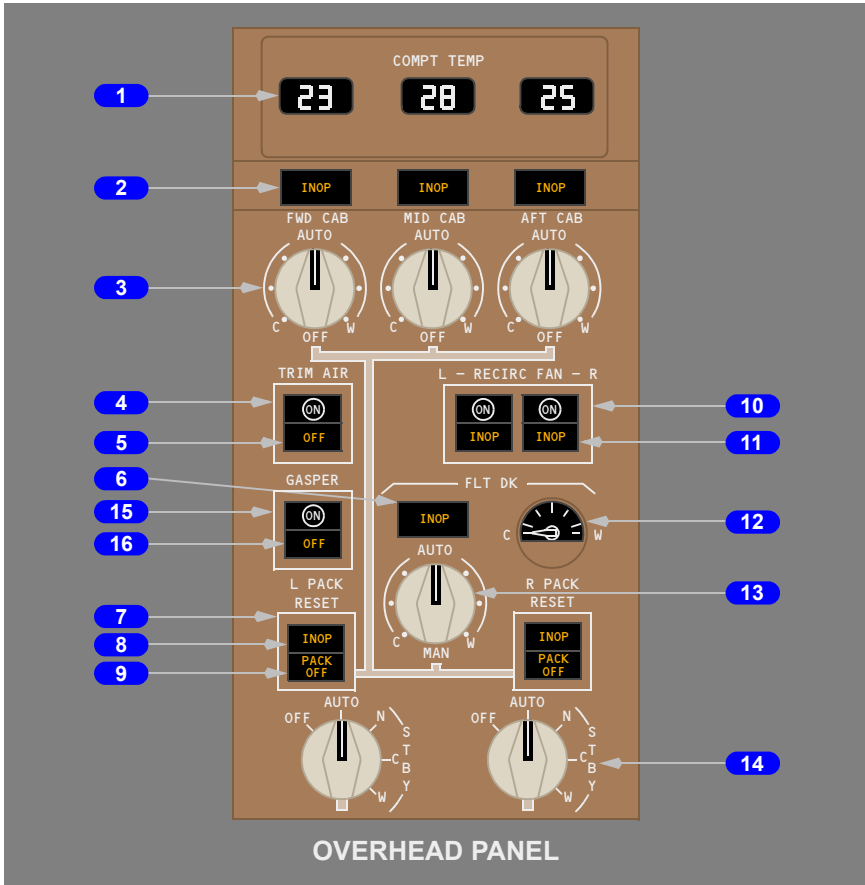

1 Compartment Temperature (COMPT TEMP) Indicators

Displays actual temperature sensed in the compartment.

2 Compartment Temperature Inoperative (INOP) Lights

Illuminated (amber) –

- fault in the zone temperature controller
- the Compartment Temperature Control is OFF
- the trim air switch is OFF.

3 Compartment Temperature Controls

AUTO –

- provides automatic compartment temperature control
- rotating the control toward C (cool) or W (warm) sets the desired temperature between 18 degrees C and 30 degrees C.

OFF –

- closes the compartment trim air valve
- the compartment temperature INOP light illuminates.

4 TRIM AIR Switch

ON – the trim air valve is commanded open.

Off (ON not visible) – the trim air valve is commanded closed.

5 Trim Air OFF Light

Illuminated (amber) – the TRIM AIR switch is off.

6 Flight Deck (FLT DK) Temperature Inoperative (INOP) Light

Illuminated (amber) –

- fault in the zone temperature controller.
- the trim air switch is OFF.

7 PACK RESET Switches

Push – resets an overheated pack if the pack has cooled to a temperature below the overheat level.

8 Pack Inoperative (INOP) Light

Illuminated (amber) –

- the pack is overheated
- fault in the automatic control system.

9 PACK OFF Lights

Illuminated (amber) – pack valve is closed.

10 Recirculation Fan (RECIRC FAN) Switches

ON – the recirculation fan operates

Off (ON not visible) – the recirculation fan does not operate.

11 Recirculation Fan Inoperative (INOP) Lights

Illuminated (amber) –

- the recirculation fan is failed or is not operating.
- the RECIRC FAN switch is off.

12 Flight Deck Trim Air Valve Position Indicator

C (cool) – valve closed.

W (warm) – valve open.

13 Flight Deck Compartment Temperature Control

AUTO –

- provides automatic flight deck temperature control
- rotating the control toward C (cool) or W (warm) sets the desired temperature between 18 degrees C and 30 degrees C.

MAN –

- provides manual control of compartment trim air valve
- spring loaded to the 6 o'clock position in this sector.

14 PACK Control Selectors

OFF – closes the pack valve.

AUTO – the pack is automatically controlled.

STBY –

- N (normal) – regulates the pack outlet temperature to a constant, moderate temperature.
- C (cool) – sets the pack to full cold operation.
- W (warm) – sets the pack to full warm operation.

15 GASPER Fan Switch

[Gasper Fan Switch and OFF light description provided when the Gasper Fan Switch option is installed.]

ON – the gasper fan is signaled on.

Off (ON not visible) – the gasper fan is signaled off.

16 Gasper Fan OFF light

Illuminated (amber) – the GASPER fan switch is ON but the gasper fan is not operating.

Shoulder and Foot Heaters

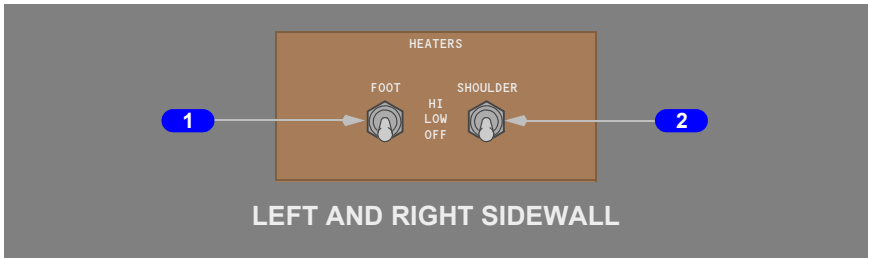

1 FOOT HEATERS Switch

HIGH – the electric heater adds heat at high setting to the conditioned air flowing to the rudder pedal area in flight only.

LOW – the electric heater adds heat at low setting to the conditioned air flowing to the rudder pedal area in flight only.

OFF – the electric heater is not operating (no heat added to the conditioned air flowing to the rudder pedal area).

2 SHOULDER HEATERS Switch

HIGH – the electric heater adds heat at high setting to the conditioned air flowing to the side window area in flight only.

LOW – the electric heater adds heat at low setting to the conditioned air flowing to the side window area in flight only.

OFF – the electric heater is not operating (no heat added to the conditioned air flowing to the side window area).

Equipment Cooling Panel

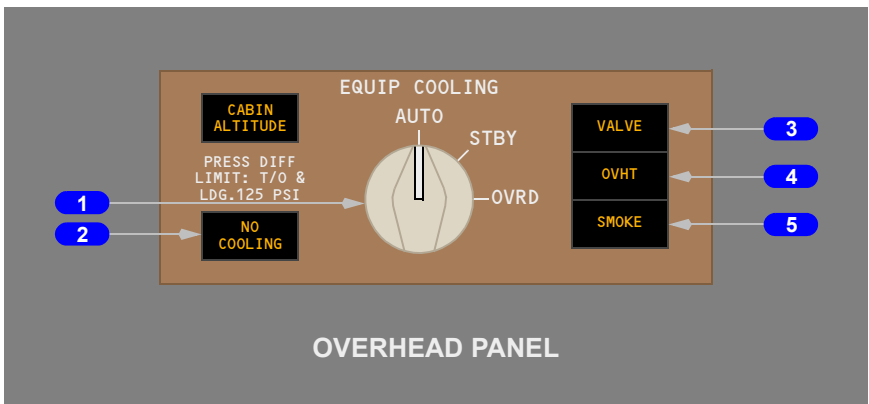

1 Equipment (EQUIP) COOLING Selector

AUTO – automatically controls equipment cooling system.

STBY – positions equipment cooling system for inboard air flow.

OVRD – positions equipment cooling system for reverse air flow.

2 NO COOLING Light

Illuminated (amber) –

- active in OVRD only
- no reverse air flow through the E/E compartment avionics.

3 VALVE Light

Illuminated (amber) – equipment cooling valves are not in their commanded position.

4 Overheat (OVHT) light

Illuminated (amber) – high temperature or low airflow in the equipment cooling system.

5 SMOKE Light

Illuminated (amber) – smoke in the equipment cooling system.

Cargo Heating

Cargo Heat Panel

[Cargo Heat Panel shown with the BULK Cargo heat option installed.]

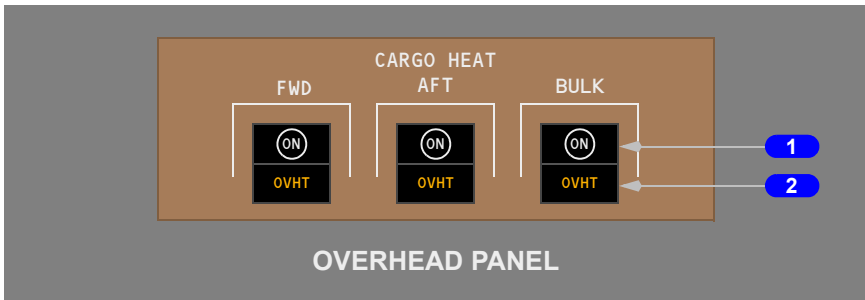

[Cargo Heat Panel shown without the BULK Cargo heat option installed.]

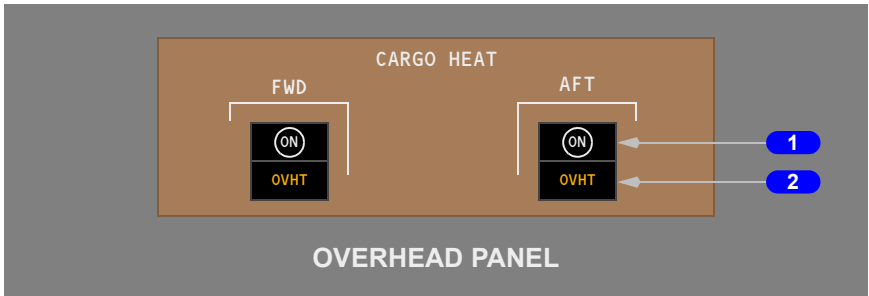

1 CARGO HEAT Switches

ON – provides power for heat valves to cycle open and closed for automatic temperature control

Off (ON not visible) – the heat valves are commanded closed

2 Cargo Heat Overheat (OVHT) Lights

Illuminated (amber) –

- cargo compartment temperature above standard control range
- shutoff valve signaled closed

Bulk Cargo Heat Panel

[Bulk Cargo Heat Panel shown with the optional NORM or VENT position selector.]

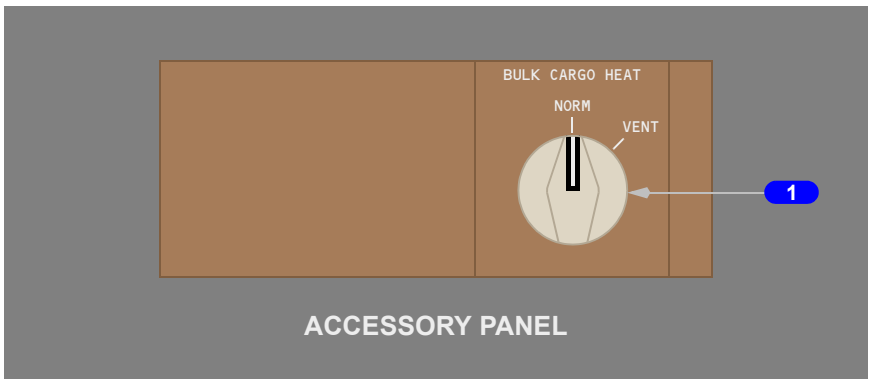

1 BULK CARGO HEAT Selector

Bulk cargo heat switch must be on

NORM – standard cargo heating range

VENT –

- requests higher temperature control range than NORM
- turns on ventilating fan for bulk cargo compartment

[Bulk Cargo Heat Panel shown with the optional CARGO or ANIMAL position selector.]

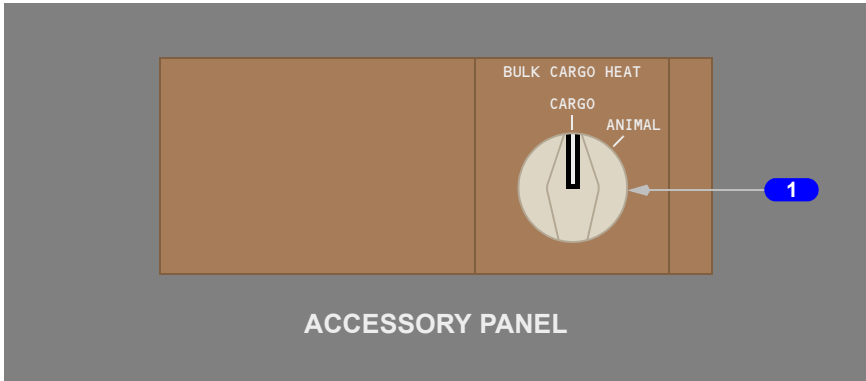

1 BULK CARGO HEAT Selector

Bulk cargo heat switch must be on

CARGO – standard cargo heating range.

ANIMAL –

- requests higher temperature control range than CARGO
- turns on ventilating fan for bulk cargo compartment.

Pressurization System

Cabin Altitude Controls

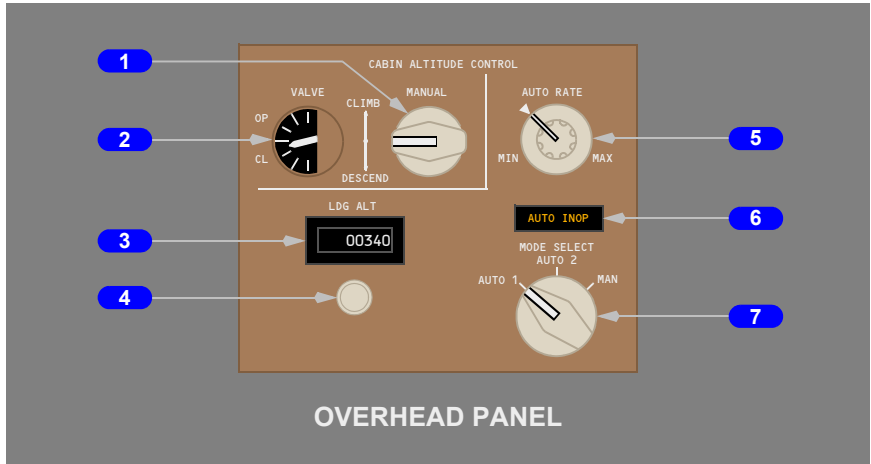

1 Cabin Altitude MANUAL Control

Spring – loaded to center.

Controls cabin outflow valve position with the Cabin Altitude Mode Selector in manual (MAN) mode.

CLIMB – moves outflow valve toward open.

DESCEND – moves outflow valve toward closed.

2 Outflow VALVE Position Indicator

OP – Open.

CL – Closed

3 Landing Altitude (LDG ALT) Indicator

Feet.

Displays selected landing altitude.

4 Landing Altitude (LDG ALT) Selector

Rotate – sets landing altitude indicator.

5 Cabin Altitude AUTO RATE Control

Rotate –

- sets limit for cabin altitude rate of climb or descent during auto control
- index mark establishes approximately 500 fpm climb and 300 fpm descent.

6 AUTO Inoperative (INOP) Light

Illuminated (amber) –

- AUTO 1 and AUTO 2 cabin altitude control functions are inoperative
- MAN mode is selected.

7 Cabin Altitude MODE SELECTOR

AUTO 1 –

- activates Auto 1 cabin altitude control for automatic operation
- outflow valve positioned automatically.

AUTO 2 –

- activates Auto 2 cabin altitude control for automatic operation
- outflow valve positioned automatically.

MAN (Manual) –

- outflow valve position is controlled by the cabin altitude MANUAL control
- AUTO INOP light illuminates.

Cabin Altitude Indicators



1 Cabin Differential Pressure Indicator

Pounds per square inch (psi).

2 Cabin Altitude

Feet x 1,000.

3 Cabin Altitude Rate

Feet per minute (fpm x 1,000).

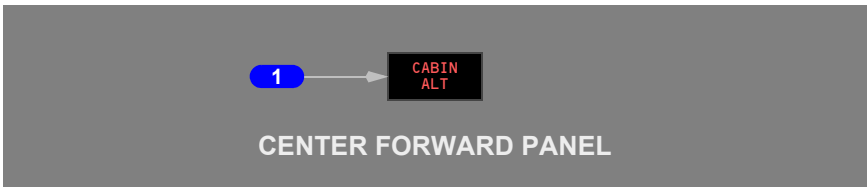
Cabin Altitude (CABIN ALT) Light**1 Cabin Altitude Light**

Illuminated (red) –

- cabin altitude exceeds 10,000 feet
- extinguishes when cabin altitude descends below 8,500 feet.

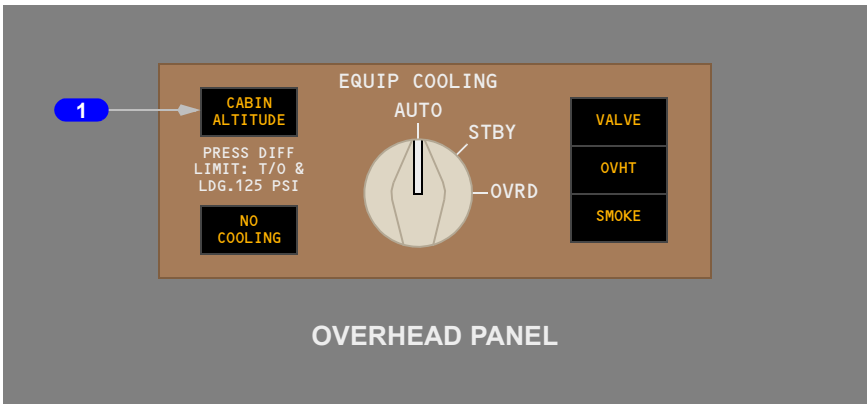
Cabin Altitude Light**1 Cabin Altitude Light**

Illuminated (red) –

- cabin altitude exceeds 10,000 feet
- extinguishes when cabin altitude descends below 8,500 feet.

Bleed Air System

Bleed Air Control Panel

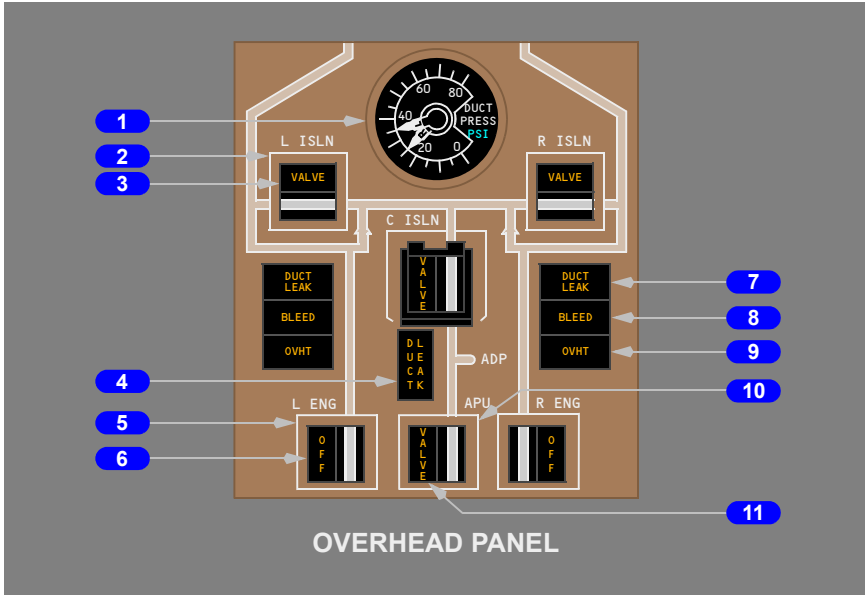

1 Duct Pressure (DUCT PRESS) Indicators

Pounds per square inch (PSI).

2 Isolation (ISLN) Switches

On (bar in view) – commands isolation valves to open.

Off (bar not in view) – commands isolation valves to close.

3 Isolation VALVE Lights

Illuminated (amber) – isolation valve position disagrees with commanded position.

4 DUCT LEAK Light

Illuminated (amber) – a high temperature bleed air leak is detected in the center pneumatic duct.

5 Engine (ENG) Bleed Air Switches

On (bar in view) – the engine bleed air valve opens when engine bleed air is available.

Off (bar not in view) – valve is manually commanded closed.

6 Engine Bleed Air OFF Lights

Illuminated (amber) – engine bleed air valve is closed:

- automatically due to a system fault
- the switch is OFF
- the engine is not running.

7 DUCT LEAK Lights

Illuminated (amber) – a high temperature bleed air leak is detected in the left, right, or engine strut pneumatic duct.

8 Engine BLEED Lights

Illuminated (amber) – the engine high pressure bleed air valve and/or pressure regulating valves are open when they should be closed.

9 Engine Bleed Air Overheat (OVHT) Lights

Illuminated (amber) –

- engine bleed air overtemp
- engine bleed valves automatically closed.

10 APU Bleed Air Switch

On (bar in view) – the APU bleed air valve is automatically controlled

Off (bar not in view) – commands APU bleed air valve to close.

11 APU Bleed Air VALVE Light

Illuminated (amber) – APU bleed air valve position disagrees with commanded position.

Intentionally
Blank

Introduction

The air conditioning system supplies conditioned bleed air and recirculated cabin air at a controlled temperature throughout the airplane.

The system supplies conditioned air to the flight deck shoulder heaters.

The system supplies ventilation for the cabin:

- lavatories
- galleys.

Pack control, zone temperature control, cabin air recirculation, fault detection, and overheat protection are all automatic.

The airplane is divided into four temperature zones: the flight deck and three cabin zones.

Air Conditioning Packs

Two identical air conditioning packs cool bleed air from the engines, APU, or high pressure air from a ground source. Bleed air is precooled before entering the pack. The packs are controlled by two identical pack controllers. Pack output is automatically increased during high pack demand periods to compensate for a failed pack or recirculation fan. This increase in pack output is inhibited during high bleed air demand periods (such as with an engine inoperative).

Air Conditioning Automatic Mode

With the pack selector in the AUTO position, pack output temperature is determined by the left and right cabin temperature controllers:

Air Conditioning Standby Mode

With the pack selector in the standby mode, pack output temperature is determined by the position of the pack selector:

- N (normal) - constant, moderate temperature
- C (cool) - full cold
- W (warm) - full warm.

Ground Conditioned Air Operation

When a ground source of conditioned air is available, it may be used to supply conditioned air directly to the cabin distribution system, eliminating the need for pack operation.

Pack Non–Normal Operation

Pack control, fault detection, and overheat protection are all automatic.

The pack INOP light illuminates and the EICAS advisory message L or R PACK TEMP displays for all pack control system faults and overheats.

When an automatic control system fault or a pack outlet overheat is detected, the pack continues to operate in an uncontrolled, degraded condition, requiring crew interaction.

The pack valve closes and the pack is shut down automatically when an internal pack overheat is detected. The PACK OFF light illuminates and the EICAS advisory message L or R PACK OFF displays in addition to the PACK TEMP indications.

If the INOP light remains illuminated after selecting STBY, the fault is a pack overheat. After the pack has cooled, an attempt to restore pack operation may be made by pushing the PACK RESET switch.

Air Distribution

Conditioned air from the packs flows into a mix manifold where it mixes with air from two recirculation fans. Recirculation fans maintain overall cabin air circulation while allowing a reduction of cabin air ventilation, permitting the packs to be operated at a reduced flow. The mixed air is then ducted into the cabin.

The recirculation fans may be turned off for several minutes to provide a more rapid exchange of air.

The recirculation fan INOP light illuminates and the EICAS advisory message L or R RECIR FAN displays whenever a recirculation fan fails or is not operating. A slight increase in fuel consumption occurs for each fan that is OFF.

Temperature Control

The airplane is divided into four temperature control zones:

- flight deck
- forward cabin
- mid cabin
- aft cabin.

The pack controllers regulate the pack output air temperature to satisfy the temperature requirement of the compartment requiring the coolest air. Hot trim air from the bleed air system is added through trim air valves to control the temperature in each of the other compartments. Each temperature control compartment has an associated temperature control.

A compartment INOP light illuminates, and the EICAS advisory message FLT DECK TEMP, FWD CABIN TEMP, MID CABIN TEMP, or AFT CABIN TEMP displays to indicate:

- zone temperature controller failure
- trim air switch is OFF
- compartment temperature control is in the OFF position (FWD, MID, and AFT CAB only).

Temperature Control With Loss of Trim Air System

During operation with the trim air system off, the packs attempt to maintain all compartments at an average temperature. The trim air OFF light illuminates and the EICAS advisory message TRIM AIR displays when a TRIM AIR switch is off.

Gasper System

[Gasper System description included when the Gasper Fan Switch option is installed.]

The gasper system draws air from the forward cabin overhead air conditioning ducts and discharges it from gasper outlets in the passenger service units located above each passenger seat. Gasper air is controlled by the GASPER fan switch.

Air Conditioning System Schematic

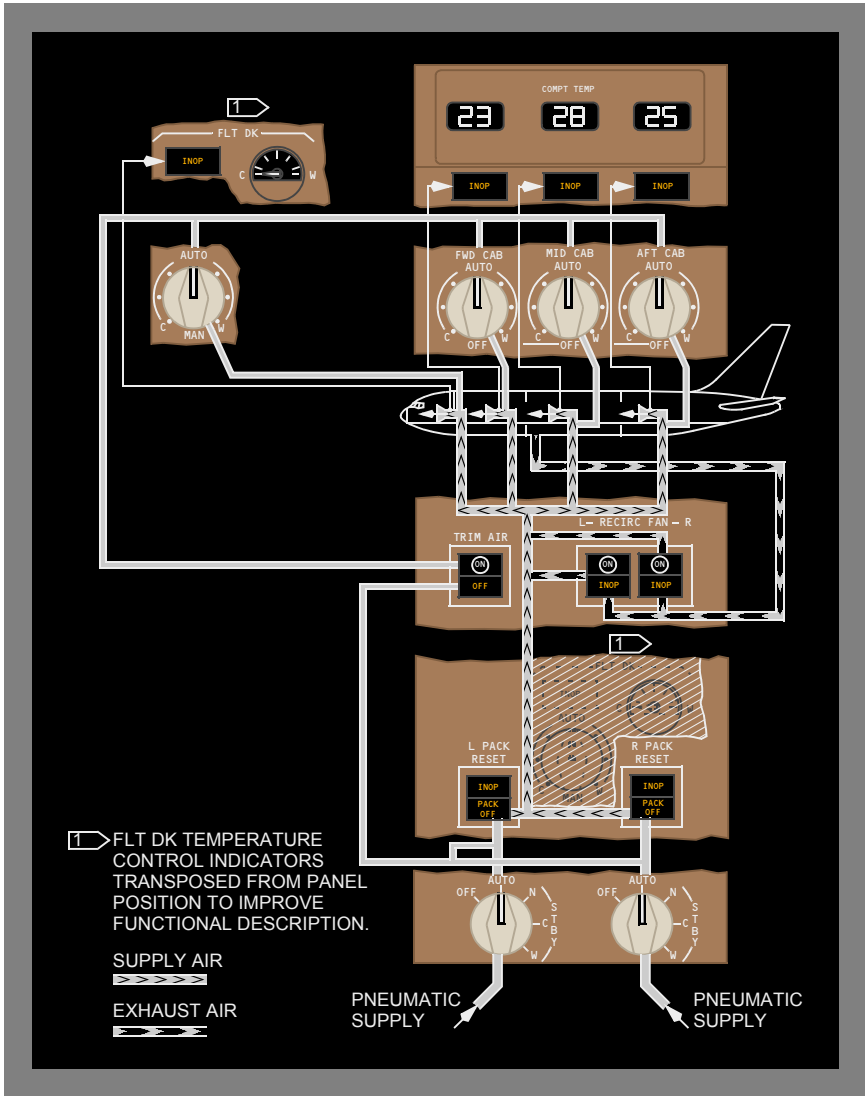

Shoulder and Foot Heaters

Flight crew shoulder and foot heat is provided by electric heaters in the ducts that supply conditioned air to the side windows and rudder pedal areas respectively. The heaters operate in flight only.

Equipment Cooling System

Forward Equipment Cooling

The forward equipment cooling system supplies cooling air to equipment in the forward electronic equipment racks and the flight deck avionics.

System operation is automatic with the EQUIP COOLING selector in AUTO.

On the ground, engine operation, pack operation, air/ground logic, airplane skin temperature and ambient temperature are all factors that determine system configuration. A supply fan and an exhaust fan either recirculate the cooling air back through the system, or port it overboard.

In flight, only the exhaust fan operates, and the air is recirculated through the system.

Non-Normal Operation

The VALVE light illuminates and the EICAS advisory message FWD EQPT VAL displays if the system valves fail to reconfigure during automatic operation. Placing the EQUIP COOLING selector in STBY provides an alternate command to reconfigure the system for recirculating the cooling air back through the system,.

The OVHT light illuminates and the EICAS advisory message FWD EQPT OVHT displays if low airflow or high temperature is sensed. Placing the EQUIP COOLING selector in STBY may correct the condition by reconfiguring the system.

The SMOKE light illuminates and the EICAS advisory message FWD EQPT SMOKE displays if smoke is sensed in the forward equipment cooling ducts. Placing the EQUIP COOLING selector in OVRD allows conditioned air to be drawn in reverse through the system by differential pressure and exhausted overboard.

The NO COOLING light illuminates and the EICAS caution message FWD EQPT COOLING displays if no cooling airflow is sensed after selecting OVRD.

Cargo Heat System

The forward and aft cargo compartments are provided heat from the bleed air system.

The forward, aft, and bulk cargo compartments are provided heat from the bleed air system.

Normal Operation

Separate switches control a shutoff valve and a heat control valve in each compartment. The system automatically maintains compartment temperature above approximately 45°F (7°C).

Bulk Cargo Heat Selector

[When the Bulk Cargo Heat option is installed, the Bulk Cargo Heat Panel will contain either the NORM/VENT selector switch or the CARGO/ANIMAL selector switch.]

A BULK CARGO HEAT selector allows a higher temperature to be selected for the bulk compartment. With the selector in the NORM position, the bulk compartment operates the same as the forward and aft compartments. With the selector in the VENT position, the bulk compartment is maintained above approximately 65°F (18°C), and a vent fan draws cabin discharge air into the compartment.

A BULK CARGO HEAT selector allows a higher temperature to be selected for the bulk compartment. With the selector in the CARGO position, the bulk compartment operates the same as the forward and aft compartments. With the selector in the ANIMAL position, the bulk compartment is maintained above approximately 65°F (18°C), and a vent fan draws cabin discharge air into the compartment.

Non-Normal Operation

[This paragraph applies to aircraft without the Bulk Cargo Heat option.]

The cargo heat switch OVHT light illuminates, and the EICAS advisory message FWD or AFT CARGO OVHT displays when the cargo compartment temperature is above the standard control range. The compartment shutoff valve closes automatically if a compartment temperature exceeds approximately 90°F (32°C). When the compartment temperature decreases below the overheat temperature setting, the OVHT light extinguishes, the EICAS message is removed, and the compartment shutoff valve re-opens.

[This paragraph applies to aircraft with the Bulk Cargo Heat option.]

The cargo heat switch OVHT light illuminates and the EICAS advisory message FWD, AFT or BULK CARGO OVHT displays when the cargo compartment temperature is above the standard control range. The compartment shutoff valve closes automatically if a compartment temperature exceeds approximately 90°F (32°C). When the compartment temperature decreases below the overheat temperature setting, the OVHT light extinguishes, the EICAS message is removed, and the compartment shutoff valve re-opens.

Introduction

Cabin pressurization is controlled by adjusting the discharge of conditioned cabin air through the outflow valve.

Positive pressure relief valves and negative pressure relief doors protect the fuselage against excessive pressure differential.

The pressurization system has automatic and manual operating modes.

Pressurization System Automatic Operation

The pressurization system is in the automatic mode when the cabin altitude mode selector is set to AUTO 1 or AUTO 2. If the selected auto mode fails, control is automatically switched to the other auto mode.

In the automatic mode, the pressurization system uses ambient pressure data from the air data system in conjunction with the selected cabin auto rate, the takeoff altitude and the indicated landing altitude to calculate the cabin pressurization schedule.

Takeoff

For takeoff, the system supplies a small positive pressurization to cause a smooth cabin altitude transition.

Climb

During climb, cabin altitude increases on a schedule related to the takeoff field elevation, airplane altitude, and the selected auto climb rate limit.

If the maximum cabin pressure differential is reached, cabin climb rate becomes a function of airplane climb rate, while maintaining the maximum differential pressure.

Cruise

Shortly after the airplane levels off, the system enters the cruise mode. The landing altitude and the scheduled cabin altitude are compared and the higher of these two is selected for the cruise cabin altitude. If necessary, the cabin climbs to the cruise cabin altitude at one-half the auto rate or descends to the cruise cabin altitude at the auto rate.

The cruise cabin altitude does not change for minor altitude variations. A significant altitude change causes the system to re-enter the climb mode or to enter the descent mode.

Descent and Landing

During descent, cabin altitude decreases to slightly below the selected landing altitude. This ensures that the airplane lands pressurized. Landing altitude barometric pressure correction comes from the captain's altimeter.

At touchdown, the outflow valve opens to depressurize the airplane.

Non-Normal Indications

If the cabin altitude climbs above 10,000 feet, the CABIN ALT and CABIN ALTITUDE lights illuminate and the EICAS warning message CABIN ALTITUDE displays. The lights extinguish and the EICAS message blanks when the cabin altitude descends below 8,500 feet.

The AUTO INOP light illuminates and the EICAS caution message CABIN AUTO INOP displays when automatic pressurization control fails or when cabin altitude MODE SELECT is MAN. Manual operation is required if the automatic system fails.

Only the automatic mode is equipped with an aneroid switch that automatically closes the outflow valve when the cabin exceeds 11,000 feet. The manual mode has no auto closure feature.

To operate the pressurization system manually:

- set the cabin altitude MODE SELECT to MAN
- hold the cabin altitude MANUAL control to CLIMB to move the outflow valve toward open and cause the cabin altitude to climb
- hold the cabin altitude MANUAL control to DESCEND to move the outflow valve toward closed and cause the cabin altitude to descend.

Introduction

Bleed air can be supplied by the engines, APU, or a ground air source.

Bleed air is used for:

- air conditioning
- pressurization
- engine start
- wing and engine anti-ice
- center hydraulic system air driven pump (ADP)
- hydraulic reservoir pressurization

When the aircraft is equipped with GE 80C2 engines.

- thrust reversers

Engine Bleed Air Supply

Engine bleed air comes from either the high pressure (HP) or the low pressure (LP) engine compressor sections. LP air is used during high power setting operations. HP air is used during descent and other low power setting operations.

The engine bleed air valves are armed when the engine bleed switches are selected ON. The valves are pressure actuated and remain closed until engine bleed air pressure is sufficient to cause forward flow. The valves may close when the APU is starting either engine. The valves may close when ground pneumatic air is connected or during periods of low engine bleed air demand, such as when the air conditioning packs are off.

The engine bleed air OFF light illuminates and the EICAS advisory message L or R ENG BLEED OFF displays when the engine bleed air valve is closed for a system fault.

The OVHT light illuminates and the EICAS advisory message L or R ENG BLD OVHT displays when the engine bleed air temperature is excessive.

The BLEED light illuminates and the EICAS advisory message L or R ENG HPSOV displays when the engine high pressure bleed air valve is open when commanded closed.

The BLEED light illuminates and the EICAS advisory message L or R ENG PRV displays when the pressure regulating valve is open when commanded closed.

APU Bleed Air Supply

APU bleed air is used primarily during ground operations for air conditioning pack operation and engine starting. In flight, APU bleed air is available up to approximately 17,000 feet.

The check valve in the APU supply line prevents reverse flow of bleed air from the duct into the APU.

The VALVE light illuminates and the EICAS advisory message APU BLEED VAL displays when the APU bleed valve position disagrees with the commanded position.

Ground Pneumatic Air Supply

External connectors are provided to connect a ground source of high pressure air directly to the bleed air duct.

Check valves prevent reverse flow of bleed air from the bleed air duct to the connectors.

Bleed Air Duct System

The duct pressure indicator displays the pressure in the left and right bleed air ducts.

Isolation valves separate the bleed air ducts into isolated segments. The left and right isolation valves are normally closed except for engine start or single bleed source operation. The center isolation valve normally remains open.

The isolation VALVE lights illuminate and the EICAS advisory message C, L or R BLD ISLN VAL displays when the bleed isolation valve position disagrees with the commanded position.

The DUCT LEAK light illuminates and the EICAS caution message L or R BLD DUCT LEAK, BODY DUCT LEAK or STRUT DCT LEAK displays when a high temperature bleed air leak is detected.

Bleed Air System Non-normal Operations

Bleed air overheat protection is provided by a bleed air temperature sensor. A higher than normal temperature causes a L or R ENG BLD OVHT advisory message to appear and the engine bleed air OVHT light to illuminate. If a bleed overheat occurs, the engine bleed air valve is automatically closed. With the engine bleed air valve closed, the HPSOV and PRV are closed. Activation of engine anti-ice will cause the PRV to open to provide cowl anti-ice unless a strut duct leak exists.

Bleed Air System Schematic

When the aircraft is equipped with GE 80C2 engines.

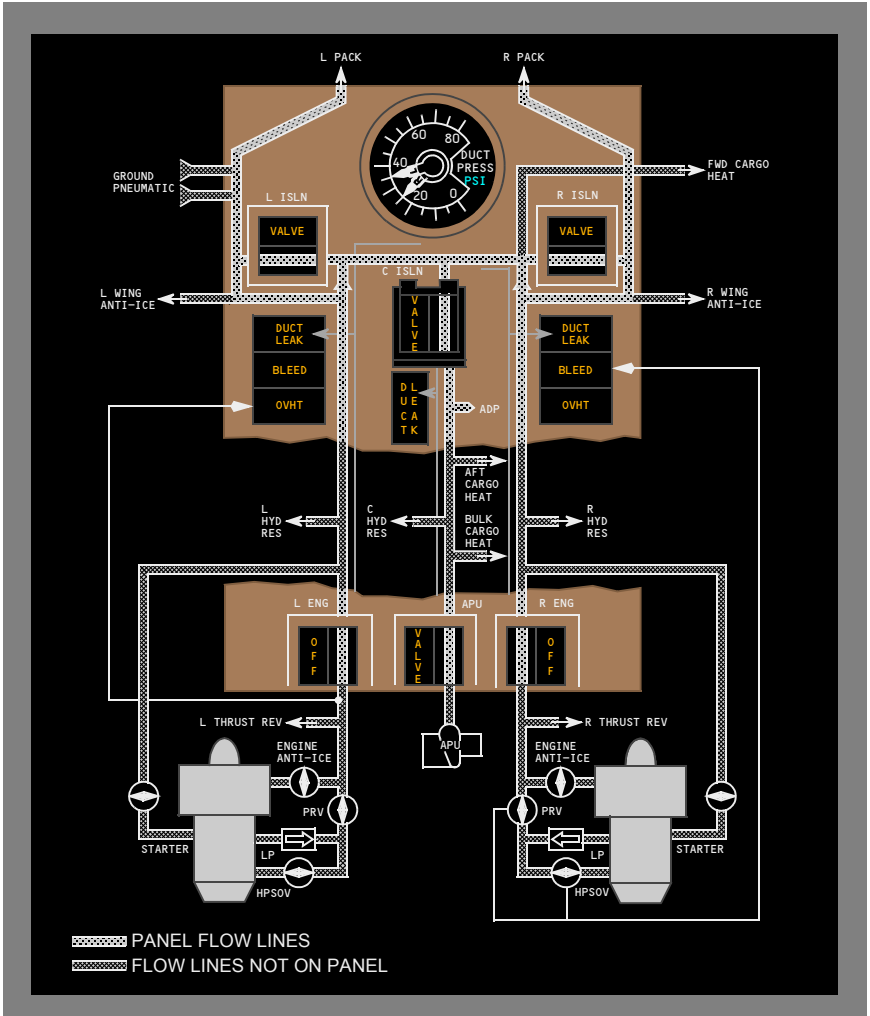

When the aircraft is equipped with PW4000 engines.

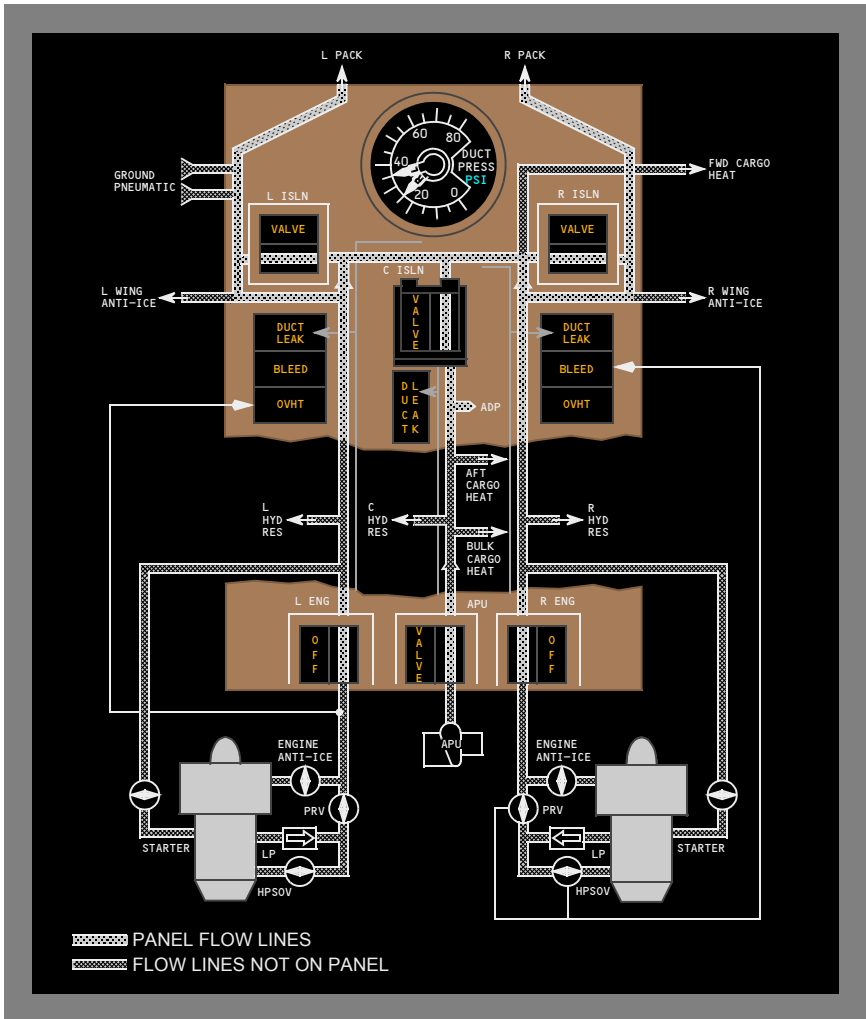

Air Systems EICAS Messages

The following EICAS messages can be displayed.

| Message | Level | Light | Aural | Condition |
|--|--------------|------------------------------------|--------------|---|
| APU BLEED VAL | Advisory | VALVE | | APU bleed valve position disagrees with the commanded position. |
| L BLD DUCT LEAK R BLD DUCT LEAK BODY DUCT LEAK | Caution | DUCT LEAK | Beeper | A high temperature bleed air leak is detected. |
| C BLD ISLN VAL L BLD ISLN VAL R BLD ISLN VAL | Advisory | VALVE | | Bleed isolation valve position disagrees with the commanded position. |
| CABIN ALTITUDE | Warning | CABIN ALTITUDE, CABIN ALT | Siren | Cabin altitude excessive. |
| CABIN AUTO INOP | Caution | AUTO INOP | Beeper | Automatic pressurization control has failed or the cabin altitude mode selector is in manual. |
| AFT CABIN TEMP FWD CABIN TEMP MID CABIN TEMP | Advisory | INOP | | A fault in the zone temperature controller, compartment temperature control is in the OFF position, or trim air switch OFF. |

[This EICAS message applies to aircraft with the Bulk Cargo Heat option.]

| | | | | |
|--|----------|------|--|---|
| AFT CARGO OVHT BULK CARGO OVHT FWD CARGO OVHT | Advisory | OVHT | | Cargo compartment temperature above standard control range. |
|--|----------|------|--|---|

| Message | Level | Light | Aural | Condition |
|---------|-------|-------|-------|-----------|
|---------|-------|-------|-------|-----------|

[This EICAS message applies to aircraft without the Bulk Cargo Heat option.]

| | | | | |
|----------------------------------|----------|------|--|---|
| AFT CARGO OVHT FWD CARGO OVHT | Advisory | OVHT | | Cargo compartment temperature above standard control range. |
|----------------------------------|----------|------|--|---|

| | | | | |
|------------------------------------|----------|-----|--|--|
| L ENG BLEED OFF R ENG BLEED OFF | Advisory | OFF | | Engine bleed air valve is closed for a system fault. |
|------------------------------------|----------|-----|--|--|

| | | | | |
|----------------------------------|----------|------|--|--|
| L ENG BLD OVHT R ENG BLD OVHT | Advisory | OVHT | | Engine bleed air temperature is excessive. |
|----------------------------------|----------|------|--|--|

| | | | | |
|----------------------------|----------|-------|--|--|
| L ENG HPSOV R ENG HPSOV | Advisory | BLEED | | High pressure bleed air valve is open when commanded closed. |
|----------------------------|----------|-------|--|--|

| | | | | |
|------------------------|----------|-------|--|--|
| L ENG PRV R ENG PRV | Advisory | BLEED | | Pressure regulating valve is open when commanded closed. |
|------------------------|----------|-------|--|--|

| | | | | |
|------------------|---------|------------|--------|---|
| FWD EQPT COOLING | Caution | NO COOLING | Beeper | OVRD selected and no reverse airflow detected through the E/E compartment avionics. |
|------------------|---------|------------|--------|---|

| | | | | |
|---------------|----------|------|---------------------------------|--|
| FWD EQPT OVHT | Advisory | OVHT | Ground crew call horn on ground | High temperature or low airflow in equipment cooling system. |
|---------------|----------|------|---------------------------------|--|

| | | | | |
|----------------|----------|-------|--|--|
| FWD EQPT SMOKE | Advisory | SMOKE | | Smoke detected in the forward equipment cooling ducts. |
|----------------|----------|-------|--|--|

| | | | | |
|--------------|----------|-------|--|---|
| FWD EQPT VAL | Advisory | VALVE | | An equipment cooling valve not in commanded position. |
|--------------|----------|-------|--|---|

| | | | | |
|---------------|----------|------|--|--|
| FLT DECK TEMP | Advisory | INOP | | A fault in the zone temperature controller or trim air switch OFF. |
|---------------|----------|------|--|--|

| | | | | |
|--------------------------|----------|----------|--|-----------------------|
| L PACK OFF R PACK OFF | Advisory | PACK OFF | | Pack valve is closed. |
|--------------------------|----------|----------|--|-----------------------|

| | | | | |
|----------------------------|----------|------|--|---|
| L PACK TEMP R PACK TEMP | Advisory | INOP | | Automatic control system fault or overheat. |
|----------------------------|----------|------|--|---|

767 Flight Crew Operations Manual

| Message | Level | Light | Aural | Condition |
|--|--------------|--------------|--------------|--|
| L RECIR FAN R RECIR FAN | Advisory | INOP | | Fan is failed or not operating. |
| L STRUT DCT LEAK R STRUT DCT LEAK | Caution | DUCT LEAK | Beeper | A high temperature bleed air leak is detected. |
| TRIM AIR | Advisory | OFF | | Trim air switch OFF. |

Intentionally
Blank

Controls and Indicators 3.10

 Manual Anti-Ice Panel 3.10.1

 Window Heat and Wiper Panels 3.10.2

 Window Heat Panel 3.10.2

 Wiper Panel 3.10.2

 Probe Heat Lights. 3.10.3

System Description 3.20

 Introduction 3.20.1

 Engine Anti-Ice System. 3.20.1

 Wing Anti-Ice System 3.20.1

 Manual Anti-Ice System Operation 3.20.2

 Engine Anti-Ice Operation 3.20.2

 Wing Anti-Ice Operation 3.20.2

 Anti-Ice System Schematic 3.20.3

 Flight Deck Window Heat 3.20.3

 Windshield Wipers. 3.20.4

 Probe Heat 3.20.4

EICAS Messages. 3.30

 Anti-Ice EICAS Messages. 3.30.1

Intentionally
Blank

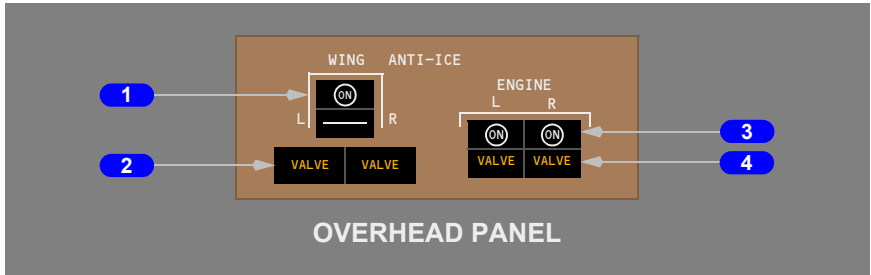
Manual Anti-Ice Panel**1 WING ANTI-ICE Switch**

ON – in flight, both wing anti-ice valves are commanded open.

Off (ON not visible) – both wing anti-ice valves are commanded closed.

2 Wing Anti-Ice VALVE Lights

Illuminated (amber) – wing anti-ice valve position disagrees with the switch position.

3 ENGINE ANTI-ICE Switches

ON – the engine anti-ice valve is commanded open.

Off (ON not visible) – the engine anti-ice valve is commanded closed.

4 Engine Anti-Ice VALVE Lights

Illuminated (amber) – engine anti-ice valve position disagrees with the switch position.

Window Heat and Wiper Panels

Window Heat Panel

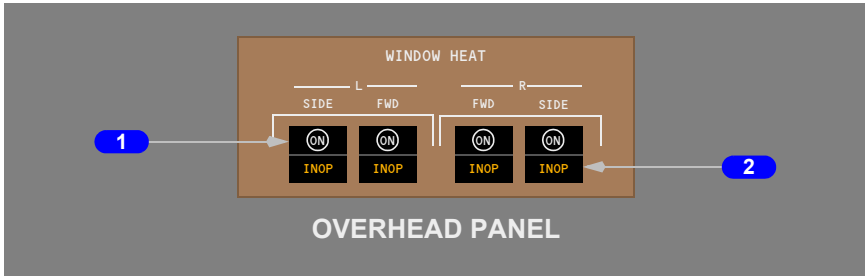

1 WINDOW HEAT Switches

ON – window heat is applied to the selected windows.

Off (ON not visible) – window heat is removed from the selected windows

2 Window Heat Inoperative (INOP) Lights

Illuminated (amber) – the window is not being heated.

Wiper Panel

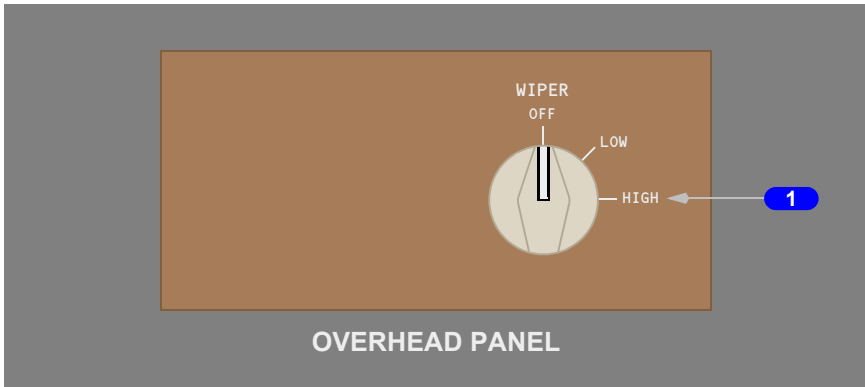

1 WIPER Selector

OFF – the wipers are stowed at the base of the windows.

LOW – the wipers operate at low speed.

HIGH – the wipers operate at high speed.

Probe Heat Lights

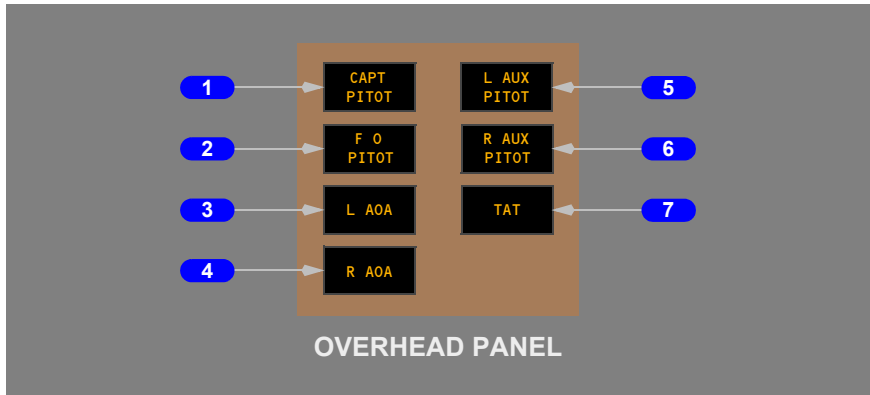

1 Captain Pitot (CAPT PITOT) Light

Illuminated (amber) – probe is not being heated in flight or neither engine is running on the ground.

2 First Officer Pitot (F O PITOT) Light

Illuminated (amber) – probe is not being heated in flight or neither engine is running on the ground.

3 Left Angle of Attack (L AOA) Probe Light

Illuminated (amber) – probe is not being heated in flight or neither engine is running on the ground.

4 Right Angle of Attack (R AOA) Probe Light

Illuminated (amber) – probe is not being heated in flight or neither engine is running on the ground.

5 Left Auxiliary Pitot (L AUX PITOT) Light

Illuminated (amber) – probe is not being heated in flight or neither engine is running on the ground.

6 Right Auxiliary Pitot (R AUX PITOT) Light

Illuminated (amber) – probe is not being heated in flight or neither engine is running on the ground.

7 Total Air Temperature (TAT) Probe Light

Illuminated (amber) – probe is not being heated in flight or neither engine is running on the ground.

Introduction

The anti-ice and rain systems include:

- engine anti-ice
- wing anti-ice
- flight deck window heat
- windshield wipers
- probe heat

Engine Anti-Ice System

The engine anti-ice system uses engine bleed air to provide engine cowl inlet ice protection. Engine anti-ice can be operated in flight or on the ground. The left and right engines have identical, independent anti-ice systems. This allows the remaining system to operate if one engine fails.

[When the aircraft is equipped with PW4000 engines.](#)

The engine thermal anti-ice (TAI) annunciation appears above the EICAS N1 indication when an engine anti-ice valve is open.

[When the aircraft is equipped with GE 80C2 engines.](#)

The engine thermal anti-ice (TAI) annunciation appears below the EICAS N1 indication when an engine anti-ice valve is open.

The VALVE light illuminates and the EICAS advisory message L or R ENG ANTI-ICE displays when the engine anti-ice valve disagrees with the switch position.

Wing Anti-Ice System

The wing anti-ice system provides bleed air to the three outboard leading edge slats on each wing. Wing anti-ice can be operated in flight only. It is inhibited on the ground.

The VALVE light illuminates and the EICAS advisory message L or R WING ANTI-ICE displays if the wing anti-ice valve disagrees with the switch position.

Manual Anti-Ice System Operation

Engine Anti-Ice Operation

On the ground or in flight, pushing the ENGINE ANTI-ICE switches ON commands the engine anti-ice valves to open, and allows engine bleed air to anti-ice the engine cowl inlets. Pushing the ENGINE ANTI-ICE switches again commands the engine anti-ice valves to close, and stops engine bleed air from anti-icing the engine cowl inlets.

Wing Anti-Ice Operation

In flight, pushing the WING ANTI-ICE switch ON commands the wing anti-ice valve in each wing to open, allowing bleed air to flow from the bleed air manifold to the affected slats. Pushing the WING ANTI-ICE switch again commands the wing anti-ice valve in each wing to close, stopping bleed air from flowing from the bleed air manifold to the affected slats.

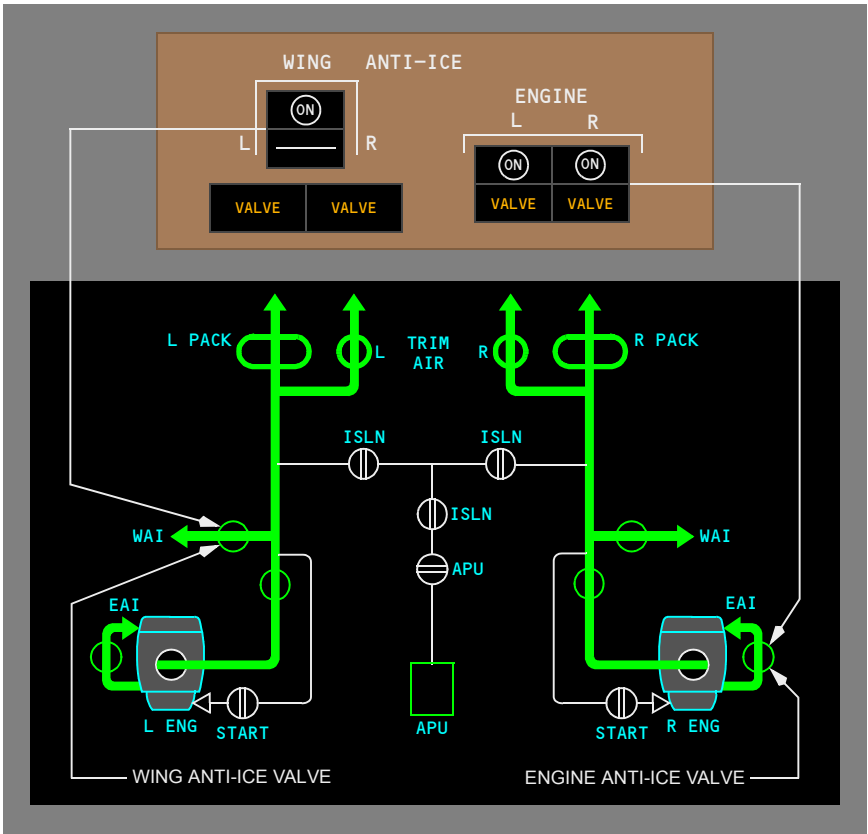
Anti-Ice System Schematic**Flight Deck Window Heat**

All flight deck windows are electrically heated. The forward windows have anti-icing protection and anti-fogging. The side windows have anti-fogging protection only.

The WINDOW HEAT switches control heating for all flight deck windows. With the switches ON, window heat operates as soon as electrical power is established. The windows are protected from thermal shock when the switches are initially placed ON.

In addition to the electric heating, conditioned air is ducted to the top of the forward windows and then flows along the inside surface to provide supplemental anti-fogging. The anti-fogging airflow is continuous and is independent of electric window heat.

One INOP light illuminates and the EICAS advisory message L or R FWD WINDOW or L or R SIDE WINDOW displays to indicate a window is not being heated. If two or more INOP lights illuminate, the EICAS advisory message WINDOW HEAT displays.

The WINDOW HEAT EICAS message displays, and electrical power for the aft-most cockpit window heat is load shed when the Fuel Jettison Switch is selected ON. Electrical power is reset, and the WINDOW HEAT EICAS message no longer displays when the Fuel Jettison Switch is selected OFF.

Windshield Wipers

The forward windows are equipped with two-speed wipers. One selector controls both wipers. With the WIPER selector in the OFF position, the wipers are off and stowed.

Probe Heat

Operation of the probe heat system is fully automatic. Power to the electrically heated probes is applied any time an engine is running.

An individual probe heat light illuminates and the associated EICAS advisory message displays when a probe is not being heated. If two or more probe lights illuminate, the EICAS advisory message PROBE HEAT displays.

Anti-Ice EICAS Messages

The following EICAS messages can be displayed.

| Message | Level | Light | Aural | Condition |
|------------------------------------|----------|---|-------|---|
| L AOA PROBE R AOA PROBE | Advisory | L AOA R AOA | | AOA probe heat is inoperative. |
| L AUX PITOT R AUX PITOT | Advisory | L AUX PITOT R AUX PITOT | | Left aux or right aux pitot heat is inoperative. |
| CAPT PITOT | Advisory | CAPT PITOT | | Captain's pitot probe heat is inoperative. |
| L ENG ANTI-ICE R ENG ANTI-ICE | Advisory | VALVE | | Engine anti-ice valve disagrees with switch position. |
| F/O PITOT | Advisory | F O PITOT | | First officer's pitot probe heat is inoperative. |
| PROBE HEAT | Advisory | Two or more PITOT, AOA or TAT | | Two or more probe heats are inoperative. |
| TAT PROBE | Advisory | TAT | | TAT probe heat is inoperative. |
| L FWD WINDOW R FWD WINDOW | Advisory | INOP | | Window is not being heated. |
| L SIDE WINDOW R SIDE WINDOW | Advisory | INOP | | Window is not being heated. |
| WINDOW HEAT | Advisory | Two or more INOP | | Two or more windows are not being heated. |
| L WING ANTI-ICE R WING ANTI-ICE | Advisory | VALVE | | Wing anti-ice valve disagrees with switch position. |

Intentionally
Blank

Automatic Flight**Chapter 4****Table of Contents****Section 0**

| | |
|---|-------------|
| Controls and Indicators | 4.10 |
| Mode Control Panel (MCP) | 4.10.1 |
| Autopilot Flight Director System (AFDS) Controls | 4.10.1 |
| Autothrottle (A/T) System Controls | 4.10.2 |
| Autopilot Flight Director IAS/MACH Controls | 4.10.4 |
| Autopilot Flight Director Roll and Pitch Controls | 4.10.5 |
| Autopilot Flight Director Heading and Bank Angle Controls .. | 4.10.7 |
| Autopilot Flight Director Vertical Speed (V/S) Controls | 4.10.8 |
| Autopilot Flight Director Altitude Controls | 4.10.9 |
| Autopilot Flight Director Approach Mode Controls | 4.10.9 |
| Autoland Status | 4.10.12 |
| ADI Flight Mode Annunciations (FMAs) | 4.10.13 |
| Autopilot Disengage Switch | 4.10.15 |
| Autothrottle Disconnect and Go-Around Switches | 4.10.16 |
| Autoflight Lights | 4.10.17 |
| System Description | 4.20 |
| Introduction | 4.20.1 |
| Autopilot Flight Director System | 4.20.1 |
| MCP Switches | 4.20.1 |
| Autopilot Engagement | 4.20.2 |
| Autopilot Disengagement | 4.20.2 |
| AFDS Failures | 4.20.2 |
| Flight Director Display | 4.20.3 |
| Autopilot Flight Director System Schematic | 4.20.4 |
| Autoland Status Annunciators (ASA) | 4.20.4 |
| AFDS Flight Mode Annunciations | 4.20.5 |
| Autothrottle System | 4.20.8 |
| Thrust Management Computer | 4.20.9 |
| Thrust Mode Select Panel | 4.20.9 |
| Autothrottle Thrust Lever Operation | 4.20.9 |
| Autothrottle Disconnect | 4.20.10 |

| | |
|--|-------------|
| Automatic Flight Operations | 4.20.11 |
| Automatic Flight – Takeoff and Climb Profile | 4.20.11 |
| Automatic Flight – Cruise | 4.20.13 |
| Automatic Flight – Approach and Landing | 4.20.14 |
| Automatic Flight – Approach Profile | 4.20.16 |
| Automatic Flight – Go-Around | 4.20.16 |
| Automatic Flight – Windshear Recovery | 4.20.18 |
| Auto Flight Limit Modes | 4.20.18 |
| EICAS Messages | 4.30 |
| Automatic Flight EICAS Messages | 4.30.1 |

Automatic Flight Controls and Indicators

Chapter 4 Section 10

Mode Control Panel (MCP)



Autopilot Flight Director System (AFDS) Controls

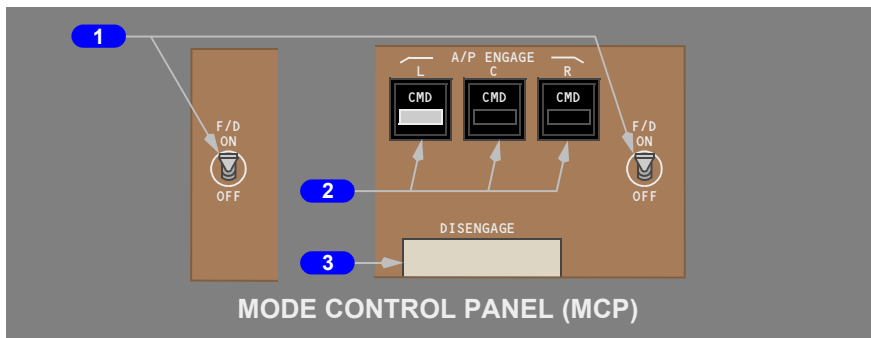

1 Flight Director (F/D) Switches

The left and right flight director switches activate flight director steering indications on their respective flight mode annunciator (FMA).

ON – respective pilots command bars operate in current AFDS mode.

- On the ground with no autopilot engaged and both F/D switches OFF, the first F/D switch positioned to ON arms the flight director in the takeoff (TO) roll and pitch modes. Positioning the second F/D switch to ON displays the flight director steering indications on the second FMA
- In flight, with the autopilot engaged and both F/D switches OFF, the first F/D switch positioned to ON activates the flight director in the selected autopilot mode(s)
- In flight with the autopilot disengaged and both F/D switches OFF, the first F/Ds switch positioned to ON engages the flight director in:

[Basic: Autopilot heading hold at engage.]

- V/S as the pitch mode and HDG HOLD as the roll mode
- command bars not in view if the autopilot, corresponding to the FCC selected for the flight director, is engaged in CMD

OFF –

- flight director steering indications do not display, unless
- the go-around switch is pushed when airspeed is greater than 80 knots and with the flaps not retracted

2 Autopilot (A/P) ENGAGE Switches

Push (any switch can engage the autopilot) –

- CMD displays on each FMA
- if either F/D switch is ON, the autopilot engages in the selected flight director mode(s) except TO and GA
- if both F/D switches are OFF, the autopilot engages in:
 - V/S as the pitch mode and HDG HOLD as the roll mode

3 Autopilot DISENGAGE Bar

Push down –

- disengages all three autopilots
- prevents autopilot engagement
- exposes amber stripe

Lift up –

- enables autopilot engagement
- conceals amber stripe

Autothrottle (A/T) System Controls

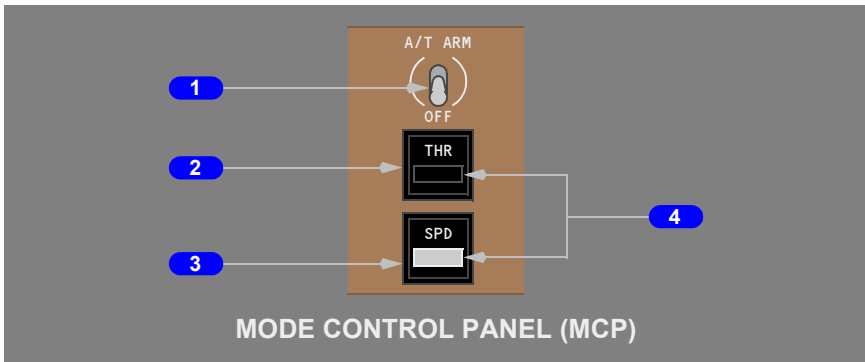

1 Autothrottle (A/T) ARM Switch

ARM –

- arms autothrottle system for mode selection
- autothrottle operates when THR, SPD, V NAV, FL CH, or GA switch pushed
- autothrottle operates when SPD switch pushed and pitch mode is ALT HOLD, V/S or G/S

OFF – disconnects autothrottle and prevents autothrottle engagement.

2 Thrust (THR) Switch

Push –

- selects autothrottle EPR mode
- EPR annunciates on each FMA
- selects autothrottle N1 mode
- N1 annunciates on each FMA
- autothrottle holds reference thrust value displayed on EICAS subject to maximum speed limits
- changes thrust reference from TO to CLB if above 400 feet radio altitude
- updates FMC position to takeoff runway threshold position when selected for takeoff only if GPS NAV is OFF (i.e. GPS NAV data not available to the FMC)

3 Speed (SPD) Switch

Push –

- selects autothrottle SPD mode
- SPD appears on each FMA
- autothrottle controls thrust to maintain IAS or MACH displayed in the speed window subject to minimum and maximum speed limits
- changes thrust reference from TO to CLB if above 400 feet radio altitude

4 MCP Mode Switch Lights

All MCP mode switches contain an annunciator light that illuminates when the mode switch is selected to indicate the mode is either engaged or armed.

Autopilot Flight Director IAS/MACH Controls

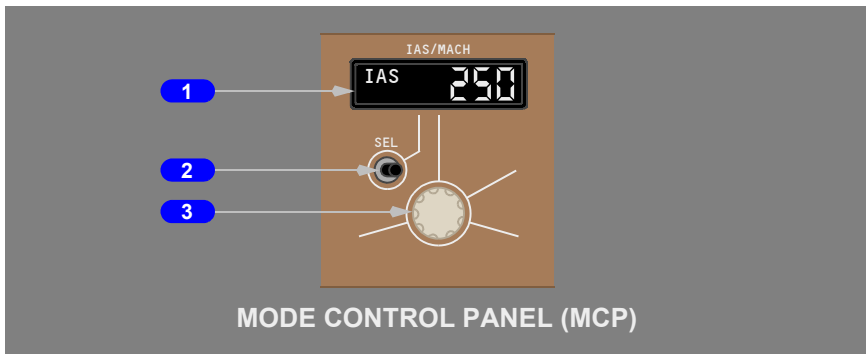

1 IAS/MACH Window

Displays selected speed when IAS/MACH selector controls command speed.

Displays 200 knots when power first applied.

Blank when FMC is controlling command airspeed bugs.

Display range:

- 0.40 – 0.95 MACH
- 100 – 399 KIAS

In climb, changes from IAS to MACH at approximately .80 MACH.

In descent, changes from MACH to IAS at approximately 300 KIAS.

2 Select (SEL) Switch

Push – alternately changes the IAS/MACH window between IAS and MACH.

3 IAS/MACH Selector

Rotate –

- sets speed in IAS/MACH window and positions command airspeed bugs
- inoperative when IAS/MACH window blank

Push – when VNAV mode is engaged, alternately changes IAS/MACH window between current IAS or MACH and a blank display.

- VNAV active, window opens and speed control transfers from FMC target speed to IAS/MACH selector
- descending in VNAV PTH, pitch mode changes to VNAV SPD. Selected speed maintained by pitch until airplane intercepts an altitude constraint and VNAV PTH reengages. Although, if on approach, pitch mode remains in VNAV PTH and autothrottle controls speed

Autopilot Flight Director Roll and Pitch Controls

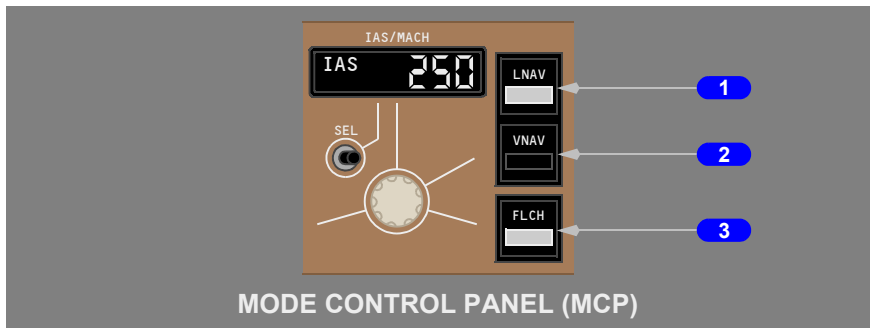

1 Lateral Navigation (L NAV) Switch

Push –

- Arms, engages or disarms LNAV as the roll mode.
- Displays LNAV in white (armed) on the roll flight mode annunciator when armed. The previous roll mode remains active.
- LNAV engages if the airplane is above 50 feet radio altitude and:
 - within 2.5 NM of the active leg
 - if not within 2.5 NM of the active leg and on an intercept heading to the active leg, remains armed then engages when approaching the active leg
 - when engaged, displays LNAV in green on roll flight mode annunciator
- selection of LNAV with the airplane not on a heading which intercepts the active leg, displays NOT ON INTERCEPT HEADING in the CDU scratch pads.
- Selection of LNAV when an active FMC route is not available displays NO ACTIVE ROUTE in the CDU scratchpad.

LNAV maintains current heading when:

- passing the last active route waypoint
- passing the last waypoint prior to a route discontinuity
- passing the last route offset waypoint
- activating the inactive route or activating an airway intercept and not within LNAV engagement criteria

LNAV deactivates:

- by selecting heading hold (HDG HOLD) or heading select (HDG SEL)
- when localizer is captured

- if there is a dual FMC failure (LNAV may be re-engaged if there is an active CDU ALTN NAV route available).
- by pushing LNAV switch a second time when LNAV is armed

2 Vertical Navigation (V NAV) Switch

Push –

- engages AFDS and A/T in VNAV mode
- VNAV PTH or VNAV SPD displays on each FMA
- AFDS and autothrottle follow vertical path and thrust guidance from FMCS
- changes thrust reference from TO to CLB if above 400 feet radio altitude

During climbs or descents, AFDS captures and holds altitude displayed in altitude window or FMC target altitude, whichever is reached first.

With VNAV engaged, pushing IAS/MACH selector permits manual speed selection. FMCs then use manually selected speeds for speed control.

VNAV deactivates:

- by selecting GA, FL CH, SPD or THR, V/S or ALT HOLD
- by pushing VNAV switch a second time when VNAV is armed
- when glideslope is captured
- in climb or descent, reaching altitude displayed in altitude window prior to reaching FMCs target altitude
- passing top of descent point if the MCP is not set to an altitude below cruise altitude

3 Flight Level Change (FL CH) Switch

Push –

- selects FLCH mode and sets IAS/MACH window and command airspeed bugs to current airspeed
- FLCH displays on each FMA
- AFDS pitch holds existing airspeed and A/T sets required thrust, limited by the thrust limit for climb and idle for descent. When selected altitude is reached, pitch mode changes to ALT HOLD and A/T changes to SPD mode
- with FLCH mode displayed, pushing switch resets IAS/MACH window and commands airspeed bugs to current airspeed
- changes thrust reference from TO to CLB if above 400 feet radio altitude

Autopilot Flight Director Heading and Bank Angle Controls

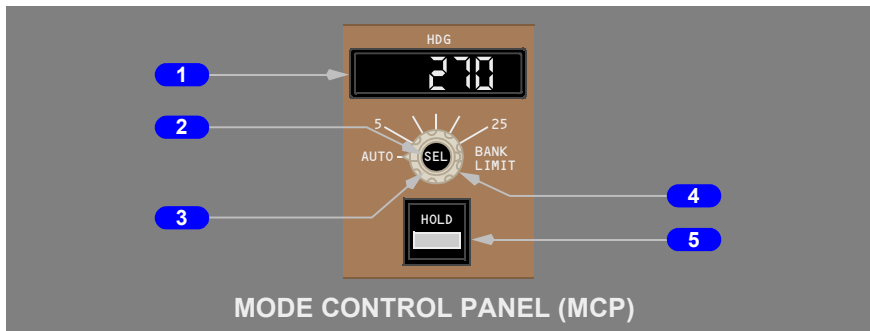

1 Heading (HDG) Window

Displays selected heading and positions map display selected heading markers. HDG window and map display headings set to 000 when power first applied. Automatically changes to ILS front course heading at LOC capture.

2 Heading Select (SEL) Switch

Push –

- engages HDG SEL roll mode
- HDG SEL roll mode displays on each FMA
- AFDS controls roll to acquire and hold heading shown in heading window and on map display heading markers
- bank is limited by bank limit selector

3 Heading Selector (inner)

Rotate – sets heading in HDG window and positions selected heading marker on both map displays.

4 BANK LIMIT Selector (outer)

Rotate – sets AFDS commanded bank limit when in HDG SEL roll mode as follows:

AUTO – bank angle varies between 15 – 25 degrees, depending on true airspeed.

- at slower true airspeeds the bank angle limit is 25 degrees
- as true airspeed increases, the bank angle limit decreases

Manually selected – 5, 10, 15, 20, or 25 selected value is maximum regardless of airspeed.

5 Heading HOLD Switch

Push –

- selects HDG HOLD roll mode and displays on each FMA
- AFDS rolls wings level, then holds present heading

Autopilot Flight Director Vertical Speed (V/S) Controls

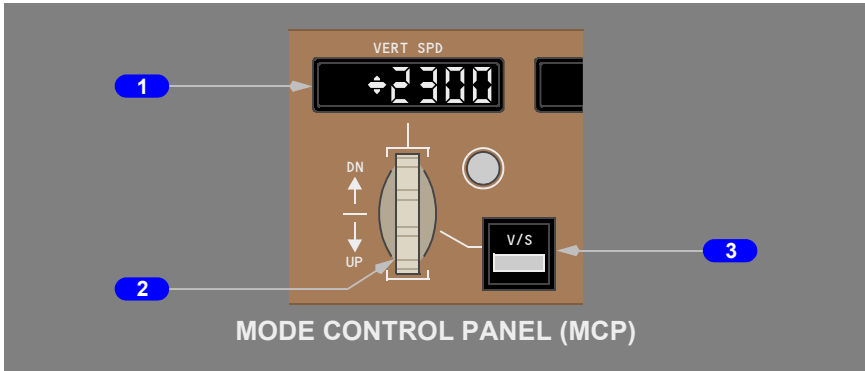

1 Vertical Speed (VERT SPD) Window

Displays selected vertical speed.

Blank when V/S pitch mode not selected.

Display range is from (–8000 to +6000 fpm) in 100 fpm increments.

2 Vertical Speed Selector (DN/UP)

UP or Down (DN) – sets vertical speed in VERT SPD window.

3 Vertical Speed (V/S) Switch

Push –

- selects V/S pitch mode and displays on each FMA
- displays current vertical speed in VERT SPD window
- when selected altitude reached, pitch flight mode annunciation changes to ALT HOLD
- AFDS pitch maintains vertical speed displayed in the VERT SPD window
- if AFDS is engaged in V/S from FLCH or from VNAV, A/T automatically engages in SPD mode if armed

Autopilot Flight Director Altitude Controls

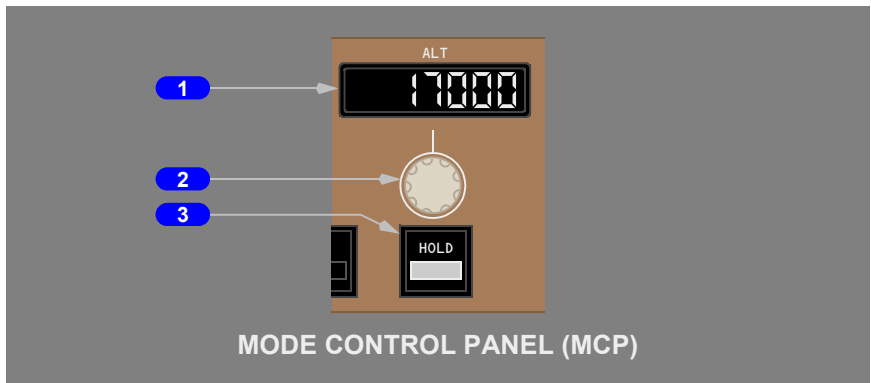

1 Altitude (ALT) Window

Displays selected altitude in 100 feet increments. Range: 0 to 50,000 feet. Displayed altitude is reference altitude, for altitude alerting and level off. ALT window set to 10,000 feet when power is first applied.

2 Altitude Selector

Rotate – sets altitude in ALT window.

3 Altitude HOLD Switch

Push –

- selects altitude ALT HOLD pitch mode
- ALT HOLD pitch mode displays on FMA pitch mode annunciation
- AFDS commands pitch to maintain the altitude when the switch was pushed

Autopilot Flight Director Approach Mode Controls

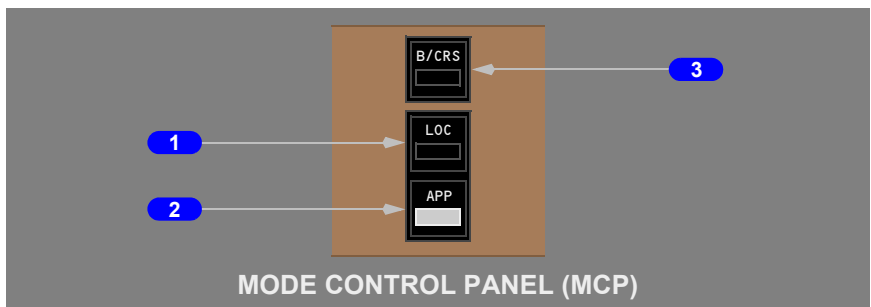

1 Localizer (LOC) Switch

Push –

- arms, disarms, captures LOC as roll mode
- displays LOC on both FMA roll flight mode annunciations before localizer capture; current roll mode LNAV, HDG SEL or HDG HOLD remains active until LOC capture
- displays LOC on FMA roll flight mode annunciations after localizer capture
- arms AFDS to capture and track inbound on front course, capture point varies based on range and intercept angle
- localizer capture can occur when intercept track angle is within 120 degrees of the localizer course

Note: After localizer capture, flight director roll commands may appear inconsistent with A/P roll maneuvers for one to two minutes.

Localizer mode can be disarmed before localizer capture by:

- pushing localizer switch a second time
- arming LNAV

Localizer mode can be deactivated after localizer capture by:

- pushing a GA switch
- selecting a roll mode other than LNAV
- disengaging the autopilot and turning both F/D switches off

Note: The LOC mode is a single autopilot function only. Multiple autopilots cannot be engaged with this mode.

2 Approach (APP) Switch

Push –

- autopilot systems powered by separate sources with three autopilots engaged
- arms, disarms, or captures LOC as roll mode and glideslope (G/S) as pitch mode
- displays LOC and G/S on FMA roll and pitch flight mode annunciations prior to localizer and glideslope capture
- displays LOC and G/S on both FMA roll and pitch flight mode annunciations after each is captured
- localizer captures when intercept track angle is within 120 degrees of localizer course

Note: After localizer capture, flight director roll commands may appear inconsistent with A/P roll maneuvers for one to two minutes.

- glideslope captures when intercept track angle to the localizer is within 80 degrees of localizer course

[Basic: Glideslope inhibit before localizer capture.]

- localizer must be captured before glideslope
- AFDS captures and tracks localizer and glideslope upon intercepting the respective localizer and glideslope radio signals

[Basic: Approach mode automatic autopilot selection.]

- arms the other autopilot systems (CMD switch bars in view) for subsequent automatic engagement which occurs when localizer and glideslope are captured, and radio altitude is below 1500 feet

Approach mode can be disarmed before localizer or glideslope capture by:

- pushing approach switch a second time
- pushing LOC switch (G/S disarms, LOC remains armed)
- pushing LNAV switch and LNAV arms (does not immediately engage)
- pushing VNAV switch and VNAV arms (does not immediately engage)

Approach mode deselects:

- with LOC captured and G/S armed, by selecting another roll mode other than LNAV; selecting LOC mode initiates a localizer approach.
- with G/S captured and LOC armed, by selecting another pitch mode other than VNAV.
- after LOC and/or G/S are captured, by selecting TO/GA mode or disengage autopilot and turn both F/D switches off

3 Backcourse (B/CRS) Switch

Push – (Must be used concurrently with LOC switch), arms or engages AFDS in B/CRS mode as follows:

B/CRS appears on each FMA prior to localizer capture.

- AFDS is armed to capture and track inbound on backcourse of localizer
- capture point varies based on range and intercept angle
- initial roll modes; LNAV, HDG SEL or HDG HOLD remain engaged until B/CRS capture
- before localizer capture, pushing the LOC switch a second time disarms both the LOC and B/CRS modes. Pushing only the B/CRS switch a second time, disarms the B/CRS mode but the LOC mode remains armed

B/CRS appears on each FMA after localizer capture.

- AFDS tracks inbound on backcourse
- if the LOC switch is selected and localizer is captured before B/CRS switch is pushed, AFDS will track the localizer front course (outbound) and B/CRS cannot be selected
- G/S, FLARE and ROLLOUT functions are not available

Note: The B/CRS mode is a single autopilot function only. Multiple autopilots cannot be engaged with this mode.

Autoland Status

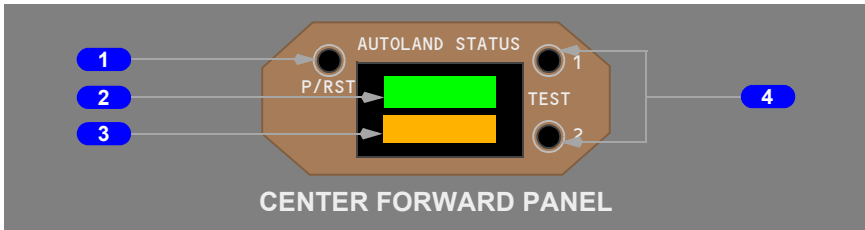

1 Push/Reset (P/RST) Switch

Push – resets both pilots annunciators as follows:

Before APP mode selected:

- changes NO AUTOLND or NO LAND 3 to blank,
- if condition is still present when switch release, annunciation returns

After APP mode selected:

- if NO LAND 3 displayed, becomes blank and remains blank until after landing and autopilots disengaged
- if NO AUTOLND displayed, remains displayed until autopilots are disengaged

2 AUTOLAND STATUS Annunciator (Upper)

Normal (blank) –

LAND 3 – (green)

- indicates all three autopilot systems and their associated supporting airplane system inputs are operating normally
- appears below 1500 feet radio altitude with LOC and G/S captured

LAND 2 – (green)

- indicates a minimum of two autopilot systems and their associated supporting airplane system inputs are operating normally
- appears below 1500 feet radio altitude with LOC and G/S captured

3 AUTOLAND STATUS Annunciator (Lower)

Normal (blank) –

NO AUTOLND (amber) – indicates fault conditions exist which preclude the use of the autopilots for an automatic landing.

NO LAND 3 (amber) – indicates a fault condition exists which results in a LAND 2 condition

4 TEST Switches

Push – activates autoland status annunciator tests.

ADI Flight Mode Annunciations (FMAs)

[Option: Top flight mode annunciations (required for speed tape).]

[Option: Top flight mode annunciations.]

[Basic: Fast / slow indicator.]

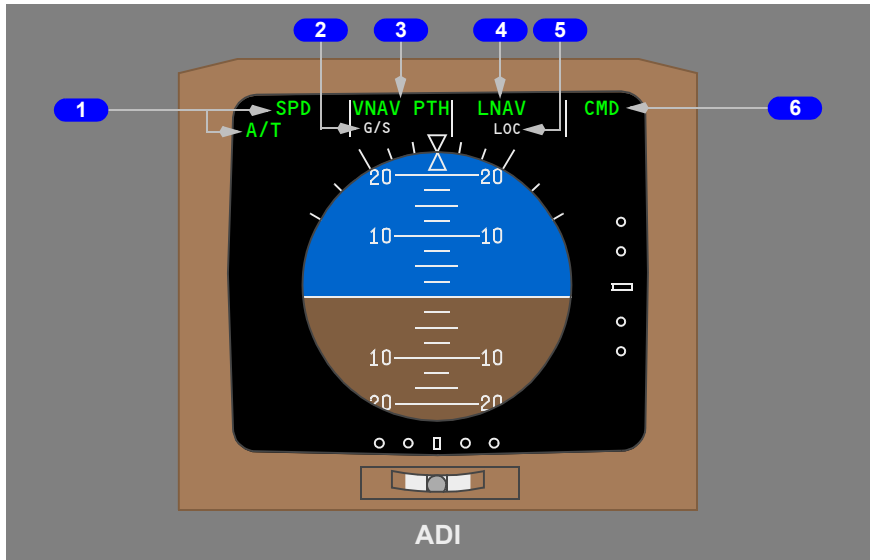
**1 Autothrottle Modes (Active)**

Displayed (green) – ***

- EPR
- N1
- SPD
- FLCH
- GA
- IDLE
- THR HLD

Autothrottle Limits: displayed (green) – */***

- FLAP LIM
- ALPHA
- SPD LIM

[Option: Top flight mode annunciations.]

[Basic: Fast / slow indicator.]

Autothrottle Status: displayed (green) – ****

- A/T
- F/S

2 AFDS Pitch Modes (Armed)

Displayed (white) –

- G/S
- FLARE
- VNAV

3 AFDS Pitch Modes (Active)

Displayed (green) – **/ ***

- TO
- ALT HOLD
- V/S
- VNAV PTH
- VNAV SPD
- SPD
- G/S
- FLARE
- ALT CAP
- GA

AFDS Pitch Limits: displayed (green) – */***

- FLAP LIM
- SPD LIM

4 AFDS Roll Modes (Active)

Displayed (green) – **/ ***

- HDG HOLD
- HDG SEL
- LNAV
- LOC
- ROLLOUT
- TO
- GA

[Option: Top flight mode annunciations]

- B/CRS

5 AFDS Roll Modes (Armed)

Displayed (white) –

- LOC
- ROLLOUT
- LNAV

[Option: Top flight mode annunciations.]

- B/CRS

6 AFDS (Active)

Displayed (green) –

- CMD
- FD

* Mode is operating with angle of attack (alpha) or airspeed limit. Limit mode annunciation replaces engaged mode annunciation.

** An amber horizontal line is drawn through the appropriate autopilot pitch or roll mode annunciation when a flight mode fault is detected.

***AFDS/Autothrottle mode changes are emphasized for 10 seconds by a box (green) drawn around the annunciated mode.

[Basic: Fast / slow indicator.]

****F/S appears only when autothrottle is disengaged, AFDS is not operating in a speed mode (FLCH or GA) and the present airspeed is approaching either the SPD LIM, ALPHA or FLAP LIM.

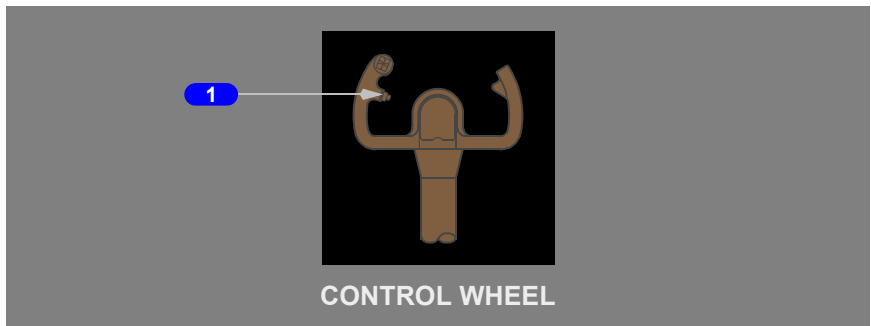
Autopilot Disengage Switch

1 Autopilot Disengage Switches

Push (either switch) –

- disconnects the autopilot
- A/P DISC and master warning lights illuminate
- displays the EICAS warning message AUTOPILOT DISC
- sounds an aural warning
- if the autopilot automatically disengages, resets the master warning lights, EICAS warning message, and the aural warning

Second push – resets

- the master warning light
- EICAS warning message
- the aural warning

Autothrottle Disconnect and Go-Around Switches

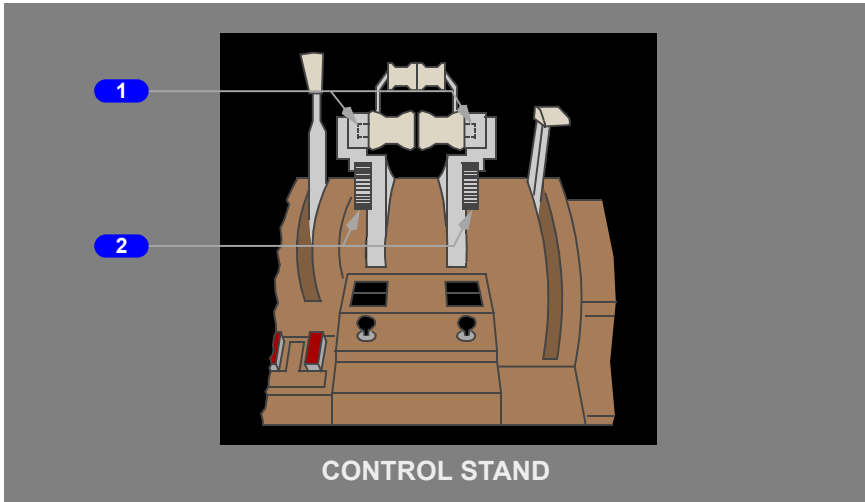

1 Autothrottle Disconnect Switches

Push (either switch) –

- disconnects autothrottle and A/T DISC light illuminates
- autothrottle remains armed
- subsequent push extinguishes A/T DISC light

2 Go-Around Switches

Push (either switch) –

- automatic arming occurs at glide slope capture or with extension of wing flaps
- engages AFDS and autothrottle in GA mode if previously armed
- provides windshear guidance during GA if windshear detected
- if flight director off, activates flight director in GA mode
- cancels all thrust derates if selected after takeoff

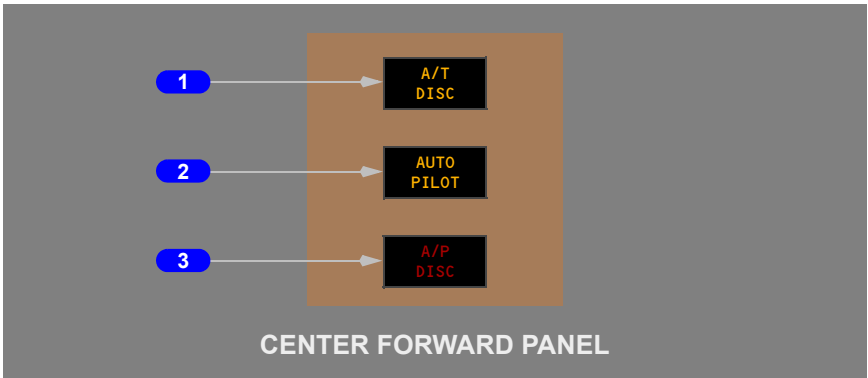
Autoflight Lights**1 Autothrottle Disconnect (A/T DISC) Light**

Illuminated (amber) –

- autothrottle has disconnected
- extinguished by pushing either autothrottle disconnect switch

2 Autopilot (AUTO PILOT) Light

Illuminated (amber) –

- a degraded operating condition exists in engaged autopilot
- extinguished when condition is corrected or an alternate autopilot is selected, provided fault is not common to alternate autopilot

3 Autopilot Disconnect (A/P DISC) Light

Illuminated (red) –

- an autopilot has been automatically or manually disconnected
- extinguished by pushing either autopilot disengage switch

Intentionally
Blank

Introduction

The automatic flight control system consists of the autopilot flight director system (AFDS) and the autothrottle system (A/T). The mode control panel (MCP) and flight management computer (FMC) control the AFDS and the autothrottle system to perform climb, cruise, descent and approach.

Autopilot Flight Director System

The AFDS consists of three flight control computers (FCCs) and the MCP.

The MCP provides control of the autopilot, flight director, altitude alert, and autothrottle systems. The MCP selects and activates AFDS modes, and establishes altitudes, speeds, and climb/descent profiles.

The three FCCs, left, center, and right, control separate hydraulically powered autopilot control servos to operate flight controls. The autopilot controls ailerons and elevators. Rudder commands are added only during a multiple autopilot approach. Nose wheel steering is also added during rollout from an automatic landing. During an ILS approach with all three autopilots engaged, separate electrical sources power the three FCCs.

The FCCs also provide inputs for AFDS operating mode displays and flight director commands on the FMA.

MCP Switches

MCP switches select automatic flight control and flight director modes. A light in the lower half of the switch illuminates to indicate the mode is armed or active. Respective roll and pitch flight mode annunciations on the FMA will also display. Autothrottle modes are discussed later in this section.

The following modes activate with a single push. These modes include:

- flight level change (FLCH)
- heading hold (HDG HOLD)
- heading select (HDG SEL)
- vertical speed (V/S)
- altitude hold (ALT HLD)

Other modes arm or activate with a single push. These modes are:

- lateral navigation (LNAV)
- vertical navigation (VNAV)
- localizer (LOC)

- approach (APP)
- back course localizer (B/CRS)

All modes deactivate by disengaging the autopilot and turning both flight directors off. After localizer and glideslope capture, the localizer and glideslope modes can only be deactivated by disengaging the autopilot and turning both flight directors off or by selecting GA mode.

Desired target values can be selected on the MCP for:

- airspeed
- mach
- heading
- vertical speed
- altitude

All parameters except vertical speed can be preselected before autopilot and/or flight director engagement.

Autopilot Engagement

Autopilot engagement requires at least two FCCs and pushing one of the MCP autopilot engage switches.

Autopilot Disengagement

Normal autopilot disengagement is through either control wheel autopilot disengage switch.

The autopilots can also be disengaged by the MCP autopilot disengage bar.

The A/P DISC light illuminates and the EICAS warning message AUTOPILOT DISC displays when the autopilot has been manually or automatically disconnected.

AFDS Failures

During autopilot operation, failures affecting the active mode annunciate on the FMA. If the failure affects only the active mode:

- the autopilot remains engaged in an attitude stabilizing mode
- an amber line is drawn through the mode annunciation
- the AUTO PILOT light illuminates
- the EICAS caution message AUTOPILOT displays

If unwanted operation is noticed or when an autopilot failure is annunciated, the autopilot should be disconnected and the airplane flown manually.

Failures affecting all autopilot modes result in an autopilot disengagement accompanied by an aural warning. Depending on the system failure, it may be possible to reengage an autopilot by pushing the autopilot engage switch.

Flight Director Display

Flight director steering indications normally display any time the related F/D switch is ON.

The steering indications are also displayed when the related flight director switch is OFF and a go-around switch is pushed, if airspeed is greater than 80 knots and the flaps are not retracted. In this case, the flight director display can be removed by cycling the respective flight director switch on and then off.

A flight director failure in either pitch or roll, causes the respective steering bars to disappear.

Autopilot Flight Director System Schematic

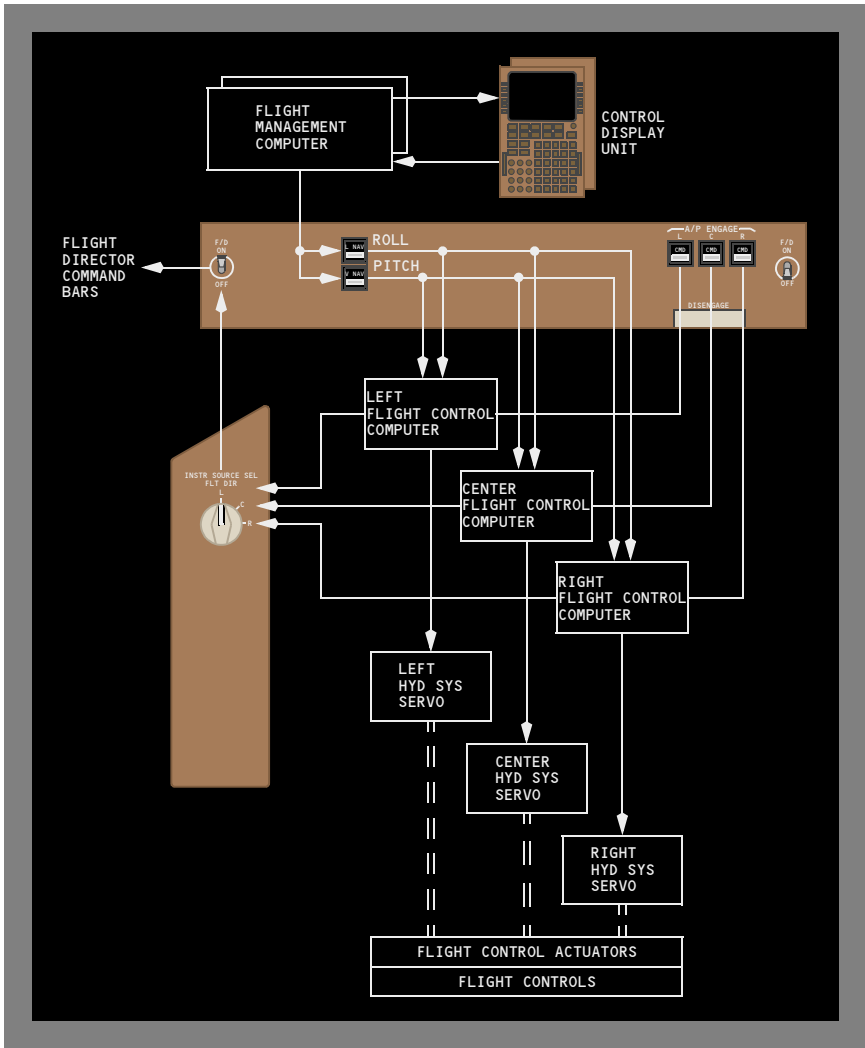

Autoland Status Annunciators (ASA)

The following AFDS status annunciations can be displayed:

- LAND 3 – three autopilots engaged and operating normally for an automatic landing
- LAND 2 – AFDS redundancy reduced, in some cases only two autopilots available

- NO LAND 3 – indicates a fault condition exists which results in a LAND 2 condition
- NO AUTOLND – AFDS unable to make an automatic landing

With a LAND 3 indication, the autopilot system level of redundancy is such that a single fault cannot prevent the autopilot system from making an automatic landing (fail operational).

With a LAND 2 indication, the level of redundancy is such that a single fault cannot cause a significant deviation from the flight path (fail passive).

Below 200 feet radio altitude the ASA display cannot change except to indicate a NO AUTOLND condition. Faults not requiring immediate crew action or awareness are annunciated after touchdown.

AFDS Flight Mode Annunciations

Flight mode annunciations are displayed on the ADI. Mode annunciations include:

- autothrottle
- pitch
- roll
- AFDS status

Active modes are displayed in green letters. When a mode changes the new active mode is highlighted with a green rectangle around it for several seconds. Armed modes display in smaller white letters.

Autothrottle Modes

Autothrottle annunciations are:

- SPD – autothrottle controlling thrust to maintain speed selected in IAS/Mach or, if VNAV engaged, the speed as programmed by the FMC
- IDLE – autothrottle is reducing or has reduced thrust to flight idle. It may engage in a VNAV descent. It will, after FLARE is engaged

[Option: [Top flight mode annunciations](#)]

- THR HLD – thrust levers remain in existing position or where manually placed
- EPR – autothrottle controlling to the selected EPR reference thrust
- N1 – autothrottle controlling to the selected N1 reference thrust
- FLCH – autothrottle controlling to a maximum of the selected mode reference thrust during climb, and to a minimum thrust during descent
- GA – autothrottle controlling to a maximum reference thrust to maintain a climb rate of at least 2000 fpm. If both flight directors and the autopilot are off, autothrottle controls to go-around reference thrust subject to flap and VMO limit speeds

Roll Modes

Roll annunciations are:

LNAV –

[Option: Top flight mode annunciations]

Arm LNAV by pushing the L NAV switch. The light illuminates and LNAV annunciates on the FMA roll mode annunciator in white characters below the current roll mode.

- LNAV (armed) – LNAV is armed to activate when parameters are met
- LNAV (active) – LNAV activates when in position to turn onto the active route leg. In flight, selection causes immediate activation if within 2 1/2 NM of the active leg

[Basic: Autopilot heading hold at engage.]

HDG –

- HDG SEL (active) – airplane turns to or maintains the heading selected in the MCP heading window
- HDG HOLD (active) – AFDS holds present heading. When turning, AFDS holds the heading reached after rolling wings level

LOC –

- LOC (armed) – AFDS captures the localizer when within range and within 120 degrees of the localizer course
- LOC (active) – AFDS follows the localizer course

B/CRS –

- B/CRS (armed) – AFDS is armed to capture and track inbound on backcourse of localizer after localizer capture
- B/CRS (active) – AFDS tracks inbound on backcourse of localizer

TO –

- On the ground, TO annunciates by selecting either F/D switch ON when both flight directors are OFF
- TO roll and pitch guidance become active at lift-off

GA –

- In flight, go-around arms with flaps out of up or at glideslope capture. There is no flight mode annunciation for go-around armed in flight; although the reference thrust limit changes to GA. Go-around is activated in flight by pushing a GA switch. The roll steering indication provides guidance to maintain the ground track present at mode engagement

ROLLOUT –

- ROLLOUT (armed) – displays below 1500 feet radio altitude and activates below 5 feet
- ROLLOUT (active) – after touchdown, AFDS uses rudder and nosewheel steering to steer the airplane on the localizer centerline

Pitch Modes

Pitch annunciations are:

TO –

On the ground, TO annunciates by selecting either F/D switch ON when both flight directors are OFF. The flight director pitch bar indicates an initial pitch of approximately eight degrees up.

After takeoff, the AFDS commands a pitch attitude to maintain:

- pitch command greater of $V_2 + 15$ knots or liftoff speed + 15
- if current airspeed remains above the target speed for 5 seconds, target airspeed resets to current airspeed, to a maximum of $V_2 + 25$ knots
- IAS/MACH window speed if IAS/MACH window speed is changed to a speed greater than the target speed

Note: AFDS uses the speed set in the IAS/MACH window prior to takeoff for V_2

GA –

Go-around arms and the reference thrust limit changes to GA when flaps are out of up or glideslope is captured.

When a go-around is initiated, the commanded speed is the MCP IAS/Mach window or current airspeed, whichever is higher. If the airspeed increases and remains above the initial target airspeed for five seconds, target airspeed resets to current airspeed to a maximum of the IAS/MACH window speed plus 25 knots. If airspeed at initiation of go-around is greater than IAS/Mach window plus 25 knots, that speed is maintained. GA displays as the reference thrust limit on the primary EICAS engine display.

VNAV –

[Option: [Top flight mode annunciations](#)]

Arm VNAV by pushing the V NAV switch. The light illuminates and VNAV annunciates on the FMA pitch mode annunciator in white characters below the current pitch mode.

VNAV provides pitch commands to maintain the FMC computed airspeed/path:

- VNAV SPD (active) – the AFDS maintains the FMC speed displayed on the FMA and/or the CDU CLIMB or DESCENT pages. During speed intervention, use the MCP IAS/MACH selector to manually set the speed
- VNAV PTH (active) – the AFDS maintains FMC altitude or descent path with pitch commands. For a non-entered headwind, thrust may increase to maintain the VNAV descent path. If the MCP altitude window is set to the current cruise altitude as the airplane approaches the top of descent, the CDU scratchpad message RESET MCP ALT displays
- when a VNAV descent is initiated before the top of descent (T/D) and the airplane descent path subsequently intercepts the VNAV descent path, the pitch annunciation changes from VNAV SPD to VNAV PTH

V/S –

Pushing the V/S switch opens the vertical speed window and displays the current vertical speed. It also opens the IAS/MACH window (if blanked). Pitch commands maintain the rate of climb or descent selected in the V/S window.

SPD –

Pushing the SPD switch opens the IAS/MACH window (if blanked). Pitch commands maintain IAS/MACH window airspeed or Mach.

ALT CAP –

A transition maneuver entered automatically from a V/S, FLCH, or VNAV climb or descent to selected MCP altitude. Engages but does not annunciate during VNAV transition.

ALT HOLD –

Altitude hold mode is activated by:

- pushing the MCP altitude HOLD switch, or
- capturing the selected altitude from a V/S or FLCH climb or descent.

G/S –

Autopilot flight director system follows the ILS glideslope.

FLARE –

- FLARE (armed) – during autoland, FLARE displays below 1500 feet radio altitude
- FLARE (active) – during autoland, flare activates at 50 feet radio altitude. FLARE deactivates at touchdown and the nosewheel smoothly lowers to the runway

Autothrottle System

The autothrottle system provides thrust control from takeoff through landing.

Autothrottle mode and speed selection is controlled from the MCP and the thrust mode select panel (TMSP). When in VNAV, the FMC selects autothrottle modes and target thrust values. Refer to Chapter 11, Flight Management, Navigation, for FMS and CDU operation.

With a command speed of VREF + 5 knots and landing flaps, there is sufficient wind and gust protection available with the autothrottle engaged. The autothrottle adjusts thrust quickly when the airspeed decreases below the command speed. The autothrottle decreases thrust slowly when the airspeed is more than the command speed. In turbulence, the result is that the thrust average is higher than necessary to keep the command speed. This causes the speed average to be more than the command speed.

The autothrottle can be operated without using the flight director or the autopilot.

The autothrottle can be manually overridden or disconnected by using either A/T disconnect switch.

Thrust Management Computer

The thrust management computer (TMC) controls the autothrottle system through manual inputs from the MCP or automatically from the FMCs while VNAV is engaged. The basic TMC functions are to:

- calculate thrust limits and settings or follow FMC thrust settings
- detect and transmit autothrottle failures
- actuate the thrust levers

[Basic: Fast / slow indicator.]

- generate fast slow indications for display on the ADIs

Thrust Mode Select Panel

The thrust mode select panel (TMSP) provides the following functions:

- selection of reference thrust modes (TO, GA, CLB, CON, CRZ)
- selection of fixed and assumed temperature derated reference thrust values

Autothrottle Thrust Lever Operation

The autothrottle system moves both thrust levers together to control speed or thrust, depending on the engaged mode.

[Option: Top flight mode annunciations]

Thrust levers can be manually positioned without disconnecting the autothrottle. After manual positioning and release, the autothrottle repositions the thrust levers to comply with the engaged mode. The autothrottle system does not reposition the thrust levers while in THR HLD mode.

Autothrottle Disconnect

The autothrottle system can be disconnected manually by positioning the A/T arm switch to OFF or by pushing either thrust lever A/T disconnect switch.

Autothrottle disconnect occurs if a fault in the active autothrottle mode is detected, or when a reverse thrust lever is raised to reverse idle.

The A/T DISC light illuminates and the EICAS caution message AUTOTHROT DISC displays.

Automatic Flight Operations

Automatic Flight – Takeoff and Climb Profile

[Option: Top flight mode annunciations]

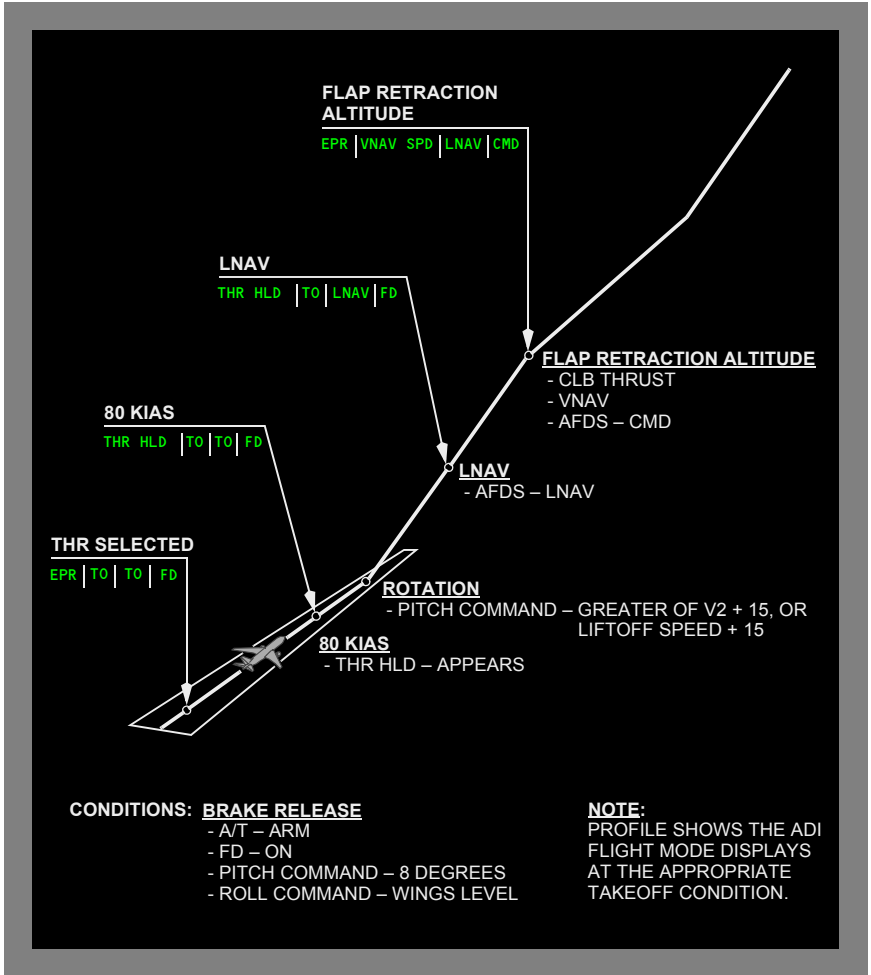

[Option: Top flight mode annunciations]

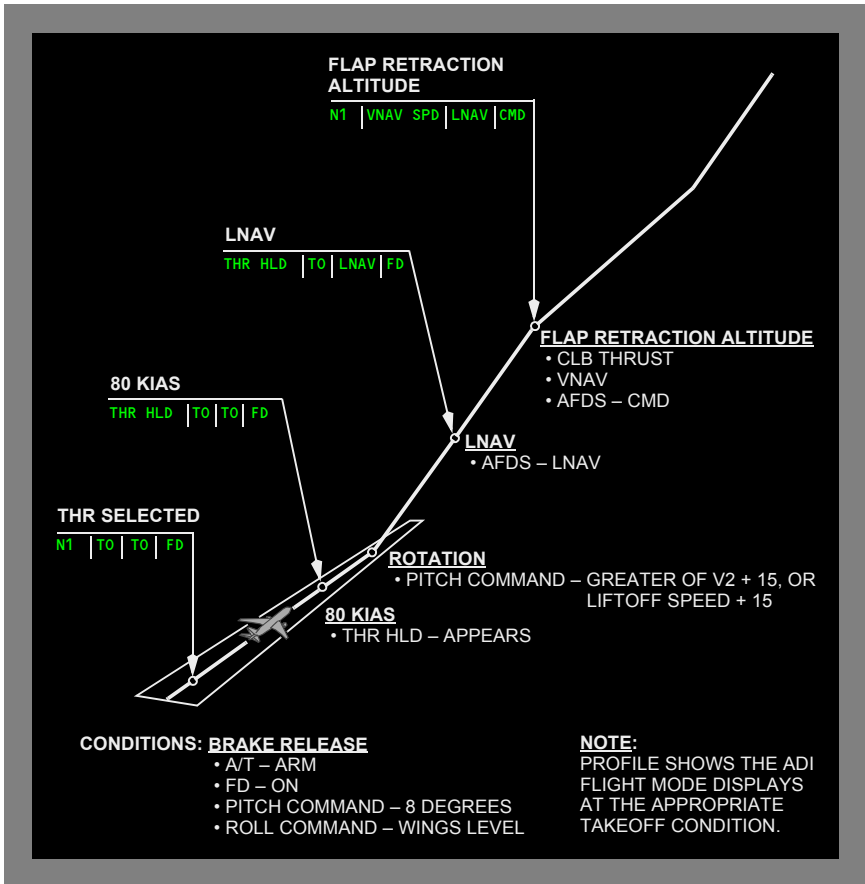

Takeoff is a flight director only function and can only be engaged on the ground. The autopilot is not used during the takeoff roll but may be engaged after liftoff.

During preflight:

- with the autopilot disengaged and both F/D switches OFF, activation of TO roll and pitch mode occurs when the first F/D switch is positioned ON
- FD displays as AFDS status and TO as the pitch and roll flight mode annunciations
- command steering bars come into view

On takeoff, prior to 80 knots IAS:

- pitch command is set to approximately eight degrees up
- roll command is wings level
- autothrottle is engaged by pushing THR switch, thrust levers advance to selected takeoff power

767 Flight Crew Operations Manual

- FMAs display N1 for autothrottle and TO for both pitch and roll modes
- FMAs display EPR for autothrottle and TO for both pitch and roll modes

During takeoff prior to lift-off:

[Option: Top flight mode annunciations]

- at 80 knots, autothrottle annunciation changes to THR HLD

At lift-off:

- pitch command greater of $V_2 + 15$ or liftoff speed + 15
- if an engine failure occurs on the ground, the pitch command target speed at lift-off is V_2 or airspeed at lift-off, whichever is greater
- roll command maintains ground track

After lift-off:

- FD TO modes are terminated by engaging an A/P in CMD, or selecting any other pitch or roll mode

[Option: Top flight mode annunciations]

- A/T remains in THR HLD mode at takeoff thrust until a pitch mode, A/T mode, or thrust reference mode select switch is pushed. The A/T then sets climb thrust or the selected reference thrust

[Basic: Fast / slow indicator.]

- Fast/Slow pointer appears on ADIs following selection of a thrust mode other than TO and a FD mode other than TO

Note: Autopilot elevator authority during a single autopilot operation is limited to reduce the effects of an autopilot malfunction. During altitude capture, there may be insufficient elevator authority and stabilizer trim rate to counteract pitch down, caused by the combination of thrust reduction, flap retraction and aft c.g.

Note: An altitude capture from a climb that includes a significant airspeed increase or thrust reduction may result in the autopilot descending away from the selected altitude in an attempt to increase the airspeed.

Automatic Flight – Cruise

The autopilot and/or flight director can be used after takeoff to fly a lateral navigation track (LNAV) and a vertical navigation track (VNAV) provided by the FMC. Using LNAV and VNAV ensures the most economical operation.

Automatic Flight – Approach and Landing

[Basic: Approach mode automatic autopilot selection.]

The AFDS provides guidance for multiple autopilot precision approaches. Pushing the APP switch arms localizer in the roll mode and glideslope in the pitch mode. Also, with an autopilot engaged, the remaining two autopilots automatically arm for a multiple autopilot approach.

[Basic: Glideslope inhibit before localizer capture.]

Glideslope capture is inhibited until the localizer is captured.

Pushing the LOC switch arms the AFDS for localizer tracking. Descent on the localizer can be accomplished using VNAV, FLCH, or V/S pitch modes. The localizer mode cannot capture if the intercept angle exceeds 120 degrees. All other nonprecision approaches can be flown using LNAV and VNAV modes, or HDG SEL or V/S modes.

Pushing the B/CRS switch in conjunction with the LOC switch will enable localizer backcourse tracking.

Runway Alignment and Asymmetric Thrust Compensation

AFDS controls rudder during multiple autopilot ILS approaches to compensate for engine-out asymmetric thrust conditions during an ILS approach.

With LAND 3 or LAND 2 annunciated, autopilot control of the rudder is active. The runway align submode is operative during multiple autopilot ILS approach. It reduces the crab angle established during crosswind conditions prior to automatic landing. The submode operates as follows:

- actuated at 500 feet radio altitude with LAND 3 or LAND 2 annunciated
- activation not displayed
- autopilot systems initiate a slip with a maximum bank angle of two degrees when the crab angle exceeds five degrees
- wing leveling from the slip is initiated when the ROLLOUT mode is engaged

If the autopilots are disengaged, manually or automatically, in an asymmetric thrust condition with rudder control active, the rudder moves to the trimmed position. The pilot may need to exert rudder pedal force to maintain a smooth transition to manual flying.

Flare

The flare maneuver brings the airplane to a smooth automatic landing touchdown. The flare submode is a multiple autopilot mode, and is not intended for single autopilot or flight director only operation.

At approximately 50 feet radio altitude, the autopilots start the flare maneuver. FLARE replaces the G/S pitch flight mode annunciation.

Flare arms when LAND 3 or LAND 2 annunciates.

During flare:

- at 15 feet radio altitude the autothrottle retards thrust levers to idle
- IDLE replaces the SPD autothrottle flight mode annunciation
- if slip exists due to runway align submode, wings leveled when ROLLOUT mode engaged
- autopilots start lowering nose wheel to runway at five feet radio altitude plus two seconds with pitch attitude less than two degrees
- at touchdown, the FLARE annunciation no longer displays, and the nose lowers to the runway

Note: During an approach with LAND 2 annunciated and below 100 feet radio altitude an increment of nose up trim is automatically applied for flare. If the autopilots are subsequently disengaged in the approach, a forward control column force of 20–30 pounds may be required to counter the automatic trim condition. If an automatic multi-autopilot go-around is performed, the increment of automatic trim is removed

Rollout

Rollout arms when LAND 3 or LAND 2 annunciates.

At approximately five feet radio altitude, rollout activates. ROLLOUT replaces the LOC roll flight mode annunciation.

The autopilot controls the rudder and nose wheel steering to keep the airplane on the localizer centerline.

Rollout guidance continues until a full stop or until the autopilots are disengaged.

During rollout, autothrottle IDLE mode remains active until the autothrottle disengages. Autothrottle disengagement occurs when either thrust lever is set in reverse thrust position. When selecting reverse thrust the A/T DISC caution light, AUTOTHROT DISC EICAS message and aural warning will not be activated.

Automatic Flight – Approach Profile

[Option: Top flight mode annunciations]

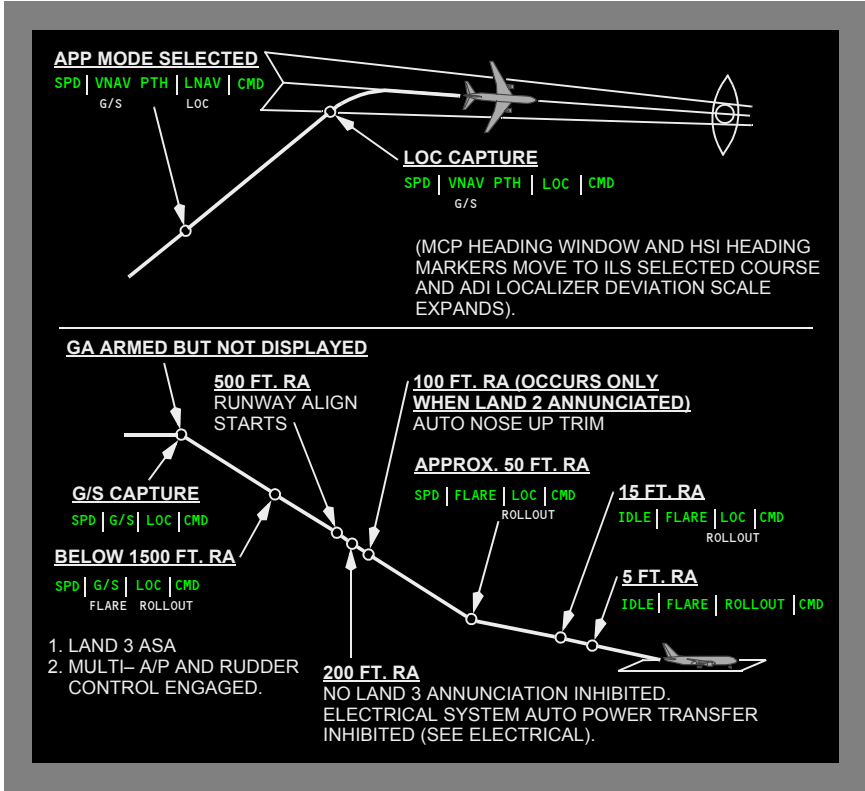

Automatic Flight – Go-Around

Pushing either GA switch activates a go-around using multiple autopilot, single autopilot or flight director only.

When the F/D switches are not on, pushing either GA switch displays the flight director bars.

Go-around arms and the reference thrust limit changes to GA when the flaps are out of up or glideslope is captured. Arming is not annunciated. GA remains armed until two seconds after five feet radio altitude. Pushing either GA switch during this period of the approach engages the GA mode. The mode remains active even if the airplane touches down while executing the go-around.

If the airplane is floating within five feet radio altitude for more than two seconds when the GA switch is pushed, the autopilot pitch mode will remain in FLARE and the autothrottle go-around mode will engage.

767 Flight Crew Operations Manual

If the airplane is on the ground but has been below five feet radio altitude for less than two seconds when the GA switch is pushed, the autopilot GA pitch mode will engage but the A/T mode will remain IDLE.

The GA switches are interlocked with the thrust reversers to prevent go-around mode engagement during reverse thrust operation.

Pushing either GA switch:

- roll and pitch activate in GA on the FMA
- autothrottle increases thrust to maintain a climb rate of at least 2000 fpm
- roll commands bank to maintain ground track
- AFDS increases pitch to hold existing speed or the selected MCP speed, whichever is higher, as thrust increases
- if flap setting is 20 or less, a thrust mode other than go-around can be selected

Note: Autopilot elevator authority during a single autopilot approach is limited to reduce the effects of an autopilot malfunction. If a go-around is initiated during a single autopilot approach, there may be insufficient elevator authority and stabilizer trim rate to counteract pitch up, caused by a rapid application of full go-around thrust. There is sufficient elevator authority to counteract pitchup when the go-around is flown using multiple autopilots, or manually (no autopilot), or when the autothrottle go-around mode is used to set a 2000 FPM climb rate.

GA level-off:

- at the selected altitude, the AFDS pitch flight mode annunciation changes to ALT CAP, then to ALT HOLD and autothrottle mode changes to SPD
- GA remains the active roll mode until another mode is selected
- landing gear and flaps must be operated manually

GA Mode Termination:

Below 400 feet radio altitude –

- if flap setting is 25 or 30, autothrottle remains in GA mode unless disengaged
- disengaged autopilot and turn off both flight directors

Above 400 feet radio altitude –

- select a different roll or pitch mode; all autopilots, except first in CMD, disengage

Note: If the autopilot systems are compensating for an asymmetric thrust condition when they revert to a single autopilot in CMD configuration, the rudder will return to the trimmed position unless the pilot exerts the rudder pedal force required to maintain the rudder position.

Automatic Flight – Windshear Recovery

The AFDS provides windshear recovery guidance by means of the normal go-around pitch and roll modes. With go-around armed, pushing a GA switch commands a pitch-up of 15 degrees or slightly below the pitch limit, whichever is lower.

When the autopilot is not engaged when go-around is initiated, the pilot must fly the windshear recovery following the flight director commands. If the autothrottle is not armed or engaged, the thrust levers must be advanced manually.

Auto Flight Limit Modes

Autothrottle Limit Modes

- FLAP LIM
- ALPHA
- SPD LIM

Pitch Limit Modes

- FLAP LIM
- SPD LIM

Flap placards speeds, airplane maximum angle of attack and maximum speed limit are automatically monitored by the AFDS and TMC. The appropriate speed limit mode annunciation of FLAP LIM, ALPHA, or SPD LIM is displayed when a speed limit is approached and the MCP selected speed or FMC target speed is set to exceed a limit. When the limit mode is displayed, the limit speed becomes the reference speed for the autothrottle and AFDS.

When the AFDS is engaged in a speed mode (FLCH, GA), the speed limit monitoring is accomplished by the AFDS. When approaching a speed limit, the appropriate limit mode annunciation, replaces the existing pitch mode.

The AFDS will not annunciate ALPHA when approaching maximum angle of attack speed, however, the alpha safe speed will be maintained by AFDS pitch.

[Basic: Fast / slow indicator.]

When the AFDS is not controlling speed, speed limit monitoring is accomplished by the TMC. When a speed limit is exceeded, the appropriate limit mode annunciation appears at the autothrottle mode position. The speed limit mode annunciations may appear when the autothrottles are engaged or not engaged.

[Basic: Fast / slow indicator.]

The Fast/Slow pointer changes color to amber and the pointer flashes when a speed limit is exceeded.

**Automatic Flight
EICAS Messages****Chapter 4
Section 30****Automatic Flight EICAS Messages**

The following EICAS messages can be displayed.

| Message | Level | Light | Aural | Condition |
|-----------|---------|---------------|--------|--|
| AUTOPILOT | Caution | AUTO PILOT | Beeper | The engaged autopilot is operating in a degraded mode. Engaged roll and/or pitch mode may have failed. |

[Basic: Autopilot disconnect siren.]

| | | | | |
|----------------|---------|-------------|-------|---------------------------------|
| AUTOPILOT DISC | Warning | A/P DISC | Siren | The autopilot has disconnected. |
|----------------|---------|-------------|-------|---------------------------------|

[Option: Autopilot disconnect wailer.]

| | | | | |
|----------------|---------|-------------|--------|---------------------------------|
| AUTOPILOT DISC | Warning | A/P DISC | Wailer | The autopilot has disconnected. |
|----------------|---------|-------------|--------|---------------------------------|

| | | | | |
|----------------|---------|-------------|--------|------------------------------------|
| AUTOTHROT DISC | Caution | A/T DISC | Beeper | The autothrottle has disconnected. |
|----------------|---------|-------------|--------|------------------------------------|

Intentionally
Blank

Communications**Chapter 5****Table of Contents****Section 0**

| | |
|---|-------------|
| Controls and Indicators | 5.10 |
| Audio Control Panel (ACP) | 5.10.1 |
| Pilot Call Panel | 5.10.2 |
| Radio System | 5.10.3 |
| VHF Communication Panel | 5.10.3 |
| HF Communication Panel | 5.10.4 |
| Miscellaneous Communication Controls | 5.10.5 |
| Control Wheel Microphone/Interphone Switch | 5.10.5 |
| Glareshield Push-To-Talk Switch | 5.10.5 |
| Service Interphone Switch | 5.10.6 |
| Flight Deck Speaker | 5.10.6 |
| Captain/First Officer Jack Panels | 5.10.7 |
| ACARS or SATCOM Control | 5.10.8 |
| ACARS Access Through Control Display Units (CDU) | 5.10.8 |
| Cockpit Voice Recorder Panel | 5.10.9 |
| System Description | 5.20 |
| Introduction | 5.20.1 |
| Audio Control Panels | 5.20.1 |
| Radio Communication Systems | 5.20.2 |
| HF Communication System | 5.20.2 |
| VHF Communication System | 5.20.2 |
| Selective Calling (SELCAL) System | 5.20.2 |
| Aircraft Communication Addressing and Reporting System (ACARS) | 5.20.3 |
| Voice Recorder System | 5.20.3 |
| Communication Crew Alerting System | 5.20.4 |
| Communication Alert Categories | 5.20.4 |
| Crew Communication or Selective Calling (SELCAL) Messages | 5.20.4 |

| | |
|--|-------------|
| Interphone Systems | 5.30 |
| Interphone Communication System..... | 5.30.1 |
| Flight Interphone System..... | 5.30.1 |
| Cabin Interphone System..... | 5.30.2 |
| Service Interphone System..... | 5.30.2 |
| Passenger Address System..... | 5.30.2 |
| Data Link System | 5.40 |
| Aircraft Communication Addressing and Reporting System (ACARS)..... | 5.40.1 |
| Control and Status Display..... | 5.40.1 |
| Control Through CDUs..... | 5.40.1 |
| Data Mode..... | 5.40.2 |
| Message Display..... | 5.40.2 |
| Voice Mode..... | 5.40.2 |
| Online ACARS Voice Mode..... | 5.40.3 |
| Air-to-Ground Voice Calls (Typical)..... | 5.40.3 |
| Ground-to-Air Voice Calls (Typical)..... | 5.40.3 |
| EICAS Messages | 5.50 |
| EICAS Communication Alert Messages..... | 5.50.1 |
| Crew Communication Messages..... | 5.50.1 |
| Selective Calling (SELCAL)..... | 5.50.1 |

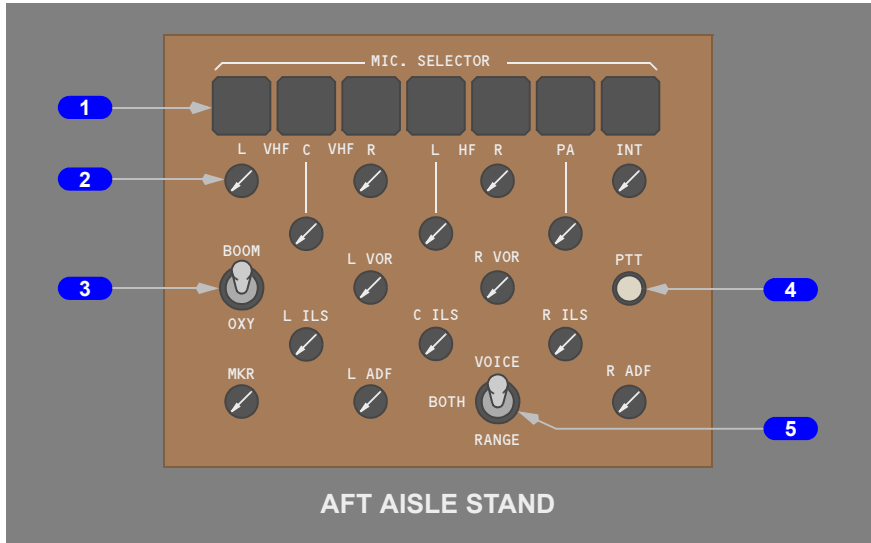
Audio Control Panel (ACP)**1 Microphone Selector Switches/Lights**

Push –

- the selected transmitter light illuminates
- the light for any other transmitter extinguishes
- selects the respective transmitter (radio or intercommunications) for transmission from this crew station (only one can be selected at a time for each crew station)
- selects the receiver audio on, if not already manually selected on

2 Receiver Control

Push – turns respective receiver ON/OFF at any volume setting.

Rotate – varies respective receiver volume.

3 Boom/Oxygen (BOOM/OXY) Switch

BOOM – transmit from the boom microphone.

OXY – transmit from the oxygen mask microphone.

4 Push-To-Talk (PTT) Switch

Push and hold – transmits on selected system.

5 Navigation Filter Selector

Filters VOR, ADF, or ILS audio:

- VOICE – only voice transmissions can be heard
- BOTH – voice transmissions and station identifiers can be heard
- RANGE – only station identifiers can be heard

Pilot Call Panel

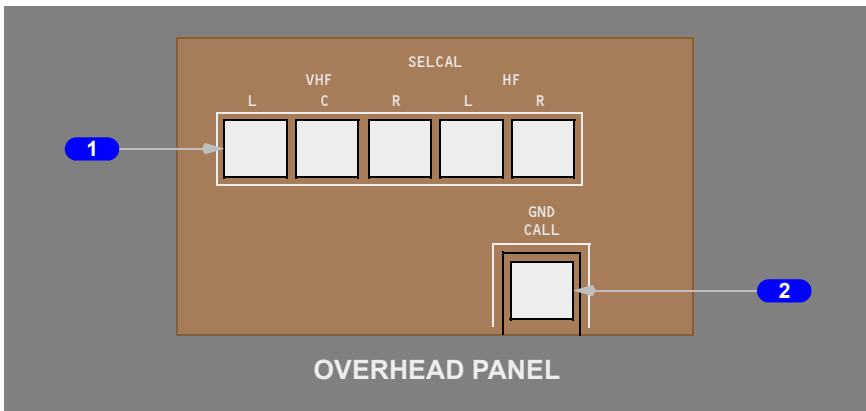

1 Selective Calling (SELCAL) Switch/Lights

Illuminated – indicates a radio call on SELCAL:

- resets when the respective transmitter is keyed or when light is pushed

2 Ground Call (GND CALL) Switch/Light

Illuminated – indicates a call from ground personnel:

- extinguishes after 30 seconds

Push – calls ground personnel as long as switch is pushed.

Radio System

VHF Communication Panel

Option: VHF radios with 8.33 KHZ spacing

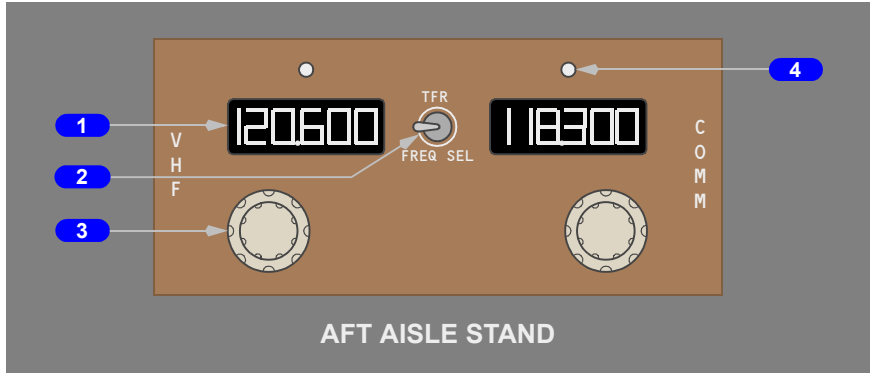

1 Frequency Window

Indicates the selected frequency.

2 Frequency Transfer (TFR) Switch

Selects which frequency is active for the transceiver.

3 Frequency Selector

Rotate – changes frequency in the window above:

- outer selector changes digits to the left of the decimal point
- inner selector changes digits to the right of the decimal point

4 Active Frequency Light

Illuminated – indicates which frequency has been selected by the frequency transfer switch.

HF Communication Panel



1 Frequency Window

Indicates the selected frequency.

2 Frequency Selectors

Selects the frequency shown in the Frequency Window:

Rotate left knob – changes the digits to the left of the decimal point.

Rotate right knob – changes the digits to the right of the decimal point.

3 Mode Selector

OFF – power removed from unit.

USB – sets the upper side band (USB) mode.

AM – sets the amplitude modulation (AM) mode.

4 SQUELCH Control

Rotate – adjusts the sensitivity of the HF receiver:

- (clockwise) increases sensitivity for reception of weak or distant stations
- (counter clockwise) decreases sensitivity to reduce noise and static

Note: Decreasing sensitivity too far prevents reception, including SELCAL monitoring of HF radio.

Miscellaneous Communication Controls

Control Wheel Microphone/Interphone Switch

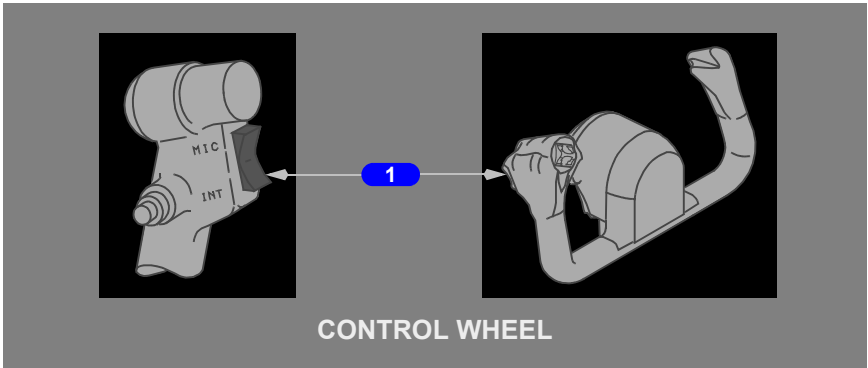

1 Control Wheel Microphone/Interphone (MIC/INT) Switch

Spring loaded to center (off) position.

MIC – allows transmission on the selected transmitter.

INT – allows transmission on the flight interphone system.

Glareshield Push-To-Talk Switch

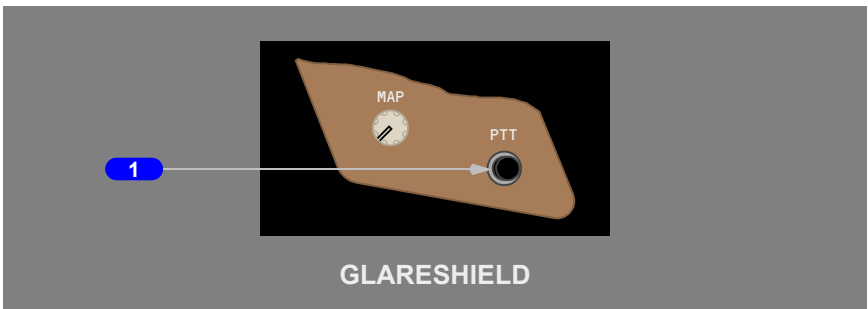

1 Glareshield Push-To-Talk (PTT) Switch

Push – allows transmission on the selected transmitter.

Service Interphone Switch

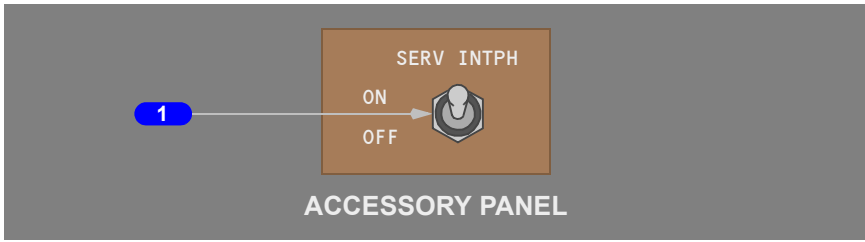

1 Service Interphone (SERV INTPH) Switch

ON – adds external (unpressurized area) headphone jacks to cabin interphone system.

OFF – deactivates external (unpressurized area) headphone jacks, except jack marked FLIGHT at the APU ground control panel.

Flight Deck Speaker

Options: Speaker has volume control in the center.

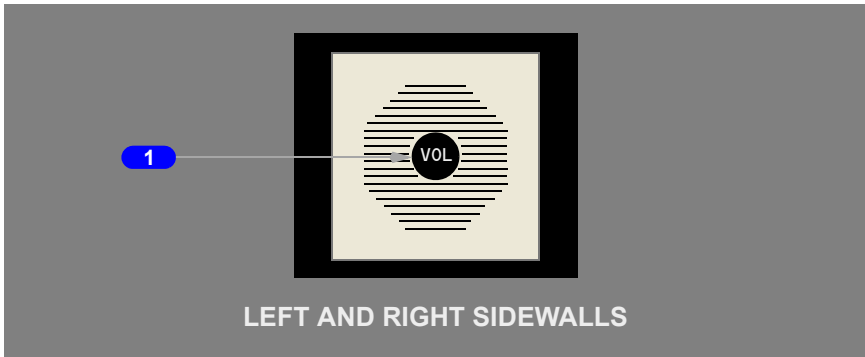

1 Flight Deck Speaker Volume Control

Rotate – adjusts speaker volume.

Captain/First Officer Jack Panels

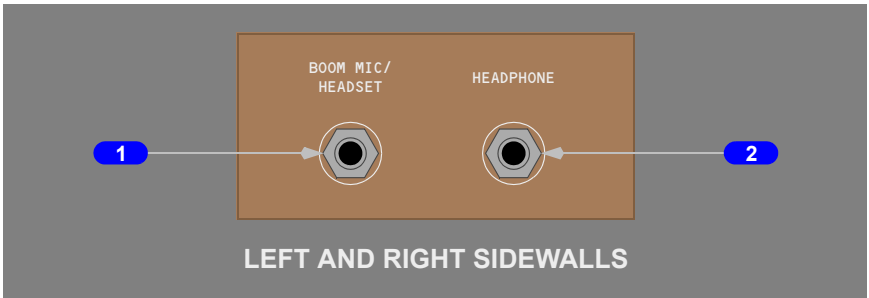

1 BOOM MIC/HEADSET Jack

Accepts a flight crew boom microphone/headset plug.

2 HEADPHONE Jack

Accepts a flight crew headphone plug.

ACARS or SATCOM Control

Option: ACARS installed

ACARS Access Through Control Display Units (CDU)

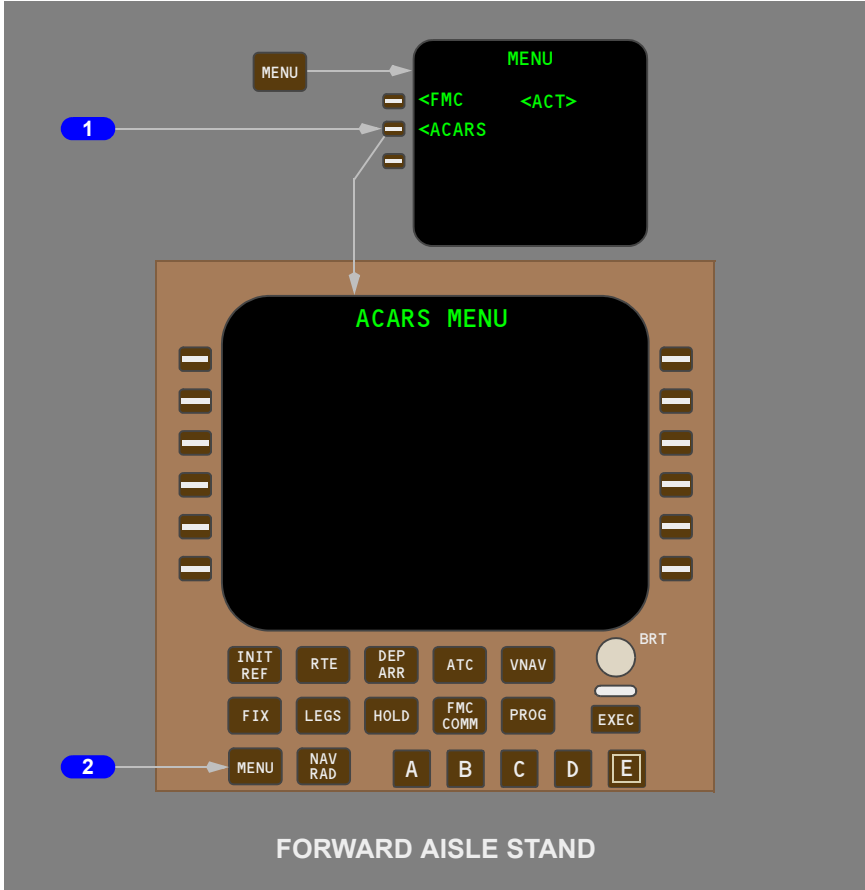

1 ACARS Line Select Key

Push – displays ACARS MENU page.

See section 40 of this chapter for description of ACARS operation.

2 MENU KEY

Push – displays MENU page.

See Chapter 11, Flight Management, Navigation for description of the FMC and associated software functions.

Cockpit Voice Recorder Panel

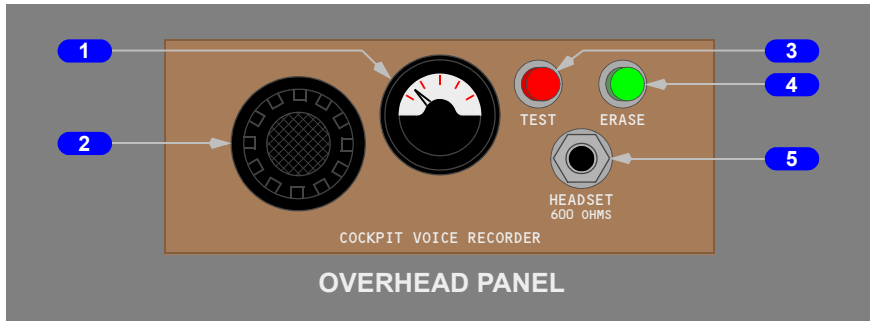

1 Monitor

During test, needle displaces to green band if all four channels are operating.

2 Microphone

Area microphone for the voice recorder.

3 TEST Switch

Push and hold – initiates cockpit voice recorder test.

4 ERASE Switch

Push (2 seconds) – erases the voice recorder (if on the ground, AC power on, and the parking brake is set).

5 HEADSET Jack

A headset may be plugged in to monitor playback of voice audio, or to monitor tone transmission during test.

Intentionally
Blank

Introduction

The communication systems include:

- radio communication system
- interphone communication system (refer to section 30 of this chapter)
- SELCAL system
- cockpit voice recorder system
- communication crew alerting system
- data communication system (refer to section 40 of this chapter)

The communication systems are controlled using the:

- audio control panels (ACP)
- pilots call panel (PCP)
- control panels for each communication radio
- control display unit (CDU) for controlling the data link (refer to section 40 of this chapter)

Audio Control Panels

The audio control panels (ACP) are used to manage the radio and interphone communication systems. Navigation receiver audio can also be monitored.

Systems are monitored using headphones or speakers. Receiver volume is controlled on the ACP by rotating the knob beneath the respective receiver.

A speaker volume control is located in the center of the speaker.

Microphones are keyed by pushing the desired audio control panel transmitter select switch and holding in a push-to-talk (PTT) switch. The PTT switches are located on:

- the control wheels
- the audio control panels
- the glareshield
- any hand microphone

There is a boom microphone on the headset, a microphone in the oxygen mask, and a hand microphone jack at all flight crew member stations.

When the BOOM/OXY switch on the ACP is in the OXY position, the oxygen mask microphone is enabled and the boom microphone is disabled. When the BOOM/OXY switch on the ACP is in the BOOM position, the oxygen mask microphone is disabled and the boom microphone is enabled.

Radio Communication Systems

The radio communication systems consist of:

- the high frequency (HF) communication system
- the very high frequency (VHF) communication system
- the selective calling (SELCAL) system

HF Communication System

Two independent HF communication radios are installed. These are designated HF L (left) and HF R (right). The ACPs are used to control voice transmission and receiver monitoring.

To tune the HF radio, rotate the frequency selectors on the HF communication panel. The left knob changes the digits to the left of the decimal point, and the right knob changes the digits to the right of the decimal point.

The sensitivity is adjusted by rotating the control knob. Rotating clockwise increases the sensitivity to receive weak or distant stations. Rotating counter clockwise decreases the sensitivity to decrease noise and static.

Note: Decreasing sensitivity too far prevents reception, including SELCAL monitoring of the HF radio.

Both HF radios use a common antenna. When either HF radio is transmitting, the antenna is disconnected from the other HF radio, and it cannot be used to transmit or receive. However, both HF radios can receive simultaneously if neither is being used for transmitting.

When an HF transmitter is keyed after a frequency change, the antenna tunes. While the antenna is being tuned, a tone can be heard through the audio system (tuning takes a maximum of 15 seconds).

VHF Communication System

Three independent VHF radios are installed, designated VHF L (left), VHF C (center), and VHF R (right).

Tuning is accomplished through communication panels (CP) for each radio.

Each VHF radio allows the tuning of two independent frequencies, an active and a standby frequency. These can be interchanged with the frequency transfer switch. The ACPs are used to control voice transmission and receiver monitoring.

Selective Calling (SELCAL) System

The SELCAL system monitors all of the communication radios. When the system receives a properly encoded call from a ground station, the crew is alerted through the illumination of the corresponding light on the pilot's call panel.

The flight crew is also alerted to an incoming call by an aural chime and the SELCAL communication message on the EICAS display. Refer to section 50 of this chapter for a list of possible messages.

Aircraft Communication Addressing and Reporting System (ACARS)

Options: ACARS operational

ACARS data and voice modes provide automatic and manual means to transmit and receive operational, maintenance, and administrative information between the airplane and a ground station. ACARS is operational when electrical power is established. The ACARS systems descriptions provided in this section are limited to manual selection of ACARS radio operating modes. Refer to section 40 of this chapter for additional information about ACARS operation and control.

ACARS communicates incoming and outgoing data and messages through:

- the center VHF radio

ACARS provides for automatic and manual control, including mode selection, of the dedicated ACARS radio through the ACARS management unit. Refer to section 40 of this chapter for description of this function.

The VHF communication panel for the ACARS dedicated radio does not provide a means to select offline voice mode and ACARS switching panels are not installed. Control of the ACARS dedicated radio may be transferred to the VHF communication panel through menu selection on the CDU/ACARS IDU or depressing the VOICE/VOX mode switch on the ACARS MIDU/CU. Refer to section 40 of this chapter for description of this function.

Voice Recorder System

The cockpit voice recorder records any transmitted or received flight deck audio transmissions from the flight deck made through the audio control panels. It also records flight deck area conversations using an area microphone.

All inputs are recorded continuously anytime AC power is applied to the airplane.

Communication Crew Alerting System

Options: EICAS 1001 computer installed or not

The communication crew alerting system provides aural and visual alerts for normal operations requiring crew awareness that may require crew action. Visual alerts are presented as EICAS communication level messages preceded by a white bullet symbol (•). The aural alert is a single chime. The following table shows communication crew alert categories and the respective aural and visual alerts for each category. Refer to section 50 of this chapter for a list of possible messages.

Communication Alert Categories

| Alert Category | Aural | Visual | Remarks |
|----------------|-------|--|--|
| Medium | Chime | EICAS communication alert. Illumination of appropriate switch/light on the PCP or ACP. | Message awareness required. Crew action may be required. |
| Low | None | EICAS communication alert. | Crew action may be required. |

Crew Communication or Selective Calling (SELCAL) Messages

The communication crew alerting system also provides a supplementary method of notifying the flight crew about incoming calls from the cabin, ground personnel, or an incoming radio call. The •SELCAL message is a medium category alert. The flight crew should respond by establishing interphone communications with the calling station or transmitting on the corresponding radio.

Interphone Communication System

The interphone communication system includes the:

- flight interphone system
- service interphone system
- cabin interphone system
- passenger address (PA) system

The interphone systems allow the flight crew to communicate with the flight attendants, ground personnel, or maintenance technicians. The PA system allows flight attendants or the flight crew to make announcements in the passenger cabin. The flight interphone, service interphone, cabin interphone, and passenger address systems are normally operated through the audio control panel (ACP) in conjunction with the pilot call panel (PCP).

Flight Interphone System

The flight interphone system (FIS) permits communication between flight deck crew members and, on the ground, with ground personnel.

The system is used by the following methods:

- pushing the interphone (INT) position of a control wheel mic/interphone switch to transmit
- selecting interphone (INT) transmitter select switch on the ACP and pushing a PTT switch

Ground personnel are able to communicate on the FIS through a jack located on the APU ground control panel mounted on the nose wheel strut.

The pilots are alerted to an incoming call from the ground crew by the following methods:

- an aural chime sounds in the flight deck
- an illuminated GND CALL light on the PCP
- the EICAS communication message GROUND CALL is displayed

The flight crew should respond to the call using the FIS. Any of the PTT switches may be used to communicate

The flight crew initiates a call to ground personnel by pushing the GND CALL switch. A horn in the nose wheel well activates as long as the switch is pushed. Communication can then take place over the FIS.

Cabin Interphone System

The cabin interphone system (CIS) provides voice communications between the flight deck and the flight attendant stations. Flight deck crew members communicate on the CIS using their ACP and the PCP. The flight crew may use the boom microphones, oxygen mask microphones, or hand microphones to transmit.

The pilots are alerted to incoming calls from the cabin by the following methods:

- an aural chime sounds in the flight deck
- EICAS communications messages CABIN ALERT or CABIN CALL

The flight attendants communicate between flight attendant stations or with the flight deck using any of the handsets in the cabin. The system is a party line in that anyone who picks up a handset is automatically connected to the system.

Service Interphone System

The service interphone system consists of additional internal and external jacks connected to the flight/cabin interphone system for use by maintenance personnel. The flight/cabin interphone system can be connected to the service interphone system by placing the service interphone switch in the ON position. To reduce external noise in the flight/cabin interphone system, the service interphone switch can be left OFF during normal flight operations. This disconnects the microphone jacks at all exterior (unpressurized) service interphone stations except the jack on the nose wheel strut. This switch does not affect the interior flight/cabin interphone stations.

Passenger Address System

The passenger address (PA) system allows flight deck crew members and flight attendants to make announcements throughout the cabin. Flight deck crew members can make announcements with any microphone by pushing the PA transmitter select switch on an audio control panel. Then, pressing any of the PTT switches will key the system for PA announcements.

The PA system is monitored on the flight deck by pushing the PA receiver volume control on an audio control panel and adjusting the volume. This will adjust the audio volume to the pilot's headset only. It does not adjust the volume of the output broadcast over the PA system.

The cabin PA announcement priorities are:

- flight deck announcements
- cabin announcements made from any flight attendant station
- pre-recorded announcements
- boarding music

PA announcements from any station override all passenger cabin pre-recorded announcements and passenger entertainment outputs.

Intentionally
Blank

Aircraft Communication Addressing and Reporting System (ACARS)

The Aircraft Communications Addressing and Reporting System (ACARS) is a data link system designed to automatically communicate flight data, performance data, and routine reports between the airplane and a network of ground stations.

The primary airborne system component is the ACARS management unit (MU). The MU provides the central clock, memory, and data processor for ACARS. For airborne event sensing and flight crew alerting, the MU interfaces with:

- the SELCAL system

The ACARS MU collects, controls, and processes incoming and outgoing data and messages through:

- the VHF radio system

The dedicated ACARS radio is normally operated in data mode for automatic transmission of data and message traffic. Refer to section 20 of this chapter for a description of the ACARS capable VHF or HF radio systems.

Control and Status Display

The flight crew access to ACARS status or control is through:

- control display unit (CDU)

ACARS installations include airline modifiable buyer furnished equipment (BFE). The ACARS system descriptions and menu page illustrations presented represent typical installations. Airline configuration of BFE equipment can make significant changes in operational menus which are not presented here.

Control Through CDUs

Flight crew access to ACARS is through a control display unit (CDU). Selecting the line select key adjacent to the <ACARS prompt will call up the ACARS Main Menu Page. From this page all ACARS functions may be accessed, such as pre-flight initialization, systems status checks, ACARS radio control, message status or display, printer functions, and ACARS configuration.

The specific software providing ACARS functionality is defined by the airline and is not covered here.

Data Mode

ACARS is normally operated in the data mode, allowing automatic transmission of routine reports, engine and performance data. In data mode, the system monitors and stores the times of the following events:

- OUT – airplane departure from the gate, based on customer defined parameters (e.g. closure of all passenger entry doors and parking brake released)
- OFF – takeoff (main gear tilted)
- ON – landing (main gear not tilted)
- IN – airplane arrival at destination gate, based on customer defined parameters (e.g. parking brake set and at least one passenger entry door open)

The system automatically transmits OOOI events at occurrence. In data mode, the MU automatically tunes the ACARS dedicated radio to a standard link frequency. ACARS monitors this frequency for messages addressed to that airplane as well as sending messages to the ground.

In addition to transmitting routine data automatically, ACARS allows manual data entry for subsequent transmission to ground stations. Engine parameters, fuel status, and other information can be conveyed to a ground station by entering values on the appropriate page and pressing the SEND key.

Pre-flight data such as flight number, fuel on board, and departure/destination station can be entered in the ACARS system manually, or received by data uplink.

Message Display

ACARS messages to or from the airplane can be displayed on the CDU through the STORED MESSAGES pages. Message titles appear in large characters until displayed. Messages can be sent to the printer by pressing the PRINT line select key.

Voice Mode

The ACARS system provides a voice mode to facilitate voice communications between the airplane and groundstations. The ACARS system descriptions presented are general in scope and represent typical installations. Airline configuration of BFE equipment can make significant changes in operational menus which are not presented here.

Online ACARS Voice Mode

Online voice mode provides an ARINC compatible communication link to ground based telephone systems. ACARS voice mode communications are initiated either from the airplane or the ground. When online voice mode is initiated the ACARS MU will continue to compile, but not transmit, data and message traffic. The MU will notify the flight crew whenever voice mode operations exceed two minutes.

Air-to-Ground Voice Calls (Typical)

To initiate an ACARS voice call, use the ACARS menu pages and request the call. The applicable phone number is automatically dialed with the downlink request and voice mode is automatically selected when the call is connected. When the call is connected, the ACARS system will annunciate the call with an aural chime and the appropriate SELCAL switchlight on the PCP or ACP (VHF C or VHF R) will illuminate.

To complete the call push the applicable microphone selector switch on the ACP and adjust the volume (if required). Push a push-to-talk (PTT) switch for microphone operation. Use a boom microphone headset or other flight interphone system to speak and listen to the call. When the call is stopped the MU will automatically return to data mode.

Ground-to-Air Voice Calls (Typical)

When an ACARS voice radio communication is received, the corresponding SELCAL light illuminates and an aural chime sounds on the flight deck. Received calls are automatically connected. ACARS voice mode is automatically selected and does not require flight crew action from the ACARS menu pages. To receive a call push the illuminated VHF C or VHF R microphone selector switch on the ACP, push a PTT switch, and begin the call.

The flight crew may also respond to a ground initiated voice call by selecting the appropriate responses on the ACARS menu pages and pushing the illuminated CALL microphone selector switch on the ACP.

Intentionally
Blank

EICAS Communication Alert Messages

This section describes the various EICAS communications alert messages that can be displayed.

Crew Communication Messages

| Message | Level | Condition | Crew Action/Remarks |
|----------------|--------------|--|--|
| • CABIN ALERT | Medium | Pilot alert received over cabin interphone. | Respond to the alert. Message accompanied by aural chime and ALERT cabin call light. |
| • CABIN CALL | Medium | Pilot call received over cabin interphone. | Respond to the call. Message accompanied by aural chime and FWD/MID/AFT cabin call light. |
| • GROUND CALL | Medium | Pilot call received from the nose wheel well over the flight interphone. | Respond to the call. Message accompanied by aural chime and GND CALL light. |

Selective Calling (SELCAL)

| Message | Level | Condition | Crew Action/Remarks |
|----------------|--------------|-------------------------------------|---|
| • SELCAL | Medium | SELCAL received on VHF or HF radio. | Determine which radio received call. Respond to the call. Message is accompanied by aural chime and VHF/HF SELCAL light. |

Intentionally
Blank

Electrical**Chapter 6****Table of Contents****Section 0**

| | |
|--|-------------|
| Controls and Indicators | 6.10 |
| Electrical Panel | 6.10.1 |
| Battery/Standby Control Panel | 6.10.3 |
| Hydraulic Generator Test Switch | 6.10.4 |
| System Description | 6.20 |
| Introduction | 6.20.1 |
| AC Electrical System | 6.20.1 |
| AC Electrical System Power Sources | 6.20.1 |
| AC Electrical Power Distribution | 6.20.2 |
| AC Electrical System Schematic (Hydraulic Driven Generator) | 6.20.6 |
| DC Electrical System | 6.20.6 |
| DC Electrical System Schematic | 6.20.8 |
| Battery/Standby Power System | 6.20.9 |
| Hot Battery Bus | 6.20.9 |
| Battery Bus | 6.20.9 |
| Standby DC Bus | 6.20.9 |
| Standby AC Bus | 6.20.10 |
| Battery/Standby System Schematic | 6.20.11 |
| Hydraulic Driven Generator | 6.20.11 |
| Battery/Standby System Schematic (Hydraulic Driven Generator Operating) | 6.20.12 |
| EICAS Messages | 6.30 |
| Electrical EICAS Messages | 6.30.1 |

Intentionally
Blank

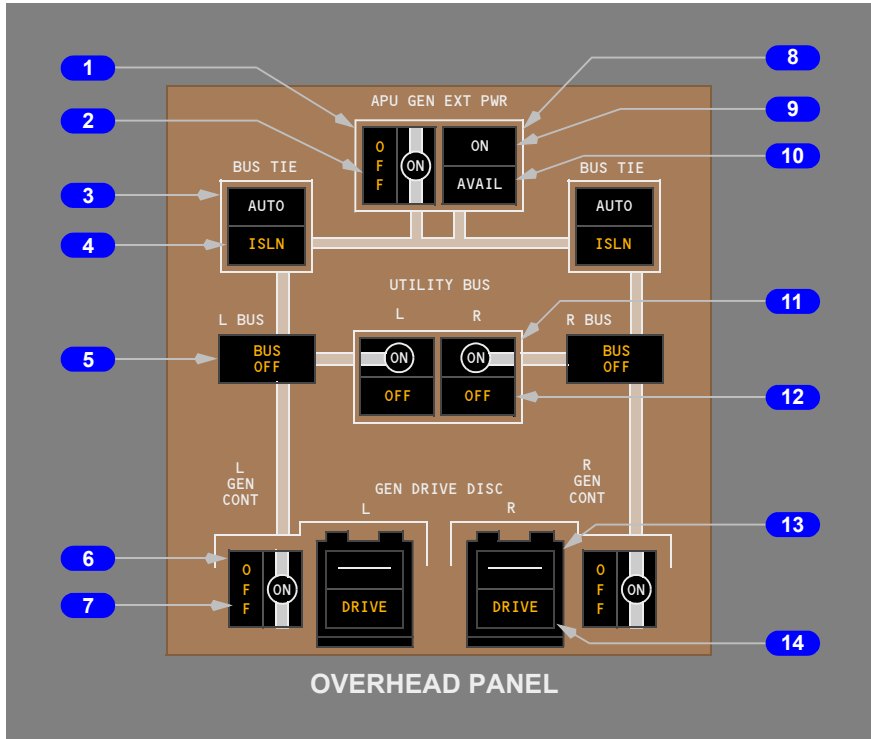
Electrical Panel**1 APU Generator (APU GEN) Control Switch**

ON (bar in view) –

- arms APU generator breaker to automatically close.

OFF (bar not visible) –

- opens APU generator breaker
- resets fault trip circuitry.

2 APU Generator OFF Light

Illuminated (amber) –

- the APU generator breaker is open because of a fault with APU running
- the APU generator control switch is selected OFF.

3 BUS TIE Switches

AUTO –

- arms automatic AC bus tie circuits
- arms automatic DC bus tie circuits
- arms automatic flight instrument transfer bus circuits.

OFF (AUTO not visible) –

- commands the AC bus tie open
- commands the DC bus tie open
- commands the flight instrument bus tie open
- resets fault trip circuitry.

4 AC Bus Isolation (ISLN) Lights

Illuminated (amber) –

- a fault has occurred, automatically opening the AC bus tie breaker
- the BUS TIE switch is OFF.

5 AC BUS OFF Lights

Illuminated (amber) – the AC bus is unpowered.

6 Generator Control (GEN CONT) Switches

ON (bar in view) – arms the generator breaker to close automatically when generator power is available.

OFF (bar not visible)

- opens generator breaker
- resets fault trip circuitry.

7 Generator OFF Lights

Illuminated (amber) – the generator breaker is open.

8 External Power (EXT PWR) Switch

Push – if AVAIL light is illuminated, closes external power contactor

Subsequent push – opens external power contactor.

9 External Power ON Light

Illuminated (white) – external power is powering the bus(es).

10 External Power Available (AVAIL) Light

Illuminated (white) – external power is plugged in and power quality is acceptable.

11 UTILITY BUS Switches

ON (bar in view) – if no load shed signal is present, connects utility and galley busses to main AC bus.

OFF (bar not visible) –

- disconnects utility and galley busses from main AC bus
- resets overload load shed circuitry.

12 Utility Bus OFF Lights

Illuminated (amber) – the utility and galley busses are unpowered.

13 Generator Drive Disconnect (GEN DRIVE DISC) Switches

Push –

- disconnects generator drive from the engine
- requires maintenance action on the ground to reconnect the generator drive.

14 Generator DRIVE Lights

Illuminated (amber) –

- the generator drive oil temperature is high
- the generator drive oil pressure is low.

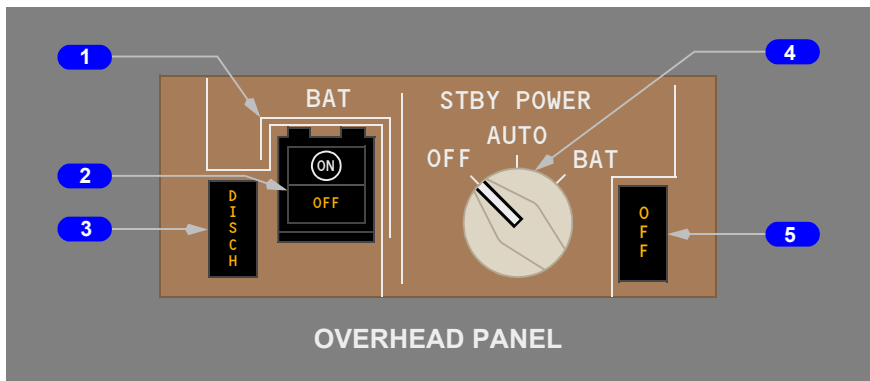
Battery/Standby Control Panel

1 Battery (BAT) Switch

ON –

- Unpowered airplane on the ground:
 - a few annunciator lights illuminate
 - allows the APU to be started
- Powered airplane in flight or on the ground when AC power is removed or lost:
 - the standby and battery busses are powered.

OFF (ON not visible) – turns battery power off.

2 Battery OFF Light

Illuminated (amber) – the battery switch is off.

3 Battery Discharge (DISCH) Light

Illuminated (amber) – the main battery is discharging.

4 Standby (STBY) POWER Selector –

OFF – the standby busses are unpowered.

AUTO – the standby busses transfer to battery power if normal AC power is lost.

BAT – the standby busses are powered from the main battery.

5 Standby Power Bus OFF Light

Illuminated (amber) – standby AC or DC bus not powered.

Hydraulic Generator Test Switch

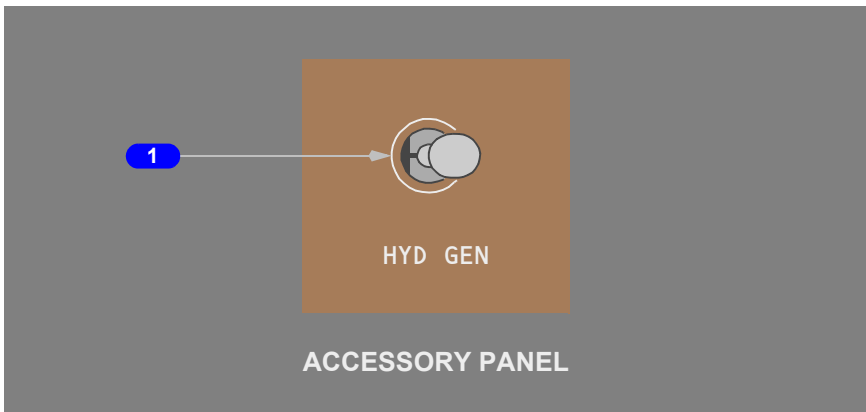

1 Hydraulic Generator Test Switch

Spring-loaded to center.

HYD GEN – initiates hydraulic driven generator system test.

Intentionally
Blank

Introduction

The electrical system generates and distributes AC and DC power to other airplane systems, and is comprised of: main AC power, main DC power, and battery/standby power. System operation is automatic. Electrical faults are automatically detected and isolated.

A hydraulic driven generator operates automatically as a backup source of power in the event that both main AC buses become inoperative.

AC Electrical System

The AC electrical system is the main source for airplane electrical power.

AC Electrical System Power Sources

The entire airplane AC electrical load can be supplied by any two main airplane AC power sources.

The main airplane AC electrical power sources are:

- left and right engine integrated drive generators (IDGs)
- APU generator.

The entire airplane AC electrical load also can be supplied by external power.

The power sources operate isolated from one another.

Integrated Drive Generators (IDGs)

Each engine has an IDG. Each IDG has automatic control and system protection functions.

When an engine starts, with the GEN CONT switch selected ON, the IDG automatically powers the respective main bus. The previous power source is disconnected from that bus.

The IDG can be electrically disconnected from the busses by pushing the GEN CONT switch to OFF. The IDG can also be electrically disconnected from its respective bus by selecting external power prior to engine shutdown. (See External Power in this section.)

The OFF light in the GEN CONT switch illuminates, and the EICAS Advisory message L or R GEN OFF displays whenever the generator control breaker is open.

The DRIVE light illuminates and the EICAS Advisory message L or R GEN DRIVE displays when low oil pressure or high oil temperature is detected in an IDG. The IDG drive can be disconnected from the engine by pushing the respective DRIVE DISC switch. The IDG cannot be reconnected by the flight crew.

APU Generator

The APU generator is electrically identical to the IDG generators. The APU generator can power either or both main busses, and may be used in flight as a replacement to an IDG source.

If no other power source is available when the APU generator becomes available, the APU generator automatically connects to both main AC busses. If the external source is powering both main busses, the external source continues to power both main busses.

The APU Generator OFF light illuminates, and the EICAS advisory message APU GEN OFF displays when the APU is operating and the APU generator breaker is open because of a fault or the APU GEN switch is selected OFF. When the APU GENERATOR switch is ON and a fault is detected, the APU generator cannot connect to the busses.

External Power

External power can power the left and right main busses. When the power source voltage and frequency are within limits, the external power AVAIL light illuminates.

Pushing the EXT PWR switch ON connects external power to both main busses and removes the IDGs and the APU generator from the busses, if they were powering the busses. When external power is connected to a main bus, the EXTERNAL POWER ON light illuminates.

AC Electrical Power Distribution

AC power is distributed through the left and right main busses and the ground service bus.

AC Main Busses

The right IDG normally powers the right main bus and the left IDG normally powers the left main bus. The APU normally powers both main busses when they are not powered by any other source. External power may also be connected and will also power both main busses.

Bus tie breakers, controlled by BUS TIE switches, isolate or parallel the right and left main busses. When both BUS TIE switches are set to AUTO, the bus tie system operates automatically to maintain power to both main busses.

767 Flight Crew Operations Manual

The AC bus ISLN light illuminates and the EICAS advisory message L or R BUS ISOLATED displays when the bus tie breaker is open because of a fault or the BUS TIE switch is OFF.

The BUS OFF light illuminates and the EICAS caution message L or R AC BUS OFF displays if an AC bus is unpowered.

The source order for powering left and right main busses is the:

- respective IDG
- APU generator
- opposite IDG.

Utility Busses

Left and right utility busses, powered by their respective main AC bus, are controlled by UTILITY BUS switches. Left and right galley busses are powered by their respective utility busses, and have no direct controls or indicators. The utility bus OFF lights illuminate and the EICAS advisory message L or R UTIL BUS OFF displays when a galley and utility bus are unpowered.

Ground Service Bus

The ground service bus is normally powered by the right main bus. Alternate sources of power for the ground service bus are:

- the APU generator
- external power.

The ground service bus powers:

- the main battery charger
- the APU battery charger
- miscellaneous cabin and system loads.

Ground Handling Bus

The ground handling bus can be powered only on the ground and only from the APU generator or from the external power source. It is provided for loads such as cargo handling and equipment energized only during ground operations.

Autoland

During autoland, the busses isolate to allow three independent sources to power the three autopilots:

- the left main system powers the left autopilot and the captain's flight instrument transfer bus
- the right main system powers the right autopilot and the first officer's flight instrument transfer bus
- the battery/standby system powers the center autopilot.

Above 200 feet, loss of a generator results in:

- both bus tie breakers closing and the operating generator powers both left and right AC busses
- the left main system powers the center autopilot
- NO LAND 3 appears on the Autoland Status Annunciator.

Below 200 feet, loss of a generator results in:

- both bus tie breakers remaining open
- the autopilot associated with a failed generator is unpowered
- the flight instruments remain powered through the flight instrument transfer busses
- the autoland continues using the remaining two autopilots.

When the autopilots are disengaged or an autopilot go-around is performed, the electrical system reverts to normal, non-isolated operation.

Flight Instrument Transfer Busses

Normally, the captain's flight instruments are powered by the left main AC Bus, and the first officer's flight instruments are powered by the right main AC Bus. If the respective bus tie breakers are in AUTO, the flight instrument transfer busses transfer to the opposite main AC bus in the event power is lost to a main AC Bus.

If power is lost to both main AC busses, the captain's flight instruments are powered by the hydraulic driven generator.

AC Transfer Busses

Left and right AC transfer busses power items considered necessary for ETOPS flights, which are not powered by the battery/standby system. Transfer busses are normally powered by their associated main AC busses, but also can be powered by the Hydraulic Driven Generator when both AC busses are unpowered.

Electrical Load Shedding

Electrical load shedding occurs automatically to ensure power is available to critical and essential equipment.

If the electrical loads exceed the power available, the electrical system automatically sheds AC loads by priority until the loads are within the capacity of the generators. The load shedding is galley power first, then utility busses. Utility busses are followed by individual equipment items powered by the main AC busses. When an additional power source becomes available or the load decreases, the electrical system automatically restores power to the shed systems (in the reverse order).

Examples of load shedding that may be observed during normal operations include:

- an electric hydraulic pump prior to engine start
- center tank fuel pumps prior to engine start
- utility busses during engine start.

Examples of load shedding that may be observed during non-normal operations include:

- utility busses after a generator failure
- center tank fuel pump after an engine failure
- cabin ceiling lights after an engine failure.

On the ground, advancing the thrust levers into the takeoff range with the engines shut down may cause inadvertent load shedding of the utility busses to occur. Returning the thrust levers to idle, then pushing the UTILITY BUS switches OFF, then ON will reset this inadvertent load shedding.

AC Electrical System Schematic (Hydraulic Driven Generator)

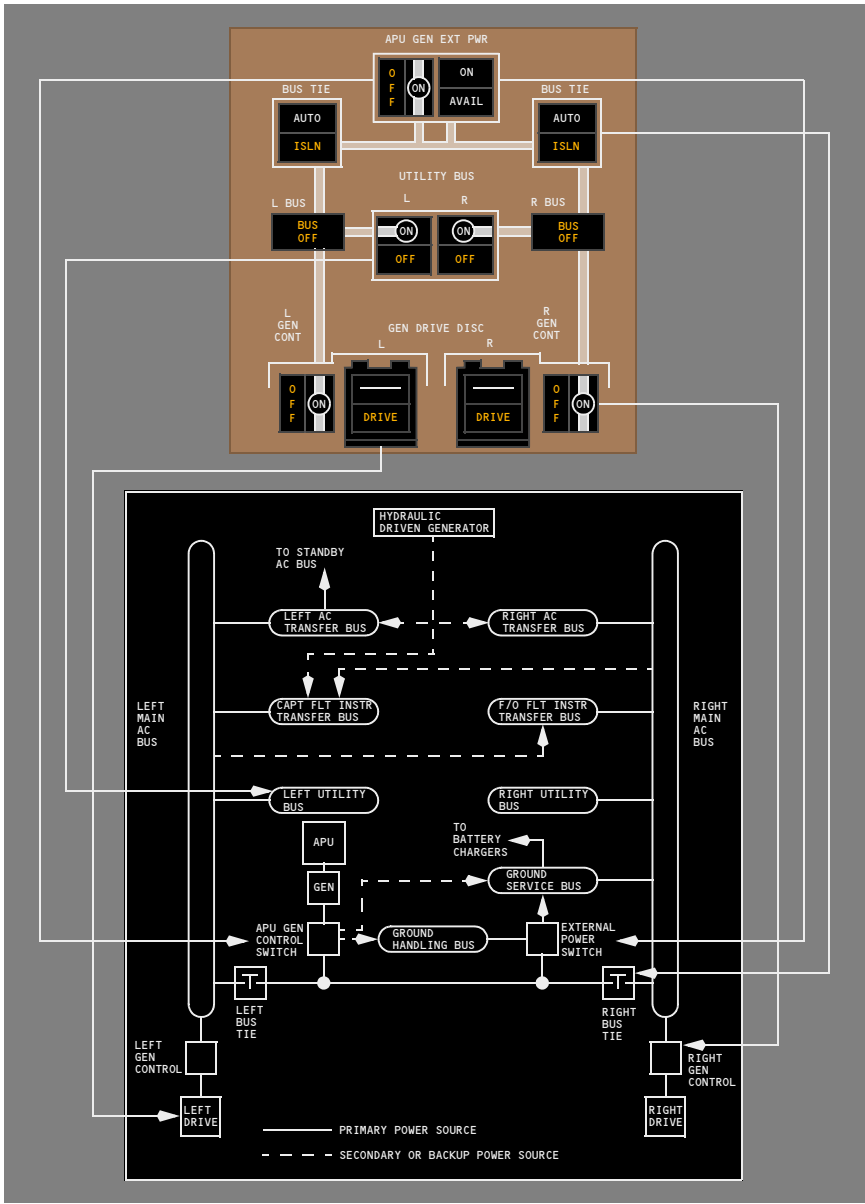

DC Electrical System

The main DC electrical system uses transformer-rectifier units (TRUs) to produce DC power. The TRUs are powered by the main AC busses.

767 Flight Crew Operations Manual

The TRUs operate isolated from one another. If one TRU fails, the DC bus tie breaker closes to keep both DC busses powered. Both BUS TIE switches must be in AUTO for the DC bus tie breaker to close.

There are no flight deck controls for the main DC electrical system.

DC Electrical System Schematic

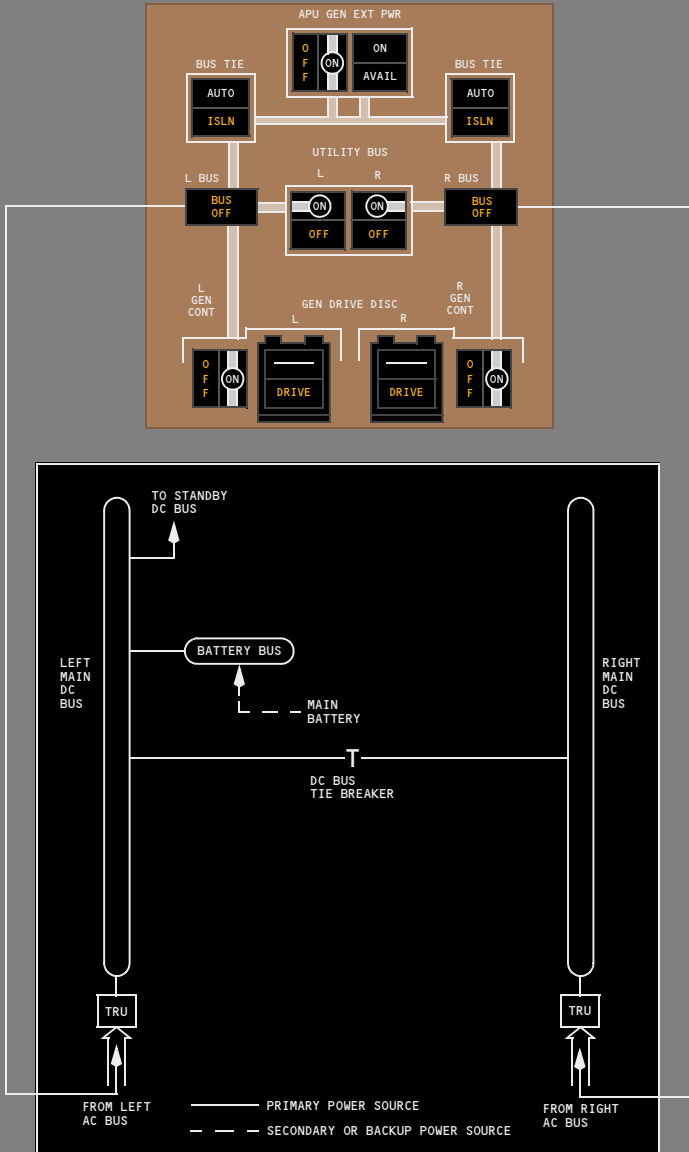

Battery/Standby Power System

The battery/standby power electrical system can supply DC and AC power to selected flight instruments, communications and navigation systems, and other critical systems, if there are main AC and DC electrical power system failures.

The Battery/Standby Power System consists of the following busses:

- the hot battery bus
- the battery bus
- the standby AC bus
- the standby DC bus

Hot Battery Bus

The hot battery bus provides power to items which must be continuously powered, such as the clock's time reference.

Prior to establishing electrical power, the main battery powers the hot battery bus.

After establishing electrical power, the main battery charger powers the hot battery bus.

Battery Bus

Prior to establishing electrical power, when the battery switch is ON, the main battery powers the battery bus.

After establishing electrical power, the left DC system powers the battery bus, and the main battery provides a backup source of power.

The Battery DISCH light illuminates when the main battery is discharging. If EICAS is powered, the advisory message MAIN BAT DISCH also displays.

The battery OFF light illuminates and the EICAS advisory message BATTERY OFF displays if the battery switch is OFF after electrical power is established.

Standby DC Bus

The standby DC bus can be powered by several sources. Prior to establishing electrical power, when the battery switch is ON and the standby power selector is in AUTO, the main battery powers the standby DC bus. The Battery DISCH light illuminates when the main battery is discharging. After establishing electrical power, the left DC system powers the standby DC bus and the main battery provides a backup source of power. When the standby power selector is in BAT, the main battery powers the standby DC bus.

The standby bus OFF light illuminates and the EICAS advisory message STANDBY BUS OFF displays if the standby DC bus is not powered.

Standby AC Bus

The standby AC bus can be powered by several sources. Prior to establishing electrical power, when the battery switch is ON and the standby power selector is in AUTO, the main battery powers the standby inverter which provides AC power to the standby AC bus. After establishing electrical power, the left AC system powers the standby AC bus and the main battery and standby inverter provide a backup source of power. When the standby power selector is in BAT, the main battery and standby inverter power the standby AC bus.

The standby bus OFF light illuminates and the EICAS advisory message STANDBY BUS OFF displays if the standby AC bus is not powered.

Battery/Standby System Schematic

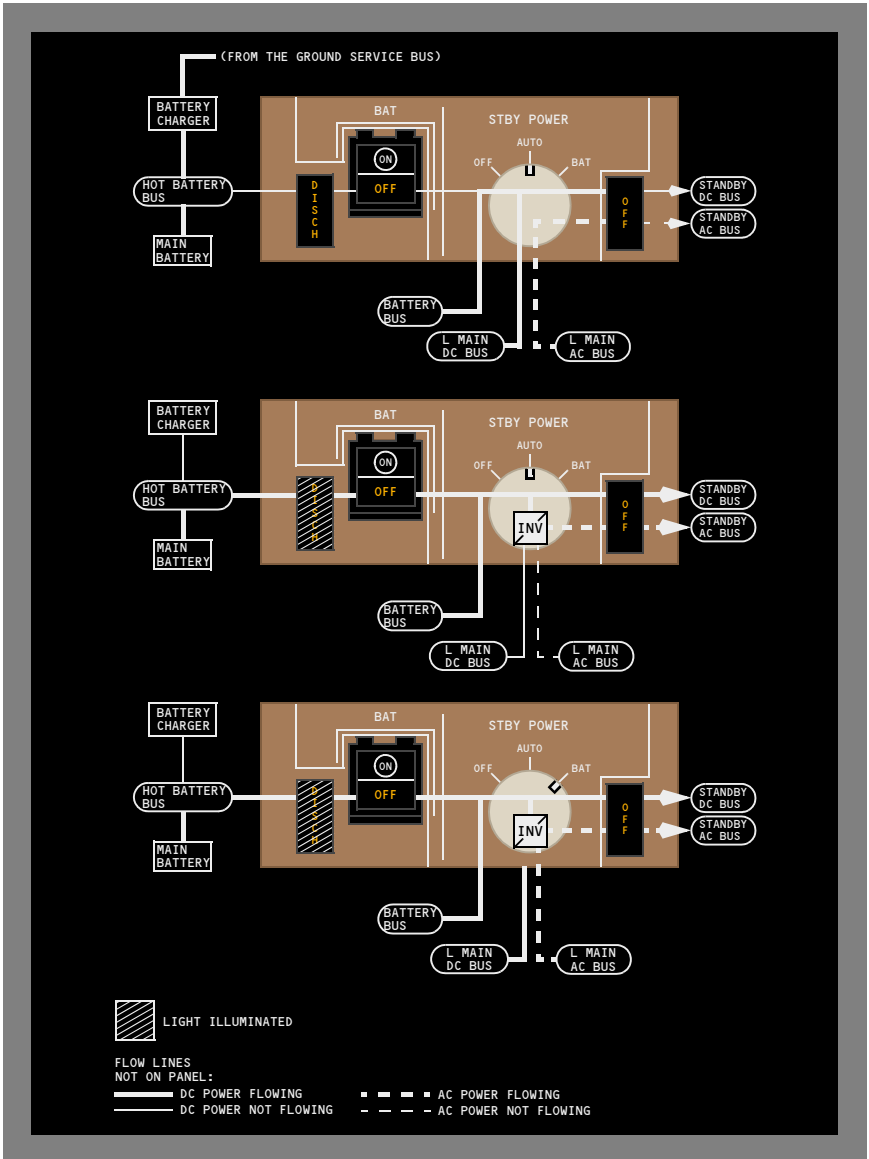

Hydraulic Driven Generator

The hydraulic driven generator (HDG) activates automatically when both the left and right main AC busses are unpowered. The Hydraulic Driven Generator (HDG) is powered by the Center Hydraulic System.

The HDG provides AC power to:

- the left AC transfer bus
- the right AC transfer bus
- the standby AC bus (through the left AC transfer bus)
- the captain's flight instrument transfer bus

The HDG provides DC power to:

- the hot battery bus
- the battery bus
- the standby DC bus.

The amount of DC power produced by the HDG is less than the DC power produced by a fully charged battery. When the HDG first begins to operate, the battery DISCH light may illuminate, until the battery power decreases to the power level produced by the HDG.

Battery/Standby System Schematic (Hydraulic Driven Generator Operating)

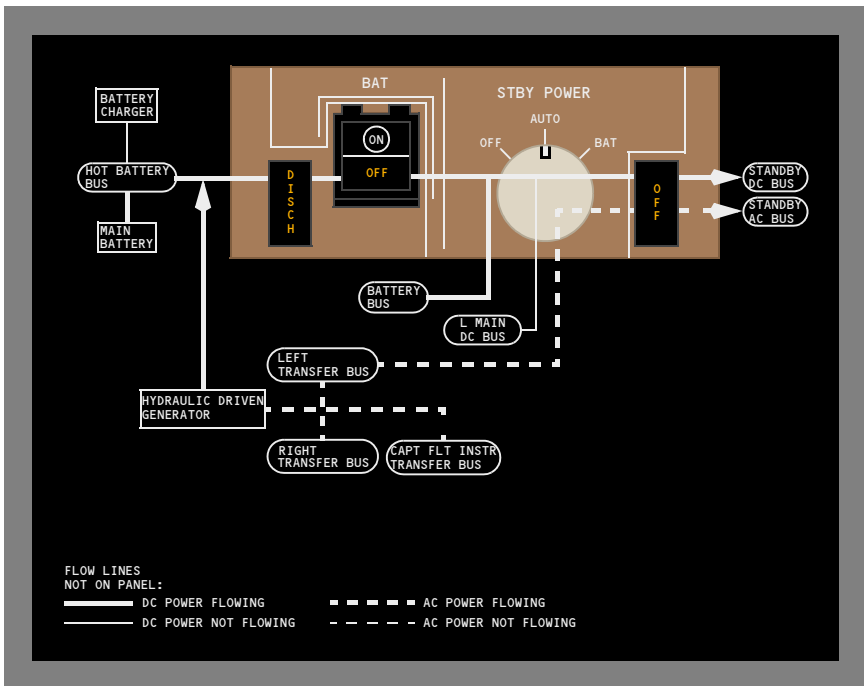

Electrical EICAS Messages

The following EICAS messages can be displayed.

| Message | Level | Light | Aural | Condition |
|----------------------------------|----------|------------|--------|---|
| L AC BUS OFF R AC BUS OFF | Caution | BUS OFF | Beeper | AC Bus is unpowered. |
| APU GEN OFF | Advisory | OFF | | APU generator control breaker is open due to a fault with the APU running. |
| BATTERY OFF | Advisory | OFF | | Battery switch is OFF. |
| L BUS ISOLATED R BUS ISOLATED | Advisory | ISLN | | Bus tie breaker is open due to an AC electrical system fault. |
| L GEN DRIVE R GEN DRIVE | Advisory | DRIVE | | Generator drive oil pressure is low or generator drive oil temperature is high. |
| L GEN OFF R GEN OFF | Advisory | OFF | | Generator control breaker is open. |
| MAIN BAT DISCH | Advisory | DISCH | | Main battery is discharging. |
| STANDBY BUS OFF | Advisory | OFF | | Standby AC or DC bus is unpowered. |
| L UTIL BUS OFF R UTIL BUS OFF | Advisory | OFF | | Galley and utility busses are unpowered. |

Intentionally
Blank

| | |
|---|-------------|
| Controls and Indicators (PW) | 7.11 |
| EICAS Displays | 7.11.1 |
| Primary Engine Indications | 7.11.1 |
| Secondary Engine Indications | 7.11.8 |
| Compact Engine Indications | 7.11.15 |
| Engine Controls | 7.11.16 |
| Thrust Levers | 7.11.16 |
| Fuel Control Switches | 7.11.17 |
| Engine Control Panel | 7.11.18 |
| Electronic Engine Control (EEC) | 7.11.19 |
| Thrust Mode Select Panel (TMSP) | 7.11.20 |
| EICAS Control Panel | 7.11.21 |
| Controls and Indicators (GE) | 7.12 |
| EICAS Displays | 7.12.1 |
| Primary Engine Indications | 7.12.1 |
| Secondary Engine Indications | 7.12.7 |
| Compact Engine Indications | 7.12.14 |
| Engine Controls | 7.12.15 |
| Thrust Levers | 7.12.15 |
| Fuel Control Switches | 7.12.16 |
| Engine Control Panel | 7.12.17 |
| Electronic Engine Control (EEC) | 7.12.18 |
| Thrust Mode Select Panel (TMSP) | 7.12.19 |
| EICAS Control Panel | 7.12.20 |
| Controls and Indicators | 7.15 |
| Auxiliary Power Unit (APU) | 7.15.1 |
| APU Controls | 7.15.1 |
| APU Indications | 7.15.2 |
| Engine System Description (PW) | 7.21 |
| Introduction | 7.21.1 |

| | |
|--|---------|
| Engine Indications | 7.21.1 |
| Primary Engine Indications | 7.21.1 |
| Secondary Engine Indications | 7.21.1 |
| Normal Display Format | 7.21.2 |
| Compact Display Format | 7.21.2 |
| Engine Secondary Data Cue | 7.21.3 |
| Engine Pressure Ratio (EPR) | 7.21.3 |
| Thrust Management Computer (TMC) | 7.21.4 |
| Assumed Temperature Takeoff | 7.21.5 |
| Reduced Climb Thrust | 7.21.6 |
| Electronic Engine Control (EEC) – PW4000 Series Engine | 7.21.6 |
| Primary (EPR) Control Mode | 7.21.6 |
| Alternate (N1) Control Mode | 7.21.7 |
| Overspeed Protection | 7.21.7 |
| Idle Selection | 7.21.7 |
| Engine Start and Ignition System | 7.21.8 |
| Engine Start | 7.21.8 |
| Starter Operation | 7.21.9 |
| In-Flight Start | 7.21.9 |
| Engine Ignition | 7.21.9 |
| Engine Start and Ignition System Schematic | 7.21.10 |
| Engine Fuel System | 7.21.11 |
| Fuel control Unit | 7.21.11 |
| Engine and Spar Valves | 7.21.11 |
| Fuel Filter | 7.21.11 |
| Fuel Flow Measurement | 7.21.12 |
| Engine Fuel System Schematic | 7.21.12 |
| Engine Oil System – PW4000 Series Engine | 7.21.13 |
| Engine Oil System Schematic – PW4000 Series Engine | 7.21.14 |
| Thrust Reverser System | 7.21.15 |
| Thrust Reverser Schematic | 7.21.16 |
| Airborne Vibration Monitoring System | 7.21.17 |

| | |
|--|-------------|
| Engine System Description (GE) | 7.22 |
| Introduction | 7.22.1 |
| Engine Indications | 7.22.1 |
| Primary Engine Indications | 7.22.1 |
| Secondary Engine Indications | 7.22.1 |
| Normal Display Format | 7.22.2 |
| Compact Display Format | 7.22.2 |
| Engine Secondary Data Cue | 7.22.3 |
| N1 RPM | 7.22.3 |
| Thrust Management Computer (TMC) | 7.22.4 |
| Assumed Temperature Takeoff | 7.22.5 |
| Reduced Climb Thrust | 7.22.6 |
| Electronic Engine Control (EEC) | 7.22.6 |
| EEC Normal Control Mode | 7.22.6 |
| EEC Alternate Mode | 7.22.7 |
| Overspeed Protection | 7.22.7 |
| Idle Selection | 7.22.8 |
| Engine Start and Ignition System | 7.22.8 |
| Engine Start | 7.22.9 |
| Starter Operation | 7.22.9 |
| In-Flight Start | 7.22.10 |
| Auto Relight | 7.22.10 |
| Engine Ignition | 7.22.10 |
| Engine Start and Ignition System Schematic | 7.22.11 |
| Engine Fuel System | 7.22.12 |
| Fuel Metering Unit | 7.22.12 |
| Engine and Spar Valves | 7.22.12 |
| Fuel Filter | 7.22.12 |
| Fuel Flow Measurement | 7.22.12 |
| Engine Fuel System Schematic | 7.22.13 |
| Engine Oil System | 7.22.13 |
| Engine Oil System Schematic | 7.22.15 |

| | |
|--|-------------|
| Thrust Reverser System | 7.22.15 |
| Thrust Reverser Schematic | 7.22.17 |
| Airborne Vibration Monitoring System | 7.22.18 |
| APU System Description | 7.30 |
| Introduction | 7.30.1 |
| APU Operation | 7.30.1 |
| APU Start | 7.30.1 |
| APU Run | 7.30.2 |
| APU Shutdown | 7.30.2 |
| Protection System | 7.30.2 |
| EICAS Messages (PW) | 7.41 |
| Engines, APU EICAS Messages | 7.41.1 |
| EICAS Messages (GE) | 7.42 |
| Engines, APU EICAS Messages | 7.42.1 |

EICAS Displays

Primary Engine Indications



1 Primary Engine Indications

Displayed full time on the EICAS display:

- EPR
- N1
- EGT

Mode Indications

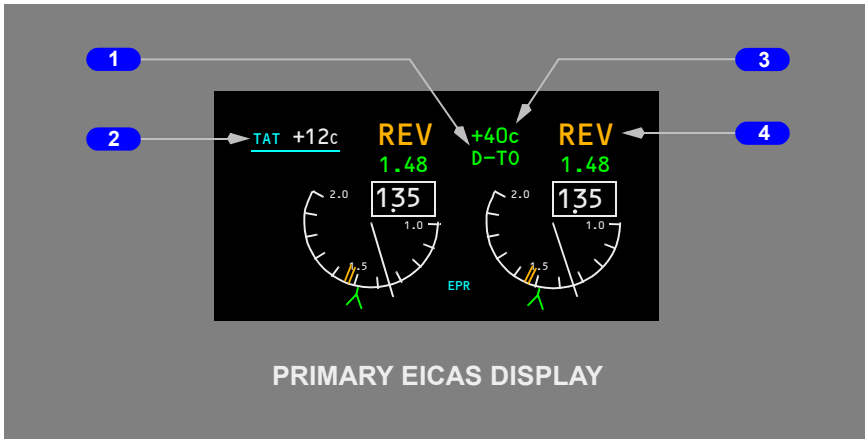

1 Thrust Reference Mode

Displayed (green) – selected FMS thrust reference mode:

Takeoff:

- TO – maximum rated takeoff thrust
- TO 1 * – maximum rated takeoff thrust, climb one preselected
- TO 2 * – maximum rated takeoff thrust, climb two preselected

Assumed Temperature Takeoff:

- D-TO – assumed temperature derated takeoff thrust
- D-TO 1 * – assumed temperature derated takeoff thrust, climb one preselected
- D-TO 2 * – assumed temperature derated takeoff thrust, climb two preselected

Climb:

- CLB – maximum rated climb thrust
- CLB 1 – derate one climb thrust
- CLB 2 – derate two climb thrust

Cruise:

- CRZ – maximum rated cruise thrust
- CRZ 1 * – maximum rated cruise thrust, climb one preselected
- CRZ 2 * – maximum rated cruise thrust, climb two preselected

Continuous:

- CON – maximum rated continuous thrust
- CON 1 * – maximum rated continuous thrust, climb one preselected
- CON 2 * – maximum rated continuous thrust, climb two preselected

Go-around and Manual:

- G/A – maximum go-around thrust
- MAN – reference EPR manually selected

Note: * WHITE NUMBER – indicates reduced climb thrust is preselected

2 Total Air Temperature (TAT)

Displayed (cyan) – "TAT" and underline

Displayed (white) - temperature (degrees C)

3 Assumed Temperature

Displayed (green) – selected assumed temperature (degrees C) for reduced thrust takeoff

4 Thrust Reverser Indication

Displayed REV (amber) – reverser in transit

Displayed REV (green) – reverser fully deployed

EPR Indications

Note: When reverse thrust is activated, the following indications are not displayed:

- reference/target EPR indication
- thrust reference mode
- reference EPR

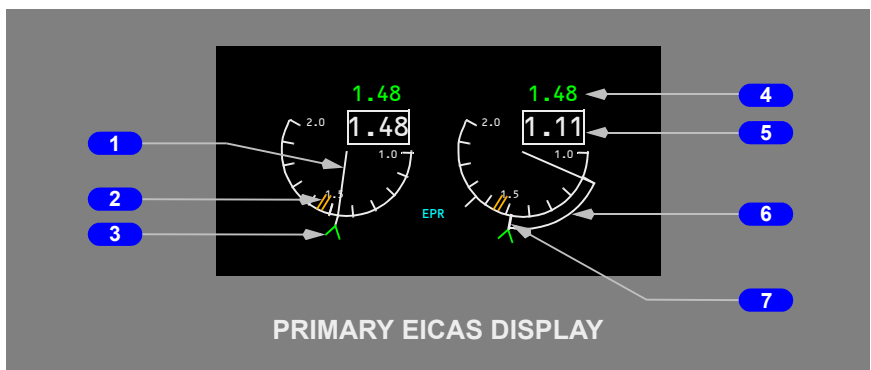

1 EPR Pointer

Displayed (white)

2 Maximum EPR Line

Displayed (amber)

3 EPR bug

Displayed (green) – reference EPR limit

Displayed magenta – target FMC commanded EPR when VNAV is engaged

4 Reference EPR

Displayed (green)

5 Actual EPR

Displayed (white)

6 Commanded EPR Sector

Displays momentary difference between engine EPR and EPR commanded by thrust lever position

7 Command Thrust Level

Displayed (white):

- end of command sector
- appears as extension of EPR pointer when engine stabilized
- EPR commanded by thrust lever position

N1 Indications

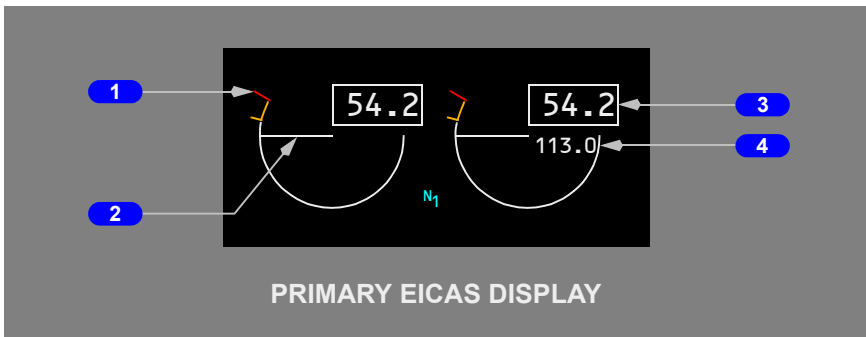

1 N1 Red Line Limit

Displayed (red) – N1 RPM operating limit

2 N1 Pointer

- (white) – points at value equal to that shown in the N1 counter
- (red) – operating limit reached or exceeded

3 N1

N1 RPM (%), displayed:

- (white) – normal operating range
- (red) – operating limit reached or exceeded

4 Maximum Exceedance

Displayed (white):

- red line limit or transient limit is exceeded
- highest value attained

EGT Indications

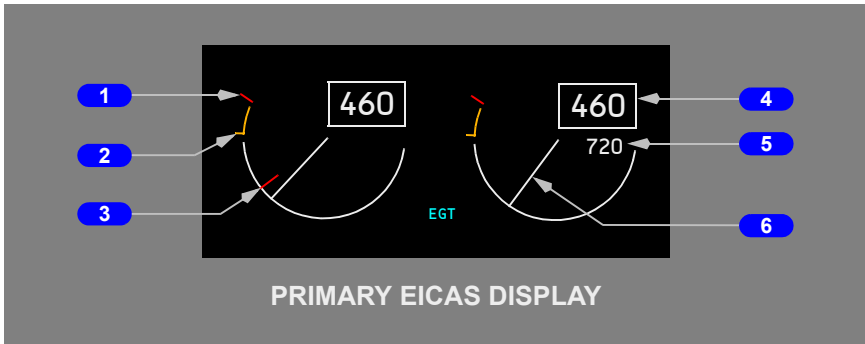

1 EGT Red Line

Displayed (red) – maximum takeoff EGT limit

2 EGT Amber Band

Displayed (amber) – maximum continuous EGT limit

3 EGT Start Limit Line

Displayed (red) – during start until engine is stabilized at minimum idle RPM

4 EGT

EGT (degrees C), displayed:

- (white) – normal operating range
- (amber) – maximum continuous limit reached*
- (red) – maximum start or takeoff limit reached

Note: * Pointer and counter remain white during TO or GA for 5 minutes after amber band is entered.

5 EGT Maximum Exceedance

Displayed (white):

- red line limit, transient limit or start EGT is exceeded
- displays the highest value attained

6 EGT Pointer

Displayed:

- (white) – normal operating range
- (amber) – maximum continuous limit reached
- (red) – maximum start or takeoff limit reached

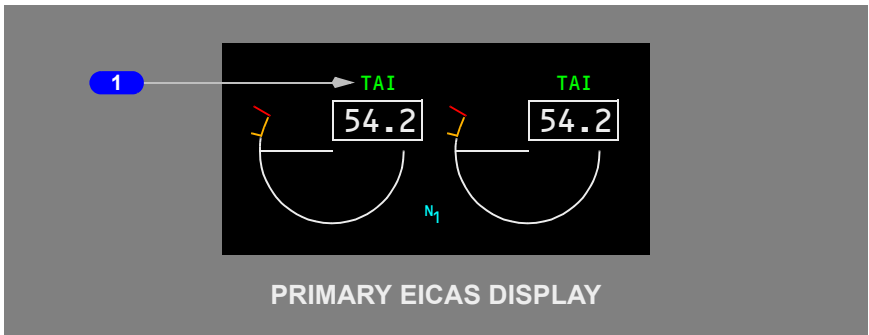
Anti-Ice Indications**1 Thermal Anti-Ice (TAI) Indication**

Displayed (green) –

- engine anti-ice is on

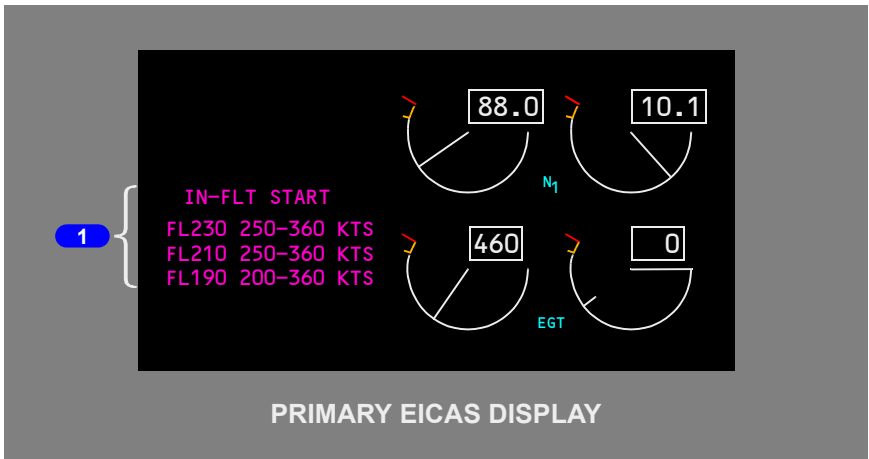
In-Flight Start Envelope**1 In-Flight Start Envelope**

Displayed (magenta) – airspeed range for an inflight start for the closest starting flight level and two descending flight levels at two thousand foot intervals when the respective engine fire switch is in and:

- a FUEL CONTROL switch is in CUT OFF, and
- engine N₂ RPM is below idle, and
- primary and secondary EICAS displayed

Secondary Engine Indications

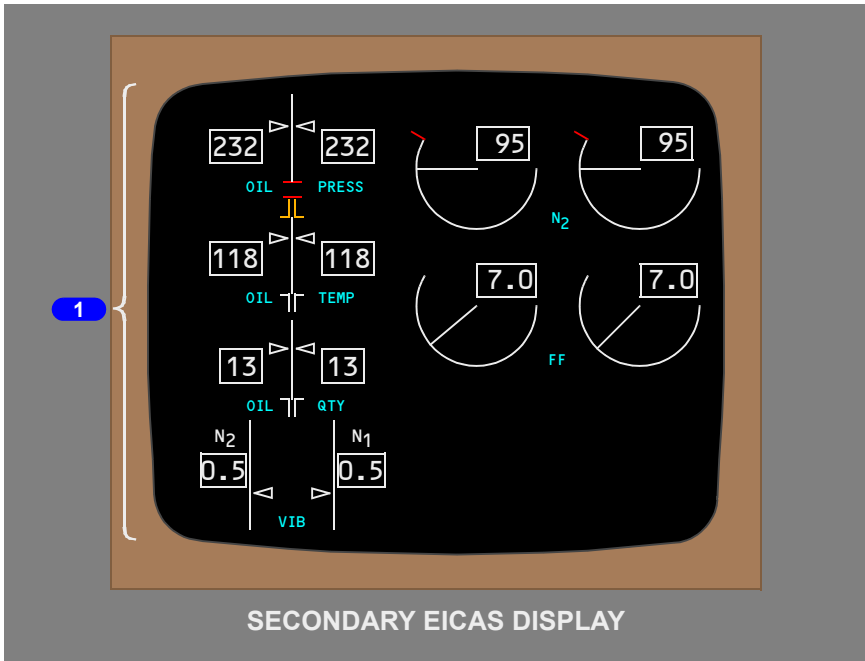

1 Secondary Engine Display

Displays:

- N2 RPM
- fuel flow (FF)
- oil pressure
- oil temperature
- oil quantity
- vibration

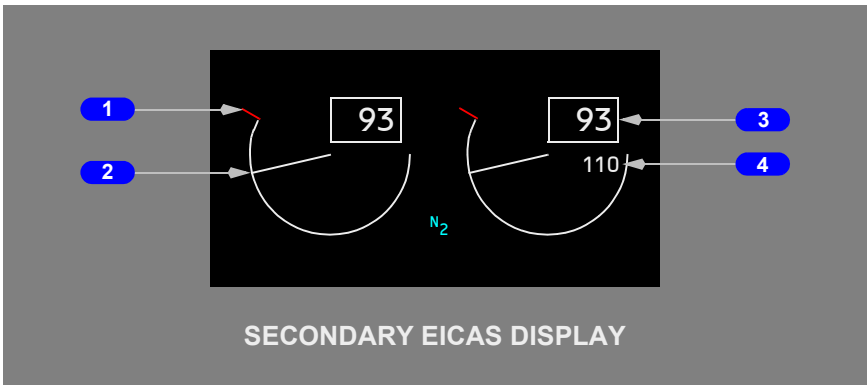
N2 Indications**1 N2 Red Line**

N2 RPM operating limit, displayed (red)

2 N2 Pointer

N2 RPM, displayed:

- (white) – normal operating range
- (red) – operating limit reached or exceeded

3 N2

N2 RPM (%), displayed:

- (white) – normal operating range
- (red) – operating limit reached

4 Maximum Exceedance

Displayed (white):

- red line limit is exceeded
- highest value attained

Crossbleed Start Indications

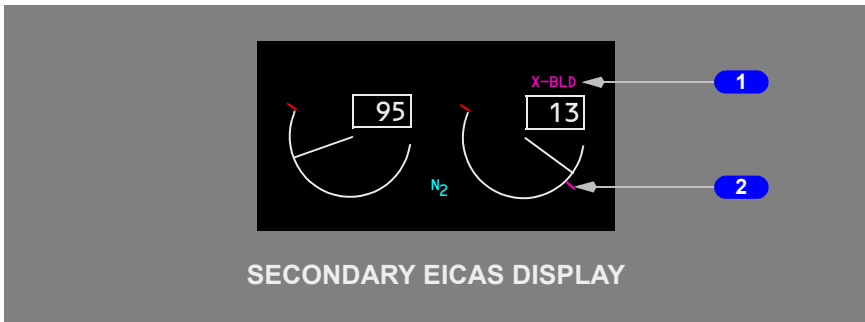

1 Crossbleed Start (X-BLD) Indication

Indicates crossbleed air is recommended for an inflight start.

Displayed (magenta):

- the inflight start envelope is displayed, and
- airspeed is lower than that for a windmilling start

2 Fuel On Command Bug

Displayed (magenta):

- engine is shutdown on the ground or inflight when X-BLD is displayed
- minimum fuel on selection point during starter cranking

Fuel Flow Indications

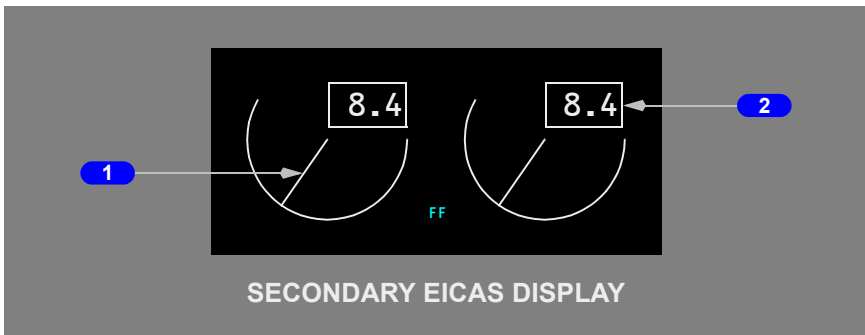

1 Fuel Flow Pointer

Displayed (white) – points at a value equal to that shown in the Fuel Flow

2 Fuel Flow (FF)

Displayed (white) – fuel flow to the engine (pounds per hour x 1000)

Oil Pressure Indications

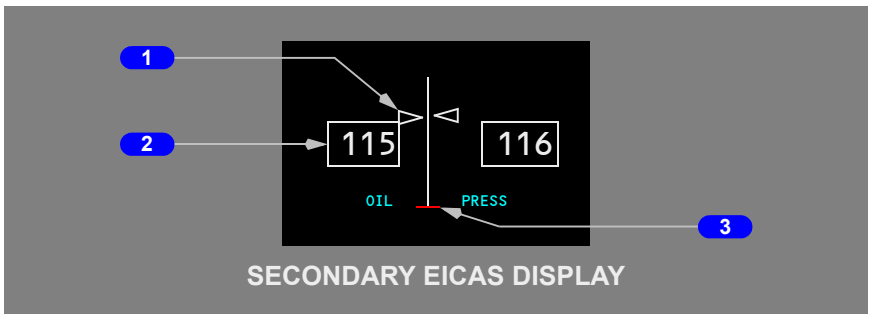

1 Oil Pressure Pointer

Engine oil pressure, displayed:

- (white) – normal operating range
- (red) – operating limit reached

2 Oil Pressure (OIL PRESS)

Engine oil pressure (psi), displayed:

- (white) – normal operating range
- (red) – operating limit reached

3 Oil Pressure Red Line

Displayed (red) – low oil pressure operating limit

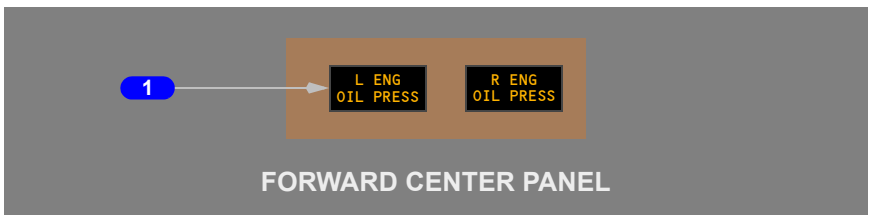

1 Engine Oil Pressure (L or R ENG OIL PRESS) Lights

Illuminated (amber):

- respective engine oil pressure is at or below minimum
- oil pressure switch malfunction

Oil Temperature Indications

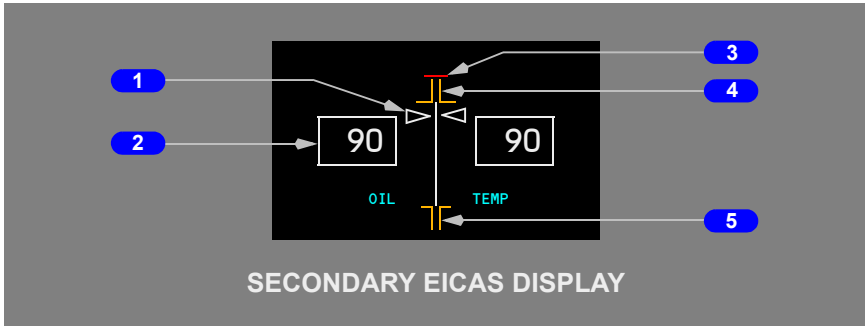

1 Oil Temperature Pointer

Engine oil temperature, displayed:

- (white) – normal operating range
- (amber) – caution range reached
- (red) – operating limit reached

2 Oil Temperature

Engine oil temperature (degrees C), displayed:

- (white) – normal operating range
- (amber) – caution range reached
- (red) – operating limit reached

3 Oil Temperature Red Line

Displayed (red) – oil temperature operating limit

4 Oil Temperature Amber Band

Displayed (amber) – upper oil temperature caution range

5 Oil Temperature Amber Band

Displayed (amber) – lower oil temperature caution range

Oil Quantity Indications

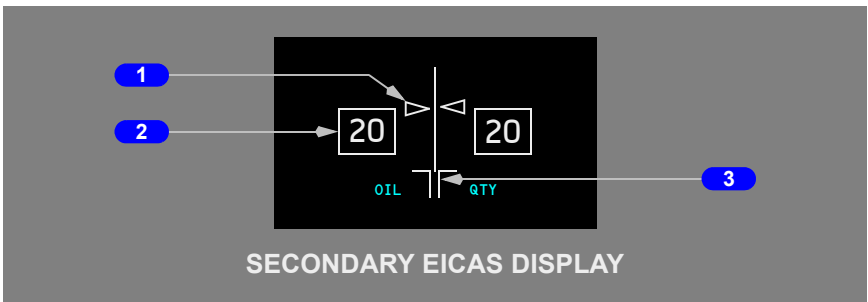

1 Oil Quantity Pointer

Displayed (white) – points at a value equal to that shown in the Oil Quantity

2 Oil Quantity

Usable oil quantity (quarts), displayed:

- (white) – normal quantity

3 Low Oil Quantity Band

Displayed (white) – awareness range for low oil quantity

Engine Vibration Indications

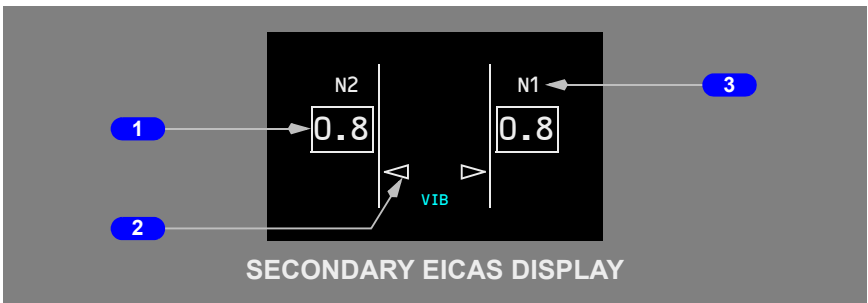

1 Engine Vibration

Displayed (white) – normal operating range

2 Engine Vibration Pointer

Displayed (white) – engine vibration

3 Vibration Source

Identifies the vibration source being displayed

Displayed (white) – vibration source with the highest vibration:

- N1 rotor vibration
- N2 rotor vibration

If the vibration source BB (broad band vibration) is displayed, the source is unknown and average vibration is displayed

Standby Engine Indicator (SEI)

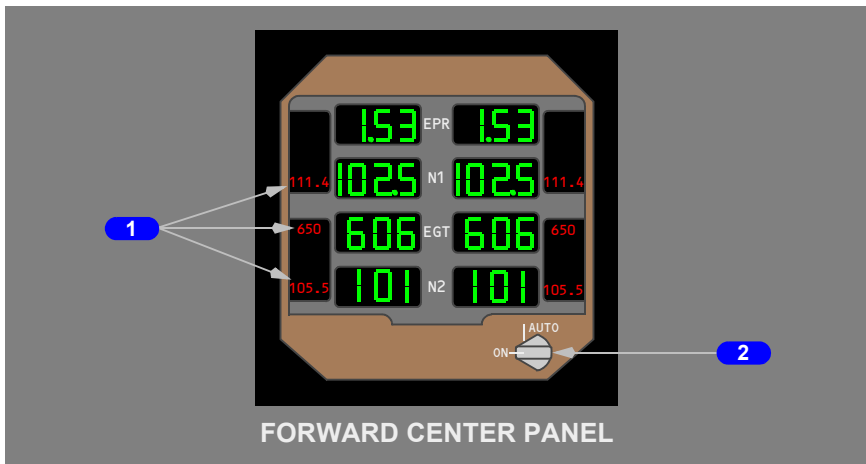

1 Maximum Engine Limits

2 Standby Engine Indicator Selector

AUTO –

- display is blank with AC power on the airplane and EICAS operative
- standby engine indications in view when:
 - AC power is lost
 - either CRT failed and STATUS selected on the ground
 - EICAS failed

ON – standby engine indications in view

Compact Engine Indications

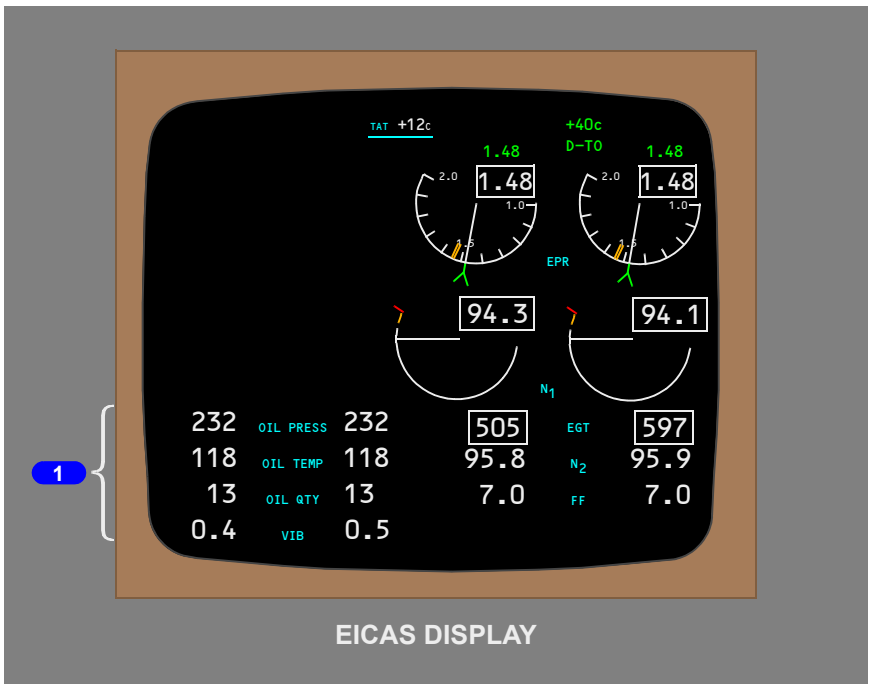

1 Compact Engine Indications

The following changes to EICAS and the normal secondary engine display occur:

- EGT and N₂ change from round dial displays to digital displays. The EGT digital display and box turn amber or red if the limit is exceeded. The N₂ digital display turns red if the limit is exceeded
- FF, OIL PRESS and OIL TEMP are displayed as digital readouts only. The OIL PRESS and OIL TEMP digital displays turn amber or red if limits are exceeded
- OIL QTY and VIB are displayed as digital readouts only. Low oil quantity and high vibrations are displayed the same as in the normal format.

Engine Controls

Thrust Levers

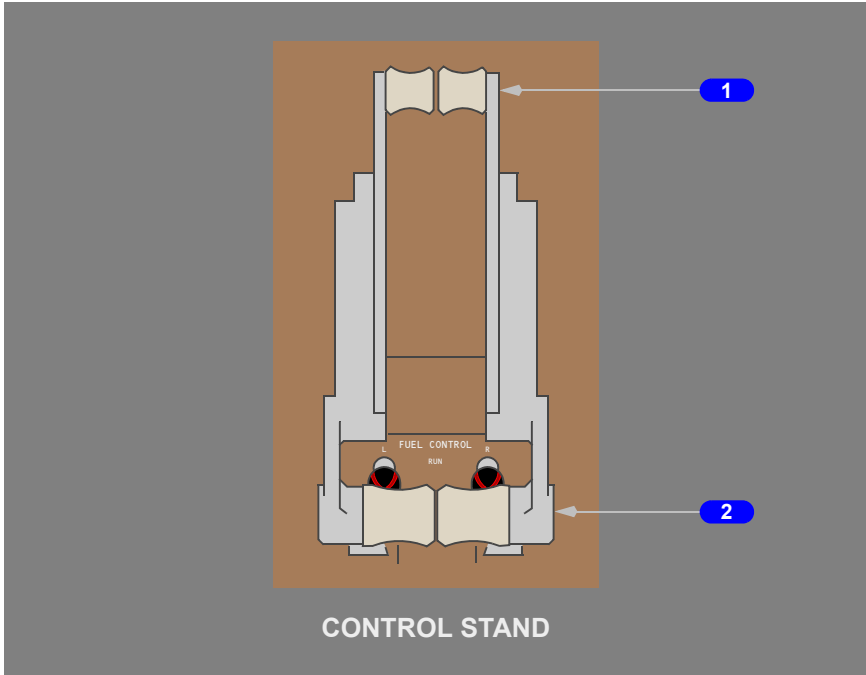

1 Reverse Thrust Levers

Controls engine reverse thrust

Reverse thrust can only be selected when the forward thrust levers are closed
Actuates automatic speedbrakes (refer to Chapter 9, Flight Controls)

2 Forward Thrust Levers

Controls engine forward thrust

The thrust levers can only be advanced if the reverse thrust levers are down

Fuel Control Switches

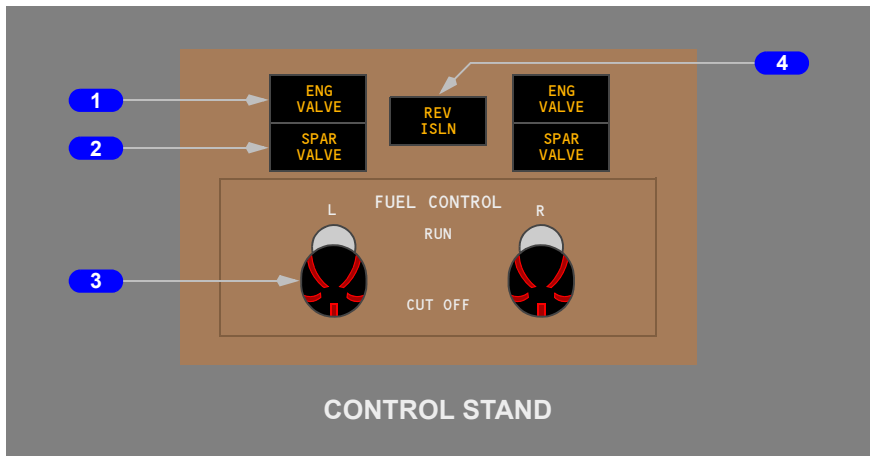

1 Engine Valve (ENG VALVE) Lights

Illuminated (amber) – engine fuel valve is not in commanded position

2 SPAR VALVE Lights

Illuminated (amber) – fuel spar valve is not in commanded position

3 FUEL CONTROL Switches

RUN –

- normal position for flight
- opens engine and spar fuel valves
- activates selected ignitor(s)

CUT OFF –

- closes engine and spar fuel valves
- terminates ignition

4 Reverser Isolation Valve (REV ISLN) Light

Illuminated (amber) – a fault has been detected in the thrust reverser system

Engine Control Panel

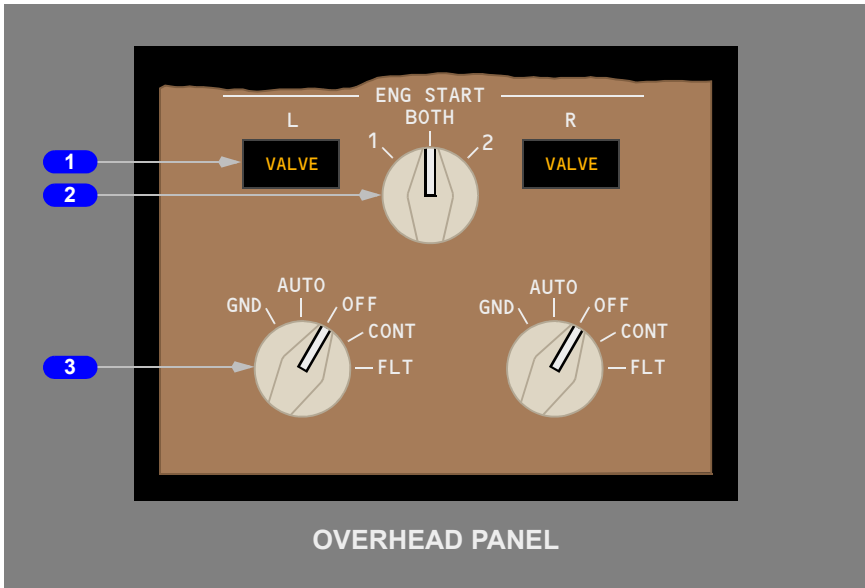

1 Engine Start Valve (VALVE) Lights

Illuminated (amber):

- valve is not in commanded position
- N2 RPM exceeds 50% and starter valve open

2 Ignition Selector

BOTH – both igniters in each engine operate when directed by Engine Start Selector

1 or 2 – selected igniter in each engine operate when directed by Engine Start Selector

3 Engine Start Selectors

GND (push-in and rotate) –

- opens start valve to supply starter air
- arms selected igniter(s)
- selector magnetically held in GND position until 50% N2 RPM

AUTO –

- selector releases to AUTO at 50% N2 RPM
- closes start valve and terminates ignition
- selected igniter(s) operate continuously with L.E. slats extended or engine anti-ice on

OFF – no ignition**CONT –**

- selected igniter(s) operate continuously
- no time limit
- engine operates at a minimum of approach idle

FLT –

- both igniters operate continuously regardless of ignition selector position
- no time limit

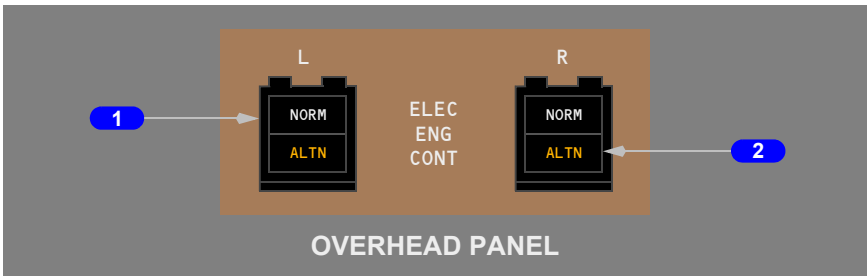
Electronic Engine Control (EEC)**1 EEC (ELEC ENG CONT) Switches**

NORM – EEC is operating in normal (EPR) mode

ALTN (NORM not visible) – EEC is operating in alternate (N1) mode

2 EEC Alternate Mode (ALTN) Lights

Illuminated (amber) – EEC is operating in alternate (N1) mode

Thrust Mode Select Panel (TMSP)

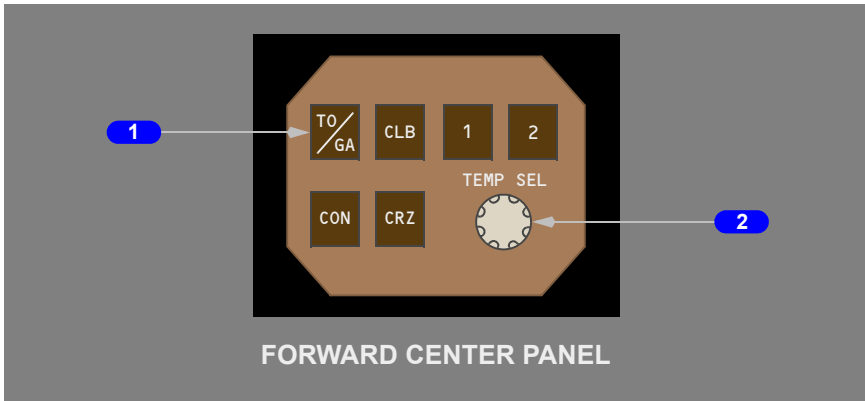

1 Thrust Reference Mode Select Switches

Push –

- manually selects desired thrust reference mode
- selected thrust reference mode and reference EPR are displayed

TO/GA –

- selects TO mode on the ground or GA mode inflight
- cancels preselected climb one or two
- cancels selected assumed temperature
- selecting 1 or 2 with TO or D-TO reference mode displayed:
 - preselects CLB 1 or CLB 2 on the ground if autothrottles not engaged
 - subsequent push cancels any preselected 1 or 2
 - cancels selected assumed temperature

CLB –

- selects CLB
- selects CLB 1 or CLB 2 if 1 or 2 is preselected
- selecting 1 or 2 with CLB Reference mode displayed:
 - selects CLB 1 or CLB 2
- with CLB 1 or CLB 2 reference mode displayed:
 - subsequent push of active mode switch cancels 1 or 2
- with CLB 2 reference mode displayed:
 - switch 1 selects CLB 1

CON –

- selects CON mode
- selecting 1 or 2 with CON reference mode displayed:
 - preselects CLB 1 or CLB 2

CRZ –

- selects CRZ mode
- selecting 1 or 2 with CRZ reference mode displayed:
 - preselects CLB 1 or CLB 2

2 Assumed Temperature Selector (TEMP SEL)

Functions only with TO, TO 1* or TO 2* mode displayed

Sets assumed temperature

Rotate clockwise –

- assumed temperature appears on EICAS
- one click equals 1 degree centigrade

Note: * WHITE NUMBER - indicates reduced climb thrust is preselected

EICAS Control Panel

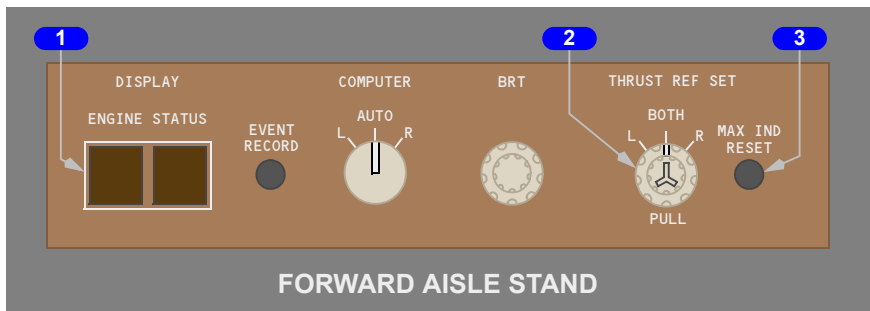

1 ENGINE Display Switch

Push – displays the secondary engine parameters on the lower EICAS CRT

If secondary engine parameters are already displayed and no limits have been exceeded, the display blanks

2 Manual Thrust Reference Set (THRUST REF SET) Controls

Outer Knob:

- BOTH – both EPR bugs may be set to the same value
- L or R – only the selected EPR bug may be set to the desired value. Bugs may be set at different values.

Inner Knob:

- Push – reference EPR is set automatically
- Pull – reference EPR is set manually. MAN appears in EPR thrust reference mode display and EPR bug moves to 1.55.
- Rotate – in manual mode, sets EPR bug and reference EPR to desired value

3 Maximum Indication Reset (MAX IND RESET) Switch

Push – resets and blanks all maximum exceedance values on EGT, N1 and N2

EICAS Displays

Primary Engine Indications

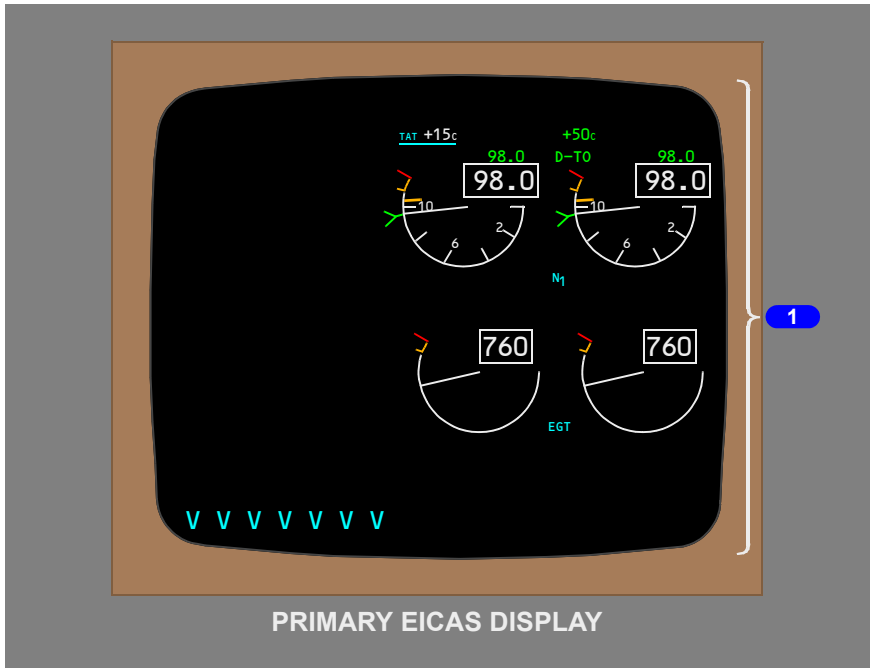

1 Primary Engine Indications

Displayed full time on the EICAS display:

- N1
- EGT

Mode Indications

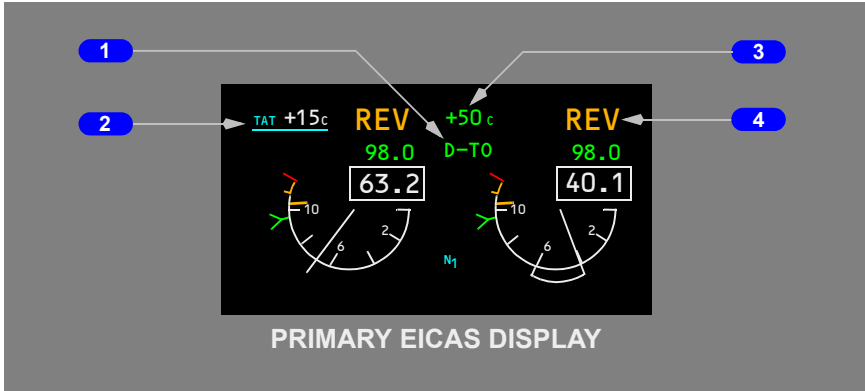

1 Thrust Reference Mode

Displayed (green) – selected FMS thrust reference mode:

Takeoff:

- TO – maximum rated takeoff thrust
- TO 1 * – maximum rated takeoff thrust, climb one preselected
- TO 2 * – maximum rated takeoff thrust, climb two preselected

Assumed Temperature Takeoff:

- D-TO – assumed temperature derated takeoff thrust
- D-TO 1 * – assumed temperature derated takeoff thrust, climb one preselected
- D-TO 2 * – assumed temperature derated takeoff thrust, climb two preselected

Climb:

- CLB – maximum rated climb thrust
- CLB 1 – derate one climb thrust
- CLB 2 – derate two climb thrust

Cruise:

- CRZ – maximum rated cruise thrust
- CRZ 1 * – maximum rated cruise thrust, climb one preselected
- CRZ 2 * – maximum rated cruise thrust, climb two preselected

Continuous:

- CON – maximum rated continuous thrust
- CON 1 * – maximum rated continuous thrust, climb one preselected
- CON 2 * – maximum rated continuous thrust, climb two preselected

Go-around and Manual:

- G/A – maximum go-around thrust
- MAN – reference N1 manually selected

Note: * WHITE NUMBER – indicates reduced climb thrust is preselected

2 Total Air Temperature (TAT)

Displayed (cyan) – "TAT" and underline

Displayed (white) - temperature (degrees C)

3 Assumed Temperature

Displayed (green) – selected assumed temperature (degrees C) for reduced thrust takeoff

4 Thrust Reverser Indication

Displayed:

- REV (amber) – reverser in transit
- REV (green) – reverser fully deployed

N1 Indications

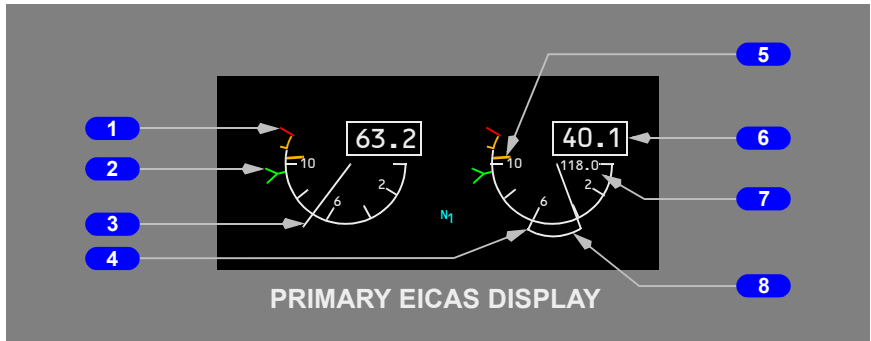

1 N1 Red Line Limit

Displayed (red) – N1 RPM operating limit

2 N1 Bug

Displayed (green) – reference N1 for:

- thrust reference mode selected by the FMC
- thrust reference mode selected by the thrust mode select panel
- manual mode selected with thrust reference control

Displayed (magenta) – target FMC commanded N1 when VNAV is engaged

3 N1 Pointer

Displayed:

- (white) – points at value equal to that shown in the N1 counter
- (red) – operating limit reached or exceeded

4 Command Thrust Level

Displayed (white):

- end of command sector
- appears as extension of N1 pointer when engine stabilized
- N1 commanded by thrust lever position

5 Limit N1

Displayed (amber) – maximum limit N1

6 N1

N1 RPM (%), displayed:

- (white) – normal operating range
- (red) – operating limit reached or exceeded

7 Maximum Exceedance

Displayed (white):

- red line limit or transient limit is exceeded
- highest value attained

8 Command N1 Sector

Displayed (white) – momentary difference between engine N1 and N1 commanded by thrust lever position

EGT Indications

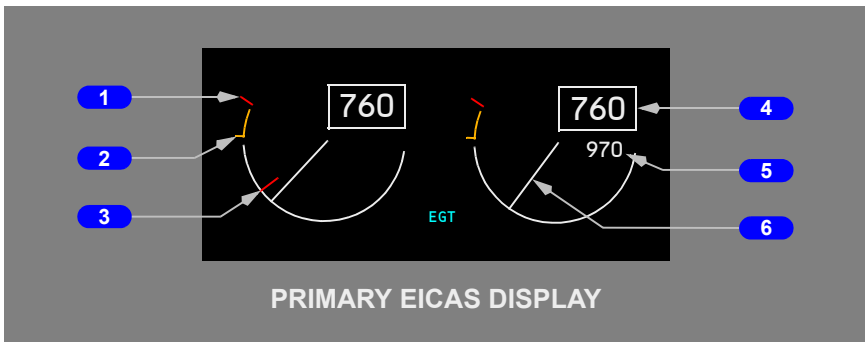

1 EGT Red Line

Displayed (red) – maximum takeoff EGT limit

2 EGT Amber Band

Displayed (amber) – maximum continuous EGT limit

3 EGT Start Limit Line

Displayed (red) – during start until engine is stabilized at minimum idle RPM

4 EGT

EGT (degrees C), displayed:

- (white) – normal operating range
- (amber) – maximum continuous limit reached*
- (red) – maximum start or takeoff limit reached

Note: * Pointer and counter remain white during TO or GA for 5 minutes after amber band is entered.

5 EGT Maximum Exceedance

Displayed (white):

- red line limit, transient limit or start EGT is exceeded
- displays the highest value attained

6 EGT Pointer

Displayed:

- (white) – normal operating range
- (amber) – maximum continuous limit reached
- (red) – maximum start or takeoff limit reached

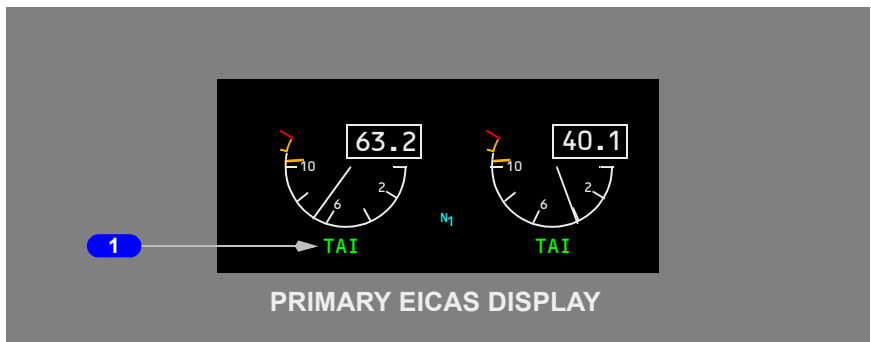
Anti-Ice Indications

1 Thermal Anti-Ice (TAI) Indication

Displayed (green) – engine anti-ice is on

In-Flight Start Envelope

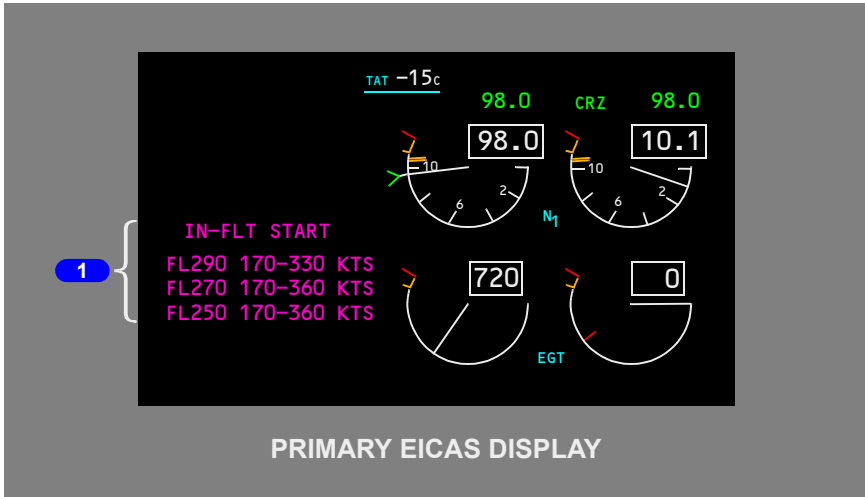

1 In-Flight Start Envelope

Displayed (magenta) – airspeed range for an inflight start for the closest starting flight level and two descending flight levels at two thousand foot intervals when the respective engine fire switch is in and:

- a FUEL CONTROL switch is in CUT OFF, and
- engine N2 RPM is below idle, and
- primary and secondary EICAS displayed

Secondary Engine Indications

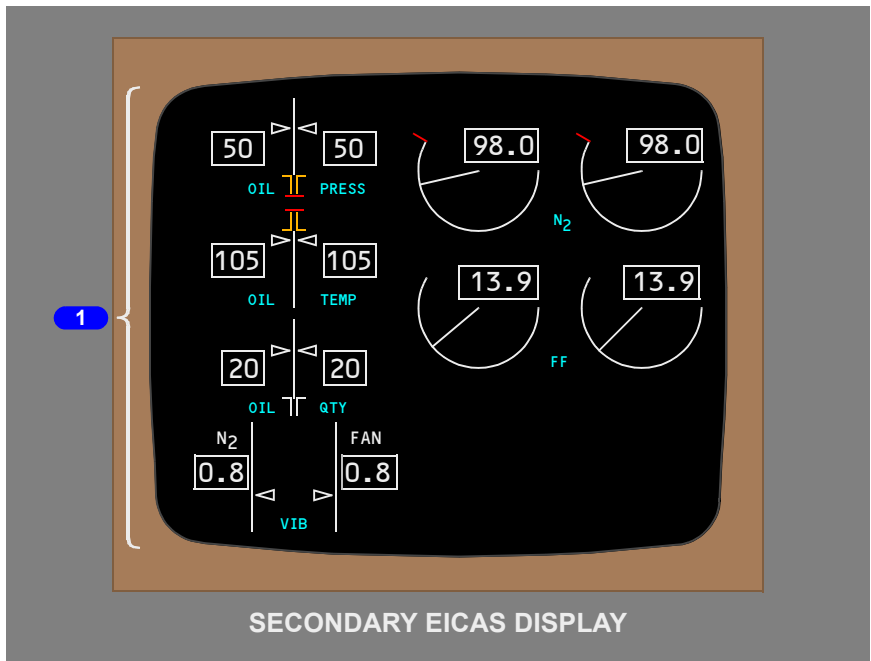

1 Secondary Engine Display

Displays:

- N2 RPM
- fuel flow (FF)
- oil pressure
- oil temperature
- oil quantity
- vibration

N2 Indications

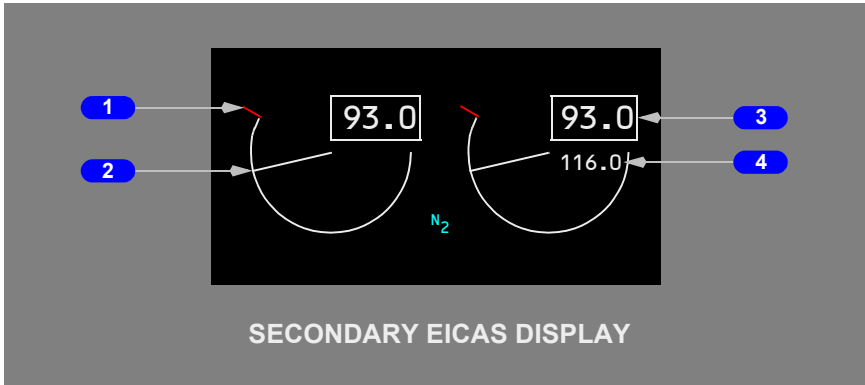

1 N2 Red Line

N2 RPM operating limit, displayed (red)

2 N2 Pointer

N2 RPM, displayed:

- (white) – normal operating range
- (red) – operating limit reached or exceeded

3 N2

N2 RPM (%), displayed:

- (white) – normal operating range
- (red) – operating limit reached

4 Maximum Exceedance

Displayed (white):

- red line limit is exceeded
- highest value attained

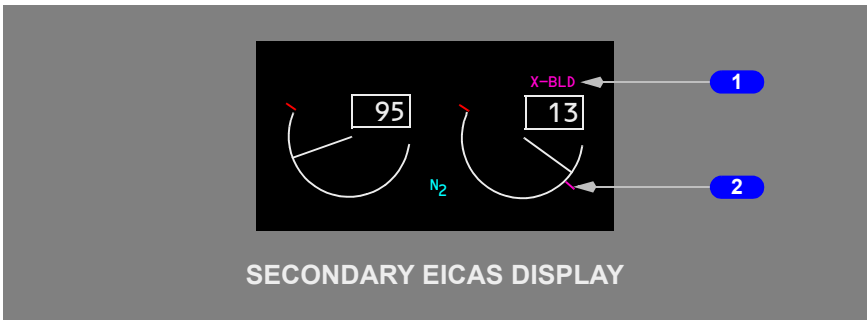
Crossbleed Start Indications**1 Crossbleed Start (X-BLD) Indication**

Indicates crossbleed air is recommended for an inflight start.

Displayed (magenta):

- the inflight start envelope is displayed, and
- airspeed is lower than that for a windmilling start

2 Fuel On Command Bug

Displayed (magenta):

- engine is shutdown on the ground or inflight when X-BLD is displayed
- minimum fuel on selection point during starter cranking

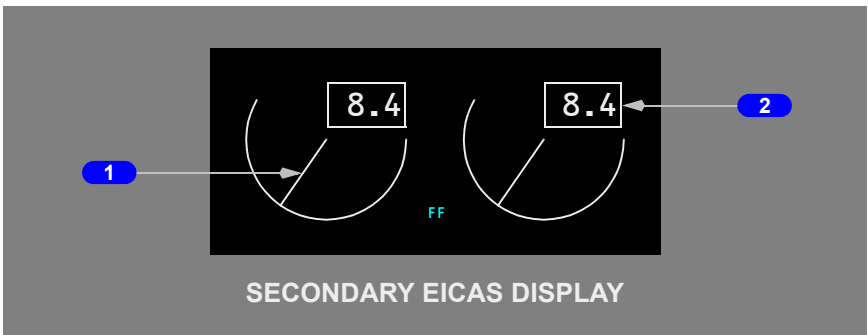
Fuel Flow Indications**1 Fuel Flow Pointer**

Displayed (white) – points at a value equal to that shown in the Fuel Flow

2 Fuel Flow (FF)

Displayed (white) – fuel flow to the engine (pounds per hour x 1000)

Oil Pressure Indications

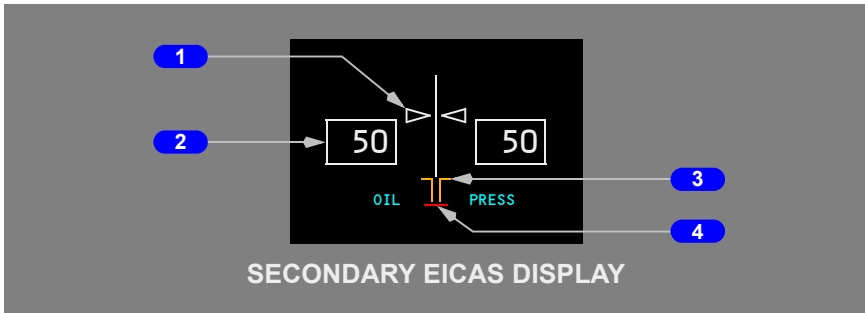

1 Oil Pressure Pointer

Engine oil pressure, displayed:

- (white) – normal operating range
- (amber) – caution range reached
- (red) – operating limit reached

2 Oil Pressure (OIL PRESS)

Engine oil pressure (psi), displayed:

- (white) – normal operating range
- (amber) – caution range reached
- (red) – operating limit reached

3 Oil Pressure Amber Band

Displayed (amber) – caution range for low oil pressure

4 Oil Pressure Red Line

Displayed (red) – low (minimum) oil pressure operating limit

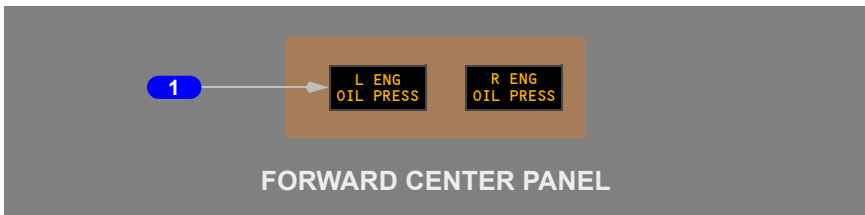

1 Engine Oil Pressure (L or R ENG OIL PRESS) Lights

Illuminated (amber):

- respective engine oil pressure is at or below minimum
- oil pressure switch malfunction

Oil Temperature Indications

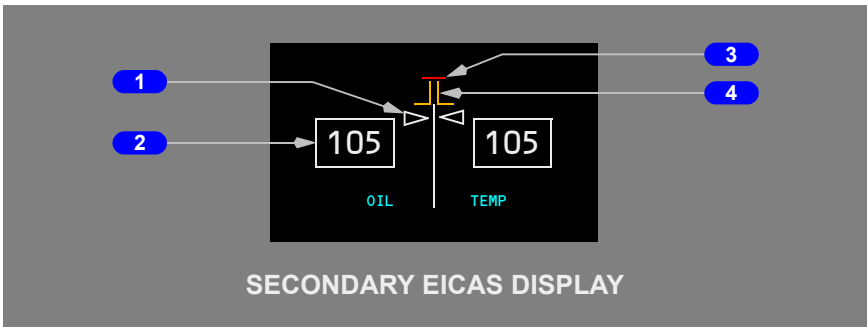

1 Oil Temperature Pointer

Engine oil temperature, displayed:

- (white) – normal operating range
- (amber) – caution range reached
- (red) – operating limit reached

2 Oil Temperature

Engine oil temperature (degrees C), displayed:

- (white) – normal operating range
- (amber) – caution range reached
- (red) – operating limit reached

3 Upper Oil Temperature Red Line

Displayed (red) – maximum oil temperature operating limit

4 Oil Temperature Amber Band

Displayed (amber) – oil temperature caution range

Oil Quantity Indications

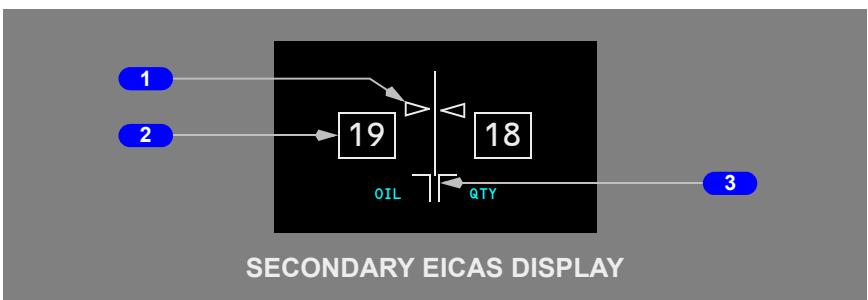

1 Oil Quantity Pointer

Displayed (white) – points at a value equal to that shown in the Oil Quantity

2 Oil Quantity

Usable oil quantity (quarts), displayed:

- (white) – normal quantity

3 Low Oil Quantity Band

Displayed (white) – awareness range for low oil quantity

Engine Vibration Indications

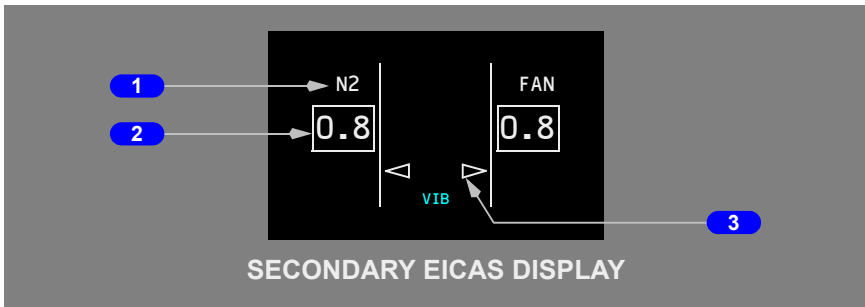

1 Vibration Source

Identifies the vibration source being displayed.

Displayed (white) – vibration source with the highest vibration:

- FAN – low pressure compressor
- LPT – low pressure turbine
- N2 – high pressure compressor
- BB – broad band engine vibration

2 Engine Vibration

Displayed (white) – display of engine vibration in units

3 Engine Vibration Pointer

Displayed (white) – engine vibration

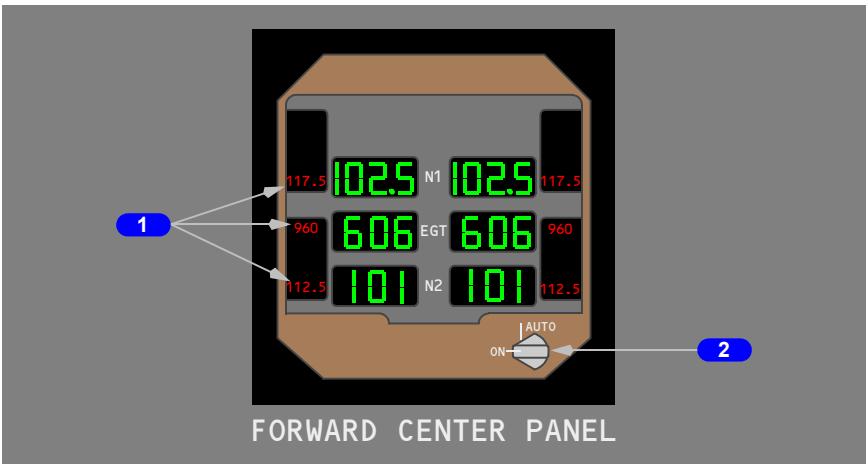
Standby Engine Indicator (SEI)**1 Maximum Engine Limits****2 Standby Engine Indicator Selector**

AUTO –

- display is blank with AC power on the airplane and EICAS operative
- standby engine indications in view when:
 - AC power is lost
 - either CRT failed and STATUS selected on the ground
 - EICAS failed

ON – standby engine indications in view

Compact Engine Indications

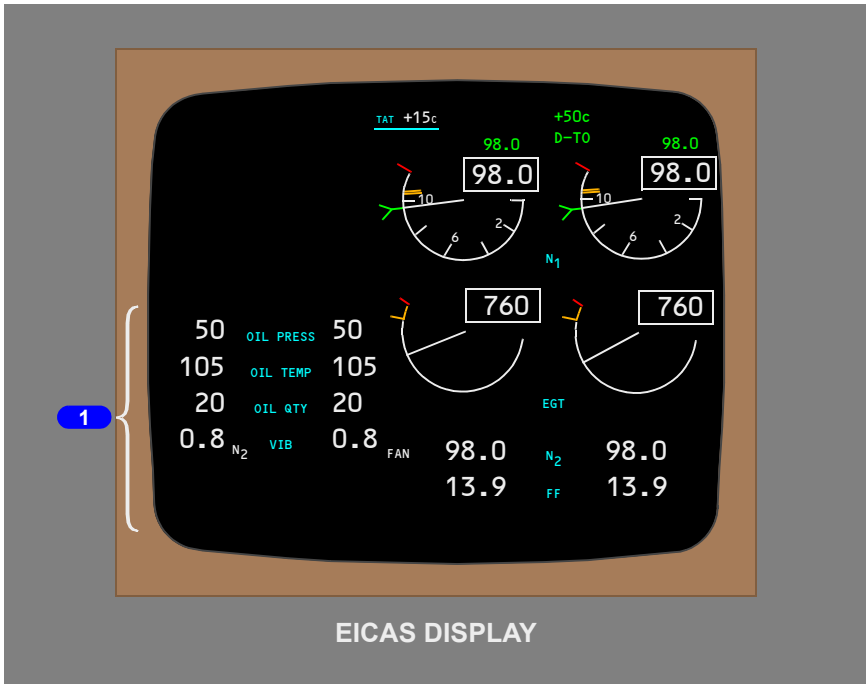

1 Compact Engine Indications

The following changes to EICAS and the normal secondary engine display occur:

- N2 changes from round dial display to digital display. The N2 digital display turns red if the limit is exceeded.
- FF, OIL PRESS and OIL TEMP are displayed as digital readouts only. The OIL PRESS and OIL TEMP digital displays turn amber or red if limits are exceeded.
- OIL QTY and VIB are displayed as digital readouts only. Low oil quantity and high vibrations are displayed the same as in the normal format.

Engine Controls

Thrust Levers

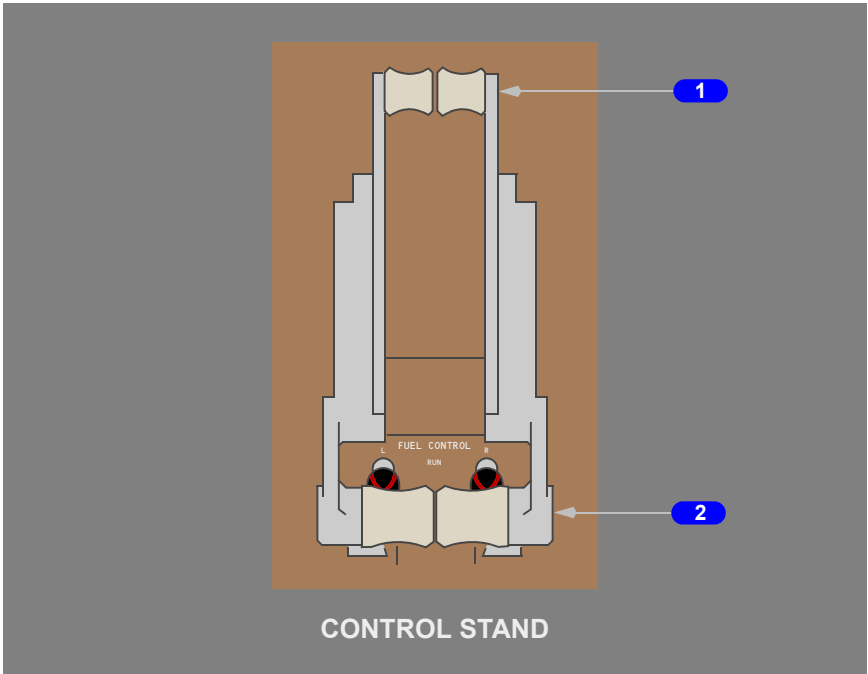

1 Reverse Thrust Levers

Controls engine reverse thrust

Reverse thrust can only be selected when the forward thrust levers are closed
Actuates automatic speedbrakes (refer to Chapter 9, Flight Controls)

2 Forward Thrust Levers

Controls engine forward thrust

The thrust levers can only be advanced if the reverse thrust levers are down

Fuel Control Switches

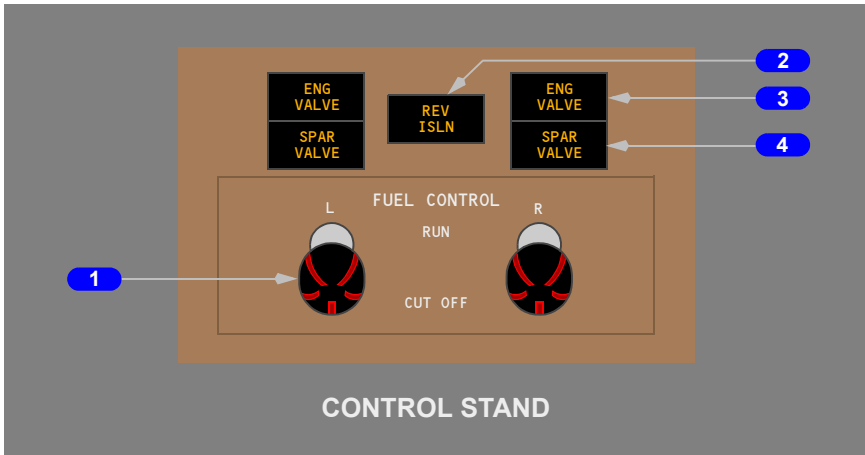

1 FUEL CONTROL Switches

RUN –

- normal position for flight
- opens engine and spar fuel valves
- activates selected ignitor(s)

CUT OFF –

- closes engine and spar fuel valves
- terminates ignition

2 Reverser Isolation Valve (REV ISLN) Light

Illuminated (amber) – a fault has been detected in the thrust reverser system

3 Engine Valve (ENG VALVE) Lights

Illuminated (amber) – engine fuel valve is not in commanded position

4 SPAR VALVE Lights

Illuminated (amber) – fuel spar valve is not in commanded position

Engine Control Panel

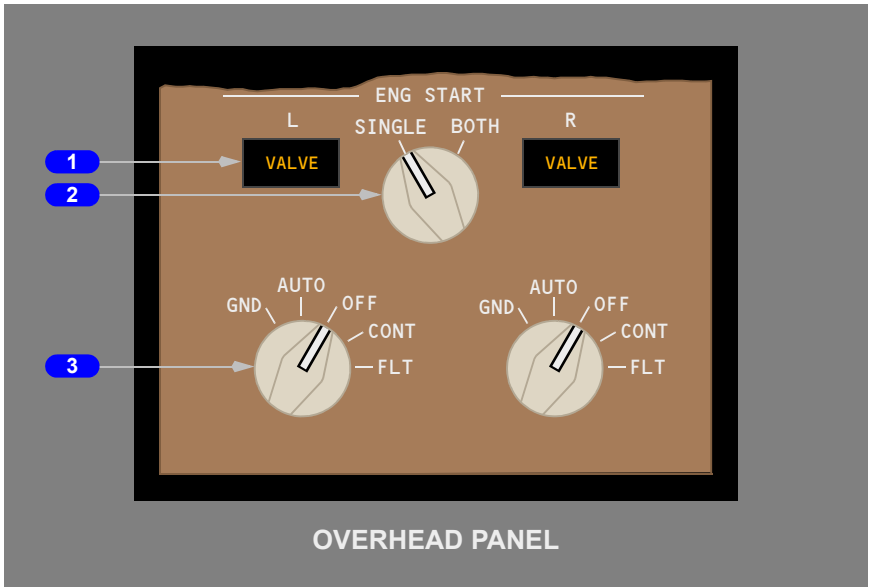

1 Engine Start Valve (VALVE) Lights

Illuminated (amber):

- valve is not in commanded position
- N2 RPM exceeds 50% and starter valve open

2 Ignition Selector

BOTH – both igniters in each engine operate when directed by Engine Start Selector

SINGLE – one igniter in each engine operates when directed by Engine Start Selector. The igniter automatically alternates with each engine start.

Note: Auto relight is enabled regardless of engine start and ignition selector positions. Both igniters operate when N2 drops below idle speed.

3 Engine Start Selectors

GND (push-in and rotate) –

- opens start valve to supply starter air
- arms selected igniter(s)
- selector magnetically held in GND position until 50% N2 RPM

AUTO –

- selector releases to AUTO at 50% N2 RPM
- closes start valve and terminates ignition
- selected igniter(s) operate continuously with L.E. slats extended or engine anti-ice on

OFF – no ignition

CONT –

- selected igniter(s) operate continuously
- no time limit
- engine operates at a minimum of approach idle

FLT –

- both igniters operate continuously regardless of ignition selector position
- no time limit

Electronic Engine Control (EEC)

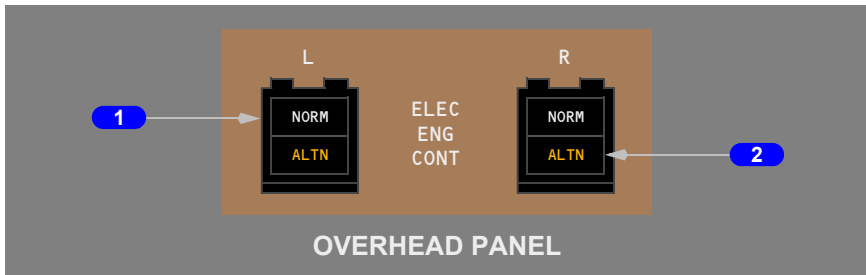

1 EEC (ELEC ENG CONT) Switches

NORM – normal EEC mode is selected

ALTN (NORM not visible) – alternate EEC mode is selected

2 EEC Alternate Mode (ALTN) Lights

Illuminated (amber) – EEC is operating in alternate mode

Thrust Mode Select Panel (TMSP)

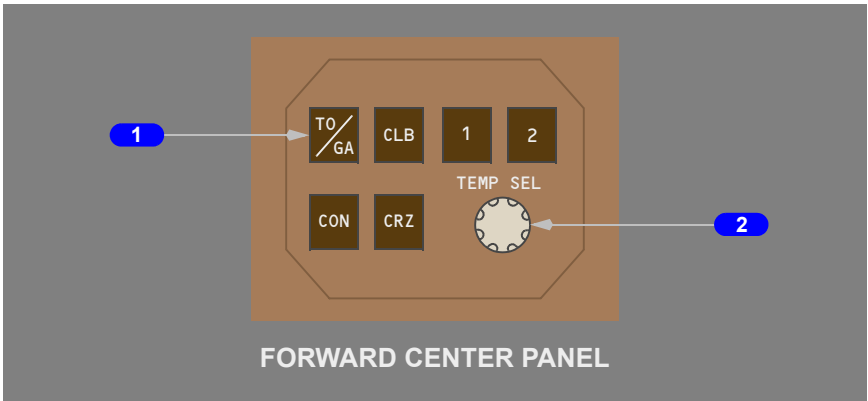

1 Thrust Reference Mode Select Switches

Push –

- manually selects desired thrust reference mode
- selected thrust reference mode and reference N1 are displayed

TO/GA –

- selects TO mode on the ground or GA mode inflight
- cancels preselected climb one or two
- cancels selected assumed temperature
- selecting 1 or 2 with TO or D-TO reference mode displayed:
 - preselects CLB 1 or CLB 2 on the ground if autothrottles not engaged
 - subsequent push cancels any preselected 1 or 2
 - cancels selected assumed temperature

CLB –

- selects CLB
- selects CLB 1 or CLB 2 if 1 or 2 is preselected
- selecting 1 or 2 with CLB Reference mode displayed:
 - selects CLB 1 or CLB 2
- with CLB 1 or CLB 2 reference mode displayed:
 - subsequent push of active mode switch cancels 1 or 2
- with CLB 2 reference mode displayed:
 - switch 1 selects CLB 1

CON –

- selects CON mode
- selecting 1 or 2 with CON reference mode displayed:
 - preselects CLB 1 or CLB 2

CRZ –

- selects CRZ mode
- selecting 1 or 2 with CRZ reference mode displayed:
 - preselects CLB 1 or CLB 2

2 Assumed Temperature Selector (TEMP SEL)

Functions only with TO, TO 1* or TO 2* mode displayed

Sets assumed temperature

Rotate clockwise –

- assumed temperature appears on EICAS
- one click equals 1 degree centigrade

Note: * WHITE NUMBER - indicates reduced climb thrust is preselected.

EICAS Control Panel

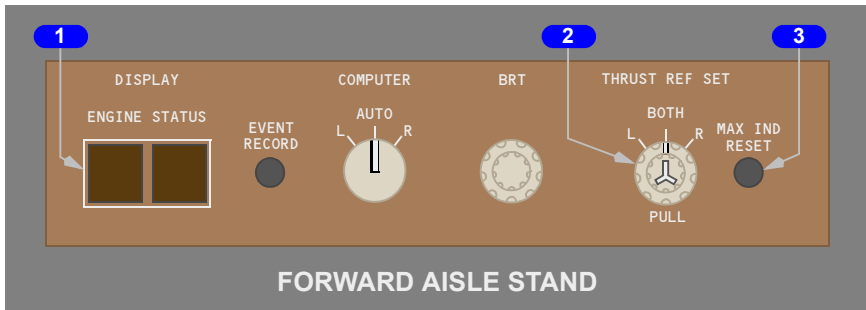

1 ENGINE Display Switch

Push – displays the secondary engine parameters on the lower EICAS CRT

If secondary engine parameters are already displayed and no limits have been exceeded, the display blanks

2 Manual Thrust Reference Set (THRUST REF SET) Controls

Outer Knob:

- BOTH – both N1 bugs may be set to the same value
- L or R – only the selected N1 bug may be set to the desired value. Bugs may be set at different values

Inner Knob:

- Push – reference N1 is set automatically
- Pull – reference N1 is set manually. MAN appears in N1 thrust reference mode display and N1 bug moves to 104%
- Rotate – in manual mode, sets N1 bug and reference N1 to desired value

3 Maximum Indication Reset (MAX IND RESET) Switch

Push – resets and blanks all maximum exceedance values N1, EGT and N2

Intentionally
Blank

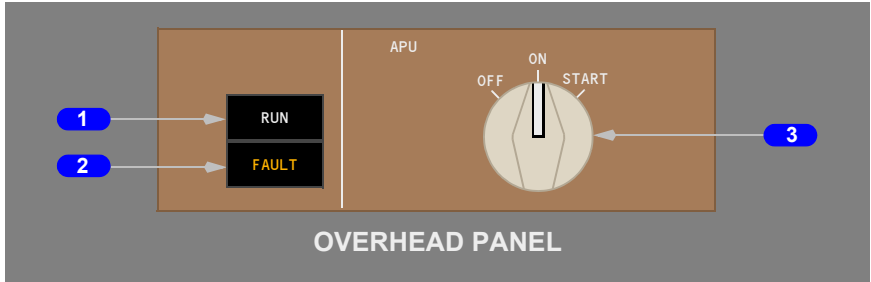
Auxiliary Power Unit (APU)**APU Controls****1 APU RUN Light**

Illuminated (white) - APU is at operating speed

2 APU FAULT Light

Illuminated (amber):

- the APU has automatically shut down
- the APU fuel valve disagrees with the commanded position

3 APU Selector

OFF –

- closes the APU bleed air valve, if open
- initiates APU cooling cycle
- shuts down APU when cooling cycle complete
- resets auto shutdown fault logic

ON (APU operating position) –

- opens the APU fuel valve and inlet door
- activates AC or DC fuel pump
- powers the APU controller
- permits the APU bleed valve to open if the APU Bleed Switch is on when APU reaches operating speed

START (momentary position, spring-loaded to ON) – initiates automatic start sequence

APU Indications

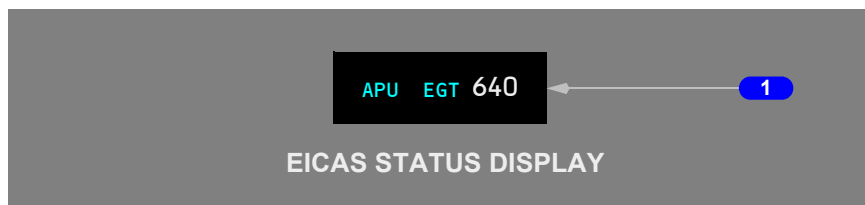

1 APU Status Display

EGT – APU exhaust gas temperature displayed in degrees centigrade

Introduction

The airplane is powered by two Pratt and Whitney PW4060 engines. The engines are rated at 60,200 pounds of takeoff thrust each.

The engines are two-rotor axial flow turbfans of high compression and bypass ratio. The N1 rotor consists of the fan, a low pressure compressor and turbine section on a common shaft. The N2 rotor consists of a high pressure compressor and turbine section on a common shaft. The N1 and N2 rotors are mechanically independent. The N2 rotor drives the engine accessory gearbox.

Each engine has individual flight deck controls. Thrust is set by positioning the thrust levers. The thrust levers are positioned automatically by the autothrottle system or manually by the flight crew.

Each engine is controlled by an electronic engine controller (EEC). The EECs monitor autothrottle and flight crew inputs through the thrust levers to automatically control the engines.

Engine indications are displayed on the engine indication and crew alerting system (EICAS) display.

Engine Indications

Primary and secondary engine indications are provided. Engine indications are displayed on the EICAS display. In addition, annunciator lights and a liquid crystal standby engine indicator are provided to monitor engine operation.

Primary Engine Indications

EPR, N1, and EGT are the primary engine indications. The primary engine indications are always displayed on the upper EICAS display.

Secondary Engine Indications

N2, fuel flow, oil pressure, oil temperature, oil quantity, and engine vibration are secondary engine indications. Secondary engine indications are displayed on the lower EICAS display. The secondary engine indications can be displayed by pushing the Engine Display Switch (the ENGINE switch on the EICAS Control Panel). The secondary engine indications are automatically displayed when:

- the displays initially receive electrical power, or
- a secondary engine parameter is exceeded.

Normal Display Format

Primary engine indications and the N2 and fuel flow indications are digital readouts and round dial/moving pointer indications. The digital readouts display numerical values while the moving pointers indicate relative value.

Oil pressure, oil temperature, oil quantity and vibration indications are both digital readouts and vertical indication/moving pointers. All digital readouts are enclosed by boxes. The dial and vertical indications display the normal operating range, caution range, and operating limits.

Normal operating range is displayed on a dial or vertical indication in white.

The oil temperature vertical indication has caution ranges displayed by amber bands. If oil temperature reaches the caution range, the digital readout, digital readout box, and pointer all change color to amber.

N1, EGT, N2, oil pressure, and oil temperature indications have operating limits indicated by red lines. If one of these indications reaches the red line, the digital readout, box, and pointer change color to red for that indication.

The EGT indication has a maximum continuous limit represented by an amber band. If EGT reaches the maximum continuous limit, the digital indication, box, pointer, and dial all change color to amber. The EGT indication is inhibited from changing to amber during takeoff or go-around for five minutes. The inhibit is extended to ten minutes for single-engine operation. The red line limits for these parameters are not inhibited. The EGT indication has a maximum takeoff limit displayed by a red line. If EGT reaches the maximum takeoff limit, the digital indication, box, pointer and dial, all change color to red.

The maximum EPR limit is indicated by an amber line on the EPR dial. The EPR indication does not change color when maximum EPR is reached. The reference/target EPR indication displays the FMS reference or target EPR. The commanded EPR indication displays the EEC calculated EPR commanded by thrust lever position.

Compact Display Format

In compact format, primary and secondary engine indications are combined on the same display. The EPR and N1 displays are the same as the normal displays. All other indications change to digital readouts only. If an amber or red line parameter for a digital indication is exceeded, the digital indication changes color to amber or red (as does the box that appears around an EGT indication).

Primary and secondary engine indications are displayed on EICAS in compact format whenever a CRT fails.

Engine Secondary Data Cue

A series of blue 'v's are visible on the lower left corner of the upper EICAS CRT any time engine data is displayed on the lower EICAS CRT. If for some reason the engine data is not visible, the Status Display Switch may be used to allow the engine data to come up partially compacted on the upper EICAS CRT display.

Engine Pressure Ratio (EPR)

Engine Pressure Ratio is the primary thrust parameter. Annunciations associated with EPR are:

- Maximum EPR
- Thrust Reference Mode
- Reference/Target EPR indication
- Reference EPR
- Assumed Temperature
- Thrust Reverser Indication
- Command Thrust Level
- Commanded EPR Sector

The maximum EPR is the maximum certified thrust limit for all phases of flight and varies with existing ambient conditions. The maximum EPR is indicated by dual amber radials on the periphery of the EPR indicator. This value is acquired from the EEC or the TMC. With the EEC operating normally, the thrust levers can be moved to the forward stop and the engines will not exceed the displayed maximum EPR.

The command thrust level is a display of thrust lever position and appears as an extension of the EPR pointer when the engine is stabilized. A change in thrust lever position moves the command thrust level and displays the commanded thrust on the EPR indicator. This allows for precise thrust control.

The command sector is a display of the momentary difference between the command thrust level and actual EPR and appears as a white band on the EPR indicator. As the engine accelerates or decelerates to the command thrust level the command sector is erased. This allows for monitoring of engine acceleration and deceleration.

Thrust reverser indication (REV) is displayed above the EPR indicator when the reverser is activated. The annunciation is amber when the reverser is unlocked or in transit. When the reverser is fully deployed, the annunciation changes color to green and the forward thrust reference displays are inhibited.

Thrust Management Computer (TMC)

The thrust management computer calculates a reference EPR based on existing pressure altitude and ambient temperature data from the air data system for the following modes:

- TO – takeoff
- D-TO – assumed temperature takeoff
- CLB – climb
- CLB 1 – climb one
- CLB 2 – climb two
- CRZ – cruise
- CON – continuous
- GA – go-around

These modes can be selected with the thrust mode select panel (TMSP). The inner thrust reference set control on the EICAS control panel must be pushed in for the thrust reference modes to be displayed on EICAS. The selected thrust reference mode is displayed above the EPR indicators. The digital reference EPR is displayed adjacent to the mode display. When the EPR bug is green, it is positioned on the EPR scale at the same value as the digital reference EPR.

The thrust mode select switches provide the capability of selecting different thrust modes for each phase of flight. The TO/GA switch is used to select takeoff thrust on the ground and go-around thrust inflight.

The assumed temperature for a reduced thrust takeoff can be set by:

- using the assumed temperature selector on the TMSP
- entering the assumed temperature into the CDU TAKEOFF REF page

The 1 and 2 switches are used to select reduced climb thrust. Reduced climb thrust one or two can be preselected in conjunction with takeoff or assumed temperature takeoff thrust prior to takeoff. The CLB switch is used to select climb thrust inflight. If reduced climb thrust one or two was preselected, pushing the climb switch inflight selects CLB 1 or CLB 2.

The CON switch is used to select maximum continuous thrust inflight. The CRZ switch is used to select cruise thrust inflight. The assumed temperature selector or the CDU is used to set assumed temperatures when reduced takeoff thrust is desired.

To manually set Reference EPR values the thrust reference set control is pulled out, MAN appears as the thrust mode annunciation and the EPR bug slews to 1.55. Manual reference EPR values can then be set by rotating the inner control. The outer control of the thrust reference set control is used to select the desired EPR indicator(s) for manual EPR display. The autothrottles do not respond to manually set reference EPR values. When the inner control is pulled out, the autothrottles remain in the active TMC mode. The TMSP remains operable and the autothrottles respond to TMSP mode changes, but selected thrust reference mode displays are inhibited.

When the AFDS VNAV mode is engaged, the EPR bug may be magenta. When the EPR bug is magenta, it is positioned at a nominal target EPR by the FMC, which may not correlate with the digital reference EPR. In VNAV, the FMC controls Thrust mode selection automatically to meet thrust requirements for the active vertical mode of operation. The FMC does not have the capability to select reduced climb thrust values, these values must be selected manually with the 1 or 2 TMSP switches.

The thrust reference mode, reference EPR and EPR bug are not displayed when the reversers are fully deployed.

Assumed Temperature Takeoff

The thrust management computer calculates the reference EPR for assumed temperature reduced thrust takeoff. The assumed temperature can be entered manually on the CDU TAKEOFF REF page or selected with the assumed temperature selector on the TMSP. The assumed temperature is displayed above the thrust reference mode.

When the assumed temperature selector on the TMSP is initially rotated clockwise, a reference temperature is displayed on EICAS. This temperature also appears on the CDU TAKEOFF REF page as THRUST.

Further clockwise rotation of the selector increases the assumed temperature by 1 degree centigrade per click. The reduced thrust annunciation of D-TO appears when the assumed temperature selected is above ambient. If the ambient temperature is greater than the initially displayed reference temperature, D-TO and reduced thrust occur when the assumed temperature selected exceeds ambient.

Counterclockwise rotation of the selector reduces the assumed temperature by one degree centigrade per click.

Assumed temperature takeoff thrust is limited to a 25% reduction of takeoff thrust or selected climb thrust, whichever is the greater thrust value. When the limit is reached, further adjustment to the assumed temperature by rotating the assumed temperature selector on the TMSP or changing the value entered in the CDU TAKEOFF REF page does not change the displayed assumed temperature or reference thrust value.

Reduced Climb Thrust

Two levels of reduced climb thrust are available with the 1 and 2 mode switches on the thrust mode select panel. Climb 1 is approximately 90% of climb thrust and climb 2 is approximately 80% of climb thrust. Climb one or two can be preselected in conjunction with the TO, D–TO, CON and CRZ thrust reference modes.

Above 10,000 feet, reduced climb thrust gradually changes to reach full climb thrust by 12,000 feet. The 1 or 2 annunciation disappears from the display by 12,500 feet.

Electronic Engine Control (EEC) – PW4000 Series Engine

The thrust system consists of a dual channel, full authority Electronic Engine Control unit without any hydromechanical backup. Each EEC is powered, when the engines are operating, by a dedicated permanent magnet alternator (PMA) independent of airplane electrical power. The EEC commands constant engine output for a given thrust lever position. EPR is the prime thrust setting parameter, N1 is alternate.

The EEC continuously computes the maximum thrust limit which is presented as an amber radial on the EPR display. Maximum rated thrust is available in any phase of flight by moving the thrust levers to the full forward positions.

Primary (EPR) Control Mode

Both engines normally operate in the primary mode to control thrust. In primary control mode operation, target EPR for current thrust lever position is computed as a ratio to the full throttle position. During rapid thrust lever movements, the difference between the engines actual EPR and the EEC commanded EPR is displayed as the command sector on the EICAS EPR display.

The EICAS advisory message L or R ENGINE CONTROL displays when faults are detected in the engine control systems. This message is designed to prevent dispatch with these faults.

The dual channel system provides redundancy of inputs to the engine fuel control.

Alternate (N1) Control Mode

If the EEC is unable to maintain EPR control, the EEC will automatically revert to the alternate control mode. The alternate control mode may be manually selected by using the flight deck EEC switches. When operating in alternate control mode, the ALTN light illuminates and the EICAS advisory message L or R ENG EEC MODE displays to indicate the EEC has reverted to the alternate mode.

In the alternate control mode, target N1 for current thrust lever position is computed as a ratio to the full throttle position. Due to changes in thrust produced at constant N1 setting during changes in ambient conditions, alternate control mode operations during climbs and descents require thrust lever adjustment to maintain constant thrust. Thrust is controlled in a manner similar to conventional fuel controls.

The alternate control mode has a dual channel system providing redundancy of inputs to the engine fuel controls. Automatic thrust limit protection is not available. In the alternate mode, the EICAS caution message L or R ENG LIM PROT displays to indicate the commanded N1 exceeds the maximum N1.

Overspeed Protection

In either control mode the EEC also provides N1 and N2 red line overspeed protection. If N1 or N2 approaches overspeed, the EEC commands reduced fuel flow. The EICAS advisory message L or R ENG RPM LIM displays to indicate N1 or N2 is at the red line limit.

The EEC does not provide EGT overtemperature protection.

If engine limit protection is not available, advancing the thrust levers full forward should be considered only during emergency situations when all other available actions have been taken and terrain contact is imminent.

Idle Selection

There are two engine idle speeds: minimum idle and approach idle. Minimum idle is a lower thrust than approach idle and selected for ground operation and all phases of flight except approach and landing. Approach idle is selected whenever this higher idle setting is required for proper system operation. The EEC selects these idle speeds automatically.

Rotating the engine start selectors to continuous manually selects approach idle.

The EICAS advisory message L or R ENG LOW IDLE displays to indicate an engine failed to go to approach idle.

The EICAS advisory message IDLE DISAGREE displays to indicate the engines are at different idle settings. Either one engine has failed to go to approach idle when required or one engine has failed to return to minimum idle. Inflight, to ensure that approach idle is available if required, the thrust lever on the engine with the lower RPM should be advanced to match the engine with the higher RPM.

Engine Start and Ignition System

Air from the pneumatic duct is used to power the air driven starter, which is connected to the N2 rotor. The starter air source may be from a ground cart, APU or the other running engine.

The engine start selectors control the start valves. Ignition and fuel flow are controlled through the fuel control switches.

A maximum start limit line (red) is displayed on the EGT indication when the fuel control switch is moved to CUT OFF. It remains displayed after the fuel control switch is moved to RUN until the engine is stabilized at idle. The EGT indication changes color to red if the EGT start limit is reached during starting.

Engine Start

Pushing in and rotating the engine start selector to the GND position, opens the start valve, engages the air driven starter to the N2 rotor and closes the engine bleed air valve if it is open. The VALVE light illuminates and the EICAS advisory message L or R ENG STARTER displays to indicate the start valve failed to open.

As N2 rotation accelerates to maximum motoring RPM, the fuel control switch is positioned to RUN.

Maximum motoring speed is reached when acceleration is less than approximately 1% in 5 seconds. Minimum N2 for selecting RUN is indicated by a magenta fuel on command bug. The fuel control switch opens the spar and engine fuel valves allowing the fuel to flow to the fuel control unit and activates the selected ignition. The ignition selector may be used to select BOTH, or either 1 or 2 ignitor(s). Normally, only one ignitor is used for ground start while both ignitors are used for inflight starts. At approximately 50% N2, the engine start selector automatically moves to the AUTO position. The starter automatically cuts out and the start valve closes stopping the flow of air to the starter. This allows the engine bleed valve to return to a position that agrees with the engine bleed air switch. If the start valve fails to close automatically, the corresponding valve light will illuminate and the EICAS caution message L or R STARTER CUTOFF will display. The engine start selector must be manually moved to the AUTO or OFF position to terminate starter operation.

Starter Operation

Continuous operation of the starter must be limited in accordance with the following starter duty cycles:

Normal Duty Cycle

Two consecutive aborted starts with EGT cooling periods. After second consecutive cooling period, let N2 drop to zero before re-engagement.

Extended Duty Cycle

- Zero to five minutes on – let N2 run down to zero before re-engaging starter
- Five to ten minutes on – followed by a ten minute cooling period
- Ten to fifteen minutes maximum on – followed by a fifteen minute cooling period

Re-engagement Speed

- 0% N2 – recommended
- 0–20% N2 – normal

Re-engagement is not recommended above 20% N2 except in case of fire. Re-engagement above 30% N2 may result in starter or gearbox damages.

In-Flight Start

Inflight start envelope information is displayed on the EICAS primary display when an engine is not running in flight, the respective engine fire switch is not pulled and both EICAS primary and secondary displays are selected. The inflight start envelope indicates the airspeed range necessary to ensure an inflight start at the current flight level. If the current flight level is above the maximum start altitude, the maximum start altitude and respective airspeed range are displayed.

A crossbleed start indication (X-BLD) appears above the N2 indication and a fuel on command bug is displayed if airspeed is below that recommended for a windmilling start.

Engine Ignition

Each engine has two ignitors. Dual ignitors are always used for inflight starts.

Main AC power is the normal power source for ignition. Standby AC power provides a backup source.

Engine Start and Ignition System Schematic

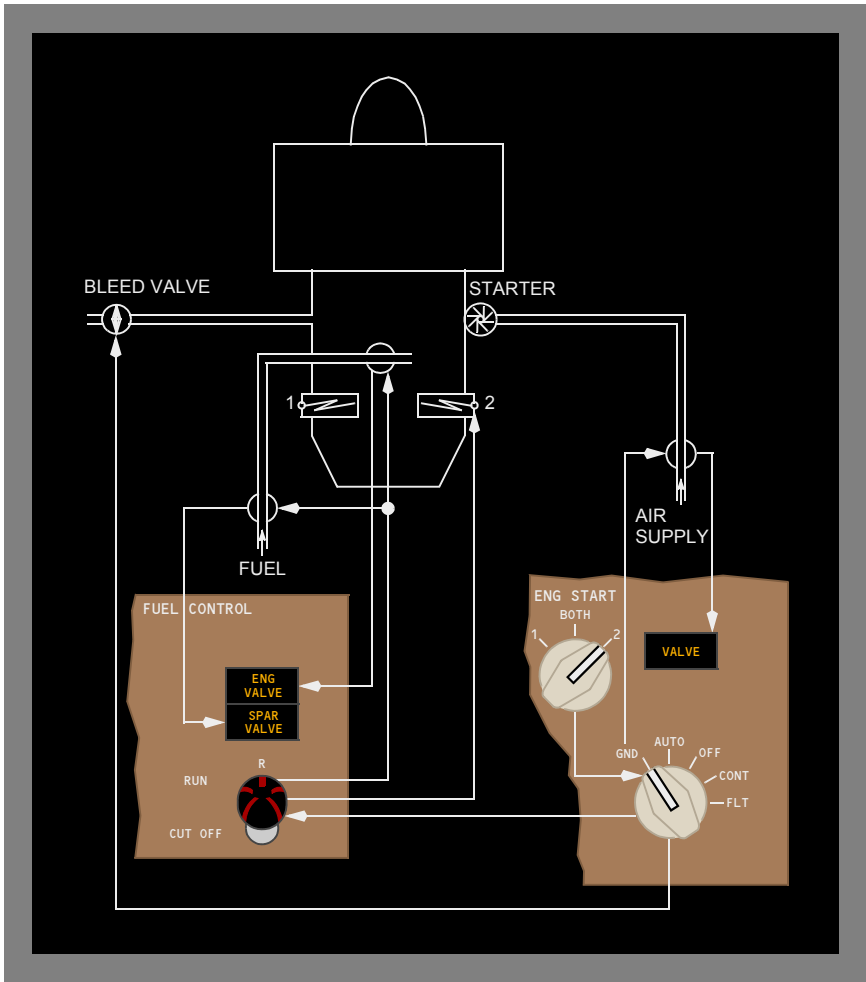

Engine Fuel System

Fuel is supplied by fuel pumps located in the fuel tanks. The fuel flows through a spar fuel valve located in the main tank. It then passes through the first stage engine fuel pump where additional pressure is added.

The fuel flows through a fuel/oil heat exchanger where it is preheated. A fuel filter removes contaminants.

A second stage engine fuel pump adds more pressure before the fuel reaches the fuel control unit. The fuel is then controlled to meet the existing thrust requirements. The fuel then flows through the engine fuel valve and fuel flow meter before entering the engine.

Fuel control Unit

The engine fuel control system incorporates a fuel control unit which operates in conjunction with the EEC. The fuel control system schedules fuel flow to meet engine thrust requirements as dictated by the thrust lever position and the specific engine operating conditions. The EEC controls the metered fuel and prevents engine limits from being exceeded.

Engine and Spar Valves

The spar and engine fuel valves allow fuel flow to the engine when both valves are open. The valves open when the engine fire switch is IN and the fuel control switch is in the RUN position. Both valves close when either the fuel control switch is in CUT OFF or the engine fire switch is OUT.

The ENG VALVE and SPAR VALVE lights illuminate momentarily as the valves open or close. If the valves do not agree with the fuel control switch or the respective fire switch position after allowing for the normal operating time, the lights remain illuminated and the EICAS advisory message L or R FUEL SPAR VAL or L or R ENG FUEL VAL displays.

Fuel Filter

The fuel is filtered by a filter with bypass capabilities. If the filter becomes clogged with contaminants, fuel will bypass the filter allowing contaminated fuel to enter the fuel control unit.

The EICAS advisory message L or R ENG FUEL FILT displays to indicate the affected engine filter is approaching a level sufficient to cause filter bypass.

Erratic engine operation and flameout may occur due to fuel contamination.

Fuel Flow Measurement

Fuel flow is measured after passing through the engine fuel valve. Fuel flow is displayed on the secondary engine display. Fuel flow information is also provided to the FMS.

Engine Fuel System Schematic

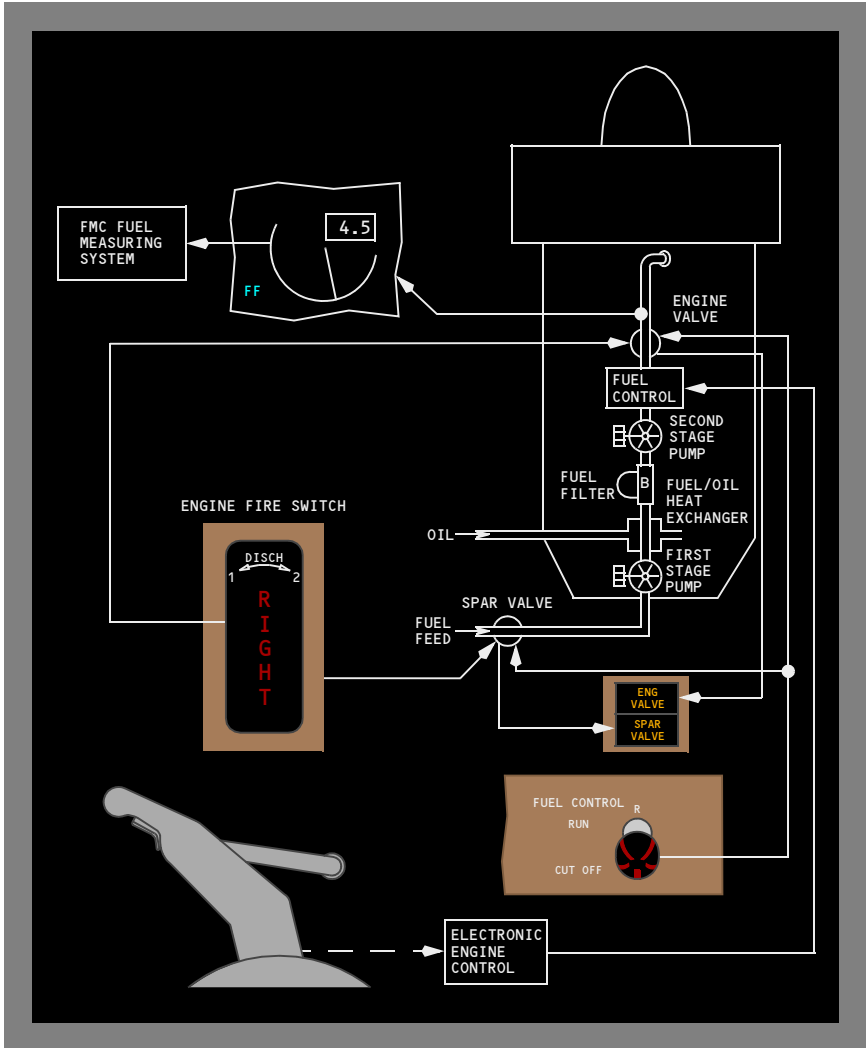

Engine Oil System – PW4000 Series Engine

The oil system provides pressurized oil to lubricate and cool the engine main bearings, gears and accessory drives. The oil system also provides automatic fuel heating for fuel system icing protection.

As an engine is started, a quantity of oil will transfer from the oil reservoir to the engine bearing compartments and gearbox. This results in a decrease of indicated oil quantity. During engine shutdown, the indicated oil quantity increases as the oil is returned to the reservoir. In addition, oil temperature will tend to vary with engine RPM such that, as RPM is increased, temperature increases. As RPM is decreased, temperature decreases.

Oil is pressurized by a main (engine-driven) oil pump. From the pump, the oil flows through the oil filter where contaminants are removed. Should the oil filter become saturated with contaminants, oil will automatically bypass the filter. The EICAS advisory message L or R OIL FILTER displays indicating the oil filter is bypassed. The oil flows through the oil coolers where fuel and air are used as the heat sink, and is then delivered to the engine main bearings, gears, and accessory drives. The oil is then returned to the reservoir.

Oil pressure, temperature, and quantity are displayed on the secondary engine display.

Oil pressure is measured prior to entering the engine. The L or R ENG OIL PRESS light illuminates and the L or R ENG OIL PRESS EICAS advisory message displays to indicate the oil pressure is low. When the oil pressure is at or below the minimum limit, the EICAS indication changes to red.

Oil temperature is measured after leaving the scavenge pump, prior to entering the reservoir. When the oil temperature is in the caution range, the EICAS indication changes to amber.

There is no minimum oil quantity limit (no amber or red line limit). There are no operating limitations for the engine oil quantity; therefore, there are no flight crew procedures based solely on a response to low oil quantity.

Engine Oil System Schematic – PW4000 Series Engine

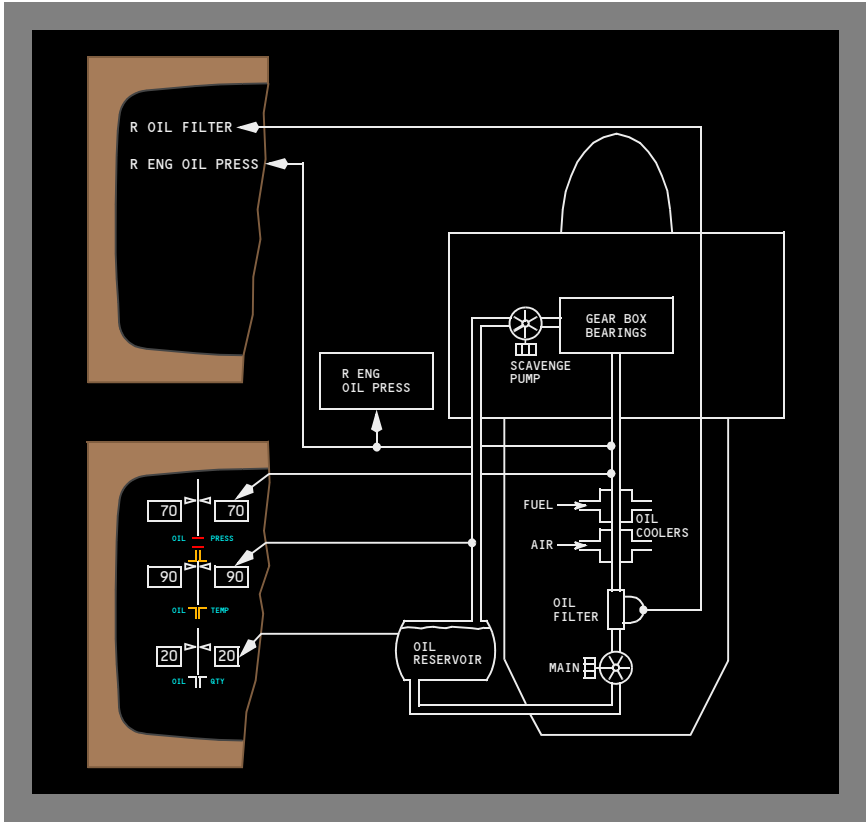

Thrust Reverser System

Each engine has a hydraulically actuated fan air thrust reverser. Reverse thrust is available only on the ground.

The reverse thrust levers can be raised only when the forward thrust levers are in the idle position. An interlock stop limits thrust to idle reverse while the reverser is in transit.

The EECs control thrust limits during reverser operation.

When the reverse thrust levers are pulled aft to the interlock position:

- the autothrottle disengages
- the auto speedbrakes deploy

When the reverser system is activated:

- reverser isolation valve opens allowing the reverser translating sleeves to hydraulically move aft
- the fan flow blocker doors rotate into place to direct fan air through stationary cascade guide vanes
- the reverser indication (REV) is displayed above each digital EPR indication (REV is displayed in amber when the reverser is in transit)

When the interlock releases:

- the reverse thrust levers can be raised to the maximum reverse thrust position
- the REV indication changes to green when the reverser is fully deployed

Pushing the reverse thrust levers to the full down position retracts the reversers to the stowed and locked position. While the reverser is in transit, the REV annunciation changes color to amber. The thrust levers cannot be moved forward until the reverse thrust levers are fully down. When the reverser reaches the stowed position, the amber REV annunciation disappears.

Each thrust reverser is automatically protected against unintentional reverse thrust. If an uncommanded thrust reverser movement is sensed, an autostow feature automatically applies hydraulic power to stow the reverser.

The EICAS advisory message L or R REV ISLN VAL is displayed and the REV ISLN light illuminates when a fault exists in the reverser system.

The light and message are inhibited in flight.

An electromechanical lock prevents uncommanded reverser deployment in the event of thrust reverser system failures.

Thrust Reverser Schematic

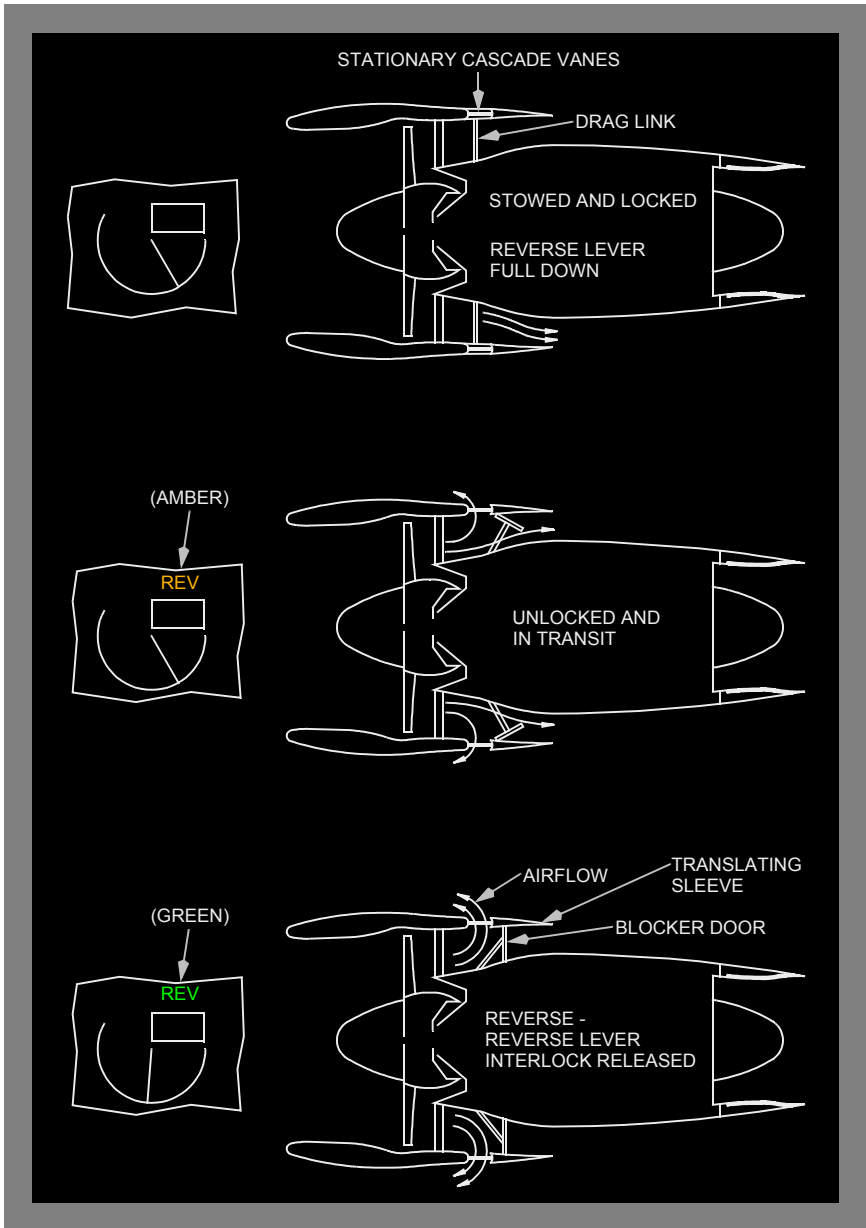

Airborne Vibration Monitoring System

The airborne vibration monitoring system monitors engine vibration levels. The vibration indications are displayed on the secondary engine display. The vibration source indication is also displayed. If the vibration monitoring system cannot determine the source (N1 or N2), broadband (BB) is displayed for the affected engine. Broadband vibration is the average vibration detected.

Certain engine malfunctions can result in airframe vibrations from the windmilling engine. As the airplane transitions from cruise to landing, there can be multiple, narrow regions of altitudes and airspeeds where the vibration level can become severe. In general, airframe vibrations can best be reduced by descending and reducing airspeed. However, if after descending and reducing airspeed, the existing vibration level is unacceptable, and if it is impractical to further reduce airspeed, the vibration level may be reduced to a previous, lower level by a slight increase in airspeed.

Intentionally
Blank

Introduction

The airplane is powered by two General Electric CF6-80C2B6F engines. The engines are rated at 60,200 pounds of takeoff thrust each.

The engines are two-rotor axial flow turbfans of high compression and bypass ratio. The N1 rotor consists of the fan, a low pressure compressor and turbine section on a common shaft. The N2 rotor consists of a high pressure compressor and turbine section on a common shaft. The N1 and N2 rotors are mechanically independent. The N2 rotor drives the engine accessory gearbox.

Each engine has individual flight deck controls. Thrust is set by positioning the thrust levers. The thrust levers are positioned automatically by the autothrottle system or manually by the flight crew. See Chapter 11, Flight Management, Navigation, Section 40, for a description of FMC thrust management functions.

Each engine is controlled by an electronic engine controller (EEC). The EECs monitor autothrottle and flight crew inputs through the thrust levers to automatically control the engines.

Engine indications are displayed on the engine indication and crew alerting system (EICAS) display.

Engine Indications

Primary and secondary engine indications are provided. Engine indications are displayed on the EICAS display. In addition, annunciator lights and a liquid crystal standby engine indicator are provided to monitor engine operation.

Primary Engine Indications

N1 and EGT are the primary engine indications. The primary engine indications are always displayed on the upper EICAS display.

Secondary Engine Indications

N2, fuel flow, oil pressure, oil temperature, oil quantity, and engine vibration are secondary engine indications. Secondary engine indications are displayed on the lower EICAS display. The secondary engine indications can be displayed by pushing the Engine Display Switch (the ENGINE switch on the EICAS Control Panel).

The secondary engine indications are automatically displayed when:

- the displays initially receive electrical power, or
- a secondary engine parameter is exceeded.

Normal Display Format

Primary engine indications and the N2 and Fuel Flow indications are digital readouts and round dial/moving pointer indications. The digital readouts display numerical values while the moving pointers indicate relative value.

Oil pressure, oil temperature, oil quantity and vibration indications are both digital readouts and vertical indication/moving pointers. All digital readouts are enclosed by boxes. The dial and vertical indications display the normal operating range, caution range, and operating limits (as applicable).

Normal operating range is displayed on a dial or vertical indication in white.

The oil pressure and oil temperature vertical indications have caution ranges displayed by amber bands. If oil pressure or oil temperature reaches the caution range, the digital readout, digital readout box, and pointer all change color to amber.

N1, EGT, N2, oil pressure, and oil temperature indications have operating limits indicated by red lines. If one of these indications reaches the red line, the digital readout, box, and pointer change color to red for that indication.

The EGT indication has a maximum continuous limit represented by an amber band. If EGT reaches the maximum continuous limit, the digital indication, box, pointer, and dial all change color to amber.

The EGT indication is inhibited from changing to amber during takeoff or go-around for five minutes. The red line limits for these parameters are not inhibited.

The EGT indication has a maximum takeoff limit displayed by a red line. If EGT reaches the maximum takeoff limit, the digital indication, box, pointer and dial, all change color to red.

The maximum N1 limit is indicated by an amber line on the N1 dial. The N1 indication does not change color when maximum N1 is reached. The reference/target N1 indication displays the FMS reference or target N1.

Compact Display Format

In compact format, primary and secondary engine indications are combined on the same display. The N1 and EGT displays are the same as the normal displays. All other indications change to digital readouts only. If an amber or red line parameter for a digital indication is exceeded, the digital indication changes color to amber or red (as does the box that appears around an EGT indication).

Primary and secondary engine indications are displayed on EICAS in compact format whenever a CRT fails.

Engine Secondary Data Cue

A series of blue 'v's are visible on the lower left corner of the upper EICAS CRT any time engine data is displayed on the lower EICAS CRT. If for some reason the engine data is not visible, the Status Display Switch may be used to allow the engine data to come up partially compacted on the upper EICAS CRT display.

N1 RPM

N1 RPM is the primary thrust parameter. Annunciations associated with N1 are:

- Maximum N1
- Thrust Reference Mode
- Reference/Target N1 Indication
- Reference N1
- Assumed Temperature
- Thrust Reverser Indication
- Command Thrust Level
- Command Sector

The maximum N1 is the maximum certified thrust limit for all phases of flight and varies with existing ambient conditions. The maximum N1 is indicated by dual amber radials on the periphery of the N1 indicator. This value is acquired from the EEC or the TMC. With the EEC operating normally, the thrust levers can be moved to the forward stop and the engines will not exceed the displayed maximum N1.

The command thrust level is a display of thrust lever position and appears as an extension of the N1 pointer when the engine is stabilized. A change in thrust lever position moves the command thrust level and displays the commanded thrust on the N1 indicator. This allows for precise thrust control.

The command sector is a display of the momentary difference between the command thrust level and actual N1 and appears as a white band on the N1 indicator. As the engine accelerates or decelerates to the command thrust level the command sector is erased. This allows for monitoring of engine acceleration and deceleration.

Thrust reverser indication (REV) is displayed above the N1 indicator when the reverser is activated. The annunciation is amber when the reverser is unlocked or in transit. When the reverser is fully deployed, the annunciation changes color to green and the forward thrust reference displays are inhibited.

Thrust Management Computer (TMC)

The thrust management computer calculates a reference N1 based on existing pressure altitude and ambient temperature data from the air data system for the following modes:

- TO – takeoff
- D-TO – assumed temperature takeoff
- CLB – climb
- CLB 1 – climb one
- CLB 2 – climb two
- CRZ – cruise
- CON – continuous
- GA – go-around

These modes can be selected with the thrust mode select panel (TMSP). The inner thrust reference set control on the EICAS control panel must be pushed in for the thrust reference modes to be displayed on EICAS. The selected thrust reference mode is displayed above the N1 indicators. The digital reference N1 is displayed adjacent to the mode display. When the N1 bug is green, it is positioned on the N1 scale at the same value as the digital reference N1.

The thrust mode select switches provide the capability of selecting different thrust modes for each phase of flight. The TO/GA switch is used to select takeoff thrust on the ground and go-around thrust inflight.

The assumed temperature for a reduced thrust takeoff can be set by:

- using the assumed temperature selector on the TMSP
- entering the assumed temperature into the CDU TAKEOFF REF page

The 1 and 2 switches are used to select reduced climb thrust. Reduced climb thrust one or two can be preselected in conjunction with takeoff or assumed temperature takeoff thrust prior to takeoff. The CLB switch is used to select climb thrust inflight. If reduced climb thrust one or two was preselected, pushing the climb switch inflight selects CLB 1 or CLB 2.

The CON switch is used to select maximum continuous thrust inflight. The CRZ switch is used to select cruise thrust inflight. The assumed temperature selector or the CDU is used to set assumed temperatures when reduced takeoff thrust is desired.

To manually set Reference N1 values the thrust reference set control is pulled out, MAN appears as the thrust mode annunciation and the N1 bug slews to 104%. Manual reference N1 values can then be set by rotating the inner control. The outer control of the thrust reference set control is used to select the desired N1 indicator(s) for manual N1 display. The autothrottles do not respond to manually set reference N1 values. When the inner control is pulled out, the autothrottles remain in the active TMC mode. The TMSP remains operable and the autothrottles respond to TMSP mode changes, but selected thrust reference mode displays are inhibited.

When the AFDS VNAV mode is engaged, the N1 bug may be magenta. When the N1 bug is magenta, it is positioned at a nominal target N1 by the FMC, which may not correlate with the digital reference N1. In VNAV, the FMC controls Thrust mode selection automatically to meet thrust requirements for the active vertical mode of operation. The FMC does not have the capability to select reduced climb thrust values, these values must be selected manually with the 1 or 2 TMSP switches.

The thrust reference mode, reference N1 and N1 bug are not displayed when the reversers are fully deployed.

Assumed Temperature Takeoff

The thrust management computer calculates the reference N1 for assumed temperature reduced thrust takeoff. The assumed temperature can be entered manually on the CDU TAKEOFF REF page or selected with the assumed temperature selector on the TMSP. The assumed temperature is displayed above the thrust reference mode.

When the assumed temperature selector on the TMSP is initially rotated clockwise, a reference temperature is displayed on EICAS. This temperature also appears on the CDU TAKEOFF REF page as THRUST.

Further clockwise rotation of the selector increases the assumed temperature by 1 degree centigrade per click. The reduced thrust annunciation of D-TO appears when the assumed temperature selected is above ambient. If the ambient temperature is greater than the initially displayed reference temperature, D-TO and reduced thrust occur when the assumed temperature selected exceeds ambient.

Counterclockwise rotation of the selector reduces the assumed temperature by one degree centigrade per click.

Assumed temperature takeoff thrust is limited to a 25% reduction of takeoff thrust or selected climb thrust, whichever is the greater thrust value. When the limit is reached, further adjustment to the assumed temperature by rotating the assumed temperature selector on the TMSP or changing the value entered in the CDU TAKEOFF REF page does not change the displayed assumed temperature or reference thrust value.

Reduced Climb Thrust

Two levels of reduced climb thrust are available with the 1 and 2 mode switches on the thrust mode select panel. Climb 1 is approximately 90% of climb thrust and climb 2 is approximately 80% of climb thrust. Climb one or two can be preselected in conjunction with the TO, D–TO, CON and CRZ thrust reference modes.

Above 10,000 feet, reduced climb thrust gradually changes to reach full climb thrust by 12,000 feet. The 1 or 2 annunciation disappears from the display by 12,500 feet.

Electronic Engine Control (EEC)

Each EEC has full authority over engine operation. The EEC uses thrust lever inputs to automatically control forward thrust and reverse thrust. The EEC has two control modes: normal and alternate. In normal and alternate modes, the EEC uses N1 RPM as the parameter for setting thrust.

EEC Normal Control Mode

In the normal mode, the EEC sets thrust by controlling N1 based on thrust lever position. N1 is commanded by positioning the thrust levers either automatically with the autothrottles, or manually by the flight crew.

Maximum N1 represents the maximum rated thrust available from the engine. The EEC continuously computes maximum N1.

Maximum rated thrust is available in any phase of flight by moving the thrust levers to the full forward positions.

The EICAS advisory message L or R ENG CONTROL and ENGINE CONTROLS displays when faults are detected in the engine control systems.

EEC Alternate Mode

If the required signals are not available to operate in the normal mode, the EEC automatically uses the alternate mode. In the alternate mode, the EEC schedules N1 as a function of thrust lever position. The alternate mode provides soft and hard levels of control:

- Soft – When the EEC automatically switches an engine to the alternate mode and the EEC mode switch remains in NORM, the EEC is in the soft alternate mode (the switch position is NORM, the EEC mode is alternate). At a fixed thrust lever position, thrust does not change.
- Hard – When ALTN is manually selected on an EEC mode switch, that engine is switched to the hard alternate mode (the switch position is ALTN, the EEC mode is alternate). Reference and target N1, and maximum and commanded N1 values are displayed on the N1 indication during the hard alternate mode. Thrust may change to set the commanded N1 when ALTN is manually selected.

For the normal, soft alternate, and hard alternate modes, actual, command, reference/target, maximum, and red line N1 information is displayed.

Automatic reversion or manual selection to the alternate mode is indicated by the EICAS advisory message L or R ENG EEC MODE and illumination of the ALTN light on the associated EEC mode switch. Selecting the alternate mode on both engines eliminates thrust lever stagger at equal thrust settings, or asymmetric thrust when the thrust levers are operated together.

The autothrottles remain engaged whenever the EEC automatically switches to the alternate mode. The alternate mode N1 reference/target values are computed by the TMC.

Note: Autothrottles remains engaged in the soft or hard alternate mode.

The alternate mode schedule (N1 schedule) provides equal or greater thrust than the normal mode for the same thrust lever position.

Thrust protection is not provided in the alternate mode and maximum rated thrust is reached at a thrust lever position less than full forward. As a result, thrust overboost can occur at full forward thrust lever positions. The EICAS caution message L or R ENG LIMIT PROT is displayed if the thrust lever position commands an N1 greater than the maximum rated thrust (maximum N1). N1 and N2 red line protection is still available in the alternate control mode.

Overspeed Protection

The EEC also provides N1 and N2 red line overspeed protection. If N1 or N2 approaches overspeed, the EEC commands reduced fuel flow.

The EICAS advisory message L or R ENG RPM LIM is displayed when N1 or N2 is at the red line limit.

The EEC does not provide EGT overtemperature protection.

If engine limit protection is not available, advancing the thrust levers full forward should be considered only during emergency situations when all other available actions have been taken and terrain contact is imminent.

Idle Selection

There are two engine idle speeds: minimum idle and approach idle. Minimum idle is a lower thrust than approach idle and selected for ground operation and all phases of flight except approach and landing. Approach idle is selected whenever this higher idle setting is required for proper system operation. The EEC selects these idle speeds automatically.

Rotating the engine start selectors to continuous manually selects approach idle.

The EICAS advisory message L or R ENG LOW IDLE displays to indicate an engine failed to go to approach idle.

The EICAS advisory message IDLE DISAGREE displays to indicate the engines are at different idle settings. Either one engine has failed to go to approach idle when required or one engine has failed to return to minimum idle. Inflight, to ensure that approach idle is available if required, the thrust lever on the engine with the lower RPM should be advanced to match the engine with the higher RPM.

Engine Start and Ignition System

Air from the pneumatic duct is used to power the air driven starter, which is connected to the N2 rotor. The starter air source may be from a ground cart, APU or the other running engine.

The engine start selectors control the start valves. Ignition and fuel flow are controlled through the fuel control switches.

A maximum start limit line (red) is displayed on the EGT indication when the fuel control switch is moved to CUT OFF. It remains displayed after the fuel control switch is moved to RUN until the engine is stabilized at idle. The EGT indication changes color to red if the EGT start limit is reached during starting.

Engine Start

Pushing in and rotating the engine start selector to the GND position, opens the start valve, engages the air driven starter to the N2 rotor and closes the engine bleed air valve if it is open. The VALVE light illuminates and the EICAS advisory message L or R ENG STARTER displays to indicate the start valve failed to open. As N2 rotation accelerates to maximum motoring RPM or 20% N2, the fuel control switch is positioned to RUN. Maximum motoring speed is reached when acceleration is less than approximately 1% in 5 seconds. Minimum N2 for selecting RUN is indicated by a magenta fuel on command bug. The fuel control switch opens the spar and engine fuel valves allowing the fuel to flow to the fuel control unit and activates the selected ignition.

The ignition selector may be used to select SINGLE or BOTH ignitor(s). With the ignition selector in SINGLE, each EEC channel alternates between the two ignitors on each engine.

Normally, only one ignitor is used for ground start while both ignitors are used for inflight starts. At approximately 50% N2, the engine start selector automatically moves to the AUTO position. The starter automatically cuts out and the start valve closes stopping the flow of air to the starter. This allows the engine bleed valve to return to a position that agrees with the engine bleed air switch. If the start valve fails to close automatically, the corresponding valve light will illuminate and the EICAS caution message L or R STARTER CUTOFF will display. The engine start selector must be manually moved to the AUTO or OFF position to terminate starter operation.

Starter Operation

Continuous operation of the starter must be limited in accordance with the following starter duty cycles:

Normal Duty Cycle

Five minutes on, followed by one-half minute off per minute on

Extended Duty Cycle

Two consecutive five minute cycles require a ten minute cooling period before each additional five minute cycles

Re-engagement Speed

- 0% N2 – recommended
- 0–20% N2 – normal

Re-engagement is not recommended above 20% N2 except in case of fire. Re-engagement above 30% N2 may result in starter or gearbox damages.

In-Flight Start

Inflight start envelope information is displayed on the EICAS primary display when an engine is not running in flight, the respective engine fire switch is not pulled and both EICAS primary and secondary displays are selected. The inflight start envelope indicates the airspeed range necessary to ensure an inflight start at the current flight level. If the current flight level is above the maximum start altitude, the maximum start altitude and respective airspeed range are displayed.

A crossbleed start indication (X-BLD) appears above the N2 indication and a fuel on command bug is displayed if airspeed is below that recommended for a windmilling start.

Auto Relight

In the air or on the ground, an automatic relight feature is enabled if N2 drops below idle speed. If this occurs, the EEC will energize both ignition systems for the affected engine(s).

Engine Ignition

Each engine has two ignitors. Dual ignitors are always used for inflight starts. Main AC power is the normal power source for ignition. Standby AC power provides a backup source.

Engine Start and Ignition System Schematic

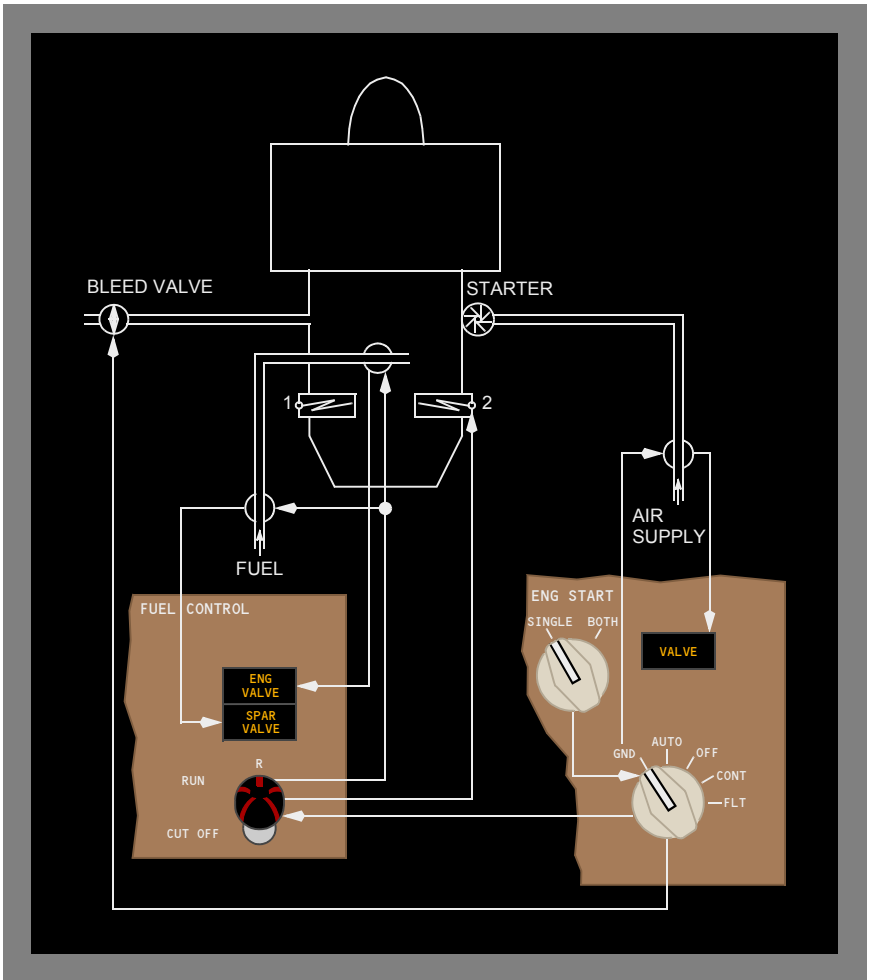

Engine Fuel System

Fuel is supplied by fuel pumps located in the fuel tanks. The fuel flows through a spar fuel valve located in the main tank. It then passes through the first stage engine fuel pump where additional pressure is added. Final pressure is generated by a second stage fuel pump prior to entering a fuel/oil heat exchanger where it is preheated. A fuel filter removes contaminants. The fuel is then controlled to meet the existing thrust requirements. The fuel then flows through the engine fuel valve and fuel flow meter before entering the engine.

Fuel Metering Unit

The engine fuel control system incorporates a fuel metering unit which operates in conjunction with the EEC. The fuel control system schedules fuel flow to meet engine thrust requirements as dictated by the thrust lever position and the specific engine operating conditions. The EEC controls the metered fuel and prevents engine limits from being exceeded.

Engine and Spar Valves

The spar and engine fuel valves allow fuel flow to the engine when both valves are open. The valves open when the engine fire switch is IN and the fuel control switch is in the RUN position. Both valves close when either the fuel control switch is in CUT OFF or the engine fire switch is OUT.

The ENG VALVE and SPAR VALVE lights illuminate momentarily as the valves open or close. If the valves do not agree with the fuel control switch or the respective fire switch position after allowing for the normal operating time, the lights remain illuminated and the EICAS advisory message L or R FUEL SPAR VAL or L or R ENG FUEL VAL displays.

Fuel Filter

The fuel is filtered by a filter with bypass capabilities. If the filter becomes clogged with contaminants, fuel will bypass the filter allowing contaminated fuel to enter the fuel control unit.

The EICAS advisory message L or R ENG FUEL FILT displays to indicate the affected engine filter is approaching a level sufficient to cause filter bypass.

Erratic engine operation and flameout may occur due to fuel contamination.

Fuel Flow Measurement

Fuel flow is measured after passing through the engine fuel valve. Fuel flow is displayed on the secondary engine display. Fuel flow information is also provided to the FMS.

Engine Fuel System Schematic

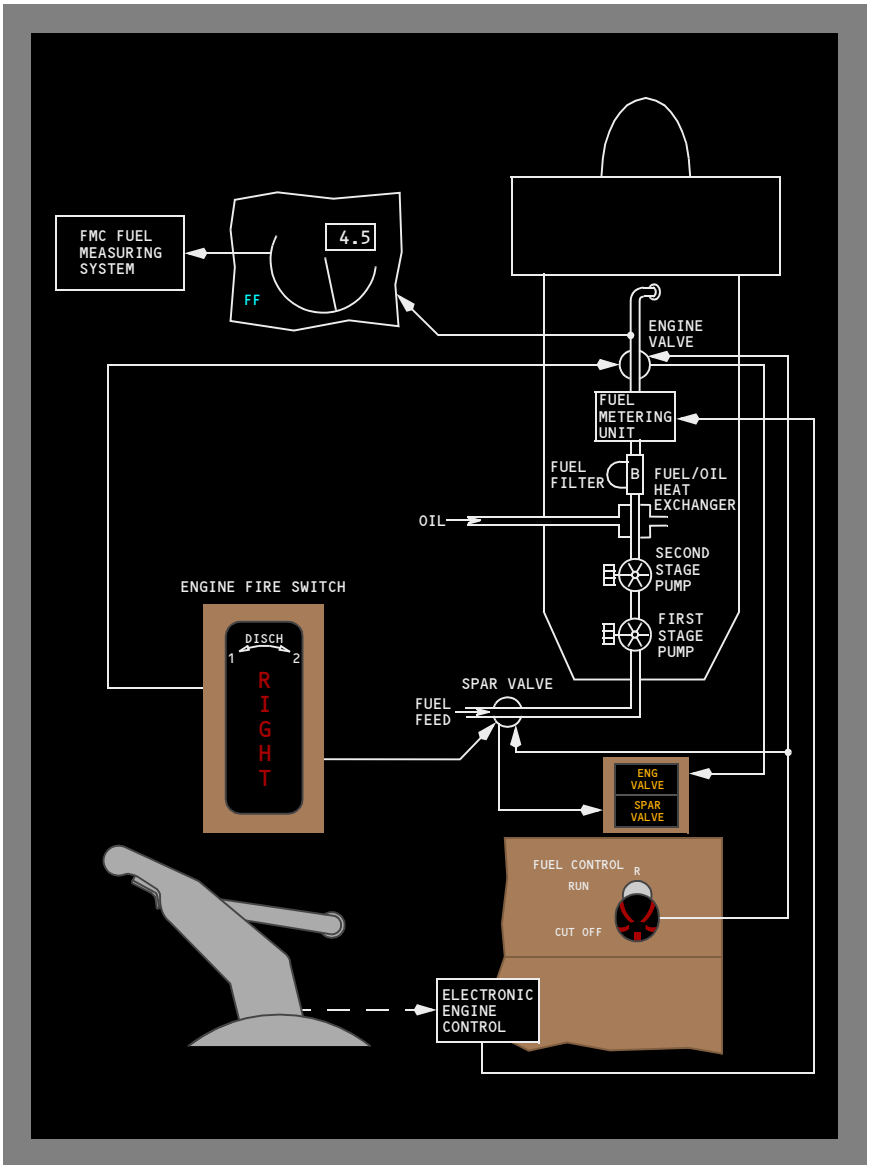

Engine Oil System

The oil system provides pressurized oil to lubricate and cool the engine main bearings, gears and accessory drives. The oil system also provides automatic fuel heating for fuel system icing protection.

Oil is pressurized by a main (engine-driven) oil pump. From the pump, the oil flows through the oil filter where contaminants are removed and then delivered to the engine main bearings, gears, and accessory drives. The oil is returned by means of a scavenge pump.

The oil enters the fuel/oil heat exchanger where fuel is used as the heat sink and then flows through a second filter before returning to the reservoir.

Should an oil filter become saturated with contaminants, oil will automatically bypass the filter. The EICAS advisory message L or R OIL FILTER displays indicating the oil filter is bypassed.

Oil pressure, temperature, and quantity are displayed on the secondary engine display.

Oil pressure is measured prior to entering the engine. The L or R ENG OIL PRESS light illuminates and the EICAS advisory message L or R ENG OIL PRESS displays to indicate the oil pressure is low. When the oil pressure is at or below the variable limits, the EICAS indication changes to amber.

Oil temperature is measured after leaving the scavenge pump, prior to entering the second filter.

There is no minimum oil quantity limit (no amber or red line limit). There are no operating limitations for the engine oil quantity; therefore, there are no flight crew procedures based solely on a response to low oil quantity.

Engine Oil System Schematic

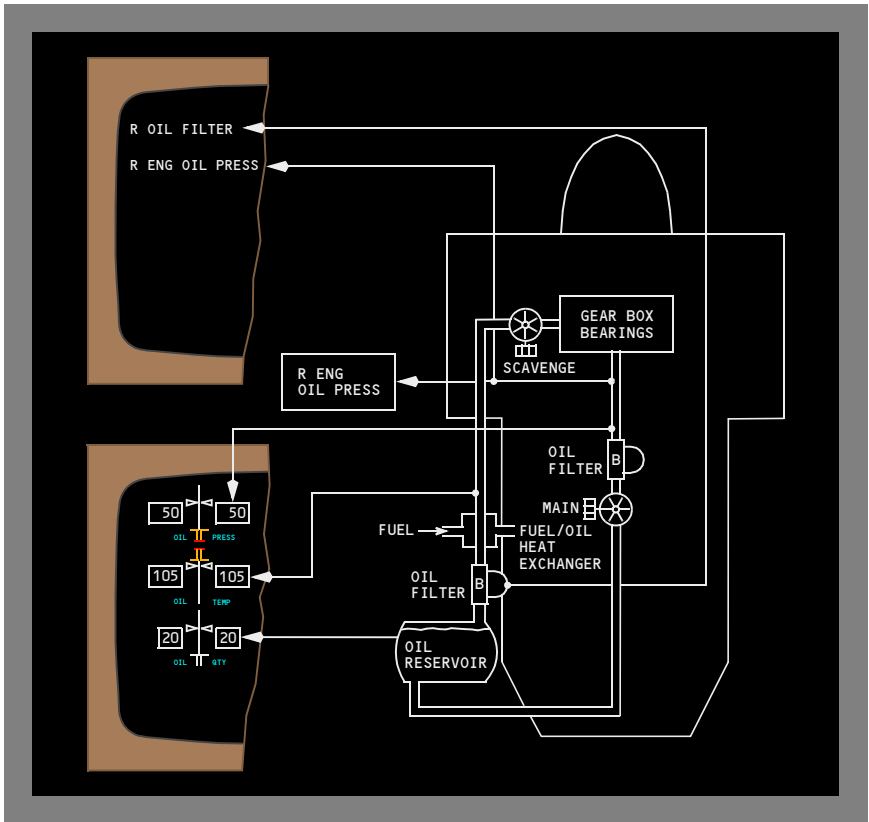

Thrust Reverser System

Each engine has a pneumatically actuated fan air thrust reverser. Reverse thrust is available only on the ground.

The reverse thrust levers can be raised only when the forward thrust levers are in the idle position. An interlock stop limits thrust to idle reverse while the reverser is in transit.

The EECs control thrust limits during reverser operation.

When the reverse thrust levers are pulled aft to the interlock position:

- the autothrottle disengages
- the auto speedbrakes deploy

When the reverser system is activated:

- reverser isolation valve opens allowing the reverser translating sleeves to pneumatically move aft
- the fan flow blocker doors rotate into place to direct fan air through stationary cascade guide vanes
- the reverser indication (REV) is displayed above each digital N1 indication (REV is displayed in amber when the reverser is in transit)

When the interlock releases:

- the reverse thrust levers can be raised to the maximum reverse thrust position
- the REV indication changes to green when the reverser is fully deployed

Pushing the reverse thrust levers to the full down position retracts the reversers to the stowed and locked position. While the reverser is in transit, the REV annunciation changes color to amber. The thrust levers cannot be moved forward until the reverse thrust levers are fully down. When the reverser reaches the stowed position, the amber REV annunciation disappears.

Each thrust reverser is automatically protected against unintentional reverse thrust. If an uncommanded thrust reverser movement is sensed, an autostow feature automatically applies pneumatic pressure to stow the reverser.

The EICAS advisory message L or R REV ISLN VAL is displayed and the REV ISLN light illuminates when a fault exists in the reverser system.

The light and message are inhibited in flight.

An electromechanical lock prevents uncommanded reverser deployment in the event of additional system failures.

Thrust Reverser Schematic

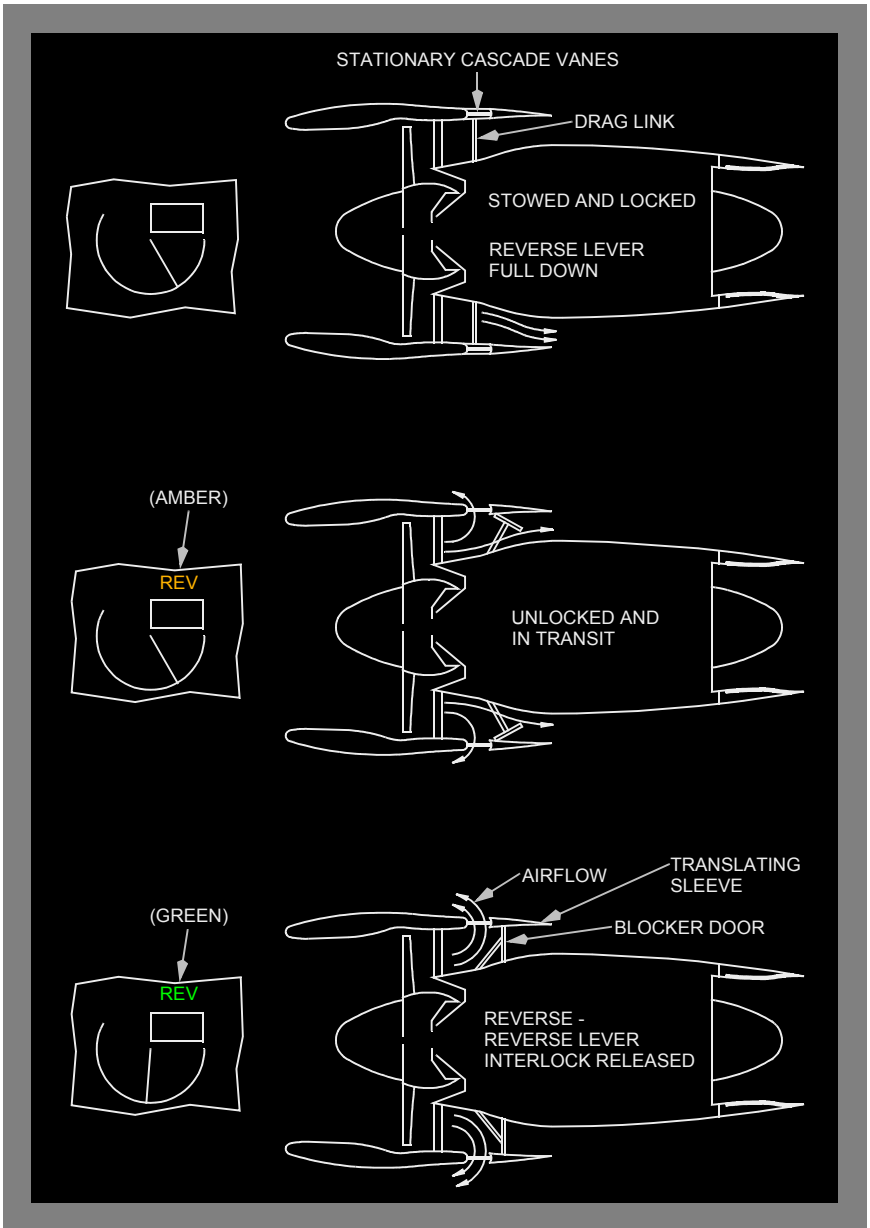

Airborne Vibration Monitoring System

The airborne vibration monitoring system monitors engine vibration levels. The vibration indications are displayed on the secondary engine display. The vibration source indication is also displayed. If the vibration monitoring system cannot determine the source (FAN, LPT or N2), broadband (BB) is displayed for the affected engine. Broadband vibration is the average vibration detected.

Certain engine malfunctions can result in airframe vibrations from the windmilling engine. As the airplane transitions from cruise to landing, there can be multiple, narrow regions of altitudes and airspeeds where the vibration level can become severe. In general, airframe vibrations can best be reduced by descending and reducing airspeed. However, if after descending and reducing airspeed, the existing vibration level is unacceptable, and if it is impractical to further reduce airspeed, the vibration level may be reduced to a previous, lower level by a slight increase in airspeed.

Introduction

The auxiliary power unit (APU) is a self-contained gas turbine engine located in the airplane tail cone. The APU air inlet door is located between the horizontal and vertical stabilizers on the right side of the airplane.

While the primary purpose of the APU is to supply electrical power and bleed air on the ground before engine start, the APU can also be started inflight, and operated up to the airplane maximum certified altitude.

Electrical power has priority over bleed air. Electrical power is available throughout the airplane operating envelope. Inflight, APU bleed air is available up to approximately 17,000 feet.

Refer to the following chapters for additional information:

- Chapter 2, Air Systems, for a description of APU bleed air operation
- Chapter 6, Electrical, for a description of APU electrical operation
- Chapter 8, Fire Protection, for a description of the APU fire protection system
- Chapter 12, Fuel, for a description of the APU fuel system

APU Operation**APU Start**

APU start requires both the APU battery and the aircraft main battery.

Fuel for the APU is supplied from the left manifold. A dedicated DC fuel pump is energized when the APU Selector is placed in the ON position if no AC power is available. When AC power is available, the left forward AC fuel pump is signaled to operate regardless of its switch position, and the DC fuel pump is signaled off.

Rotating the APU selector to START begins the automatic start sequence. The APU fuel valve opens and at the same time the APU inlet door begins to open. A fuel pump also begins to operate.

When the inlet door is open, the electric starter engages. After the APU reaches the proper speed, ignition and fuel are provided, and the APU accelerates to its normal operating speed.

The starter duty cycle is a maximum of three consecutive starts or attempts within a sixty minute period.

APU Run

When the APU RUN light illuminates, the APU may be used to supply electrical power and bleed air.

APU Shutdown

To protect the unit from thermal shock, the APU control system incorporates a time-delay feature permitting APU cooling before shutdown. If the APU is supplying pneumatic power, rotating the APU selector to OFF begins the shutdown cycle by closing the APU bleed air valve. If the APU bleed valve has been closed for a sufficient length of time when the selector is moved to OFF, the APU shuts down without delay.

If the selector is inadvertently moved to OFF, but the RUN light is still illuminated, momentarily moving the selector to START cancels the shutdown signal.

Protection System

On the ground, placing the Battery Switch OFF also results in an APU shutdown. This is not a recommended procedure however, because while the APU will go through a cooldown cycle, APU fire detection may not be available. In flight, Battery Switch position does not affect APU operation.

An amber FAULT light on the APU control panel illuminates whenever a fault is sensed. In addition, an EICAS advisory message APU FAULT is displayed, and the APU shuts down immediately. Fault detection circuitry is reset by positioning the APU Selector to OFF.

The FAULT light also comes on when the APU fuel valve is not in the commanded position. Therefore, during APU start and shutdown, the light illuminates momentarily. The EICAS advisory APU FUEL VAL appears if the valve fails to reach the commanded position.

With the APU Selector positioned to OFF, both the APU FAULT light and the associated APU FAULT EICAS message are inhibited. Only a failure of the APU fuel valve to close causes the APU FAULT light and the associated APU FUEL VAL message.

Engines, APU EICAS Messages

The following EICAS messages can be displayed.

APU

| Message | Level | Light | Aural | Condition |
|--------------|----------|-------|-------|---|
| APU FAULT | Advisory | FAULT | | The APU has automatically shut down |
| APU FUEL VAL | Advisory | FAULT | | The APU fuel valve position disagrees with the commanded position |

Engine**Control**

| Message | Level | Light | Aural | Condition |
|----------------------------------|----------|-------|--------|--|
| L ENG CONTROL R ENG CONTROL | Advisory | | | Faults are detected in the engine control system |
| L ENG EEC MODE R ENG EEC MODE | Advisory | ALTN | | The electronic engine control is not receiving adequate inputs and an alternate N1 control mode is being used by the EEC to control thrust |
| L ENG LIM PROT R ENG LIM PROT | Caution | ALTN | Beeper | The electronic engine control is operating in the ALTN control mode and the commanded N1 exceeds maximum N1 |
| L ENG LOW IDLE R ENG LOW IDLE | Advisory | | | An engine has failed to go to approach idle |
| L ENG RPM LIM R ENG RPM LIM | Advisory | | | N1 or N2 RPM is at the red line limit |
| L ENG SHUTDOWN R ENG SHUTDOWN | Caution | | | Engine was shutdown by the fuel control switch or fire switch |

| Message | Level | Light | Aural | Condition |
|---------------|----------|-------|-------|--|
| IDLE DISAGREE | Advisory | | | The engines are at different idle settings |

Fuel

| Message | Level | Light | Aural | Condition |
|------------------------------------|----------|------------|-------|---|
| L ENG FUEL FILT R ENG FUEL FILT | Advisory | | | An impending fuel filter bypass condition exists on the affected engine |
| L ENG FUEL VAL R ENG FUEL VAL | Advisory | ENG VALVE | | The engine fuel valve position disagrees with commanded position |
| L FUEL SPAR VAL R FUEL SPAR VAL | Advisory | SPAR VALVE | | The fuel spar valve position disagrees with commanded position |

Oil

| Message | Level | Light | Aural | Condition |
|------------------------------------|----------|------------------------------------|-------|--|
| L ENG OIL PRESS R ENG OIL PRESS | Advisory | L ENG OIL PRESS R ENG OIL PRESS | | Engine oil pressure is low |
| L OIL FILTER R OIL FILTER | Advisory | | | Affected engine oil filter contamination has been detected |

Start

| Message | Level | Light | Aural | Condition |
|--------------------------------------|----------|-------|--------|---|
| L ENG STARTER R ENG STARTER | Advisory | VALVE | | Engine starter valve is not in the commanded position |
| L STARTER CUTOUT R STARTER CUTOUT | Caution | VALVE | Beeper | The engine start valve is open when commanded closed |

767 Flight Crew Operations Manual**Thrust Reverser**

| Message | Level | Light | Aural | Condition |
|----------------------------------|--------------|--------------|--------------|--|
| L REV ISLN VAL R REV ISLN VAL | Advisory | REV ISLN | | Fault is detected in the affected engine reverser system |

Intentionally
Blank

Engines, APU EICAS Messages

The following EICAS messages can be displayed.

APU

| Message | Level | Light | Aural | Condition |
|--------------|----------|-------|-------|---|
| APU FAULT | Advisory | FAULT | | The APU has automatically shut down |
| APU FUEL VAL | Advisory | FAULT | | The APU fuel valve position disagrees with the commanded position |

Engine**Control**

| Message | Level | Light | Aural | Condition |
|--|----------|-------|--------|--|
| L ENG CONTROL R ENG CONTROL | Advisory | | | Faults are detected in the engine control system |
| L ENG EEC MODE R ENG EEC MODE | Advisory | ALTN | | The electronic engine control is not receiving adequate inputs and an alternate N1 control mode is being used by the EEC to control thrust |
| L ENG LIM PROT R ENG LIM PROT | Caution | ALTN | Beeper | The electronic engine control is operating in the ALTN control mode and the throttles are advanced into the overboost range |
| L ENG LOW IDLE R ENG LOW IDLE | Advisory | | | An engine has failed to go to approach idle |
| L ENG RPM LIM R ENG RPM LIM | Advisory | | | N1 or N2 RPM is at the red line limit |
| L ENG SHUTDOWN R ENG SHUTDOWN | Caution | | | Engine was shutdown by the fuel control switch or fire switch |

| Message | Level | Light | Aural | Condition |
|---------------|----------|-------|-------|--|
| IDLE DISAGREE | Advisory | | | The engines are at different idle settings |

Fuel

| Message | Level | Light | Aural | Condition |
|---------------------------------------|----------|---------------|-------|---|
| L ENG FUEL FILT R ENG FUEL FILT | Advisory | | | An impending fuel filter bypass condition exists on the affected engine |
| L ENG FUEL VAL R ENG FUEL VAL | Advisory | ENG VALVE | | The engine fuel valve position disagrees with commanded position |
| L FUEL SPAR VAL R FUEL SPAR VAL | Advisory | SPAR VALVE | | The fuel spar valve position disagrees with commanded position |

Oil

| Message | Level | Light | Aural | Condition |
|------------------------------------|----------|--|-------|--|
| L ENG OIL PRESS R ENG OIL PRESS | Advisory | L ENG OIL PRESS R ENG OIL PRESS | | Engine oil pressure is low |
| L OIL FILTER R OIL FILTER | Advisory | | | Affected engine oil filter contamination has been detected |

Start

| Message | Level | Light | Aural | Condition |
|--|----------|-------|--------|---|
| L ENG STARTER R ENG STARTER | Advisory | VALVE | | Engine starter valve is not in the commanded position |
| L STARTER CUTOUT R STARTER CUTOUT | Caution | VALVE | Beeper | The engine start valve is open when commanded closed |

767 Flight Crew Operations Manual**Thrust Reverser**

| Message | Level | Light | Aural | Condition |
|----------------------------------|--------------|--------------|--------------|--|
| L REV ISLN VAL R REV ISLN VAL | Advisory | REV ISLN | | Fault is detected in the affected engine reverser system |

Intentionally
Blank

Fire Protection**Chapter 8****Table of Contents****Section 0**

| | |
|--|-------------|
| Controls and Indicators | 8.10 |
| Engine Fire Protection | 8.10.1 |
| Engine Fire Panel | 8.10.1 |
| Fuel Control Switches | 8.10.2 |
| Fire Warning Light | 8.10.2 |
| Cargo and APU Fire Protection | 8.10.2 |
| Cargo and APU Fire Panel | 8.10.2 |
| Wheel Well Fire Light | 8.10.4 |
| APU Ground Control Fire Protection Panel | 8.10.4 |
| Fire/Overheat Test Panel | 8.10.6 |
| System Description | 8.20 |
| Introduction | 8.20.1 |
| Engine Fire Protection | 8.20.1 |
| Engine Fire and Overheat Detection | 8.20.1 |
| Engine Fire Warning | 8.20.1 |
| Engine Overheat Caution | 8.20.2 |
| Engine Fire Extinguishing | 8.20.2 |
| Engine/APU Fire and Override Switches | 8.20.2 |
| APU Fire Protection | 8.20.3 |
| APU Fire Detection | 8.20.3 |
| APU Fire Warning | 8.20.3 |
| APU Fire Extinguishing | 8.20.3 |
| Main Gear Wheel Well Fire Protection | 8.20.4 |
| Main Gear Wheel Well Fire Detection | 8.20.4 |
| Main Gear Wheel Well Fire Warning | 8.20.4 |
| Cargo Compartment Fire Protection | 8.20.4 |
| Cargo Compartment Smoke Detection | 8.20.4 |
| Cargo Compartment Fire Warning | 8.20.5 |
| Cargo Compartment Fire Extinguishing | 8.20.5 |

| | |
|---|-------------|
| Lavatory Fire Protection | 8.20.5 |
| Lavatory Fire Detection and Annunciation | 8.20.5 |
| Lavatory Fire Extinguishing | 8.20.6 |
| Fire and Overheat Detection System Fault Test | 8.20.6 |
| System EICAS Messages | 8.30 |
| Fire Protection EICAS Messages | 8.30.1 |

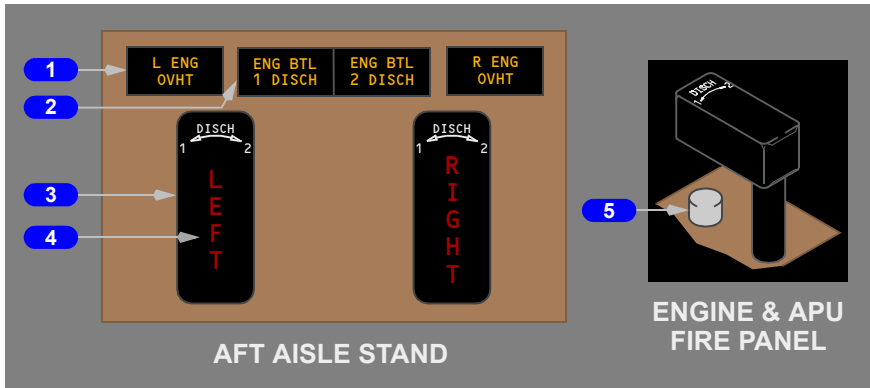
Engine Fire Protection**Engine Fire Panel****1 Engine Overheat (L/R ENG OVHT) Lights**

Illuminated (amber) – engine overheat is detected

2 Engine Bottle Discharged (ENG BTL DISCH) Lights

Illuminated (amber) – the extinguisher bottle is discharged or has low pressure

3 Engine Fire Switches

In – normal position, mechanically locked; unlocks automatically for fire warning

Out – closes the associated engine and spar fuel valves, and

- closes the associated engine bleed air valves
- trips the associated engine generator off
- shuts off hydraulic fluid to the associated engine-driven hydraulic pump
- arms both engine fire extinguisher bottles

Rotate to position 1 or 2 – discharges the selected fire extinguisher into the engine nacelle

4 Engine Fire Warning Lights

Illuminated (red) – an engine fire is detected

5 Engine and APU Fire Override Switches

Push – unlocks the respective engine or APU fire switch

Fuel Control Switches

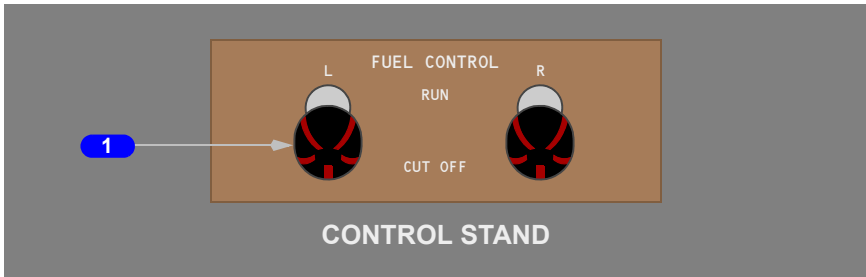

1 FUEL CONTROL Switch Fire Warning Lights

Illuminated (red) – an associated engine fire is detected

Fire Warning Light



1 FIRE Warning Light

Illuminated (red) – an engine, APU, wheel well, or cargo fire is detected

Cargo and APU Fire Protection

Cargo and APU Fire Panel

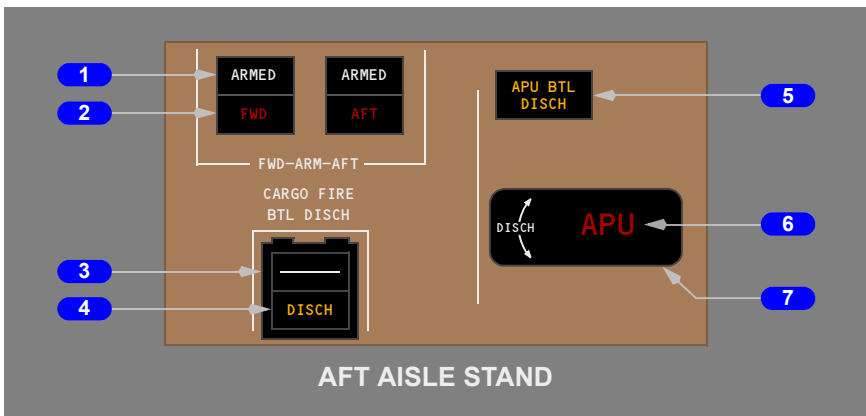

1 CARGO FIRE ARM Switches and Lights

Push FWD ARMED – Light Illuminates

- arms all cargo fire extinguisher bottles
- turns off both recirculation fans

Push AFT ARMED – Light Illuminates

- arms all cargo fire extinguisher bottles
- turns off both the recirculation fans
- inhibits high flow operation of both packs

Off – normal position

2 CARGO FIRE Warning Lights (FWD or AFT)

Illuminated (red) – smoke is detected in associated cargo compartment

3 CARGO FIRE Bottle Discharge (BTL DISCH) Switch

Push – discharges the fire extinguisher bottles into the ARMED cargo compartment

4 CARGO FIRE Bottle Discharged (DISCH) Light

Illuminated (amber) – either extinguisher bottle has discharged or has low pressure

5 APU Fire Bottle Discharged (APU BTL DISCH) Light

Illuminated (amber) – the extinguisher bottle is discharged or has low pressure

6 APU Fire Warning Light

Illuminated (red) – an APU fire is detected

7 APU Fire Switch

In – normal position, mechanically locked; unlocks automatically if fire warning occurs

Out – closes the APU fuel valve, and:

- trips the APU generator off
- closes the APU air supply valve
- shuts down the APU
- arms the APU fire extinguisher bottle

Rotate – either direction discharges the APU fire extinguisher into the APU compartment

Wheel Well Fire Light

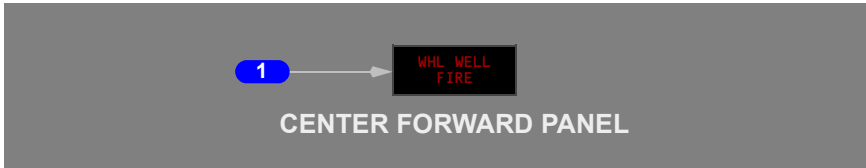

1 Wheel (WHL) WELL FIRE Warning Light

Illuminated (red) – a fire is detected in one or both of the main gear wheel wells

APU Ground Control Fire Protection Panel

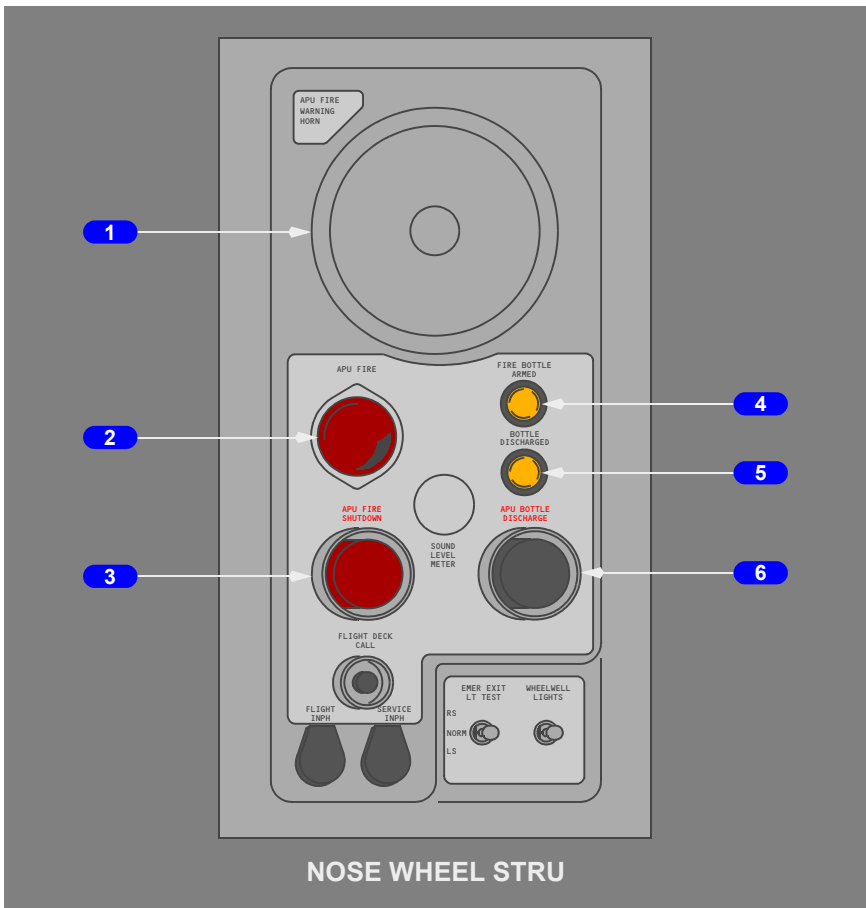

1 APU Fire Warning Horn

Sounds intermittently during ground operation for an APU fire

2 APU FIRE Light

Illuminated (red) – an APU fire is detected

The APU automatically shuts down for a detected fire

3 APU FIRE SHUTDOWN Switch

Push –

- closes the APU fuel valve and trips the APU generator off
- closes the APU air supply valve and shuts down the APU
- arms the APU fire extinguisher bottle

4 APU FIRE BOTTLE ARMED Light

Illuminated (amber) - the APU fire extinguisher is armed

5 APU Fire BOTTLE DISCHARGED Light

Illuminated (amber) - the APU fire extinguisher bottle is discharged or has low pressure

6 APU BOTTLE DISCHARGE Switch

Push – discharges the APU fire extinguisher bottle into the APU compartment

Fire/Overheat Test Panel

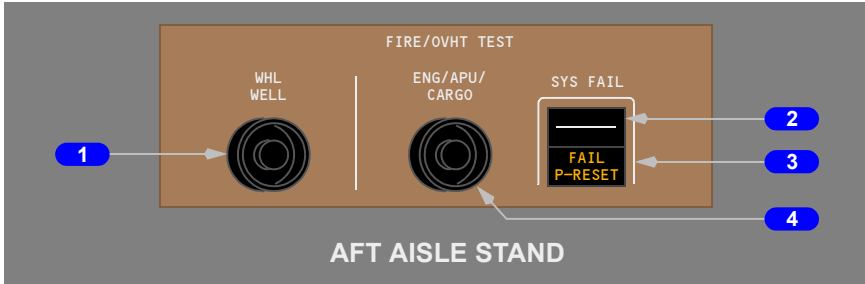

1 Wheel (WHL) WELL Fire Test Switch

Push and hold – initiates a wheel well fire test

2 System Fail (FAIL P – RESET) Light

Illuminated (amber) – indicates the failure of the detectors in one of the following systems:

- engine fire
- engine overheat
- APU fire
- cargo fire

3 System Fail (SYS FAIL) Reset Switch (FAIL P – RESET)

Push – extinguishes the FAIL light and resets the monitor for other systems

4 ENG/APU/CARGO Test Switch

Push and hold – initiates an engine, APU, and cargo fire/overheat test

Introduction

There are fire detection and extinguishing systems for the:

- engines
- APU
- forward and aft cargo compartments
- lavatories

The main gear wheel wells have a fire detection system, but no fire extinguishing system. The system will not detect hot brakes alone, without an associated fire.

Overheat detection systems are installed for both engines, struts, and pneumatic ducts in the wing and body areas.

Refer to Chapter 2, Air Systems, for a description of equipment smoke evacuation, equipment overheat detection and bleed air duct leak.

Engine Fire Protection

Engine fire protection consists of these systems:

- engine fire and overheat detection
- engine fire warning
- engine overheat caution
- engine fire extinguishing

Engine Fire and Overheat Detection

There are detector loops in each engine nacelle to provide both fire and overheat detection. The SYS FAIL light illuminates and the EICAS advisory message FIRE/OVHT SYS displays to indicate failure of the fire/overheat detection system. The SYS FAIL light and advisory message can be reset to allow monitoring of the remaining systems.

Engine Fire Warning

The indications of an engine fire warning are:

- the fire bell sounds
- the master WARNING lights illuminate
- the engine fire switch LEFT or RIGHT fire warning light illuminates
- the discrete FIRE warning light illuminates
- the engine FUEL CONTROL switch fire warning light illuminates
- the EICAS warning message L or R ENGINE FIRE displays
- the engine fire switch unlocks

The fire warning lights remain illuminated as long as the fire signal exists. The fire bell may be silenced by any of the following actions:

- extinguishing the fire
- pushing either master warning/caution reset switch
- pulling the appropriate fire switch

Engine Overheat Caution

The indications of an engine overheat caution are:

- the caution beeper sounds
- the master CAUTION lights illuminate
- the L or R ENG OVHT light illuminates
- the EICAS caution message L or R ENG OVHT displays

The overheat lights remain illuminated as long as the overheat condition exists.

Engine Fire Extinguishing

There are two engine fire extinguisher bottles. Either or both bottles can be discharged into either engine.

When an engine fire switch is pulled out, the associated engine:

- fuel is shut off
- bleed valves are closed
- generator is tripped off
- hydraulic fluid is shut off to the engine-driven hydraulic pump
- fire extinguishing bottles are armed

Rotating the fire switch in either direction discharges a single extinguisher bottle into the associated engine. Rotating the engine fire switch in the other direction discharges the second extinguisher bottle into the same engine.

If an extinguisher bottle is discharged or has low pressure:

- the ENG BTL 1 or 2 DISCH light illuminates
- the EICAS advisory message ENG BTL 1 or 2 displays

Engine/APU Fire and Override Switches

The engine and APU fire switches are mechanically locked in the down position to avoid inadvertent activation. When a fire is detected, the respective switch is electrically unlocked and may then be pulled out. Manual unlocking of the switch is accomplished by pushing the fire override switch located beneath the fire switch.

APU Fire Protection

APU fire protection consists of these systems:

- APU fire detection
- APU fire warning
- APU fire extinguishing

APU Fire Detection

There are fire detector loops in the APU compartment. There is no APU overheat detection. The SYS FAIL light illuminates and the EICAS advisory message FIRE/OVHT SYS displays to indicate failure of the APU fire detection system. The SYS FAIL light and advisory message can be reset to allow monitoring of the remaining systems.

APU Fire Warning

The indications of an APU fire warning are:

- the fire bell sounds
- the master WARNING lights illuminate
- the APU fire warning light illuminates
- the discrete FIRE warning light illuminates
- the EICAS warning message APU FIRE displays
- the APU automatically shuts down
- the APU fire switch unlocks

In addition to the above APU fire warnings, if the airplane is on the ground the horn on the nose gear strut sounds and the fire warning light on the APU ground control panel illuminates.

The fire warning lights remain illuminated as long as the fire signal exists. The fire bell (and horn if APU fire on the ground) may be silenced by any of the following actions:

- extinguishing the fire
- pushing either master warning/caution reset switch
- pulling the APU fire switch
- pushing the APU fire shutdown switch if on the ground

APU Fire Extinguishing

Option - One APU Fire Extinguishing Bottle

There is one APU fire extinguisher bottle. When the APU fire switch is pulled out, the APU:

- fuel is shut off
- bleed air valve is closed

- generator is tripped off
- fire extinguishing bottle is armed

Rotating the switch in either direction discharges the extinguisher bottle into the APU compartment. When the bottle is discharged or has low pressure:

- the APU BTL DISCH light illuminates
 - the EICAS advisory message APU BTL displays
-

Main Gear Wheel Well Fire Protection

The main gear wheel well has fire detection and warning only. There is no fire extinguishing system. The nose gear wheel well does not have a fire detection system.

Main Gear Wheel Well Fire Detection

The main wheel well fire detection system consists of a single fire detection loop.

Main Gear Wheel Well Fire Warning

The indications for a main wheel well fire are:

- the fire bell sounds
- the master WARNING lights illuminate
- the WHL WELL FIRE warning light illuminates
- the discrete FIRE warning light illuminates
- the EICAS warning message WHEEL WELL FIRE displays

The fire warning lights remain illuminated as long as the fire signal exists. The fire bell may be silenced by any of the following actions:

- extinguishing the fire
 - pushing either master warning/caution reset switch
-

Cargo Compartment Fire Protection

Cargo compartment fire protection consists of these systems:

- cargo compartment smoke detection
- cargo compartment fire warning
- cargo compartment fire extinguishing

Cargo Compartment Smoke Detection

The forward and aft cargo compartments each have smoke detectors installed

The SYS FAIL light illuminates and the EICAS advisory message FIRE/OVHT SYS displays to indicate failure of the cargo compartment smoke detection system. The SYS FAIL light can be reset to allow monitoring of the remaining systems.

Cargo Compartment Fire Warning

The indications of a cargo compartment fire are:

- the fire bell sounds
- the master WARNING lights illuminate
- the FWD or AFT cargo fire warning light illuminates
- the discrete FIRE warning light illuminates
- the EICAS warning message FWD or AFT CARGO FIRE displays

The fire warning lights remain illuminated as long as the fire signal exists. The fire bell may be silenced by any of the following actions:

- extinguishing the fire and clearing the smoke
- pushing either master warning/caution reset switch
- pushing the illuminated cargo compartment ARMED switch

Cargo Compartment Fire Extinguishing

Fire extinguisher bottles are installed for cargo compartment fire extinguishing. Pushing the FWD or AFT cargo compartment ARMED switch arms the extinguishers for that compartment.

Pushing the cargo fire bottle discharge switch initiates discharge of the fire bottles. The first bottle discharges immediately into the selected compartment. The CARGO BTL 1 advisory message is displayed on EICAS within a few seconds after pressing the cargo fire bottle DISCH switch. The second fire bottle discharges at a later time or at a reduced flow rate into the selected compartment. The CARGO BTL 2 advisory messages is displayed on EICAS within a few seconds after the bottle starts to discharge. The DISCH light illuminates when either bottle discharges.

Lavatory Fire Protection

Lavatory fire protection consists of these systems:

- lavatory fire detection and annunciation
- automatic fire extinguishing in the lavatory waste container cabinet

Lavatory Fire Detection and Annunciation

Each lavatory has a single smoke detector. When smoke is detected, aural annunciations sound in the lavatory and in the cabin. Depending on configuration, cabin lavatory smoke detection annunciation will consist of a horn, a chime, a flashing lavatory call light or illumination of the master call light at the associated flight attendant station.

There is no cockpit annunciation of smoke detected in a lavatory.

Lavatory Fire Extinguishing

Each lavatory has a fire extinguisher located in the waste container cabinet, with:

- automatic fire extinguisher operation
 - no cockpit annunciations of lavatory fire extinguisher operations
-

Fire and Overheat Detection System Fault Test

Automatic testing of the engine fire and overheat detectors, APU fire detectors and cargo compartment smoke detectors occurs when electrical power is initially applied. The FIRE/OVHT test panel permits manual testing of the various fire and overheat sensors.

Fire Protection EICAS Messages

The following EICAS messages can be displayed.

| Message | Level | Light | Aural | Condition |
|----------------------------------|----------|--|--------------|---|
| APU BTL | Advisory | APU BTL DISCH | | APU fire extinguisher bottle pressure is low |
| APU FIRE | Warning | APU | Fire Bell | Fire is detected in the APU |
| CARGO BTL 1 CARGO BTL 2 | Advisory | DISCH | | Cargo fire extinguisher bottle 1 or bottle 2 pressure is low |
| AFT CARGO FIRE FWD CARGO FIRE | Warning | AFT FWD | Fire Bell | Smoke is detected in the affected cargo compartment |
| ENG BTL 1 ENG BTL 2 | Advisory | ENG BTL 1 DISCH ENG BTL 2 DISCH | | Engine fire extinguisher bottle 1 or bottle 2 pressure is low |
| L ENGINE FIRE R ENGINE FIRE | Warning | LEFT RIGHT | Fire Bell | Fire is detected in the engine |
| L ENG OVHT R ENG OVHT | Caution | L ENG OVHT R ENG OVHT | Beeper | An overheat is detected in the engine |
| FIRE/OVHT SYS | Advisory | FAIL P-RESET | | Fire or overheat detection is inoperative for loops as shown on the status page |
| WHEEL WELL FIRE | Warning | WHL WELL FIRE | Fire Bell | Fire is detected in a main wheel well |

Intentionally
Blank

Flight Controls**Chapter 9****Table of Contents****Section 0**

| | |
|--|-------------|
| Controls and Indicators | 9.10 |
| Pitch and Stabilizer Trim System | 9.10.1 |
| Control Wheel and Column | 9.10.1 |
| Stabilizer Trim System | 9.10.2 |
| Stabilizer Trim Lights | 9.10.3 |
| Aileron and Rudder Trim Controls | 9.10.3 |
| Aileron Trim Indicator | 9.10.3 |
| Aileron and Rudder Trim | 9.10.4 |
| Rudder System | 9.10.4 |
| Rudder/Brake Pedals | 9.10.4 |
| EICAS Status Display | 9.10.5 |
| Yaw Damper Switches | 9.10.5 |
| Rudder System Light | 9.10.6 |
| Flight Control Shutoff Switches | 9.10.6 |
| Speedbrakes | 9.10.7 |
| Speedbrake Lever | 9.10.7 |
| Speedbrake and Aileron Lights | 9.10.7 |
| Flap System | 9.10.8 |
| Flap Controls | 9.10.8 |
| Flap Position Indicator/Alternate Flaps Selector | 9.10.10 |
| System Description | 9.20 |
| Introduction | 9.20.1 |
| Pilot Controls | 9.20.1 |
| Flight Control Surfaces | 9.20.2 |
| Flight Control Surface Locations | 9.20.2 |
| Pitch Control | 9.20.2 |
| Elevator | 9.20.2 |
| Actuator Control Hydraulic Power Distribution | 9.20.4 |
| Stabilizer Trim Control | 9.20.5 |
| Electric Trim | 9.20.5 |

| | |
|--|-------------|
| Alternate Trim | 9.20.5 |
| Automatic Trim | 9.20.5 |
| Non-normal Operation | 9.20.5 |
| Pitch Enhancement System (PES) | 9.20.6 |
| Roll Control | 9.20.6 |
| Ailerons | 9.20.6 |
| Yaw Control | 9.20.7 |
| Rudder | 9.20.7 |
| Rudder Ratio | 9.20.7 |
| Yaw Damping | 9.20.8 |
| Spoilers | 9.20.8 |
| Spoiler Speedbrake Operation | 9.20.8 |
| Flaps and Slats | 9.20.9 |
| Flap and Slat Sequencing | 9.20.9 |
| Flap Load Relief | 9.20.10 |
| Flap/Slat Non-Normal Operation | 9.20.10 |
| Alternate Flap Operation | 9.20.10 |
| Leading Edge Disagreement | 9.20.10 |
| Leading Edge Asymmetry | 9.20.11 |
| Trailing Edge Disagreement | 9.20.11 |
| Trailing Edge Asymmetry | 9.20.11 |
| Load Relief Inoperative | 9.20.11 |
| Hydraulic Driven Generator | 9.20.11 |
| EICAS Messages | 9.30 |
| Flight Controls EICAS Messages | 9.30.1 |

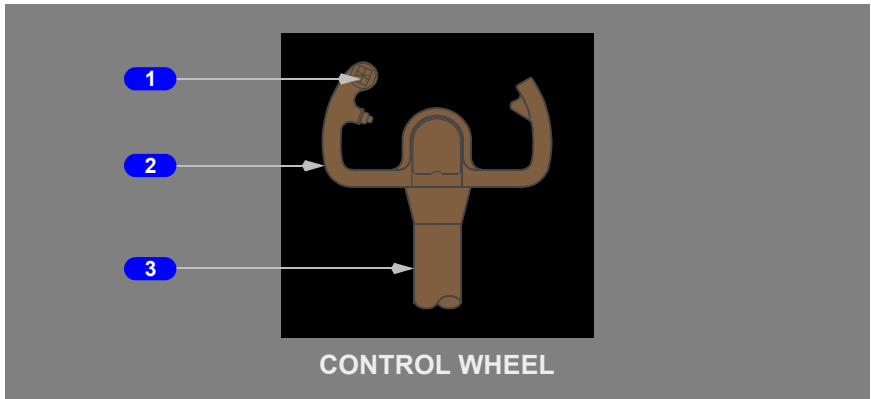
Pitch and Stabilizer Trim System**Control Wheel and Column****1 Pitch Trim Switches**

Spring-loaded to neutral.

Push (both switches) – electrically signals stabilizer movement.

2 Control Wheel

Rotate – deflects the ailerons and spoilers in the desired direction.

Moves and remains displaced with aileron trim.

3 Control Column

Push/Pull –

- deflects the elevator
- movement opposing stabilizer trim stops trimming

Stabilizer Trim System

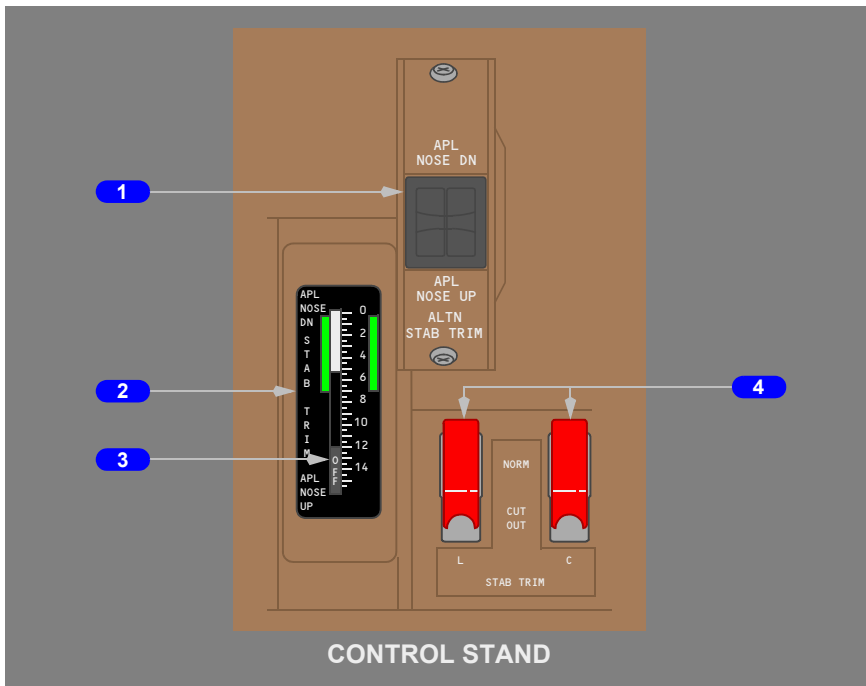

1 Alternate Stabilizer Trim (ALTN STAB TRIM) Switches

Spring-loaded to neutral.

Push (both switches) –

- electrically signals stabilizer movement
- neutralizes conflicting trim commands

2 Stabilizer Trim (STAB TRIM) Indicator

- indicates stabilizer position in units of trim
- the green bands indicate the allowable takeoff trim range

3 Stabilizer Trim OFF Flag

Trim indicator inoperative.

4 Stabilizer (STAB) Cutout Switches

NORM – hydraulic power is supplied to the related stabilizer trim control module.

CUTOUT – shuts off the respective left or center hydraulic system power to the related stabilizer trim control module.

Stabilizer Trim Lights

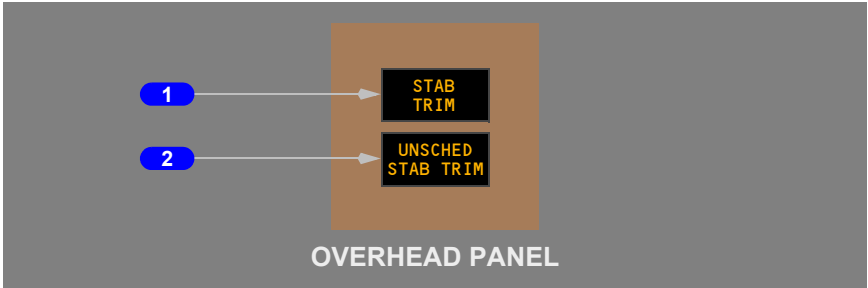

1 Stabilizer Trim (STAB TRIM) Light

Illuminated (amber) – stabilizer trim rate is one-half the normal control wheel stabilizer trim switch rate.

2 Unscheduled Stabilizer Trim (UNSCHEDED STAB TRIM) Light

Illuminated (amber) – uncommanded stabilizer motion detected.

Aileron and Rudder Trim Controls

Aileron Trim Indicator

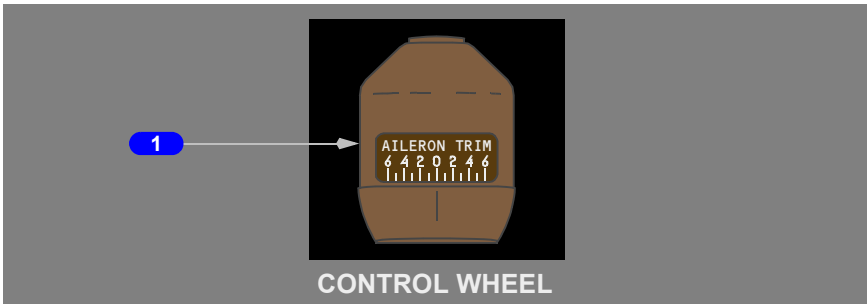

1 AILERON TRIM Indicator

Indicates units of aileron trim.

Aileron and Rudder Trim



1 RUDDER TRIM Indicator

Indicates units of rudder trim.

2 AILERON Trim Switches

Spring-loaded to neutral.

Push (both switches) – moves the control wheel, ailerons, and spoilers in the desired direction.

3 RUDDER Trim Control

Spring-loaded to neutral.

Rotate – moves the rudder pedals and rudder in the desired direction.

Rudder System

Rudder/Brake Pedals

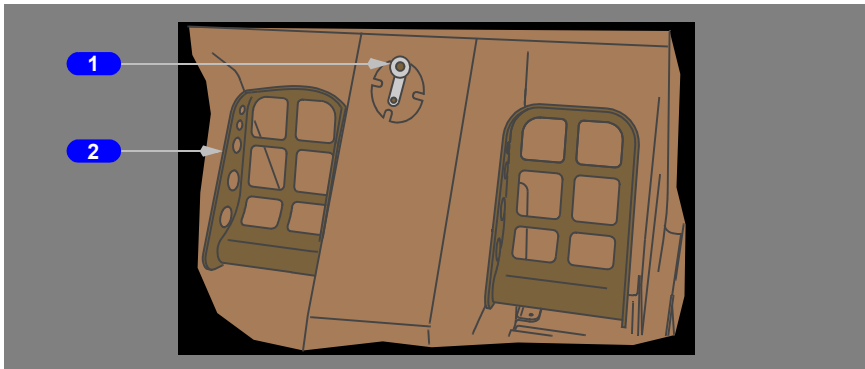

1 Rudder Pedals Adjustment Crank

Pull and Rotate – adjusts rudder pedals forward or aft.

2 Rudder Pedals

Push – deflects the rudder in the desired direction.

Refer to Chapter 14, Landing Gear, for brakes and nosewheel steering description.

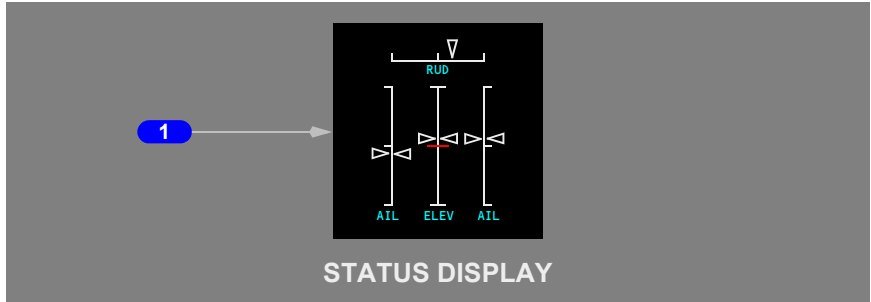
EICAS Status Display**1 Rudder, Aileron, and Elevator (RUD, AIL, ELEV) Position**

Indicates rudder, aileron, and elevator flight control surface deflection.

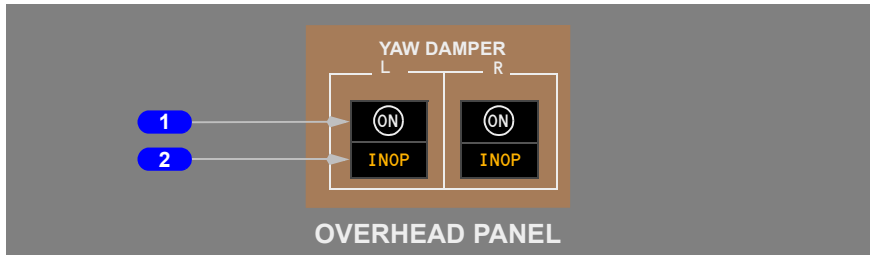
Yaw Damper Switches**1 YAW DAMPER Switches**

ON – yaw damper is commanded on.

Off (ON not visible) – the yaw damper is commanded off.

2 Yaw Damper Inoperative (INOP) Lights

Illuminated (amber) – the yaw damper is off or inoperative.

Rudder System Light

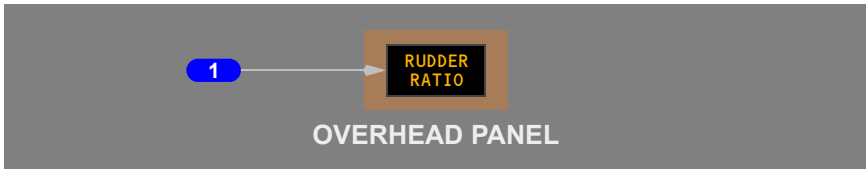

1 RUDDER RATIO Light

Illuminated (amber) – the rudder ratio system is failed.

Flight Control Shutoff Switches

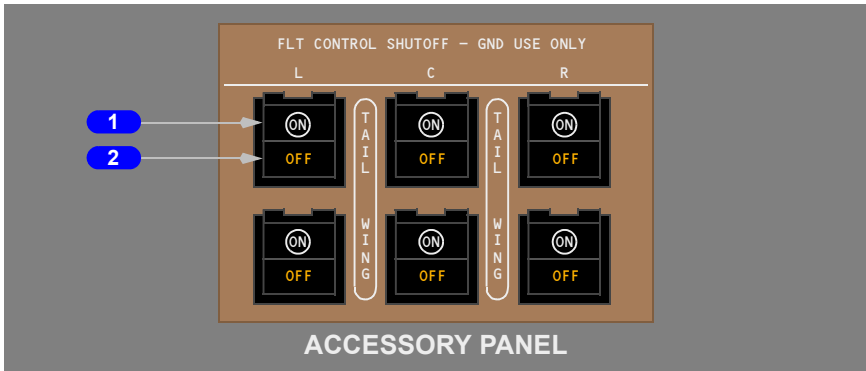

1 Flight (FLT) CONTROL SHUTOFF Switches

ON – the flight control valve is commanded open.

Off (ON not visible) – the flight control valve is commanded closed.

2 Flight Control Shutoff OFF Lights

Illuminated (amber) – the flight control valve is closed.

Speedbrakes

Speedbrake Lever

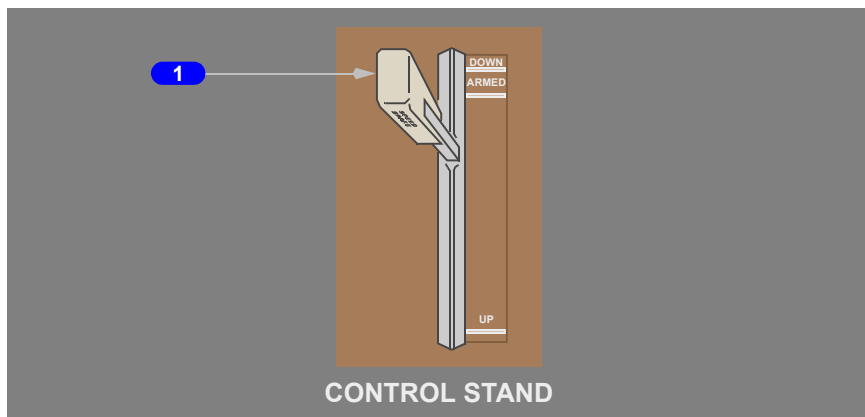

1 SPEEDBRAKE LEVER

DOWN (detent) – all spoiler panels are retracted.

ARMED –

- the auto speedbrake system is armed
- after landing, the speedbrake lever automatically moves to UP and the spoiler panels extend

UP – the required spoiler panels extend to their maximum in-flight or on-ground positions (intermediate positions can be selected).

On the ground:

- speedbrake lever moves to DOWN and all spoiler panels retract if either thrust lever is advanced to the takeoff thrust position
- the speedbrake lever moves to UP and all spoiler panels extend if either reverse thrust lever is raised to the reverse idle detent

Speedbrake and Aileron Lights

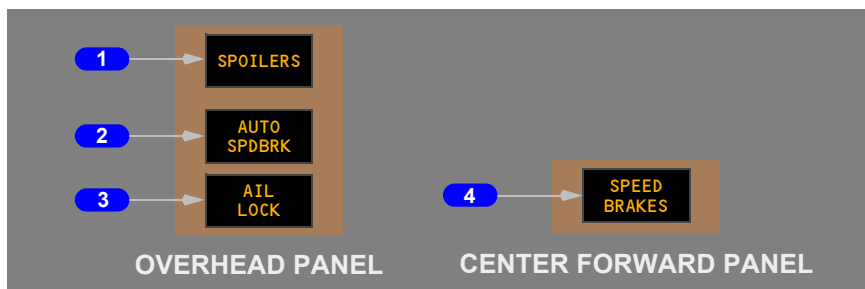

1 SPOILERS Light

Illuminated (amber) – one or more spoiler pairs are inoperative.

2 Auto Speedbrake (AUTO SPDBRK) Light

Illuminated (amber) – a fault is detected in the automatic speedbrake system.

3 Aileron Lockout (AIL LOCK) Light

Illuminated (amber) – aileron lockout actuator disagrees with the commanded position.

4 SPEED BRAKES Light

Illuminated (amber) – the speedbrakes are extended when:

- radio altitude is 800 feet or below, or
- flaps are in a landing position

Flap System

Flap Controls

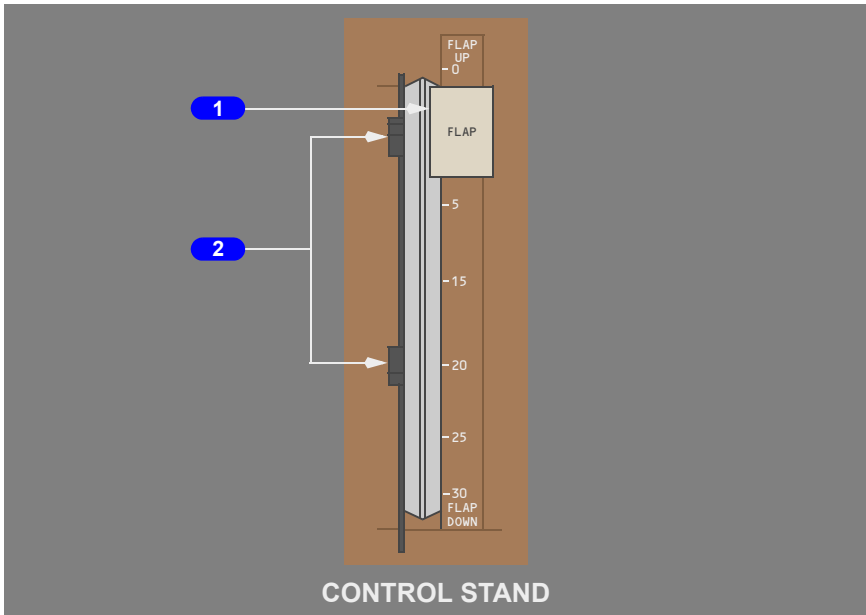

1 FLAP Lever

Positions the slats and flaps hydraulically.

Up – the slats and flaps are retracted.

1 –

- the slats extend to the midrange position
- the flaps remain retracted

5, 15, and 20 –

- the slats remain in the midrange position
- the flaps extend to the commanded position
- the inboard ailerons droop in conjunction with flap extension
- the flap load relief system arms at flaps 20

25 –

- the slats extend to the fully extended position
- the flaps extend to 25

30 –

- the slats remain in the fully extended position
- the flaps extend to 30

2 Flap Gates

1 – prevents inadvertent retraction of the slats.

20 – prevents inadvertent retraction of the flaps past the go-around position.

Flap Position Indicator/Alternate Flaps Selector

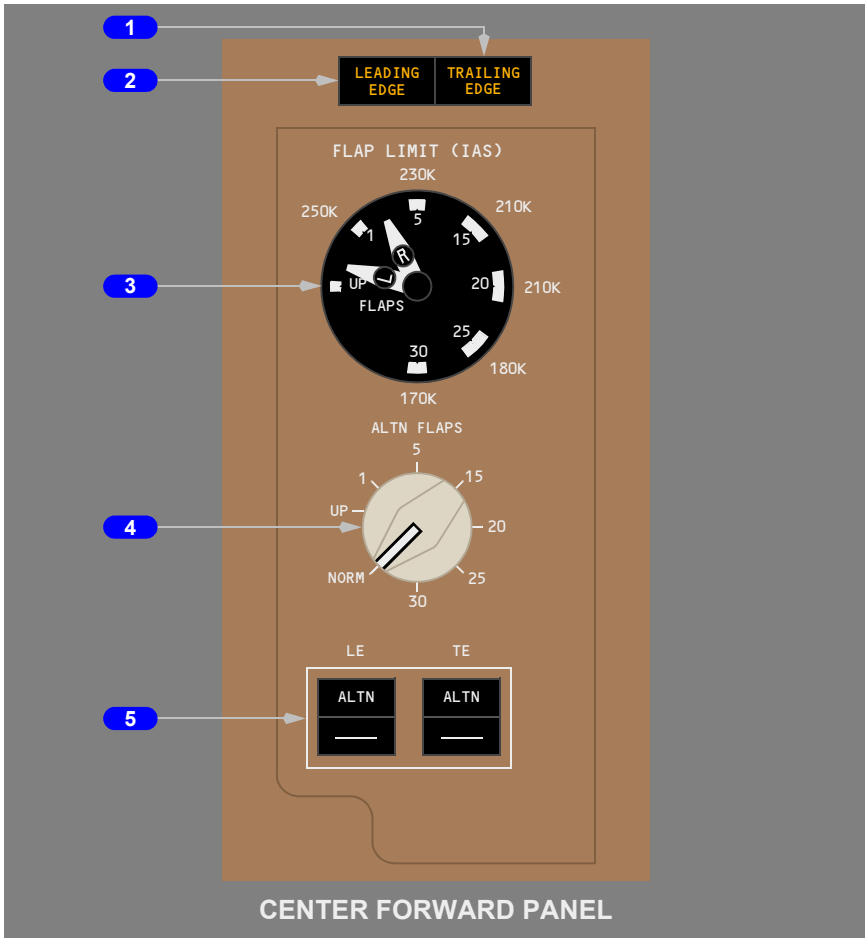

1 TRAILING EDGE Light

Illuminated (amber) –

- a flap disagree exists
- a flap asymmetry exists
- the flap load relief system is not operating when required

2 LEADING EDGE Light

Illuminated (amber) –

- a slat disagree exists
- a slat asymmetry exists

3 Flap Position Indicator

Indicates flap position.

UP – the slats and flaps are retracted.

Between UP and 1 – the slats are between the retracted and midrange position.

1 to 30 – the flaps are in the indicated position.

4 Alternate (ALTN FLAPS) Flaps Selector

NORM – normal flap operation, alternate system not in use.

UP – the slats and flaps are retracted.

1 –

- the slats extend to the midrange position
- the flaps remain retracted

5 to 20 –

- the slats remain in the midrange position
- the flaps extend to the commanded position

Alternate flaps switches must be in ALTN for the slats and flaps to move.

5 Alternate (ALTN) Flaps Switches

ALTN –

- arms the selected LE slat or TE flap alternate drive unit
- shuts off hydraulic power to the selected LE slat or TE flap drive system.

Off (ALTN not visible) – alternate flaps and slats command inactive.

Intentionally
Blank

Introduction

The primary flight controls are elevators, ailerons, and rudders. The control column, control wheel, and rudder pedals control these flight control surfaces. The primary flight controls are powered by redundant hydraulic systems; there is no manual reversion.

Secondary flight controls include a moveable horizontal stabilizer, spoilers, and leading and trailing edge flaps. Spoilers operate differentially to assist ailerons for roll control and symmetrically as speedbrakes.

There are six guarded flight control shutoff switches that control hydraulic power to the ailerons, spoilers, elevators and rudder. The flight control shutoff OFF light illuminates and the EICAS advisory message L, C, or R WING HYD VAL or L, C, or R TAIL HYD VAL displays when a flight control valve is closed. If two or more OFF lights illuminate the EICAS advisory message FLT CONT VALS displays.

Pilot Controls

The pilot controls consist of:

- two control columns
- two control wheels
- two pairs of rudder pedals
- control wheel stabilizer trim switches
- the speedbrake lever
- the flap lever
- aileron trim switches
- rudder trim switch
- alternate stabilizer trim switches

The columns and wheels are connected through jam override mechanisms. If a jam occurs in a column or wheel, the pilots can maintain control by applying force to the other column or wheel to overcome the jam. When a restricted portion of the flight controls are bypassed, some control effectiveness may be lost.

The rudder pedals are rigidly connected between the two sides.

The speedbrake lever allows manual or automatic symmetric actuation of the spoilers.

Flight Control Surfaces

Pitch control is provided by:

- two elevators
- a movable horizontal stabilizer

Roll control is provided by:

- four ailerons
- twelve spoilers

Yaw control is provided by a single rudder.

Flaps and slats provide high lift for takeoff, approach, and landing.

Symmetric spoilers are used as speedbrakes.

Flight Control Surface Locations

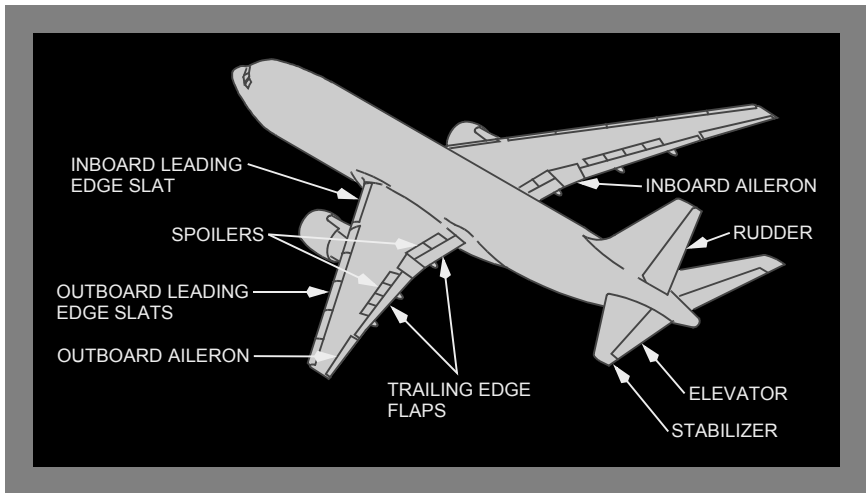

Pitch Control

The pitch control surfaces consist of two elevators and a stabilizer.

Elevator

Moving the control column signals hydraulic actuators to move the elevators.

Elevator positions are shown on the EICAS status display. Separate pointers indicate the left and right elevator deflection. A full-scale indication corresponds to the maximum elevator deflection.

767 Flight Crew Operations Manual

If one control column should jam, applying significant forward or aft force to the other causes the two columns to override. Pitch control is then available using the free control column path.

Two elevator feel systems provide artificial feel forces to the pilots control columns. Mechanical springs provide feel following a loss of the left and center hydraulic systems.

Actuator Control Hydraulic Power Distribution

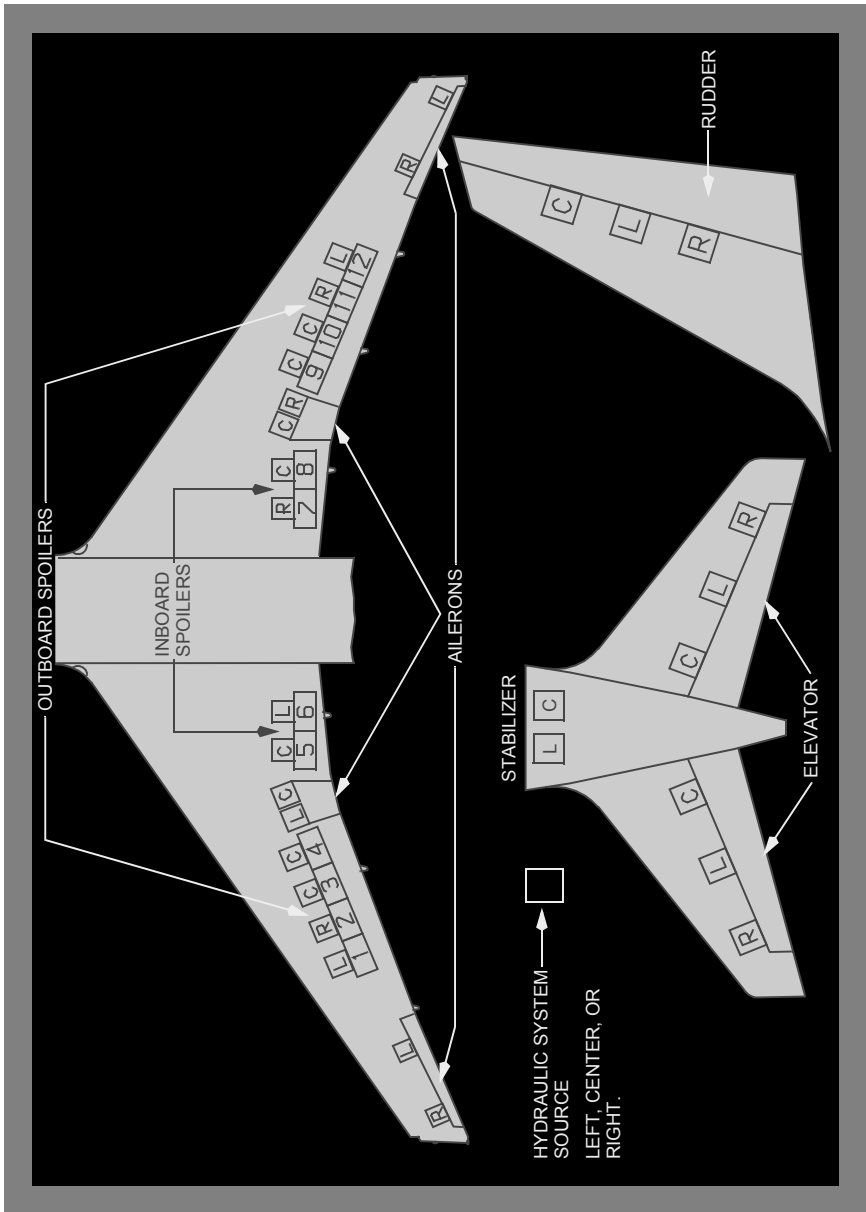

Stabilizer Trim Control

The stabilizer is powered by the left and center hydraulic systems. Stabilizer position commands are sent to the stabilizer trim control modules, which control hydraulic power to the stabilizer. There are two modules, one for each stabilizer hydraulic source.

Stabilizer position is displayed on two stabilizer position indicators located on the control stand. Green bands indicate the normal trim settings for takeoff.

There are three modes of stabilizer trim control:

- electric
- alternate
- automatic

Electric Trim

Dual electric pitch trim switches located on the control wheel must be pushed simultaneously to command trim changes.

To set Stabilizer Trim less than 1.5 units with flaps up, requires use of Alternate Trim system.

Alternate Trim

Alternate trim control is provided by the alternate stabilizer trim switches on the control stand. Pushing both switches simultaneously commands trim changes and provides an increased range of stabilizer travel. The signals neutralize any other conflicting trim inputs.

Automatic Trim

The stabilizer is controlled automatically by the autopilot.

Automatic stabilizer trim uses only one trim control module and trims at one-half the electric or alternate trim rate.

Non-normal Operation

If a single autopilot is engaged, electric trimming causes the autopilot to disengage. If multiple autopilots are engaged, the electric trim switches are inhibited. Alternate trimming does not cause autopilot disengagement.

The UNSCHED STAB TRIM light illuminates and the EICAS caution message UNSCHD STAB TRIM displays when uncommanded stabilizer motion is detected.

The light and message also occur if alternate trim is used with an autopilot engaged.

The left and center stabilizer cutout switches control hydraulic power to the respective stabilizer trim control module. Placing both switches in the CUTOUT position removes all hydraulic power from the stabilizer.

The control column can be used to interrupt stabilizer trim commands. This feature allows the pilot to quickly stop uncommanded trim changes. The stabilizer trim commands are interrupted if the control column is displaced in the opposing direction.

The STAB TRIM light illuminates and the EICAS advisory message STAB TRIM displays when the electric or alternate stabilizer trim rate is one-half the normal control wheel stabilizer trim switch rate.

If the malfunction is unique to the electric trim control, full trim rate is available by using alternate trim.

Pitch Enhancement System (PES)

The Pitch Enhancement System (PES) consists of a hydraulic motor in the right system driving a pump which uses trapped left trim system fluid to operate the stabilizer. It will automatically activate if both the left and center hydraulic systems are lost in flight. Only electric trim is available at approximately 1/4 the normal rate. Alternate and automatic trim will be inoperative.

Roll Control

Two ailerons are located on each wing on either side of the outboard trailing edge flap. Aileron surface deflections are proportional to control wheel displacement. Spoilers begin to extend to augment roll control after several degrees of control wheel rotation. Control wheel forces increase as control displacement increases.

The control wheels are connected so that, if one control wheel jams, using significant force causes the control wheels to override. Roll control is then available using the free control wheel.

The inboard ailerons droop in conjunction with trailing edge flap extension.

Ailerons

Aileron positions are shown on the EICAS status display. A full-scale indication corresponds to maximum aileron deflection.

Dual aileron trim switches located on the aft aisle stand must be pushed simultaneously to command trim changes. Hydraulic power from one of the three hydraulic systems is necessary to accurately set aileron trim.

The amount of aileron trim is indicated on a scale on the top of each control column.

Note: If the flight crew inadvertently activates aileron trim while an autopilot is engaged, the repositioning of the aileron neutral point is not apparent to the crew. When the autopilot is disengaged, the control wheels and ailerons move to the new (possibly undesired) neutral point and the airplane will roll proportional to the amount of trim input.

The aileron lockout control system permits full travel of the outboard ailerons at low speeds and locks out the outboard ailerons at high speeds. This provides the required roll authority at low airspeeds and prevents over controlling at high airspeeds.

The AIL LOCK light illuminates and the EICAS advisory message AILERON LOCKOUT displays to indicate aileron lockout actuator disagrees with the commanded position. At high airspeeds it may indicate that one or both of the outboard ailerons failed to lockout. When the message and light appear at low airspeeds it may indicate that one or both of the outboard ailerons failed to unlock.

Yaw Control

Yaw control is provided by a single rudder. Two yaw dampers operate through the rudder control system to improve directional stability.

Rudder

Rudder position is shown on the EICAS status display. On the ground, a full scale indication corresponds to the maximum rudder deflection.

The rudder trim control can be used to command trim changes. The rudder trim indicator shows the units of rudder trim that are commanded.

Rudder Ratio

The control commands from the rudder pedals and trim control are modified by a rudder ratio changer. As airspeed increases the ratio changer desensitizes these inputs from the pilot to reduce the rudder deflection.

The ratio changer receives air data computer airspeed inputs and provides control commands to an actuator powered by the left hydraulic system. The actuator then dampens the pilots inputs to the rudder.

The RUDDER RATIO light illuminates and the EICAS advisory message RUDDER RATIO displays to indicate the rudder ratio system is failed. Rudder structural protection is provided by automatic depressurization of the left hydraulic system actuator which limits rudder displacement at high airspeeds. However, abrupt rudder pedal input should be avoided at high airspeeds. At low airspeeds the two remaining rudder actuators provide sufficient control for full rudder displacement.

If the left hydraulic system is providing normal pressure to the ratio changer, a fault may result in limited displacement of the rudder at all airspeeds. This requires that crosswind and auto land limitations be observed.

Yaw Damping

The yaw damper systems improve turn coordination and dutchroll damping.

The yaw damper INOP light illuminates and the EICAS advisory message L or R YAW DAMPER displays, when a yaw damper is inoperative.

Spoilers

There are six spoiler panels located on the upper wing surface of each wing. Spoilers on opposing wings are symmetrically paired.

Spoiler panels are used as speedbrakes to increase drag and reduce lift, both in flight and on the ground. The spoilers also supplement roll control in response to control wheel commands.

Spoiler Speedbrake Operation

The speedbrakes are controlled by the speedbrake lever located on the control stand. The speedbrake lever has three marked positions:

- DOWN
- ARMED
- UP

The speedbrake lever can be placed in intermediate positions between ARMED and UP.

In the ARMED position, when the landing gear is fully on the ground (not tilted) and the thrust levers are at idle, the speedbrake lever is driven aft to the UP position and the spoiler panels are fully extended.

On the ground when either reverse thrust lever is moved to the reverse idle detent, the speedbrake lever is driven to the up position and the spoiler panels are fully extended. The speedbrake lever does not need to be in the ARMED position.

The SPEEDBRAKES light illuminates if speedbrakes are extended when radio altitude is 800 feet or below or the flaps are in landing position.

The EICAS caution message SPEEDBRAKES EXT displays and the master caution lights and beeper activate when the SPEEDBRAKES light illuminates.

The AUTO SPDBRK light illuminates and the EICAS advisory message AUTO SPEEDBRAKE displays to indicate a fault is detected in the automatic speedbrake system which may result in the loss of automatic speedbrake extension.

If the speedbrake lever is armed, the message and light indicate a fault which may result in an inadvertent speedbrake extension in flight. The speedbrake lever should be returned to the DOWN position. The speedbrakes can still be operated manually.

The SPOILERS light illuminates and the EICAS advisory message SPOILERS displays to indicate that one or more spoiler pairs are inoperative.

Flaps and Slats

The trailing edge flaps and leading edge slats are high lift devices that increase wing lift and decrease stall speed during takeoff, approach, and landing.

Flap and slat positions are indicated by two pointers in the flap position indicator. There are L and R pointers for the left and right wing flaps and slats. The right pointer is normally hidden from view by the left pointer.

In the flaps 1 position, only the slats move. Flaps 5, 15, 20 are takeoff flap positions. Flaps 25 and 30 are landing flap positions. Flaps 20 is used for some non-normal landing conditions.

Flap and Slat Sequencing

When the flap lever is in the UP detent, all flaps and slats are commanded retracted and the flap position indicator points to UP. Moving the flap lever aft allows selection of flap detent positions 1, 5, 15, 20, 25, and 30.

Starting from flaps UP, selection of flaps 1 commands the slats to move to the midrange position. The flaps remain retracted. The position indicator pointers move mid-way between UP and 1 when the slats are in transit. The pointers move to the 1 indication when all slats are in the midrange position.

Selection of the flaps 5, 15, or 20 positions commands the flaps to move to the position selected. The inboard ailerons droop in conjunction with flap extension. The slats remain in the midrange position. The position indicator provides only trailing edge flap position indications for all flap settings greater than 1.

Selection of flaps 25 commands both the flaps and slats to move to landing positions.

Selection of flaps 30 commands the flaps to extend to the primary landing position.

During retraction flap and slat sequencing is reversed.

The flap gate at the flaps 20 detent prevents inadvertent retraction of the flaps past the go-around position. The flap gate at flaps 1 prevents inadvertent retraction of the slats.

Flap Load Relief

The flap load relief system protects the flaps from excessive airloads.

If the flap airspeed placard limit is exceeded with the flaps in the 25 or 30 position, the flaps automatically retract to position 20.

When airspeed is reduced, the flaps automatically re-extend.

Flap/Slat Non-Normal Operation

Alternate Flap Operation

The alternate mode allows direct manual operation of either the flaps and/or slats through electric motors. The alternate flaps switches:

- allow independent selection of either flaps or slats
- disable normal control
- arm the alternate mode
- engage the electric motors
- the flap lever no longer controls the selected flaps and/or slats

The alternate flaps selector extends and retracts the flaps and slats. Alternate mode flap and slat extension is limited procedurally to flaps 20. Flap load relief is not available in the alternate mode.

Trailing edge flap asymmetry protection is not available in the alternate mode.

Slat and flap operation time in the alternate mode is greatly increased.

Leading Edge Disagreement

The LEADING EDGE light illuminates and the EICAS caution message LE SLAT DISAGREE displays when the leading edge slat positions disagree with commanded position.

The disagree indicates that the slats are not driving toward their new commanded position.

A LE SLAT DISAGREE may also occur if the flap lever is not in a detent for an extended period of time. In this case, the light and message can be removed by moving the flap lever to the desired detent.

Leading Edge Asymmetry

The LEADING EDGE light illuminates and the EICAS caution message LE SLAT ASYM displays when the leading edge slats are not symmetrically extended. Hydraulic power to the slats is automatically shut off.

Trailing edge flaps extension is inhibited until the slats extend to position 1. Therefore, if a slat asymmetry occurs between the UP and 1 positions, the flap indicator may not move until flaps 5 or greater is selected.

Trailing Edge Disagreement

The TRAILING EDGE light illuminates and the EICAS caution message TE FLAP DISAGREE displays when the trailing edge flap positions disagree with commanded position.

The disagree indicates that the flaps are not driving toward their new commanded position.

A TE FLAP DISAGREE may also occur if the flap lever is not in a detent for an extended period of time. In this case, the light and message can be removed by moving the flap lever to the desired detent.

Trailing Edge Asymmetry

The TRAILING EDGE light illuminates and the EICAS caution message TE FLAP ASYM displays when the trailing edge flaps are not symmetrically extended. Hydraulic power to the flaps is automatically shut off.

Load Relief Inoperative

The TRAILING EDGE light illuminates and the EICAS advisory message FLAP LD RELIEF is displayed when the flap load relief system fails to operate when required.

Hydraulic Driven Generator

When the hydraulic driven generator is supplying electrical power, hydraulic flow to the slats and flaps is reduced, resulting in increased slat and flap operating time.

Intentionally
Blank

Flight Controls EICAS Messages

The following EICAS messages can be displayed.

| Message | Level | Light | Aural | Condition |
|------------------|----------|---------------|--------|---|
| AILERON LOCKOUT | Advisory | AIL LOCK | | An aileron lockout actuator disagrees with the commanded position. |
| AUTO SPEEDBRAKE | Advisory | AUTO SPDBRK | | A fault is detected in the automatic speedbrake system. |
| FLAP LD RELIEF | Advisory | TRAILING EDGE | | The flap load relief system fails to operate when required. |
| FLT CONT VALS | Advisory | OFF | | Two or more flight control valves are closed. |
| LE SLAT ASYM | Caution | LEADING EDGE | Beeper | The leading edge slats are not symmetrically extended. |
| LE SLAT DISAGREE | Caution | LEADING EDGE | Beeper | The leading edge slat positions disagree with the commanded position. |
| RUDDER RATIO | Advisory | RUDDER RATIO | | The rudder ratio system is failed. |
| SPEEDBRAKES EXT | Caution | SPEED BRAKES | Beeper | The speedbrakes are extended when the flaps are in a landing position, or when radio altitude is 800 feet or below. |
| SPOILERS | Advisory | SPOILERS | | One or more spoiler pairs are inoperative. |
| STAB TRIM | Advisory | STAB TRIM | | The stabilizer trim rate is one-half of the normal control wheel stabilizer trim switch rate. |

| Message | Level | Light | Aural | Condition |
|--|----------|--------------------------|--------|--|
| C TAIL HYD VAL L TAIL HYD VAL R TAIL HYD VAL | Advisory | OFF | | A tail flight control valve is closed. |
| TE FLAP ASYM | Caution | TRAILING EDGE | Beeper | The trailing edge flaps are not symmetrically extended. |
| TE FLAP DISAGREE | Caution | TRAILING EDGE | Beeper | The trailing edge flap positions disagree with the commanded position. |
| UNSCHD STAB TRIM | Caution | UNSCHE D STAB TRIM | Beeper | Uncommanded stabilizer motion is detected. |
| C WING HYD VAL L WING HYD VAL R WING HYD VAL | Advisory | OFF | | A wing flight control valve is closed. |
| L YAW DAMPER R YAW DAMPER | Advisory | INOP | | The yaw damper is inoperative. |

| | |
|--|--------------|
| EFIS Controls and Indicators | 10.10 |
| Attitude Director Indicator (ADI) Display | 10.10.1 |
| ADIs with Flight Mode Annunciations (FMA) on Top | 10.10.1 |
| ADI Speed Tape | 10.10.6 |
| ADI Failure Flags and Annunciations | 10.10.10 |
| Horizontal Situation Indicator (HSI) Display Modes | 10.10.12 |
| MAP Mode | 10.10.12 |
| CTR MAP Mode | 10.10.16 |
| APP Mode | 10.10.20 |
| CTR APP Mode | 10.10.22 |
| VOR Mode | 10.10.24 |
| CTR VOR Mode | 10.10.26 |
| PLAN Mode | 10.10.28 |
| HSI Symbology | 10.10.31 |
| Heading, Track, and Wind | 10.10.31 |
| Radio Navigation | 10.10.33 |
| Map | 10.10.36 |
| Radar | 10.10.39 |
| TCAS | 10.10.42 |
| Look-Ahead Terrain | 10.10.44 |
| Predictive Windshear | 10.10.47 |
| HSI Failure Flags and Annunciations | 10.10.48 |
| Instrument Switching | 10.10.49 |
| Left Instrument Source Selector Panel (Upper) | 10.10.49 |
| Left Instrument Source Selector Panel (Lower) | 10.10.50 |
| Right Instrument Source Selector Panel (Upper) | 10.10.51 |
| Right Instrument Source Selector Panel (Lower) | 10.10.52 |
| EFI/IRS Interface Diagram | 10.10.54 |
| Heading Reference Switch | 10.10.55 |
| EFIS Control Panel | 10.10.56 |

| | |
|---|------------------|
| EFIS System Description | 10.20 |
| Introduction | 10.20.1 |
| EFIS Symbol Generators | 10.20.1 |
| EFIS Control Panels | 10.20.1 |
| Attitude Director Indicator | 10.20.1 |
| Attitude Display | 10.20.2 |
| Mode Annunciations | 10.20.2 |
| Flight Director Commands | 10.20.2 |
| Glide Slope and Localizer Deviation Displays | 10.20.2 |
| Attitude Comparator | 10.20.2 |
| Height Alert | 10.20.2 |
| Radio Altitude and Decision Height | 10.20.2 |
| Pitch Limit Indicator | 10.20.3 |
| Ground Speed Display | 10.20.3 |
| Airspeed Display | 10.20.3 |
| Horizontal Situation Indicator (HSI) | 10.20.3 |
| Display Orientation | 10.20.3 |
| Track | 10.20.4 |
| MAP Mode | 10.20.4 |
| VOR Mode | 10.20.4 |
| APP Mode | 10.20.4 |
| PLAN Mode | 10.20.4 |
| Weather Radar Display | 10.20.4 |
| Terrain Display | 10.20.5 |
| Traffic | 10.20.5 |
| Predictive Windshear | 10.20.5 |
| EFIS Failure Flags and Annunciations | 10.20.5 |
| Light Sensing and Brightness Control | 10.20.6 |
| Conventional Instruments Controls and Indicators | 10.30 |
| Conventional Flight Instruments | 10.30.1 |
| Mach/Airspeed Indicator (Electric) | 10.30.1 |
| Primary Altimeter (Electric) | 10.30.2 |
| Radio Distance Magnetic Indicator | 10.30.3 |

767 Flight Crew Operations Manual

| | |
|--|--------------|
| Vertical Speed Indicator | 10.30.5 |
| Clock | 10.30.5 |
| Standby Flight Instruments | 10.30.7 |
| Standby Attitude Director Indicator (Standby ADI) | 10.30.7 |
| Standby Airspeed Indicator (Pneumatic) | 10.30.9 |
| Standby Altimeter (Pneumatic) | 10.30.9 |
| Standby Magnetic Compass | 10.30.10 |
| Flight Recorder | 10.30.10 |
| Conventional Instruments System Description | 10.40 |
| Introduction | 10.40.1 |
| Primary Flight Instruments | 10.40.1 |
| Mach/Airspeed Indicator | 10.40.1 |
| Primary Altimeter | 10.40.1 |
| Radio Distance Magnetic Indicator (RDMI) | 10.40.1 |
| Vertical Speed Indicator | 10.40.2 |
| Standby Flight Instruments | 10.40.2 |
| Standby Attitude Director Indicator (Standby ADI) | 10.40.2 |
| Standby Airspeed Indicator (Pneumatic) | 10.40.2 |
| Standby Altimeter (Pneumatic) | 10.40.2 |
| Standby Magnetic Compass | 10.40.2 |
| Clock | 10.40.2 |
| Flight Recorder | 10.40.3 |
| Air Data System | 10.40.3 |
| Pitot-Static System Schematic | 10.40.4 |
| Total Air Temperature (TAT) | 10.40.4 |
| True Airspeed/Static Air Temperature (TAS/SAT) | 10.40.5 |
| EICAS Messages | 10.50 |
| Flight Instruments, Displays EICAS Messages | 10.50.1 |

Intentionally
Blank

Attitude Director Indicator (ADI) Display

ADIs with Flight Mode Annunciations (FMA) on Top

Option: Flight Mode Annunciations on top.

Option: Speed tape with rolling digits.

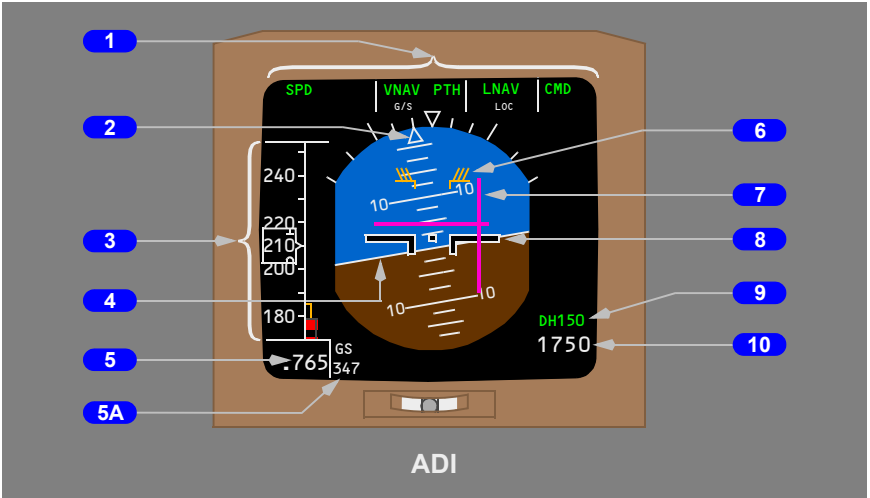

Option: Fast/Slow airspeed indicator.

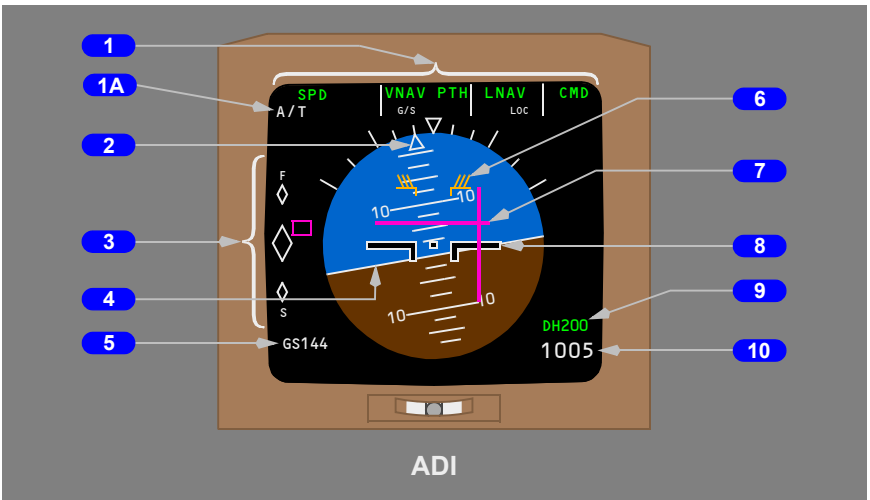

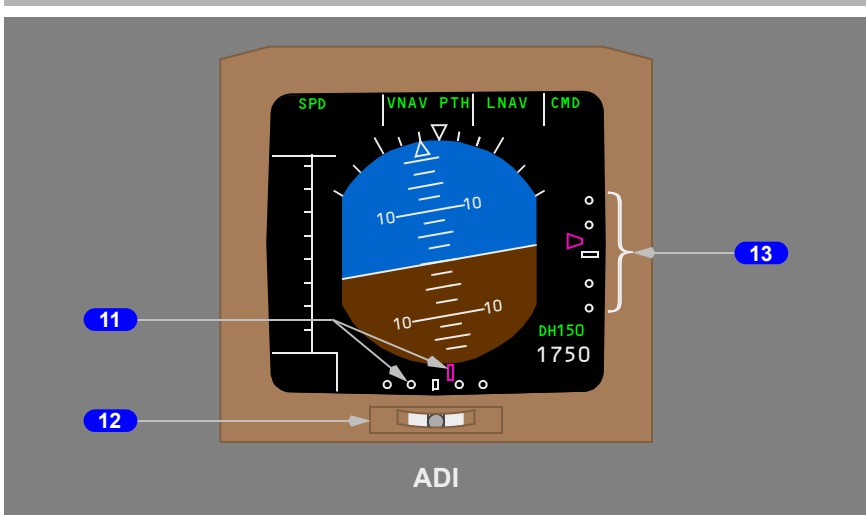

Options: Height alerting at 1,000, 1,500, or 2,500 feet.

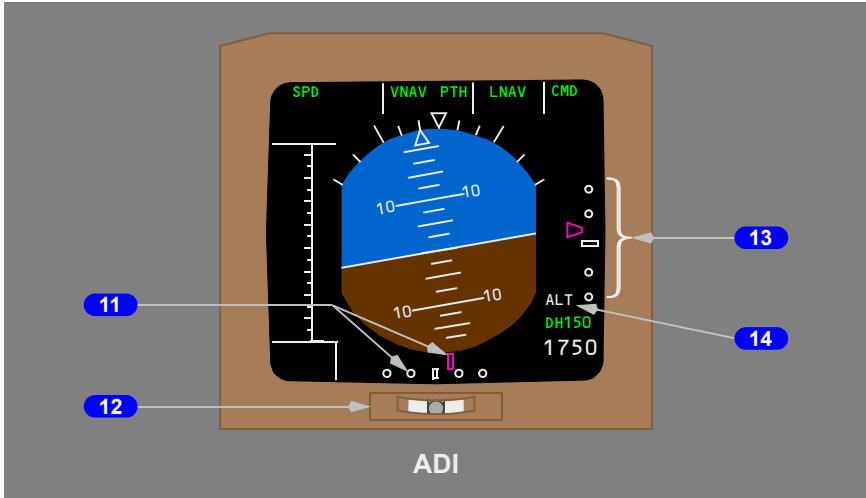

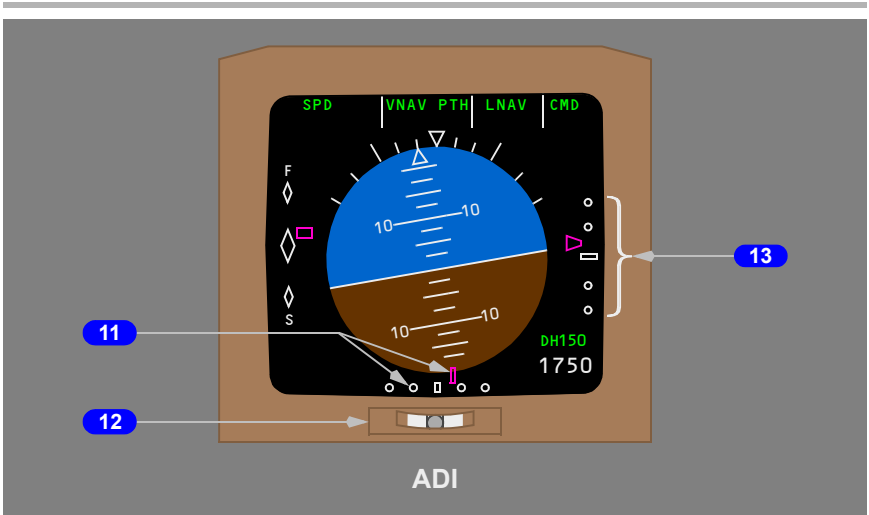

Options: Height alerting at 1,000, 1,500, or 2,500 feet.

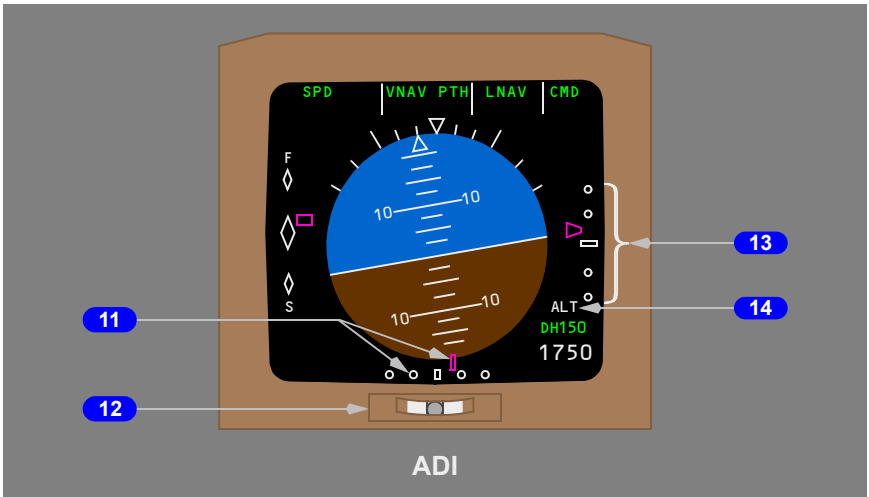

1 Flight Mode Annunciations

Displays Autopilot Flight Director System (AFDS) mode status. Refer to Automatic Flight, Chapter 4, for description.

1A Autothrottle Annunciation

These airplane(s) have A/T annunciated below the thrust mode.

2 Bank Pointer and Scale

Indicates IRS bank in reference to the bank scale.

3 Speed Tape

Displays airspeed information. Refer to "ADI Speed Tape", this section, for description.

3 Fast/Slow Indicator

Option: Fast/Slow airspeed indicator.

Displays airspeed information.

- indicates deviation from the airspeed selected by the FMC or the IAS/MACH selector, or limit speed
- small diamonds indicate 10 knots fast (F), or slow (S).

4 Horizon Line and Pitch Angle Scale

Indicates the IRS horizon relative to the airplane symbol.

Pitch scale is in 2.5 degree increments.

5 Current Mach

Displays current Mach.

- displays when Mach is 0.40 or above
- blanks when Mach is 0.38 or below.

5 Ground Speed

Indicates ground speed in knots.

5A Ground Speed

Indicates ground speed in knots.

6 Pitch Limit Indicator

Indicates pitch limit (stick shaker activation point for the existing flight conditions).

- displays when flaps are not up, or at slow speeds with the flaps up.

7 Flight Director Command Bars

Indicates flight director pitch and roll steering commands.

- displays when the respective F/D switch is ON, valid command steering is available, and the selected flight director and autopilot in (CMD) are not the same
- blanks when the respective FD switch is OFF, or when command steering becomes invalid, or when the selected flight director and autopilot in (CMD) are the same.

8 Airplane Symbol

Indicates airplane attitude with reference to the IRS horizon.

9 Decision Height

Displays selected decision height.

- blanks when negative decision height is selected
- display changes from green to amber, increases in size and “DH” flashes momentarily when airplane descends below decision height (decision height alerting)
- decision height alert is reset automatically – if airplane climbs 75 feet or more above the selected decision height, or after the airplane lands
- decision height alert is reset manually – if the RST switch is pushed.

10 Radio Altitude

Displays radio altitude.

- blank above 2500 feet AGL
- changes color from white to amber when below selected decision height on descent
- changes color from amber back to white when airplane climbs 75 feet or more above the selected decision height, or after the airplane lands
- changes color from amber back to white when the RST switch is pushed.

11 Localizer Pointer and Deviation Scale

The localizer pointer indicates position relative to the airplane.

- scale indicates deviation
- pointer not displayed when localizer is unusable
- scale and pointer not displayed when an ILS frequency is not selected
- a two dot expanded localizer scale (not shown here) displays when LOC is engaged and deviation is slightly more than one half dot on the four dot scale. The expanded scale is more sensitive, with one dot deviation equal to one half dot deviation on the four dot scale

12 Slip Indicator

Indicates coordinated flight.

13 Glide Slope Pointer and Deviation Scale

The glideslope pointer indicates glideslope position relative to the airplane.

- scale indicates deviation
- pointer not displayed when glide slope unusable or when track and the front course on the ILS panel differ by more than 90°
- scale and pointer not displayed when an ILS frequency is not selected

14 Height Alert

Options: Height alerting at 1,000, 1,500, or 2,500 feet.

Indicates airplane has descended through a specified altitude.

- blanks if the RST switch is pushed.
- displays during descent from 2,500 feet to 500 feet AGL

ADI Speed Tape

Option: Speed Tape with rolling digits.

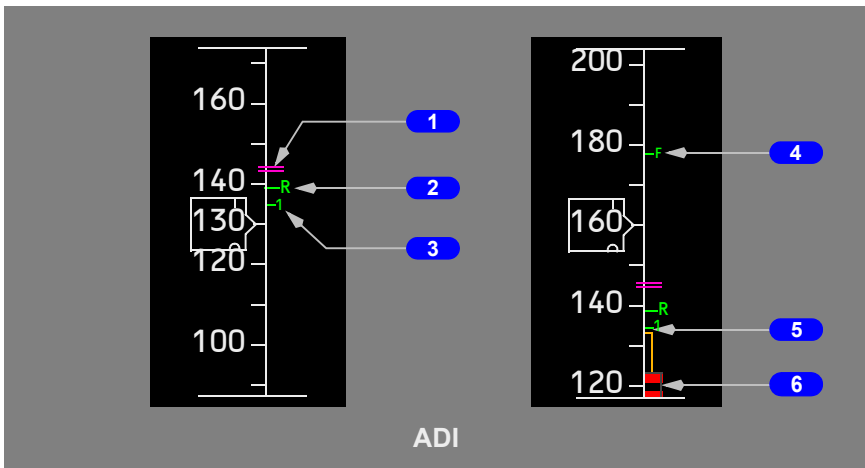

1 FMC/MCP Command Airspeed Bug

Displays when the FMC/MCP command airspeed as selected by the FMC or the IAS/MACH selector is in the displayed range.

2 VR (Rotation Speed) Bug

Indicates rotation speed.

- displays after manual entry on the TAKEOFF REF page
- blanks 2 minutes after takeoff.

4 VF (Maneuvering Speed) Bug

- displays maneuvering speed for existing flap setting
- displays 10 seconds after takeoff
- if VF is within 4 knots of VR, both VR and V1 bugs are blanked
- blanks above 20,000 feet.

3 V1 (Decision Speed) Bug

Indicates Decision Speed

- displays after manual entry on the TAKEOFF REF page
- replaces digital V1 display when V1 speed is within the displayed range
- blanks 2 minutes after takeoff.

5 Minimum Maneuvering Speed

Top of amber bar indicates minimum maneuvering speed. This airspeed provides:

- 1.3g maneuver capability to stick shaker below approximately 20,000 feet
- 1.3g maneuver capability to low speed buffet (or an alternative approved maneuver capability as preset by maintenance) above approximately 20,000 feet.

Displayed shortly after takeoff.

Note: 1.3g maneuver capability occurs at 40 degrees of bank in level flight.

6 Minimum Operating Speed

Indicates the minimum operating speed

- below 20,000 feet - airspeed where stick shaker activates
- above 20,000 feet - initial buffet onset speed.

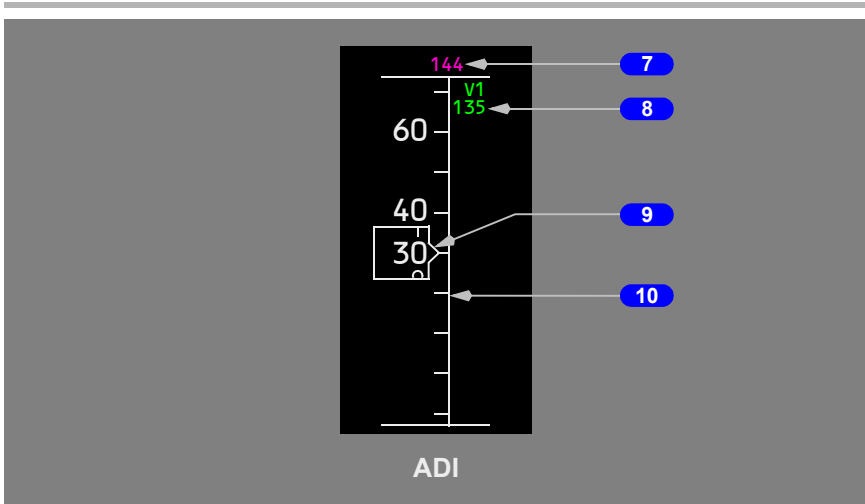

7 FMC/MCP Command Airspeed

Displays in this location when the FMC/MCP command airspeed bug as selected by the FMC or IAS/MACH selector is above the displayed range.

8 V1 (Decision Speed)

Indicates decision speed.

- displays after manual entry on the TAKEOFF REF page
- displays during initial takeoff roll when V1 is above the displayed range.

9 Airspeed Pointer and Digital Display

- indicates current airspeed when above 30 knots

10 Speed Tape Scale

Scrolls up or down in response to airspeed changes.

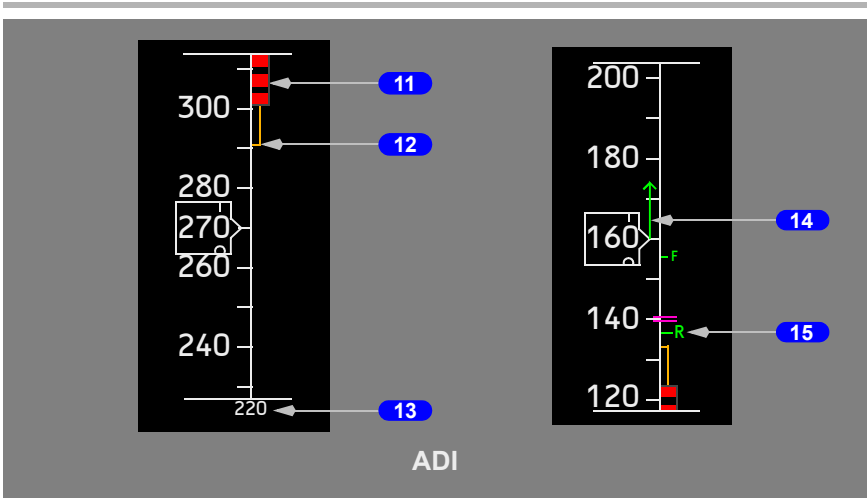

11 Maximum Speed

Indicates maximum permissible airspeed as limited by the lowest of the following:

- Vmo/Mmo
- landing gear placard speed
- flap placard speed.

12 Maximum Maneuvering Speed

Bottom of the amber bar indicates the maximum maneuvering speed. This airspeed provides 1.3g maneuver capability to high speed buffet (or an alternative approved maneuver capability set by maintenance). May be displayed when operating at high altitude at relatively high gross weights.

Note: 1.3g maneuver capability occurs at 40 degrees of bank in level flight.

13 FMC/MCP Command Airspeed

Displayed in this location when the FMC/MCP command airspeed bug as selected by the FMC or IAS/MACH selector is below the displayed range.

14 Speed Trend Vector

Indicates predicted airspeed in 10 seconds based on current acceleration or deceleration.

15 Landing Reference Bug

Displays the VREF speed as selected on the APPROACH REF page.

ADI Failure Flags and Annunciations

Note: ADI failure flags replace the appropriate display to indicate source system failure, or lack of computed information.

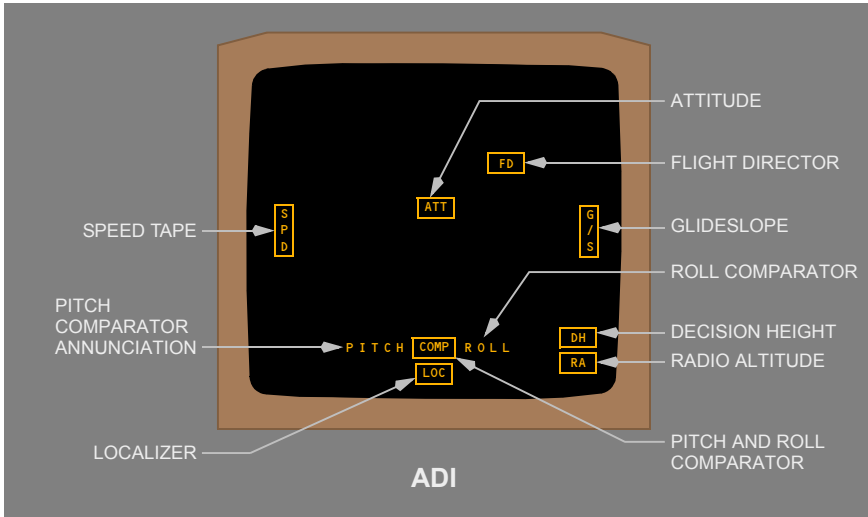
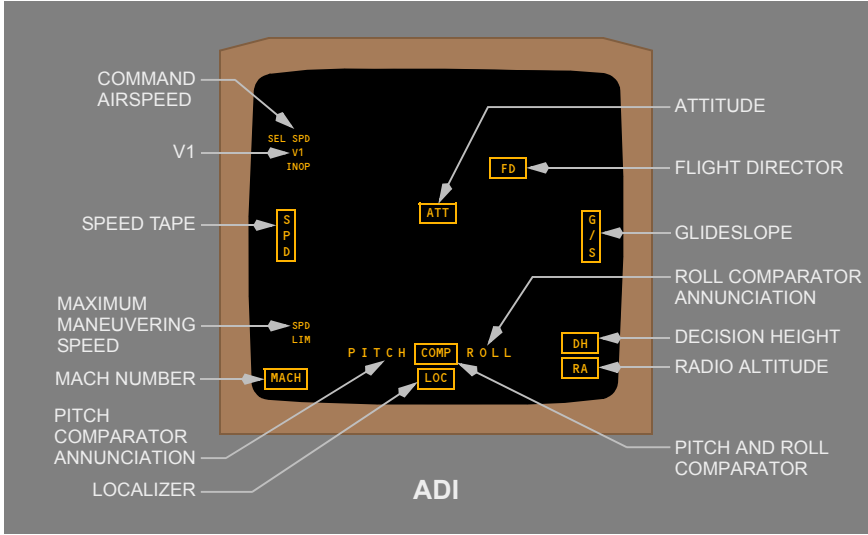

Intentionally
Blank

Horizontal Situation Indicator (HSI) Display Modes

MAP Mode

Option: Track up HSI orientation.

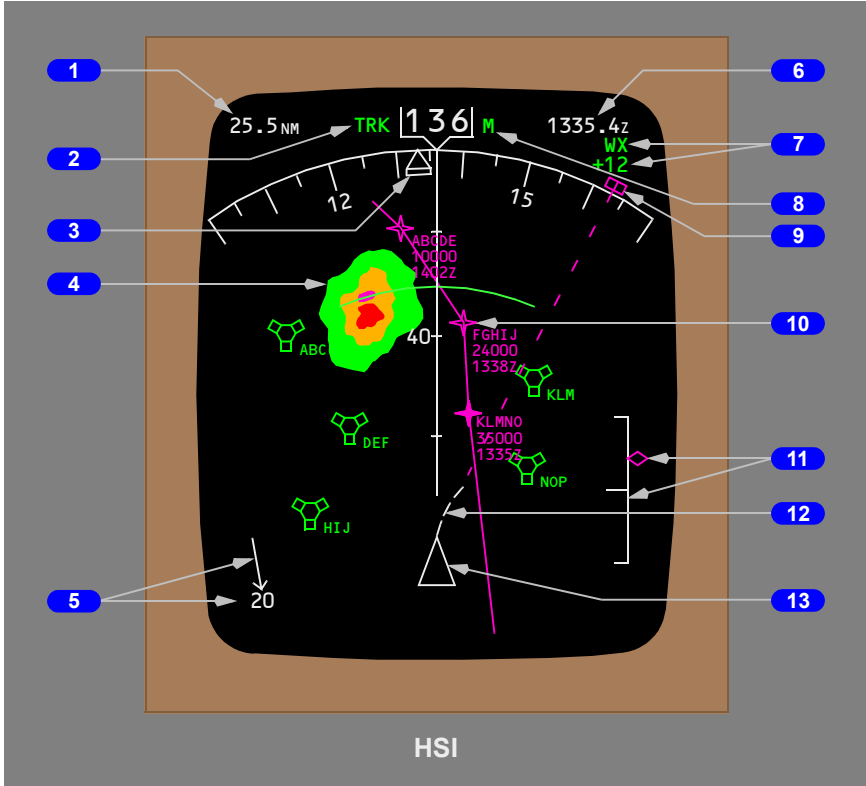

- 1** Distance to the Active Waypoint
- 2** Current Track
- 3** Heading Pointer
- 4** Weather Radar Returns
- 5** Wind Direction and Speed
- 6** Estimated Time of Arrival at the Active Waypoint
- 7** Weather Radar Annunciations
- 8** Magnetic/True Reference
- 9** Selected Heading Bug
- 10** Active LNAV Route
- 11** Vertical Pointer and Deviation Scale
- 12** Position Trend Vector
- 13** Airplane Symbol

Option: Heading up HSI orientation.

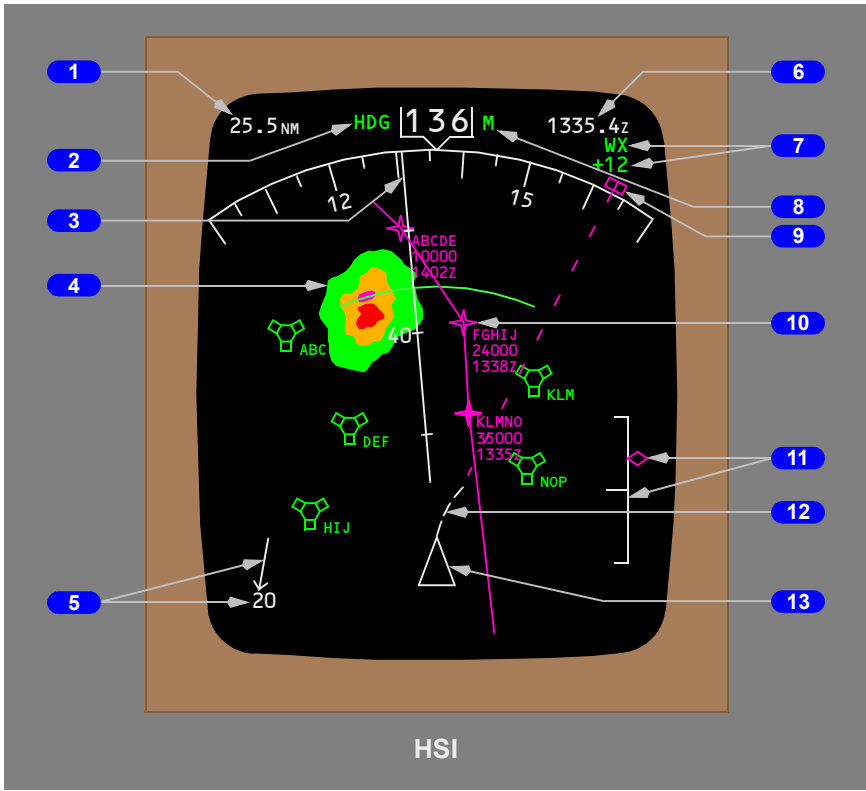

- 1** Distance to the Active Waypoint
- 2** Current Heading
- 3** Track Line
- 4** Weather Radar Returns
- 5** Wind Direction and Speed
- 6** Estimated Time of Arrival at the Active Waypoint
- 7** Weather Radar Annunciations
- 8** Magnetic/True Reference
- 9** Selected Heading Bug
- 10** Active LNAV Route
- 11** Vertical Pointer and Deviation Scale
- 12** Position Trend Vector
- 13** Airplane Symbol

CTR MAP Mode

Option: Track up HSI orientation.

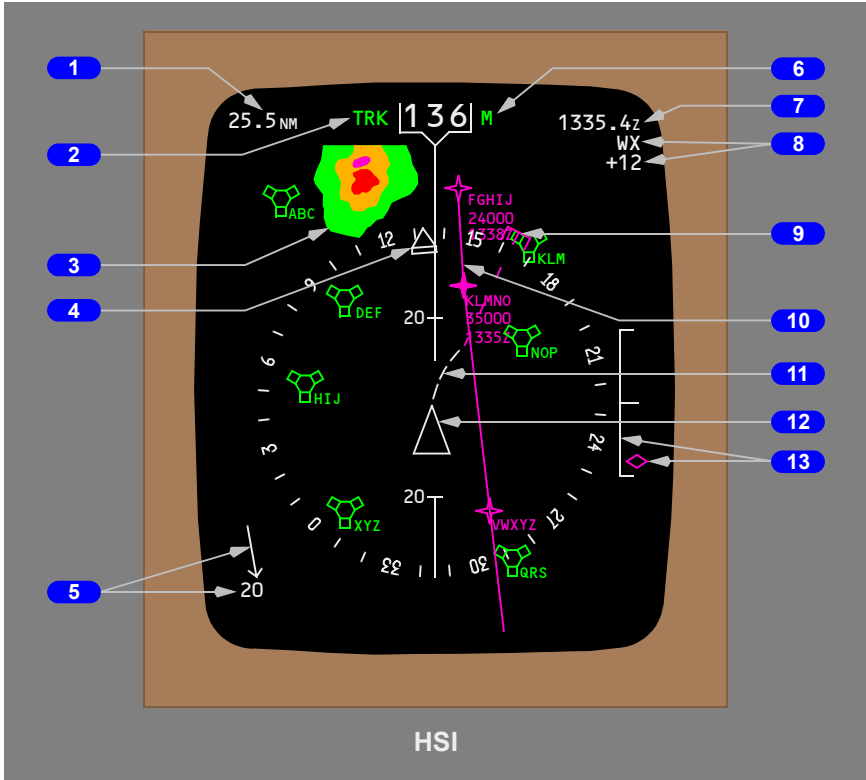

- 1** Distance to the Active Waypoint
- 2** Current Track
- 3** Weather Radar Returns
- 4** Heading Pointer
- 5** Wind Direction and Speed
- 6** Magnetic/True Reference
- 7** Estimated Time of Arrival at the Active Waypoint
- 8** Weather Radar Annunciations
- 9** Selected Heading Bug
- 10** Active LNAV Route
- 11** Position Trend Vector
- 12** Airplane Symbol
- 13** Vertical Pointer and Deviation Scale

Option: Heading up HSI orientation.

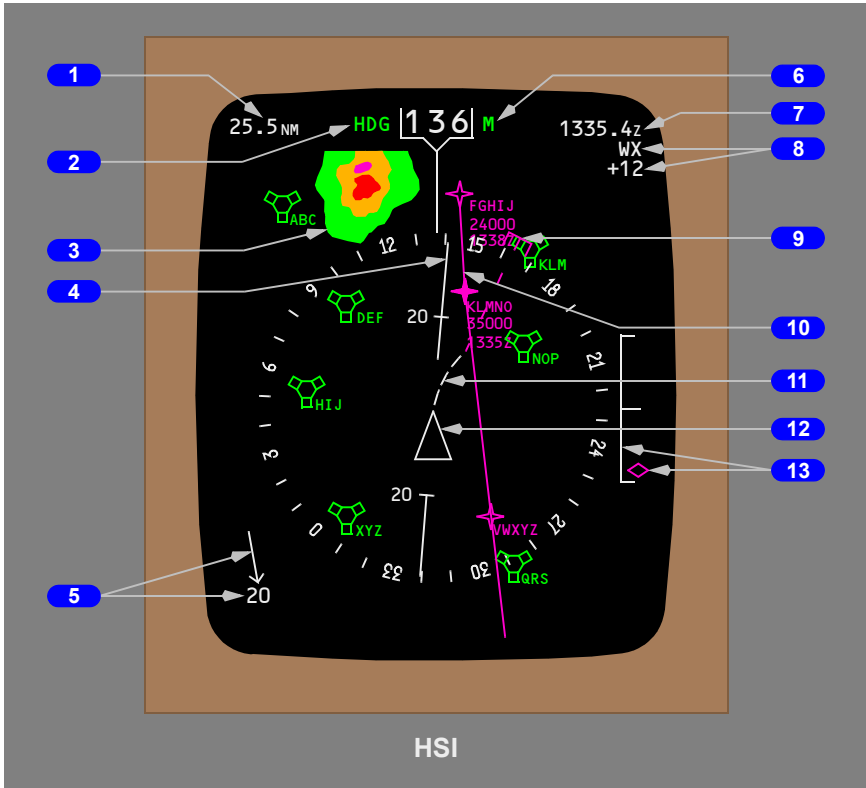

- 1** Distance to the Active Waypoint
- 2** Current Heading
- 3** Weather Radar Returns
- 4** Track Line
- 5** Wind Direction and Speed
- 6** Magnetic/True Reference
- 7** Estimated Time of Arrival at the Active Waypoint
- 8** Weather Radar Annunciations
- 9** Selected Heading Bug
- 10** Active LNAV Route
- 11** Position Trend Vector
- 12** Airplane Symbol
- 13** Vertical Pointer and Deviation Scale

APP Mode

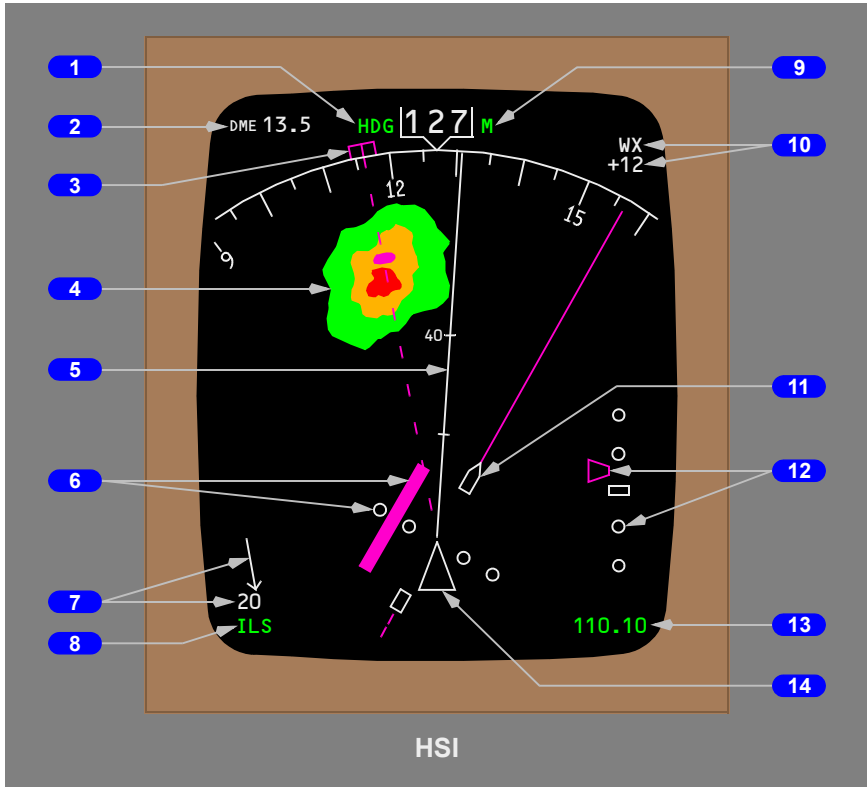

- 1** Current Heading
- 2** Reference ILS DME
- 3** Selected Heading Bug
- 4** Weather Radar Returns
- 5** Track Line
- 6** Course Deviation Indicator and Deviation Scale
- 7** Wind Direction and Speed
- 8** Reference ILS Receiver
- 9** Magnetic/True Reference
- 10** Weather Radar Annunciations
- 11** Selected Course Pointer
- 12** Glideslope Pointer and Deviation Scale
- 13** Reference ILS Frequency
- 14** Airplane Symbol

CTR APP Mode

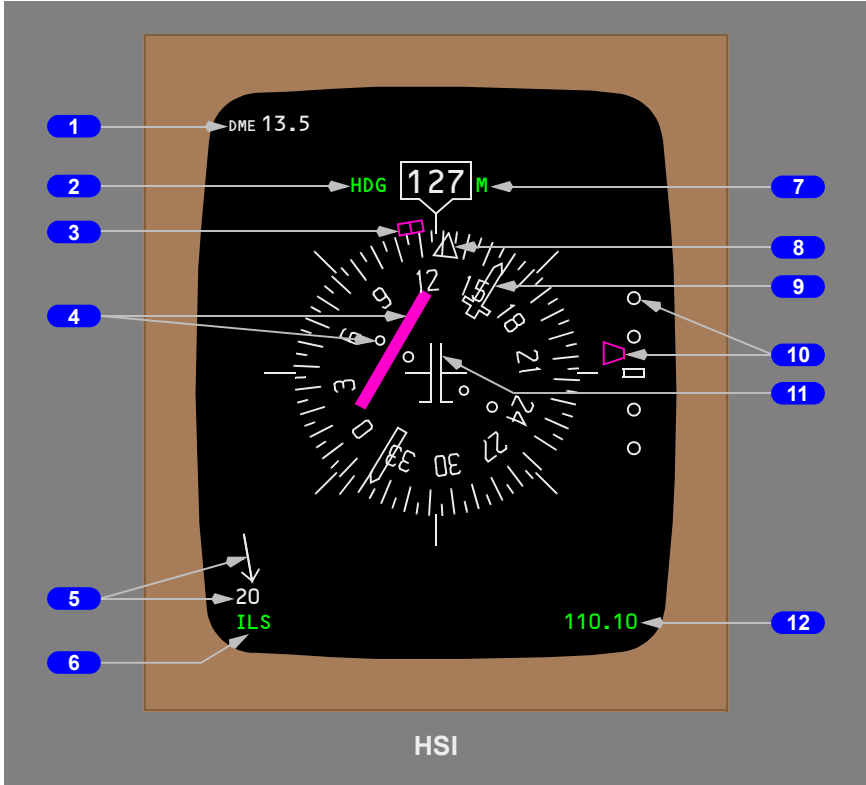

- 1** Reference ILS DME
- 2** Current Heading
- 3** Selected Heading Bug
- 4** Course Deviation Indicator and Deviation Scale
- 5** Wind Direction and Speed
- 6** Reference ILS Receiver
- 7** Magnetic/True Reference
- 8** Drift Angle Pointer
- 9** Selected Course Pointer
- 10** Glideslope Pointer and Deviation Scale
- 11** Airplane Symbol
- 12** Reference ILS Frequency

VOR Mode

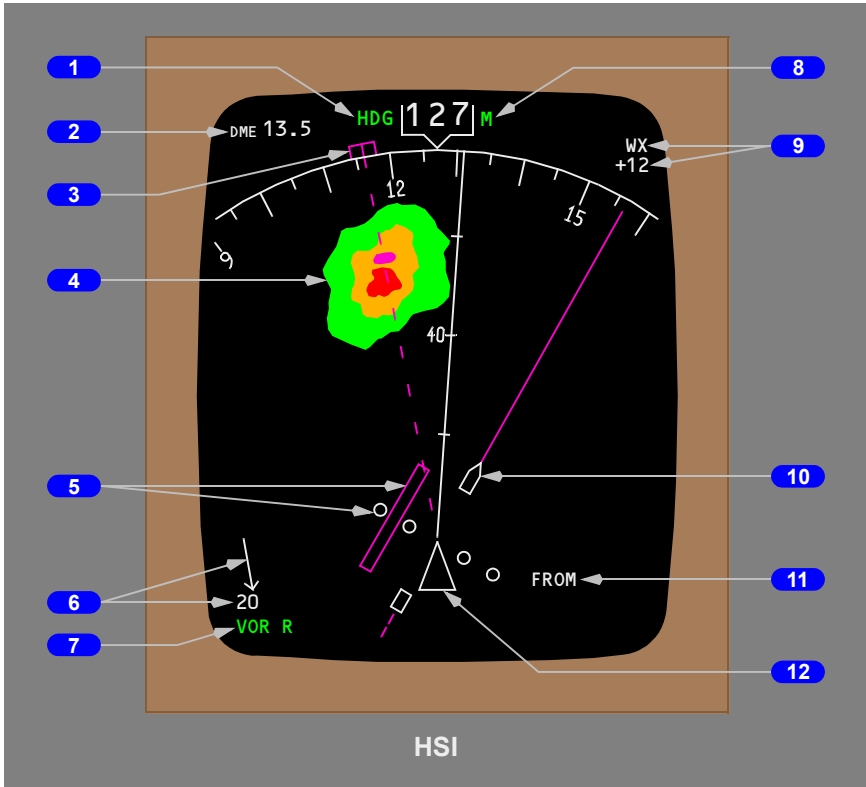

- 1** Current Heading
- 2** Reference VOR DME
- 3** Selected Heading Bug
- 4** Weather Radar Returns
- 5** Course Deviation Indicator and Deviation Scale
- 6** Wind Direction and Speed
- 7** Reference VOR Receiver
- 8** Magnetic/True Reference
- 9** Weather Radar Annunciations
- 10** Selected Course Pointer
- 11** TO/FROM Indication
- 12** Airplane Symbol

CTR VOR Mode

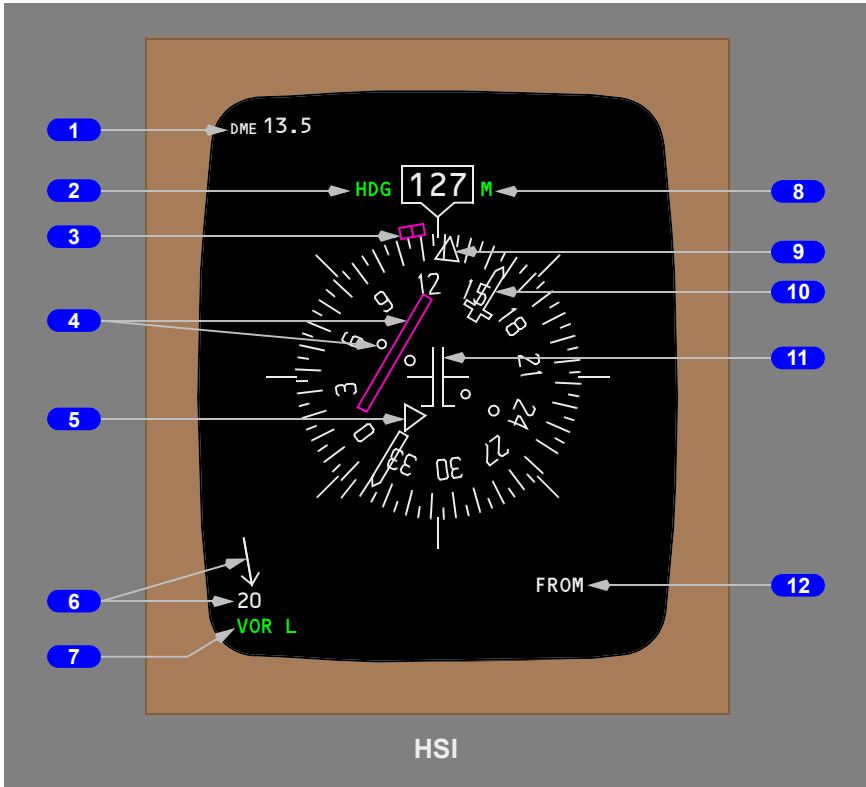

- 1** Reference VOR DME
- 2** Current Heading
- 3** Selected Heading Bug
- 4** Course Deviation Indicator and Deviation Scale
- 5** To/From Pointer
- 6** Wind Direction and Speed
- 7** Reference VOR Receiver
- 8** Magnetic/True Reference
- 9** Drift Angle Pointer
- 10** Selected Course Pointer
- 11** Airplane Symbol
- 12** TO/FROM Indication

PLAN Mode

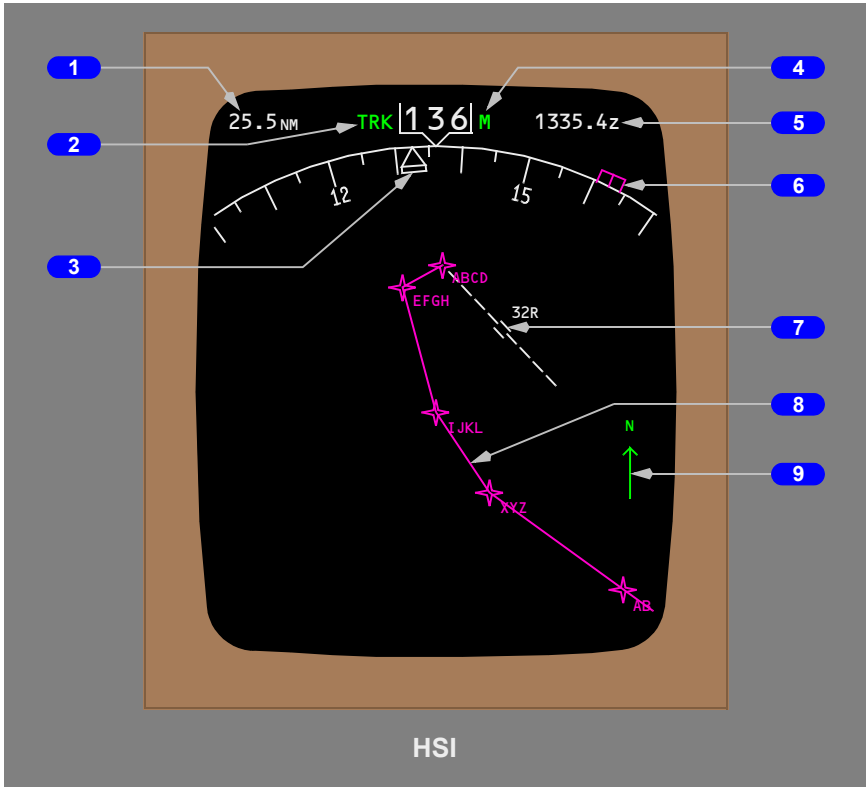

767 Flight Crew Operations Manual

- 1 Distance to the Active Waypoint
- 2 Current Track
- 3 Heading Pointer
- 4 Magnetic/True Reference
- 5 Estimated Time of Arrival at the Active Waypoint
- 6 Selected Heading Bug
- 7 Airport and Runway
- 8 Active LNAV Route
- 9 True North Pointer

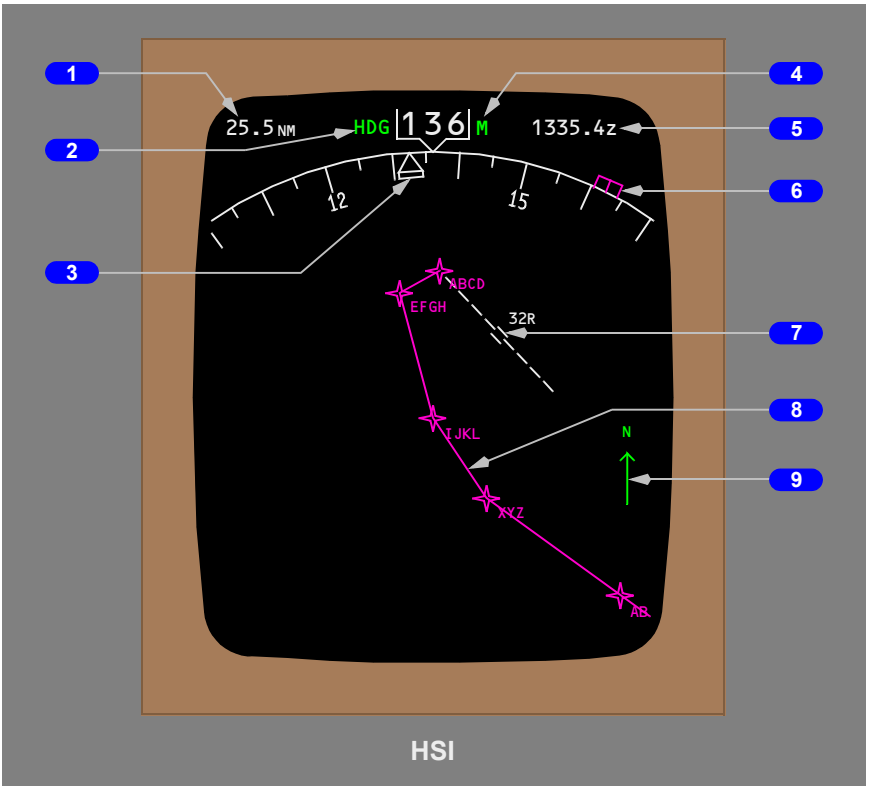



- 1** Distance to the Active Waypoint
- 2** Current Heading
- 3** Drift Angle Pointer
- 4** Magnetic/True Reference
- 5** Estimated Time of Arrival at the Active Waypoint
- 6** Selected Heading Bug
- 7** Airport and Runway
- 8** Active LNAV Route
- 9** True North Pointer



HSI Symbology

The following symbols can be displayed, depending on EFIS control panel switch selections. Colors indicate the following:

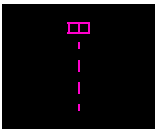

- W (white) – present status, range scales
- G (green) – active or selected mode and/or dynamic conditions
- M (magenta) – command information, pointers, symbols, fly-to condition, weather radar turbulence
- C (cyan) – nonactive or background information
- A (amber) – cautions, faults, flags
- R (red) – warnings
- B (black) – blank area, off condition.

Heading, Track, and Wind

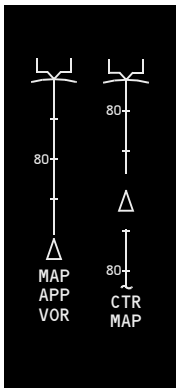
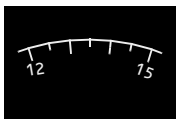

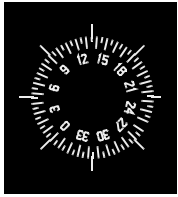

| Symbol | Name | Applicable Mode(s) | Remarks |
|---|---|----------------------------------|---|
|  | HDG – Heading orientation (G), current heading and pointer (W), heading reference (G) | All | HDG – Displays heading as the display orientation, current heading, M or TRU as the heading reference, and points to the heading on the compass rose. |
|  | Track orientation (G), current track (W), and track reference (G) | MAP PLAN CTR MAP | Displays track as the display orientation, the current track, and M or TRU as the reference, and points to the heading on the compass rose. |
|  | HDG – Heading orientation (G), current heading and pointer (W), heading reference (G) | VOR CTR VOR APP CTR APP | HDG – Displays heading as the display orientation, current heading, M or TRU as the heading reference, and points to the heading on the compass rose. |



| Symbol | Name | Applicable Mode(s) | Remarks |
|--|---|--|--|
|  | Heading reference (G), box (W) in TRU, box (A) if TRU displayed in descents of 2,000 feet at more than 800 feet per minute. | All | Indicates heading/track is referenced to magnetic north or true north. On transition from TRU to M, a highlight box is displayed around M for 10 seconds. When TRU is the reference, the highlight box is displayed full time (W). |
|  | Selected heading bug (M) and reference line (M) | MAP, CTR MAP VOR, APP Bug only CTR VOR CTR APP PLAN | Displays the heading set in the MCP. A dashed line (M) extends from the bug to the airplane symbol in the MAP and expanded modes. |
|  | Current heading pointer (W) | MAP PLAN | Points to current heading on the compass rose. |
|  | Track line and range scale (W) | MAP CTR MAP APP VOR | Displays present ground track based on airplane heading and wind. The displayed range numeric values are one-half and one-fourth (CTR MAP) the actual selected range. With heading-up orientation (VOR/APP mode), the track line will be rotated left or right at an angle equal to the drift angle. |
|  | Expanded compass rose (W) | MAP PLAN VOR APP | Displays 70 degrees of compass rose. |

767 Flight Crew Operations Manual

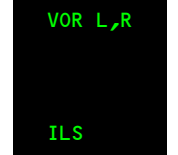
| Symbol | Name | Applicable Mode(s) | Remarks |
|---|--|--------------------|--|
|  | Full compass rose (W) Fixed reference marks (W) | CTR VOR CTR APP | The compass rose rotates through 360 degrees as a function of airplane heading. Fixed reference marks are evenly spaced at 45 degree intervals. |
|  | Center Map full compass rose (W) | CTR MAP | The compass rose rotates through 360 degrees as a function of airplane heading. |
|  | Wind speed and direction. (W) | All except PLAN | Indicates wind speed and direction, with respect to display orientation and heading reference. |

Radio Navigation

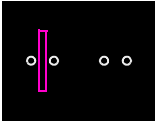
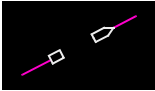
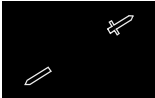
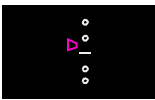

| Symbol | Name | Applicable Mode(s) | Remarks |
|---|--|----------------------------------|---|
|  | Airplane symbol (W) | VOR APP | Current airplane position is at the apex of the triangle. |
|  | Airplane symbol (W) | CTR VOR CTR APP | Current airplane position is at the center of the symbol. |
|  | Reference VOR receiver (G) Reference ILS receiver (G) | VOR CTR VOR APP CTR APP | Indicates the source of the displayed navigation data. In the VOR or APP mode the displayed data source is a function of the tuned frequency (VOR or LOC). |
|  | Reference ILS frequency (G) | APP CTR APP | Displays frequency of manually tuned navaid. |
|  | Reference VOR or ILS DME (W) | VOR CTR VOR APP CTR APP | Indicates DME distance to the reference navaid. |

| Symbol | Name | Applicable Mode(s) | Remarks |
|--|--|----------------------------------|--|
|  | Course deviation indicator (M) and deviation scale (W) | VOR CTR VOR APP CTR APP | Displays ILS or VOR course deviation. |
|  | Selected course pointer (W) and line (M) | VOR APP | Displays selected course as set by the related VOR or ILS course selector. |
|  | Selected course pointer (W) | CTR VOR CTR APP | Displays selected course as set by the related VOR or ILS course selector. |
|  | Glideslope pointer (M) and deviation scale (W) | APP CTR APP | Displays glideslope position and deviation. Pointer not displayed when track and front course differ by more than 90°. |
|  | To/from indication (W) | VOR CTR VOR | Displays VOR TO/FROM indication. |
|  | To/from pointer (W) | CTR VOR | Displays VOR to/from direction. |

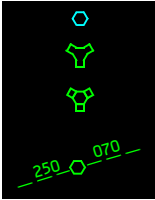
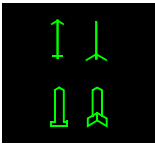

767 Flight Crew Operations Manual

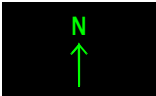
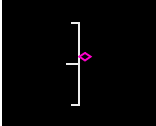

| Symbol | Name | Applicable Mode(s) | Remarks |
|---|---|------------------------|--|
|  | <p>VOR (C, G), DME/TACAN (C, G), VORTAC (C, G) Manually tuned VOR radials (G)</p> | <p>MAP CTR MAP</p> | <p>When the EFIS control panel NAV AID switch is OFF, tuned navaids, excluding NDBs, are displayed (G).</p> <p>When the EFIS control panel NAV AID switch is selected ON, appropriate navaids are displayed. All navaids contained in the FMC data base and within the MAP area are displayed when the selected range is 10, 20 or 40 NM. Only high altitude navaids are displayed when the selected range is 80, 160, 320 NM. Navaids not being used are displayed in cyan.</p> <p>Tuned VHF navaids are displayed in green, regardless of switch selection. When a navaid is manually tuned, the selected course and reciprocal are displayed.</p> |
|  | <p>Left ADF pointer head and tail (G) Right ADF pointer head and tail (G)</p> | <p>All</p> | <p>Indicates bearing to (head) or from (tail) the tuned station.</p> |

Map

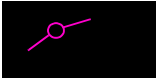
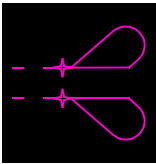
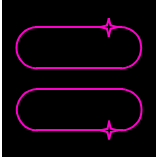
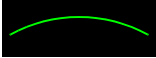

| Symbol | Name | Applicable Mode(s) | Remarks |
|--|--|------------------------|--|
|  | Position trend vector (W) (dashed line) and airplane symbol (W). | MAP CTR MAP | Predicts position at the end of 30, 60, and 90 second intervals, based on bank angle and ground speed. Each segment represents 30 seconds. Selected range determines the number of segments displayed: <ul style="list-style-type: none"> • Range > 20 NM, 3 segments • Range = 20 NM, 2 segments • Range = 10 NM, 1 segment |
|  | North Pointer (G) | PLAN | Indicates orientation of map background to true north. |
|  | Vertical pointer (M), and deviation scale (W) | MAP CTR MAP | Displays vertical deviation from selected VNAV PATH during descent only. Scale indicates +/- 400 feet deviation. |
|  | Off route waypoint (C) | MAP PLAN CTR MAP | When the EFIS control panel WPT switch is selected on, waypoints not on the selected route are displayed, for ranges of 10, 20, or 40 NM. When a range greater than 40NM is selected, only those waypoints associated with NDBs that are within 80NM of the airplane are displayed. |

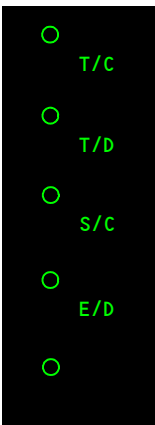
767 Flight Crew Operations Manual

| Symbol | Name | Applicable Mode(s) | Remarks |
|---|---|------------------------|---|
|  | Conditional Waypoint: active (M), inactive (W) | MAP PLAN | Active – represents the waypoint the airplane is currently navigating to. Inactive – represents the waypoints on the active route. Data with parentheses for conditional waypoints indicates type of conditional waypoint (ALTITUDE etc.) |
|  | Procedure turn: active (M), modified (W), inactive (C) | MAP PLAN CTR MAP | A fixed size procedure turn appears when it is part of the displayed FMC route. When the procedure turn waypoint is active and the HSI range is 40 nm or less, the procedure turn changes to the correct scale size. |
|  | Holding pattern: active route (M), modified route (W), inactive route (C) | MAP PLAN CTR MAP | A fixed size holding pattern appears when it is part of the displayed FMC route. When the holding waypoint is active and the HSI range is 80 nm or less, the holding pattern changes to the correct scale size. |
|  | Altitude range arc (G) | MAP CTR MAP | Based on present vertical speed and ground speed, indicates the approximate map position where the MCP altitude is reached. |
|  | Energy management circles: clean (C), speedbrake (W) | MAP CTR MAP | Indicates clean and speedbrake energy management circles as defined on OFFPATH DES page. |



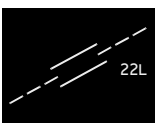
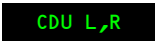

| Symbol | Name | Applicable Mode(s) | Remarks |
|--|---|------------------------|--|
|  | Altitude profile point and identifier (G) | MAP PLAN CTR MAP | Indicates the approximate map position of the FMC-calculated T/C (top-of-climb), T/D (top-of-descent), S/C (step climb), and E/D (end of descent) points. Deceleration points have no identifier. |
|  | Selected reference point and bearing information (G) | MAP PLAN CTR MAP | Displays the reference point selected on the CDU FIX page. Bearing from the fix is displayed with dashes (G). |
|  | Selected reference point and distance information (G) | MAP PLAN CTR MAP | Displays the reference point selected on the CDU FIX page. Distance from the fix is displayed with dashes (G). |

767 Flight Crew Operations Manual

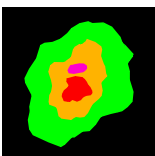
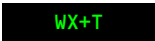
| Symbol | Name | Applicable Mode(s) | Remarks |
|---|-----------------------------|-----------------------|--|
|  | Airport (C) | MAP PLAN CTRMAP | Displayed if the EFIS control panel ARPT switch is selected ON. Origin and destination airports are always displayed, regardless of switch selection. |
|  | Airport and runway (W) | | Displayed when selected as the origin or destination and selected range is 80, 160, or 320 NM. |
|  | Airport and runway (W) | | Displayed when selected as the origin or destination and selected range is 10, 20, or 40 NM. Dashed runway centerlines extend 14.2 NM. |
|  | MAP source annunciation (G) | MAP | Displays HSI source if CDU is selected on respective NAV Source Select Switch. |

Radar

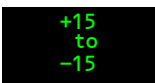





| Symbol | Name | Applicable Mode(s) | Remarks |
|---|--|------------------------------|--|
|  | Weather radar (WXR) returns (R, A, G, M) | MAP CTR MAP VOR APP | The most intense areas are displayed in red, lesser intensity in amber, and lowest intensity green. Turbulence is displayed in magenta. |
|  | WXR and turbulence mode (G) | MAP CTR MAP VOR APP | Weather radar system is selected on the EFIS control panel. Weather radar mode, gain and tilt is controlled on the weather radar panel(s) (refer to Chapter 11, Flight Management, Navigation). |

| Symbol | Name | Applicable Mode(s) | Remarks |
|--|--|------------------------------|--|
|  | WXR receiver gain (G) | MAP CTR MAP VOR APP | Weather radar system is selected on the EFIS control panel. Weather radar mode, gain and tilt is controlled on the weather radar panel(s) (refer to Chapter 11, Flight Management, Navigation). |
|  | Mode used with down-tilt when ground mapping (G) | MAP CTR MAP VOR APP | Weather radar system is selected on the EFIS control panel. Weather radar mode, gain and tilt is controlled on the weather radar panel(s) (refer to Chapter 11, Flight Management, Navigation). |
|  | WXR antenna tilt (G) | MAP CTR MAP VOR APP | Weather radar system is selected on the EFIS control panel. Weather radar mode, gain and tilt is controlled on the weather radar panel(s) (refer to Chapter 11, Flight Management, Navigation). |
|  | WXR test mode (C) (G) | MAP CTR MAP VOR APP | Weather radar mode, gain and tilt is controlled on the weather radar panel(s) (refer to Chapter 11, Flight Management, Navigation). |

767 Flight Crew Operations Manual

| Symbol | Name | Applicable Mode(s) | Remarks |
|---------------------------------------|------------------------------------|------------------------------|---|
| WXR WEAK | WXR calibration fault (A) | MAP CTR MAP VOR APP | When a degraded condition is present the EFIS will continue to display weather radar information. If any two or all degraded conditions occur simultaneously, the system will display only the highest priority condition as follows: <ul style="list-style-type: none"> • WEAK • ATT • STAB |
| WXR ATT | WXR attitude input fault (A) | | |
| WXR STAB | WXR stabilization off (A) | | |
| WXR DSPY | WXR display fault (A) | MAP CTR MAP VOR APP | HSI overheat or loss of digital unit cooling air when WXR is selected. Overheat annunciation has display priority over all other degraded conditions. Weather radar information removed after 30 seconds. |
| WXR FAIL | WXR system failure (A) | MAP CTR MAP VOR APP | Weather radar system failure is annunciated under any of the following conditions: <ul style="list-style-type: none"> • receiver transmitter failure • antenna failure • control panel failure |
| WXR RANGE DISAGREE | WXR range status annunciations (A) | MAP CTR MAP VOR APP | Weather output range disagrees with the range selected by the EFIS control panel. |
| MAP/WXR RANGE DISAGREE | WXR range status annunciations (A) | MAP CTR MAP | Weather output range and map display output range disagree with selected EFIS control panel range. |

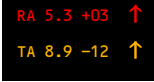

TCAS

| Symbol | Name | Applicable Mode(s) | Remarks |
|--|--|------------------------------|--|
|  | TCAS resolution advisory (RA), relative altitude (R) | MAP CTR MAP APP VOR | <p>These symbols are displayed only when the EFIS control panel traffic (TFC) switch is selected on. Refer to Chapter 15, Warning Systems.</p> <p>The arrow indicates traffic climbing or descending at a rate greater than or equal to 500 fpm. At rates less than 500 fpm, the arrow is not displayed.</p> <p>The number and associated signs indicate altitude of traffic in hundreds of feet relative to the airplane.</p> <p>The number is below the traffic symbol when the traffic is below, and above the traffic symbol when the traffic is above the airplane. Absence of the number implies altitude unknown.</p> |
|  | TCAS traffic advisory (TA), relative altitude (A) | | |
|  | TCAS proximate traffic, relative altitude (W) | | |
|  | TCAS other traffic, relative altitude (W) | | |
|  | TCAS no bearing message (RA-R, TA-A) | MAP CTR MAP APP VOR | Message provides traffic type, range in NM, altitude and vertical direction. |
|  | TCAS traffic alert message (RA-R, TA-A) | All | Displayed whenever a TCAS RA or TA is active. EFIS control panel TFC switch does not have to be selected on. |
|  | TCAS off scale message (RA-R, TA-A) | MAP CTR MAP APP VOR | Displayed whenever RA or TA traffic is outside the traffic area covered by the HSI range. Displayed only if the EFIS control panel TFC switch is selected on. |



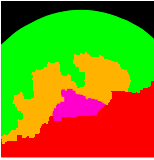

767 Flight Crew Operations Manual

| Symbol | Name | Applicable Mode(s) | Remarks |
|------------------|-----------------------|------------------------------|--|
| TFC | TCAS mode (G) | MAP CTR MAP APP VOR | Indicates the HSI TCAS display is active; the EFIS control panel TFC switch is selected on. |
| TA ONLY | TCAS mode (G) | All | Indicates TCAS computer is not computing RAs. Displayed whether the EFIS control panel TFC switch is selected on or off. |
| TCAS TEST | TCAS mode (W) | All | Indicates TCAS is operating in the test mode. Displayed whether EFIS control panel TFC switch is selected on or off. |
| TCAS OFF | TCAS off message (W) | MAP CTR MAP APP VOR | Displayed when the TCAS/ATC mode switch is not in TA ONLY or TA/RA. Not displayed if TCAS is failed. |
| TCAS FAIL | TCAS fail message (A) | MAP CTR MAP APP VOR | Indicates TCAS failure. |

Look-Ahead Terrain

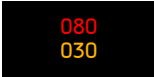

| Symbol | Name | Applicable Mode(s) | Remarks |
|--|---------------------------------|------------------------------|--|
|  | Terrain display (R, A, G, M) | MAP CTR MAP VOR APP | <p>Displays terrain data from the GPWS terrain data base.</p> <p>When the airplane is higher than 2,000 feet above the terrain, peaks contours are displayed in three densities (G). Highest peaks are displayed as solid, intermediate height terrain peaks are displayed as high density, and lowest terrain peaks are displayed as low density.</p> <p>When the airplane is lower than 2,000 feet above the terrain, the terrain displays as follows: 2,000 feet below to 500 feet (250 feet with gear down) below the airplane's current altitude (G), 500 feet (250 feet with gear down) below to 2000 feet above the airplane's current altitude (A), more than 2,000 feet above the airplane's current altitude (R), no terrain data available (M).</p> |
|  | Obstacle display (R, A, G) | | <p>Displays obstacle data from the GPWS obstacle data base.</p> <p>Color displays using the same rules as terrain display.</p> |

767 Flight Crew Operations Manual

| Symbol | Name | Applicable Mode(s) | Remarks |
|--|--|------------------------------|--|
|  | Highest and lowest terrain or obstacle altitudes (R, A, G) | MAP CTR MAP VOR APP | Terrain display enabled (manual or automatic display). Numbers displayed are altitudes, in hundreds of feet, of highest and lowest contours displayed on the HSI. Color corresponds to colors of highest and lowest terrain or obstacle displayed. Altitudes not displayed when terrain data unavailable. |
|  | Obstacle alert annunciation (R, A) | All | Look-ahead obstacle caution alert active (A), Look-ahead obstacle warning alert active (R). |
|  | Terrain alert annunciation (R, A) | All | Look-ahead terrain caution alert active (A), look-ahead terrain warning alert active (R). |
|  | Terrain mode annunciation (C) | MAP CTR MAP VOR APP | Terrain display enabled (manual or automatic display). |

| Symbol | Name | Applicable Mode(s) | Remarks |
|--------------------------------|--|------------------------------|---|
| TERR FAIL | Terrain status annunciations (A) | MAP CTR MAP VOR APP | Look-ahead terrain alerting and display have failed. |
| TERR POS | | | Look-ahead terrain alerting and display unavailable due to position uncertainty. |
| TERR OVRD | | | GPWS terrain override switch in OVRD position. |
| TERR TEST | | | Terrain test mode annunciation (C) |
| TERR DSPY | TERR display fault (A) | MAP CTR MAP VOR APP | HSI overheat or loss of digital unit cooling air when TERR is selected. Overheat annunciation has display priority over all other degraded conditions. Look-ahead terrain information removed after 30 seconds. |
| TERR RANGE DISAGREE | Terrain range status annunciations (A) | MAP CTR MAP VOR APP | Terrain output range disagrees with selected EFIS control panel range. |
| MAP/TERR RANGE DISAGREE | Terrain range status annunciations (A) | MAP CTR MAP | Terrain output range and map display output range disagree with selected EFIS control panel range. |

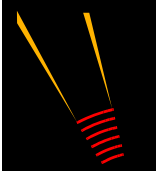
Predictive Windshear

| Symbol | Name | Applicable Mode(s) | Remarks |
|---|---------------------------------------|------------------------------|--|
|  | Predictive windshear symbol (R, B, A) | MAP CTR MAP APP VOR | Displays windshear location and approximate geometric size (width and depth). Amber radials extend from predictive windshear symbol to help identify location of windshear event. |
|  | Windshear annunciation (R, A) | All | Predictive windshear caution active (A). Predictive windshear warning active (R). |

HSI Failure Flags and Annunciations

Note: HSI failure flags replace the appropriate display to indicate source system failure, or lack of computed information.

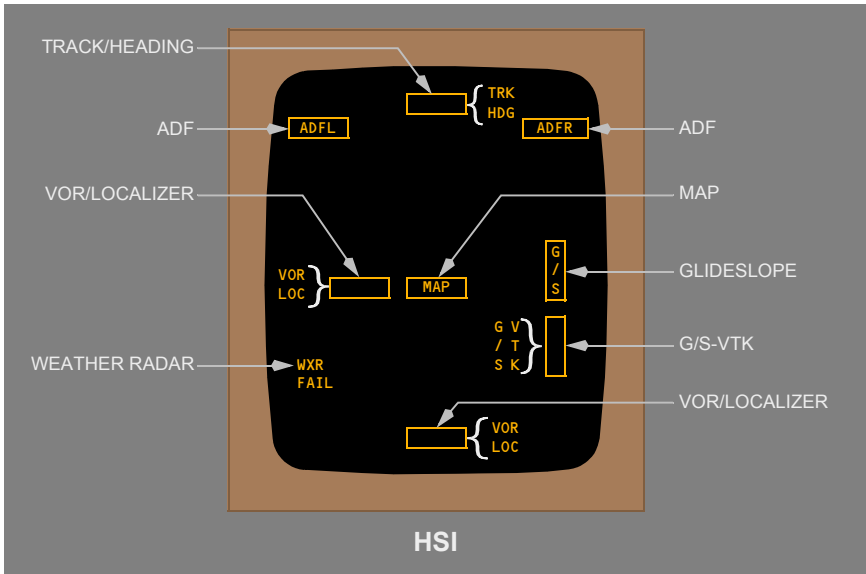
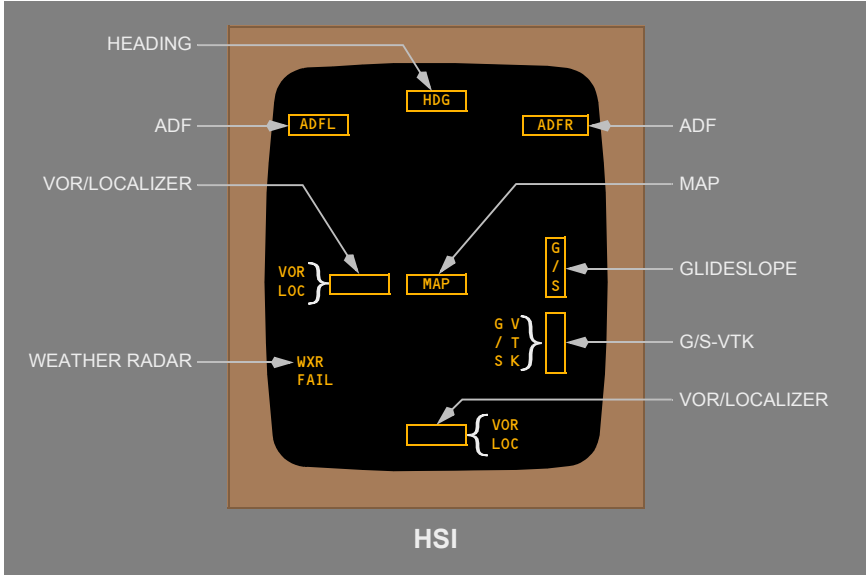

Instrument Switching

Various source selections are available for instrument displays. For other related instrument transfer switching, refer to Chapter 11, Flight Management, Navigation

Left Instrument Source Selector Panel (Upper)

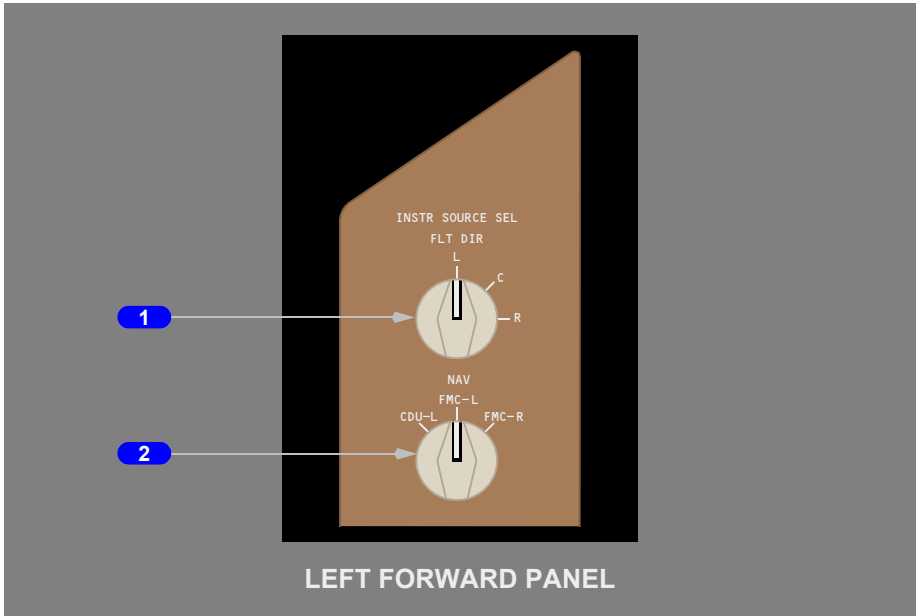

1 Flight Director (FLT DIR) Source Selector

Selects the flight control computer (left, center, or right) used as the source of commands for the captain's flight director display.

2 Navigation (NAV) Source Selector

Selects the source of FMC information used by the left and center EFIS symbol generators and the left and center flight control computers (FCCs).

- FMC L – normal position. Provides information to the left and center symbol generators, and to the left and center FCCs
- FMC R – alternate position. Provides information to the left and center symbol generators, and to the left and center FCCs
- CDU L – provides information to the left and center symbol generators. Used for operation of the Alternate Navigation System (refer to Chapter 11, Flight Management, Navigation)

Left Instrument Source Selector Panel (Lower)

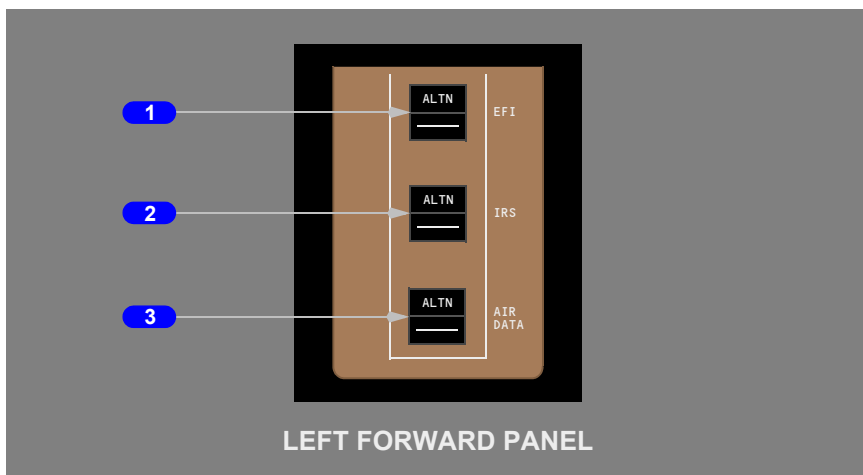

1 Electronic Flight Instruments (EFI) Switch

Selects the EFIS symbol generator, ILS receiver, and radio altimeter used as the sources of information for the captains's ADI and HSI displays.

- Blank – normal position. The captains's displays use the left symbol generator, left ILS receiver, and left radio altimeter
- ALTN – alternate position. The captains's displays use the center symbol generator, center ILS receiver, and center radio altimeter

If both pilots select ALTN (both using center sources):

- both pilots' ADI and HSI displays are controlled by the left EFIS control panel
- the EICAS message INSTR SWITCH displays

2 Inertial Reference System (IRS) Switch

Selects the IRS used as the source of information for the left and center symbol generators, the captain's VSI, and the first officer's RDMI. Information provided by the IRS includes attitude, heading, and vertical speed

- Blank – normal position. The left IRS is the source for the left and center symbol generators, the captain's VSI, and the first officer's RDMI
- ALTN – alternate position. The center IRS is the source for the left and center symbol generators, the captain's VSI, and the first officer's RDMI

3 AIR DATA Switch

Selects the air data computer used as the source of information for the captain's Mach/airspeed indicator, primary altimeter, and vertical speed indicator (via the selected IRS).

- Blank – normal position. The left air data computer is the source for the captain's air data instruments
- ALTN – alternate position. The right air data computer is the source for the captain's air data instruments

Right Instrument Source Selector Panel (Upper)

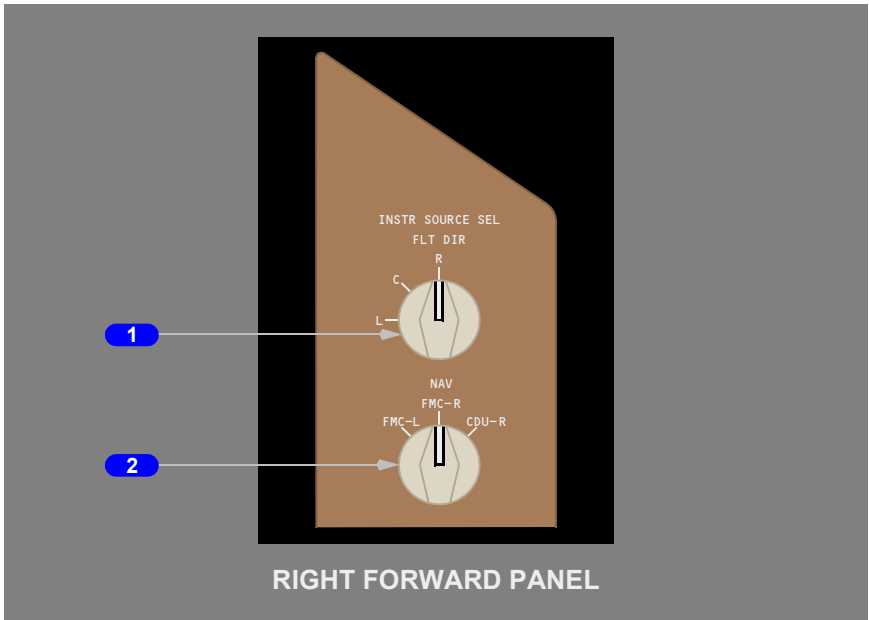

1 Flight Director (FLT DIR) Source Selector

Selects the flight control computer (left, center, or right) used as the source of commands for the first officer's flight director display.

2 Navigation (NAV) Source Selector

Selects the source of FMC information used by the right EFIS symbol generator and the right flight control computer (FCC).

- FMC R – normal position. Provides information to the right symbol generator, and to the right FCC
- FMC L – alternate position. Provides information to the right symbol generator, and to the right FCC
- CDU R – provides information to the right symbol generator. Used for operation of the Alternate Navigation System (refer to Chapter 11, Flight Management, Navigation).

Right Instrument Source Selector Panel (Lower)

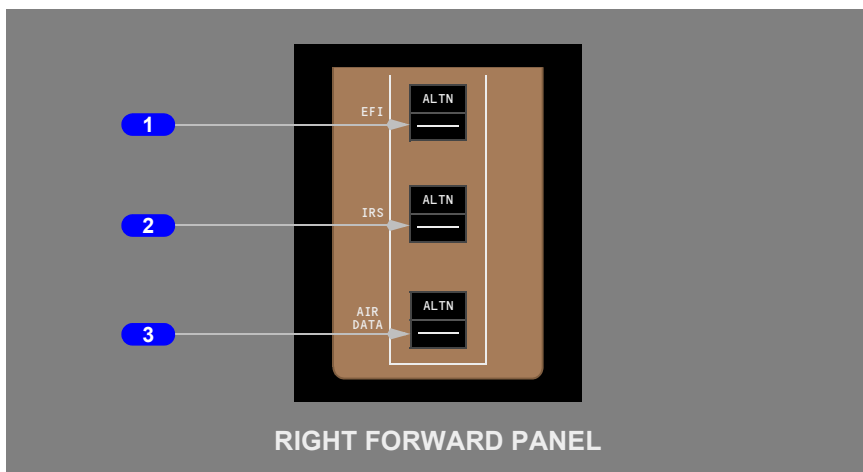

1 Electronic Flight Instruments (EFI) Switch

Selects the EFIS symbol generator, ILS receiver, and radio altimeter used as the sources of information for the first officer's ADI and HSI displays.

- Blank – normal position. The first officer's displays use the right symbol generator, right ILS receiver, and right radio altimeter
- ALTN – alternate position. The first officer's displays use the center symbol generator, center ILS receiver, and center radio altimeter

If both pilots select ALTN (both using center sources):

- both pilots' ADI and HSI displays are controlled by the left EFIS control panel
- the EICAS message INSTR SWITCH displays

2 Inertial Reference System (IRS) Switch

Selects the IRS used as the source of information for the right symbol generator, the first officer's VSI, and the captain's RDMI. Information provided by the IRS includes attitude, heading, and vertical speed.

- Blank – normal position. The right IRS is the source for the right symbol generator, the first officer's VSI, and the captain's RDMI
- ALTN – alternate position. The center IRS is the source for the right symbol generator, the first officer's VSI, and the captain's RDMI.

3 AIR DATA Switch

Selects the air data computer used as the source of information for the first officer's Mach/airspeed indicator, primary altimeter, and vertical speed indicator (via the selected IRS).

- Blank – normal position. The right air data computer is the source for the first officer's air data instruments
- ALTN – alternate position. The left air data computer is the source for the first officer's air data instruments.

EFI/IRS Interface Diagram

The following diagram shows the normal EFI/IRS interface. EFI switching determines the center symbol generator (C-SG) input and output. Normally, left system instrument sources supply the center symbol generator. When both pilots select ALTN with their EFI switches, the left system instrument sources supply data to the center symbol generator. However, the center symbol generator always uses the center ILS and center radio altimeter. Each EFIS control panel is connected to the symbol generator with the EFI switch. Each IRS switch permits pilot selection of the alternate data source for heading, attitude, and vertical speed.

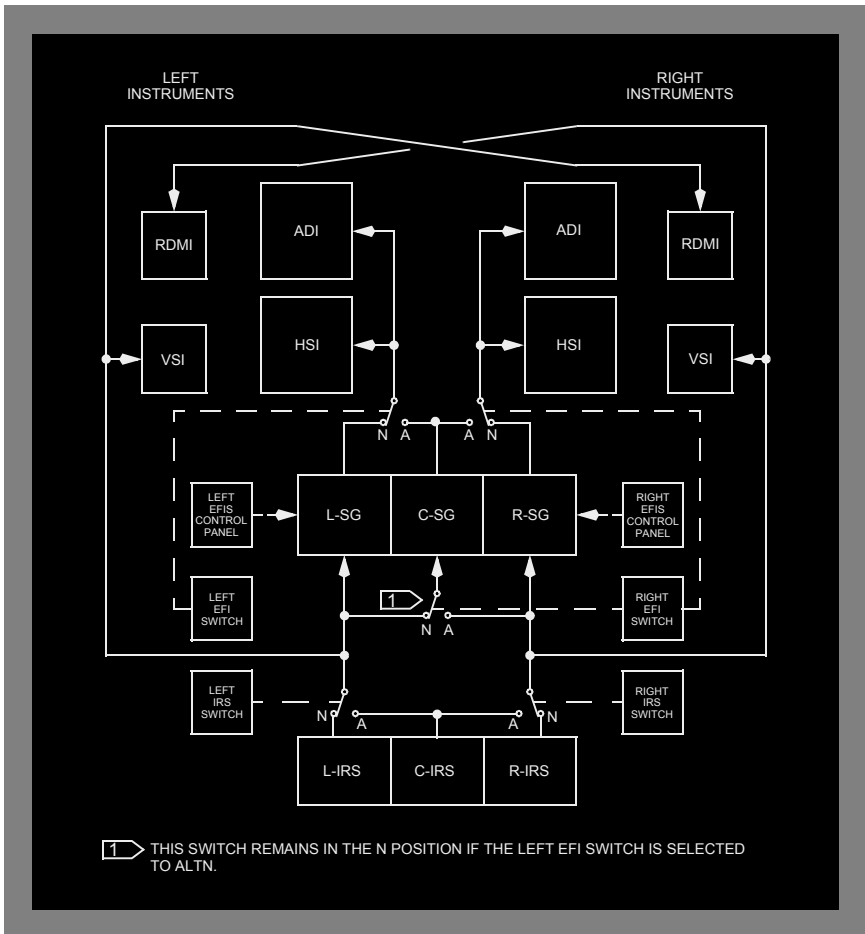

Heading Reference Switch

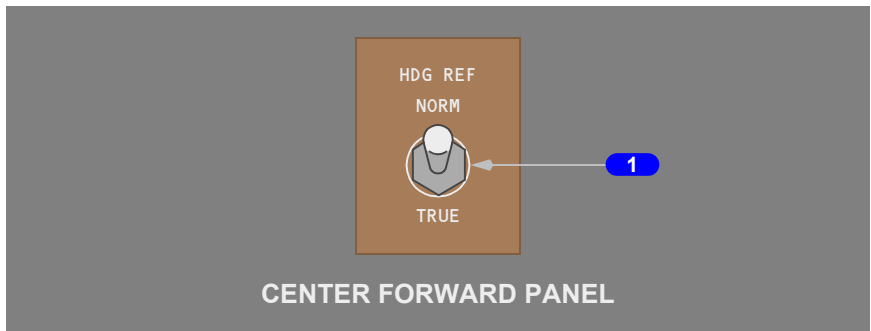

1 Heading Reference (HDG REF) Switch

NORM –

- references each compass card to magnetic north when operating outside polar regions
- references each HSI to true north and causes each RDMI heading flag to appear when operating within polar regions.

TRUE – references each compass card to true north regardless of latitude.

EFIS Control Panel

The left EFIS control panel controls the left ADI and HSI. The right EFIS control panel controls the right ADI and HSI.

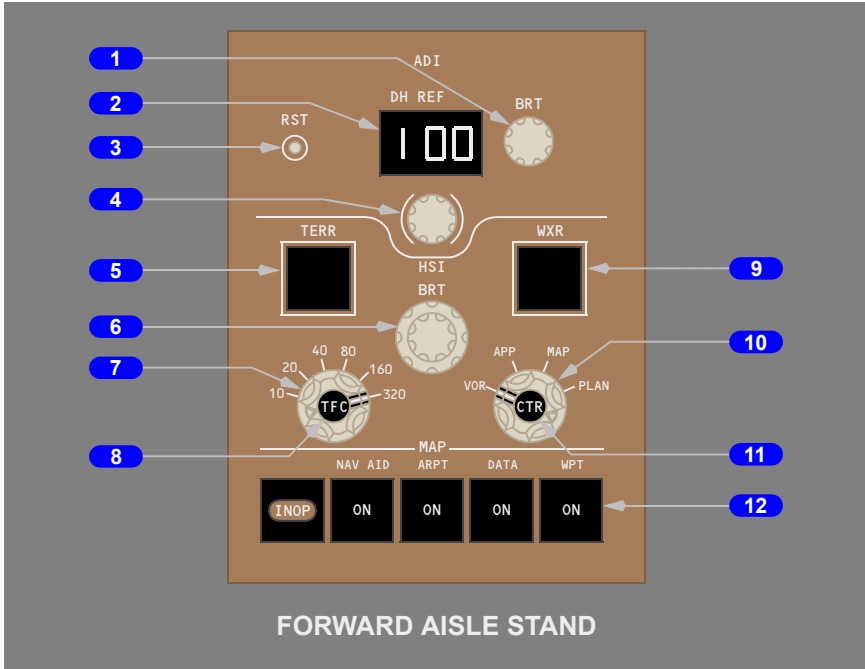

1 ADI Brightness (BRT) Control

Rotate – adjusts brightness of ADI display.

2 Decision Height Reference (DH REF) Window

- displays selected decision height
- displays on ADI (ADI blanks when a negative decision height is selected)

3 Decision Height Reset (RST) Switch

Push –

- resets DH alert on related ADI
- changes RA display from amber to white
- blanks height alert on related ADI

4 Decision Height Selector

Rotate – selects decision height for DH alerting.

5 Terrain (TERR) Switch

Push –

- displays terrain data on the HSI in MAP, CTR MAP, VOR, and APP
- deselected the weather radar display regardless of the mode selector position

For a description of the ground proximity warning system, refer to Chapter 15, Warning Systems.

6 HSI Brightness (BRT) Control

Rotate –

- outer control – adjusts overall brightness of HSI display
- inner control – adjusts brightness of weather radar or terrain display

7 HSI Range Selector

Rotate –

- selects nautical mile range for MAP, CTR MAP, and PLAN displays
- when the WXR switch or TCAS TFC switch is ON, also selects the desired range for the VOR and APP mode displays

8 Traffic (TFC) Switch

Note: TCAS must be activated on the Transponder Panel (refer to Chapter 11, Flight Management, Navigation).

Push –

- displays or removes TCAS traffic information on HSI

9 Weather Radar (WXR) Switch

Push – displays weather radar information (refer to Chapter 11, Flight Management, Navigation).

10 HSI Mode Selector

VOR, CTR VOR –

- displays VOR navigation information
- selects manual VOR and DME tuning on the VOR/DME panel (automatic tuning inhibited)

APP, CTR APP –

- displays ILS navigation information
- selects manual VOR and DME tuning on the VOR/DME panel (automatic tuning inhibited)

MAP, CTR MAP –

- displays a dynamic map
- allows selection of manual or automatic VOR and DME tuning on the VOR/DME panel
- allows remote manual VOR and DME tuning on the PROGRESS page

PLAN –

- displays static FMC map in true–north–up orientation
- displays heading information in heading–up form
- allows selection of manual or automatic VOR and DME tuning on the VOR/DME panel
- allows remote manual VOR and DME tuning on the PROGRESS page
- activates the MAP CTR STEP prompt on the LEGS page for stepping through the displayed route

11 Center (CTR) Switch

Push –

- when the HSI Mode Selector is in the MAP, VOR, or APP positions, toggles between full and expanded rose displays
- does not affect display in PLAN mode

12 Map Switches

NAV AID –

- displays only high altitude VHF navigation aids when HSI range is 80nm or greater
- displays all VHF navigation aids when HSI range is 40nm or less

Airport (ARPT) –

Displays all airports in the display range.

DATA –

Displays estimated time of arrival and any altitude constraint for each waypoint in the displayed flight path.

Waypoint (WPT) –

- displays all waypoints when HSI range is 40nm or less
- those waypoints associated with NDBs are displayed at any selected range as long as the NDBs are within 80nm of the airplane.

Introduction

The electronic flight instrument system (EFIS) consists of three (L, C, R) symbol generators (SGs), two control panels (CPs), two attitude director indicators (ADIs), two horizontal situation indicators (HSIs), and ambient light sensing units. The EFIS uses information provided by a variety of aircraft systems to generate the appropriate visual presentations on the HSI and ADI.

Data relating primarily to navigation is provided by aircraft systems such as the navigation radios, flight management computer (FMC), and the inertial reference systems. Data relating primarily to automatic flight is provided by the flight control computers (FCCs), the autothrottle (A/T), and the FMC. Data which is used to display current aircraft state information is provided by the two air data computers (ADCs) and the three inertial reference systems (IRSs).

Automatic adjustment of the display intensity for each display unit is provided by the ambient light sensing units. Flight crew control of the EFIS displays is accomplished by positioning the various controls on the respective EFIS control panels to the desired settings. For information on EFIS/IRS interface, and instrument switching see Section 10, of this chapter.

EFIS Symbol Generators

Three symbol generators form the heart of the EFIS. The SGs receive inputs from various aircraft systems, then generate the proper visual displays for the related ADI and HSI. Each pilot's ADI and HSI displays are provided from the SG selected with their respective EFI switch. The left SG normally provides the captain's displays, and the right SG normally provides the first officer's displays. The center SG is available as an alternate source for either or both pilots.

EFIS Control Panels

The EFIS control panels control display options, modes, ranges and brightness for the respective ADIs and HSIs.

Attitude Director Indicator

The ADI presents conventional displays for attitude (pitch and roll), flight director commands, localizer deviation and glide slope deviation. In addition, the ADI displays information relating to autoflight system mode annunciations, airplane speed, pitch limit, radio altitude, and decision height. The captain's attitude information is provided by the left IRS and the first officer's information is provided by the right IRS. The center IRS provides that data as an alternate source.

Attitude Display

Airplane attitude data is provided by the IRSs. The IRSs' pitch and roll attitude information is valid throughout 360 degrees of rotation in each axis.

Mode Annunciations

Mode annunciations for the A/T and the AFDS are displayed at the top of the ADI displays. For a detailed description of the various autoflight mode annunciations and their meanings, refer to Chapter 4, Automatic Flight.

Flight Director Commands

Flight director guidance commands from the selected FCC are displayed via the flight director symbol on the ADI.

A flight director failure in either axis causes the respective command bar to disappear. If both axes become unreliable, both command bars disappear and the FD flag appears.

Glide Slope and Localizer Deviation Displays

Conventional ILS information is provided from the ILS receiver selected with each pilot's EFI switch. All three ILS receivers are commonly tuned on the ILS panel.

Attitude Comparator

The EICAS caution message ATT DISAGREE displays when a difference of more than 3 degrees between the captain's and first officer's pitch or roll displays is detected. An amber PITCH or ROLL alerting annunciation is displayed on both ADIs for the parameter that is out of tolerance. Attitude comparison monitoring is inhibited when both pilots are using the center symbol generator by selecting ALTN on the EFI switches.

Height Alert

The radio height alert ALT is triggered when the airplane descends below 2,500 feet AGL. The alert is turned off when the airplane continues to descend below 500 feet AGL or climbs above 2,500 feet AGL, or after pressing the decision height reset switch on the EFIS control panel.

Radio Altitude and Decision Height

When radio altitude is less than 2,500 feet AGL, a digital display is depicted on the ADI. At all other times, the digital radio altitude display is blanked.

When a positive decision height has been selected on the related EFIS control panel, the letters DH and the decision height are displayed just above the digital radio altitude display of the associated ADI.

When descending through the selected decision height, a decision height alert occurs. The display changes from white to amber, increases in size and DH flashes momentarily

The decision height alert is reset if any one of the following occurs:

- the DH reset switch on the EFIS control panel is pressed
- the radio altitude increases to decision height +75 feet
- the radio altitude is equal to zero feet (i.e. during touchdown).

Pitch Limit Indicator

The position of the pitch limit indicator is a function of the stall warning computer. It is programmed so that stick shaker activation will coincide with a pitch attitude equal to the pitch limit indication.

Ground Speed Display

A digital presentation of the current ground speed is displayed. The ground speed data is received from the FMC or the IRS, with the FMC being the primary source.

Airspeed Display

The fast/slow airspeed indicator is positioned by the thrust management computer. For additional details see Chapter 4, Automatic Flight.

Airspeed is displayed on a tape on the ADI. The current Mach number is digitally displayed below the airspeed tape when the current Mach number is greater than 0.40.

The selected airspeed, takeoff and landing reference speeds, and flap maneuvering speeds are shown on the airspeed tape. Maximum and minimum airspeeds are also displayed on the airspeed tape.

CAUTION: Reduced maneuver capability exists when operating within the amber regions below the minimum maneuvering speed or above the maximum maneuvering speed. During non-normal conditions the target speed may be below the minimum maneuvering speed.

Horizontal Situation Indicator (HSI)

The HSI presents an electronically generated color display of navigational data. Each HSI is capable of displaying the airplane's progress on a dynamic map display.

Display Orientation

During normal operation, heading reference data is supplied to each HSI from the respective IRS.

The compass rose can be referenced to magnetic north or true north. The heading reference switch is used to manually select magnetic or true reference. The compass display is automatically referenced to true north when the airplane is operating within polar regions.

Track

Airplane track data is supplied by the FMC during normal operation and by the CDU when in alternate navigation.

MAP Mode

The MAP mode is recommended for most phases of flight.

Presented track up, this mode shows airplane position relative to the route of flight against a moving map background.

Presented heading up, this mode shows airplane position relative to the route of flight against a moving map background.

Displayed information can include:

- track
- heading
- wind
- routes
- position trend vector
- altitude range arc
- estimated time of arrival
- selected navigation data points programmed in the FMC

VOR Mode

The VOR mode is presented heading up. The VOR mode displays track, heading, and wind speed and direction with VOR navigation information.

APP Mode

The APP mode is presented heading up. The APP mode displays track, heading, and wind speed and direction with ILS approach information.

PLAN Mode

The PLAN mode is presented true north up. The active route may be viewed using The STEP prompt on the LEGS pages.

Weather Radar Display

Display of weather radar returns on the HSI is enabled or disabled by the WXR switch on the respective EFIS control panel. The weather radar system is described in Chapter 11, Flight Management, Navigation.

Terrain Display

The HSI can display look ahead terrain alerting. For detailed information, refer to Chapter 15, Warning Systems.

Traffic

Traffic information from the TCAS can be displayed on the HSI. TCAS is described in Chapter 15, Warning Systems.

Predictive Windshear

The HSI can display predictive windshear warnings. For detailed information, refer to Chapter 15, Warning Systems.

EFIS Failure Flags and Annunciations

In addition to the normal EFIS displays, various failure annunciations, flags, or indications may be displayed on the ADI or HSI.

The location of the different failure flags and annunciations is depicted in the ADI and HSI Failure Flags and Annunciations figures included in the EFIS Controls and Indicators, section 10 of this chapter.

Not all EFIS displays will be replaced by a failure flag or annunciation if the signal from the sending unit has failed. In these instances, failure is indicated by removal of the data or the affected portions of the display.

During preflight, heading/track data is unavailable until the associated IRS has completed alignment and entered the navigation mode. Heading flags do not appear in this case.

If an FMC FAIL message is observed on a CDU, a MAP flag will appear on the associated HSI when viewing the MAP mode. Selecting the opposite FMC with the NAV selector will restore the map display. If both FMCs fail, selecting CDU on the NAV selector will allow the CDU to provide limited map data to the HSI. For more detailed information on the alternate navigation system, refer to Chapter 11, Flight Management, Navigation.

Various fault messages can also be displayed. For example, a WXR/MAP RANGE DISAGREE message is displayed when the ranges for the FMC and weather radar disagree with the range selected on the HSI control panel.

An EXCESS DATA message is displayed if the quantity of information to the display exceeds the HSI's capability to provide a normal display. If in the MAP mode, deselecting the Map switches may correct the condition and remove the message.

Light Sensing and Brightness Control

Ambient light sensors automatically adjust the brightness of the EFIS displays. Once the desired brightness is set, using the EFIS brightness controls, little or no adjustment is needed throughout a wide range of ambient light conditions both outside and inside the flight deck.

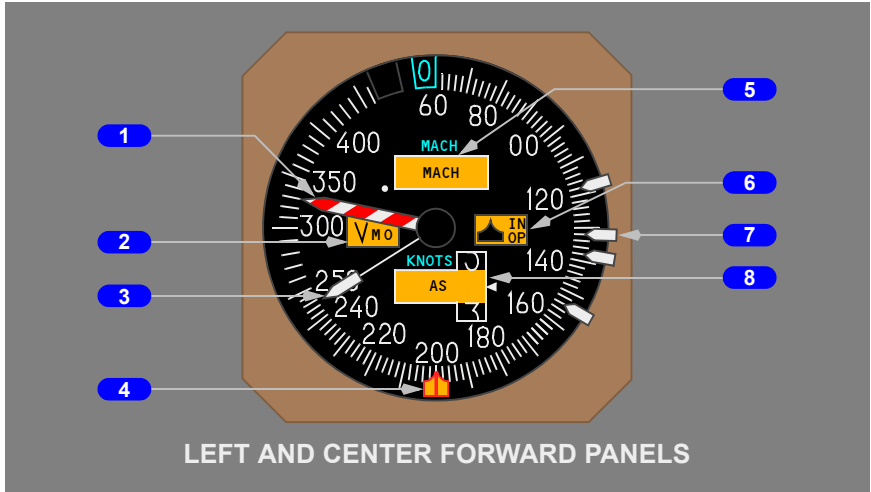
Conventional Flight Instruments**Mach/Airspeed Indicator (Electric)****1 Vmo Pointer**

Indicates the maximum operating airspeed in knots.

2 Vmo Flag

Flag in view – indicates the Vmo pointer is inoperative.

3 Airspeed Pointer

Indicates airspeed in knots.

4 Command Airspeed Bug

Indicates airspeed as manually selected with the IAS/MACH selector.

- positioned by FMC when IAS/MACH window is blank
- removed from view when inoperative.

5 Mach Indicator and Flag

Displays Mach number.

Display range:

- .400 to .999 Mach
- masked below .400 Mach
- flag in view – air data system is inoperative.

6 Command Airspeed Inoperative Flag

Flag in view – command airspeed bug is inoperative.

7 Reference Airspeed Bugs

Set at reference airspeeds.

8 Airspeed Indicator and Flag

- displays airspeed when above 30 knots
- flag in view – air data system is inoperative.

Primary Altimeter (Electric)



1 Altitude Indicator

Indicates altitude in increments of twenty feet.

OFF flag in view– the altimeter is inoperative

NEG flag in view – displays in the two left-hand windows when altitude below zero feet is displayed.

2 Altitude Pointer

Makes one revolution each one thousand feet.

3 Barometric Setting Control

Rotate – adjusts barometric settings.

4 Altimeter Altitude (ALT) Light

Illuminated (white) –

- between 300 and 900 feet of the altitude selected with the altitude selector

5 Barometric Setting Window

Displays barometric correction (in millibars and inches of mercury) as set by the barometric setting control.

6 Reference Altitude Marker

Manually positioned to the desired reference altitude using the reference altitude marker control.

7 Reference Altitude Marker Control

Used to manually set the reference altitude marker.

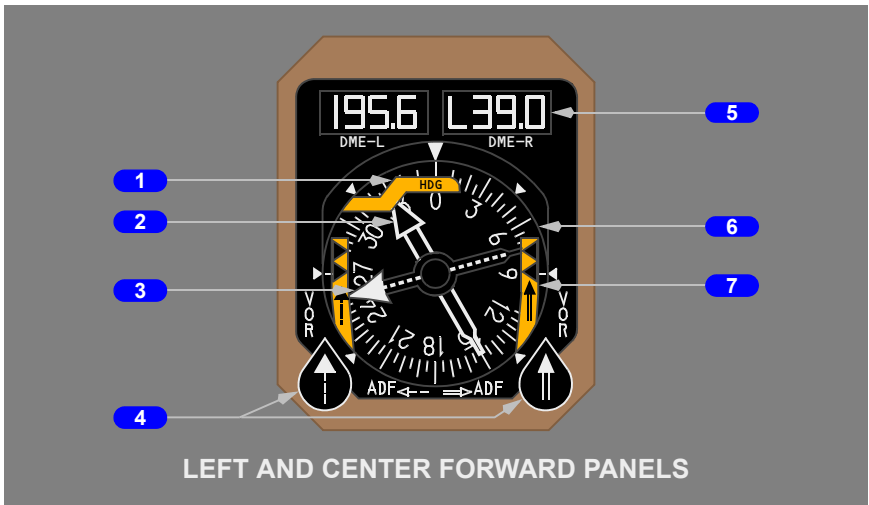
Radio Distance Magnetic Indicator**1 Heading (HDG) Flag**

Flag in view –

- selected IRS heading source has failed, or no computed data is available
- instrument failure.

2 Wide Bearing Pointer

- indicates right ADF/VOR magnetic bearing to selected station
- maintains last known bearing on loss of right ADF/VOR signal.

3 Narrow Bearing Pointer

- indicates left ADF/VOR magnetic bearing to selected station
- maintains last known bearing on loss of left ADF/VOR signal.

4 VOR/ADF Selector (Left/Right)

Rotate – selects related VOR or ADF for the bearing pointer.

5 Left/Right DME (DME –L/R) Indicators

Displays distance to the VOR–tuned station (VORTAC or VOR/DME) in nautical miles, except when APP is selected on the associated (L or R) EFIS control panel.

- displays distance to the ILS–tuned station when APP is selected on the associated (L or R) EFIS control panel (L is displayed when valid ILS/DME is available)
- displays dashes when no computed data is available
- displays blank when DME distance is unreliable, or when there are no DME nav aids within range for autotuning

6 Compass Card

Indicates airplane heading under lubber line.

- Captain’s heading information as selected by the first officer’s IRS switch
- First officer’s heading information as selected by the captain’s IRS switch

7 Bearing Pointer Failure Flag (Left/Right)

Selected VOR/ADF receiver has failed, or no computed data is available.

- may be in view with heading flag
- instrument failure.

Vertical Speed Indicator

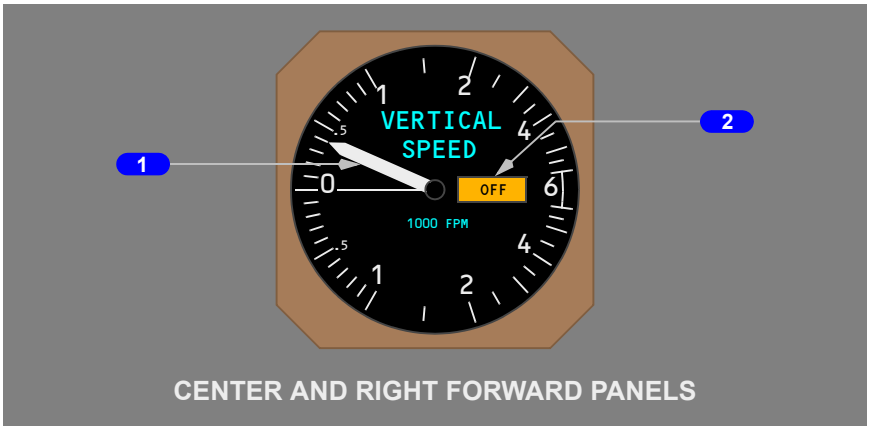

1 Vertical Speed Pointer

Indicates rate of climb or descent from 0 to 6,000 feet per minute.

2 OFF Flag

Flag in view – VSI is inoperative.

Clock

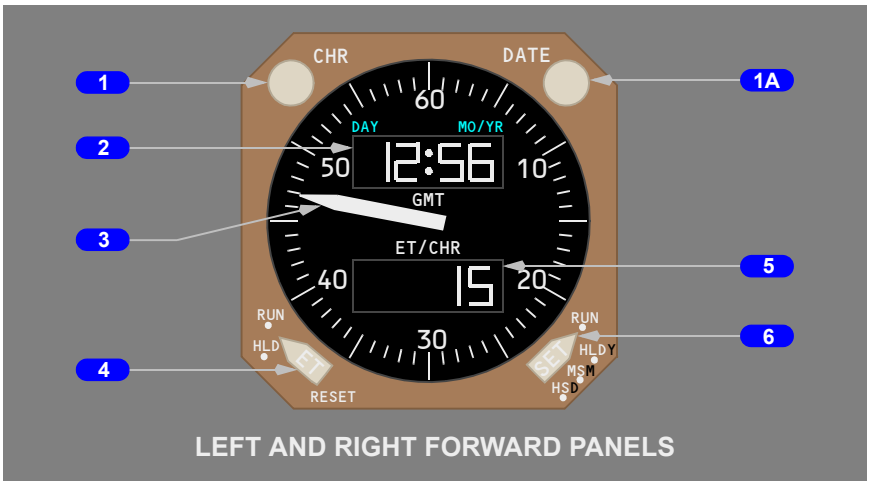

1 Chronograph (CHR) Switch

Push – initiates start, stop and reset functions of the CHR display and second hand
Subsequent pushes –

- overrides any existing ET display
- controls chronograph second hand.

1A DATE Switch

Push – displays day and month, alternating with year.

Subsequent push – returns display to time.

2 Time/Date Window

Displays time (hours, minutes – 24 hour format) when time is selected with the date switch.

Alternately displays day–month and year when date is selected with the date switch.

3 Chronograph Second Hand

Indicates seconds.

4 Elapsed Time (ET) Selector

Controls the elapsed time function.

RUN – starts the elapsed time display.

HLD – stops the elapsed time display.

RESET – (spring-loaded to HLD) returns ET display to zero.

5 Elapsed Time/Chronograph (ET/CHR) Window

Displays elapsed time in hours and minutes, or chronograph minutes.

- when selected, the chronograph display replaces the elapsed time display
- elapsed time continues to run in the background and displays after the chronograph is reset.

6 SET Selector

Sets the time and date when the date switch is set to manual

RUN – starts the time indicator.

HLDY (hold, year) –

- stops the time indicator and sets the seconds to zero when time is selected with the date switch
- advances years when date is selected with the date switch.

MSM (minute slew, month) –

- advances minutes when time is selected with the date switch
- advances months when date is selected with the date switch.

HSD (hour slew, day) –

- advances hours when time is selected with the date switch
- advances days when date is selected with the date switch

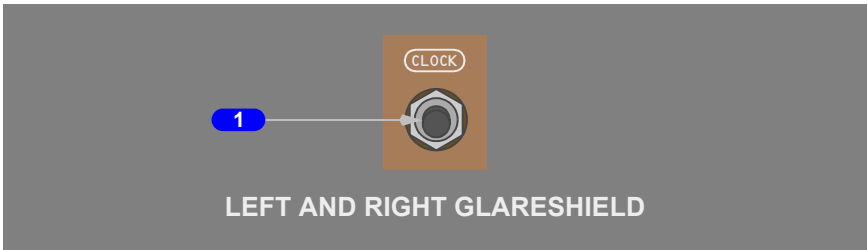

1 CLOCK Switch

Operates the same as the chronograph switch.

Standby Flight Instruments

Standby Attitude Director Indicator (Standby ADI)

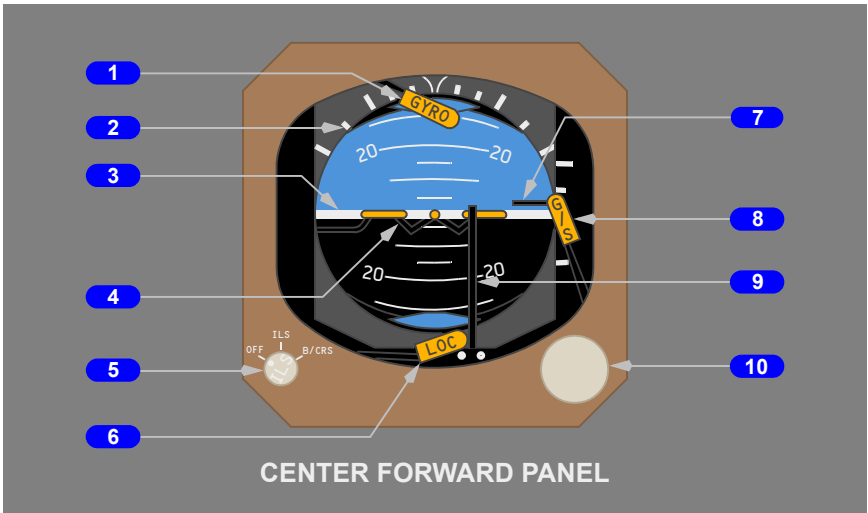

1 GYRO Flag

Flag in view – attitude is unreliable.

2 Bank Indicator and Scale

Indicates bank in reference to the bank scale.

3 Horizon Line and Pitch Angle Scale

Indicates horizon relative to the airplane symbol.

Pitch scale is in 5 degree increments.

4 Airplane Symbol

Indicates airplane attitude with reference to the horizon.

5 ILS Selector

OFF – deviation pointers and failure flags retracted from view.

ILS – pointers indicate deviation from localizer and glideslope.

B/CRS – reverses sensing for localizer deviation pointer.

6 Localizer (LOC) Flag

Flag in view – center localizer receiver has failed.

7 Glideslope Pointer and Deviation Scale

The glideslope pointer indicates glideslope position relative to the airplane.

- scale indicates deviation
- pointer is not displayed when ILS selector is OFF or no computed data exists.

8 Glideslope (G/S) Flag

Flag in view – center glideslope receiver has failed.

9 Localizer Pointer and Deviation Scale

The localizer pointer indicates position relative to the airplane.

- scale indicates localizer deviation
- expanded localizer scale not available
- pointer not displayed when ILS selector is OFF or no computed data exists.

10 Caging Control

Pull – aligns horizon with the airplane symbol.

Standby Airspeed Indicator (Pneumatic)

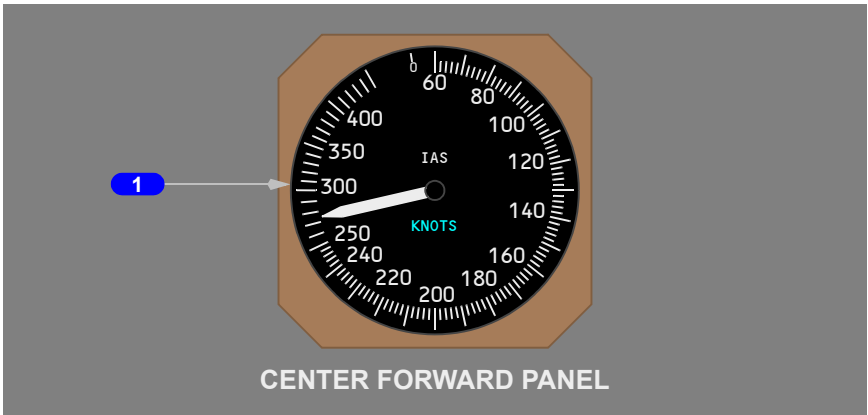

1 Standby Airspeed Indicator

Provides alternate airspeed information.

Standby Altimeter (Pneumatic)

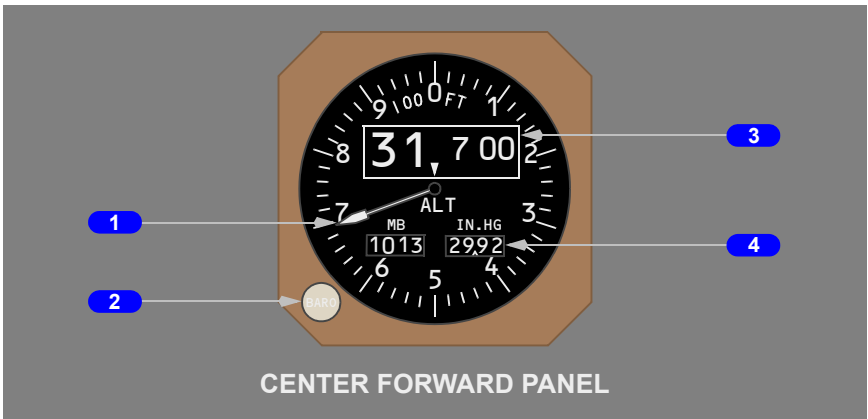

1 Altitude Pointer

Makes one revolution each one thousand feet.

2 Barometric Setting Control

Rotate – adjusts barometric settings.

3 Altitude Indicator

Indicates altitude in increments of twenty feet.

4 Barometric Setting Window

Displays barometric correction (in millibars and inches of mercury) as set by the barometric setting control.

Standby Magnetic Compass



1 Standby Magnetic Compass

Displays magnetic heading.

Flight Recorder

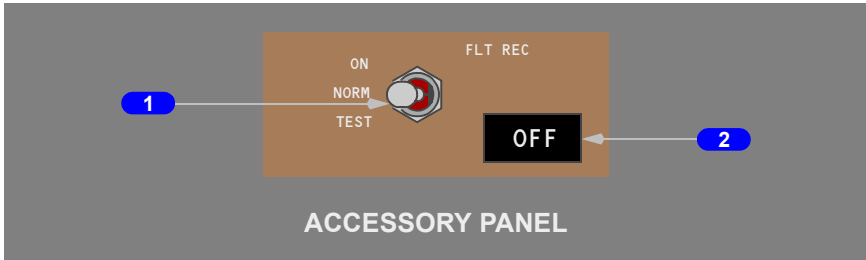

1 Flight Recorder (FLT REC) Switch

ON – applies power to the flight recorder.

NORM –

- in flight – the recorder operates anytime electrical power is available
- on the ground – either engine must also be operating.

TEST – (Spring – loaded to NORM) initiates a flight recorder test.

2 Flight Recorder OFF Light

Illuminated (white) – indicates the recorder is not operating or the test is invalid.

Introduction

The conventional instruments provide information in addition to the EFIS displays to aid pilots in controlling the airplane throughout its flight regime. This section includes a discussion of the primary instruments, standby instruments, and the pitot static system.

Primary Flight Instruments

Mach/Airspeed Indicator

Two electric mach/airspeed indicators display airspeed, mach, and V_{mo} from the selected air data source. The V_{mo} pointer indicates the maximum operating airspeed in knots or the equivalent to the maximum operating mach number. The command airspeed bug on each indicator can be automatically positioned from the FMC, or manually from the MCP IAS/MACH Selector.

Primary Altimeter

Two electric altimeters indicate current altitude in feet. An altimeter altitude light is provided. Altitude alerting is described in Chapter 15, Warning Systems.

Radio Distance Magnetic Indicator (RDMI)

Two radio distance magnetic indicators are installed. Each displays magnetic heading or true heading, VOR or ADF bearing, and (VOR/ILS/DME, VORTAC) distance. The RDMI receives primary heading signals from the opposite side IRS and alternate heading signals from the C-IRS. The RDMI is inoperative until the associated IRS has completed alignment and entered the navigation mode.

With the heading reference switch in NORM, magnetic heading is displayed if the airplane is outside polar regions. In polar regions, a heading flag shows. When the switch is in TRUE, true heading is displayed regardless of latitude. For more information on polar regions refer to Chapter 11, Flight Management, Navigation.

When the RDMI is referenced to true north, positioning an ADF/VOR selector to VOR causes the associated pointer failure flag to appear.

Vertical Speed Indicator

Two electrically-driven vertical speed indicators (VSI) are installed. The captain's VSI is connected to the left IRS and ADC, and the first officer's VSI is connected to the right IRS and ADC. The center IRS provides backup vertical speed data for either crew member when ALTN is selected with the respective IRS switch. The opposite ADC provides backup vertical speed data for either crewmember when ALTN is selected with the respective AIR DATA switch.

The VSI is inoperative until the associated IRS has completed alignment and entered the navigation mode.

Standby Flight Instruments

Standby Attitude Director Indicator (Standby ADI)

A self-contained standby attitude director indicator incorporating an ILS display is installed. In the event that all generator power is lost, the standby ADI will be supplied with electrical power from the standby DC bus. ILS information is provided from the C-ILS receiver.

Standby Airspeed Indicator (Pneumatic)

The standby airspeed indicator provides current airspeed in knots. It is connected directly to the L AUX PITOT and the alternate static ports. (See pitot-static system schematic.)

Standby Altimeter (Pneumatic)

A single indicator is installed for standby reference. Input for the indicator is from the alternate static ports. (See pitot-static system schematic.)

Standby Magnetic Compass

A standard magnetic standby compass is provided. A card located near the compass provides heading correction factors.

Clock

Two electronic clocks are installed, with two digital displays on each clock. Either coordinated universal time (UTC) or local time may be set on the upper time display. The lower ET/CHR display is used for either elapsed time or the chronograph. Separate controls are provided for each display.

In addition to UTC and local time, the date may be set on the upper time display.

Flight Recorder

The flight recorder provides a permanent record of selected operational systems in a sealed, fire-resistant container. The recorder automatically turns on when either engine is operating or the airplane is in flight.

Air Data System

The air data system consists of the pitot-static system, one temperature probe (TAT), two angle of attack probes, two air data computers (ADCs), and electric flight instruments.

The system provides pitot and/or static pressure information to various flight instruments and airplane systems. Standby airspeed and altimeter indicators are also provided. The ADCs use air data information to provide input signals to certain flight instruments (electric mach/airspeed indicator, electric altimeter) and other using systems (AFDS, FMC, etc.). The left instruments use the left ADC and the right instruments use the right ADC. The opposite ADC is available as an alternate air data source.

Warning flags indicate instrument failure or unreliable data. When a malfunction occurs in instruments with failure monitors, warning flags appear.

The EICAS caution messages ALT DISAGREE or IAS DISAGREE display when there is a significant difference between the left and right air data information. These messages are inhibited at low altitude or when both pilots have the same air data source selected.

Pitot-Static System Schematic

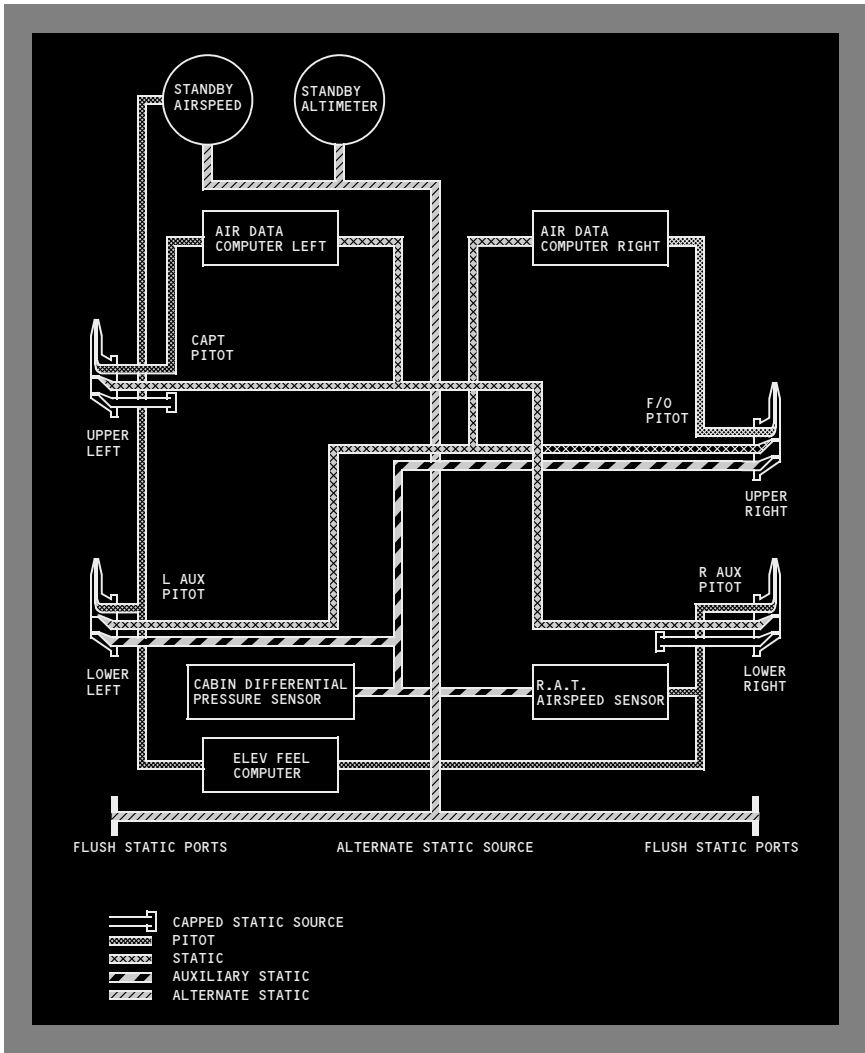

Total Air Temperature (TAT)

TAT appears on EICAS above the EPR display and is supplied by a thrust management or air data computer. The TAT indication is comprised of outside air temperature (OAT) plus ram rise. TAT Indication on the ground will approximate OAT.

True Airspeed/Static Air Temperature (TAS/SAT)

True airspeed (TAS) and static air temperature (SAT) are displayed on the PROGRESS page.

Intentionally
Blank

Flight Instruments, Displays EICAS Messages

Note: The OVERSPEED warning and the ALTITUDE ALERT caution messages are covered in Chapter 15, Warning Systems.

The following EICAS messages can be displayed.

| Message | Level | Light | Aural | Condition |
|----------------|--------------|--------------|--------------|--|
| ALT DISAGREE | Caution | | Beeper | Captain's and first officer's altitude indications disagree. |
| ATT DISAGREE | Caution | | Beeper | Captain's and first officer's attitude indications disagree. |
| IAS DISAGREE | Caution | | Beeper | Captain's and first officer's airspeed indications disagree. |
| INSTR SWITCH | Caution | | Beeper | Both EFI switches are in the ALTN position. |

Intentionally
Blank

Controls and Indicators 11.10

- Flight Management System 11.10.1
 - Control Display Unit (CDU) 11.10.1
 - Function and Execute Keys 11.10.2
 - Alpha/Numeric and Miscellaneous Keys 11.10.4
 - CDU Page Components 11.10.5
 - FMC Annunciator Light 11.10.6
- Inertial System 11.10.7
 - Inertial Reference System 11.10.7
- Radio Navigation Systems 11.10.10
 - Automatic Direction Finding (ADF) Control 11.10.10
 - Transponder Panel 11.10.10
 - ILS Control Panel 11.10.11
 - VOR Control Panel 11.10.12
 - Marker Beacon Lights 11.10.14
- Weather Radar 11.10.14
 - Weather Radar Control Panel 11.10.14
 - Weather Radar Switch 11.10.16

Navigation Systems Description 11.20

- Introduction 11.20.1
- Navigation Systems Flight Instrument Displays 11.20.1
- Inertial Reference System 11.20.1
 - Inertial Reference System Operation 11.20.1
 - IRS Alignment 11.20.1
 - IRS Attitude 11.20.3
 - IRS Power 11.20.3
- Radio Navigation Systems 11.20.3
 - Automatic Direction Finding (ADF) 11.20.3
 - Distance Measuring Equipment (DME) 11.20.3
 - VOR 11.20.4
 - Marker Beacon 11.20.5

| | |
|---|--------------|
| Multi-Mode Receiver | 11.20.5 |
| Instrument Landing System (ILS). | 11.20.5 |
| Global Positioning System (GPS) | 11.20.5 |
| GPS Displays | 11.20.5 |
| GPS Data | 11.20.6 |
| GPS System Schematic | 11.20.7 |
| Transponder | 11.20.7 |
| Weather Radar | 11.20.8 |
| Flight Management System Description | 11.30 |
| Introduction | 11.30.1 |
| Flight Management Computer (FMC) | 11.30.1 |
| Control Display Units (CDUs) | 11.30.2 |
| Flight Management System Operation | 11.31 |
| Introduction | 11.31.1 |
| Preflight | 11.31.1 |
| Takeoff | 11.31.2 |
| Climb | 11.31.2 |
| Cruise | 11.31.2 |
| Descent | 11.31.2 |
| Approach | 11.31.2 |
| Flight Complete | 11.31.2 |
| Operational Notes | 11.31.2 |
| Terminology | 11.31.3 |
| Navigation Position | 11.31.4 |
| FMC Position Determination | 11.31.5 |
| FMC Polar Operations | 11.31.6 |
| Navigation Performance | 11.31.7 |
| Lateral Navigation (LNAV) | 11.31.8 |
| Waypoints | 11.31.8 |
| EO SID | 11.31.14 |
| Map Displays | 11.31.15 |

767 Flight Crew Operations Manual

| | |
|--|--------------|
| Vertical Navigation (VNAV) | 11.31.15 |
| Speed/Altitude Constraints | 11.31.15 |
| Takeoff and Climb | 11.31.17 |
| Cruise | 11.31.19 |
| Mode Control Panel Speed Intervention | 11.31.20 |
| Descent | 11.31.20 |
| Early Descent | 11.31.22 |
| Approach | 11.31.24 |
| Missed Approach | 11.31.25 |
| Cruise and Descent Profile (Nonprecision Approach) | 11.31.26 |
| VNAV Engine Out Operation | 11.31.28 |
| Data Entry Rules | 11.31.30 |
| Altitude Entry | 11.31.30 |
| Airspeed Entry | 11.31.31 |
| Data Pairs | 11.31.31 |
| Flight Management Computer | 11.32 |
| FMC Databases | 11.32.1 |
| Thrust Management | 11.32.1 |
| Fuel Monitoring | 11.32.2 |
| Loss of FMC Electrical Power | 11.32.3 |
| FMC Failure | 11.32.3 |
| Single FMC Failure | 11.32.3 |
| Dual FMC Failure | 11.32.3 |
| FMC Resets | 11.32.4 |
| FMC Preflight | 11.40 |
| Introduction | 11.40.1 |
| Preflight Page Sequence | 11.40.1 |
| Minimum Preflight Sequence | 11.40.2 |
| Supplementary Pages | 11.40.2 |
| Preflight Pages | 11.40.3 |
| Initialization/Reference Index Page | 11.40.3 |
| Identification Page | 11.40.5 |

| | |
|------------------------------------|--------------|
| Position Initialization Page | 11.40.7 |
| Position Reference Pages | 11.40.10 |
| Route Page | 11.40.16 |
| Preflight Pages – Part 2 | 11.40.22 |
| Departure/Arrival Index Page | 11.40.22 |
| Departures Page | 11.40.23 |
| Navigation Radio Page | 11.40.26 |
| Performance Initialization Page | 11.40.27 |
| Takeoff Reference Page | 11.40.29 |
| Menu Page | 11.40.32 |
| FMC Takeoff and Climb | 11.41 |
| Introduction | 11.41.1 |
| Takeoff Phase | 11.41.1 |
| Climb Phase | 11.41.1 |
| Climb Page | 11.41.2 |
| Engine Out Climb | 11.41.5 |
| Route Legs Page | 11.41.6 |
| Engine Out Departure | 11.41.10 |
| Air Turnback | 11.41.10 |
| Arrivals Page | 11.41.10 |
| FMC Cruise | 11.42 |
| Introduction | 11.42.1 |
| LNAV Modifications | 11.42.1 |
| RTE LEGS Page Modifications | 11.42.1 |
| Add Waypoints | 11.42.2 |
| Delete Waypoints | 11.42.3 |
| Change Waypoint Sequence | 11.42.4 |
| Remove Discontinuities | 11.42.5 |
| Direct To And Intercept Course To | 11.42.7 |
| Intercept Course From | 11.42.8 |
| SELECT DESIRED Waypoint (WPT) Page | 11.42.11 |
| Airway Intercept | 11.42.13 |

767 Flight Crew Operations Manual

| | |
|---|--------------|
| Route Offset | 11.42.15 |
| Cruise Page | 11.42.16 |
| All Engine Cruise | 11.42.16 |
| Engine Out Cruise | 11.42.19 |
| VNAV Modifications | 11.42.22 |
| Cruise Climb | 11.42.22 |
| Planned Step Climb | 11.42.22 |
| Calculated Step Climb | 11.42.23 |
| Cruise Descent | 11.42.26 |
| Early Descent | 11.42.27 |
| Navigation Data | 11.42.27 |
| Reference Navigation Data Page | 11.42.27 |
| Fix Information Page | 11.42.30 |
| In-Flight Position Update | 11.42.32 |
| Route and Waypoint Data | 11.42.33 |
| Route Data Page | 11.42.33 |
| Wind Data | 11.42.34 |
| Wind Page | 11.42.35 |
| Progress Pages | 11.42.37 |
| Progress Page 1 | 11.42.37 |
| Progress Page 2 | 11.42.39 |
| Position Report Page | 11.42.42 |
| FMC Descent and Approach | 11.43 |
| Introduction | 11.43.1 |
| Early Descent | 11.43.1 |
| Descent | 11.43.1 |
| Descent Page | 11.43.1 |
| Descent Forecast Page | 11.43.4 |
| Offpath Descent Page | 11.43.6 |
| Engine Out Descent | 11.43.8 |
| Approach | 11.43.8 |
| Arrivals Page – IFR Approaches | 11.43.8 |
| Vertical Angle Display on the Route Legs Page | 11.43.10 |

| | |
|--|--------------|
| Arrivals Page – VFR Approaches | 11.43.11 |
| Approach Reference Page | 11.43.13 |
| Alternate Airport Diversions | 11.43.15 |
| Alternate Page | 11.43.15 |
| XXXX Alternate Page | 11.43.18 |
| Holding | 11.43.21 |
| Hold Page (First Hold) | 11.43.22 |
| Hold Page (Existing Hold) | 11.43.26 |
| FMS Alternate Navigation System Description | 11.50 |
| Introduction | 11.50.1 |
| Alternate Navigation Waypoints | 11.50.1 |
| Alternate Lateral Navigation | 11.50.1 |
| Route Changes | 11.50.1 |
| Course Reference | 11.50.2 |
| Alternate Navigation CDU Pages | 11.50.2 |
| IRS Legs Page | 11.50.3 |
| IRS Progress Page | 11.50.4 |
| EICAS Messages | 11.60 |
| EICAS and CDU Messages | 11.60.1 |
| FMC Messages | 11.60.2 |
| FMC Alerting Messages | 11.60.2 |
| FMC Advisory Messages | 11.60.4 |
| CDU Annunciator Lights | 11.60.6 |

**Flight Management System
Control Display Unit (CDU)**

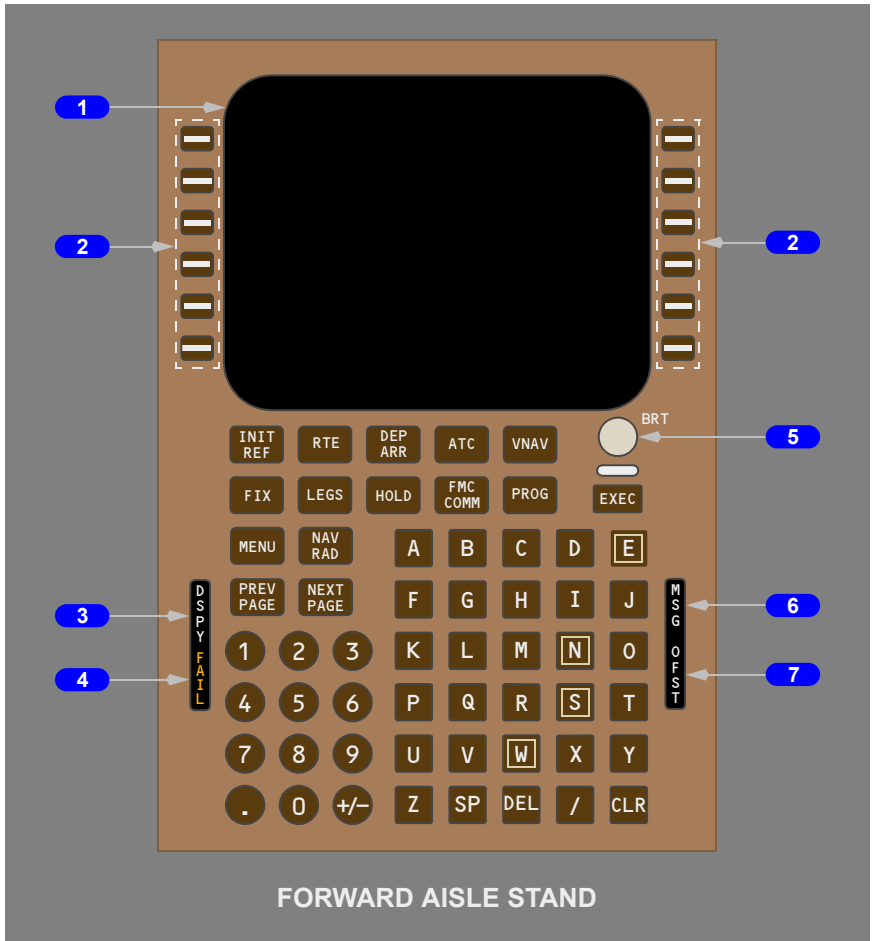

1 Control Display Unit (CDU) Display

Displays CDU data pages.

2 Line Select Keys

Push –

- moves data from scratchpad to selected line
- moves data from selected line to scratchpad
- selects page, procedure, or performance mode as applicable
- deletes data from selected line when DELETE is shown in scratchpad.

3 Display (DSPY) Light

Illuminated (white) –

- when RTE page 3 or greater, RTE LEGS page 2 or greater, RTE DATA page 2 or greater is shown
- when airplane is not in holding pattern shown on HOLD page
- when modification is in progress, and any RTE, RTE LEGS, RTE DATA, HOLD, CLB, CRZ, or DES page is shown.

4 FAIL Light

Illuminated (amber) – fault detected in related FMC.

5 Brightness Control

Rotate – controls display brightness.

6 Message (MSG) Light

Illuminated (white) – scratchpad message is shown.

7 Offset (OFST) Light

Illuminated (white) – LNAV gives guidance for lateral route offset.

Function and Execute Keys

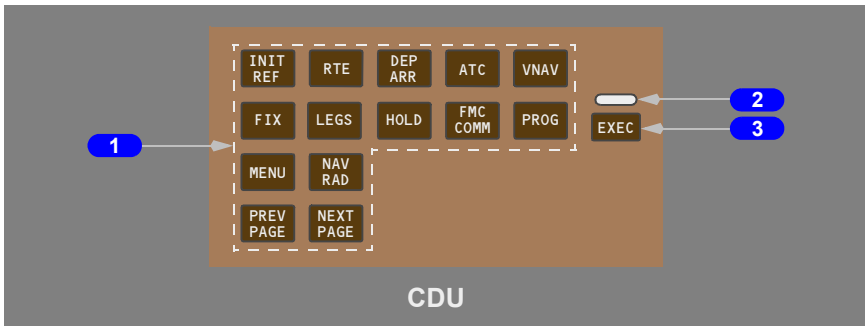

1 CDU Function Keys

Push –

- INIT REF – displays page for data initialization or for reference data
- RTE – displays page to input or change origin, destination, or route
- DEP ARR – displays page to input or change departure and arrival procedures
- ATC – displays ATC datalink pages (function inoperative)
- VNAV – displays page to view or change vertical navigation path data
- FIX – displays page to create reference points on the map display
- LEGS –
 - displays page to evaluate or modify lateral and vertical route data
 - displays page to control the center point on the PLAN mode display
- HOLD – displays page to create holding patterns and show holding pattern data
- FMC COMM – displays FMC data link status page (function inoperative)
- PROG – displays page to view dynamic flight and navigation data, including waypoint and destination ETAs, fuel remaining, and arrival estimates
- MENU – displays page to choose subsystems controlled by CDU
- NAV RAD – displays page to monitor or control VOR tuning
- PREV PAGE – displays previous page of related pages (for example, LEGS pages)
- NEXT PAGE – displays next page of related pages.

2 Execute Light

Illuminated (white) – active data is modified but not executed.

3 Execute (EXEC) Key

Push –

- makes data modification(s) active
- extinguishes execute light.

Alpha/Numeric and Miscellaneous Keys

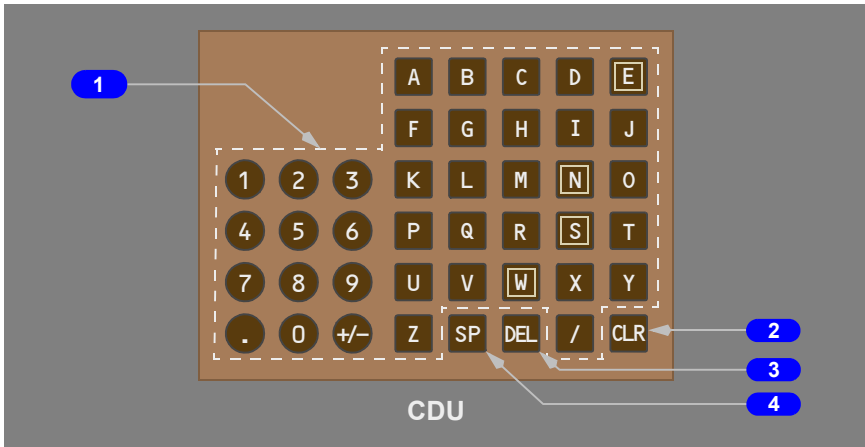

1 Alpha/Numeric Keys

Push –

- puts selected character in scratchpad
- Slash (/) key – puts "/" in scratchpad
- Plus Minus (+/-) key – first push puts "-" in scratchpad. Subsequent pushes alternate between "+" and "-".

2 Clear (CLR) Key

Push –

- if scratchpad message is present – clears scratchpad message.
- if scratchpad entry in progress – clears last scratchpad character

Push and hold – clears all scratchpad data.

3 Delete (DEL) Key

Push – enters "DELETE" in scratchpad.

4 Space (SP) Key

Push – puts space in scratchpad.

Note: The SP key is normally used when keying in messages for datalink communications. If the SP key is inadvertently pressed while keying in data for FMC use, it will result in an INVALID ENTRY scratchpad message when attempting to select the data to the appropriate line. Should this occur, clear the scratchpad and begin again.

CDU Page Components



1 Page Title

Subject or name of data shown on page.

ACT (active) or MOD (modified) displays whether page contains active or modified data.

2 Line Title

Title of data on line below.

3 Line

Displays –

- prompts
- selectors
- data.

4 Prompts

Show pages, select modes, and control displays. Caret, "<" or ">", is displayed before or after the prompt adjacent to the related line select key.

5 Page Number

Left number is page number. Right number is total number of related pages. Page number is blank when only one page exists.

6 Boxes

Data input is mandatory.

7 Dashes

Data input is optional. The data is not mandatory.

8 Scratchpad

Displays messages, alphanumeric entries or line selected data.

FMC Annunciator Light

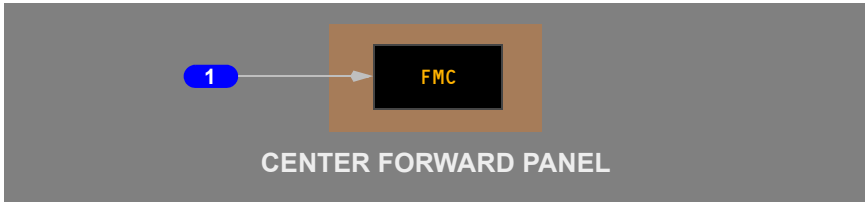

1 FMC Annunciator Light

Illuminated (amber) –

- CDU is displaying an operationally significant message in the scratchpad
- pushing CDU CLR key extinguishes the light and clears the scratchpad message

Inertial System

Inertial Reference System

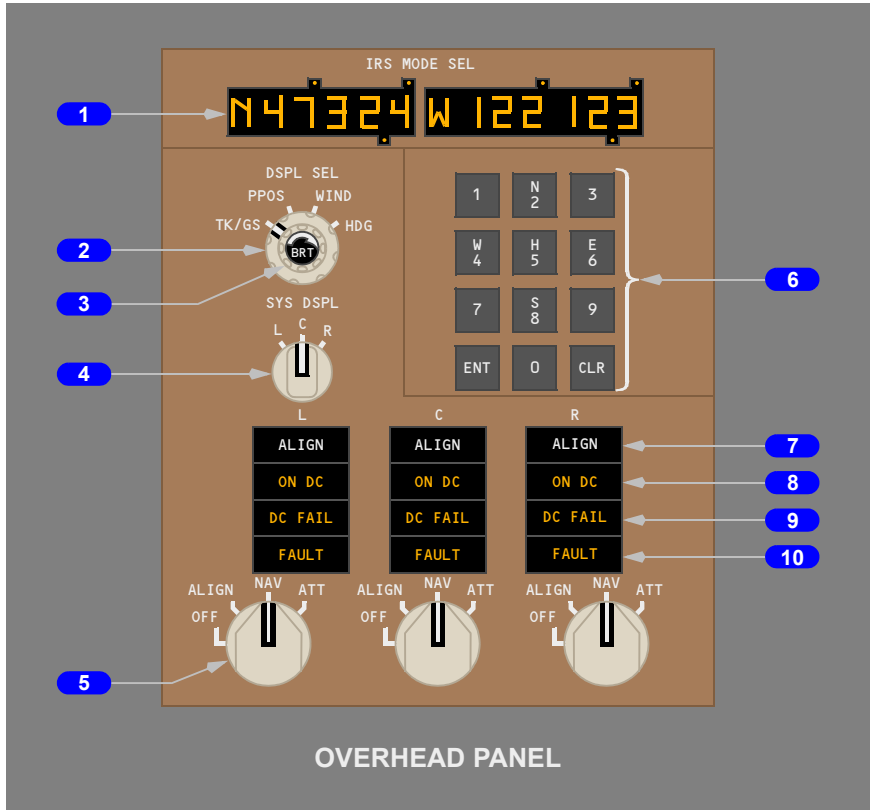

1 IRS DISPLAY

Displays track, groundspeed, present position, wind or heading as controlled by display selectors or keyboard.

2 IRS Display Selector

Selects data for display when keyboard not in control.

- TK/GS – displays present true track and groundspeed
- PPOS – displays present position
- WIND – displays present true wind when inflight
- HDG – displays present true heading.

3 Brightness Control

Rotate – controls intensity of display.

4 IRS System Display Selector

Selects system to display data when keyboard not in control.

5 IRS Mode Selectors

Rotate – controls mode of related IRS.

Must be pulled out to move from NAV position.

OFF –

- alignment is lost
- ALIGN light illuminates for 30 seconds as system goes through a shutdown sequence
- realignment requires about 10 minutes while the airplane is parked and entry of present position (latitude and longitude).

ALIGN –

- initiates alignment when parked
- initiates a quick alignment if selected when the system is in the navigation mode.

NAV –

- normal operational mode
- permits system to enter NAV mode after completing alignment
- initiates a 10 minute alignment if selected from OFF.

ATT –

- provides only attitude and heading information
- position and ground speed information lost until system realigned on ground
- when selected airborne, ALIGN light illuminates for 30 seconds while system senses local level (requires level flight)
- magnetic heading input required to initialize heading output
- the selector must be cycled through OFF to re-enter ALIGN or NAV mode.

6 IRS Keyboard

Push an alpha key to begin entry.

- pushing the N, S, E or W keys changes the IRS display to keyboard control and arms the keyboard for latitude or longitude entry
- pushing H changes the display to keyboard control and arms the keyboard for heading entry.

Enter (ENT) Key – push

- enters data from display into all three IRS systems
- restores display to the display selector setting

Clear (CLR) Key – push

- clears data keyed into display
- restores display to the display selector setting.

7 ALIGN Lights

Illuminated (white) –

- steady – the related IRS is operating in the ALIGN mode, the initial ATT mode, or the shutdown cycle
- flashing – alignment cannot be completed due to IRS detection of:
 - significant difference between previous and entered positions or an unreasonable present position entry
 - no present position entry.

Extinguished –

- IRS not in ALIGN mode
- with mode selector in NAV, alignment is complete, and all IRS information is available
- with mode selector in ATT, attitude information is available. Heading information is available following entry of initial magnetic heading.

8 ON DC Lights

Illuminated (amber) –

- normal AC power for the related IRS has failed and the IRS is operating on DC backup power from the hot battery bus (AC power not normal)
- if on the ground, the ground-call horn in the nose wheel well sounds, providing an alert that a battery drain condition exists
- EICAS advisory message L, C or R IRS ON DC is displayed
- momentary illumination is normal during alignment self-test.

9 DC FAIL Lights

Illuminated (amber) –

- DC backup power for the related IRS has failed
- if the other lights are extinguished, the IRS is operating normally on AC power.
- EICAS advisory message L, C or R IRS DC FAIL is displayed

10 FAULT Lights

Illuminated (amber) – a system fault affecting the related IRS ATT and/or NAV modes has been detected. The EICAS advisory message L, C or R IRS FAULT is also displayed.

Radio Navigation Systems

Automatic Direction Finding (ADF) Control

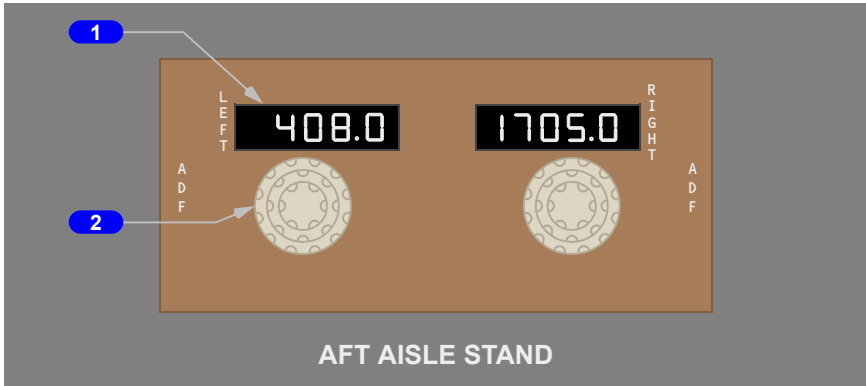

1 Frequency Indicators

Display the frequency selected with the related frequency selector.

2 Frequency Selectors

Rotate –

- outer knob sets the hundreds number
- middle knob sets the tens number
- inner knob sets the tenths and ones number.

Transponder Panel



767 Flight Crew Operations Manual**1 Transponder Mode Selector**

TEST – activates test.

STBY – deactivates transponder.

ALT RPTG OFF – activates transponder without altitude reporting if airplane is in-flight.

XPDR – activates transponder with altitude reporting if airplane is in-flight.

TA ONLY – activates TCAS Traffic Advisory (TA) mode and altitude reporting. (refer to Chapter 15, Warning Systems)

TA/RA – activates TCAS TA and Resolution Advisory (RA) modes. (refer to Chapter 15, Warning Systems)

2 Transponder Code Selector

Sets transponder code in transponder code window and both Transponders.

3 Transponder Code Window

Displays transponder code.

4 ATC FAIL Light

Illuminated (amber) – selected transponder has failed.

5 Transponder (XPDR) Selector

L or R – selects transponder for operation.

6 Identification (IDENT) Switch

Push – transmits an identification signal.

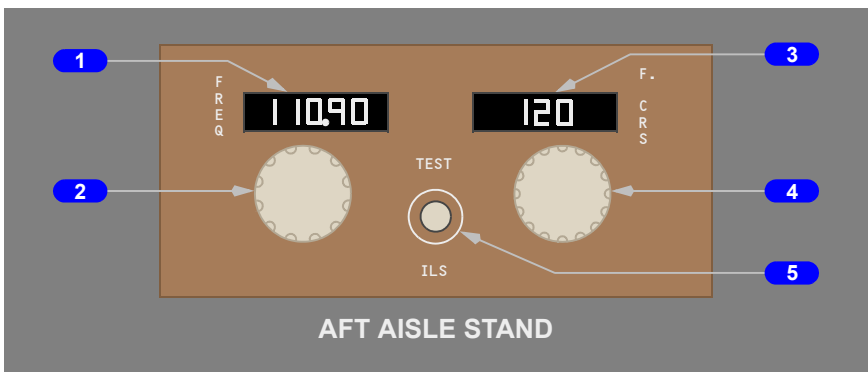
ILS Control Panel

1 ILS Frequency (FREQ) Indicator

Displays frequency tuned in all three ILS receivers or dashes (----) if the selector is in the standby position. The display is generated by the center ILS receiver.

2 ILS Frequency Selector

Rotate – tunes all ILS receivers.

- tuned frequency displayed in frequency indicator
- received data is displayed on the ADI
- if an ILS mode is selected on the HSI, ILS data is displayed on the related HSI and the associated DME is tuned to the ILS frequency
- VOR frequencies cannot be tuned
- frequency change is inhibited when all three autopilots are armed and either Localizer or Glideslope is captured
- dashes are displayed when turned to the standby position. ILS display symbology is removed from the ADI when dashes are displayed

3 ILS Front Course (F. CRS) Indicator

Displays the selected front course.

4 ILS Front Course Selector

Rotate – selects the ILS front course.

5 ILS Test Switch

Push – sends a test signal to all ILS receivers except during multiple autopilot approaches after either the localizer or glideslope is captured.

VOR Control Panel

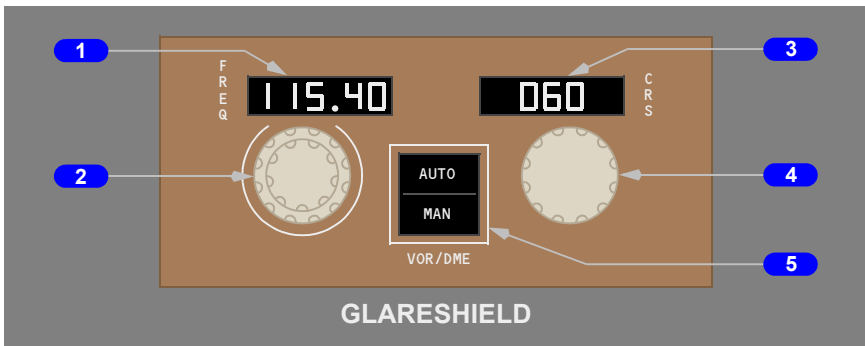

1 VOR Frequency (FREQ) Indicator

Indicates the frequency selected by the frequency selector.

2 VOR Frequency Selector

Rotate –

- when MAN light illuminated, tunes related VOR and also tunes DME if HSI mode selector is not in an ILS position
- ILS frequencies cannot be tuned.

3 VOR Course (CRS) Indicator

Displays course set by VOR course selector.

4 VOR Course Selector

ROTATE – sets course in VOR course indicator and EFIS.

5 VOR/DME Switch

Push –

- alternates VOR and DME tuning between the FMC (AUTO) automatic and VOR frequency selector (MAN) manual when the HSI mode selector is in a MAP or PLAN mode.
- only MAN available when the HSI is not in a MAP or PLAN mode.

AUTO Light illuminated (white) –

- FMC is tuning related VOR and DME
- HSI selector must be in a MAP or PLAN mode.

MAN Light illuminated (white) –

- VOR frequency selector is tuning VOR
- if the HSI mode selector is not in an ILS mode, the VOR frequency selector tunes the DME
- if the HSI mode selector is in an ILS mode, the ILS frequency selector tunes the DME.

Marker Beacon Lights

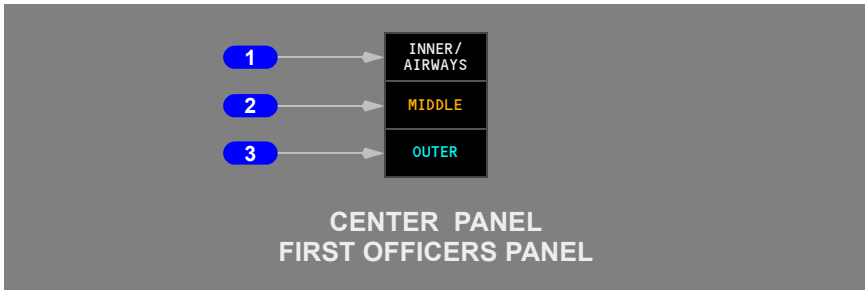

1 INNER/AIRWAYS

Illuminates (white) – over an inner or airways marker beacon.

2 MIDDLE

Illuminates (amber) – over a middle marker beacon.

3 OUTER

Illuminates (blue) – over an outer marker beacon.

Weather Radar

Weather Radar Control Panel



1 System (SYS) Switch

L – selects left weather radar system.

R – selects right weather radar system.

INOP – the right system is not installed.

767 Flight Crew Operations Manual**2 GAIN Control**

AUTO – normal operation, detent position provides automatic gain control calibrated for optimum return.

Rotate – provides manual control of radar gain. Gain increases as control is rotated clockwise toward MAX.

3 Mode Selector

TEST – activates system test.

WX – displays weather radar returns at selected gain level.

WX/TURB – displays weather radar returns plus turbulence. Turbulence is only displayed within 40 NM of the airplane.

MAP – displays ground returns.

4 TILT Control

Rotate clockwise – radar antenna tilts up to selected degrees from horizon.

Rotate counterclockwise – radar antenna tilts down to selected degrees from horizon.

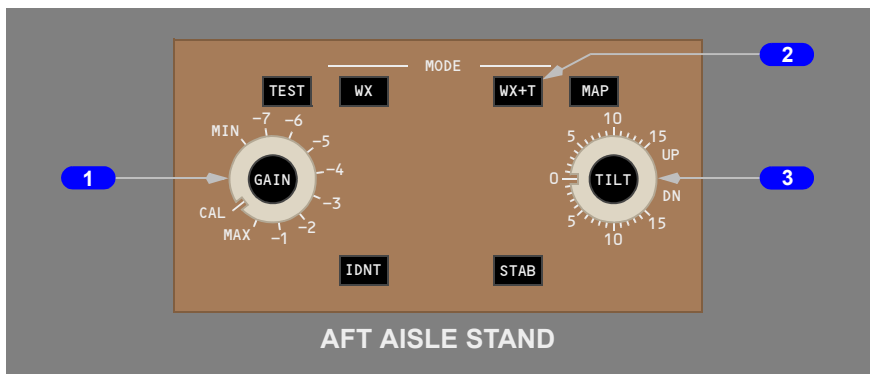
**1 GAIN Control**

CAL – normal operation, detent position provides automatic gain control calibrated for optimum return.

Rotate – provides manual control of radar gain. Gain increases as control is rotated clockwise toward MAX.

2 MODE Switches

TEST – activates system test.

WX – displays weather radar returns at selected gain level.

WX+T – displays weather radar returns plus turbulence. Turbulence is only shown on display ranges of 40 miles or less.

MAP – displays ground returns.

IDNT – suppresses ground returns. Normal operation is with this switch off because weather returns can also be suppressed.

STAB – activates antenna stabilization.

3 TILT Control

Rotate clockwise – radar antenna tilts up to selected degrees from horizon.

Rotate counterclockwise – radar antenna tilts down to selected degrees from horizon.

Weather Radar Switch

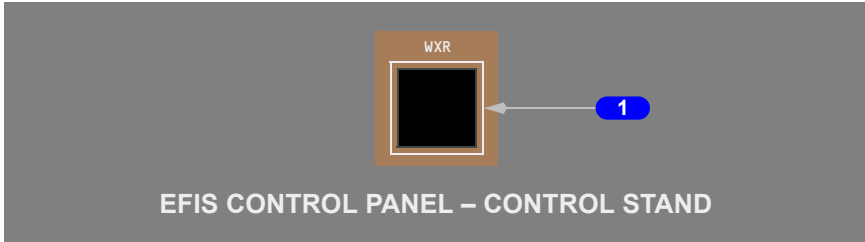

1 Weather Radar (WXR) Switch

Push – alternately selects the HSI radar display on and off. The radar transmitter is activated when the radar is displayed on either HSI.

Introduction

Navigation systems include the global positioning system (GPS), inertial reference system (IRS), VOR, DME, ILS, ADF, ATC transponder, weather radar, and the flight management system (FMS). The FMS is described in the Flight Management System Description section of this chapter.

The FMC will provide navigation guidance and map display between 87° North and 87° South latitudes.

Navigation Systems Flight Instrument Displays

Refer to Chapter 10, Flight Instruments, Displays for flight instrument display system operations and typical instrument displays.

Inertial Reference System

The inertial reference system (IRS) calculates airplane position, acceleration, track, vertical speed, ground speed, true and magnetic heading, wind speed and direction. It also supplies attitude data for the displays, flight management system, flight controls, engine controls, and other systems.

The IRS consists of three Inertial Reference Units (IRUs) and the IRS mode selector panel.

Inertial Reference System Operation

The Inertial Reference System is controlled by the IRS Mode Control Panel on the overhead panel. When operating in the navigation mode, the IRS provides attitude, acceleration, ground speed, track, true and magnetic heading, present latitude and longitude, and wind speed and direction to other systems.

Magnetic heading and track are not available in polar regions. Magnetic reference is provided between N73° and S60° latitude. Above these latitudes only true headings are available.

IRS Alignment

An IRS must be aligned before it can enter the NAV mode. Rotating the IRS mode selector from OFF to NAV begins the IRS alignment. The IRS performs a short power test, during which the ON DC light illuminates. When the ON DC light extinguishes the ALIGN light illuminates. Alignment requires approximately ten minutes.

Present position (latitude and longitude) must be entered on the CDU position initialization page to complete the alignment. If the present position cannot be entered through the CDU, it may be entered through the IRS mode selector keyboard.

If the latitude/longitude position is not near the origin airport, the CDU scratchpad message VERIFY POSITION is displayed. If the entered latitude/longitude position does not pass the IRS internal comparison tests, the scratchpad message ENTER IRS POSITION is displayed.

Alignment can be accomplished only when the airplane is parked. Alignment stops if an IRU detects motion during alignment. When the motion stops, some units automatically restart the alignment. Other units flash the ALIGN Light until the alignment is restarted. Manual restarts are accomplished by moving the IRS Mode Selector to OFF, then back to NAV after the ALIGN Light stops flashing.

The IRS is aligned when all IRUs enter the navigation mode. The latitude and longitude display on the SET IRS POS line of the CDU POS INIT page then blanks. Alignment is lost if the selector is moved out of the NAV position.

High Latitude Alignment

High latitude (between 70°~ 12.0' and 78°~ 15.0') alignments requires an extended alignment time. This extended alignment is accomplished by rotating the Mode Selector from OFF to the ALIGN position and allowing the IRS to align for a minimum of 17 minutes. Present position is entered while in the align mode. After the extended alignment, navigation mode is entered by rotating the mode selector to the NAV position.

Fast Alignment

Following operation in the navigation mode and with the airplane parked, performing a fast alignment removes accumulated track, ground speed, and attitude errors, levels the system, and updates present position. This is accomplished by positioning selectors to ALIGN, entering present position, and repositioning selectors to NAV. Fast alignment completes in approximately 30 seconds.

Fast alignment can be accomplished without entering present position. However, greater navigational accuracy is attained by entering present position.

A full alignment, accomplished by rotating the IRS mode selector to OFF and back to NAV, must be accomplished when the time from the last full alignment exceeds 18 hours.

IRS Attitude

If alignment is lost in flight, the navigation mode is inoperative for the remainder of the flight. Attitude information can be obtained by moving the selector to the attitude (ATT) position. The IRU enters the Align mode for 30 seconds during which the airplane should stay in straight and level flight. This re-levels the system and provides an attitude reference. Some attitude errors may occur during acceleration. After acceleration, errors are slowly removed.

Heading information can be provided in the ATT Mode if a heading entry is made on the CDU POS INIT page or IRS mode selector panel. Magnetic heading must be updated periodically.

IRS Power

Normally the IRSs operate on AC power from the left and right electrical systems. The main airplane battery is used as an alternate power source. The ON DC light illuminates and the EICAS message IRS ON DC is displayed when AC power is lost and DC power is being used. The DC FAIL light illuminates and the EICAS message IRS DC FAIL is displayed when DC power is lost and AC power is being used. Both lights extinguish if both AC and DC power are on or off.

If all AC power sources are lost the IRSs are powered by the Standby power system.

Standby power to the right IRS is limited to 5 minutes to save battery power.

Radio Navigation Systems

Automatic Direction Finding (ADF)

A dual ADF system is installed with the control panel located on the aft electronics panel.

The ADF bearing signals are displayed on pointers and flags on the HSIs and can also be displayed on the RDMIs.

Distance Measuring Equipment (DME).

Two DME systems are installed and each can be automatically tuned by the FMC or manually tuned by the VOR or ILS control panel.

DME Tuning

When the HSI Mode Selector is in the VOR or ILS position, the related panel tunes the DME. When the HSI selector is in the MAP or PLAN position automatic FMC tuning or manual VOR panel tuning can be selected with the MAN/AUTO switch on the VOR panel.

The DME can also be remotely tuned by entering a VOR frequency on the NAV RADIO page on the CDU.

The FMC uses two DMEs for position updates. If only one DME is available the FMC can use that DME and the associated VOR for a VOR/DME update.

The FMC cannot tune specific DMEs if the nav aids are inhibited on the REF NAV DATA page.

When either or both VORs are being auto tuned by the FMCs the DME receivers are scanned through several frequencies. This provides the FMC with continuous DME–DME updating even when one VOR is being manually tuned or when both VORs are remotely tuned. If both VORs are manually tuned the scanning DME function is disabled.

DME Displays

DME distance is displayed on the RDMI. When the DME is tuned by the ILS receiver the distance display is preceded by an L. DME distance is also displayed on the HSI when a VOR or ILS display is selected.

The POS REF page 2/4 and the NAV RADIO page display the identifiers of the DME stations used for FMC position updates.

VOR

There are two VOR receivers and two control panels installed.

VOR Tuning

In normal operation the FMC tunes both VORs and the associated DMEs for radio position updates. The HSI must be in the MAP or PLAN mode to allow FMC tuning of the VOR.

Specific VOR nav aids can be inhibited on the REF NAV DATA page to prevent the FMC from using those nav aids for position updating.

The crew can tune the VORs manually using the control panels, or remotely using the CDU. If the HSI is not in a MAP or PLAN mode, the associated VOR must be manually tuned using the control panel.

If the HSI is in the MAP or PLAN mode, the AUTO/MAN switch on the control panel must be selected to MAN to manually tune the VOR.

If the switch is in AUTO, the VOR can be remotely tuned on the CDU NAV RADIO page.

VOR Displays

Left and right VOR bearings can be displayed on the RDMIs. When VOR is selected on the HSI, the selected course and course deviation are displayed.

The tuned frequencies and selected courses are displayed on the VOR control panels on the glareshield.

If the HSI is in a MAP mode, symbols indicate the position of tuned VORs on the map display. If a VOR is manually tuned, the selected course is displayed on the HSI map as a dashed green line.

The identifier and frequency of the navaid tuned on the left and right VOR are displayed on the NAV RADIO page. The current radial of the tuned navaids are also displayed digitally on the NAV RADIO page.

POS REF page 2 displays the identifier of the navaids being used for position updates.

Marker Beacon

Each pilot has a set of marker beacon lights that show outer, middle and inner/airways beacon passage. Both sets are operated by the marker beacon receiver that is part of the left VOR receiver.

Multi-Mode Receiver

Three Multi-Mode Receivers (MMRs) are installed. Each MMR includes an ILS and GPS receiver. The GPS receiver in the center MMR is not used.

Instrument Landing System (ILS)

Three ILS receivers are installed. They are controlled by a single control panel on the aft electronics panel. Frequency changes are inhibited after localizer or glideslope capture if three autopilots are armed for approach. The selected runway front course is locked to prevent changes when the localizer is captured.

ILS Displays

Localizer and glideslope deviation are shown on the ADIs and Standby Attitude Indicator. When the ILS display is selected on the HSI, localizer and glideslope deviation plus the selected course and frequency are displayed. Front or back course deviation is determined from airplane heading.

Global Positioning System (GPS)

Left and right GPS receivers are independent and supply very accurate position data to the FMC. The GPS receivers are contained in the left and right Multi-Mode Receivers (MMRs). All GPS tuning is automatic.

GPS Displays

Position Reference, page 3 of 4 (POS REF 3/4) displays the left and right GPS position.

GPS Data

The FMC uses GPS data for position information as long as the GPS is enabled and the GPS data is valid. If GPS data is not available or is unreliable the FMC will use Radio or IRS position data.

The GPS NAV prompt on POS REF page 3/4 can be used to inhibit GPS navigation data. The EICAS message GPS alerts the crew when data from both GPS systems are unavailable or when both systems have failed.

GPS position updates are allowed for all United States National Airspace approach operations. Outside of this region, GPS position updates are allowed during approaches only if the FMC database and approach charts are referenced to the WGS-84 reference datum. GPS updates should be inhibited for all other approach operations unless other appropriate procedures are used.

GPS System Schematic

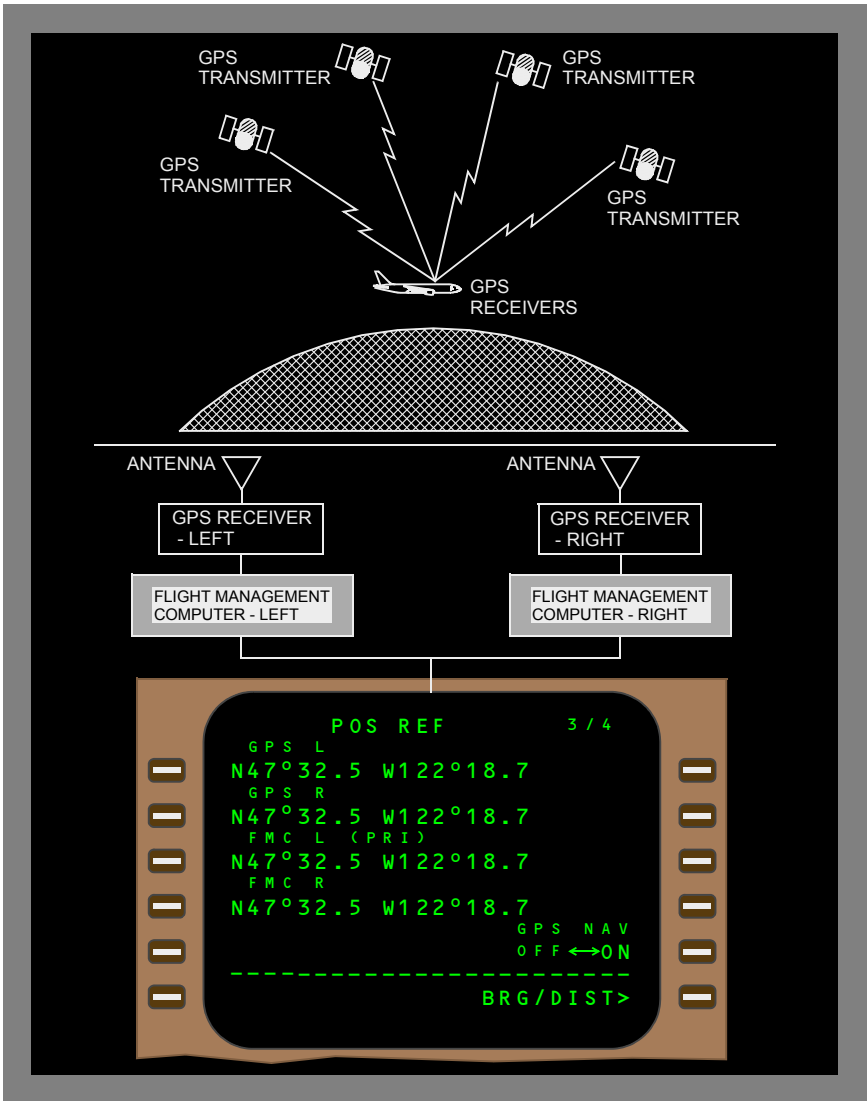

Transponder

There are two ATC transponders installed. They are controlled by a single control panel and provide normal transponder functions and altitude reporting. The control panel is used to set the ATC code, operating mode, and to select which transponder is active.

The transponder is also capable of providing traffic alert and collision avoidance system (TCAS) indications. Select TA ONLY or TA/RA to enable traffic displays. Refer to Chapter 15, Warning systems, for a description of TCAS.

Failure of a transponder is indicated by the illumination of the amber ATC FAIL light on the control panel and the ATC FAULT advisory message on EICAS.

Weather Radar

[Basic: [Weather radar single.](#)]

The weather radar system consists of a receiver–transmitter, an antenna, and a control panel.

[Option: [Weather radar dual.](#)]

The weather radar system consists of two receiver–transmitters, an antenna, and a control panel. The control panel provides manual selection of which receiver-transmitter is used.

Radar returns are displayed on the HSI.

The weather radar switch (WXR) on the EFIS control panel selects the weather radar display. The radar display range is set by the range selected on the EFIS control panel.

The radar system transmits when either WXR switch is selected on.

Turbulence can be sensed by the weather radar only when there is sufficient precipitation. Turbulence is displayed in magenta. Clear air turbulence can not be sensed by radar.

The predictive windshear alerting system uses the weather radar to sense windshear. To provide windshear alerting the weather radar transmitter is activated on the ground when takeoff power is set and in flight when the airplane is below 2300 feet radio altitude. Weather radar returns are not displayed unless the WXR switch is ON, or a predictive windshear alert occurs. Weather radar returns can only be displayed in VOR, APP, MAP and CTR MAP modes.

Introduction

The flight management system (FMS) aids the flight crew with navigation, in-flight performance optimization, automatic fuel monitoring, and flight deck displays. Automatic flight functions manage the airplane lateral flight path (LNAV) and vertical flight path (VNAV). The displays include a map for airplane orientation and command markers on the airspeed, and thrust indicators to help in flying efficient profiles.

The flight crew enters the applicable route and flight data into the CDUs. The FMS then uses the navigation database, airplane position, and supporting system data to calculate commands for manual and automatic flight path control.

The FMS tunes the navigation radios for position updating. The FMS navigation database supplies the necessary data to fly routes, SIDs, STARs, holding patterns, and procedure turns. Cruise altitudes and crossing altitude restrictions are used to calculate VNAV commands. Lateral offsets from the programmed route can be calculated and commanded.

Flight Management Computer (FMC)

The heart of the flight management system is the flight management computer. Under normal conditions, one FMC accomplishes the flight management tasks while the other FMC monitors. The second FMC is ready to replace the first FMC if system faults occur.

The FMC uses flight crew-entered flight plan data, airplane systems data, and data from the navigation database to calculate airplane present position and generate the pitch, roll, and thrust commands necessary to fly an optimum flight profile. The FMC sends these commands to the autothrottle, autopilot, and flight director.

Map and route data are sent to the HSIs. The EFIS control panels are used to select the data to be displayed on the HSIs.

The mode control panel selects the autothrottle, autopilot, and flight director operating modes. Refer to the following chapters for operation of these other systems:

- Chapter 4, Automatic Flight
- Chapter 10, Flight Instruments, Displays.

The FMC is certified for area navigation when used with navigation radio and/or GPS updating. The FMC and CDU are used for enroute and terminal area navigation, RNAV approaches, and as a supplement to primary navigation means when conducting other types of nonprecision approaches.

Control Display Units (CDUs)

Two CDUs are used to control the FMC.

The CDUs also provide alternate navigation capability if there is a dual FMC failure (refer to the Alternate Navigation section of this chapter). The CDUs can also provide control of other systems which are accessed through the menu page.

Introduction

Many FMS functions change depending on the current phase of flight. When first powered, the FMS is in the preflight phase. As a phase is completed, the FMS changes to the next phase in this order:

- preflight
- takeoff
- climb
- cruise
- descent
- approach
- flight complete.

Preflight

During preflight, flight plan and load sheet data are manually entered into the CDU. The flight plan defines the route of flight from the origin to the destination and initializes LNAV. Flight plan and load sheet data are provided to the FMC to enable performance calculations and initialize VNAV.

Required preflight data consists of:

- initial position
- route of flight
- performance data
- takeoff data.

Optional preflight data includes:

- navigation database selection
- route 2
- alternate airport
- SID
- STAR
- wind.

Each required or optional data item is entered on specific preflight pages.

Preflight starts with the IDENT page. If the IDENT page is not displayed, it can be selected with the IDENT prompt on the INIT/REF INDEX page. Visual prompts help the flight crew select necessary CDU preflight pages. Preflight pages can be manually selected in any order.

After the necessary data on each preflight page is entered and checked, the lower right line select key selects the next preflight page. When ACTIVATE is selected on the ROUTE page, the execute (EXEC) light illuminates. Push the EXEC key to make the route active.

Use the departure/arrival (DEP/ARR) page to select a standard instrument departure (SID). Selection of the SID may cause a route discontinuity in the flight plan. The modification can be connected to the existing route and executed. This is accomplished on the ROUTE or LEGS page.

When all required preflight entries are complete, PRE-FLT COMPLETE is displayed on the TAKEOFF REF page.

Takeoff

The takeoff phase starts with engagement of takeoff thrust and extends to the thrust reduction altitude where climb thrust is normally selected.

Climb

The climb phase starts at the thrust reduction altitude and extends to the top of climb (T/C) point. The T/C is the position where the airplane reaches the cruise altitude entered on the PERF INIT page.

Cruise

The cruise phase starts at the T/C point and extends to the top of descent (T/D) point. Cruise can include step climbs and en route descents.

Descent

The descent phase starts at the T/D point or when the VNAV descent page becomes active. The descent phase extends to the start of the approach phase.

Approach

The approach phase starts when intercepting the first leg of a published approach selected from the ARRIVALS page.

Flight Complete

Thirty seconds after engine shutdown, the flight complete phase clears the active flight plan and load data. Some preflight data fields initialize to default values in preparation for the next flight.

Operational Notes

When operating in the LNAV and VNAV modes, system operation must be monitored for unwanted pitch, roll, or thrust commands. If unwanted operation is noticed, roll and pitch modes other than LNAV and VNAV must be selected.

The system must be carefully monitored for errors following:

- activation of a new data base
- power interruption
- IRS failure.

When operating far off the route, the FMC may not sequence to the next waypoint when the airplane passes abeam the active waypoint.

LNAV can only capture the active leg. It cannot capture an inactive leg in the active route. The DIRECT TO or INTERCEPT COURSE TO procedures can be used to create an active leg for capture.

When a waypoint is in the route more than once, certain route modifications (such as DIRECT TO and HOLD) use the first occurrence of the waypoint even if the second occurrence is selected.

Some SIDs or STARS contain a heading vectors leg. VECTORS waypoints display on the map display as a magenta line without an end point leading away from the airplane symbol. If LNAV is engaged, the DIRECT TO or INTERCEPT COURSE TO procedure can be used to start waypoint sequencing beyond the vectors leg.

When entering airways in a route page, the start and end waypoints must be in the data base. Otherwise, the route segment must be entered as a DIRECT leg.

If the engines remain operating between flights, entering a new cruise altitude before the next flight recalculates the proper vertical profile.

If a climb to cruise altitude is necessary after completing a descent, a new cruise altitude entry must be made. Cruise altitude can be entered on the CLB page.

Direct-to courses are segments of a great circle route. When entering a direct-to waypoint on the LEGS page, the course above the waypoint before execution is the arrival course at the waypoint. However, after execution, the course is the current course to fly to the waypoint. These courses may not be the same.

Terminology

The following paragraphs describe FMC and CDU terminology.

Active – flight plan data being used to calculate LNAV or VNAV guidance commands.

Activate – the procedure to change an inactive route to the active route for navigation. It is a two step procedure.

- select the ACTIVATE prompt
- push the execute (EXEC) key.

Altitude constraint – a crossing restriction at a waypoint.

Delete – using the delete (DEL) key to remove FMC data and revert to default values, dash or box prompts, or a blank entry.

Econ – a speed schedule calculated to minimize operating cost. The economy speed is based on the cost index. A low cost index causes a lower cruise speed. Maximum range cruise or the minimum fuel speed schedule may be obtained by entering a cost index of zero. This speed schedule ignores the cost of time.

A low cost index may be used when fuel costs are high compared to operating costs.

A minimum time speed schedule may be obtained by entering a cost index of 9999. This speed schedule calls for maximum flight envelope speeds.

Enter – insert data in the CDU scratchpad and line select the data to the applicable location. New characters can be typed or existing data can be line selected to the scratchpad for entry.

Erase – remove entered data, which has resulted in a modification, by selecting the ERASE prompt.

Execute – push the EXEC key when the light is illuminated to make modified data active.

Inactive – data not being used to calculate LNAV or VNAV commands.

Initialize – entering data required to make the system operational.

Message – FMC information displayed in the scratchpad.

Modify – to change active data. When a modification is made to the active route or performance mode, MOD displays in the page title, ERASE displays next to line select key 6 left, and the EXEC key illuminates.

Prompt – CDU symbol that aids the flight crew in accomplishing a task. Prompts can be boxes, dashes, or symbols (< or >) to remind the flight crew to enter or select data.

Reset – a self protection function which causes an FMC to shutdown and restart when an error is detected. Current flight and performance data is automatically re-loaded from the other FMC during the reset.

Select – pushing a key to obtain the necessary data or action, or to copy selected data to the scratchpad.

Speed restriction – an airspeed limit associated with a specified altitude entered by the flight crew.

Speed transition – an airspeed limit associated with a specified altitude entered from the database.

Waypoint – a point on the route or in the navigation database. It can be a fixed point such as a latitude and longitude, VOR or ADF station, or an airway intersection. A conditional waypoint is not associated with a land reference; it is based on a time or altitude requirement. An example of a conditional waypoint is "when reaching 1000 feet".

Navigation Position

The FMC determines present position from these navigation systems:

- IRS
- navigation radios.
- GPS

The FMC uses its calculated present position to generate lateral steering commands along the active leg to the active waypoint. The FMC requires position data from the IRS. All other position sources are validated against the IRS position and are used to refine the FMC position.

FMC Position Determination

The FMC position is based on the IRS position adjusted with updates from available navigation signals.

FMC Position Update

FMC position may be manually updated to any of the navigation system positions. This update is accomplished on POS REF page 2.

On the ground, the FMC calculates present position based on IRS and the GPS data.

If GPS NAV is OFF, the FMC updates position to the takeoff runway threshold when the autothrottle is engaged for takeoff. The runway data is on the TAKEOFF REF page. When an intersection takeoff is made, the intersection displacement distance from the runway threshold must be entered on the TAKEOFF REF page. If GPS NAV is ON, this update is inhibited. GPS navigation can be selected on or off on POS REF page 3/4.

In flight, the FMC position is continually updated from the GPS, navigation radios, and IRS. Updating priority is based on the availability of valid data from the supporting systems.

The FMC automatically tunes the VOR, DME, and ILS radios for position updates.

FMC position updates from navigation sensor positions follow this priority:

- one LOC and GPS (tuned for approach)
- one LOC and collocated DME (tuned for approach)
- one LOC and VOR with a collocated DME (tuned for approach)
- LOC (tuned for approach)
- GPS
- two DME stations
- one VOR with a collocated DME
- IRS.

The selected station identifiers of the radio navigation aids are displayed on the POS REF page 2.

| Primary FMC Position Update Source | POS REF page 2/4 |
|---|------------------|
| GPS | GPS |
| LOC, GPS valid* | LOC–GPS |
| LOC, DME DME valid; GPS invalid* | LOC–RADIO |
| LOC, VOR DME valid; GPS invalid* | LOC–RADIO |
| LOC valid; GPS, DME, VOR invalid* | LOC |
| DME DME valid; GPS invalid | RADIO |
| VOR DME valid; GPS invalid | RADIO |
| GPS, VOR, DME invalid | IRS |
| IRS invalid (no navigation capability) | blank |
| * The FMC changes to LOC updating when: <ul style="list-style-type: none"> • the tuned localizer is associated with the destination runway • valid localizer signal is being received • the airplane is within the criteria to ensure accurate LOC updating. | |

FMC Polar Operations

The FMC automatically starts polar operations when the calculated airplane position enters a polar region. The FMC switches all flight display inputs to reference true north while in these regions.

Automatic switching to a true north reference is annunciated by a flashing white box around the word TRU on the HSI. A TRUE heading reference can be selected with the heading reference switch when outside the polar region. The HSI displays a green box around the word MAG to annunciate the change back to magnetic reference. If the heading reference is TRU in the descent phase, the HSI displays an amber box around the word TRU.

The navigation and display system does not support operations at latitudes greater than 87° North or South.

FMC Polar Regions

Polar regions are all areas above 73° North or below 60° South. Magnetic headings are not available in these areas.

Navigation Performance

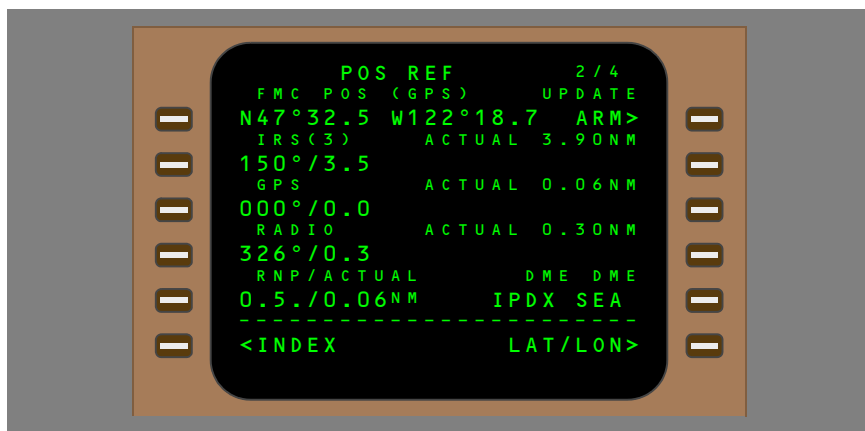

The FMC uses data from the navigation systems to accurately calculate the position of the airplane. The current FMC position is displayed on line 1 of POS REF page 2. The primary source of update is shown in parentheses above the FMC position. The positions of each of the navigation systems are shown in lines 2 through 4. The flight crew can change the display format from latitude/longitude to bearing/distance format. The bearing/distance is from the FMC position to the individual navigation system position.

Actual Navigation Performance

Actual navigation performance (ANP) is the FMC current computed position accuracy. It is shown on POS REF page 2 (line 5L) titled ACTUAL. ACTUAL navigation performance is expressed in nautical miles. It represents the radius of a circle centered at the FMC position which defines the limit of the potential error in that position. The smaller the ANP the more accurate the FMC position.

ACTUAL navigation performance is also computed for each of the navigation systems and those values are displayed on POS REF page 2 adjacent to the system name. The systems' ACTUAL navigation performance is equivalent to the one calculated for the FMC.

After a manual position update, the ACTUAL navigation performance of the FMC changes to the ACTUAL navigation performance of the selected navigation system. In the example above, a manual position update to the INERTIAL system would change the FMC ACTUAL navigation performance to 3.9 NM. The FMC then updates from the best available navigation system and eventually, the manual update has no effect on position calculation. Some automatic updates can be inhibited: GPS on POS REF page 3 and VOR/DME updates on the REF NAV DATA page. Inertial and DME/DME updates can not be inhibited.

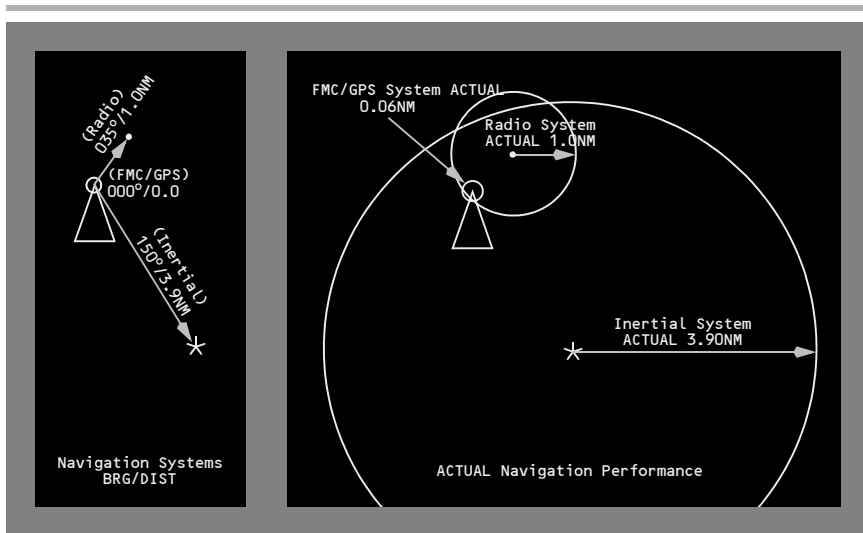

Required Navigation Performance

Required navigation performance (RNP) values have been created and published for certain areas of operation and procedures. The RNP, expressed in nautical miles, defines the accuracy of the navigation equipment required to fly the route or procedure for which it is published. ACTUAL navigation performance should not exceed RNP. The FMC triggers the EICAS advisory or caution level message UNABLE RNP to alert the flight crew if ANP exceeds RNP. The FMC supplies a default RNP value for takeoff, enroute, oceanic/remote, terminal, and approach phases of flight. RNP is displayed on POS REF page 2. The flight crew may enter an RNP value, if required.

Lateral Navigation (LNAV)

LNAV provides steering commands to the next waypoint or the selected route intercept point. When armed on takeoff, LNAV engages at or above 50 feet when laterally within 2.5 nautical miles of the active route leg. FMC LNAV guidance normally provides great circle courses between waypoints. However, when an arrival or approach from the FMC data base is entered into the active route, the FMC commands a heading, track, or a DME arc to comply with the procedure.

Waypoints

Waypoint (navigation fix) identifiers are displayed on the CDU and on the map display.

The CDU message NOT IN DATABASE is displayed if a manually entered waypoint identifier is not in the data base. The waypoint can still be entered as a latitude/longitude, place–bearing/distance or a place–bearing/place–bearing waypoint.

FMC–generated waypoints contain a maximum of five characters assigned according to the following rules.

Navaid Waypoints

VHF – waypoints located at VHF nav aids (VOR/DME/LOC) are identified by one, two, three or four character facility identifier. Examples:

- Los Angeles VORTAC – LAX
- Tyndall TACAN – PAM
- Riga Engure, Latvia – AN.

NDB (non–directional beacon) – waypoints located at NDBs are identified by use of the station identifier. Example: FORT NELSON, CAN – YE.

Fix Waypoints

Waypoints located at fixes with names containing five or fewer characters are identified by the name. Examples:

- DOT
- ACRA
- ALPHA.

Long Waypoint Names

Waypoints with more than five characters are abbreviated using the following rules sequentially until five characters remain. For double letters, one letter is deleted. Example:

- KIMMEL becomes KIMEL.

Keep the first letter, first vowel and last letter. Delete other vowels starting from right to left. Example:

- BAILEY becomes BAILY.

The next rule abbreviates names even further. Apply the previous rule, then delete consonants from right to left. Example:

- BRIDGEPORT becomes BRIDGPRT then BRIDT.

Fixes with multiword names use the first letter of the first word and abbreviate the last word, using the above rules sequentially until a total of five characters remain. Examples:

- CLEAR LAKE becomes CLAKE
- ROUGH ROAD becomes RROAD.

Unnamed Waypoints

If an unnamed turn point, intersection, or fix is collocated with a named waypoint or navaid on a different route structure (such as low altitude routes or an approach), the name or identifier of the collocated waypoint is used. Example:

- Unnamed turn point on J2 between the Lake Charles (LCH) and New Orleans (MSY) VORTACs is coincidental with the Lafayette (LFT) low altitude VORTAC. LFT is used as the identifier for the turn point.

Identifier codes for unnamed turn points not coincidental with named waypoints are constructed from the identifier of a navaid serving the point and the distance from the navaid to the point. If the distance is 99 nautical miles or less, the navaid identifier is placed first, followed by the distance. If the distance is 100 nautical miles or more, the last two digits are used and placed ahead of the navaid identifier. Examples (NAVAID – DISTANCE – IDENT):

- INW – 18 – INW18
- CSN – 106 – 06CSN.

Waypoint located at unnamed flight information region (FIR), upper flight information region (UIR), and controlled airspace reporting points are identified by the three-letter airspace type identification followed by a two-digit sequence number. Example:

- FRA01

Unnamed oceanic control area reporting points in the northern hemisphere use the letters N and E, while points in the southern hemisphere use the letters S and W. Latitude always precedes longitude. For longitude, only the last two digits of the three digit value are used.

Placement of the designator in the five character set indicates whether the first longitude digit is 0 or 1. The letter is the last character if the longitude is less than 100° and is the third character if the longitude is 100° or greater.

N is used for north latitude, west longitude. E is used for north latitude, east longitude. S is used for south latitude, east longitude. W is used for south latitude, west longitude. Examples:

- N50° W040° becomes 5040N
- N75° W170° becomes 75N70
- N50° E020° becomes 5020E
- N06° E110° becomes 06E10
- S52° W075° becomes 5275W
- S07° W120° becomes 07W20
- S50° E020° becomes 5020S
- S06° E110° becomes 06S10.

Procedure Arc Fix Waypoint Names

Unnamed terminal area fixes along a DME arc procedure are identified with the first character D. Characters 2 through 4 indicate the radial on which the fix lies. The last character indicates the arc radius. The radius is expressed by a letter of the alphabet where A = 1 mile, B = 2 miles, C = 3 miles and so forth. Example:

- EPH252°/24 = D252X.

An unnamed waypoint along a DME arc with a radius greater than 26 miles is identified by the station identifier and the DME radius. Example:

- CPR338°/29 = CPR29.

When there are multiple unnamed waypoints along a DME arc with a radius greater than 26 miles, the station identifier is reduced to two characters, followed by the radius, and then a sequence character. Examples:

- CPR134°/29 = CP29A
- CPR190°/29 = CP29B.

DME step down fixes are identified by the distance and a "D".
Examples: 138D, 106D, 56D, 3D.

Procedure Fix Waypoints

Marker beacons are identified by the marker type identifier followed by the runway number. Examples:

- Outer Marker 13R = OM13R
- Middle Marker 21 = MM21.

Waypoints located at unnamed runway-related fixes are identified by adding a two-letter prefix to the runway number. The following list is used to determine the applicable prefix:

- | | |
|----------------------------------|--|
| • RX – runway extension fix | • BM – back course marker |
| • FA – VFR final approach fix | • MD – minimum descent altitude |
| • CF – final approach course fix | • A – (+ an alpha) step down fix |
| • FF – final approach fix | • RW – runway threshold |
| • IF – initial approach fix | • MA – missed approach point other than RW |
| • OM – outer marker | • TD – touchdown point inboard of RW. |
| • MM – middle marker | |
| • IM – inner marker | |

Examples: OM25L, MM09, IM23, RW04, RW18L.

For airports with more than one approach to the same runway, the two letter prefix may change to allow different identifiers for the same waypoint. The first letter identifies the type of fix and the second letter identifies the type approach as follows:

-
- C() – final approach course fix
 - F() – final approach fix
 - P() – missed approach point
 - I() – initial approach fix
 - D() – minimum descent altitude
 - T() – touch down point
 - R() – runway centerline intercept.
 - ()I – ILS
 - ()L – localizer only
 - ()B – backcourse ILS
 - ()D – VOR/DME
 - ()V – VOR only
 - ()S – VOR with DME points
 - ()N – NDB
 - ()Q – NDB with DME points
 - ()M – MLS
 - ()T – Tacan
 - ()R – RNAV.

Examples: CI32R, PV15, FN24L.

Unnamed turn points that are part of a procedure are identified as a latitude and longitude waypoint. These include waypoints (except conditional waypoints) defined by flying a course or track from a waypoint (except conditional waypoints) to a radial or DME distance. These waypoints are automatically entered in a route by selection of a procedure using these waypoints, from the departures or arrivals page.

Airport reference points are identified by the ICAO identifier.

Duplicate Waypoints

Application of the abbreviation rules may create identical identifiers for different waypoints. When a duplicate waypoint identifier is entered, the page changes to the SELECT DESIRED WPT page. The page lists the latitude, longitude, and the type of facility or waypoint of all the waypoints with the same identifier. Select the latitude/longitude of the correct waypoint to enter the correct waypoint on the original page.

Conditional Waypoints

Conditional waypoints are automatically entered into a route as a result of selecting a procedure on a DEPARTURES or ARRIVALS page. They are not geographically fixed. They are defined by satisfying a condition such as passing an altitude or flying a heading to a radial. Some conditional waypoints are displayed on the map display. The conditions that may define conditional waypoints are:

- climb/descent through an altitude
- flying a heading to a radial or DME distance
- intercepting a course
- heading vectors to a course or fix.

Altitude and course intercept conditional waypoints display on the CDU inside (parenthesis) marks. The diagram below shows conditional waypoints.

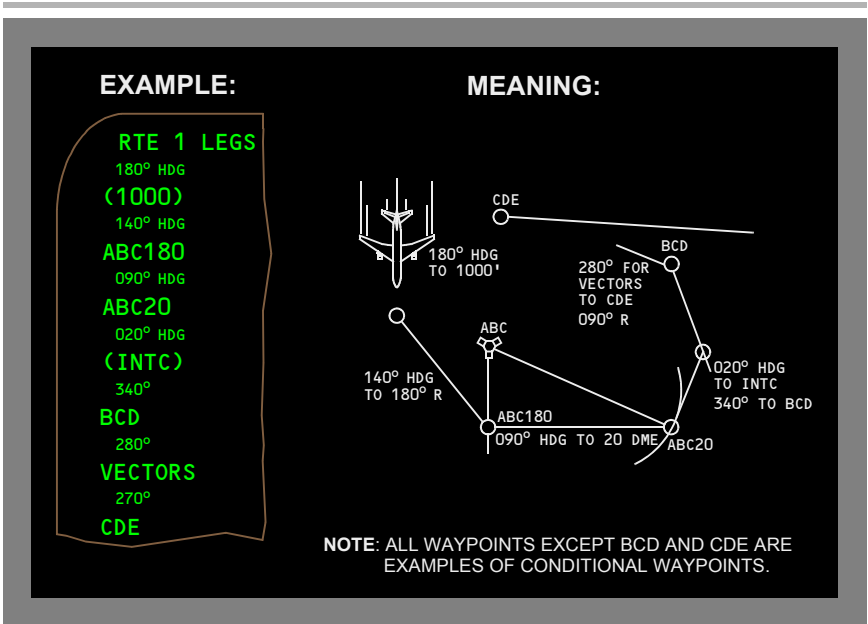

Manually Entered Latitude/Longitude Waypoints

Pilot defined waypoints entered as a latitude and longitude are shown in a seven-character format. Latitude and longitude waypoints are entered with no space or slash between the latitude and longitude entries. Leading zeroes must be entered. All digits and decimal points (to 1/10 minute) must be entered unless the latitude or longitude are full degrees. Examples:

- N47° W008° is entered as N47W008 and is displayed as N47W008
- N47° 15.4' W008° 3.4' is entered as N4715.4W00803.4 and is displayed as N47W008.

Manually Entered Place-Bearing/Distance or Place-Bearing/Place-Bearing Waypoints

Waypoints entered as a place-bearing/distance or place-bearing/place-bearing are identified by the first three characters of the entry followed by a two-digit sequence number. Examples:

- SEA330/10 becomes SEA01
- SEA330/OLM020 becomes SEA02.

The two digit sequence numbers reserved for RTE1 are 01 through 49. The two digit sequence numbers reserved for RTE2 are 51 through 99.

Manually Entered Airway Crossing Waypoints

Airway crossing fixes are entered as a five character waypoint name or by entering consecutive airways on the ROUTE page. In the latter case, the display is an X followed by the second airway name. Example: entering J70 on the VIA line of the ROUTE page causes box prompts to display opposite on the same line. Leaving the TO box prompts empty and entering J52 on the next VIA line, directly below J70, causes the FMC to calculate the intersection of the two airways and replace the boxes with the waypoint identifier, XJ52.

Manually Entered Latitude or Longitude Reporting Point Waypoints

Latitude or longitude reporting waypoints are entered as the full latitude or longitude followed by a dash, then the increment chosen for the following multiple waypoints. Example:

- W060–10 adds waypoints starting at W060 in ten degree increments from that point to the destination
- the entry must be made on a LEGS page on any line before the first reporting point
- usually, this entry is made on the active waypoint line and proper sequencing is performed by the FMC.

Manually Entered Along–Track Waypoints

Along–track waypoints are created on the active route and do not cause route discontinuities when they are created.

Along–track waypoints are entered using the waypoint name (the place), followed by a slash and minus sign, for points before the waypoint, or no sign for points after the waypoint, followed by the mileage offset for the newly defined waypoint. The created waypoint is then inserted over the original waypoint. The distance offset must be less than the distance between the originating waypoint and next (positive value) or preceding (negative value) waypoint. Latitude and longitude waypoints cannot be used to create along–track waypoints. Examples:

- VAMPS/25 is 25 miles after VAMPS on the present route and displays as VAM01
- ELN/–30 is 30 miles before ELN on the present route and displays as ELN01.

EO SID

An engine out SID is a procedure developed by an airline for a particular runway to provide unique routing if an engine fails on takeoff. If the database contains an EO SID for the takeoff runway and an engine fails while the flaps are extended, the active route is automatically modified to the engine out route. The modification may be either executed or erased.

Map Displays

The route is displayed on the HSI when a MAP or PLAN mode is selected.

The display color and format represent the following status:

- an inactive route is displayed as a cyan dashed line
- an activated, but not yet executed route, is displayed as a white dashed line
- the active route is displayed in magenta
- modifications to an active route are shown as dashed white lines
- modified waypoints are displayed in white
- executed route offsets are displayed as a dashed magenta line.
- prior to execution, entered route offsets are displayed as a dashed white line

The MAP displays the FMC position at the apex of the airplane symbol. All MAP data is displayed relative to this apex.

When adequate position updating is not available, the map may display a shift error. This error results in the displayed position of the airplane, route, waypoints and navigation aids being shifted from their actual position. An undetected, across track map shift may result in the airplane flying a ground track that is offset from the desired track. An undetected, along track map shift may result in the flight crew initiating altitude changes earlier or later than desired. In either case, an undetected map shift may compromise terrain or traffic separation.

Map shift errors can be detected by comparing the position of the airplane on the map with data from the ILS, VOR, DME, and ADF systems.

Vertical Navigation (VNAV)

VNAV provides vertical profile guidance through the climb, cruise, and descent phases of flight.

Speed/Altitude Constraints

VNAV controls the path and speed to comply with waypoint crossing constraints. Waypoint crossing constraints are entered on the LEGS page waypoint line by pushing the applicable key on the right side of the CDU. Barometric altitude constraints must be below the cruise altitude to be valid. Values entered as part of a procedure and manually entered constraints are shown in large font. FMC predicted values do not act as constraints, and are displayed in small font.

Waypoints can have altitude or airspeed/altitude constraints. Speed constraint entries require an altitude constraint at the same waypoint. All speed constraints are considered by the FMC as at or below constraints.

At or above altitude constraints are entered with a suffix letter A (example: 220A).
At or below altitude constraints are entered with a suffix letter B (example: 240B).
Mandatory altitude constraints are entered without any suffix letter (example: 270).

Altitude constraints with two altitudes may be entered in either order. The lower altitude constraint, followed by a suffix letter A, and the upper altitude constraint, followed by a suffix letter B (example: 220A240B or 240B220A).

Takeoff and Climb

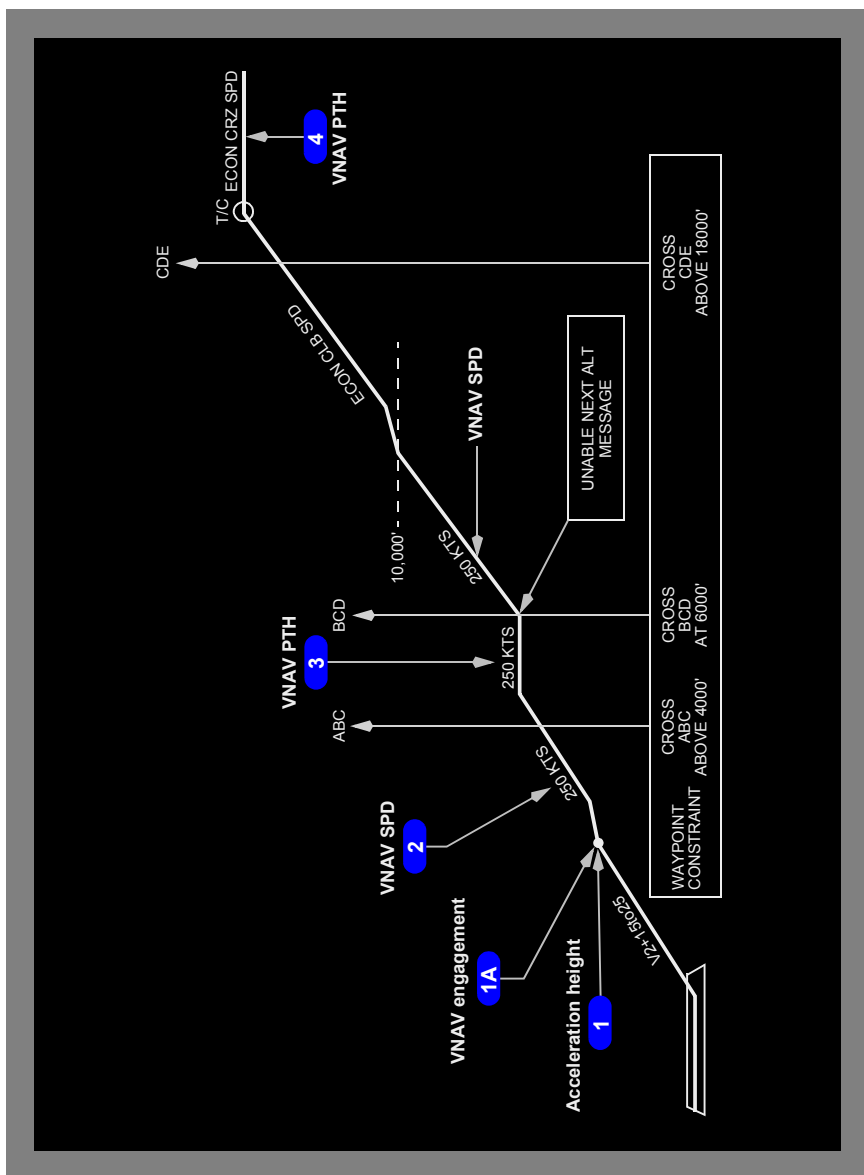

1 Acceleration Height

Height at which acceleration is initiated for flap retraction, normally 1000 feet. Takeoff (TO) pitch mode is used for takeoff and initial climb up to this point.

1A VNAV Engagement

VNAV is normally engaged at acceleration height. Pitch guidance then commands:

- an airspeed increase to 250 knots, or
- the speed transition associated with the origin airport, or
- the takeoff target airspeed (between $V_2 + 15$ and $V_2 + 25$ knots) if the acceleration altitude entered on TAKEOFF REF page 2/2 has not been reached

Initial reduction of flaps after VNAV is engaged also initiates pitch guidance to accelerate to 250 knots.

When VNAV is engaged (above 400 feet) the thrust reference changes to climb.

2 VNAV Climb

The VNAV climb profile uses VNAV SPD or VNAV PTH at the default climb speed, or pilot selected climb speed to remain within all airspeed and altitude constraints that are part of the SID entered into the active route. Autothrottle uses selected climb thrust limit.

3 Climb Constraints

VNAV enters the VNAV PTH mode to remain within departure or waypoint constraints. Speed maintained during this time can be:

- procedure based speed restriction
- waypoint speed restriction
- default VNAV climb speed
- manually entered climb speed.

When executing a SID with a speed and altitude constrained waypoint, VNAV will maintain the speed constraint during the climb until the respective waypoint is sequenced, regardless of the associated altitude constraint.

If the FMC predicts the airplane will not reach an altitude constraint, the message UNABLE NEXT ALTITUDE is displayed on the CDU. Speed intervention can be used by pushing the IAS/MACH selector and manually setting a lower airspeed to provide a steeper climb or climb derates can be deleted.

4 Top Of Climb (T/C)

The point where the climb phase meets the cruise altitude is called the top of climb. Approaching this point, the FMC changes from the climb phase to the cruise phase. The T/C is displayed any time the FMC calculates a change from a climb phase to a cruise phase, such as a step climb.

The T/C point is displayed on the map as a green open circle with the label T/C.

Cruise

At cruise altitude, the FMC commands economy cruise speed or the pilot entered speed until reaching the top-of-descent (T/D) point. Alternate cruise speed options are:

- long range (LRC)
- engine out (ENG OUT), or
- flight crew entered speed.

If the cost index is set to zero the FMC commands maximum range cruise speed. Cost index modifications are allowed until within ten miles of the top of descent.

Cruise Climb

When VNAV is engaged, resetting the MCP to an altitude higher than the current cruise altitude causes that altitude to be displayed in the scratchpad of the CDU. The altitude can then be entered on the CRZ ALT line on the cruise page. When the modification is executed the airplane will climb to the new cruise altitude. The CRZ page displays ACT ECON CRZ CLB.

Step Climb

Fuel and ETA predictions assume the airplane climbs at each predicted step climb point as airplane weight decreases.

FMC predicted step climb increments are based on the step size shown on the CRZ page. Entering a step size of zero causes the FMC to assume a constant altitude cruise.

Flight crew entry of a step altitude on the CRZ or RTE LEGS page overrides the FMC step climb predictions. Entry of a planned step altitude on the RTE LEGS page overrides a "Step To" entry made on the CRZ page.

Predicted step altitudes display on the RTE LEGS page. The distance and ETA to the next step point (predicted or flight crew entered) display on the CRZ and progress pages. They also display on the map display with a green circle and S/C label.

Cruise Descent

Resetting the MCP to an altitude below the current cruise altitude causes the new altitude to be copied to the scratchpad if the altitude change is 4000 feet or less. The new cruise altitude can be entered on the cruise page. When the modification is executed the CRZ page displays ACT ECON CRZ DES. If the altitude set in the altitude window is below the speed transition (SPD TRANS) or restriction (SPD RESTR) altitude displayed on the DES page, those altitudes and speeds are deleted and the airplane will maintain cruise speed during the descent. Transition or speed restrictions must be maintained by flight crew action.

Mode Control Panel Speed Intervention

With VNAV engaged, pushing the IAS/MACH selector enables speed intervention. Speed intervention allows the flight crew to change airplane speed with the IAS/MACH selector.

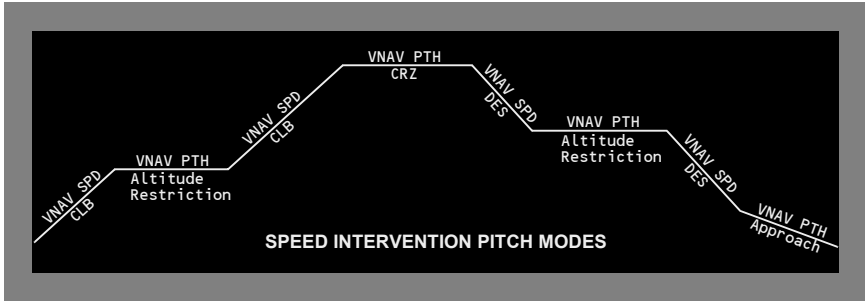

The above illustration shows VNAV mode for each phase of flight during speed intervention.

Note: The FMC does not use the speed set on the MCP for fuel or ETA predictions so FMC predictions are not accurate if speed intervention is used for an extended period.

In VNAV PTH mode, thrust controls speed; in VNAV SPD mode, pitch controls speed.

If speed intervention is selected during a VNAV PTH descent, VNAV PTH pitch mode changes to VNAV SPD and the airplane may depart the FMC calculated descent path. In all other phases of flight, the AFDS captured pitch mode remains unchanged when speed intervention is selected.

In approach phase (see Approach topic this chapter/section), during speed intervention, pitch mode remains in VNAV PTH and the vertical path is maintained regardless of IAS MACH selector changes.

Descent

The FMC calculates a descent path based on airspeed and altitude constraints and the end of descent (E/D) point. Dashes display on the LEGS page for speed and altitude descent waypoints. When an arrival or approach procedure is selected on the ARRIVALS page and incorporated into the flight plan, the FMC creates an E/D. The E/D is located 50 feet above the runway threshold (RW waypoint) for all approaches except VOR approaches. The E/D for VOR approaches is the missed approach point; which may be the VOR, runway waypoint (RWXXX), or a named waypoint. During cruise, an E/D is also created when an altitude constraint is entered on the LEGS page on a downstream waypoint.

The top of descent (T/D) is the point where the cruise phase changes to the descent phase. It displays on the HSI as a green circle with the label T/D. The descent path starts at the T/D and includes waypoint altitude constraints. The path to the first constraint is based on:

- idle thrust
- speedbrakes retracted
- FMC cruise wind
- wind entries on the DESCENT FORECAST page
- predicted use of anti-ice
- applicable target speed

The descent may be planned at economy Mach/CAS (based on Cost Index) or a manually entered Mach/CAS. VNAV will not command an economy target speed greater than 344 knots (VMO/MMO minus 16 knots) or a pilot entered speed greater than 349 knots (VMO/MMO minus 11 knots).

The FMC creates the descent path with a deceleration at the speed transition altitude (typically 250 knots below 10,000 feet). Below the speed transition altitude, VNAV defines the descent path at a speed target 10 knots below the transition speed (typically 240 knots) to allow for unknown tailwinds.

Descent path segments after the first altitude constraint waypoint are constructed as straight line point-to-point segments. The autothrottle provides thrust as required to maintain the path.

If the airplane passes the T/D point and the altitude window has not been set lower, or if the airplane levels at an MCP altitude not in the FMC descent profile, ALT HOLD annunciates. The MCP must be reset and VNAV re-engaged to initiate/continue the descent.

On a VNAV PTH descent, the descent path angle is calculated to maintain speed based on the six parameters listed above. Above the first speed transition altitude, pitch will maintain the path, and resultant speed, according to the following:

- If airspeed decreases to 15 knots below the VNAV target airspeed, as may be caused by an unforecast headwind, the autothrottle changes from IDLE/HOLD to SPD and adds an appropriate amount of thrust to accelerate back to the VNAV target speed. Upon reacquiring the target airspeed, the autothrottle changes back to IDLE/HOLD.

If the autothrottle is disengaged, the scratchpad message THRUST REQUIRED displays and it is the flight crew's responsibility to adjust thrust to reacquire the VNAV target airspeed.

- If airspeed increases to 15 knots above the VNAV target airspeed, as may be caused by an unforecast tailwind, the scratchpad message DRAG REQUIRED displays. To slow the airspeed back to the target it is the flight crew's responsibility to add an appropriate amount of drag (usually with speedbrakes). Upon reacquiring the target airspeed, the scratchpad DRAG REQUIRED message automatically clears.

The DRAG REQUIRED scratchpad message may also appear if the airspeed reaches VMO/MMO minus 16 knots before reaching the airspeed of VNAV target speed + 15 knots.

- If airspeed is allowed to decrease/increase below/above the 15 knot limits and approach an aerodynamic/airframe speed limit (VMO/MMO, minimum maneuvering, flap placard, etc.), VNAV reverts to speed reversion mode. In speed reversion mode, VNAV departs the calculated vertical descent path and pitch changes from VNAV PTH to VNAV SPD. VNAV then pitches to maintain a safe target speed (not the VNAV PTH descent speed) above/below the path as appropriate. If the calculated vertical descent path is reacquired, the target speed returns to the original VNAV PTH descent speed. The scratchpad messages THRUST REQUIRED and DRAG REQUIRED also reappear as appropriate during speed reversion.

Below the first speed transition altitude, pitch will maintain the path, and resultant speed, as described for when above the first speed transition altitude, except the airspeed is only allowed to transit a maximum of 10 knots above/below the VNAV target airspeed before the autothrottle reacts or the FMC scratchpad messages display.

Early Descent

When a descent is started before the T/D, VNAV commands a descent at a reduced descent rate until the idle descent path is intercepted.

Start an early descent by resetting the MCP altitude, then selecting the DES NOW prompt on the DES page. In an early descent, the autothrottle mode annunciation is initially THR, followed by HOLD, allowing the pilot to adjust the rate of descent. The pitch mode is VNAV SPD.

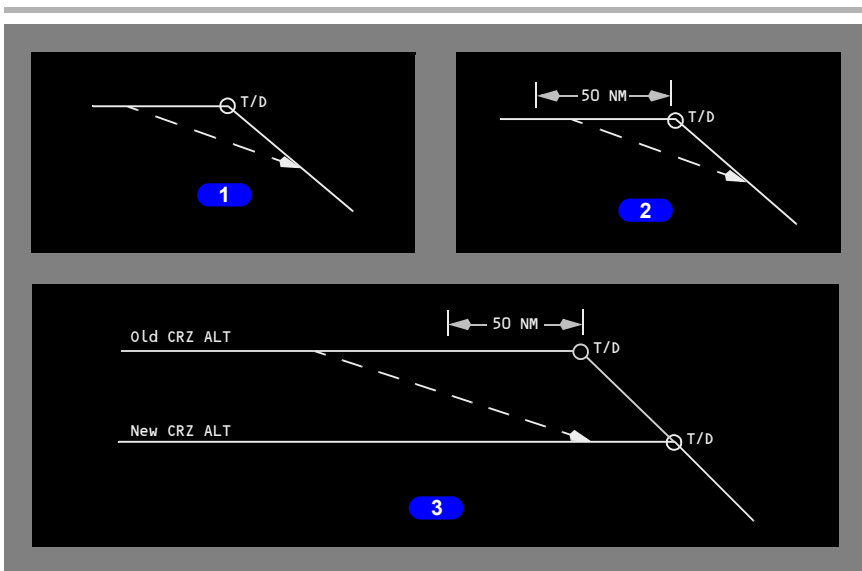

1 DES NOW

Use the DES NOW prompt on the VNAV DES page. VNAV starts an early descent and captures the idle descent path.

Note: When more than 50 NM from the top of descent point, perform a cruise descent rather than a descend now for descent to intermediate altitudes. During cruise descent the FMC computes a new top of descent for the new cruise altitude and accurate destination fuel predictions. Fuel predictions using DES NOW more than 50 NM from the top of descent point can cause a fuel computation error.

2 Within 50 NM of Top of Descent Point

Use the MCP altitude selector to start an early descent. Within 50 NM of the top of descent point, VNAV starts an early descent and captures the idle descent path.

3 More than 50 NM from Top of Descent Point

Use the MCP altitude selector to start a cruise descent. If the distance from the top of descent is more than 50 NM, VNAV begins a cruise descent to the new cruise altitude. VNAV may not capture the idle descent path since the target airspeed is economy cruise and the descent path is based on idle thrust and economy descent airspeed. In the example, VNAV levels at the new cruise altitude.

Approach

For VFR and nonprecision approaches, VNAV will fly the computed descent path to the E/D point altitude if the MCP altitude is set at or below the E/D point altitude. However, it is the responsibility of the flight crew not to descend below the MDA of the approach being flown until adequate visual contact is achieved.

"On Approach" Mode

The FMC transitions to "on approach" mode for any of the following conditions:

- an approach procedure selected into the active route from the destination airport ARRIVALS page becomes the active procedure on page 2 of the active Route Page
- distance to the destination airport is less than 12 nm and the active leg is not part of a procedure
- the MAP (or last waypoint on the approach procedure) is the active waypoint and the distance to that waypoint is less than 25 nm
- VNAV engaged in DES mode and flaps extended

Transition to the "on approach" FMC mode may be delayed if the flight crew manually inserts, bypasses, or deletes an approach waypoint on the LEGS page.

When the FMC is "on approach", the following features are available:

- the IAS/MACH window can be opened and the command speed can be set while VNAV remains in VNAV PTH descent; VNAV commands the set speed
- the MCP altitude can be set above the airplane altitude for the missed approach. When the MCP altitude setting is at least 300 feet above the current airplane altitude, VNAV continues to command a descent
- VNAV remains in VNAV PTH and follows the descent path unless the airplane accelerates to within 5 knots of the current flap placard and the airplane rises more than 150 feet above the path. In this case, VNAV PTH changes to VNAV SPD

The FMC transitions out of approach under the following conditions:

- the airplane lands
- selecting GA
- the airplane flies beyond the missed approach waypoint

A side step to another approach can be accomplished by selection of a new approach on the ARRIVALS page. An along-course intercept to the next logical approach waypoint in the new approach can be selected on the "INTC CRS TO" line on the LEGS page or by selecting the "XXXXX INTC>" prompt on the ARRIVALS page.

Missed Approach

A missed approach is accomplished by selection of either GA switch. The following features are available:

- VNAV (and LNAV) can only be activated when the airplane climbs above 400 feet radio altitude
- all descent altitude constraints below the current airplane altitude are deleted; the waypoints are retained in the active flight plan
- the higher of the altitude in the MCP altitude window or the highest altitude in the missed approach procedure becomes the new cruise altitude
- the FMC transitions from active descent to active climb
- AFDS guidance to fly the published missed approach procedure to the new cruise altitude is active when VNAV (and LNAV) are selected
- when cruise phase is active, the speed target is the most restrictive of 250 knots (below speed transition altitude), best hold speed, or ECON cruise (above speed transition altitude)

Cruise and Descent Profile (Nonprecision Approach)

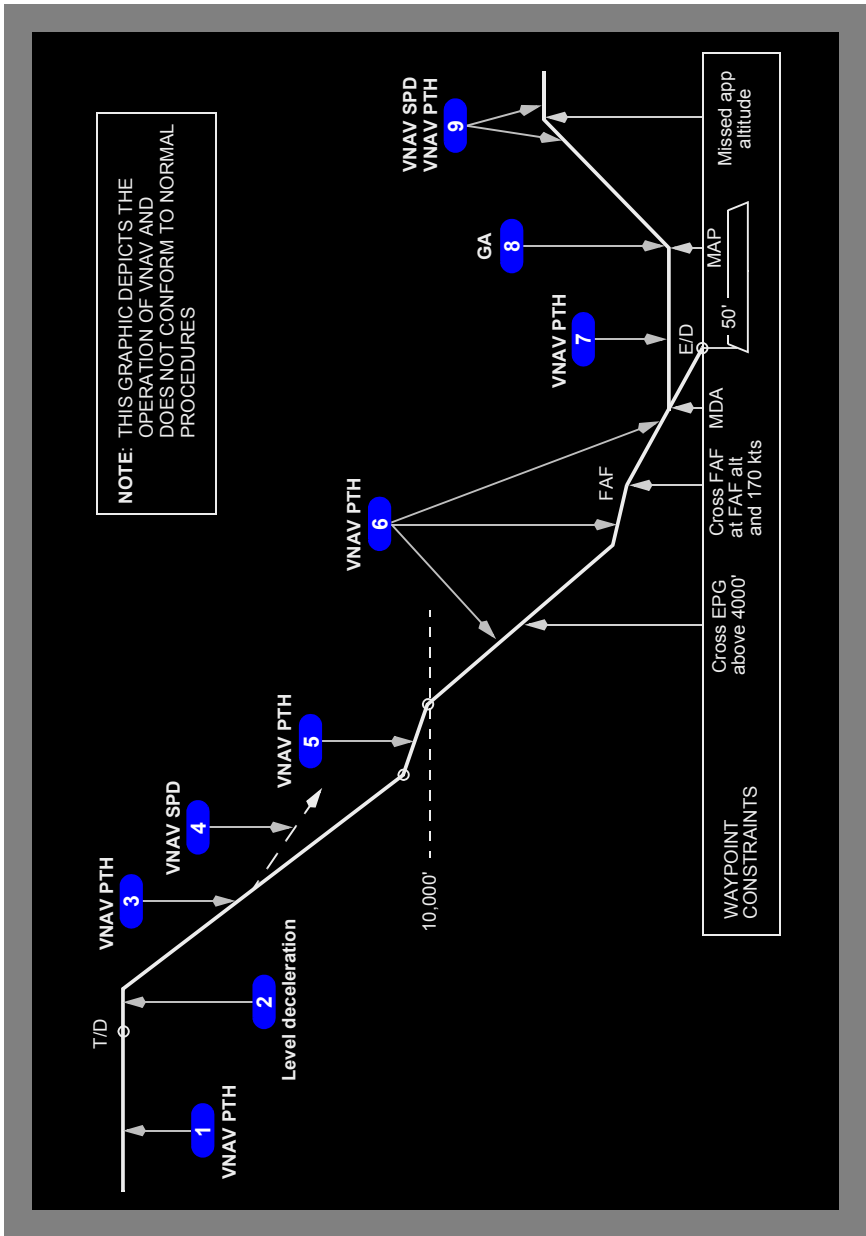

1 Cruise

Before the top of descent, FMC is in cruise mode and uses VNAV PTH and ECON cruise speed.

2 Level descent phase

After top of descent, FMC is in descent mode, VNAV decreases airspeed to ECON descent speed, maintains altitude in VNAV PTH.

3 Descent

Upon reaching descent speed, VNAV descends in VNAV PTH at ECON descent speed.

4 Speed Limit Protection

If a tailwind which was not entered on the descent forecast page causes the airplane to accelerate, the DRAG REQUIRED scratchpad message will be displayed. If the speedbrakes are not deployed, the pitch mode will change to VNAV SPD and depart the path before the speed reaches the limit.

5 Speed Restriction Deceleration

Before the speed restriction altitude, VNAV decelerates to commanded speed using VNAV PTH.

6 Descent and Approach

When at restricted speed, VNAV descends and starts approach in VNAV PTH at commanded speed.

7 Minimum Descent Altitude

When the MDA is reached with VNAV engaged the airplane will maintain the MDA altitude in VNAV PTH.

If the missed approach point is crossed without selecting GA, VNAV will continue to the end of descent point altitude until GA is selected.

8 Go-Around (GA)

The missed approach go-around is commenced by pushing a Go-Around switch.

Pushing a Go-Around switch

- starts a missed approach
- sets go-around thrust
- and deletes altitude constraints between the airplane and the missed approach waypoint.

9 Missed Approach Level Off

If VNAV is selected during missed approach, VNAV engages in VNAV SPD. At the missed approach altitude the pitch mode changes to VNAV PTH.

VNAV Engine Out Operation

The FMC provides single engine performance guidance which is accessed with the ENG OUT prompt on the VNAV pages (CLB, CRZ or DES). After the engine out page is selected the execute key must be pushed to activate the single engine guidance.

The autothrottle system does not have a single engine capability and the autothrottle should be disconnected after an engine failure. VNAV thrust settings and thrust reference modes must be manually set when operating single engine.

Climb (Engine Out Above Engine Out Max Alt)

When the airplane is above the engine out maximum altitude, selection of the ENG OUT> prompt on the CLB page creates a modification and displays the applicable engine out driftdown (D/D) performance data to enable the airplane to descend to the engine out maximum altitude. Execution of the modification activates the engine out driftdown function.

Cruise (Engine Out Above Engine Out Max Alt)

Selection of ENG OUT> may also be selected on the CRZ page. If the current altitude is above the engine out maximum altitude, the FMC will command a cruise drift down.

Selection of ENG OUT> may also be accomplished on the XXXX ALTN page in conjunction with a diversion modification.

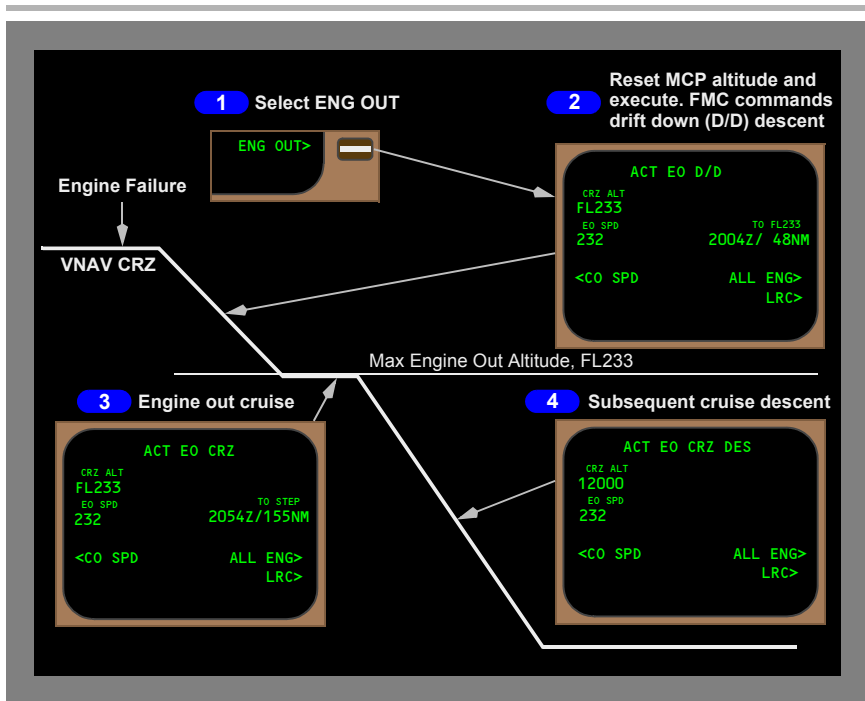

1 Engine Out Modification

Select the ENG OUT> prompt on the VNAV CRZ page. Disconnect the autothrottle and set maximum continuous thrust on the operating engine.

Result: The FMC creates a modification and displays the applicable engine out driftdown (D/D) performance data to enable the airplane to descend to the engine out maximum altitude.

2 Drift Down Execution

Set the MCP altitude at or below EO MAX altitude and execute the FMC modification. This assumes clearance is approved to descend slowly to a non-standard altitude; for example, FL233.

Result: VNAV commands a driftdown at EO SPD, and the EO MAX altitude becomes the cruise altitude at 1L. The descent rate is controlled to a minimum of 300 feet per minute (fpm). Time and distance for the D/D to EO MAX altitude are displayed at 2R.

The initial drift down speed defaults to E/O (minimum drag) speed. Prompts for LRC (long range cruise) and CO SPD (company speed) are displayed or a manual speed entry may be made.

3 Engine Out Cruise

When VNAV captures the engine out maximum altitude, the page changes to the engine out cruise page and the pitch annunciation is VNAV PTH. Predictions for engine out step climb are displayed at 2R.

The VNAV single engine speed can be adjusted to LRC speed, company speed, or a speed entered by the crew. Any change in the single engine speed will change the maximum altitude.

4 Subsequent Cruise Descent

With the FMC in engine out mode more than 50 nm from T/D, set a lower MCP altitude, select the entered altitude from the CDU scratchpad to the CRZ ALT line on the CRZ page and execute.

Result: VNAV cruise descent at approximately 1,250 fpm at the current speed. When the engine out cruise descent intersects the planned descent profile, descent mode becomes active.

Data Entry Rules

Altitude Entry

Altitudes can be entered into the FMC as three digit (XXX), four digit (XXXX), five digit (XXXXX), or flight level (FLXXX) numbers. The FMC displays altitude or flight level entries in the proper form based on the transition altitude. Some data lines further restrict the valid entry forms.

Three digit entries represent altitude or flight levels in increments of 100 feet. Leading zeros are required.

Examples of three digit (XXX, FLXXX) entries with transition altitude = 10,000 feet:

- 800 feet is entered as 008 or FL008; displays as 800
- 1,500 feet is entered as 015 or FL015; displays as 1500
- 11,500 feet is entered as 115 or FL115; displays as FL115
- 25,000 feet is entered as 250 or FL250; displays as FL250.

Four digit entries represent feet, rounded to the nearest ten feet. Leading zeros are required. This form is used when the altitude does not exceed 9,994 feet.

Examples of four digit (XXXX) entries with transition altitude = 18,000 feet:

- 50 feet is entered as 0050; displays as 50
- 835 feet is entered as 0835; displays as 830
- 1,500 feet is entered as 1500; displays as 1500
- 8,500 feet is entered as 8500; displays as 8500
- 9,994 feet is entered as 9994; displays as 9990.

Five digit entries represent feet, rounded to the nearest ten feet. This form is used when the altitude exceeds 9,994 feet

Examples of five (XXXXX) digit entries with transition altitude = 4,000 feet:

- 50 feet is entered as 00050; displays as 50
- 836 feet is entered as 00836; displays as 840
- 1,500 feet is entered as 01500; displays as 1500
- 8,500 feet is entered as 08500; displays as FL085
- 9,996 feet is entered as 09996; displays as FL100
- 11,500 feet is entered as 11500; displays as FL115
- 25,000 feet is entered as 25000; displays as FL250.

Negative altitude entries are allowed to -1000 feet.

Airspeed Entry

Airspeeds can be entered into the FMC as calibrated airspeed (CAS) or Mach number (M). CAS is entered as three digits (XXX) in knots. Mach numbers are entered as one, two, or three digits following a decimal point.

Data Pairs

Many CDU pages display data in pairs separated by a slash "/." Examples of these pairs include wind direction/speed and waypoint airspeed/altitude constraints. When entering both values in a pair, the slash is inserted between the values. When it is possible to enter only one value of the pair, the slash may not be required. When entering only the outboard value of a pair, the trailing or leading slash may be entered, but is not required before transferring to the data line. When entering the inboard value of a pair, the trailing or leading slash must be entered before transferring to the data line. Omission of the required slash normally results in an INVALID ENTRY message.

Intentionally
Blank

FMC Databases

The FMC contains the following databases:

- performance database
- navigation database
- airline modifiable information (AMI).

The performance database supplies all the necessary performance data to the flight crew. It supplies the FMC with the necessary data to calculate pitch and thrust commands. All necessary data can be shown on the CDU. The database includes:

- airplane drag and engine characteristics
- maximum and optimum altitudes
- maximum and minimum speeds.

The navigation database includes data usually found on navigation charts. The database contains:

- the location of VHF navigation aids
- airways
- airports
- runways
- other airline selected data, such as SIDs, STARs, approaches, and company routes
- transition altitudes.

The FMC contains two sets of navigation data, each valid for 28 days. Each set corresponds to the usual navigation chart revision cycle. The flight crew selects which set of navigation data is active for navigation calculations. The contents of the navigation database are periodically updated and are transferred to the FMC before the expiration date of the active data.

The Airline Modifiable Information (AMI) file contains airline specified data. If the FMC senses a conflict in an AMI value after a new AMI data load, the scratchpad shows the message CHECK AIRLINE POLICY.

Thrust Management

The autothrottle is controlled by the thrust management computer. When VNAV is engaged, the FMC controls the autothrottle by setting the command speeds and thrust reference modes on the thrust management computer.

When VNAV is not engaged, the thrust management is controlled by the flight crew through selections made on the TMSP and AFDS.

Fuel Monitoring

The FMC receives fuel quantity data from the fuel quantity system or from manual entries. Fuel quantity values are shown on the PERF INIT page as calculated (CALC), MANUAL, or SENSED. They are shown on PROGRESS page 2 as TOTALIZER and CALCULATED. TOTALIZER and SENSED values are the same data with different names.

The FMC usually uses the calculated value for performance computations. Before engine start, the calculated value is the same as the fuel quantity indicating system totalizer value. When the FMC receives a positive fuel flow signal at engine start, the calculated value is independent of the fuel quantity system and decreases at the fuel flow rate.

The FMC will accept manual entry of the fuel quantity. The line title changes to MANUAL and the manual value is then updated by fuel flow rate. When the fuel quantity calculations are based on a manual entry the FUEL QUANTITY DISAGREE message is inhibited. Deleting the manual entry resets the fuel quantity to the totalizer value and the title returns to CALCULATED.

The calculated value is invalid if fuel flow data is invalid. The FMC uses the fuel quantity indicating system quantity for performance computations. The line title on the PERF INIT page changes to SENSED and is shown as TOTALIZER on PROGRESS page 2. The fuel used by each engine is calculated with its related fuel flow signal.

FUEL USED is also shown on PROGRESS page 2. It is calculated by the FMC from the fuel flow rate beginning at engine start.

Fuel used is reset to zero on the ground after engine shutdown when electrical power is removed or when the FMC receives a positive fuel flow at the next engine start.

The scratchpad shows the message FUEL DISAGREE–PROG 2 (or FUEL DISAGREE–PROG 2/2) if the FMC calculates a large difference between the total fuel value determined by the fuel quantity indicating system and the total fuel value calculated by the FMC. When the fuel disagree message appears, PROGRESS page 2 is used to select one of those two values for use by the FMC for its fuel calculations for the remainder of the flight.

Note: The FUEL DISAGREE message is inhibited if the fuel quantity on the PERF INIT page is entered manually. Deleting a manual entry sets the fuel quantity back to the totalizer value, changes the line title back to CALC and enables the FUEL DISAGREE message.

The FMC continually estimates the fuel at the destination airport if the active route is flown. The CDU message INSUFFICIENT FUEL is shown if the estimate is less than the fuel reserve value entered on the PERF INIT page.

Note: FMC calculated fuel predictions assume a clean configuration. Flight with gear or flaps extended cause fuel prediction errors. Fuel predictions are accurate after the gear and flaps are retracted if the active route in the FMC is flown.

Loss of FMC Electrical Power

The FMC must have continuous electrical power to operate. When the electrical power is interrupted and returns, the FMC automatically restarts.

After the restart, the performance data must be re-entered on the PERF INIT page. The route previously in use is available but must be reactivated.

The flight crew must modify the active waypoint to engage LNAV. Select the applicable active waypoint and proceed direct or intercept a course to the waypoint.

FMC Failure

Single FMC Failure

The scratchpad shows the message SINGLE FMC OPERATION after loss of a single FMC. The EICAS shows the advisory message L (or R) FMC FAIL and the MAP flag is displayed on the side with the failed FMC.

The crew member on the side with the failed FMC selects the opposite FMC with the NAV selector to regain CDU access to the operating FMC and map displays. LNAV and VNAV, if engaged, stay engaged and all flight plan and performance data is kept.

Note: If the MENU page and the scratchpad message TIMEOUT RESELECT is shown, the FMC is no longer connected to the CDU. Use the <FMC prompt on the MENU page to connect the CDU to the FMC.

Dual FMC Failure

In the unlikely event that both FMCs fail, the EICAS advisory messages L FMC FAIL and R FMC FAIL are displayed. LNAV and VNAV are not available.

Selecting CDU-L or CDU-R with the NAV selector on the instrument select panel provides route data to the MAP display. Alternate navigation using the CDUs is discussed in Section 50 of this chapter.

Note: The MENU page is shown and the <FMC prompt is not shown in line 1. Push the LEGS function key to show the IRS LEGS page or the PROG key to show the IRS PROGRESS page.

FMC Resets

A software reset may occur in dual or single FMC operation. When a software reset occurs, the active route becomes inactive, the performance data is erased, and LNAV and VNAV modes (if engaged) fail. There is not an EICAS message or an FMC scratchpad message to alert the crew of a reset condition. To regain FMC operation, activate and execute the flight plan, reenter the necessary performance data, and reengage LNAV and VNAV.

Introduction

FMC preflight is required before flight.

Completion of the FMC preflight requires data entry in all minimum required data locations. Additional entry of optional preflight data optimizes FMC accuracy.

Preflight Page Sequence

The usual FMC power-up page is the identification page. Preflight flow continues in this sequence:

- identification (IDENT) page
- position initialization (POS INIT) page
- ROUTE page
- DEPARTURES page (no automatic prompt)
- performance initialization (PERF INIT) page
- takeoff reference (TAKEOFF REF) page.

Some of these pages are also used in flight.

Minimum Preflight Sequence

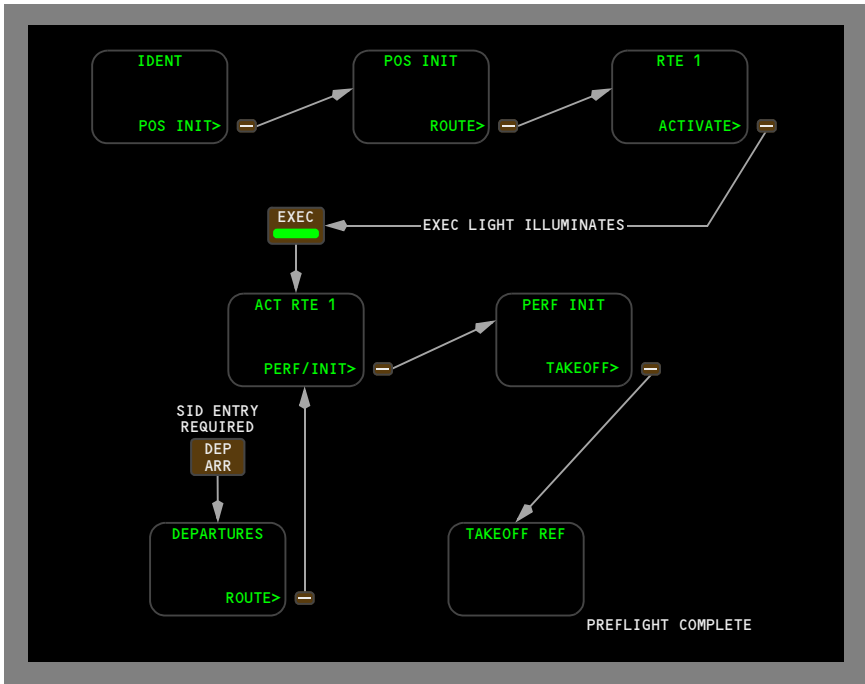

During preflight, a prompt in the lower right directs the flight crew through the minimum requirements for preflight completion. Selecting the prompt key displays the next page in the flow. If a required entry is missed, a prompt on the TAKEOFF page leads the flight crew to the preflight page missing data.

Airplane inertial position is necessary for FMC preflight and flight instrument operation.

A route must be entered and activated. The minimum route data is origin and destination airports, and a route leg.

Performance data including the airplane weight and cruise altitude is required.

Takeoff data requires a flap setting.

Supplementary Pages

Supplementary pages are sometimes required, these pages have no prompts and interrupt the usual sequence. Discussions of each page includes methods to display the page.

When the route includes SIDs and STARs, they can be entered using the DEPARTURES or ARRIVALS pages.

767 Flight Crew Operations Manual

Route discontinuities are removed and the route is modified on the ROUTE and RTE LEGS pages. Speed/altitude restrictions are entered and removed on the RTE LEGS page. The RTE LEGS page is described in the FMC Cruise section of this chapter.

Waypoint, navaid, airport, and runway data is referenced on the REF NAV DATA page. The REF NAV DATA page is described in the FMC Cruise section of this chapter.

Alternate airports are added on the ALTN page. The ALTN page is described in the FMC Descent/Approach section of this chapter.

VNAV performance is improved if forecast winds and temperatures are entered during the preflight.

Wind and temperature information for specific waypoints is entered on the WIND page. The WIND page is described in the FMC Cruise section of this chapter.

Preflight Pages

The preflight pages are presented in the sequence used during a typical preflight.

Initialization/Reference Index Page

The initialization/reference index page allows manual selection of FMC pages. It gives access to pages used during preflight and not usually used in flight.

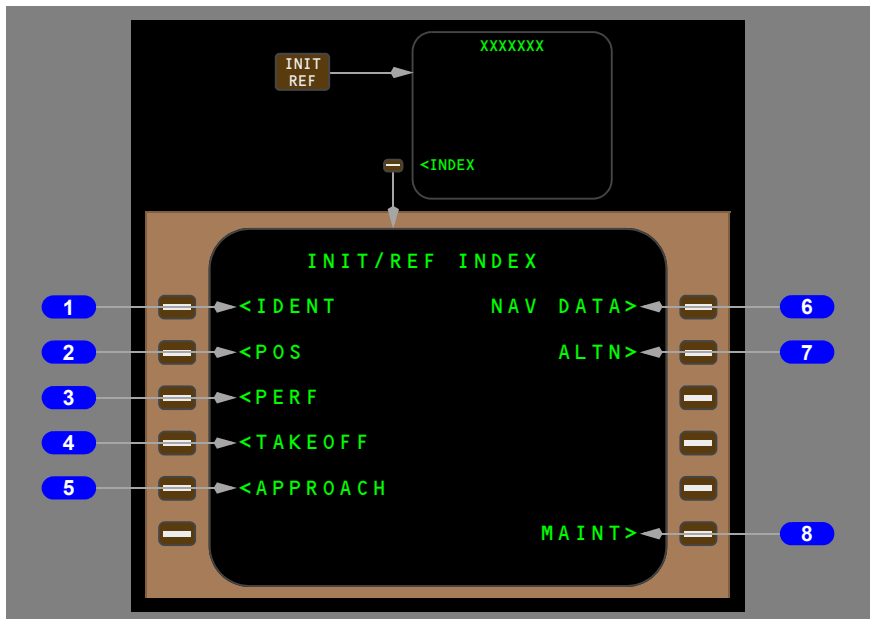

1 Identification (IDENT)

The IDENT page is the first page in the preflight sequence.

2 Position (POS)

The POS INIT page is used for input of reference position for inertial alignment.

3 Performance (PERF)

The PERF INIT page is used for initialization of data required for VNAV operations and performance predictions.

4 TAKEOFF

The TAKEOFF REF page is used to enter takeoff reference data and V speeds.

5 APPROACH

The APPROACH REF page is used to set the approach VREF speed bug on the ADI speed tape for the planned landing flap configuration.

6 Navigation (NAV) DATA

The REF NAV DATA page is used for data on waypoints, nav aids, airports, and runways. NAV DATA pages are accessible only from this page.

7 Alternate (ALTN)

The ALTN page is used for alternate airport planning and diversions.

8 Maintenance (MAINT)

For maintenance use only; displays maintenance pages.

Identification Page

Most of the data on this page is for flight crew verification. The active navigation database can be selected.

The flight crew verifies FMC data, selects the current navigation database, and checks drag and fuel flow factors on the identification page.





1 MODEL

Displays the airplane model from the FMC performance database.

2 Navigation (NAV) DATA

Displays the navigation database identifier.

3 Operating (OP) PROGRAM

Displays the operating program identifier.

4 Operational Program Configuration (OPC) PART NUMBER

Displays the Operational Program Configuration part number.

5 INDEX

Push – displays the INIT/REF INDEX page.

6 ENGINES

Displays the engine model from the FMC performance database.

7 ACTIVE

Displays range of effective dates for the active navigation database.

The active navigation database can be replaced with the inactive database while on the ground. Changing the navigation database removes all previously entered route data.

8 Inactive Date Range

Displays range of effective dates for the inactive navigation database. May be line selected to the scratchpad and inserted to the ACTIVE line while on the ground.

9 Company (CO) DATA

Displays the last eight characters of the Airline Modifiable Information (AMI) part number.

10 DRAG/Fuel Flow (FF) Factors

Displays the airplane drag and fuel flow correction factors.

For maintenance use only.

11 Position Initialization (POS INIT)

Push – displays the POS INIT page.

Position Initialization Page

The position initialization page allows entry of airplane present position for IRS alignment. This page is also used to enter the heading when an IRS is in the ATT mode.

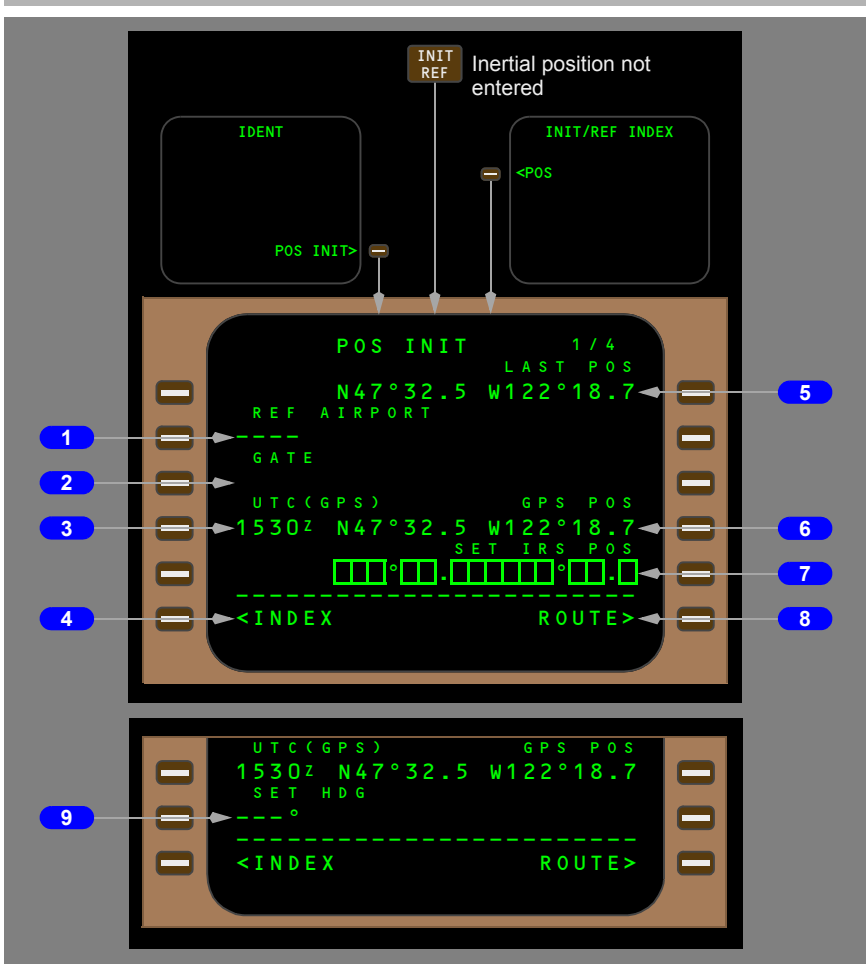

1 Reference Airport (REF AIRPORT)

Entry of the reference airport displays the airport latitude/longitude.

Optional entry.

Valid entries are ICAO four letter airport identifiers.

Removes previous GATE entry.

Entry blanks when airborne.

2 GATE

The gate entry allows further refinement of the latitude/longitude position.

Optional entry after reference airport entered.

Valid entry is a gate number at the reference airport.

Displays the latitude and longitude of the reference airport gate.

Changes to dashes when a new reference airport is entered.

Entry blanks when airborne.

3 Universal Time Coordinated (UTC)

UTC (GPS) – displays time from GPS.

UTC (MAN) –

- displays time from captain's clock when operative; otherwise, displays time from first officer's clock
- hours can be set by entering desired hour reference
- minutes set by resetting appropriate pilot's clock.

4 INDEX

Push – displays the INIT/REF INDEX page.

5 Last Position (LAST POS)

Displays the last FMC calculated position.

6 GPS Position (GPS POS)

Displays the GPS present position. During preflight, the GPS POS may not display due to satellite availability, performance, or unfavorable geometry.

7 Set IRS Position (SET IRS POS)

The set inertial position entry is required to initialize the IRS. Select the most accurate latitude/longitude from LAST POS, REF AIRPORT, GATE, GPS POS, or a manual entry to initialize the IRS.

If an entry is not made before the IRS completes the initial alignment, the scratchpad message ENTER IRS POSITION is displayed.

If the manually entered position fails the IRS internal check, the scratchpad message ENTER IRS POSITION is displayed.

The manually entered position is also compared with the FMC origin airport position. If the entered position is not within 6 NM of the FMC origin airport position, the scratchpad message IRS POS/ORIGIN DISAGREE is displayed.

Boxes display within one minute of IRS power-up.

Blanks when the IRS changes from the alignment to the navigation mode.

8 ROUTE

Push – displays the ROUTE page.

9 Set Heading (SET HDG)

Dashes display when an IRS selector is placed in the ATT position.

Enter magnetic heading to initialize the IRS in the ATT mode to provide headings. Heading should be updated regularly if extended operation in ATT is necessary.

Valid entry is 0 to 360 (0 or 360 displays as 0°).

Position Reference Pages

The position reference pages are not part of a normal preflight. They are presented here in a logical sequence because they are accessed from the position initialization page.

Position Reference Page 2/4

Position reference page 2 displays positions calculated by the FMC, IRS, GPS, and radio navigation receivers. The FMC position can be updated to IRS, GPS, or radio position on this page.

Positions are displayed as the latitude/longitude calculated by the individual systems. When BRG/DIST is selected the IRS, GPS, and radio positions are shown as bearing and distance from the FMC position.

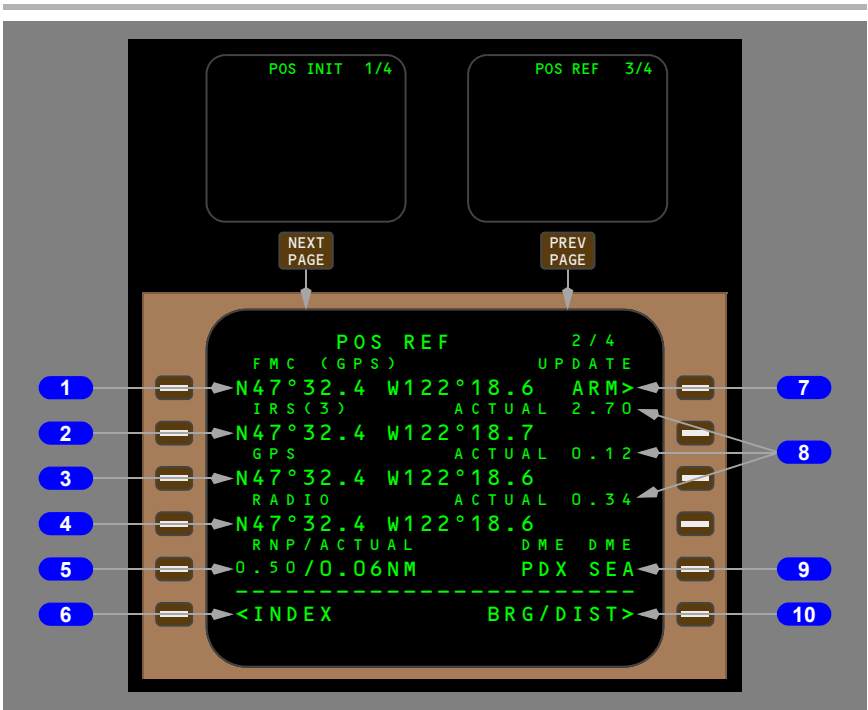
**1 FMC**

The source used by the active FMC for position data is displayed next to the FMC line title. In the example, the FMC uses GPS for position data.

Displays the FMC calculated latitude/longitude.

Identifies the source for calculating the FMC position:

- GPS – position calculated from GPS and inertial position data
- IRS – position calculated from inertial position data only
- RADIO – position calculated from navigation radio and inertial position data
- LOC–GPS – position is calculated from localizer, GPS and inertial data
- LOC–RADIO – position is calculated from localizer, navigation radio and inertial data
- LOC – position is calculated from localizer and inertial data.

2 IRS

Displays latitude/longitude position or the bearing and distance from the FMC position determined by the IRS. If the displayed position is derived from all three IRSs, (3) is displayed. If the position is from a single IRS then (L), (C), or (R) is displayed to indicate which IRS position is displayed.

3 GPS

Displays latitude/longitude position or the bearing and distance from the FMC position determined by the GPS.

4 RADIO

After airborne, displays latitude/longitude position or the bearing and distance from the FMC position determined by navigation radios.

5 Required Navigation Performance and Actual Navigation Performance (RNP /ACTUAL)

Displays the RNP and actual navigational performance (ACTUAL) of the FMC. Default RNP is in small font.

Valid RNP entries are in the range 0.01 to 99.9. ACTUAL entry not allowed.

When ACTUAL exceeds RNP, EICAS displays UNABLE RNP message.

Note: The FMC stops GPS updating if GPS data accuracy degrades due to satellite availability or unfavorable geometry. Subsequently, the FMC receives updates from another system.

6 INDEX

Push – displays the INIT/REF INDEX page.

7 UPDATE ARM

Push –

- arms FMC position update function
- changes prompt to ARMED
- adds NOW prompts to right side of INERTIAL, GPS, and RADIO lines.

Push a NOW prompt key to momentarily update FMC position to the selected source. If another source with a smaller ANP exists, the FMC position will correct back to the most accurate position available.

8 ACTUAL

Displays actual navigation performance (ANP) of the IRS, GPS and navigation radios.

9 Radio Update Station(s)/Mode

Displays radio station identifiers.

Position update mode is indicated in the line title:

- DME DME
- VOR DME

Line and title are blank when no radio position is computed.

10 Bearing/Distance (BRG/DIST) or Latitude/Longitude (LAT/LON)

Push – alternates position data format between bearing/distance or latitude/longitude.

The page illustration is shown in the latitude/longitude display format.

Latitude/longitude format displays are actual position. Bearing/distance display is relative to the FMC position.

Position Reference Page 3/4

On position reference page 3, the flight crew can observe the calculated positions from the left and right GPS receivers and the left and right FMC calculations. This page also allows the flight crew to enable or disable GPS position updates.

This page can display the bearing/distance or latitude/longitude format. The bearing/distance format displays the positions relative to the active FMC position on the POS REF 2/4 page.

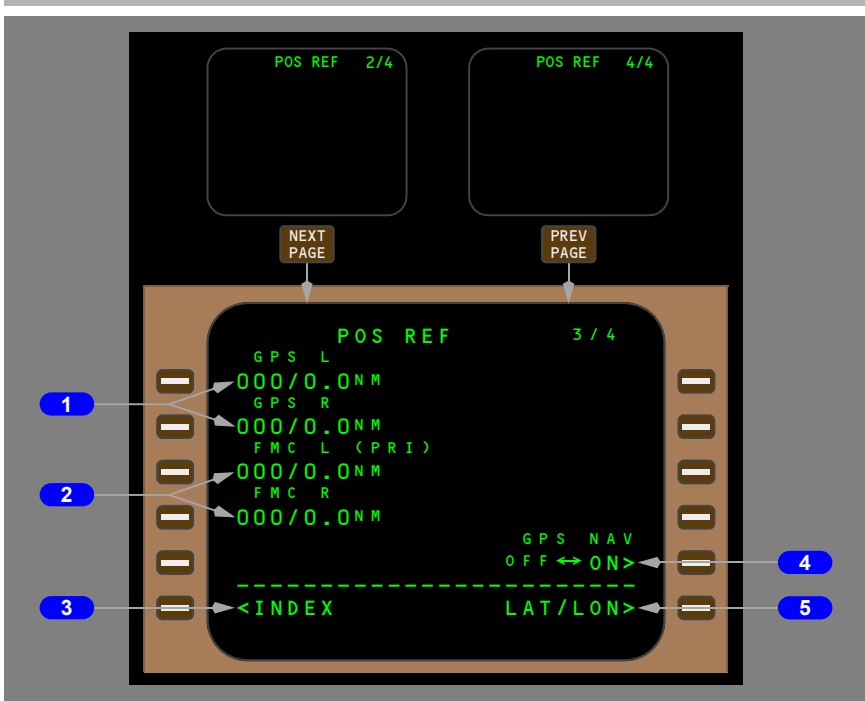

1 GPS L and GPS R

Displays the left and right GPS positions.

2 FMC L and FMC R

Displays the left and right FMC calculated position.

Primary (PRI) is displayed in line title of the FMC that is the navigation master.

3 INDEX

Push – displays the INIT/REF INDEX page.

4 GPS NAV

Push – alternately selects GPS NAV ON (enabled) and OFF (disabled).

OFF – GPS position data is not available to the FMC. OFF displays in large letters; ON displays in small letters.

ON – GPS position data is available to the FMC. ON displays in large letters; OFF displays in small letters.

Note: When the engines are shut down after flight GPS NAV is set to ON.

5 Latitude/Longitude (LAT/LON) or Bearing/Distance (BRG/DIST)

Push – alternately changes the display of position data on POS REF 2/4, 3/4, and 4/4 to latitude/longitude format or bearing/distance format.

The page illustration is shown in the bearing/distance display mode.

Position Reference Page 4/4

On position reference page 4, the calculated positions and ground speeds from the left, center and right IRS are displayed. Positions can be displayed in the bearing/distance or latitude/longitude format.

**1 IRS L, C, and R**

Displays the position of the Left, Center, and Right IRS. Positions can be displayed in latitude longitude or as bearing and distances from the FMC position.

2 INDEX

Push – displays the INIT/REF INDEX page.

3 Ground Speed (GS)

Displays the ground speed calculated by each IRS. The displayed values are frozen when the engines are shut down after flight until power is removed.

4 Latitude/Longitude (LAT/LON) or Bearing/Distance (BRG/DIST)

Push – alternately changes the displayed position between latitude/longitude format and bearing/distance format. When the display is in the bearing/distance format the prompt shows LAT/LON>.

Route Page

Two routes (RTE 1 and RTE 2) can be stored and displayed in air traffic control format. The first route page displays origin and destination data. Subsequent route pages display route segments between waypoints or fixes. Having two routes allows management of alternate or future routes while leaving the active route unmodified. RTE 2 has an identical page structure as RTE 1.

Route Page 1/X

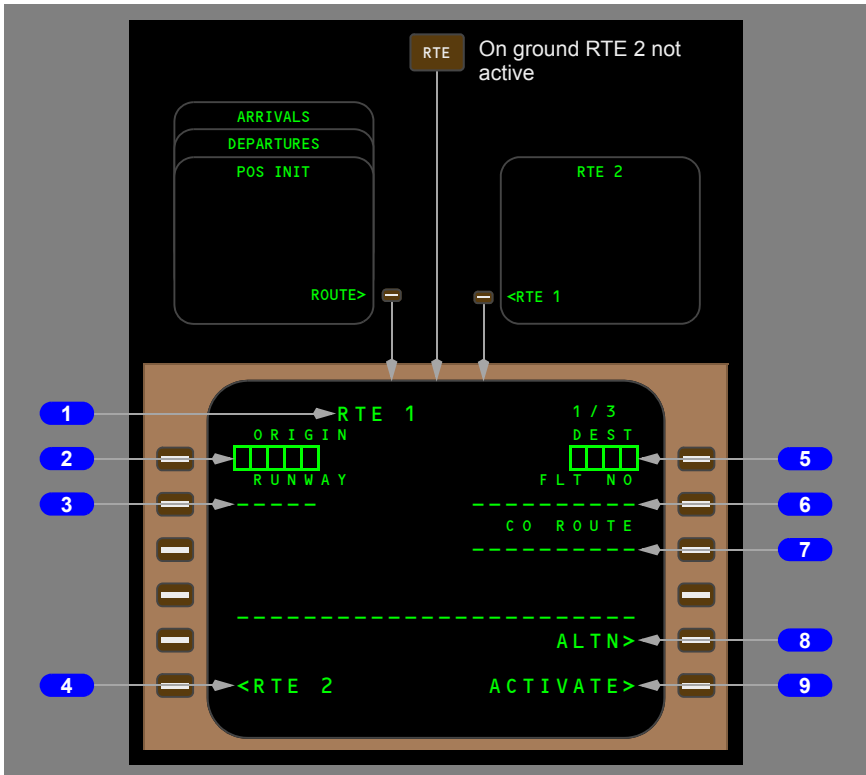

1 Page Title

Preceded by ACT when the route is active, and by MOD when the route is modified and the change is not executed.

Multiple route pages are indicated by the page sequence number to the right of the title. The minimum number of route pages is 2.

2 ORIGIN

Entry:

- must be a valid ICAO identifier in the navigation database
- made automatically when a company route is entered
- enables direct selection of departure and arrival procedures
- required for route activation
- inhibited in-flight for active route.

Entry on the ground deletes existing route.

3 RUNWAY

Enter the applicable runway for the origin airport. Runway must be in the navigation database.

Entry:

- is optional
- causes MOD to display in the title if route is active
- can be selected on the DEPARTURES page
- can be included in company route.

The runway is deleted after the first waypoint is crossed.

4 Route (RTE) 2

Push – displays the RTE 2 page 1/x.

Allows access to an inactive route for entry, modification or activation.

Inactive route modifications:

- do not alter the active route
- do not change the inactive RTE page title.

Prompt changes to RTE 1 when RTE 2 is displayed.

5 Destination (DEST)

Entry:

- must be a valid ICAO identifier in the navigation database
- made automatically when a company route is entered
- enables direct selection of destination arrival procedures
- required for route activation
- displays MOD in page title if entered in an active route.

6 Flight Number (FLT NO)

Enter the company flight number.

Entry:

- optional for activation of the route
- limited to 10 characters
- may be entered by the flight crew or uplinked
- included in the PROGRESS page title
- propagated to RTE 2 page
- deleted at flight completion.

7 Company Route (CO ROUTE)

A company route can be called from the navigation database by entering the route identifier. The data supplied with a company route can include origin and destination airports, departure runway, SID and STAR, and the route of flight. All company route data is automatically entered when the route identifier is entered.

An entry is optional for activation of the route.

Valid entry is any flight crew entered or uplinked company route name. If the name is not contained in the navigation database, the entry is allowed and the scratchpad message NOT IN DATABASE is displayed.

Entry of a new company route replaces the previous route.

In-flight entry is inhibited for the active route.

8 Alternate (ALTN)

Push – displays the ALTN page.

9 ACTIVATE

Push the ACTIVATE key to arm the route and illuminate the execute light. When the EXEC key is pushed, the route becomes active, ACT is displayed in the title, and the ACTIVATE prompt is replaced with the next required preflight page prompt.

Activation of a route is required for completion of the preflight.

ACTIVATE is always displayed on the inactive route pages.

After route activation, the ACTIVATE prompt is replaced by:

- PERF INIT, when the required performance data is incomplete, or
- TAKEOFF when the required performance data is complete.

More Route Page Prompts for an Active Route

Additional prompts are displayed on the route page once it becomes active.



1 Route Copy (RTE COPY)

Push – copies the entire active route (RTE x) into the inactive route (RTE y).

Displayed only on the active route page.

Displays COMPLETE after the route is copied.

Route Page 2/X

The subsequent route pages 2/X through X/X, display route segments in air traffic control format. Route segments are defined as direct routing, airways, or procedures with start and end points such as waypoints, fixes, navaids, airports, or runways. More waypoints for each route segment are shown on the RTE LEGS page.

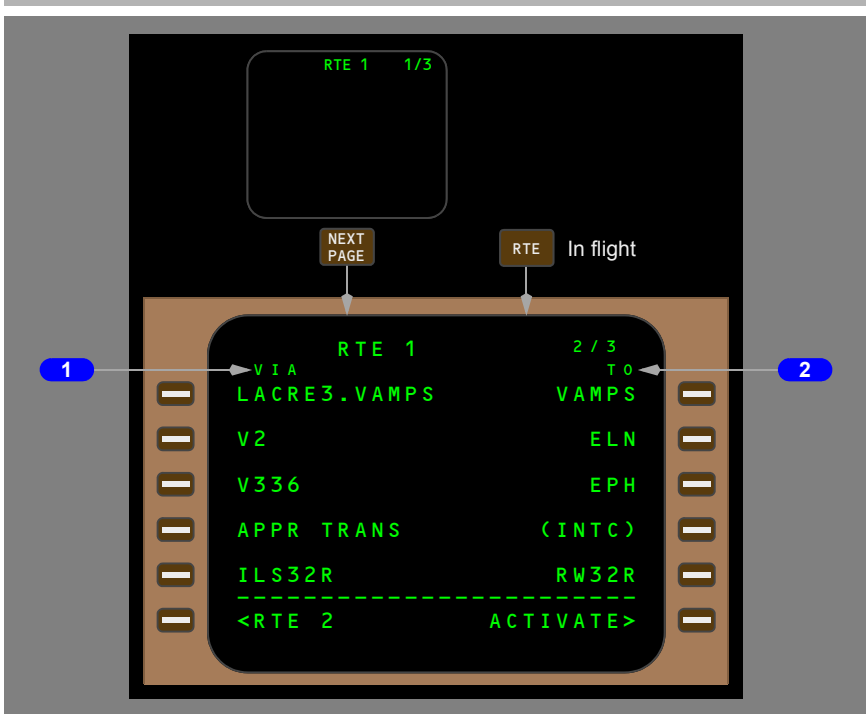

1 VIA

The VIA column displays the route segment to the waypoint or termination in the TO column. Enter the path which describes the route segment between the previous waypoint and the segment termination.

Enter an airway in the VIA column and boxes display in the TO column.

Valid entries can also include procedures or DIRECT. Procedures are usually entered through selections on DEPARTURES and ARRIVALS pages. DIRECT is usually entered as a result of entering a TO waypoint first.

Valid airways must:

- contain the fix entered in the TO waypoint, and
- contain the previous TO waypoint, or
- intersect the previous VIA route segment.

Dashes change to DIRECT if the TO waypoint is entered first.

Dashes display for the first VIA beyond the end of the route.

Invalid VIA entries result in the scratchpad message INVALID ENTRY.

Invalid VIA entries are:

- airways and company routes which do not contain the TO waypoint of the previous line
- airways that do not intersect the previous airway
- airways or company routes that are not in the navigation database.

The start and end waypoints determine whether the entered airway is valid. The route segment must contain the waypoint entered in the TO position. The TO waypoint of the previous route segment must be the same as the start point of the next route segment or a route discontinuity is created between the segments.

Entry of a SID or transition enters the VIA and TO data for the route segments of the SID. A SID links to the next route segment when the final SID waypoint is part of the route segment.

When no SID is used, entering an airway on the first line of page 2 initiates an airway intercept from the runway heading and:

- replaces the airway with dashes in the first line VIA
- shows boxes in the first line TO waypoint
- moves the airway to line 2 after the TO waypoint is entered
- enters the first fix on the airway nearest to being abeam of the departure heading in the airway line TO waypoint.

A route can contain segments formed by the intersection of two airways. Entering two intersecting airways in successive VIA lines without a TO waypoint causes the FMC to create an airway intersection waypoint to change from one segment to the next. The FMC created waypoint intersection (INTC) displays in the first airway segment TO waypoint.

LACRE3.VAMPS is an example of a SID selection made on the DEPARTURES page.

V2 and V336 are examples of airway entries.

APP TRANS is an example of a STAR selection made on the APPROACH page.

ILS32R is an example of an approach selection made on the APPROACH page.

2 TO

Enter the end point of the route segment specified by the VIA entry.

Entry of a waypoint in the TO column without first entering a VIA airway shows DIRECT in the VIA column.

Data input is mandatory when boxes are displayed.

Valid waypoint entries for a DIRECT route segment are any valid waypoint, fix, navaid, airport, or runway.

Valid waypoint entries for airways are waypoints or fixes on the airway.

Dashes display on the first TO waypoint after the end of the route.

Preflight Pages – Part 2

Departure/Arrival Index Page

The departure and arrival index page is used to select the departure or arrival page for the origin and destination airports for each route. The index also allows reference to departure or arrival data for any other airport in the navigation database.

Departure and arrival prompts are available for the origin airport. Destination airports have only arrival prompts.

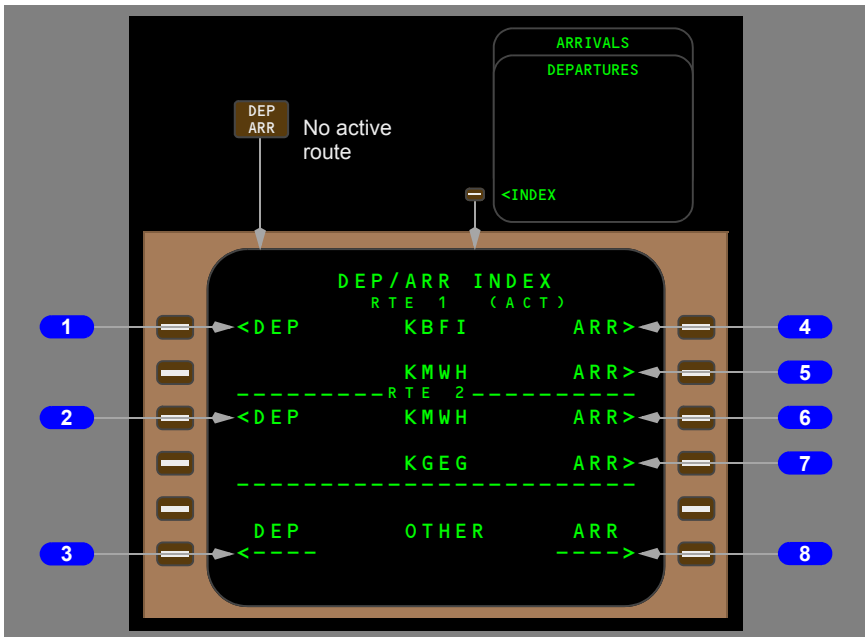

1 Departure (DEP) – Route 1

Push – displays the departure page for route 1 origin airport.

2 Departure (DEP) – Route 2

Push – displays the departure page for route 2 origin airport.

3 Departure (DEP) – Other

Displays the departure page for the airport entered into this line through the scratchpad.

DEP prompt for OTHER allow display of departure data about airports that are not the origin or destination for route 1 or 2. The data can be viewed but cannot be selected because the airport is not on the route.

4 Arrival (ARR) – Route 1 Origin

Push – displays the arrival page for route 1 origin airport. Origin airport arrivals selection is used during a turn-back situation.

5 Arrival (ARR) – Route 1 Destination

Push – displays the arrival page for route 1 destination airport.

6 Arrival (ARR) – Route 2 Origin

Push – displays the arrival page for route 2 origin airport. Origin airport arrivals selection is used during a turn-back situation.

7 Arrival (ARR) – Route 2 Destination

Push – displays the arrival page for route 2 destination airport.

8 Arrival (ARR) – Other

Displays the arrival page for the airport entered in this line through the scratchpad. ARR prompt for OTHER allows display of arrival data about airports that are not the origin or destination for route 1 or 2. The data can be viewed but cannot be selected because the airport is not on the route.

Departures Page

The departures page is used to select the departure runway, SID, and transition for the route origin airport.

The departures page for the inactive route displays when the DEP ARR function key is pushed with an inactive RTE or RTE LEGS page is displayed.

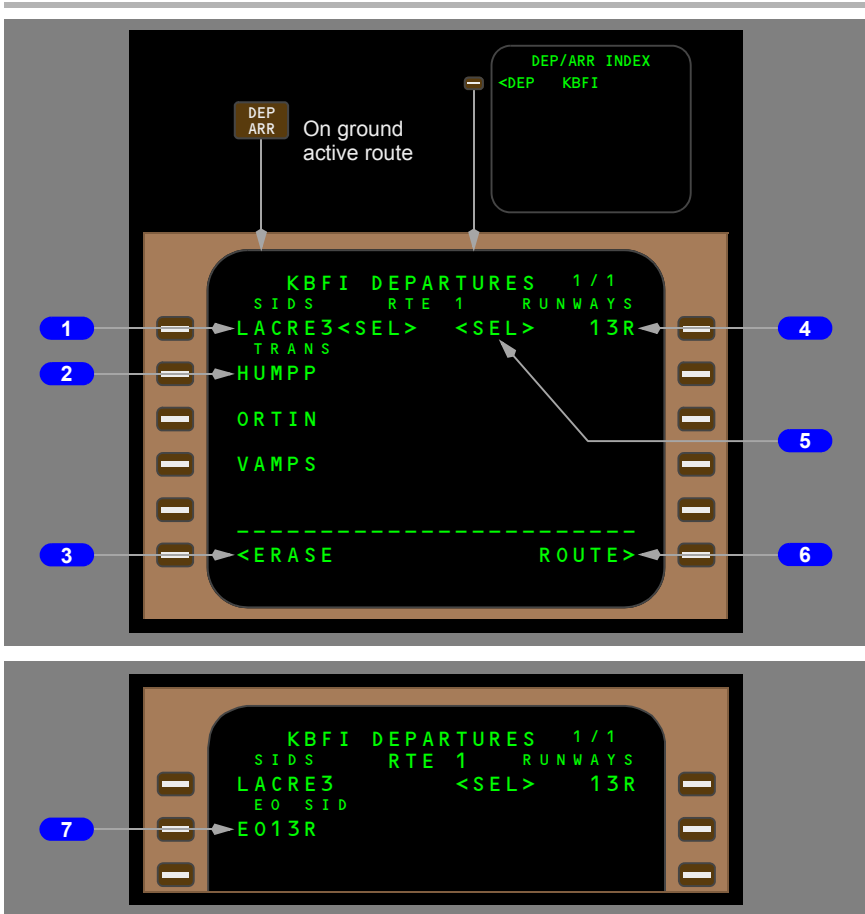

1 Standard Instrument Departures (SIDS)

Displays a list of SIDS for the airport.

Push –

- selects SID for use in the route
- other SIDs are no longer displayed and the transitions for the selected SID are displayed
- runways for selected SID remain and others are no longer displayed.

2 Transitions (TRANS)

Displays transitions compatible with the selected SID.

Push –

- selects transition for entry in the route
- other transitions no longer display.

3 ERASE or INDEX

Erase displays when a route modification is pending. INDEX displays when no route modification is pending.

ERASE push – removes route modifications not executed and displays the original route.

INDEX push – displays the DEP/ARR INDEX page.

4 RUNWAYS

Displays a list of runways for the selected airport.

The runway selected on the RTE 1/X page displays as <SEL> or <ACT>.

Push –

- selects runway for use in the route. All other runways no longer display
- SID's associated with selected runway remain, all others no longer display
- subsequent change of a runway deletes departure procedures previously selected.

5 <SEL>, <ACT>

Selecting an option displays <SEL> inboard of the option and creates a route modification. After executing the modification, <SEL> becomes <ACT>.

Executing a modification or leaving the page and returning displays all options and the <SEL> or <ACT> prompts.

6 ROUTE

Push – displays the related RTE page.

7 Engine Out Standard Instrument Departure (EO SID)

EO SID's are airline designed procedures for specific runways. When a runway is selected the EO SID is listed after the other SID's associated with that runway. If no EO SID exists for the selected runway, NONE is displayed.

PUSH – on the ground, selects the EO SID as a route modification for review. The modification should be erased after the review is complete.

If an engine failure occurs after takeoff before the flaps are retracted, the EO SID will be automatically loaded as a route modification to be executed or erased.

Navigation Radio Page

VOR navigation radios are normally autotuned by the FMC. The NAV RADIO page displays the tuned VOR frequencies, identifiers, tuning status and current radial for both VOR receivers. The VORs can be remotely tuned from this page.



1 VOR Frequency and Tune Status

Displays the frequency and identifier of the tuned navaids and allows input of frequencies or identifiers to remote tune the VORs. Dashes are displayed if the VOR is not tuned.

The tuning status is displayed adjacent to left and right VOR frequencies. Entry of a frequency or identifier remotely tunes a VOR. The FMC autotunes VORs and their related DMEs for procedure flying and radio positions. The tuning status displays are:

- A (autotuning) – FMC selects a navaid for best position orientation
- P (procedure autotuning) – FMC selects navaids for approach or departure procedure guidance
- R (remote tuning) – VOR frequency or identifier has been entered by the flight crew on the NAV RADIO page
- M (manual) – VOR is manual-tuned using the VOR control panels on the glareshield. Manual-tuning takes priority over FMC autotuning.

Valid entries:

- VOR, non-ILS DME, or ILS DME identifier
- VOR frequency (XXX.X or XXX.XX).

2 RADIAL

Displays the current radial from the left and right VOR stations to the airplane.

Performance Initialization Page

The performance initialization page allows the entry of airplane and route data to initialize performance calculations. This data is required for VNAV operation.

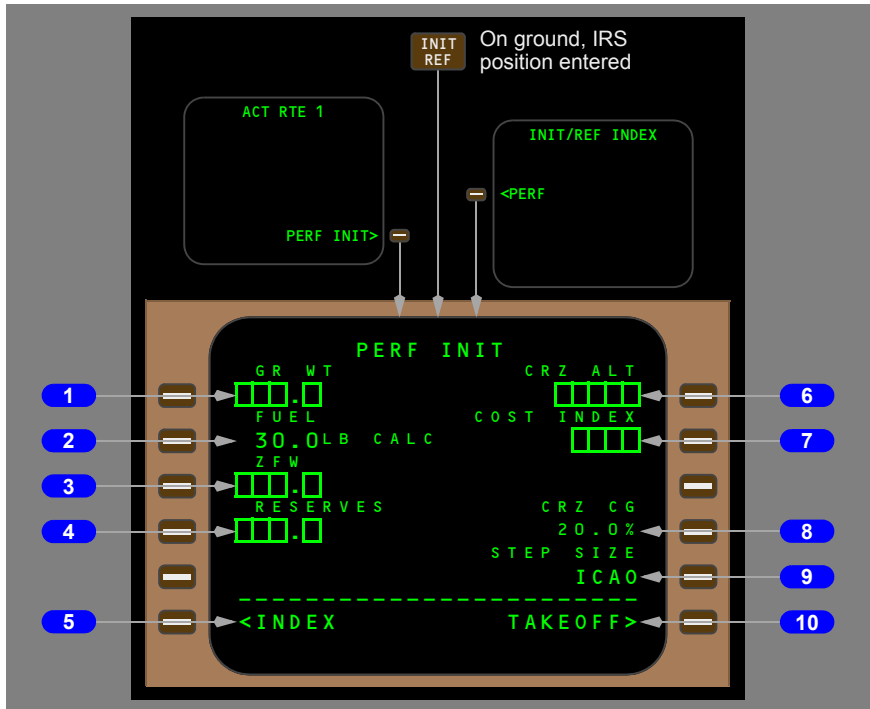
Performance Initialization Page**1 Gross Weight (GR WT)**

Airplane gross weight can be entered by the flight crew or calculated by the FMC after entry of zero fuel weight.

Valid entry is thousands of pounds with a decimal (hundreds) optional.

Entering the zero fuel weight first displays calculated gross weight.

Entry of a value after takeoff speeds are selected removes the speeds and displays the scratchpad message TAKEOFF SPEEDS DELETED.

2 FUEL

Fuel on board displays when the fuel totalizer calculations are valid. The source for the display is included in the line:

- SENSED – fuel quantity is from the totalizer.
- CALC (calculated) – fuel quantity is from FMC calculations. Manual entry is possible
- MANUAL – fuel quantity has been manually entered. Manual entries blank totalizer on PROGRESS page 2/3.

Valid entry is thousands of pounds with a decimal (hundreds) optional.

Only manual entries can be deleted. The display returns to the sensed (totalizer) value when a manual entry is deleted.

3 Zero Fuel Weight (ZFW)

Normally, ZFW is entered from the airplane dispatch papers and the FMC calculates the airplane gross weight.

Valid entry is thousands of pounds with a decimal (hundreds) optional.

Calculated zero fuel weight displays when airplane gross weight is entered first and fuel on board is valid.

Entry of a value after takeoff speeds are selected removes the speeds and displays the scratchpad message TAKEOFF SPEEDS DELETED.

ZFW may be manually entered or uplinked. When a performance uplink is pending, uplinked values (small font) display beside the entered values (large font).

4 RESERVES

Valid entry is thousands of pounds with a decimal (hundreds) optional.

Can be manually entered or uplinked. When a performance uplink is pending, uplinked values (small font) display beside the entered values (large font).

5 INDEX

Push – displays the INIT/REF INDEX page.

6 Cruise Altitude (CRZ ALT)

Cruise altitude can be entered by the flight crew or from a company route or uplink.

Entered value is displayed on the CLB and CRZ pages.

7 COST INDEX

Cost index is used to calculate ECON climb, cruise, and descent speeds. Larger values increase the ECON cruise speed. Entering zero results in maximum range airspeed and minimum trip fuel. Cost index can be entered by the flight crew or from a company route or uplink.

Valid entries are 0 to 9999.

8 Cruise Center of Gravity (CRZ CG)

Used by FMC to compute maximum altitude and maneuver margin to buffet.

Displays default center of gravity.

Can be manually entered or uplinked.

Default value displays in small font.

A flight crew entered or unlinked value displays in large font.

9 STEP SIZE

Displays the climb altitude increment used for planning the optimum climb profile.

Default value is ICAO which provides a 2000 foot step below FL290 and a 4000 foot step above FL290.

Valid manual entries are 0 to 9000 in 1000 foot increments.

In-flight entries are inhibited. In-flight step size changes are made on the CRZ page.

For a non-zero entry, performance predictions are based on step climbs at optimum points. For a zero entry, performance predictions are based on a constant CRZ ALT.

10 TAKEOFF

Push – displays the TAKEOFF REF page.

Takeoff Reference Page

The takeoff reference page allows the input of the final performance data required for takeoff. Entries on the takeoff reference page complete the normal FMC preflight. If any required preflight data has been omitted, a prompt is displayed to access the page where data is missing.

Takeoff Reference Page

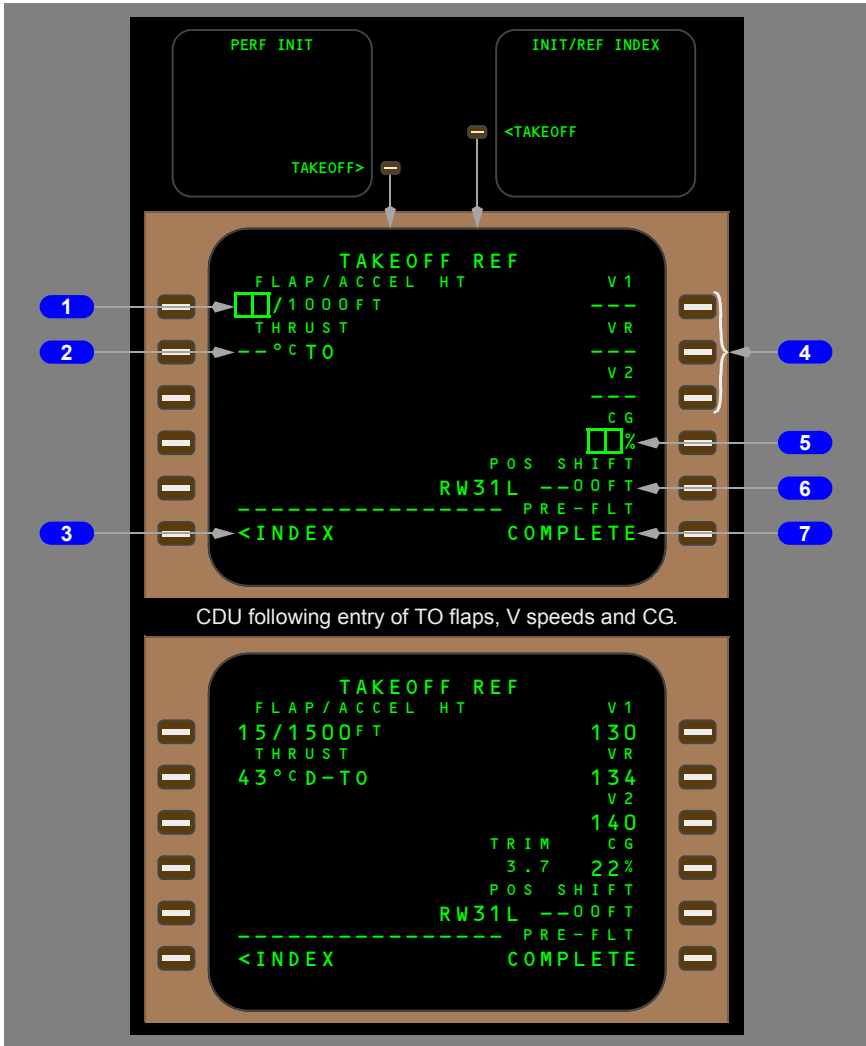

1 Flap/Acceleration Height (FLAP/ACCEL HT)

Enter a valid takeoff flap setting: 5, 15, or 20.

Entry of a value after takeoff speeds are entered removes the speeds and displays the scratchpad message TAKEOFF SPEEDS DELETED.

ACCEL HT displays the acceleration height in feet above the origin airport. VNAV commands acceleration at this altitude or at first flap retraction.

Default value is from the AMI.

Valid flight crew entries are from 400 to 9999 feet above the origin airport elevation.

2 THRUST

Initially displays dashes and the thrust reference mode.

If an assumed temperature value is entered on the thrust management select panel, the entered temperature is displayed here.

Allows entry of an assumed temperature which is used by the TMC. Entries can be made in degrees Celsius or Fahrenheit. Fahrenheit entries must be suffixed with an F. The entered value is displayed on EICAS.

Entry of a value after takeoff speeds are entered removes the speeds and displays the scratchpad message TAKEOFF SPEEDS DELETED.

3 INDEX

Push – displays the INIT/REF INDEX page.

4 V Speeds

Dashes are displayed before speeds are entered and when speeds have been deleted.

Flight crew entered speeds are displayed in large font. "V1" and "VR" are displayed on the ADI speed tape.

If performance data is changed after speeds are entered, the speeds are deleted, dashes are displayed, and the scratchpad message TAKEOFF SPEEDS DELETED is displayed.

5 TRIM, Center of Gravity (CG)

Valid entry is CG within the valid range.

After the CG is entered, the FMC calculates and displays the stabilizer takeoff trim setting to the left of the CG entry.

6 Position Shift (POS SHIFT)

Displays the departure runway from the active RTE page and allows entry of a distance between departure runway threshold and where the autothrottle will be engaged for takeoff.

The FMC updates its position to the departure runway threshold when the autothrottle is engaged for takeoff. If a position shift distance is entered, upon autothrottle engagement the FMC updates its position to that entered distance from the departure runway threshold.

If an intersection takeoff is planned, the intersection identifier or a positive value should be entered. If a displaced threshold takeoff is planned a negative value should be entered.

Valid position shift entries are from 99 to – 99 in hundreds of feet.

Entry of a value after takeoff speeds are selected removes the speeds and displays the scratchpad message TAKEOFF SPEEDS DELETED.

POS SHIFT update is inhibited when GPS is primary FMC navigation source (i.e GPS NAV is ON).

7 Pre-Flight (PRE–FLT) Status

Displays COMPLETE if all required pre–flight entries have been made.

Displays a prompt to access a pre–flight page where further entries are required if pre–flight is not complete.

Menu Page

The MENU page allows access to other airplane systems which are controlled with the CDU.

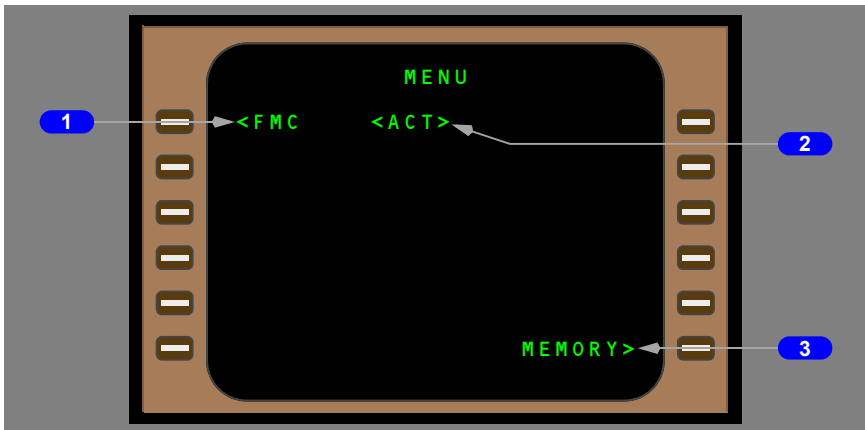

1 FMC

Push – connects FMC to CDU

2 **CDU Status**

- <ACT> – indicates system currently controlling CDU
- <REQ> – indicates inactive CDU function requiring pilot action
- blank – indicates function is not selected or requiring action

3 **MEMORY (not displayed while airborne)**

Push – displays maintenance memory page, providing access to computer memory for maintenance while the airplane is on the ground

Intentionally
Blank

Introduction

The takeoff phase of flight starts with the selection of takeoff thrust at the start of the takeoff roll.

If GPS navigation is not available the FMC position is updated to the takeoff runway position when the autothrottle is engaged for takeoff.

The takeoff mode of the autoflight system provides flight director guidance until LNAV and VNAV are engaged after takeoff. Preparation for this phase starts in the preflight phase and includes entry of the TAKEOFF REF page data.

The takeoff phase changes to the climb phase when climb thrust and VNAV are engaged. The climb phase continues to the top of climb point, where the cruise phase starts.

Takeoff Phase

When changes are made to the departure runway and SID, the DEPARTURES and TAKEOFF REF pages must be modified to agree. The modified data is entered the same as during preflight.

During takeoff, the autothrottle commands the selected thrust and the autoflight system provides pitch and roll commands through the flight director.

When armed before takeoff, LNAV engages at 50 feet radio altitude. When engaged, FMC roll commands fly the active route leg.

Climb Phase

When climb thrust and VNAV are engaged the FMC provides pitch commands to maintain the climb speed until the acceleration height is reached. At the acceleration height the FMC provides pitch commands to accelerate.

The VNAV commanded speed is limited by the airplane configuration. At acceleration height, VNAV commands a speed 5 knots below the flap placard speed.

Passing 10,000 feet, VNAV commands an acceleration to the economy climb speed, which is maintained until reaching the cruise altitude unless the climb profile contains other constraints.

During the climb, VNAV complies with the LEGS page waypoint altitude and speed constraints. A temporary level-off for a crossing altitude restriction is accomplished at the commanded speed.

If the climb speed profile results in a climb angle that will cause the airplane to miss a waypoint altitude constraint, the CDU scratchpad message UNABLE NEXT ALTITUDE is displayed. A different speed profile that gives a steeper climb angle must be selected.

A decrease in airspeed may be observed during VNAV level off to cruise altitude if the rate of climb is high at the level off capture point. VNAV will continue a smooth level off and eventually accelerate to the selected cruise speed. During level off under these conditions, VNAV will not allow the airspeed to decrease below the best hold speed for that altitude, which is above the minimum maneuvering speed.

Climb Page

The climb page is selected by pushing the CDU VNAV function key while on the ground, during takeoff, or in climb.

The climb page is used to evaluate, monitor, and modify the climb path. The data on the climb page comes from preflight entries made on the route and performance pages, and from the FMC data bases.

The FMC manages the climb to comply with the active route. The climb mode is indicated by the CLB page title. The mode can be economy, selected speed, or engine out. In each mode, the same type of data is shown on the page.

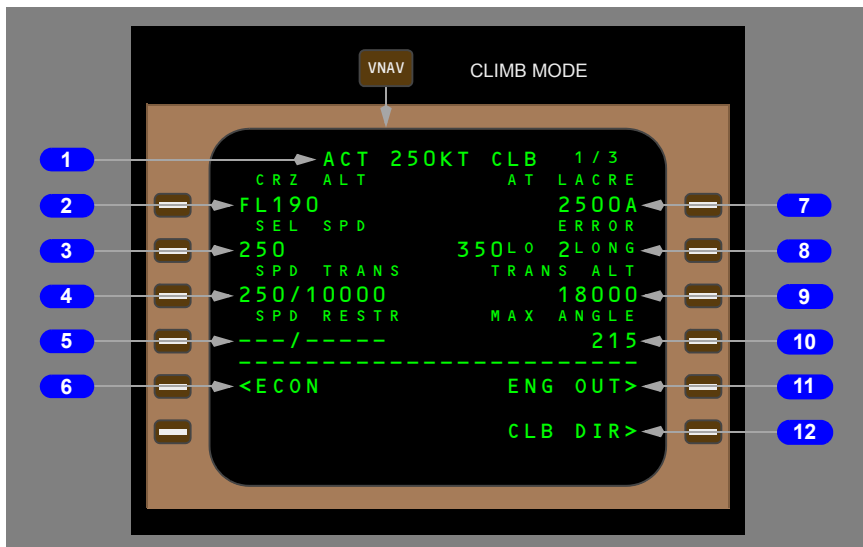

1 Page Title

ACT is displayed when the climb phase is active.

The page title displays the type of climb:

- ECON – speed based on the cost index
- LIM SPD – speed based on airplane configuration limiting speed
- MCP SPD – MCP speed intervention selected
- EO – engine out mode selected
- XXXKT – fixed CAS climb speed profile
- M.XXX – fixed Mach climb speed profile.

Fixed climb speeds are for:

- climb segment constraints
- waypoint speed constraints
- an altitude constraint associated with a speed constraint
- a speed transition
- a flight crew selected speed.

2 Cruise Altitude (CRZ ALT)

Displays cruise altitude entered on PERF INIT page.

Valid entries are: XXX, XXXX, XXXXX, or FLXXX. Altitude displays in feet or flight level depending on transition altitude.

3 Economy Speed (ECON SPD), Selected Speed (SEL SPD)

ECON SPD

- economy speed based on cost index
- displays CAS and Mach values.

SEL SPD

- displayed when intermediate level off required below an existing speed constraint
- displayed when flight crew enters speed
- CAS or Mach value may be entered.

4 Speed Transition (SPD TRANS)

Displays the transition speed/altitude from one of these sources:

- the navigation database value for the origin airport
- a default speed of 250 knots and 10,000 feet.

Not displayed above the transition altitude.

Can be deleted.

5 Speed Restriction (SPD RESTR)

Speed restrictions not associated with specific waypoints are manually entered on this line.

Displays dashes before entry by flight crew.

Valid entry is a CAS and altitude (example 240/8000).

6 Economy (ECON)

Push – changes climb speed to ECON. Must be executed.

Prompt is shown on line 5L when the climb mode is not ECON.

7 Waypoint Constraint (AT XXXXX)

Displays next airspeed and/or altitude constraint at waypoint XXXXX.

FMC commands the slower of constraint speed or performance speed.

Constraints are entered on RTE LEGS page or are inserted as part of a SID.

Delete here or on RTE LEGS page.

Blank if no constraint exists.

8 ERROR at Waypoint

Displays altitude discrepancy and distance past waypoint where altitude will be reached.

Blank if no error exists.

9 Transition Altitude (TRANS ALT)

Transition altitude for origin airport contained in navigation database. FMC uses 18,000 feet if transition altitude is not available.

Manually change transition altitude here or on DESCENT FORECAST page.

Valid entries are XXX, XXXX, XXXXX, or FLXXX.

Altitude information displayed on the CDU changes from altitudes to flight levels above the transition altitude.

10 Maximum Angle (MAX ANGLE)

Maximum angle of climb speed.

Entry not allowed.

11 Engine Out (ENG OUT)

Push – modifies page to show engine out (ENG OUT) performance data.

12 Climb Direct (CLB DIR)

Push – deletes all waypoint altitude constraints between the airplane altitude and the MCP altitude. FMC cruise altitude is not affected.

Blank if no constraints exist.

Engine Out Climb

Engine out VNAV climb guidance is displayed on the EO CLB page. The EO CLB page must be selected and executed by the flight crew. Engine out data is available with all engines operating. Engine out climb (EO CLB) changes to engine out cruise (EO CRZ) at the top of climb.

Engine Out CLB Page

The modified page displays engine out performance limitations. Manual entries are allowed. After the modification is executed VNAV gives engine out guidance in the climb.

**1 Cruise Altitude (CRZ ALT)**

Displays cruise altitude if less than MAX ALT.

Displays MAX ALT if less than cruise altitude.

Manual entry is allowed.

2 Speed Line

Displays engine out best gradient climb speed (EO SPD) when page first selected. Any valid speed can be entered.

Valid entry is XXX for CAS.

Valid entry is 0.XXX for Mach. Trailing zeros can be omitted.

A manual entry changes the line heading to SEL SPD and may cause MAX ALT to change.

3 Engine Out Speed (EO SPD)

Push – resets command speed to best gradient speed. Blank when EO SPD is displayed on the speed line.

4 Maximum Altitude (MAX ALT)

Lower of maximum altitude at engine out climb speed or cruise speed.

Entry not allowed.

5 All Engine (ALL ENG)

Push – modifies page to display all engine (ALL ENG) performance data.

Route Legs Page

The legs page is used to evaluate and modify the planned route of flight during the climb and to add or delete waypoint constraints to comply with the ATC clearance. The data on the climb page comes from preflight entries made on the route and departure pages, and from the FMC data bases.

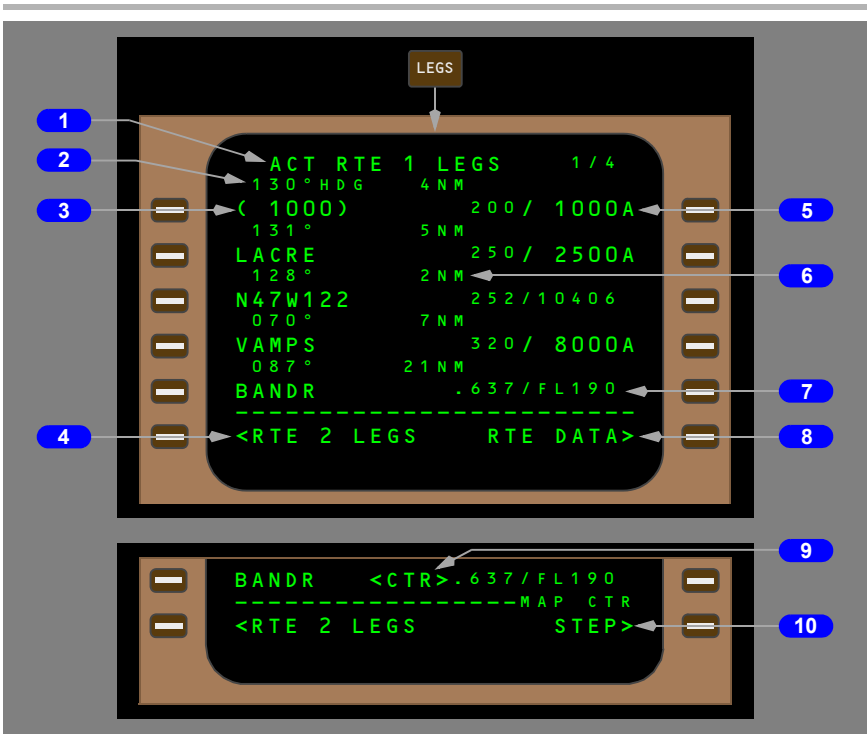
**1 Page Title**

Title format shows route status:

- RTE X LEGS – inactive route
- ACT RTE X LEGS – active route
- MOD RTE X LEGS – modified active route.

2 Leg Direction

Leg segment data in line title:

- courses – magnetic (xxx°) or true (xxx° T)
- arcs – distance in miles, ARC, turn direction (example: 24 ARC L)
- heading leg segments – xxx° HDG
- track leg segments – xxx° TRK
- special procedural instructions from database – HOLD AT, PROC TURN.

Calculated great circle route leg directions may be different than chart values.

Dashes are shown for an undefined course.

3 Waypoint Identifier

Displays waypoints by name or condition.

Active leg is always the first line of the first active RTE X LEGS page.

All route waypoints are shown in flight sequence.

Waypoints can be modified. Examples:

- add waypoints
- delete waypoints
- change waypoint sequence
- connect route discontinuities.

Boxes are shown for route discontinuities.

Dashes are in the line after the end of the route.

4 Route 2 Legs (RTE 2 LEGS)

Push –

- displays the RTE 2 LEGS
- when RTE 2 LEGS page is shown, prompt changes to RTE 1 LEGS.

5 Waypoint Speed/Altitude Constraints

Waypoint speed or altitude constraint in large font.

Manual entry allowed in climb or descent phase. Entered by FMC when constraints are part of a procedure.

Speed constraint is assumed to be at or below the displayed speed.

Valid entries are:

- speed in airspeed or Mach
- altitude in thousands of feet or flight level (19000, 190)
- XXX/XXXXX – airspeed/altitude entered simultaneously
- XXX/ – airspeed only (requires an existing altitude constraint)
- XXXXX or /XXXXX – altitude only.

Altitude constraint suffixes:

- blank – cross at altitude
- A – cross at or above altitude
- B – cross at or below altitude
- both – altitude block. Example: 220A240B
- S – planned step climb (refer to Flight Management, Navigation, Cruise).

6 Distance to Waypoint

Distance from airplane to active waypoint or from waypoint to waypoint.

The first line displays the distance from the airplane to the active waypoint.

7 Waypoint Speed/Altitude Predictions

Waypoint speed and altitude predictions are displayed in small font.

Dashes are displayed in the descent region prior to descent path calculation.

Descent path calculation requires altitude constraint below cruise altitude.

8 ACTIVATE, Route Data (RTE DATA)

Push – three possible prompts

- ACTIVATE – activates inactive flight plan; shows RTE DATA prompt
- RTE DATA (route data) – shows route data page
- CTR – see below

9 Center (<CTR>)

Displayed when PLAN mode selected.

Displayed adjacent to the waypoint around which plan mode is centered.

10 MAP Center (CTR) STEP

Replaces ACTIVATE or RTE DATA when PLAN mode selected.

Push – steps <CTR> to next waypoint. Plan mode recenters.

Engine Out Departure



1 Engine Out Standard Instrument Departure (EO SID)

Engine out SIDs can be created by the airline for specific runways. If there is an EO SID in the database for the departure runway it will be listed on the departures page after the runway is selected.

The FMC puts the EO SID into the route as a modification if:

- an engine failure is sensed
- flaps are extended
- and the navigation database has an EO SID for the departure runway.

The modification can be executed or erased.

Air Turnback

Arrivals Page

During a turn-back situation, the flight crew requires quick access to the arrivals data for the origin airport. The arrivals page allows access without changing the destination on the route page.

767 Flight Crew Operations Manual

During climb if the airplane is less than 400 miles from the origin and less than half way to the destination, push the DEP ARR key to show the ARRIVALS page for the origin airport.

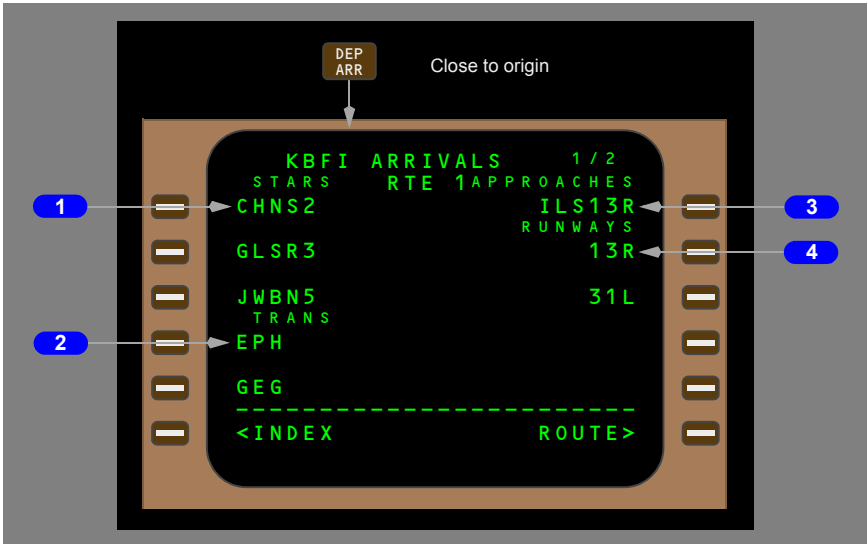
**1 Standard Terminal Arrivals (STARS)**

Displays STARS for origin airport.

2 Transitions (TRANS)

Displays transitions for origin airport.

3 APPROACHES

Displays approaches for origin airport.

4 RUNWAYS

Displays runways for origin airport.

Intentionally
Blank

Introduction

The cruise phase starts at the top of climb.

During cruise, the primary FMC pages are:

- RTE X LEGS
- CRZ
- PROGRESS.

The RTE LEGS pages are used to modify the route. The CRZ pages display VNAV related data. The PROGRESS pages display flight progress data. During cruise, the specific page listed below is used to:

- POS REF page – verify the FMC position
- RTE DATA page – display progress data for each waypoint on the RTE LEGS page
- REF NAV DATA page – display data about waypoints, nav aids, airports, or runways, and can be used to inhibit nav aids
- RTE X page – select a route offset
- FIX INFO page – display data about waypoints. Page data can be transferred to other pages to create new waypoints and fixes
- SELECT DESIRED WAYPOINT page – shows a list of duplicate waypoints from the navigation database. The flight crew selects the correct waypoint from the list
- POS REPORT page – display data for a position report.
- WINDS page – enter forecast wind and temperature

The CLB page changes to CRZ at the top of climb. The CRZ CLB and CRZ DES pages change to CRZ at the new cruise altitude. The CRZ page changes to DES at top of descent.

LNAV Modifications

This section shows typical techniques to modify the route. The modifications include:

- add and delete waypoints
- connect discontinuities
- change waypoint's sequence
- intercept a course.

RTE LEGS Page Modifications

Modifications to the LNAV route are usually made on the RTE LEGS page. When the route is modified, MOD is displayed in the title and the execute light is illuminated.

Add Waypoints

Waypoints can be added to the route at any point. Added waypoints are followed by route discontinuities.

First, enter the waypoint name in the scratchpad.

Second, locate the correct line in the flight plan and push the adjacent line select key. The scratchpad waypoint name is put into the selected line. The entered waypoint is connected to the waypoint above it via a direct route. A route discontinuity follows the waypoint.

For example, OED is typed into the scratchpad. Push line select key 2L to put OED into line 2. The FMC assumes BTG direct OED. RBL and the rest of the flight plan are kept but, are put after the route discontinuity.

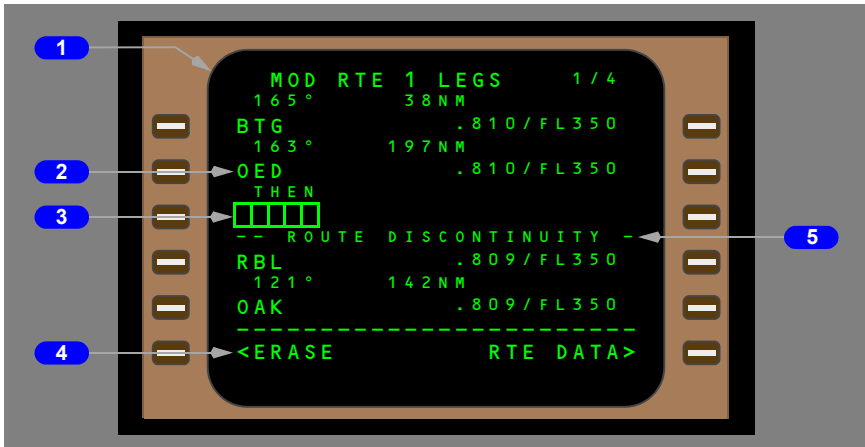

1 Page Title

MOD – replaces ACT when modification is in progress.

ACT – replaces MOD when ERASE is selected or execute key is pushed.

2 Modified Waypoint

OED waypoint entered into the route after BTG. Modification creates a route discontinuity because OED was not in the active route. The FMC now requires routing beyond OED.

3 Discontinuity Waypoint

Discontinuity is corrected when applicable waypoint is entered in boxes.

4 ERASE

Push – removes all modifications and shows active data.

Displayed when the FMC contains modified data.

Removed when selected or the modifications are executed.

5 ROUTE DISCONTINUITY

Line title separates route segments when there is a discontinuity.

Note: Performance predictions to destination on the PROGRESS page are calculated assuming the route of flight is direct between waypoints on either side of a route discontinuity.

Delete Waypoints

Use the RTE LEGS page to remove waypoints from the route. The active waypoint can not be deleted. Two methods to remove a waypoint are:

- delete the waypoint with the DEL function key
- change the waypoint's sequence.

The data in the route before the deleted waypoint does not change. A discontinuity is put in the route when the DEL function key is used to remove a waypoint.

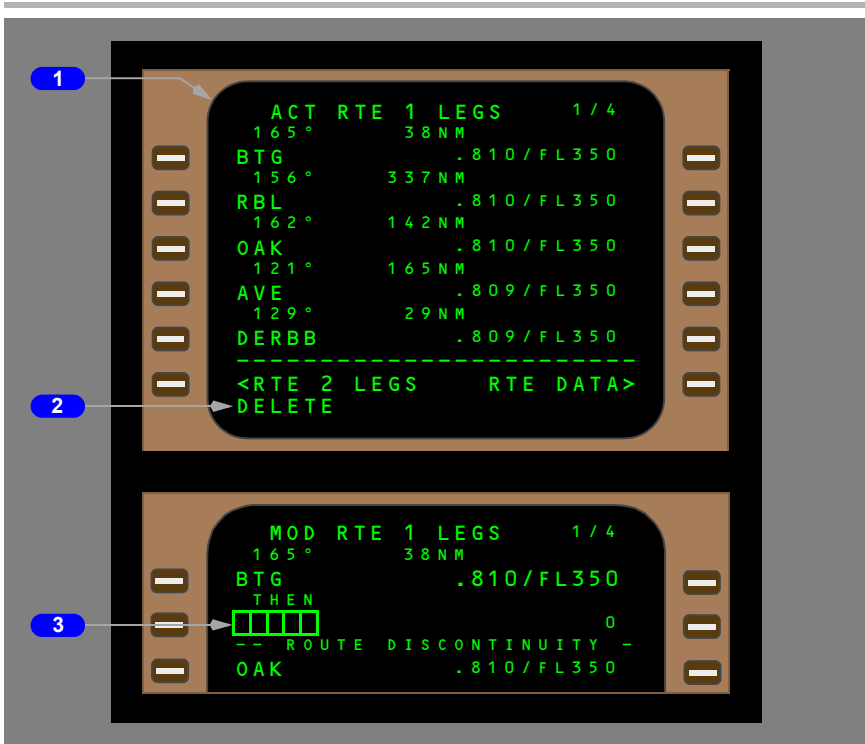

1 Active Route

The active route shows RBL followed by OAK and AVE.

2 DELETE Entry

Pushing the DEL function key arms the delete function and selects DELETE to the scratchpad.

3 Route Discontinuity

With DELETE in the scratchpad, pushing the line select key for RBL deletes the waypoint. Boxes replace RBL and a route discontinuity is displayed.

Change Waypoint Sequence

Waypoints moved from one position in the flight plan to another do not cause route discontinuities.

The waypoint may be manually typed or copied from any of the RTE LEGS pages. To copy the waypoint, push the line select key adjacent to the waypoint.

767 Flight Crew Operations Manual

The example below shows the flight plan being modified to fly from BTG direct OAK. Push the line select key adjacent to OAK to put OAK in the scratchpad. Push the line select key adjacent to RBL. RBL is removed from the flight plan and the routing is direct from BTG to OAK to AVE. The modification does not cause a route discontinuity. Several waypoints can be removed from the flight plan at a time with this method.

**1 Active Route**

The active route shows RBL followed by OAK and AVE. The clearance is to fly from BTG direct OAK. The OAK waypoint is selected to the scratchpad.

2 Change OAK's Sequence

OAK is selected to the waypoint after BTG. RBL is removed with no discontinuity.

Remove Discontinuities

A discontinuity exists when two waypoints are not connected by a route segment. To remove a discontinuity, copy the subsequent waypoint from the route into the scratchpad and enter it into the discontinuity.



1 Route Discontinuity

The active route has a discontinuity after BTG. The example shows how to fly direct from BTG to OAK. Copy OAK to the scratchpad. Any subsequent waypoint in the route can be selected to the scratchpad to remove the discontinuity.

2 Continuous Route

Select OAK to the boxes to remove the discontinuity.

If a waypoint which does not already exist on the route is entered into the boxes the discontinuity moves one waypoint further down the route.

Direct To And Intercept Course To

If the airplane is not on the active leg segment, LNAV may deactivate or it may not activate when armed. This happens after the airplane crosses a discontinuity, or is not on an intercept heading to the active leg segment. Here are three ways to arm or activate LNAV:

- When the airplane is within 2.5 miles of the active leg, push the LNAV switch. LNAV activates and intercepts the active route leg
- When more than 2.5 miles from the active leg, push the LNAV switch when the airplane is on an intercept heading to the active route leg. Initially, LNAV arms and then activates as the airplane approaches the active leg. An intercept heading must intersect the active leg inbound before the active waypoint
- Fly direct to a waypoint or intercept a course to a waypoint. Enter a waypoint in the RTE LEGS page active waypoint line to fly direct. Use the INTC CRS prompt in line 6R to create an intercept course to the waypoint. When the modification has been executed, push the LNAV switch and LNAV arms or activates, depending on the distance from the active leg.

Modification of the Active Waypoint

The following example shows a modification to go direct to a waypoint. After vectors off the original route a clearance is received to proceed direct to BTG.

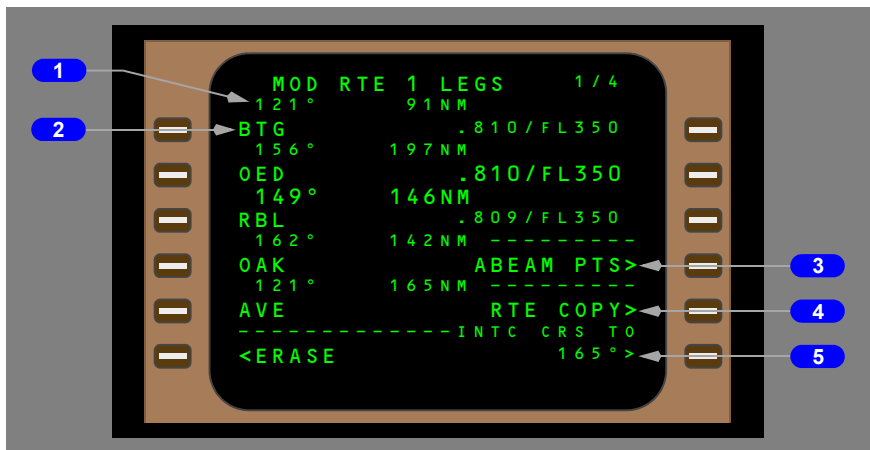

1 Course to Active Waypoint

Prior to execution, displays direct-to inbound course at waypoint; changed by entry in INTC CRS line or by selecting intercept course.

After execution, displays current required track to fly inbound course to waypoint.

2 Active Waypoint

Displays crew entered direct/intercept waypoint. If entered waypoint is not part of the active route it will be followed by a discontinuity.

3 ABEAM Points (PTS)

Push –

- creates abeam points on new route to indicate waypoints bypassed by direct to function
- abeam points are perpendicular to the waypoints bypassed
- line title displays ABEAM PTS, line data displays SELECTED
- subsequent route modifications remove ABEAM PTS prompt.

4 Route (RTE) COPY

Push –

- copies active unmodified route into inactive route
- erases previous inactive route
- line title displays RTE COPY, line data displays COMPLETE
- subsequent route modifications remove RTE COPY prompt.

5 Intercept Course (INTC CRS) TO

Displays boxes if entered waypoint not in the active route.

Displays current route course and prompt caret if the entered waypoint is in the active route. Allows entry of a different inbound course via the scratchpad.

When boxes displayed, valid entry is intercept course from 000 to 360.

Push –

- when course displayed, selects current route course as intercept course to active waypoint
- when course is displayed and a different course has been entered in the scratchpad, the scratchpad value is entered as the intercept course to the active waypoint
- selection or entry is displayed as the course to the active waypoint
- selection or entry removes ABEAM PTS and RTE COPY prompts.

Intercept Course From

The steps to create an intercept course from a waypoint are nearly the same as the steps for an intercept course to. The waypoint name in the scratchpad is suffixed with the outbound course.

767 Flight Crew Operations Manual

An intercept course can be created outbound from a waypoint in the navigation data base or from present position. The waypoint does not have to be in the route. Entering a waypoint and course pair in the active waypoint line displays the INTC CRS FROM prompt. The FMC calculates a route leg with the waypoint as the origin of the entered course.

The following example demonstrates entering a 160° course from BTG. BTG160 is entered in the scratchpad. When this entry is line selected to the active waypoint line, the entered course is displayed as a conditional waypoint.

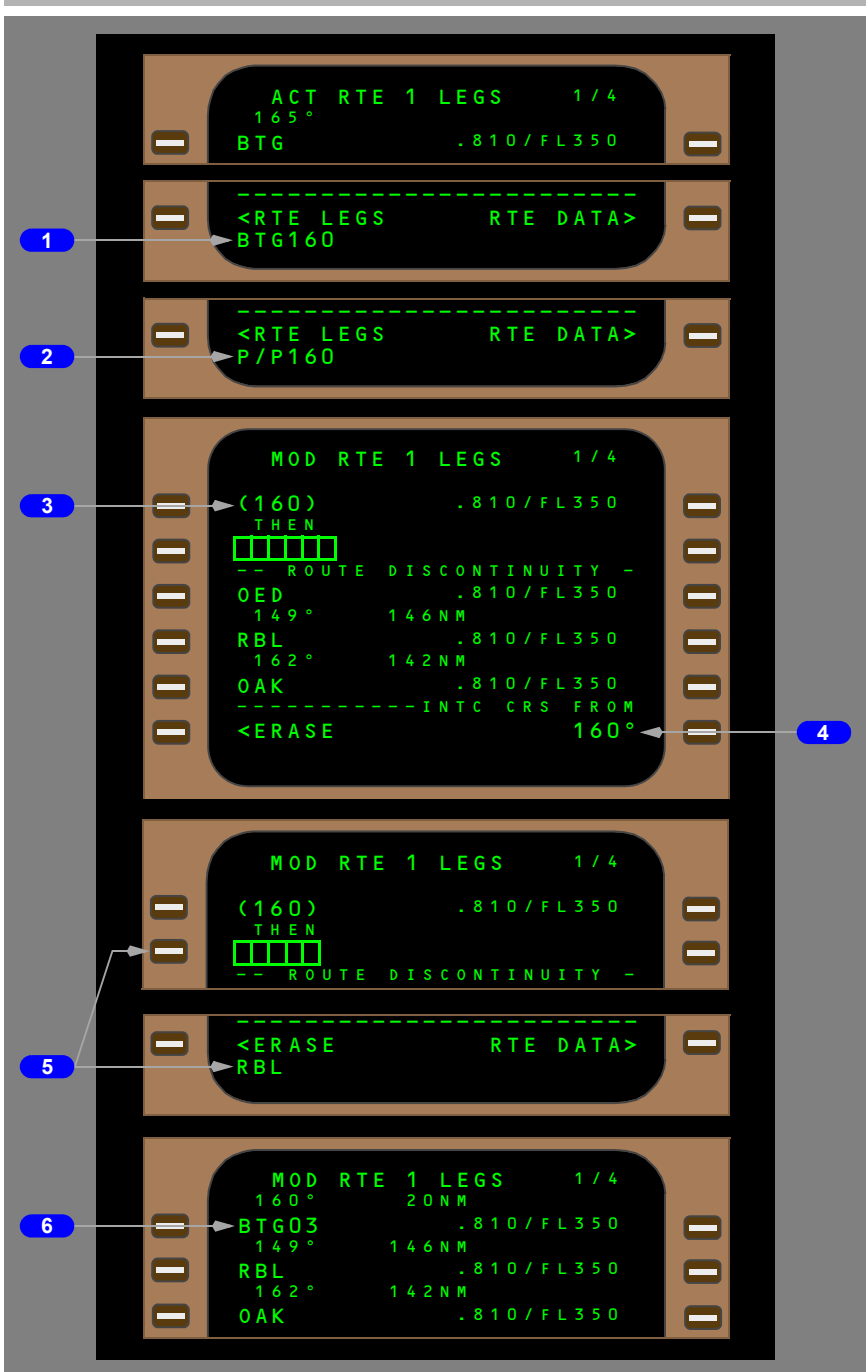

1 Waypoint and Outbound Course

Enter the waypoint name and outbound course in the scratchpad.

2 Present Position and Outbound Course

Enter P/P and outbound course in the scratchpad.

3 Active Outbound Course Entry

After the active waypoint line is selected, the outbound course is displayed. The waypoint name is not used.

For example, BTG160 is entered into the active waypoint line. The FMC calculates a new route leg with BTG as the origin on a outbound course of 160°.

4 Intercept Course From (INTC CRS FROM)

Displays outbound course from the entered waypoint. Allows input of a different outbound course until the modification is executed.

Valid entry is any course from 000° through 360°.

5 Next Waypoint

Enter a down track waypoint into the boxes. To resolve the discontinuity the waypoint must be part of the active route and the inbound course to that waypoint must be intersected by the entered course.

6 Created Waypoint

If the 160° course intercepts the course inbound to the entered waypoint, a new waypoint is created at the intercept point. Line selecting the new waypoint results in a place, bearing, distance format in the scratchpad.

SELECT DESIRED Waypoint (WPT) Page

The SELECT DESIRED WPT page is displayed when a waypoint identifier or name is entered and the navigation database contains more than one location for that name. Selection of a waypoint returns the display to the previous page.

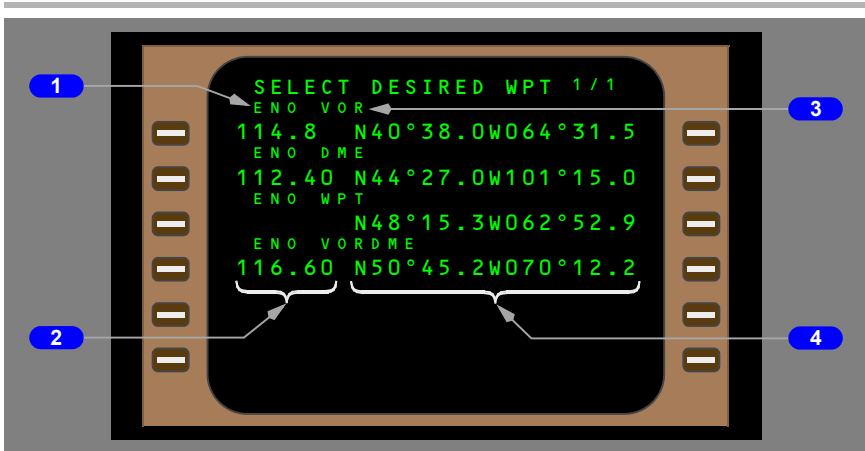

1 Identifier

Displays a list of the waypoints in the navigation database that have the same identifier as entered.

Up to 48 waypoints (8 pages) can be listed.

Waypoints are sorted as follows:

- when page is accessed as a result of a flight plan entry or modification, sort is based on proximity to the waypoint preceding the entered waypoint
- when page is accessed as a result of a DIR/INTC, FIX INFO, or REF NAV DATA entry, sort is based on proximity to current aircraft position.

Select the desired waypoint by pushing either the left or right line select key adjacent to the waypoint. The CDU page where the waypoint identifier was entered is redisplayed with the selected waypoint inserted.

2 Frequency

Displays frequency of the waypoint if it is a navaid. Blank if the waypoint is not a navaid.

3 Type

Displays the type of waypoint for each duplicate name.

4 Latitude/Longitude

Displays the latitude/longitude for each duplicate name.

Airway Intercept

Just as in intercept to, LNAV can be used to intercept an airway. An airway intercept changes the active waypoint on the RTE and LEGS pages.

Enter the airway identifier under VIA on line 1 of the RTE page. Boxes display under TO. Enter the desired airway exit waypoint in the boxes. For this open-ended airway intercept, the FMC selects the waypoint preceding the closest abeam location as the starting waypoint of the airway. This waypoint is displayed on line 1. The entered airway and the desired exit point are displayed on line 2. When the modification is executed the leg inbound to the FMC selected starting waypoint becomes the active leg.

If the clearance heading intercepts the active leg segment, LNAV can be armed and the intercept will occur. In most airway intercept situations, the commanded heading will not intercept the active leg.

If the clearance heading does not intercept the active leg segment, use the intercept-course-to procedure to make the course inbound to the waypoint after the crossing location the active leg segment.

Example

The active route is direct to EPH, then direct to MWH. ATC clears the airplane to:

- turn right heading 110°
- intercept V2 to MWH.

Following the V2 modification to MWH and execution, the LEGS page displays this waypoint sequence:

- BANDR
- BEEZR
- ELN
- PLUSS
- MWH.

Modify the LEGS page using a course intercept to the waypoint after the crossing location. In this case, it would be PLUSS. PLUSS becomes the active waypoint on the V2 airway. The LEGS page now displays:

- PLUSS
- MWH.



1 Active RTE 1 Page

The route page before the ATC clearance.

2 Input Airway

Enter the airway in the first VIA position on the RTE page. Boxes display in the TO position. A route discontinuity follows on the next line.

3 Airway Exit

Enter desired airway exit point in the boxes.

767 Flight Crew Operations Manual

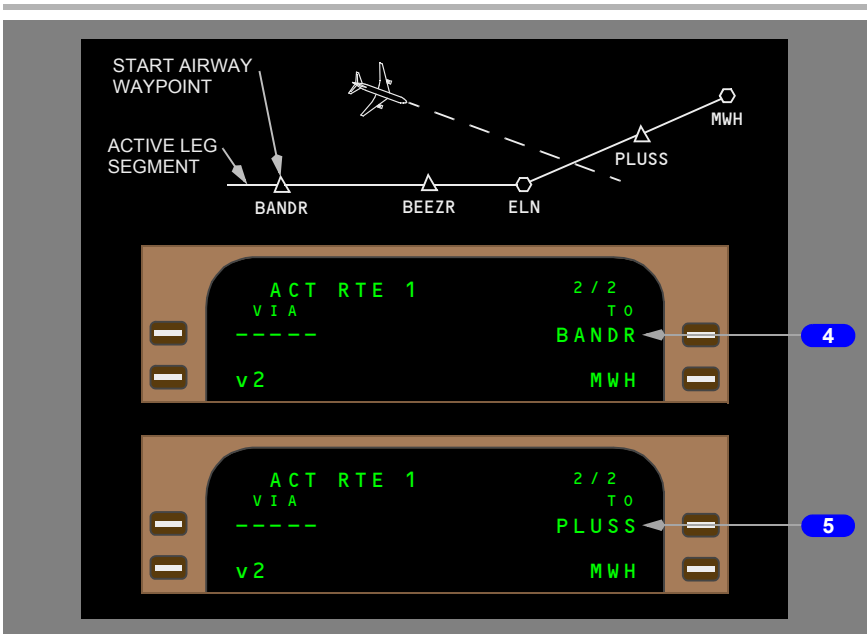
**4 Start Airway Waypoint**

After entering MWH in the boxes:

- the FMC selects BANDR as the airway start waypoint
- the airway line moves down one line
- dashes are shown in the VIA to the start airway waypoint.

5 New Active Waypoint

Following modification and execution of the course intercept procedure to PLUS, the LEGS page displays PLUS as the active waypoint. LNAV can be armed and the airway intercept can be completed.

Route Offset

Route offsets are selected on the RTE page. The OFFSET prompt is displayed on the RTE page when the airplane is airborne and not on a SID, STAR, or transition. Entering a distance value into the OFFSET dashes creates the selected offset. An offset propagates along the route from the active waypoint until a discontinuity, approach, approach transition, holding pattern, course change of greater than 135°, or end of route is reached. An offset can be removed by deleting the offset, proceeding direct, or entering an offset value of zero.

The offset is shown as a white dashed line on the map display until the offset modification is executed or erased.

After execution, the offset route is shown as a dashed magenta line on the map display. The original route remains a solid magenta line.

If LNAV is engaged when the offset is executed, the airplane turns to an intercept heading and captures the offset course.



1 OFFSET

Enter the necessary offset. When executed, the CDU offset (OFST) light illuminates.

Valid entries are L (left) or R (right) followed by a distance from 0 to 99 in nautical miles.

Cruise Page

All Engine Cruise

The cruise page is used to monitor and change cruise altitude and speed. Speed changes can be manually selected or automatically selected with the selection of other VNAV modes. Cruise climbs, cruise descents, and step climbs can be accomplished from the cruise page.

When using the economy mode, page data is based on operating at ECON SPD. Economy cruise speed is based on cost index. When the flight crew enters a selected speed, page data changes. When the FMC is in the engine out mode, the data changes to include the airplane capabilities with one engine inoperative. The long range cruise (LRC) mode calculates speeds to maximize airplane range.

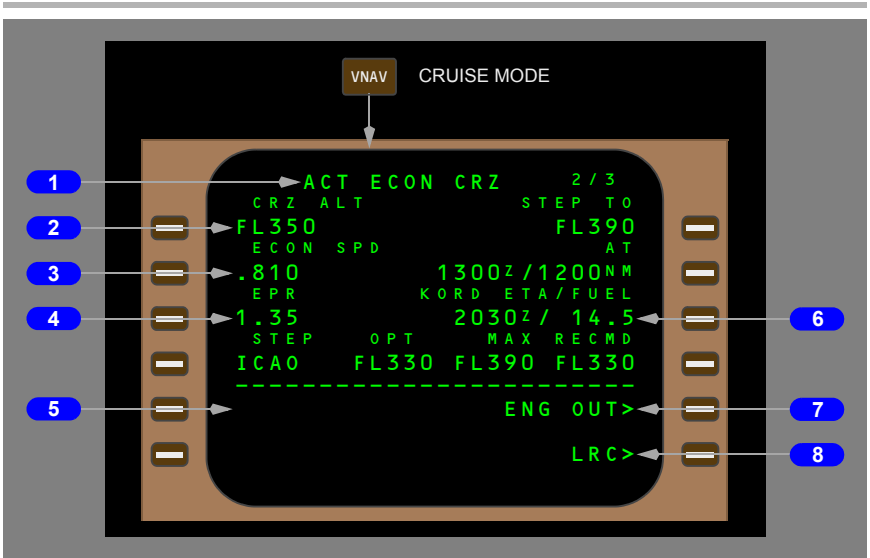

1 Page Title

The page title displays active (ACT) or modified (MOD) cruise. Usually, the title contains ECON for economy cruise. Fixed speed, engine out, and long range cruise modify the title.

Page titles include:

- CO – engine out mode and company speed selected
- CRZ CLB or CRZ DES – cruise climb or descent
- ECON – speed based on cost index
- EO – engine out mode selected
- EO D/D – engine out drift down displays when EO selected and the airplane altitude is above the maximum altitude for engine out performance
- LIM SPD – based on an airplane configuration limiting speed
- LRC – long range cruise selected
- MCP SPD – speed intervention applied from the MCP
- M.XXX – fixed Mach cruise speed
- XXXKT – fixed CAS cruise speed.

Fixed cruise speeds are for:

- waypoint speed constraints
- an altitude constraint associated with a speed constraint
- a flight crew selected speed (SEL SPD).

2 Cruise Altitude (CRZ ALT)

Displays cruise altitude entered on PERF INIT page.

Valid entries are: XXX, XXXX, XXXXX, OR FLXXX. Altitude displays in feet or flight level depending on the transition altitude. Changing the MCP altitude enters the new altitude in the scratchpad for entry. Entry creates a modification.

When the modification is executed the page title changes to CRZ CLB or CRZ DES.

3 Economy Speed (ECON SPD), Selected Speed (SEL SPD)

Displays target speed or Mach.

Allows entry of any valid speed or mach number. MOD displays in the page title until the modification is erased or executed.

A manually entered speed changes the line title to SEL SPD.

ECON can be replaced with LRC or company speed (CO SPD), depending on the VNAV mode.

4 EPR

Displays EPR necessary for level flight at the target airspeed.

4 N1

Displays N1 necessary for level flight at the target airspeed.

5 Economy (ECON)

Push – selects economy cruise speed.

Displayed when speed or Mach is not ECON.

6 Destination ETA/FUEL

Estimated time of arrival and calculated fuel remaining at the destination.

Displays the same data for the alternate airport when a DIVERT NOW modification is selected from the ALTN page.

Calculations are based on optimum step climbs and cruise altitudes.

7 Engine Out (ENG OUT)

Push –

- displays engine out cruise page
- commands engine out performance calculations
- changes CRZ ALT if above maximum engine out altitude
- changes target speed to engine out speed
- upon execution, thrust reference mode changes to CON.

8 Long Range Cruise (LRC)

Push – displays long range cruise page.

Engine Out Cruise

Engine out VNAV cruise guidance displays on the EO CRZ page. Engine out data is also available with both engines operating.

The initial page data includes engine out performance limitations. Manual entries are allowed. When above the maximum engine out cruise altitude, VNAV calculates engine out (EO) guidance for drift down (D/D). The EO D/D page changes to the EO CRZ page when reaching the engine out cruise altitude. Subsequent engine out cruise climb or descent is accomplished the same as two engine cruise climb or descent.

As the airplane gross weight decreases, maximum altitude increases. A step climb may be possible under these conditions.

The example is based on a cruise altitude above the maximum engine out altitude. When ENG OUT is first selected, the default speed is EO SPD.



1 Page Title

Displays EO D/D (for this example, airplane is above MAX altitude).

Displays MCP SPD D/D when controlling to a manually entered speed during the driftdown.

Displays EO LRC (long range cruise) D/D when LRC selected during driftdown.

Displays EO LRC when in level cruise flight and the LRC speed is selected.

Displays EO CRZ CLB or EO CRZ DES during engine out cruise climbs or descents and the airplane is below the engine out maximum altitude.

2 Cruise Altitude (CRZ ALT)

Displays altitude from MAX ALT line when current CRZ ALT above MAX ALT.

Manual entry of an altitude above maximum engine out altitude results in the scratchpad message, "MAX ALT FLXXX".

Valid entries are the same as all engine cruise page.

3 Engine Out Speed (EO SPD)

Displays the target speed or Mach.

Manual entry is allowed.

Valid entries are the same as all engine cruise page.

A manually entered speed changes the line title to SEL SPD.

ECON can be replaced with long range cruise (LRC), company (CO SPD), or engine out (EO SPD) speed using prompts at the bottom of the page.

Selecting any speed shows engine out speed (EO SPD) as a select prompt at 6L.

Manual entries may change MAX altitude.

4 Company Speed (CO SPD)

Push – Modifies the page with company speed, engine out data from the Airline Policy page.

5 Engine Out (EO SPD)

Push – enables execution of engine out minimum drag speed profile.

Display when EO LRC, EO SEL SPD, or CO SPD is the active speed mode.

6 Optimum, Maximum and Recommended Altitude (OPT MAX RECMD)

OPT – displays the most economical altitude based on airplane gross weight.

MAX – displays the maximum cruise altitude based on:

- engine out operation
- selected speed option
- without any altitude or speed constraints, and
- capable of a 100 feet per minute climb rate.

RECMD – displays the most economical altitude based on airplane performance and winds.

7 ALL Engine (ENG)

Push – displays a MOD XXX CRZ page with performance based on both engines operating.

Selection and execution allows subsequent selection of two engine economy VNAV modes.

8 Long Range Cruise (LRC)

Push – enables execution of engine out long range cruise.

Displayed when EO or SEL SPD is the active mode.

VNAV Modifications

During the cruise phase, VNAV can calculate two types of climbs: cruise and step climbs. Cruise and planned climbs can be entered by the flight crew. Optimum step climbs are calculated by the FMC. In all cases, the new climb altitude must be selected in the MCP altitude window before VNAV commands the climb.

Cruise Climb

To initiate a cruise climb set the higher altitude on the MCP, then enter the altitude in the CRZ ALT line and execute. When the CRZ page is displayed, the new MCP altitude is automatically copied to the scratchpad to be line selected to the CRZ ALT line.

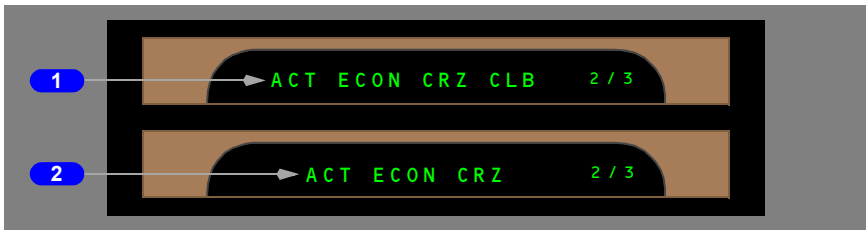

1 During Cruise Climb

VNAV page title displays ACT ECON CRZ CLB in a climb to a new cruise altitude. ECON is replaced by an indication of the selected speed if other than ECON.

2 End of Cruise Climb

VNAV page title displays ECON CRZ after level off at cruise altitude.

Planned Step Climb

When a step climb is planned to start at a waypoint, the data can be entered on the RTE LEGS page. The FMC performance predictions assume the airplane will start the climb at the identified waypoint.

The FMC displays the distance and ETA to the step point on the CRZ and PROGRESS page. The corresponding altitude profile point and identifier are shown on the map display.

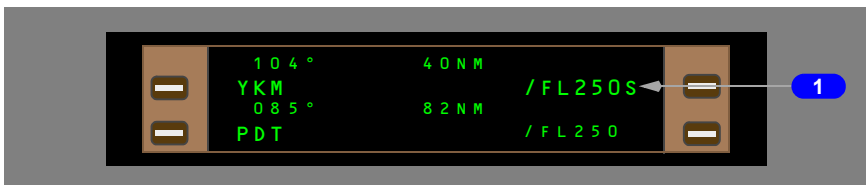

1 Step Climb Altitude

Enter the cruise altitude as an altitude constraint and the letter S. The FMC assumes the step climb starts at the waypoint. Accomplish the step climb at the waypoint with the steps described in cruise climb.

Calculated Step Climb

When a non-zero value is entered into the STEP SIZE line on the PERF INIT or CRZ page, the FMC calculates optimum points for step climbs as the airplane performance permits. The climb altitude is determined by the value in STEP SIZE. Multiple step climbs are possible based on performance and route length. VNAV commands the step climbs, if the MCP altitude and the FMC CRZ ALT are set to the new altitude.

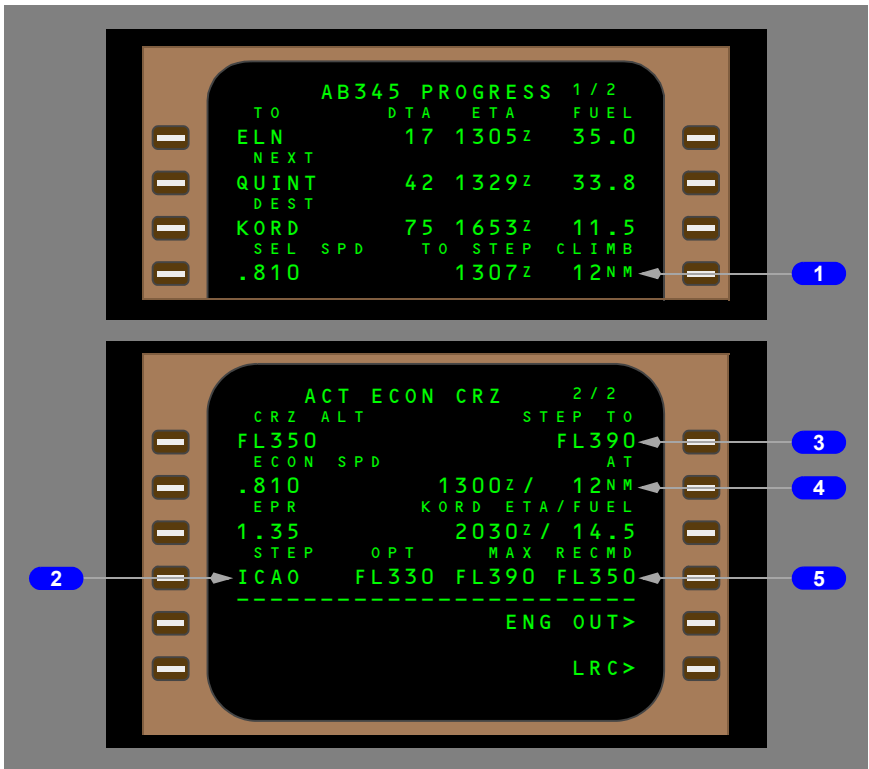

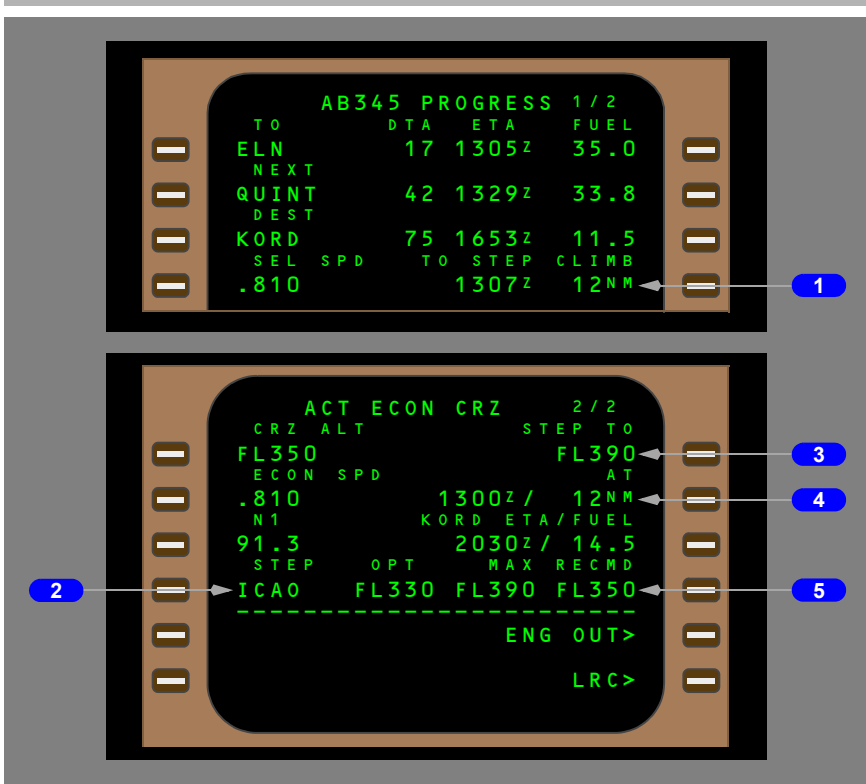

1 TO STEP CLIMB

When the step climb start point is the next VNAV event, the line title changes to TO STEP CLIMB.

Displays the ETA and DTG to the point where the step climb starts.

If the airplane passes the step climb point and has not started to climb, the ETA and DTG are replaced with the word NOW.

When the FMC calculates that a step climb is not advised, the ETA and DTG are replaced with the word NONE.

2 STEP SIZE

Displays the default step climb size of ICAO.

Valid entries are altitudes from 0 to 9000 in 1000 foot increments.

Used for calculation of optimum step point and step climb predictions.

Deletion of a manual entry defaults back to ICAO.

3 STEP TO

An altitude can be entered for a step climb evaluation. The FMC calculates the predicted step climb data and displays the results on this page and the PROGRESS page.

Entering a zero value for STEP SIZE causes the FMC to calculate performance based on a constant altitude flight at the CRZ ALT. Entering a valid, non-zero increment or ICAO step size causes the FMC to calculate performance based on accomplishing step climbs at calculated step climb points.

Step climb altitudes entered on the RTE LEGS page can be higher or lower than the CRZ ALT. These step climb altitudes cannot be overwritten on the CRZ page.

When using the ICAO step size, the STEP TO altitude is the next higher altitude above the OPT altitude corresponding to the direction of flight, based on the CRZ ALT entered before takeoff. Changes to CRZ ALT while in flight do not affect calculation of STEP TO altitudes using ICAO step sizes. However, if an alternate route (for example, Route 2) is activated in flight, the hemispheric altitude will be calculated using the current CRZ ALT.

When using an altitude increment step size, the STEP TO altitude is the next higher altitude above OPT calculated by adding the STEP SIZE increment to the FMC CRZ ALT.

When entering a cruise altitude above maximum altitude, the scratchpad message MAX ALT FLXXX is displayed.

Displays:

- the STEP TO altitude from the RTE LEGS page
- a calculated step climb altitude based on the step size.

Manual entry is allowed.

Blank when:

- there is no active flight plan
- within 200 NM of the T/D point or 500 miles from the destination
- the step size is zero
- in the EO D/D phase.

4 AT

Displays the ETA and DTG to the step climb point.

Displays NOW when past the calculated step climb point.

Line title changes to AVAIL AT when the climb is restricted by thrust or buffet.

Line title displays AT XXXXX where XXXXX is the waypoint where a planned step climb has been entered on the RTE LEGS page.

Line title changes to TO T/D when within 200 NM of the top of descent point. ETA and DTG are relative to the T/D point.

The data is the same as displayed on the PROGRESS page.

5 Optimum, Maximum and Recommended Altitude (OPT MAX RECMD)

OPT – displays the most economical altitude based on gross weight and the active cruise speed.

MAX – displays the two engine maximum altitude based on gross weight, climb and cruise speeds within the speed envelope, and sufficient excess thrust to provide a specified residual rate of climb capability.

RECMD – displays the most economical altitude based on winds and airplane performance.

Cruise Descent

Cruise descents can be started in the cruise phase when more than 50 miles from the T/D point.

A cruise descent can be started by selecting a lower altitude on the MCP, entering the new altitude in the CRZ ALT line and executing. A VNAV cruise descent is commanded at the current cruise speed and approximately 1250 feet per minute rate of descent.

The autothrottles adjust thrust to maintain the target descent rate; pitch maintains the commanded speed. Thrust levers can be manually positioned to adjust the descent rate.

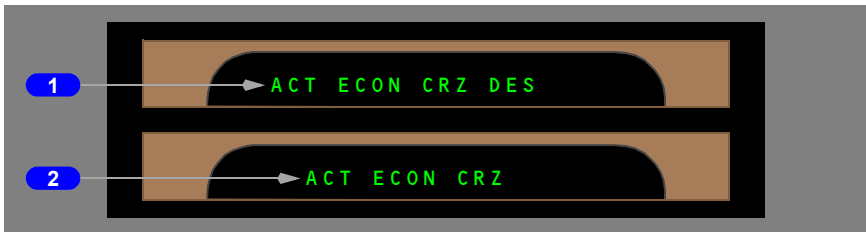

1 During Cruise Descent

VNAV page title shows cruise phase in a descent to a new cruise altitude.

2 End of Cruise Descent

VNAV page title shows cruise phase after level off at new cruise altitude.

Early Descent

An early descent starts when the descent for landing is commenced prior to the top of descent point. Early descents should not be started when the distance to the top of descent point is greater than 50 nautical miles. When further from the top of descent point, the cruise descent function should be used.

Early descents are started on the DES page. Once an early descent is started, VNAV changes to the descent phase and cruise features are no longer available.

The autothrottle adjusts thrust to maintain the target descent rate; pitch maintains the commanded speed. Thrust levers can be manually positioned to adjust the descent rate.

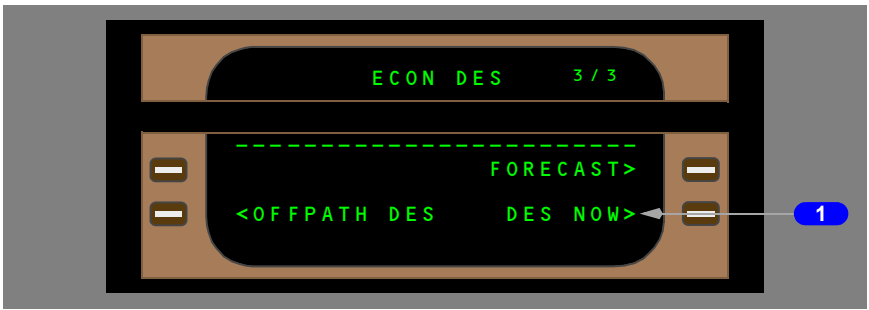

1 Descend Now (DES NOW)

The DES NOW prompt is shown on the descent page when the cruise phase is active. Reset the MCP altitude and select the DES NOW prompt and execute to start an early descent. The descent page becomes active and the airplane starts a VNAV ECON descent of approximately 1250 feet per minute at ECON descent speed.

Once the descent is established the autothrottle mode changes to THR HLD to allow the pilot to adjust the rate of descent with power changes.

Upon reaching the planned descent path, VNAV commands pitch to maintain the planned descent path and ECON speed.

Navigation Data

Reference Navigation Data Page

The reference navigation data page displays data about waypoints, nav aids, airports, and runways. Use this page to inhibit FMC position updates from radio nav aids.



1 Identification (IDENT)

Valid entries are any waypoint, navaid, airport, or runway from the navigation database. Only runways at the destination airport can be entered.

Dashes are displayed when the page is first selected. Entry changes to dashes when the page is exited and then reselected.

2 LATITUDE

Displays latitude of entered identifier. When the identifier is a runway the latitude displayed is for the threshold of the runway.

3 Magnetic Variation (MAG VAR), LENGTH

MAG VAR - displays magnetic variation when entered identifier is a navaid.

LENGTH - displays runway length when entered identifier is a runway.

4 NAVAID INHIBIT

When a navigation radio is known to provide erroneous position information, the FMC must be inhibited from automatically tuning that navaid.

Enter the identifier of up to two VOR, VOR/DME, VORTAC, or DME stations that must not be used for FMC position updates.

Entries are blanked at flight completion. Deleting or overwriting removes a previous inhibit.

5 VOR ONLY INHIBIT

Use this line when only the VOR portion of a VOR/DME or VORTAC navaid must be inhibited. ALL is displayed if the VOR/DME NAV prompt is selected to OFF.

Enter the identifier of up to two VORs that must not be used for FMC position updates. Only the VOR portion of the navaid is inhibited, the FMC will still tune the DME for DME-DME updating.

Entries are blanked at flight completion. Deleting or overwriting removes a previous inhibit.

6 INDEX

Push – displays the INIT/REF INDEX page.

7 Frequency (FREQ)

Displays frequency of entered identifier when it is a navaid.

8 LONGITUDE

Displays longitude of entered identifier. When the identifier is a runway the longitude displayed is for the threshold of the runway.

9 ELEVATION

Displays elevation of entered identifier when it is a navaid, airport, or runway.

10 VOR/DME NAV

Alternately switches VOR/DME NAV updating between OFF and ON

Push – when ON is displayed in large font

- changes OFF to large font and ON to small font
- inhibits VOR/DME updates to the FMC by inhibiting all VORs. DME-DME updating is not inhibited.
- displays ALL in both locations of the VOR ONLY INHIBIT line.

Push – when OFF is displayed in large font

- changes ON to large font and OFF to small font
- enables VOR/DME updating to the FMC
- deletes the ALL from the VOR ONLY INHIBIT line.

Fix Information Page

Two identical fix information pages are used to create waypoint fixes and waypoints for the map display. Some of the created waypoints can be copied into the route.

Magnetic or true fix bearings depend on the position of the heading reference switch or airplane location. Refer to FMC Polar Operations, Flight Management Navigation, section 31.

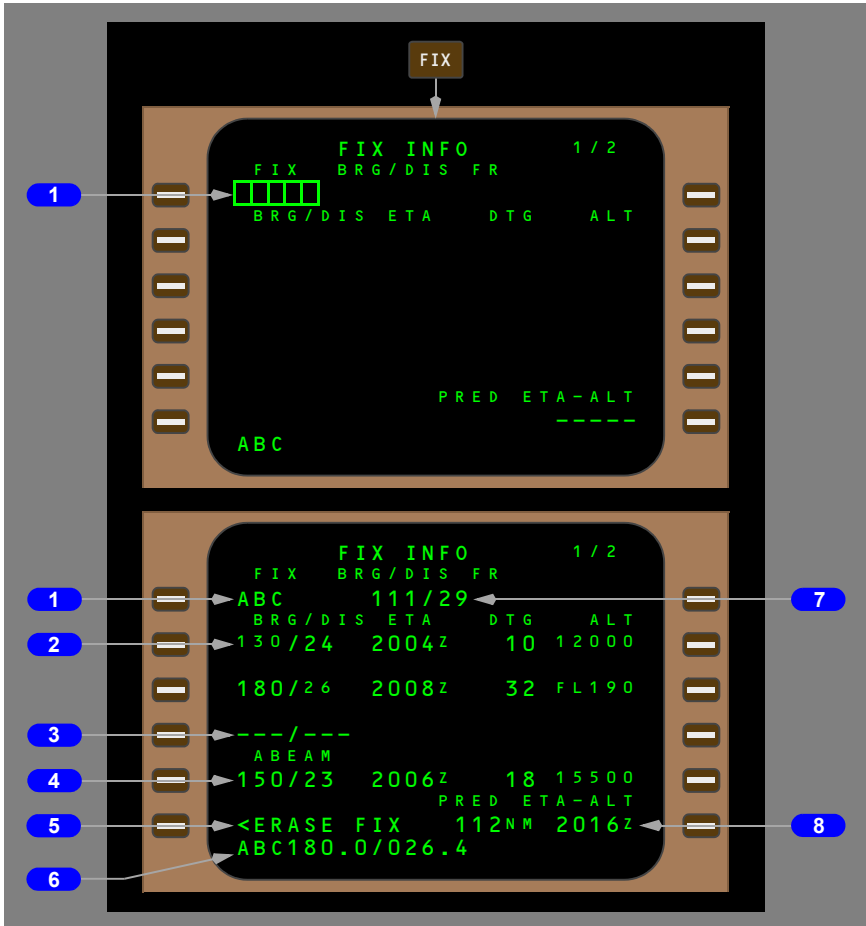

1 FIX

Before entry of a name or identifier, boxes displayed and most data lines are blank. Valid entries are airports, nav aids, and waypoints from the navigation database. The selected fix appears on the map display highlighted by a green circle.

2 Bearing/Distance (BRG/DIS), ETA, DTG, ALT

Valid entries are XXX/YYYY.Y:

- decimal values can be omitted
- leading zeros can be omitted for distance entries
- distance only entries must start with a slash (/).

Distances from the fix appear on the map display as a circle around the fix.

When the circle intersects the active route, the ETA, DTG, and predicted altitude at the intersection display for the closest of the two intersections.

Bearings from the fix appear on the map display as radial lines from the fix.

When the bearing intersects the active route, the ETA, DTG, and predicted altitude at the intersection display.

ETA – displays the estimated time if arrival to the intersection point.

DTG – displays the distance to go to the intersection point.

ALT – displays the predicted altitude at the intersection point.

Push - copies the fix place/bearing/distance into the scratchpad. This fix can be placed in the route on a LEGS or RTE page as a waypoint.

3 Bearing/Distance (BRG/DIS) – Dashes

Enter a bearing, distance, or both bearing and distance from the fix. A bearing and distance from the fix appear on the map display as a waypoint fix point. ETA, DTG, and predicted do not display.

4 ABEAM

Displays ABEAM prompt.

Push - displays bearing and distance from the fix perpendicular to the nearest segment of the flight plan path, and ETA, DTG, and altitude at the intersection point.

Second push - copies the fix place/bearing/distance into the scratchpad. This fix can be placed in the route on a LEGS or RTE page as a waypoint.

5 ERASE FIX

Push – removes all fix data from the page and the map display.

6 Route Intersection Point Copied

Pushing the line select key for one of the BRG/DIS entries copies the fix place/bearing/distance definition into the scratchpad. This fix can be placed into the route on a LEGS page as a waypoint.

7 Bearing/Distance From (BRG/DIS FR)

Displays the bearing and distance of the airplane from the fix.

8 Predicted Distance to ETA or Altitude (PRED ETA-ALT)

Valid entry is altitude, flight level, or time. Time entry must be followed by "Z".
Entering an altitude or flight level displays the predicted along track distance and altitude or flight level on this line. The predicted airplane position appears on the map as a green circle with the entered altitude/flight level or time.

In-Flight Position Update

FMC position update can be accomplished on the POS REF 2/4 page in flight.



1 UPDATE ARMED

Pushing the ARM prompt arms the position update function. ARM changes to ARMED. Each of the position update sources have a NOW prompt.

2 NOW

Push – to update the FMC position from the desired source. The FMC position is momentarily changed to the position of the selected system. If other valid sensor position exist, it returns to the most reliable sensor position.

Route and Waypoint Data

Route Data Page

The route data page displays progress data for each waypoint on the ACT RTE X LEGS page. This page also allows access to the WIND page. This page is available only for the active route.

One page shows data for five waypoints.

The ETA and calculated fuel remaining at the waypoint display for each waypoint. Manual entry is not possible.



1 Waypoint (WPT)

Displays identifier for waypoint.

2 ETA

Displays ETA for waypoint.

3 FUEL

Displays the FMC calculated fuel remaining at the waypoint.

Note: ETA and estimated fuel calculations assume a direct flight across route discontinuities.

4 WIND Page Prompts

Push – selects WIND page for the selected waypoint.

A "W" next to the prompt indicates that wind data has been entered on the wind page for that waypoint.

5 LEGS

Push – displays RTE LEGS page.

Wind Data

The FMC uses wind data to improve performance prediction accuracy.

The FMC applies the first entered wind data to all waypoints in the flight plan. Wind data includes altitude and direction/speed.

Wind data entered at another waypoint (at the same altitude) changes wind data down track from the second entered waypoint either to the end of the track, or to the next entered wind. The wind data before the second entered waypoint does not change. Therefore, enter wind data for waypoints closest to the airplane, then enter wind data for waypoints down track from the airplane.

For example: at FL 350, 100°/085 is entered at waypoint OED. All waypoints in the route have the OED wind data. Then, additional wind data entered at OAK changes the wind data at OAK and through the end of the route.

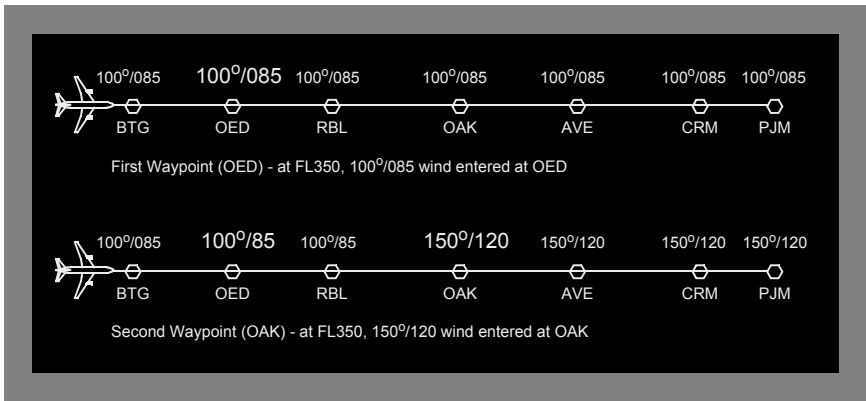

767 Flight Crew Operations Manual

Entered wind data are mixed with sensed wind data for performance predictions. The FMC uses entered winds for predictions far ahead of the airplane and sensed winds close to the airplane. The FMC mixes these winds for predictions in between.

Sensed winds are displayed on the HSI and on progress page 2.

Wind Page

The wind page is used to enter forecast winds and temperatures at specific altitudes for specific waypoints to enhance VNAV performance. The FMC calculates step climb points based on the wind effect.

The wind page displays waypoint wind data for one to four altitudes per waypoint. This data can be uplinked or manually entered.

The altitudes are entered first. The altitudes can be entered in any order and are sorted and displayed in ascending order.

Wind speed and direction are entered for the specific altitudes.

OAT can be entered for any one altitude. The FMC calculates the temperature for the entered altitudes using the standard lapse rate.

**1 Page Title**

Displays ACT XXXXX WIND, where XXXXX is the waypoint for which the wind page was selected.

When a route is being modified, MOD is shown in the page title. If ACT is displayed when the wind page is first accessed, entry of wind data caused MOD to be displayed. Wind entries must be executed.

2 Altitude (ALT)

Enter altitude or flight level for wind entries. Altitude data entry is possible only on line 1L.

After altitude entry, data is sorted in ascending order in lines 1 through 4. Dashes display on right side of line for wind direction and speed entry.

When all four lines have data, one must be deleted before new data can be entered.

Entered altitudes are propagated to all wind pages.

3 Altitude/Flight Level Data

Displays the altitude or flight level for wind entries. Data entered on 1L is displayed on lines 1 through 4 in ascending order. Altitude entry is not possible in lines 2L through 4L.

Calculated OAT based on standard lapse rate from the entry made on the ALT/OAT line are display in small font.

4 ERASE

Push – removes modified data.

5 Direction and Speed (DIR/SPD)

Displays dashes after altitude/flight level entry in the ALT line. Enter predicted wind direction and speed for the altitude.

Values propagate to other waypoint winds. Propagated values display in small font.

Manual entries display in large font.

6 Altitude/Outside Air Temperature (ALT/OAT)

Enter altitude and OAT. The altitude for OAT does not have to be one of the wind altitudes. The FMC uses standard lapse rate to calculate the temperature at the other altitudes.

Entries must be executed.

7 Route Data (RTE DATA)

Push – displays the RTE DATA page.

Progress Pages

The progress page displays general flight progress data.

The position report page is accessed from the progress page.

Progress Page 1

The page title displays the company flight number entered on the RTE page.

Page one of the progress pages displays general data about:

- waypoints (active and next)
- destination
- FMC speed
- next VNAV profile point.

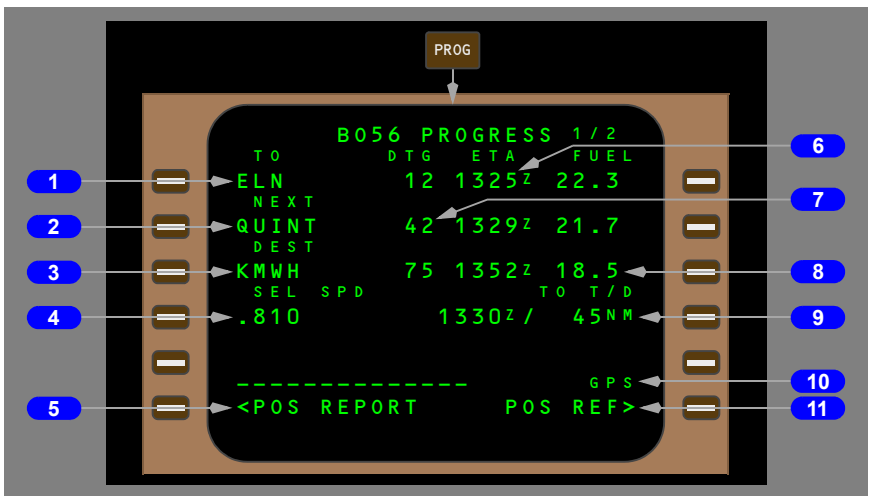

1 TO

Active waypoint is displayed.

Can not be modified.

2 NEXT

Waypoint after TO waypoint is displayed.

Can not be modified

3 Destination (DEST)

When the page is selected the active route destination is displayed. Any waypoint or airport in navigation database can be entered over the destination.

The line titles are:

- DEST – performance predictions to destination. Default display.
- DIR TO FIX – when entered waypoint is not in flight plan. Data is based on flying present position direct to the waypoint.
- EN ROUTE WPT – when entered waypoint is in flight plan. Line data are based on flying the flight plan route to the waypoint.
- MOD – a modification has been made on another page. Performance predictions include modification.

Entries do not modify the active route and are deleted when all CDUs are changed to a different page.

4 Selected Speed (SEL SPD)

Displays the FMC active command speed.

The active speed mode is the same as on the performance page, unless changed by the MCP or a limit. The speed modes are:

- LRC SPD – long range cruise speed
- ECON SPD – economy speed
- SEL SPD – selected speed manually entered on the CDU
- LIM SPD – speed is limited by VMO, MMO, flap limit, or buffet limit
- MCP SPD – MCP speed entered on the MCP IAS/MACH indicator
- EO SPD – engine out speed
- CO SPD – engine out operations at airline specified engine out company speed

5 Position Report (POS REPORT)

Push – displays the POS REPORT page.

6 ETA

Estimated time of arrival at waypoint or destination.

7 Distance To Go (DTG)

Distance to go to waypoint or destination.

8 FUEL

Estimated fuel remaining at waypoint or destination.

9 TO Top Of Descent (T/D)

ETA and DTG to next VNAV profile point.

The line title and data change for other phases of flight. Other line titles:

767 Flight Crew Operations Manual

- TO T/C – top of climb data
- TO STEP CLIMB – step climb data
- TO E/D – end of descent data
- LEVEL AT – time and distance to level off in engine out mode.

10 Navigation Updating Mode

Displays the current FMC position updating source. Possible displays are:

- GPS
- RADIO
- IRS
- LOC–GPS
- LOC–RADIO
- LOC

11 Position Reference (POS REF)

Push – displays position reference page.

Progress Page 2

Progress page two contains:

- wind data
- true airspeed
- fuel data
- track error data.
- static air temperature

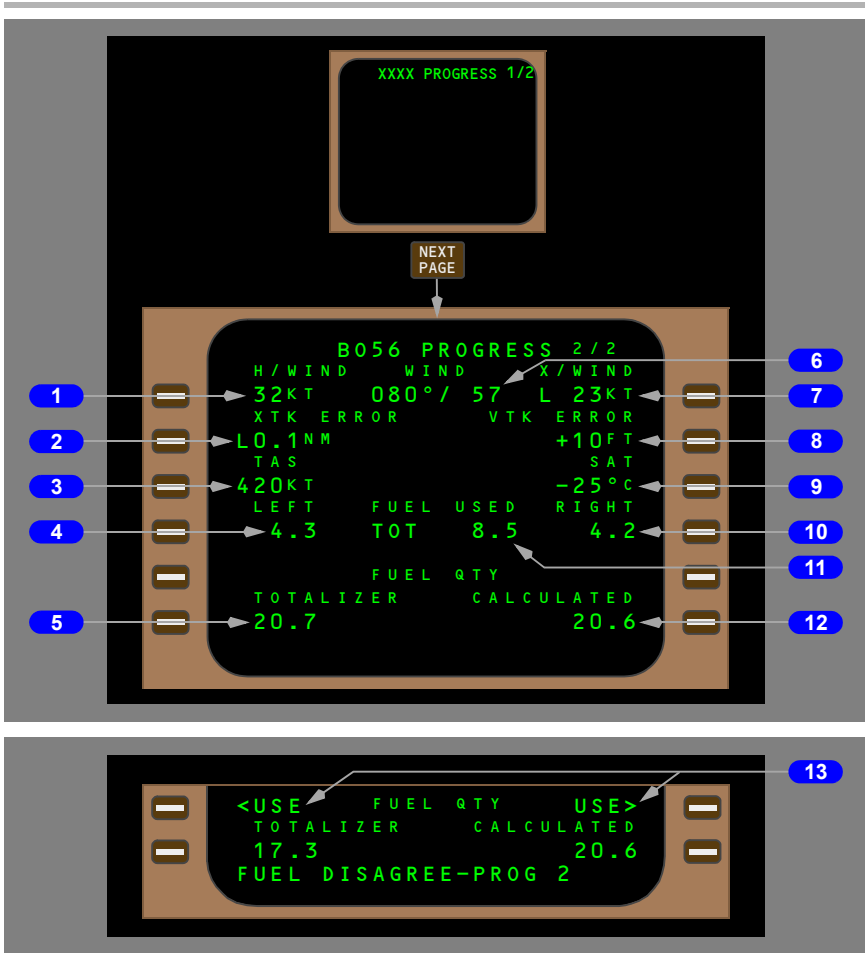

1 Headwind (H/WIND), Tailwind (T/WIND)

Displays headwind (H/WIND) or tailwind (T/WIND) component relative to the airplane heading.

2 Crosstrack Error (XTK ERROR)

Displays crosstrack (XTK) error in nautical miles left or right of the active route.

3 TAS

Displays airplane true airspeed.

4 LEFT FUEL USED

Displays fuel used by left engine sensed by fuel flow meters.

5 Fuel Quantity (TOTALIZER)

Displays total fuel quantity from the fuel system quantity processor.

The fuel remaining line displays two independent fuel remaining values, TOTALIZER and CALCULATED. They can be compared to validate FMC calculations.

6 WIND

Displays current wind direction and speed referenced to true north.

7 Crosswind (X/WIND)

Displays left (L) or right (R) crosswind component relative to airplane heading.

8 Vertical Track Error (VTK ERROR)

Displays vertical path (VTK) error above (+) or below (-) vertical path.

9 Static Air Temperature (SAT)

Displays outside static air temperature.

10 RIGHT FUEL USED

Displays fuel used by right engine sensed by fuel flow meters.

11 FUEL USED Total (TOT)

Displays sum of the LEFT and RIGHT fuel used values.

12 FUEL Quantity (QTY) CALCULATED

Displays fuel remaining as calculated by the FMC with these methods:

- before engine start, fuel quantity calculated by fuel quantity system totalizer
- after engine start, fuel quantity at engine start decreased by EICAS engine fuel flow rate
- after fuel dump or after erasing a manually entered fuel quantity, resets to fuel quantity system totalizer
- after all engines are shutdown, resets to fuel quantity system totalizer.

The fuel remaining line displays two independent fuel remaining values, TOTALIZER and CALCULATED. They can be compared to validate FMC calculations.

13 USE

USE prompts display when TOTALIZER and CALCULATED values disagree by a significant amount. The scratchpad message FUEL DISAGREE-PROG 2 is also displayed.

Push – selects method to calculate fuel quantity, either TOTALIZER or CALCULATED.

When one is selected:

- it is used for remainder of flight
- the other fuel calculation method blanks
- scratchpad clears.

Position Report Page

The position report page displays current flight data formatted as a position report. The page contains reference data only. Manual entries are inhibited.



1 Position (POS)

Waypoint used to report position. This is the previous active waypoint.

The actual time of arrival (ATA) and altitude (ALT) at the waypoint follow the waypoint name.

2 Estimate (EST)

The active waypoint is displayed with the ETA to that waypoint.

3 NEXT

The waypoint following the active waypoint.

4 Temperature and Wind (TEMP WIND)

TEMP displays the OAT in degrees C.

WIND displays the wind direction and speed. Wind direction is shown in degrees true.

5 Destination ETA (DEST ETA)

The FMC calculated ETA for the destination is displayed.

6 Speed (SPD)

Displays the target FMC speed.

7 Position Fuel (POS FUEL)

Displays the fuel on board at the POS waypoint.

Intentionally
Blank

Introduction

The descent phase starts at the top of descent point and continues to the end of descent point. Planning for the descent phase starts during cruise.

The approach phase starts at the end of descent point and continues to touchdown or go-around. When a go-around is accomplished, the FMC enters a modified cruise or approach phase, depending on the route and cruise conditions.

Alternates can be selected at any time. Alternates are available from preflight through all phases of flight and can be updated at any time. Diversion to an alternate can be accomplished during cruise, descent, or approach.

As the airplane passes the top of descent point with VNAV engaged, the descent page becomes active and the CDU automatically changes from the cruise page to the descent page.

Early Descent

Descent for the approach and landing may be commenced before reaching the top of descent point. The description of early descent options and functions is in Section 42, FMC Cruise.

Descent

During descent, LNAV is managed using the RTE LEGS page, as in the cruise phase. VNAV descent management is accomplished primarily on the DES page.

Other pages which support descent are:

- DESCENT FORECAST page – to enter forecast wind data to aid descent planning
- OFFPATH DES page – to analyze descent performance with and without the use of speedbrakes

Descent Page

The descent page is used to monitor and revise the descent path. Descent speed modes are economy (ECON) and fixed speed (SEL). The default VNAV descent mode is ECON. A fixed speed descent is flown when speed intervention is used or a speed is entered on the DES page. The descent page is no longer available after the end of descent.

The page title includes the VNAV speed mode. The ECON mode controls descent speed at the economy speed until reaching a lower speed restriction. The fixed speed mode controls descent speed until a lower speed restriction is reached.

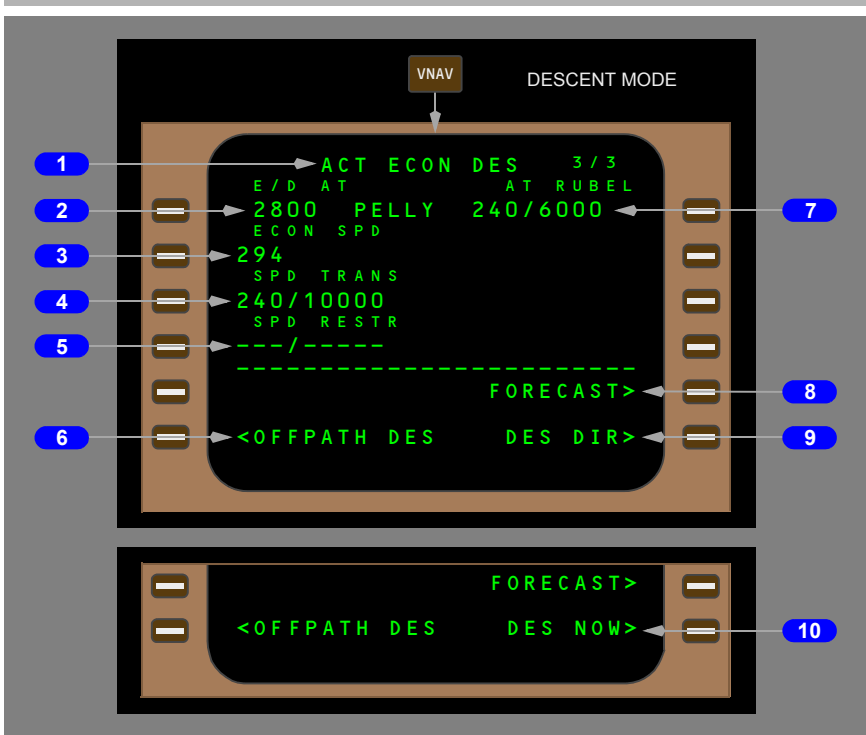

1 Page Title

The title usually shows ECON during descent. Fixed speed descents modify the title.

The page title shows the type of descent:

- ECON – speed based on a cost index
- LIM SPD – speed based on airplane configuration limiting speed
- MCP SPD – MCP speed intervention is selected
- XXXKT – fixed CAS descent speed profile
- M.XXX – fixed Mach descent speed profile
- ACT – prefix shown when descent phase is active
- MOD – prefix shown when descent phase is active and the flight plan is modified.

Reasons for fixed descent speeds are:

- waypoint speed constraints
- an altitude constraint associated with a speed constraint
- a speed transition
- a flight crew entered selected speed (SEL SPD).

2 End Of Descent At (E/D AT)

Shows the end of descent altitude and waypoint.

The end of descent point is a waypoint in the descent phase with the lowest altitude constraint.

Blank if no E/D point exists.

3 Economy Speed (ECON SPD), Selected Speed (SEL SPD)

Shows the current target descent speed.

ECON SPD –

- economy speed based on cost index
- shows CAS or Mach.

SEL SPD –

- shows when intermediate level off required below an existing speed constraint
- shows when flight crew enters speed
- CAS or Mach value may be entered.
- page title changes to ACT XXXKT DES or ACT M.XXX DES
- <ECON prompt appears at line 5L to allow selection of economy descent speed

4 Speed Transition (SPD TRANS)

The transition speed is usually 10 knots less than the destination airport limiting speed from the navigation database. When no airport limit speed exists, the default speed of 240 knots is shown. The transition altitude is the point that the transition speed is active for the destination airport. When no altitude exists in the navigation database, the default of 10,000 feet is shown.

Blanks when the transition has occurred.

Can be deleted.

5 Speed Restriction (SPD RESTR)

Speed restrictions not associated with specific waypoints are manually entered on this line.

Dashes before entry by flight crew.

Valid entry is a CAS and altitude (example 240/8000).

An entry creates a modification.

6 Off Path Descent (OFFPATH DES)

Push – shows the OFFPATH DES page.

7 AT XXXXX

Shows the next waypoint constraint from the RTE LEGS page.

Line title shows:

- AT XXXXX (the waypoint identifier)
- HOLD AT XXXXX
- AT VECTORS
- AT (INTC).

The constraint is speed/altitude. Blank when no constraint exists.

Can be deleted on this page.

VNAV commands the lesser of constraint speed or present performance speed.

8 FORECAST

Push – shows the DESCENT FORECAST page.

9 Descend Direct (DES DIR)

Push – deletes all waypoint altitude constraints between the airplane altitude and the MCP altitude. FMC cruise altitude is not affected.

Shown in descent phase with altitude constraint between airplane and E/D.

10 Descend Now (DES NOW)

Shown when the descent phase is not active.

Push –

- starts a 1250 feet per minute descent schedule until intercepting the planned descent path
- activates the FMC descent phase.

Descent Forecast Page

The descent forecast page is used to enter wind data for descent, and the altitude at which anti-ice use is anticipated for more accurate descent path calculation.

The primary entries are wind direction and speed for up to four descent altitudes, and the altitude that anti-ice is turned on.



1 Transition Level (TRANS LVL)

Shows the transition level.

The transition level can be specified by the arrival procedure. The default transition level is FL 180.

Above transition level, altitudes are in flight levels. Below transition level, altitudes are in thousands of feet.

Valid entry is an altitude or flight level.

2 Altitude (ALT)

Enter altitude of forecast wind data.

Altitudes and flight levels can be entered in any order. Entries are not sorted.

Execute not necessary.

3 Thermal Anti-Ice On Altitude (TAI/ON ALT)

Enter the altitude where anti-ice is first turned on during the descent. The FMC calculates the descent profile based on the higher thrust caused by thermal anti-ice operation below this altitude.

4 Wind Direction/Speed (WIND DIR/SPD)

Enter the wind direction/speed for the specified altitude. Initial entry must have wind direction and speed, subsequent entries may have one or the other.

Execute not necessary.

5 Descent (DES)

Push – shows the DES page.

Offpath Descent Page

The offpath descent page allows the analysis of descent performance off the present route of flight, direct to a selected waypoint. Data entered on the page shows clean and drag descent ranges on the page and on the map display. The ranges are based on an entered waypoint and altitude constraint. The range can be used to determine if the altitude constraint can be met in a direct descent to the waypoint.

The FMC puts the last descent waypoint with an altitude constraint into DES TO. The ECON SPD, SPD TRANS, SPD RESTR, and DES data are the same as the DES page.



1 Descend To (DES TO)

The waypoint for a direct-to descent. Usually, this is the E/D waypoint from the active route. Manual entry of waypoints on or off of the route are allowed. The DTG calculations are for a descent direct to the selected waypoint.

When within 150 feet of the DES TO altitude for a waypoint other than the E/D waypoint, the display automatically changes the DES TO waypoint to the E/D waypoint from the DES page.

A waypoint is entered for direct-to analysis.

2 Distance To Go (DTG)

Shows the straight line distance to the entered waypoint.

3 Speed/Altitude (SPD/ALT)

Shows the speed/altitude constraint for the entered waypoint.

A manual waypoint entry shows boxes for manual speed and altitude entry.

4 TO CLEAN

Distance to the clean descent circle. The distance is negative when a clean descent is no longer possible.

A clean circle assumes no drag devices are used for descent.

A direct descent to the DES TO waypoint at a SPD/ALT constraint is possible when the airplane is outside the clean circle. The clean circle is shown on the map display when the DISPLAY prompt is ON.

5 TO DRAG

Distance to the drag descent circle. The distance is negative when a drag descent is no longer possible.

A drag circle assumes speedbrakes are UP for descent.

A direct descent to the DES TO waypoint at a SPD/ALT constraint is possible when the airplane is outside the drag circle. The drag circle is shown on the map display when the DISPLAY prompt is ON and the airplane is inside the clean circle.

6 DISPLAY

Push – alternates between ON and OFF.

ON – shows the clean and drag circles on the map display. The drag circle is not displayed until the airplane position is inside the clean circle.

OFF – removes the clean and drag circles from the map display.

Selected state is large font.

Automatically changes to OFF within 150 feet of the waypoint constraint altitude.

Engine Out Descent

There are no specific engine out pages for descent. Use the two engine descent planning features and pages.

Approach

During approach, roll and pitch modes usually change to the approach guidance supplied by navigation radios. The FMC continues to calculate and show present position and can supply LNAV and VNAV approach guidance for certain types of approaches when radio navigation is not used.

The RTE LEGS and DESCENT pages are used to manage the airplane until other approach guidance becomes active. Other pages which support approaches are:

- ARRIVALS page – to select arrival and approach procedures
- HOLD page – to manage holding patterns.
- APPROACH REF page – to specify approach flap settings and set the approach VREF speed

Holding is described in this section but it can be used during any phase of flight.

Arrivals Page – IFR Approaches

The arrivals page allows selection of an approach, standard terminal arrival route (STAR), and an arrival transition to the destination airport. This page can also be used to view data about a selected airport that is not the destination. Route 1 and Route 2 have separate arrival pages.

The approaches, STARS/profile descents, and transitions are shown and selected on this page.

Selecting Options

Selecting a runway, approach, approach transition, STAR/profile descent, or descent transition option shows <SEL> inboard of the selection, and makes a route modification. The other options within the same category are removed from the list. When the modification is executed, <SEL> changes to <ACT>. Select another page and return to ARRIVALS to show all options; the applicable <SEL> or <ACT> prompts are shown.

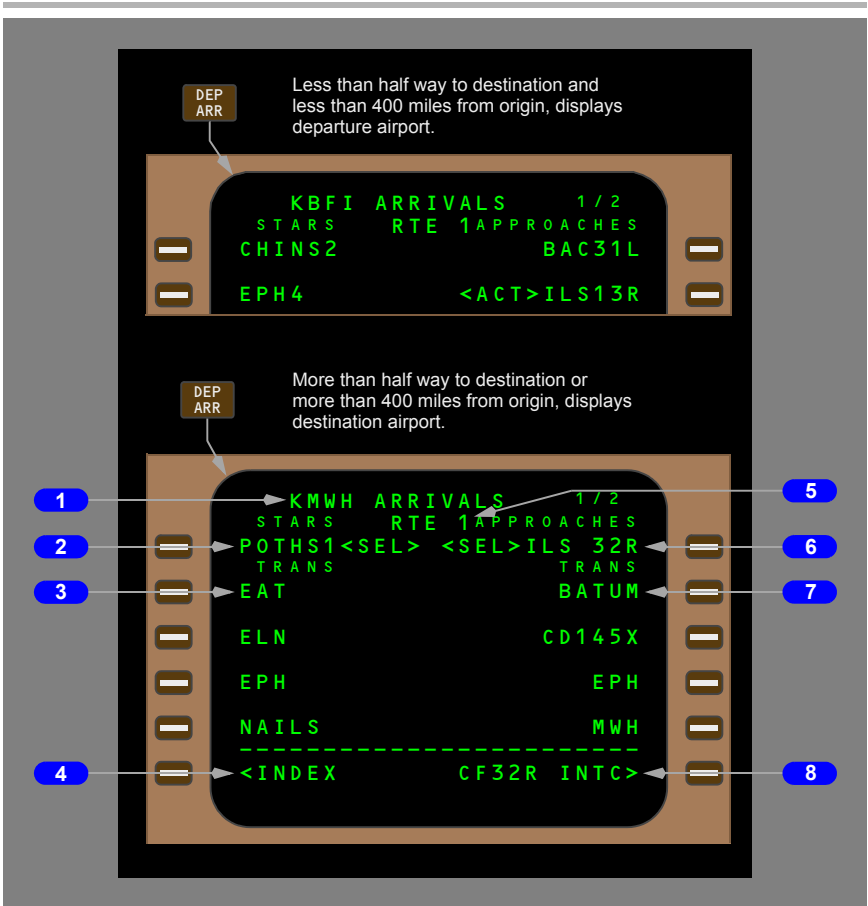

1 Page Title

The destination airport identifier is shown in the title.

Airports with more than 5 runways or STARS produce multiple arrivals pages.

2 Standard Terminal Arrivals (STARS)

Lists the STARS and PROFILE DESCENTS for the airport.

STARS are shown first in a list under the STAR line title. Profile descents are listed after the STARS under the PROF DES line title.

When a selection is made the procedures not selected are removed from the page. The selected procedure is listed with <SEL> and a list of compatible transitions is shown.

3 Standard Terminal Arrivals Transitions (STARS TRANS)

Lists all the transitions for the selected STAR.

When a selection is made the transitions not selected are removed from the page. The selected transition is listed and marked <SEL>.

4 INDEX

Push – shows the DEP/ARR INDEX page.

5 Route 1 (RTE 1)

Shows the active route number (RTE 1 or RTE 2).

6 APPROACHES

Lists all approaches and runways for the destination airport.

When a selection is made, other approaches and runways are removed from the page and compatible transitions are listed. The list of STARS and profile descents is reduced to those compatible with the selected approach.

7 Approach Transitions (APPROACHES TRANS)

Transitions are listed when an approach is selected. Shows a list of available transitions to the selected approach.

Approach transitions include:

- IAF
- feeder fix
- fixes which define routing to the FAF.

Selecting an approach without a transition makes a straight-in approach which starts at:

- a charted fix or CFXXX, where XXX is the runway number
- a waypoint 4–8 miles outside the final approach fix.

8 Final Approach Fix Intercept (XXXXX INTC)

Selecting the prompt shows a modified RTE LEGS page with an intercept course to the approach transition fix (usually the IAF) for the selected approach.

Vertical Angle Display on the Route Legs Page

When a runway is selected as part of the active route the vertical angle of the flight path approaching the runway is displayed on the RTE LEGS page.



1 Glide Path (GP) Angle

Displays the vertical angle for use by VNAV on the final approach to the runway. If the runway was selected as part of a published approach, the displayed angle will be close to the published glide path angle but may differ slightly.

Arrivals Page – VFR Approaches

The arrivals page also allows selection of a VFR approach if the navigation database contains a VFR approach for the selected runway.



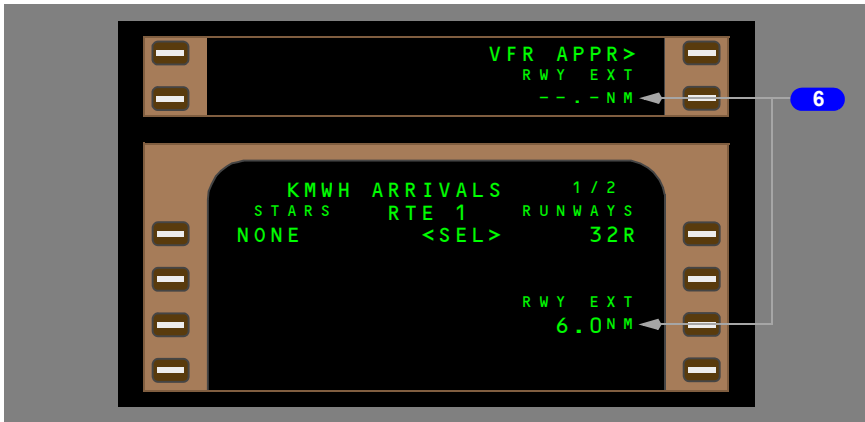
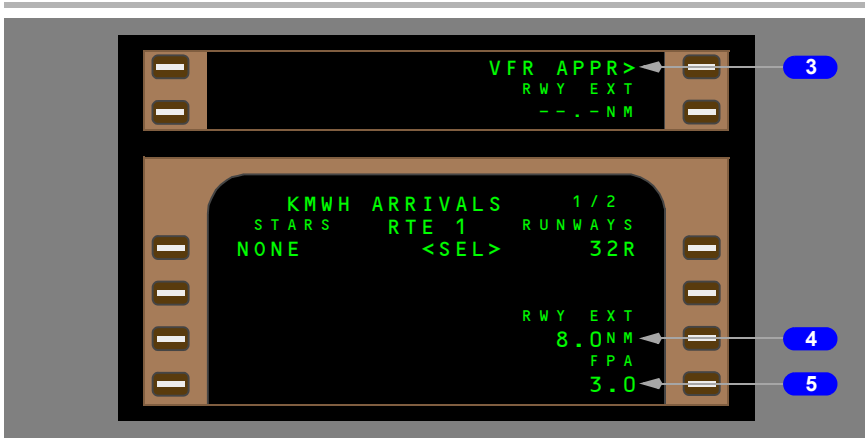

1 RUNWAYS

Push – removes approach list and other runways. Displays RWY EXT prompt and VFR APPR prompt in line 2 if a VFR approach is in the navigation database.

The RUNWAYS list for other runways is shown if a runway is not selected.

Example shows runway 32R selected. Change the CDU to another page and return to the ARRIVALS page to show all arrival procedures.

2 ROUTE

Push – shows the active route page 2/X.

3 VFR Approach (VFR APPR)

Push – makes a transition waypoint, FAXXX at 8 NM and 2000 feet above the runway.

Shown when a VFR approach is in navigation data base for selected runway.
LNAV and VNAV guidance to the runway is available.

4 Runway Extension (RWY EXT)

After VFR APPR is selected, RWY EXT can not be modified.

5 Flight Path Angle (FPA)

Shows flight path angle. Shown only after VFR APPR is selected.

Default is 3.0 degrees. Valid entries are from 2.4 to 3.7 degrees.

6 Runway Extension (RWY EXT)

Valid entries are from 1.0 to 25.0 miles from the runway threshold.

Entry allowed if VFR APPR is not selected. Entry removes VFR APPR prompt.
Example shows 6 NM entered.

Makes waypoint RXYYY, where YYY is the runway; example: RX32R. Makes a route discontinuity before and after the waypoint.

VFR Approach Path

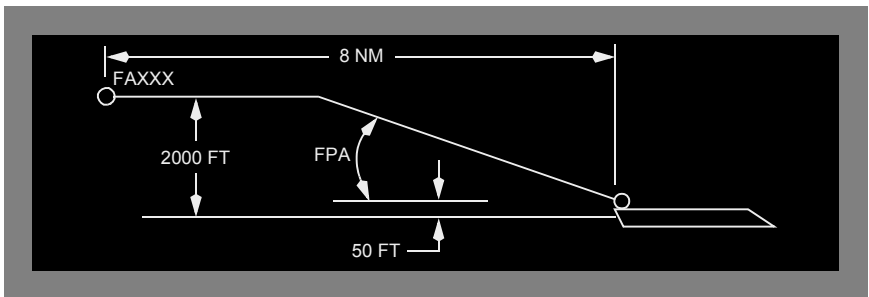

The VFR approach is a level path until the FPA is intercepted. The FPA goes from the FAXXX waypoint altitude to the runway threshold at 50 feet and 170 knots. Default values are shown in RWY EXT and FPA.

Approach Reference Page

The approach reference page shows approach planning data and approach reference speed (VREF) selection.

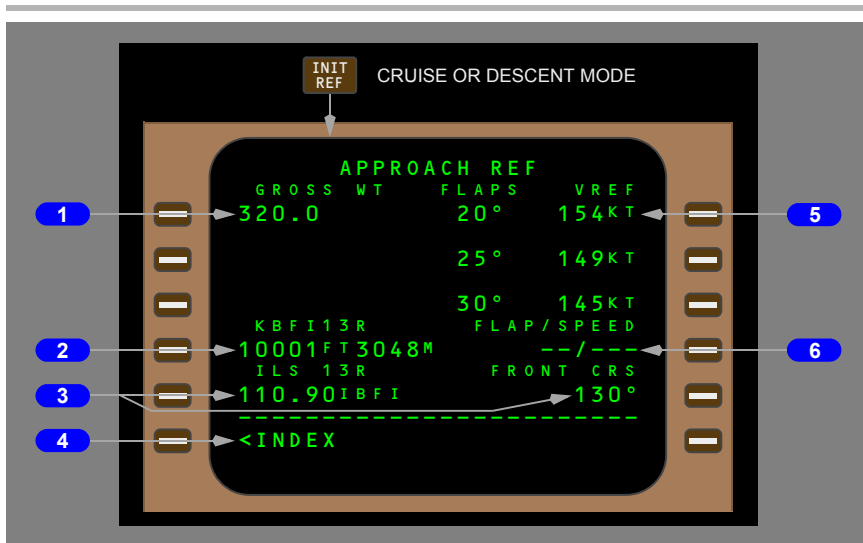

1 Gross Weight (GROSS WT)

FMC calculated airplane gross weight is usually shown.

Manual entry is allowed in case the FMC calculated gross weight is unavailable or invalid, or to allow previewing recommended approach speeds at other than the calculated FMC gross weight. The manually entered gross weight is for reference only and is deleted when a different page is selected. Permanent changes to gross weight may only be made on the PERF INIT page.

Shows boxes when gross weight is not available from the FMC.

Valid entry is XXX.X.

2 Runway Length

The shown runway reference changes based on route progress. The destination runway is the reference when the present position is more than halfway to the destination or more than 400 NM from the origin airport. The origin airport runway is the reference when less than halfway or less than 400 NM from the origin airport.

Shows the length of the referenced runway in feet and meters.

3 ILS Frequency and FRONT Course (CRS)

Display is blank prior to entering a destination runway in the active route.

Displays the runway, corresponding ILS frequency, facility identifier and FRONT CRS from the navigation database for the runway shown.

4 INDEX

Push – shows the INT/REF INDEX page.

5 FLAPS VREF

A gross weight is necessary for VREF speed calculation. Push the applicable line select key to select the correct VREF speed. The three VREF speeds are based on landing flap setting.

Shows the calculated reference speed for flaps 20°, 25°, and 30°.

The display is blank until a gross weight is shown.

Alternate Airport Diversions

The ALTN page data helps the flight crew find the best alternate airport. The page has four airports shown in an ETA sequence. Each airport on the list has an ALTN XXXX page with more data. Select the ALTN XXXX page with a caret.

Alternate Page

The alternate page displays a list of alternate airports. An alternate airport can be selected from this page to change the flight plan destination.

The page displays a list of up to four alternate airports sorted in order of the ETA to the airport while airborne. The source of alternate airports can be:

- automatic selection from the navigation database
- manual entry.

Alternate airports automatically selected from the navigation database are displayed in small font. The presently selected alternate airport is shown on the map display in normal airport symbology. All four alternate airports are shown on the plan mode.

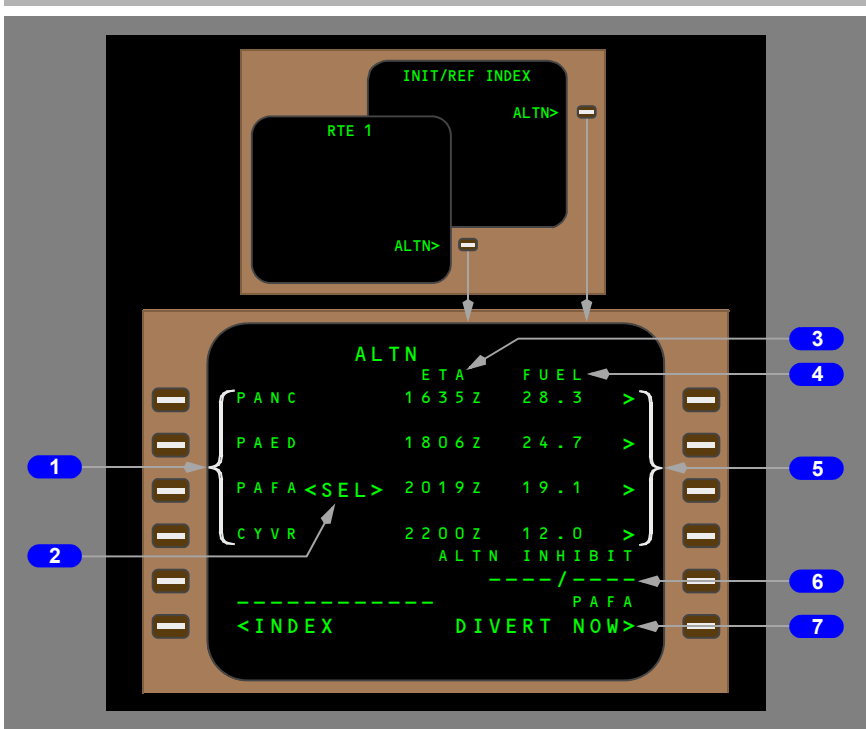

1 Alternate Airports

Displays the identifier of four alternate airports in ETA order when airborne. Displays the identifier of four alternate airports in distance order when on the ground.

Valid manual entry is an airport from the navigation database. A manual entry replaces the alternate where the entry is made and is shown in large font. After entry, the four airports are resequenced according to ETA.

Use the DELETE function to remove manually entered alternate airports from the ALTN page.

2 Selected (<SEL>), Automatically Selected (<A>)

<SEL> indicates a manually selected alternate airport.

A manual selection of an alternate airport is made by pushing the line select key left of the airport identifier with nothing in the scratchpad.

When there is no manually selected alternate the FMC automatically selects the alternate airport with the earliest ETA. Automatically selected alternates are indicated by <A> next to the airport identifier.

The selected alternate identifier is shown in the line title of the DIVERT NOW prompt.

Entering a new airport into the list deletes the last airport in the list and selects the new airport. After entry, the airports are rearranged in ETA sequence. Manually entered airports are shown in large font and can be removed using the DELETE function.

Use the DELETE function to remove the <SEL> from a manually selected alternate. The automatic selection function selects a new alternate.

3 ETA

Displays the alternate airport ETA.

ETA is calculated based on the routing, altitude, and speed shown on the XXXX ALTN page. ETA is blank when the airplane is on the ground.

4 FUEL

Displays the alternate airport predicted arrival fuel.

Predicted arrival fuel is calculated based on the routing, altitude, and speed shown on the XXXX ALTN page. The message UNABLE FUEL is shown in the FUEL column if the predicted arrival fuel is less than zero.

Fuel values are blank when the airplane is on the ground.

5 Alternate Select

Selects the XXXX ALTN page, which contains more data about the specific airport.

6 Alternate Inhibit (ALTN INHIBIT)

An airport will not be one of the four alternate airports if entered into the alternate inhibit line.

One or two airports can be manually entered.

Valid entries are airports from the navigation database.

7 DIVERT NOW

The DIVERT NOW selection modifies the route to go from the present position to the selected alternate using the route shown on the XXXX ALTN page.

Push –

- makes an LNAV route modification for a divert to the selected alternate
- automatically displays the MOD XXXX ALTN page for the selected alternate

- displays SELECTED in this position on the CDUs not involved with the modification
- blank on ground
- blank in the air when a diversion is not permitted.

The DIVERT NOW selection changes the display to the XXXX ALTN page for the diversion airport. The details of the route can be confirmed or modified before the diversion is executed.

Execution of the diversion:

- changes the route destination airport
- includes the route modification into the active flight plan
- deletes all parts of the original route that are not part of the diversion
- if a descent path exists, deletes all descent constraints (the scratchpad message DESCENT PATH DELETED is shown when DIVERT NOW is selected).

After a divert is executed the XXXX ALTN page is not updated until all CDUs are selected off of the XXXX ALTN page.

XXXX Alternate Page

Each of the four alternate airports shown on the ALTN page 1/2 have a related XXXX ALTN page. The XXXX ALTN pages show specific data about alternate airports, the route used for a diversion, and the conditions upon which the ETA and fuel calculations are based. All data on the page is related to the alternate airport shown in the page title.

Three route options to the airport can be selected:

- DIRECT TO – direct to alternate
- OFFSET – flight plan route with an offset
- OVERHEAD – flight plan route to a waypoint then direct to alternate.

The selected route option is identified by <SEL>. ETA and fuel remaining are calculated based on the selected option. Selection of a route option for one alternate selects the same route option for the other three alternates.

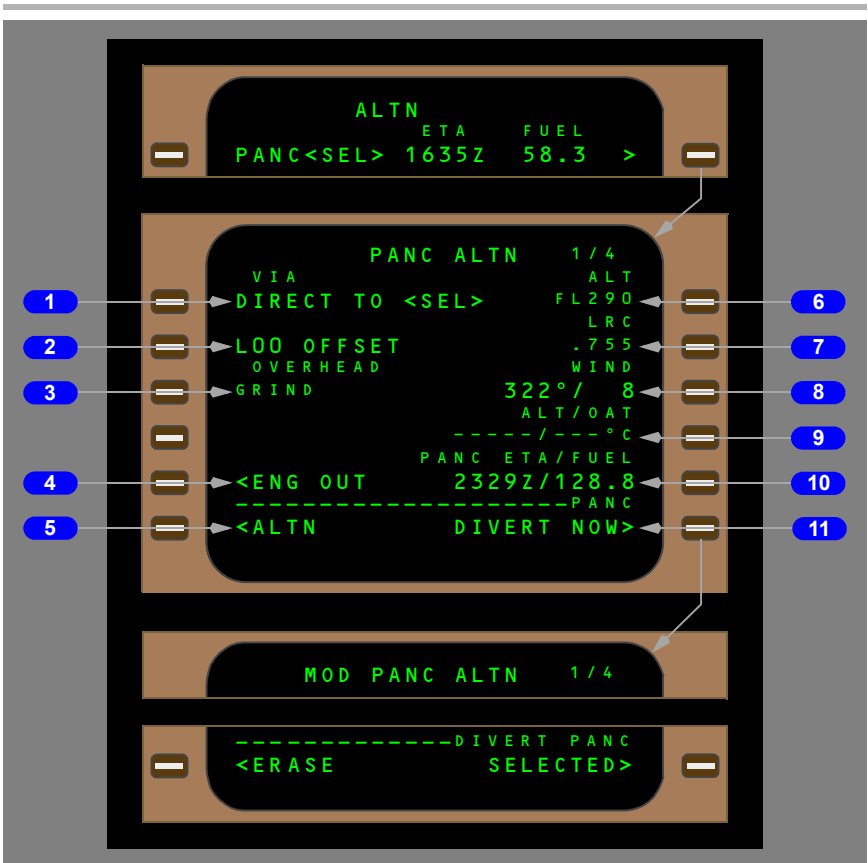

1 VIA DIRECT TO

Push – selects present position DIRECT TO alternate route option.
All flight plan waypoints are deleted.

2 VIA OFFSET

Push –

- with scratchpad empty, selects OFFSET route option
- with offset data in scratchpad, enters offset data. Does not select option.

Entry and exit to the offset is the same as for the RTE page offset. All flight plan waypoints are kept.

3 VIA OVERHEAD

Push –

- with scratchpad empty, selects OVERHEAD option
- with overhead data in scratchpad, enters overhead data. Does not select route option.

Displays active waypoint in flight plan.

The waypoints up to the selected or entered overhead waypoint are kept, then routing is direct to the alternate airport. All waypoints after overhead waypoint are deleted.

Enter any waypoint in the active or modified route.

4 Engine Out (ENG OUT)

This prompt performs the same function as described on the cruise page in the FMC Cruise section. It can be selected before or after the diversion is selected.

5 Alternate (ALTN)

Push – displays the ALTN 1/2 page.

6 Altitude (ALT)

Entry of any valid altitude or flight level into this line causes a recomputation of ETA and arrival fuel. Altitude entries do not become part of the diversion modification. Altitude entries apply to all four alternates.

Displays the altitude for which ETA and arrival fuel are calculated.

The scratchpad displays the message UNABLE ALT, if the entry is above maximum altitude or the top of climb point for divert is after top of descent point for divert.

7 Speed (SPD)

Entry of speed or Mach number into this line causes a recomputation of ETA and arrival fuel. Speed entries do not become part of the diversion modification. Speed entries apply to all four alternates.

Speed modes available are:

- ECON (economy)
- LRC (long range cruise)
- EO (engine out)
- EO LRC (engine out long range cruise)
- CO (company speed)
- any CAS or Mach.

8 WIND

Entry of data into these lines causes a recomputation of ETA and arrival fuel. A separate wind entry may be made for each of the four alternates.

Displays the estimated average wind for the divert route.

Valid entry is a direction in degrees/speed in knots from 1 to 999.

9 Altitude/Outside Air Temperature (ALT/OAT)

Entry of data into these lines causes a recomputation of ETA and arrival fuel. A separate ALT/OAT entry may be made for each of the four alternates.

Displays the OAT for a specific altitude.

Valid entry is an altitude/temperature in degrees C.

10 Alternate Airport ETA/Fuel (XXXX ETA/FUEL)

Displays the calculated airport ETA and arrival fuel based on the selected route, altitude, and speed shown on this page.

11 XXXX DIVERT NOW

This prompt performs the same function as described on the ALTN 1/2 page.

Note: After a divert is executed, the XXXX ALTN page data is not updated until all CDUs change to a page other than the XXXX ALTN page.

Holding

The FMC computes holding patterns with constant radius turns based on current wind and FMC commanded airspeed. The pattern size is limited to FAA or ICAO protected airspace. In LNAV, the AFDS tracks the holding pattern using up to a 30 degree bank angle. Strong winds or airspeed in excess of FAA or ICAO entry speeds may result in the airplane flying outside the protected airspace.

Entry to a holding pattern is via the parallel, teardrop, or direct entry methods, dependant upon the airplane's track to the hold fix. However, to make efficient use of the holding airspace, the airplane may begin the initial turn to the holding entry maneuver, parallel, teardrop or direct, just prior to crossing the hold fix ("fly-by"). In all entry maneuvers the airplane will "fly-over" or "fly-by" the holding fix as appropriate to remain on the holding side of the inbound hold course. Teardrop and parallel entry flight maneuvers are flown within the confines of the holding pattern as displayed on the HSI. Direct entry maneuvers may extend slightly beyond the end of the hold pattern.

Note: The holding pattern entry flight path is displayed on the HSI with an HSI selected range of 40 NM or less, and after the holding fix becomes the active waypoint.

Hold Page (First Hold)

The hold page is used to enter a holding pattern into the route.

When the flight plan does not have a holding pattern, push the HOLD function key to show the RTE X LEGS page with the HOLD AT line.

Two versions of the hold page are possible:

- an airway or procedure holding pattern
- a flight crew-entered holding pattern.

The holding page displays actual or default data about the holding pattern.

Entries make route modifications, which can be erased or executed.

Active holding patterns are magenta on the HSI.

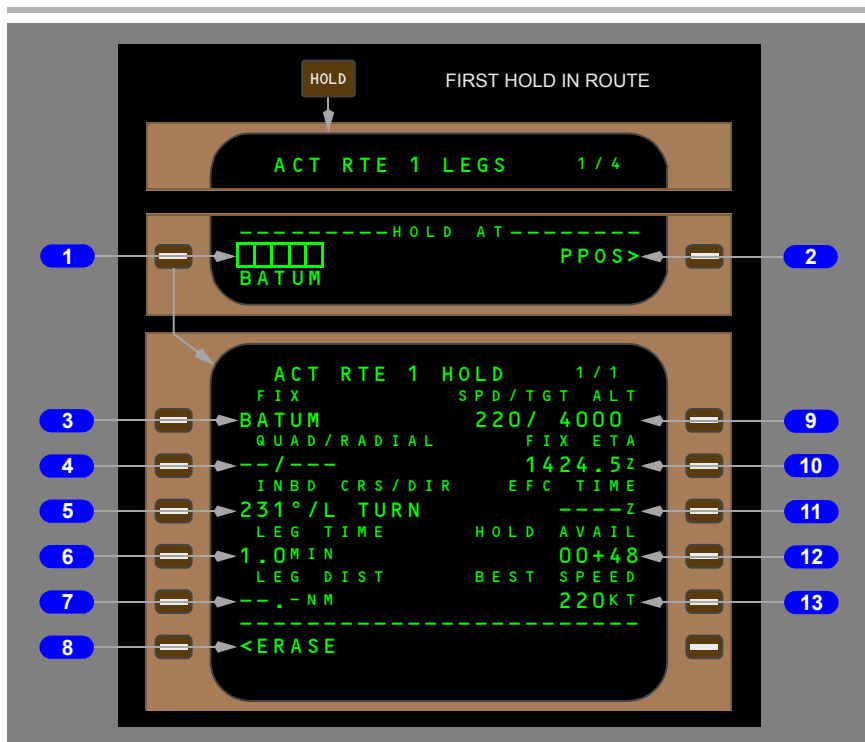

1 HOLD AT

When the HOLD function key is pushed and no holding pattern exists in the route, the RTE LEGS page displays prompts to enter the holding fix. Enter the holding fix to show the RTE X HOLD page.

Normally a route waypoint is entered as the holding fix. If a waypoint that is not part of the active route is entered the scratchpad message HOLD AT XXX appears where XXX is the entered waypoint. The holding fix can then be inserted in the route in the proper sequence.

2 HOLD AT Present Position (PPOS)

Selects the airplane present position as the holding fix.

3 Holding FIX

Displays the holding fix.

4 Quadrant/Radial (QUAD/RADIAL)

The holding quadrant and radial are entered.

Valid entry is X/XXX, XX/XXX, or /XXX (example NE/040).

Automatically changes INBD CRS/DIR to agree.

5 Inbound Course/Direction (INBD CRS/DIR)

Displays the holding inbound course and turn direction.

Valid entry is XXX (inbound course), XXX/X (inbound course/turn direction), /X or X (turn direction).

Automatically changes QUAD/RADIAL to agree.

6 LEG TIME

Default display is 1.0 MIN (minute) at or below 14,000 feet or 1.5 MIN above 14,000 feet.

Displays -- if a LEG DIST is entered.

Valid entry is X, X.X, or .X in minutes from 0.1 to 9.9.

When climbing/descending through 14,000 feet with VNAV engaged and the SPD/TGT ALT values are displayed in large font, the FMC adjusts leg time (1.0 MIN at or below 14,000 feet; 1.5 MIN above 14,000 feet).

7 Leg Distance (LEG DIST)

Default display is -- NM if no leg distance has been entered or if a LEG TIME is entered

Valid entry is X.X, XX.X, or .X.

8 ERASE

Erases all FMC modifications.

9 Speed/Target Altitude (SPD/TGT ALT)

Waypoint holding fix speed/altitude constraint from the RTE LEGS page.

Manual entries are in large font.

During cruise, an altitude entry below cruise altitude activates the descent page, unless a new cruise altitude is entered. Altitude entry must be at or below cruise altitude.

A speed entry requires an altitude constraint.

10 FIX ETA

Displays the ETA to the next passing of the holding fix.

11 Expect Further Clearance Time (EFC TIME)

Enter the expect further clearance time to enable accurate fuel and ETA predictions after the hold.

12 Hold Available (HOLD AVAIL)

Displays calculated holding time available before requiring reserve fuel to reach the destination.

13 BEST SPEED

Displays the best holding speed for the airplane gross weight, altitude, and flap setting.

Note: May exceed ICAO limit speed.

Hold Page (Existing Hold)

When one or more holding patterns are already in the route, push the HOLD key to show the hold page for the first holding pattern. Holding parameters can be monitored and changed on this page. New holding patterns are added using the NEXT HOLD prompt.

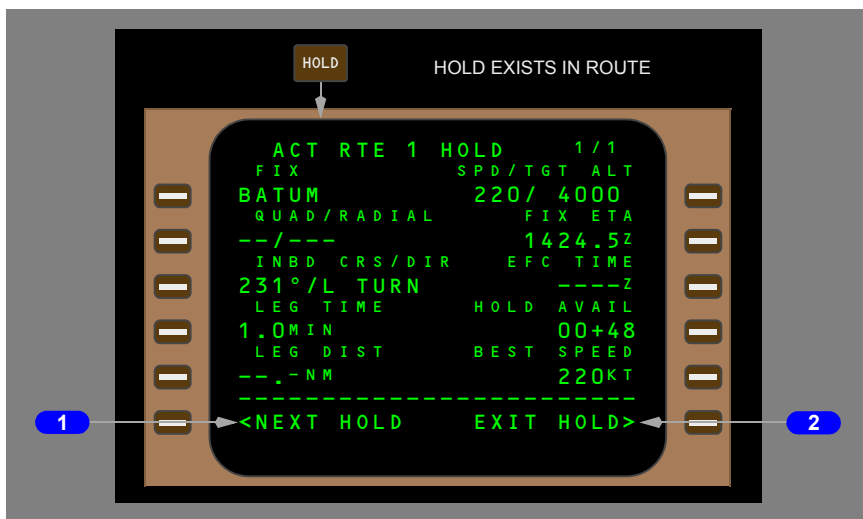

1 NEXT HOLD

Push – displays a new hold page for a new holding pattern entry.

2 EXIT HOLD

Push –

- arms a return to the holding fix via the inbound course for holding pattern exit
- EXIT ARMED displayed
- EXEC light illuminated.

When the EXEC key is pushed, the airplane will cross the holding fix and exit holding. If executed when outbound in the holding pattern the airplane will immediately turn inbound and exit holding when the fix is crossed.

Exit from the hold will be initiated prior to crossing the hold fix ("fly-by") if the course to the next route waypoint is not closely aligned with the holding inbound course. Acute angles between the inbound hold course and the course to the next waypoint may result in a substantial distance from the airplane to the hold fix during the exit hold maneuver. However, flight is maintained at all times within FAA or ICAO protected holding airspace. The exit flight path is displayed on the HSI.

Note: If a turn (course change) of 110°- 135° is required to exit the hold toward the next flight plan waypoint, the exit flight path on the HSI may display as a zigzag line, typically in the shape of a Z. However, in all instances LNAV provides appropriate guidance via a smooth turn to intercept the active leg to the next route waypoint. There is no indication on the FMC CDU LEGS page if the exit flight path displayed on the HSI is irregular.

Intentionally
Blank

Introduction

The CDUs can be used as an alternate navigation system if both FMCs fail. The CDUs perform lateral navigation computations. LNAV and VNAV are not available.

During normal FMC operation, all system capabilities are contained within the FMCs. During alternate navigation operation, the CDUs use their own internal memory and computing capability.

Each CDU performs its calculations based on inputs from its own IRS and provides information for display independent of the other CDU. Each CDU can display its route on its respective map display without database symbology.

Alternate Navigation Waypoints

The CDUs do not have a performance or navigation database. The CDUs continuously load the active route from the FMC. If both FMCs fail, the CDUs keep flight plan waypoints except for conditional waypoints, offsets, and holding patterns. Waypoints which are part of the route when the FMCs fail can be referenced by either their identifier, or latitude and longitude.

New waypoints can only be entered as latitude and longitude. This includes waypoints the flight crew has deleted from the CDU. Complete departure or arrival/approach procedures cannot be manually entered.

Waypoint Operations

Waypoint operations include:

- add new waypoints (latitude/longitude entry only)
- remove existing waypoints
- change the sequence of existing waypoints
- connect discontinuities.

Alternate Lateral Navigation

All CDU calculations are based on a great-circle course between waypoints.

Route Changes

Route changes are made on IRS LEGS page in almost the same manner as normal FMC operations. All courses between waypoints are direct routes. When the active waypoint is modified, the only navigational choice is present position direct to the modified active waypoint.

The two CDUs operate independently. A route change to one CDU does not change the other one. The route entered in the left CDU can be displayed on the captain's HSI using his NAV source select switch. The route entered in the right CDU can be displayed on the first officer's HSI using his NAV source select switch.

Course Reference

Each CDU uses its associated IRS for navigation data. The IRS supplies magnetic variation only for the present position. Therefore only the active waypoint course can be referenced to magnetic north. All subsequent courses are referenced to true north.

Alternate Navigation CDU Pages

The alternate navigation system provides two CDU pages:

- IRS LEGS
- IRS PROGRESS

Failure of a single FMC causes the related CDU to display the MENU page. Selecting the operable FMC on the NAV selector switch restores the CDU displays to normal.

If the other FMC fails, the IRS LEGS and IRS PROGRESS pages are available on either CDU via the LEGS and PROG mode select keys. Selecting CDU on the NAV source selectors provides a CDU generated map on the map display.

IRS Legs Page

This page displays data about each leg of the route. The route can be modified. Waypoint speed and altitude restrictions are not displayed because performance data is not available.

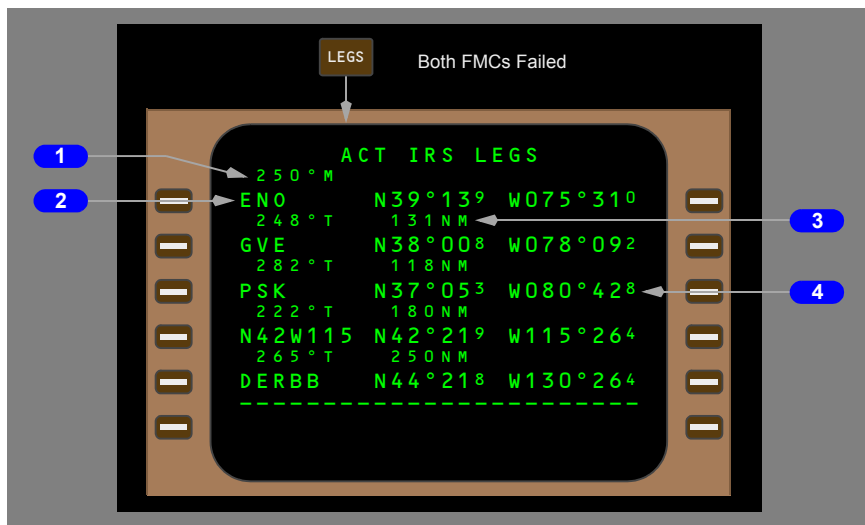

1 Leg Direction

Displays course to the waypoint.

Course reference is M for magnetic, T for true.

Active waypoint leg direction can be magnetic or true. Subsequent waypoint leg directions are true.

2 Waypoint Identifier

Displays the waypoint by name or latitude/longitude.

Valid entries are waypoint names that were in the route when the FMCs failed, or latitude/longitude for new waypoints.

3 Distance to Waypoint

Displays the great circle distance between waypoints.

4 Waypoint Coordinates

Displays the waypoint coordinates.

IRS Progress Page

This page shows general data about flight progress.

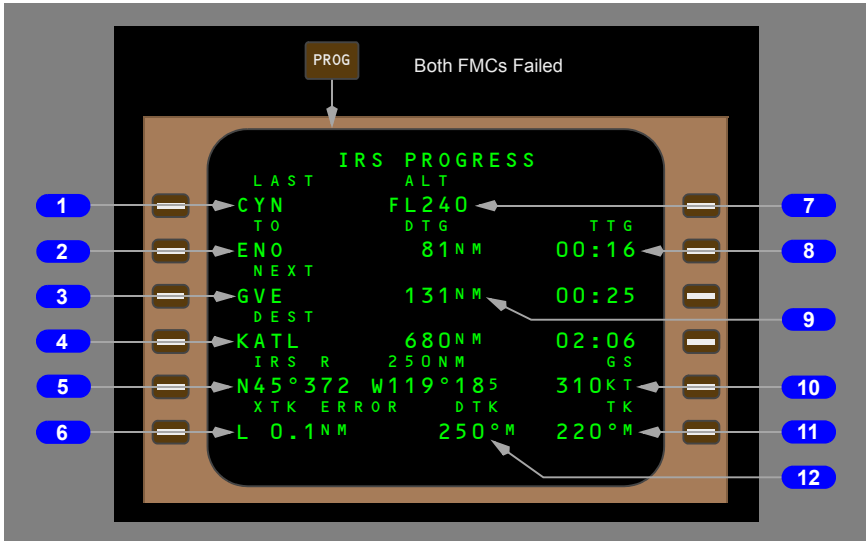

1 LAST

Displays the identifier of the last waypoint.

2 TO

Displays the active waypoint.

3 NEXT

Displays the waypoint after the TO waypoint.

4 Destination (DEST)

Displays identifier for route destination waypoint or airport. Any waypoint on or off the route can be entered. Time and distance data temporarily displays for that waypoint.

Display options:

- destination airport identifier; distance and time to go along track to the destination airport
- entry of an existing flight plan waypoint (identifier or latitude/longitude) causes the line title to change to ENROUTE WPT. Time and distance to go are along the track to the enroute waypoint
- entry of a waypoint not in the flight plan causes the line title to change to DIR TO ALTERNATE. Time and distance to go are from the present position direct to the new waypoint.

5 IRS Position

Displays IRS present position.

Line title displays IRS source for position.

6 Cross Track Error (XTK ERROR)

Displays airplane left or right cross-track error in nautical miles from the active route track.

7 Altitude (ALT)

Displays airplane altitude when the LAST waypoint was crossed.

8 Time to Go (TTG)

Displays time to go to waypoint or destination.

9 Distance to Go (DTG)

Displays distance to go to waypoint or destination.

10 Ground Speed (GS)

Displays IRS groundspeed.

11 Track (TK)

Displays airplane track angle relative to the true or magnetic reference selected on the HEADING REFERENCE switch.

12 Desired Track (DTK)

Displays desired track angle relative to the true or magnetic reference selected on the HEADING REFERENCE switch.

Intentionally
Blank

**Flight Management, Navigation
EICAS Messages****Chapter 11
Section 60****EICAS and CDU Messages**

The following EICAS messages can be displayed to alert the flight crew to navigation system faults and failures.

| Message | Level | Light | Aural | Condition |
|---|---------------------|-------------|--------|---|
| ATC FAULT | Advisory | ATC FAIL | | Selected transponder has failed. |
| L FMC FAIL R FMC FAIL | Advisory | FAIL | | FMC has failed. |
| FMC MESSAGE | Advisory | FMC | | A message is in the FMC scratchpad. |
| L GPS R GPS | Advisory | | | Indicated GPS has failed. |
| GPS | Advisory | | | GPS system has failed. |
| L IRS DC FAIL C IRS DC FAIL R IRS DC FAIL | Advisory | DC FAIL | | IRS DC backup power has failed and the IRS AC normal power is being used. |
| L IRS FAULT C IRS FAULT R IRS FAULT | Advisory | FAULT | | An IRS fault is detected. |
| L IRS ON DC C IRS ON DC R IRS ON DC | Advisory | ON DC | | Indicated IRS AC normal power has failed and the IRS DC backup power is being used. |
| UNABLE RNP | Caution Advisory | | Beeper | Navigation performance not meeting required accuracy. Message is a caution if fault occurs when the airplane is in "on approach" mode. Message is an advisory if fault occurs when the airplane is not in "on approach" mode. |

FMC Messages

FMC messages alert the flight crew to conditions that could degrade the system operation and advise the crew of input errors.

The messages are categorized as:

- alerting messages
- advisory messages

The scratchpad messages display according to their level of importance. A less important message replaces another message in the scratchpad when the CLEAR key is pushed or the condition is corrected.

The FMC light illuminates and the EICAS advisory message FMC MESSAGE displays when there is an FMC alerting message.

Scratchpad advisory messages appear in the scratchpad without an EICAS message or FMC light. All FMC messages illuminate the CDU message (MSG) light. Clear the message or correct the condition to cancel the message.

Keying data into the scratchpad that contains an FMC message temporarily removes the message from the scratchpad. The message reappears in the scratchpad when the data is line selected into a display or cleared from the scratchpad.

FMC Alerting Messages

FMC alerting messages:

- display in the CDU scratchpad
- illuminate the amber FMC light on the center instrument panel
- cause the EICAS advisory message FMC MESSAGE to display
- illuminate the CDU message light (MSG).

Use the CLEAR key or correct the condition responsible for the message to remove the message.

CHECK AIRLINE POLICY – after loading a new airline modifiable information file, the FMC determines a parameter is invalid. The FMC uses the default value. This is a maintenance function.

CHECK ALT TGT – VNAV active and the airplane is between the MCP and FMC altitudes. VNAV maintains level flight.

CYCLE IRS OFF – NAV – With the airplane on the ground any IRS has detected a condition that requires cycling inertial power off and back to NAV.

DESCENT PATH DELETED – VNAV active and all waypoint altitude constraints defining the descent profile deleted.

Note: This message displays before execution of the modification which deletes the descent path.

767 Flight Crew Operations Manual

DISCONTINUITY – LNAV active and the route is not defined after the waypoint (except when the waypoint is before a manually terminated leg, such as a VECTORS legs).

DRAG REQUIRED – VNAV active and additional drag required or autothrottle off and less thrust required to maintain the VNAV descent path.

END OF OFFSET – LNAV active and two minutes prior to end of active route offset. AFDS maintains last heading if active route offset overflow.

END OF ROUTE – LNAV active and end of active route overflow. AFDS maintains last heading.

ENTER IRS POSITION – the flight crew–entered present position did not pass one of the IRS comparison checks, or the IRS is ready to change to navigate mode and has not received a present position entry. Use the CLEAR key to remove this message.

FMC L (or R) OUTPUT LOSS – data output or discreet signals from indicated FMC are lost.

FUEL DISAGREE–PROG 2 – totalizer (TOTL) fuel quantity and FMC calculated (CALC) fuel quantity disagree by a significant amount.

INSUFFICIENT FUEL – estimated fuel at destination less than entered RESERVES value.

IRS MOTION – an IRS has detected motion while in ALIGN.

IRS NAV ONLY – the FMC has been without radio or GPS updating for a predetermined time.

IRS POS/ORIGIN DISAGREE – valid inertial position differs from active origin airport.

LIMIT ALT FLXXX – the flight crew– or FMC–selected altitude is greater than the VNAV limit altitude.

NAV DATA OUT OF DATE – the clock calendar date is after the active navigation database valid calendar cycle.

NAV INVALID–TUNE XXXX – RNAV or VOR approach procedures must have a specific navaid tuned. It is either not tuned or a valid signal is not being received.

NO ACTIVE ROUTE – LNAV selected and no active route activated.

PERF/VNAV UNAVAILABLE – VNAV selected and gross weight, cost index, or cruise altitude are not entered.

RESET MCP ALT – 2 minutes prior to the top of descent point with VNAV active and MCP not set to altitude below cruise altitude.

RW/ILS CRS ERROR – LOC mode armed and the selected ILS course is incorrect for the active route runway.

RW/ILS FREQ ERROR – the selected ILS frequency does not match frequency for runway in active route.

SINGLE FMC L (or R) OPERATION – one FMC has failed, only the indicated FMC is operational.

SPLIT IRS OPERATION – a fault exists on an IRS making only two IRSs available for navigation.

TAKEOFF SPEEDS DELETED – selected V speeds have been deleted due to changes in takeoff performance or configuration data.

THRUST REQUIRED – VNAV active, autothrottle disconnected, and additional thrust required to track VNAV descent path and maintain speed.

UNABLE NEXT ALT – VNAV active and climb not sufficient to comply with waypoint altitude constraint.

VERIFY POSITION – the difference between the FMC position and other position data exceeds a comparison threshold. The possible conflicts are:

- the left FMC position differs from the right FMC position
- the radio position, with radio updating, differs from the FMC position
- the GPS position, with GPS updating, differs from the FMC position

VERIFY RNP – POS REF 2 – the default RNP has changed due to a change in flight phase and the flight crew entered RNP value exceeds the new default RNP value.

VIA OFFSET INVALID – flight conditions invalidate the modification with a divert to an alternate airport via OFFSET.

FMC Advisory Messages

FMC advisory messages are displayed on the CDU scratchpad and illuminate the CDU message light (MSG). There are no EICAS messages associated with these messages and they do not cause the FMC light to illuminate.

Those messages which are caused by an entry error must be cleared before the entry can continue.

CRS REVERSAL AT FA FIX – a conflict exists between the default final approach (FA) waypoint (result of a runway or VFR approach selection) and the flight plan before it.

DELETE – DELETE key pushed.

ENG OUT SID MOD – an engine failure is sensed after takeoff before the flaps are fully retracted; the FMC has automatically loaded an available engine out standard instrument departure as a route modification to the active route.

767 Flight Crew Operations Manual

HOLD AT XXXX – a waypoint not contained in the active route is entered into the HOLD AT box on the RTE LEGS page, after selection of the HOLD function key. Selection of HOLD AT XXXX into a RTE LEGS page waypoint line makes a holding fix at the XXXX waypoint.

INVALID DELETE – deletion of selected data is not allowed.

INVALID ENTRY – entry format or range is incorrect for the selected field or the entered airway or TO waypoint does not coincide with the navigation database.

INVALID TUNE REQUEST – attempt to remotely tune a VOR is not valid.

KEY/FUNCTION INOP – selected mode key is inoperative.

MANUALLY TUNED – attempt to remotely tune a VOR that is manually tuned.

MAX ALT FLXXX – the altitude entry on any CDU page is above the performance calculated maximum altitude.

NOT IN DATABASE – data is not in the route or the navigation database.

NOT ON INTERCEPT HEADING – LNAV selected and the airplane is outside active capture criteria and the present heading will not intercept the active leg.

ROUTE FULL – the route is filled to the allowable capacity.

RUNWAY N/A FOR SID – selected runway not compatible with SID.

STANDBY ONE – the FMC requires more than 4 seconds to display data.

TIMEOUT-RESELECT – communication between the FMC and the CDU has failed. The flight crew must reselect FMC on the CDU MENU page.

UNABLE CRZ ALT – performance predicts a zero cruise time at the entered cruise altitude.

VERIFY RNP ENTRY – the entered RNP value is greater than the default RNP value for the present flight phase or, less than the present Actual Navigation Performance.

VOR AAA INVALID – signal is lost from remotely tuned VOR. AAA is the identifier for the VOR.

XXXXX – altitude set in the MCP window when VNAV is engaged, the CLB or CRZ page is displayed, and the altitude is above, within 4000 feet below, and not equal to the CRZ ALT.

CDU Annunciator Lights

These annunciator lights illuminate when certain conditions exist.

DSPY – a flight plan modification is pending and the RTE, RTE LEGS, RTE DATA, or RTE HOLD page not containing the active leg or route segment is displayed, or a VNAV page (CLB, CRZ, or DES) not corresponding to the active VNAV mode is displayed.

OFST – an offset path has been entered and executed.

MSG – an FMC message is waiting to display or is displayed.

FAIL – the associated FMC has failed.

Controls and Indicators 12.10

- Fuel System 12.10.1
- Fuel Indications 12.10.2
 - Fuel Quantity Indicator 12.10.2
- Fuel Jettison 12.10.3
- Fuel Quantity Test 12.10.4

System Description 12.20

- Introduction 12.20.1
- Fuel Quantity 12.20.1
- Fuel Temperature 12.20.1
- Fuel Pumps 12.20.1
- Fuel Crossfeed 12.20.2
- Suction Feed 12.20.2
- Fuel Configuration Light 12.20.3
- Fuel Imbalance 12.20.3
- Fuel Tank Locations and Capacities 12.20.3
 - Fuel Tank Locations 12.20.3
 - Fuel Tank Capacities 12.20.4
- Fuel System Schematic 12.20.5
- APU Fuel Feed 12.20.5
- Fuel Jettison 12.20.6
 - Fuel Jettison Schematic 12.20.7
- Fuel System FMS CDU Messages 12.20.7

EICAS Messages 12.30

- Fuel System EICAS Messages 12.30.1

Intentionally
Blank

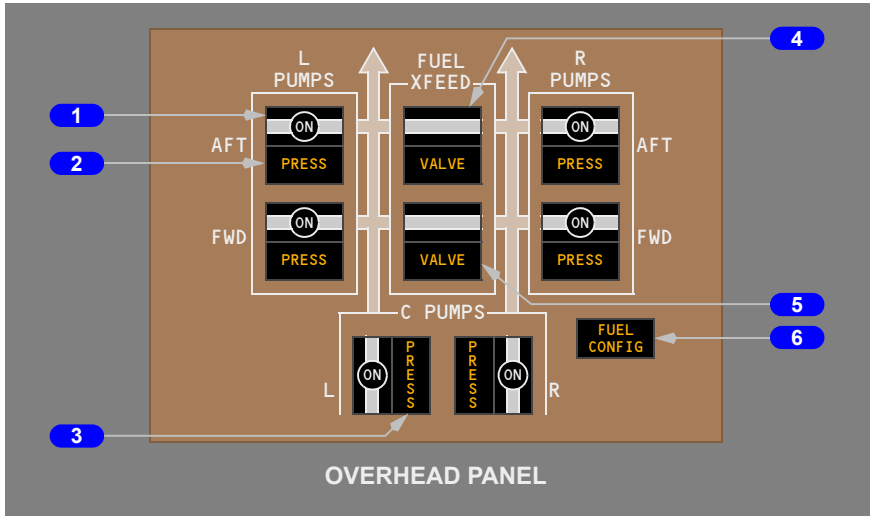
Fuel System**1 Left/Center/Right (L/C/R PUMPS) Switches**

ON – the fuel pump is selected ON

Off (ON not visible) – the fuel pump is selected off

2 Left/Right Pump Pressure (PRESS) Lights

Illuminated (amber) – fuel pump output pressure is low

3 Center Pump Pressure (PRESS) Lights

Illuminated (amber) –

- fuel pump output pressure is low with the pump selected ON
- associated N2 below 50% with pump switch ON

Note: Illumination is inhibited when the center tank fuel pump switch is selected OFF.

4 Fuel Crossfeed (FUEL XFEED) Switches

On (bar visible) – the crossfeed valve is selected open

Off (bar not visible) – the crossfeed valve is selected closed

5 Crossfeed VALVE Light

Illuminated (amber) – the crossfeed valve is not in the selected position

6 Fuel Configuration (FUEL CONFIG) Light

Illuminated (amber) –

- low fuel quantity
- imbalance between left and right main tanks
- center tank fuel pumps off with fuel in center tanks

Fuel Indications

Fuel Quantity Indicator

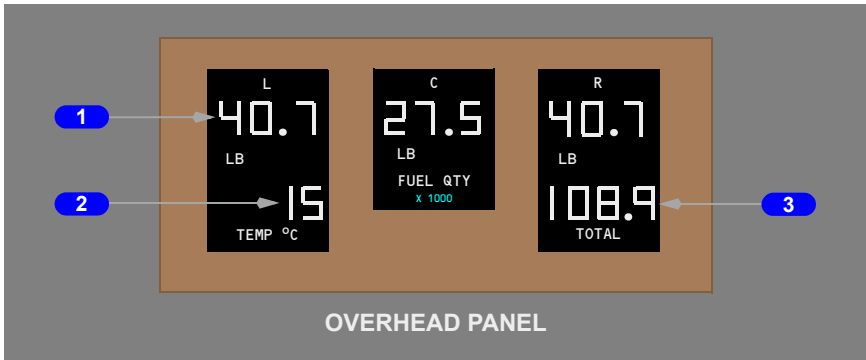

1 Fuel Quantity (L/C/R FUEL QTY) Indication

Displays usable fuel quantity in the left main, center, and right main tank (pounds x 1000)

2 Fuel Temperature (TEMP) Indication

Displays temperature of fuel in the left main tank (degrees celsius)

3 TOTAL Fuel Quantity Indication

Displays total usable fuel quantity in all tanks (pounds x 1000)

Fuel Jettison

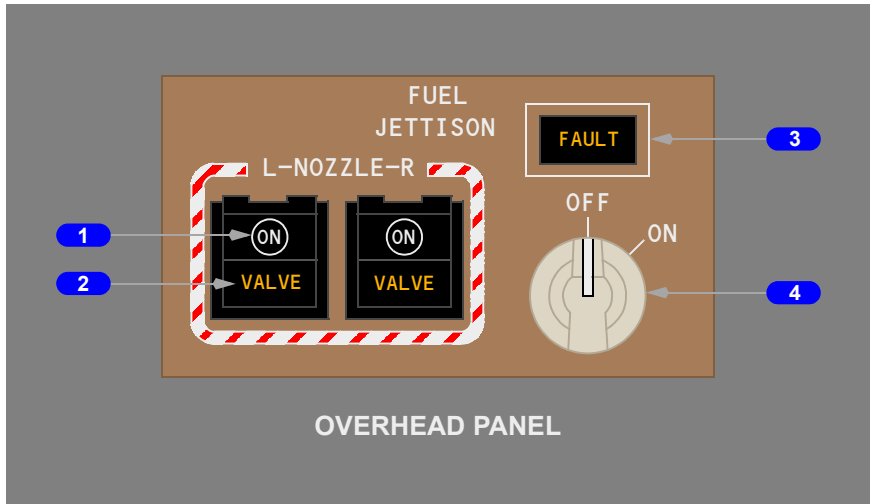

1 Fuel Jettison Nozzle Switches (L-NOZZLE-R)

ON – opens respective jettison nozzle

Off (ON not visible) – closes respective jettison nozzle

2 Fuel Jettison Nozzle VALVE Lights

Illuminated (amber) – the jettison nozzle valve is not in the selected position

3 FAULT Light

Illuminated (amber) – jettison pump(s) and/or transfer valve(s) disagree with jettison switch position

4 Fuel Jettison Selector

OFF – closes both jettison transfer valves and turns off jettison pumps

ON – opens both jettison transfer valves and turns on jettison pumps

Fuel Quantity Test

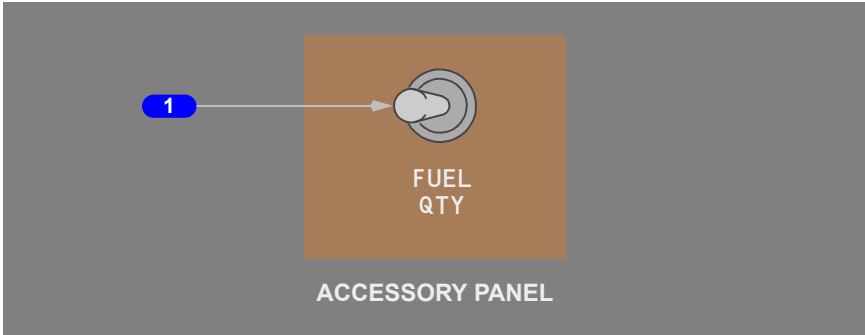

1 Fuel Quantity (FUEL QTY) Test Switch

Spring-loaded to center

Initiates fuel quantity test

Introduction

The fuel system supplies fuel to the engines and the APU. The fuel is contained in a center tank, and left and right main tanks.

Refer to Chapter 7, Engines, APU, for an additional description of the engine and APU fuel systems.

Fuel Quantity

Fuel quantity data, measured by probes in each tank, is fed to the fuel quantity processor where it is corrected for density then displayed on a fuel quantity indicator for each tank. Total fuel quantity, from a separate calculation, is shown on the total fuel quantity indicator and is also provided to the FMC.

When total usable fuel in either left or right main tank drops below approximately 2200 pounds, the FUEL CONFIG light illuminates and the LOW FUEL caution message is displayed.

Fuel Temperature

Temperature of the fuel in the left main tank is displayed on the fuel temperature indicator.

Fuel Pumps

Each fuel tank contains two AC-powered fuel pumps. A single pump can supply sufficient fuel to operate one engine under all conditions.

The two center tank fuel pumps have greater output pressure than the left and right main tank fuel pumps. When all six pumps are operating, the center tank pumps override the left and right main tank pumps so that center tank fuel is used before left or right main tank fuel.

If any pump has low output pressure, the appropriate switch PRESS light illuminates and the pump pressure EICAS message is displayed. If the main tank pump switches are OFF, the low pressure lights are illuminated and EICAS messages for the pumps are displayed. When the center pump switches are OFF, the low pressure lights and EICAS messages for the center pumps are inhibited.

To reduce electrical loads, the center tank pumps are inhibited when the associated N2 is less than 50% RPM. Thus both center tank pumps are inhibited when the engines are shutdown. As an engine is started and N2 RPM increases above 50%, the inhibit is removed for the associated center tank pump.

The EICAS caution messages, L or R FUEL SYS PRESS, displays when all fuel pumps have low output pressure or all fuel pumps on one side have low output pressure and the crossfeed switches are off.

The fuel pump low pressure messages are inhibited by the corresponding L or R FUEL SYS PRESS messages.

During normal operation, the EICAS advisory messages CTR L FUEL PUMP and CTR R FUEL PUMP display to indicate depletion of center tank fuel.

With either message displayed, a small amount of center tank fuel may be indicated. A scavenge system will operate automatically to transfer any remaining center tank fuel to the main tanks. Fuel scavenge begins when the main tanks are approximately half empty.

The left main tank contains a DC-powered fuel pump. It has no controls or indicators. The DC pump operates automatically to provide fuel to the APU when AC power is not available and the APU selector is ON.

Fuel Crossfeed

The fuel manifolds are arranged so that any fuel tank pump can supply either engine. Two crossfeed valves isolate the left fuel manifold from the right. These valves are normally closed providing fuel feed from tank to engine. Both valves are opened any time it becomes necessary to feed an engine from an opposite fuel tank. Only one open crossfeed valve is required for successful crossfeed operation. A valve disagreement light illuminates and the EICAS advisory message FWD FUEL X-FEED or AFT FUEL X-FEED displays if a valve position does not agree with its switch position. The L or R FUEL SYS PRESS messages are inhibited with either crossfeed valve open.

Suction Feed

When main tank fuel pump pressure is low, each engine can draw fuel from its corresponding main tank through a suction feed line that bypasses the pumps. As the airplane climbs, dissolved air is released from the fuel in the tank due to the decrease in air pressure. This air may collect in the suction feed line and restrict fuel flow. At high altitude, thrust deterioration or engine flameout may occur as a result of the fuel flow reduction.

Fuel pressure can be provided from a main tank with operating fuel pumps to both engines by opening the fuel crossfeed valves. Continued crossfeed use will result in a progressive fuel imbalance.

The dissolved air in the fuel tank will eventually deplete after reaching cruise altitude. The depletion time is dependent upon airplane altitude, fuel temperature, and type of fuel. Once the dissolved air is depleted, the engine may be capable of suction feed operation at cruise power.

Fuel Configuration Light

When the fuel quantity in left and right main tanks differ by 2000 pounds (plus or minus 500 pounds) or center fuel pump switches are OFF with more than 1200 pounds in the center tank, the FUEL CONFIG light illuminates and the EICAS advisory message FUEL CONFIG is displayed.

The FUEL CONFIG light also illuminates when the EICAS caution message LOW FUEL is displayed.

Fuel Imbalance

Fuel balancing is accomplished by opening the crossfeed valves and turning off the fuel pump switches for the left or right main fuel tank that has the lowest quantity. Fuel balancing may be done in any phase of flight.

Fuel Tank Locations and Capacities

Fuel Tank Locations

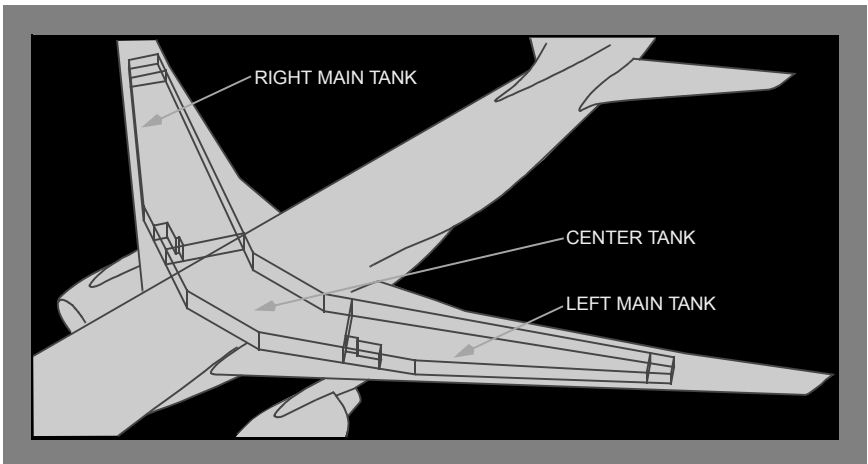

Fuel Tank Capacities

| Tank | U.S. Gallons | Pounds * |
|-------------|---------------------|-----------------|
| Left main | 6,010 | 40,267 |
| Right main | 6,010 | 40,267 |
| Center | 11,900 | 79,730 |
| Total | 23,920 | 160,264 |

* Usable fuel at level attitude, fuel density = 6.7 LB/U.S. per Gallon

| Tank | U.S. Gallons | Pounds * |
|-------------|---------------------|-----------------|
| Left main | 6,010 | 40,267 |
| Right main | 6,010 | 40,267 |
| Center | 11,960 | 80,132 |
| Total | 23,980 | 160,666 |

* Usable fuel at level attitude, fuel density = 6.7 LB/U.S. per Gallon

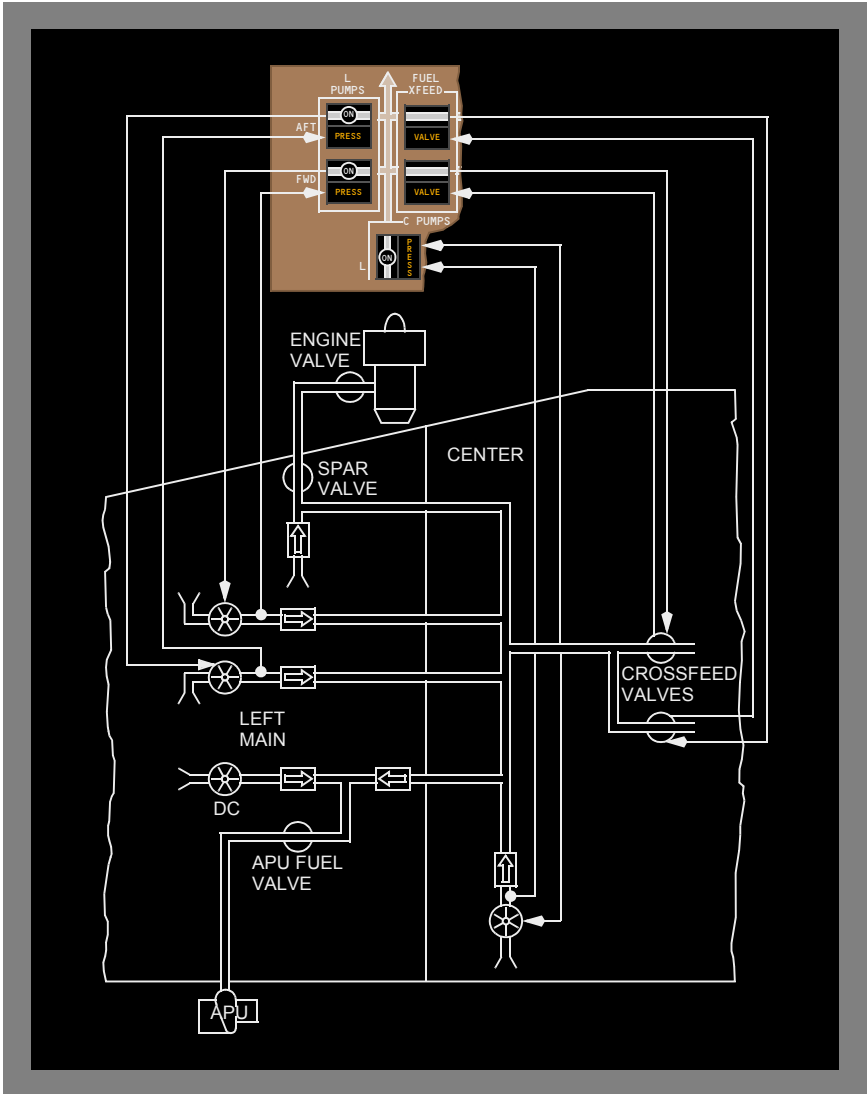
Fuel System Schematic**APU Fuel Feed**

APU fuel is supplied from the left fuel manifold. APU fuel can be provided by any AC fuel pump supplying fuel to the left fuel manifold or by the left main tank DC fuel pump.

On the ground, with the APU selector ON and no AC power available, the DC pump runs automatically. With AC power available, the left forward AC fuel pump operates automatically, regardless of fuel pump switch position, and the DC fuel pump turns off.

Fuel Jettison

The fuel jettison system allows jettison from the center fuel tank. Fuel is jettisoned through nozzles inboard of each outboard aileron. The common fuel manifold allows jettison pumps in the center tank to pump fuel overboard.

Two dual pump units provide a high capacity jettison rate of approximately 2600 pounds per minute.

Fuel jettison begins when:

- the FUEL JETTISON selector is selected ON
- the jettison transfer valves open
- the FUEL JETTISON NOZZLE switches are selected ON
- the nozzle valves open, and
- the jettison pumps operate

The FMC discontinues fuel value calculations and the totalizer value is used during fuel jettison operation. After fuel jettison is complete, the calculated value will reset using the same value as the totalizer value.

The fuel disagree message is not displayed during fuel jettison operation.

Fuel Jettison Schematic

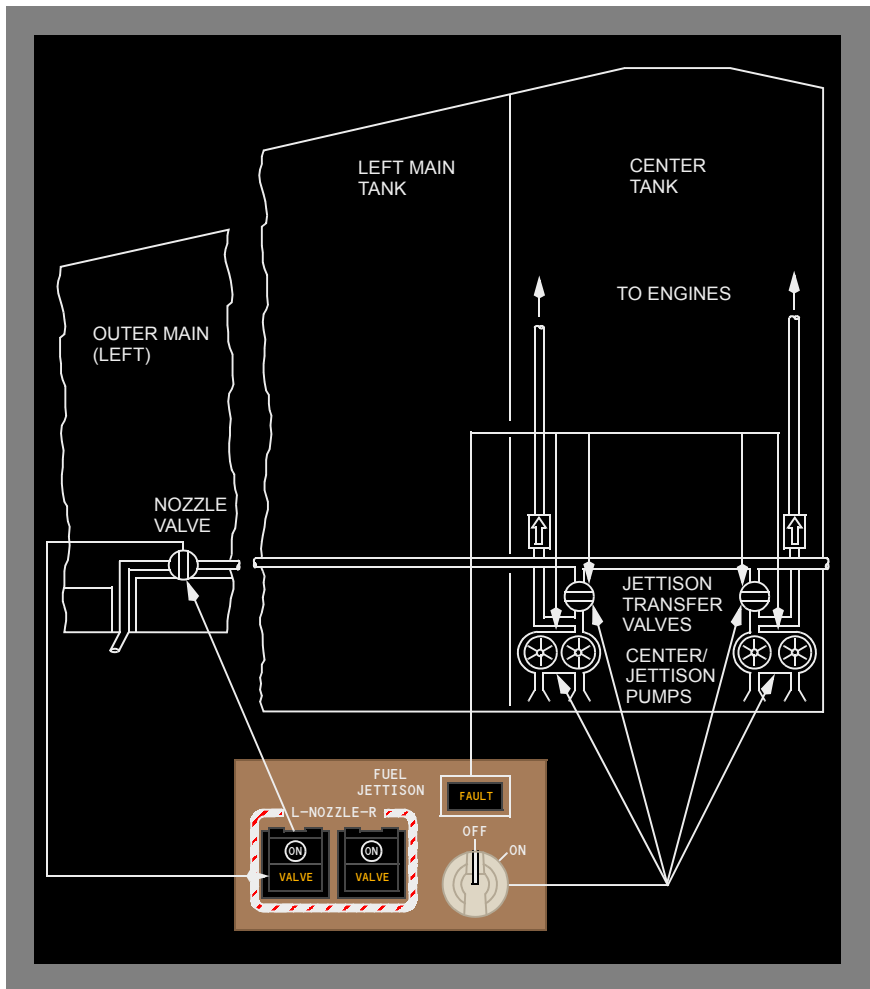

Fuel System FMS CDU Messages

The CDU can display the following messages.

INSUFFICIENT FUEL – Predicted fuel at destination is less than the FMC reserves

FUEL DISAGREE-PROG 2 – The fuel totalizer and calculated fuel quantity disagree

Intentionally
Blank

Fuel System EICAS Messages

The following EICAS messages can be displayed.

| Message | Level | Light | Aural | Condition |
|--|----------|-------------|-------|---|
| FUEL CONFIG | Advisory | FUEL CONFIG | | Both center pump switches are OFF with fuel in the center tank or a fuel imbalance between main tanks |
| AFT FUEL X-FEED FWD FUEL X-FEED | Advisory | VALVE | | The crossfeed valve position disagrees with the commanded position |
| FUEL JET NOZ | Advisory | VALVE | | In flight, the nozzle valve position disagrees with the commanded position On the ground indicates one or both fuel nozzle valves are open |
| L FUEL JET PUMP R FUEL JET PUMP | Advisory | FAULT | | The associated fuel jettison pump is inoperative |
| L JET XFER VALVE R JET XFER VALVE | Advisory | FAULT | | The associated fuel jettison transfer valve is not in the commanded position |
| CTR L FUEL PUMP CTR R FUEL PUMP L AFT FUEL PUMP R AFT FUEL PUMP L FWD FUEL PUMP R FWD FUEL PUMP | Advisory | PRESS | | Fuel pump output pressure is low |

| Message | Level | Light | Aural | Condition |
|--------------------------------------|---------|-------------|--------|---|
| L FUEL SYS PRESS R FUEL SYS PRESS | Caution | | Beeper | All fuel pumps have low output pressure or all fuel pumps on one side have low output pressure and the crossfeed switches are off |
| LOW FUEL | Caution | FUEL CONFIG | Beeper | Fuel quantity is low in either left or right main tank |

Hydraulics

Chapter 13

Table of Contents

Section 0

Controls and Indicators 13.10

- Hydraulic Panel 13.10.1
 - Status Display 13.10.2
- Miscellaneous Hydraulic System Controls 13.10.2
 - Reserve Brakes and Steering Reset/Disable Switch 13.10.2
 - Ram Air Turbine 13.10.3

System Description 13.20

- Introduction 13.20.1
 - Hydraulic Systems Schematic 13.20.2
- Left Hydraulic System 13.20.4
 - Fluid Supply 13.20.4
 - Engine-driven Primary Pump 13.20.4
 - Electric Motor-driven Demand Pump 13.20.4
 - System Pressure Indications 13.20.5
- Right Hydraulic System 13.20.5
 - Fluid Supply 13.20.5
 - Engine-driven Primary Pump 13.20.5
 - Electric Motor-driven Demand Pump 13.20.5
 - System Pressure Indications 13.20.5
- Center Hydraulic System 13.20.5
 - Fluid Supply 13.20.6
 - Electric Motor-driven Primary Pumps 13.20.6
 - Air-driven Demand Pump 13.20.6
 - System Pressure Indications 13.20.6
 - Reserve Brakes and Steering Isolation 13.20.6
 - Hydraulic Driven Generator 13.20.6
- Ram Air Turbine (RAT) Pump 13.20.7

EICAS Messages 13.30

- Hydraulics EICAS Messages 13.30.1

Intentionally
Blank

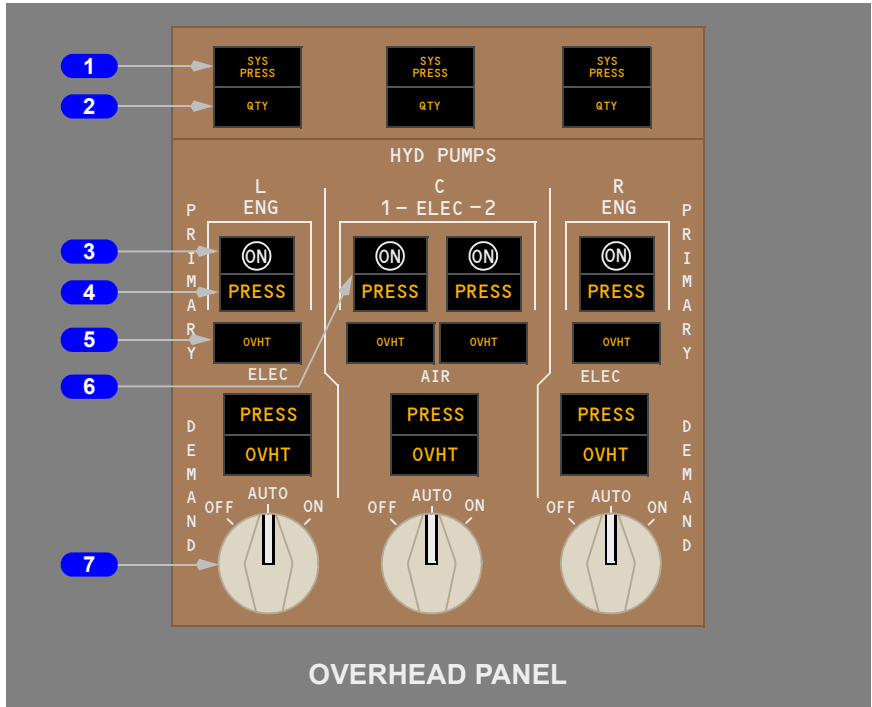
Hydraulic Panel**1 System Pressure (SYS PRESS) Lights**

Illuminated (amber) – system pressure is low.

2 Reservoir Low Quantity (QTY) Lights

Illuminated (amber) – reservoir quantity is low.

3 Left/Right Engine (L/R ENG) Primary Pump Switches

ON – the engine-driven hydraulic pump pressurizes when engine rotates.

Off (ON not visible) – the engine-driven hydraulic pump is turned off and depressurized.

4 Pump Pressure (PRESS) Lights

Illuminated (amber) – pump output pressure is low.

5 Pump Overheat (OVHT) Lights

Illuminated (amber) – pump temperature is high.

6 Center 1/2 Electric (C1/2 ELEC) Primary Pump Switches

ON – the electric motor–driven pump pressurizes the center hydraulic system.

OFF (ON not visible) – the electric motor–driven hydraulic pump is turned off.

7 Left/Right Electric and Center Air (L/R ELEC and C AIR) Demand Pump Selectors

ON – continuous operation.

AUTO –

- left/right electric pumps operate when engine pump pressure is low
- center air demand pump operates when both center electric pump pressures are low
- center air demand pump operates when heavy load items are selected

OFF – pump off.

Status Display

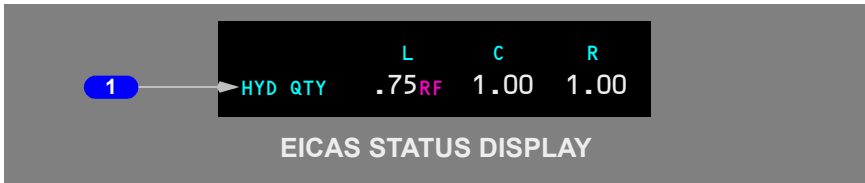

1 Hydraulic Fluid Quantities (HYD QTY)

- displays system reservoir quantity (1.00 is the normal service level)
- RF (magenta) – displayed when the reservoir requires refilling

Miscellaneous Hydraulic System Controls

Reserve Brakes and Steering Reset/Disable Switch

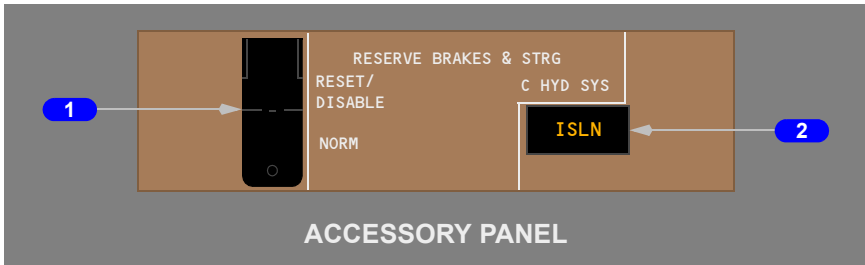

1 Reset/Disable Switch

RESET/DISABLE – resets or disables the automatic isolation feature of the center hydraulic system.

NORM – the isolation feature is armed for automatic operation.

2 Isolation (ISLN) Light

Illuminated (white) – the center number one electric primary hydraulic pump is isolated to provide hydraulic pressure to the reserve brakes and steering system.

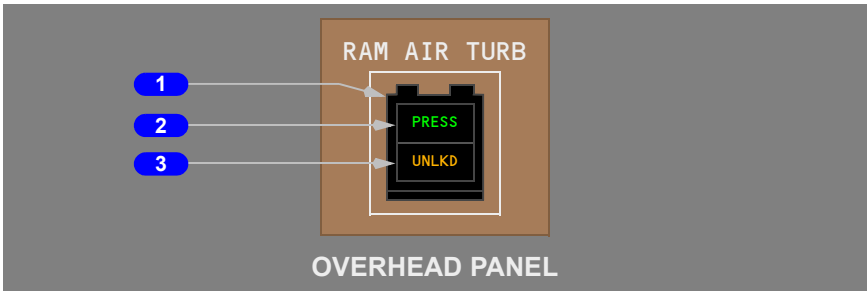
Ram Air Turbine**1 RAM AIR Turbine (TURB) Switch**

Push – deploys the RAT.

2 Ram Air Turbine Pressure (PRESS) Light

Illuminated (green) –

- the RAT is deployed
- the RAT is producing hydraulic pressure

3 Ram Air Turbine Unlocked (UNLKD) Light

Illuminated (amber) – the RAT is not stowed and locked.

Intentionally
Blank

Introduction

The airplane has three independent hydraulic systems: left, right, and center. The hydraulic systems power the:

- flight controls
- leading edge slats
- trailing edge flaps
- landing gear
- wheel brakes
- nose wheel steering
- autopilot servos
- thrust reversers
- tailskid

Flight control system components are distributed so that any one hydraulic system can provide adequate airplane controllability.

Hydraulic fluid is supplied to each hydraulic pump from the associated system reservoir. The reservoirs are pressurized by the bleed air system.

Hydraulic Systems Schematic

Hydraulic Schematic with Hydraulic Thrust Reversers

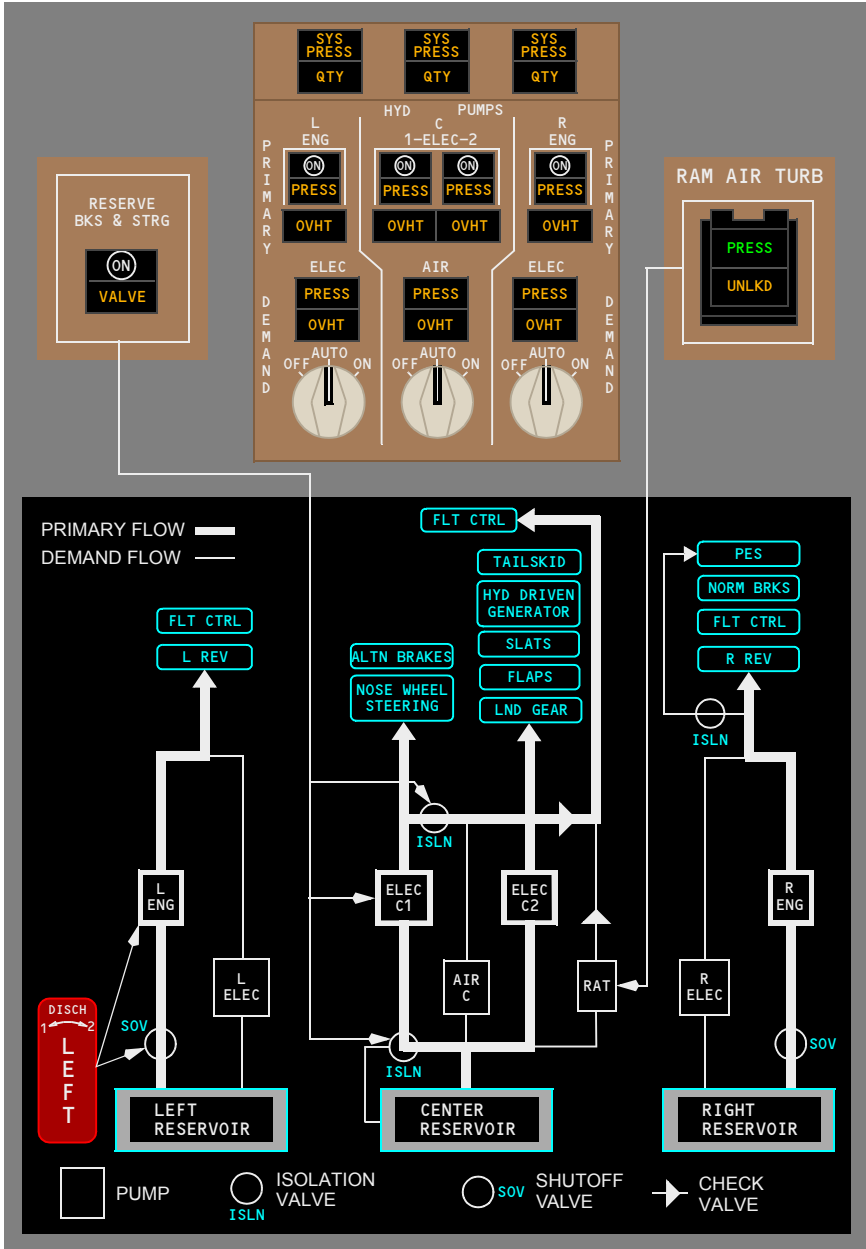

Hydraulic Schematic with Pneumatic Thrust Reversers

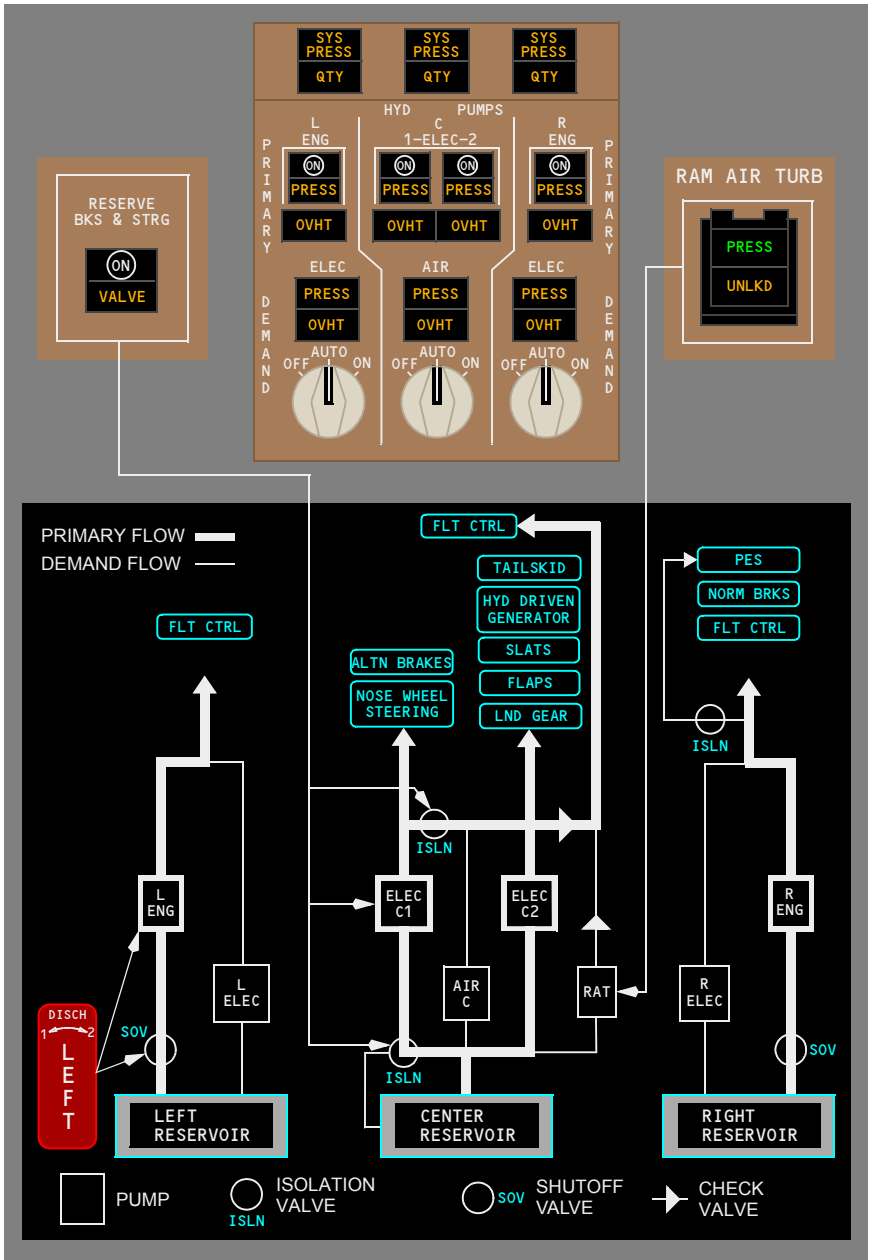

Left Hydraulic System

The left hydraulic system powers:

- flight controls
- left engine thrust reverser

The system consists of a reservoir, engine-driven primary pump, and an electric motor-driven demand pump.

Fluid Supply

Hydraulic fluid is supplied to each hydraulic pump from a reservoir. The reservoir is pressurized by the bleed air system. A quantity measuring system provides information to the EICAS status display. RF displays on the EICAS status page when a reservoir requires refilling prior to dispatch.

The QTY light illuminates and the EICAS advisory message L HYD QTY displays when the reservoir quantity is low.

Fluid for the engine-driven pump flows through a shutoff valve controlled by the engine fire switch. Pulling the fire switch shuts off the flow of fluid to the engine pump and depressurizes the pump.

Engine-driven Primary Pump

The primary hydraulic system pump is an engine-driven pump.

The primary pump PRESS light illuminates and the EICAS advisory message L HYD PRIM PUMP displays when the pump output pressure is low. The pump OVHT light illuminates and the EICAS advisory message L PRIM HYD OVHT displays when the pump temperature is high.

Electric Motor-driven Demand Pump

An electric motor-driven demand pump provides additional hydraulic power either on demand or continuously for periods of high system demand. The demand pump also provides a backup hydraulic power source for the engine-driven primary pump.

The pump PRESS light illuminates and the EICAS advisory message L HYD DEM PUMP displays when the pump output pressure is low. The pump OVHT light illuminates and the EICAS advisory message L DEM HYD OVHT displays when the pump temperature is high.

To reduce electrical load, the left electric demand pump is inhibited on the ground during engine start of either engine, when only one electrical generator is operating. The left demand pump PRESS and SYS PRESS lights may illuminate when starting engines on the ground.

System Pressure Indications

The SYS PRESS light illuminates and the EICAS caution message L HYD SYS PRESS displays when the hydraulic system pressure is low.

Right Hydraulic System

The right hydraulic system is similar to the left system. The right system powers:

- flight controls
- normal brakes
- pitch enhancement system
- right engine thrust reverser

The system consists of a reservoir, engine-driven primary pump, and an electric motor-driven demand pump.

Fluid Supply

The right reservoir is similar to the left system. The associated EICAS message for low reservoir quantity is R HYD QTY.

Engine-driven Primary Pump

The right engine-driven primary pump is identical to the left system. The associated EICAS messages for low pump output pressure or high pump temperature are R HYD PRIM PUMP and R PRIM HYD OVHT.

Electric Motor-driven Demand Pump

The right electric motor-driven demand pump is identical to the left system. The associated EICAS messages for low pump output pressure or high pump temperature are R HYD DEM PUMP and R DEM HYD OVHT.

System Pressure Indications

The right system pressure indications are similar to the left system. The associated message for low system pressure is R HYD SYS PRESS.

Center Hydraulic System

The center system powers:

- flight controls
- nose wheel steering
- flaps and slats
- alternate brakes
- landing gear
- hydraulic driven generator
- tailskid

The system consists of a reservoir, two electric motor-driven pumps, an air-driven demand pump, and a ram air turbine (RAT) pump.

Fluid Supply

The center reservoir is similar to the left system. The associated EICAS messages for low reservoir quantity is C HYD QTY.

The reservoir maintains reserve hydraulic fluid for use by the brakes and steering in the event of a center system hydraulic leak.

Electric Motor-driven Primary Pumps

The two center electric motor-driven primary pumps are identical to the left and right system electric motor-driven pumps. The C2 pump may be load shed automatically to reduce electrical loads. The associated EICAS messages for low pump output pressure or high pump temperature are C HYD PRIM 1, C HYD PRIM 2, C HYD 1 OVHT, and C HYD 2 OVHT.

Air-driven Demand Pump

An air-driven demand pump provides additional hydraulic power either on demand or continuously for periods of high system demand. The demand pump also provides a backup hydraulic power source for the electric motor-driven primary pumps.

The pump PRESS light illuminates and the EICAS advisory message C HYD DEM PUMP displays when the pump output pressure is low. The pump OVHT light illuminates and the EICAS advisory message C DEM HYD OVHT displays when the pump temperature is high.

System Pressure Indications

The center system pressure indications are similar to the left system. The associated message for low system pressure is C HYD SYS PRESS.

Reserve Brakes and Steering Isolation

The center number one electric primary hydraulic pump is automatically isolated, if system quantity is sensed low, to provide hydraulic pressure to the reserve brakes and steering system.

Hydraulic Driven Generator

A hydraulic driven generator is automatically powered by the center hydraulic system when electrical power is lost from both main AC busses. The center air demand pump will then operate continuously to ensure sufficient hydraulic pressure to drive the generator.

Ram Air Turbine (RAT) Pump

When deployed, the RAT, provides hydraulic power to the flight controls portion of the center hydraulic system. The RAT provides adequate hydraulic power at speeds above 130 knots. In flight, the RAT deploys automatically when both engines fail. The RAT is inhibited from auto deployment on the ground.

The RAT can be deployed manually by pushing the RAM AIR TURB switch. The UNLKD light illuminates and the EICAS advisory message RAT UNLOCKED displays when the RAT is not stowed and locked. Once the RAT is producing pressure the ram air turbine PRESS light illuminates. The SYS PRESS light remains illuminated if the RAT is the only source of center system pressure. Once deployed, the RAT cannot be stowed in flight.

Intentionally
Blank

Hydraulics EICAS Messages

The following EICAS messages can be displayed.

| Message | Level | Light | Aural | Condition |
|--|----------|-----------|--------|---|
| C DEM HYD OVHT L DEM HYD OVHT R DEM HYD OVHT C HYD 1 OVHT C HYD 2 OVHT L PRIM HYD OVHT R PRIM HYD OVHT | Advisory | OVHT | | Pump temperature is high. |
| C HYD DEM PUMP L HYD DEM PUMP R HYD DEM PUMP L HYD PRIM PUMP R HYD PRIM PUMP C HYD PRIM 1 C HYD PRIM 2 | Advisory | PRESS | | Pump output pressure is low. |
| C HYD QTY L HYD QTY R HYD QTY | Advisory | QTY | | Hydraulic quantity is low. |
| C HYD SYS PRESS L HYD SYS PRESS R HYD SYS PRESS | Caution | SYS PRESS | Beeper | Hydraulic system pressure is low. |
| RAT UNLOCKED | Advisory | UNLKD | | The ram air turbine is not stowed and locked. |

Intentionally
Blank

Controls and Indicators 14.10

Landing Gear Panel 14.10.1

 Gear Extension/Retraction 14.10.3

Nose Wheel Steering Tiller 14.10.4

Brake System 14.10.4

 Rudder/Brake Pedals 14.10.4

 Auto Brakes Selector 14.10.5

 Parking Brake Handle 14.10.5

 Brake Accumulator Pressure Indicator 14.10.6

 Brake Source Light 14.10.6

 Reserve Brakes and Steering Switch 14.10.6

Antiskid Light 14.10.7

Brake Temperature 14.10.7

System Description 14.20

Introduction 14.20.1

Air/Ground Sensing System 14.20.1

Landing Gear Operation 14.20.1

 Landing Gear Retraction 14.20.2

 Landing Gear Extension 14.20.2

 Landing Gear Alternate Extension 14.20.2

Nose Wheel Steering 14.20.3

Brake System 14.20.3

 Normal Brake Hydraulic System 14.20.3

 Alternate Brake Hydraulic System 14.20.3

 Reserve Brakes and Steering 14.20.3

 Brake Accumulator 14.20.4

 Antiskid Protection 14.20.4

 Autobrake System 14.20.4

 Parking Brake 14.20.5

 Brake Temperature Indication 14.20.6

Landing Gear Panel

[Option-Brake Temp light installed]

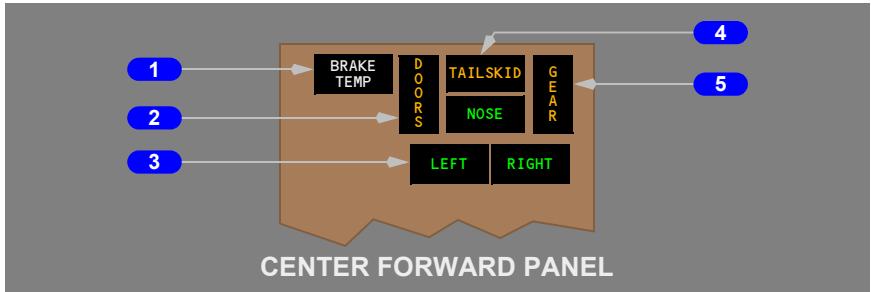
**1 Brake Temperature (BRAKE TEMP) Light**

Illuminated (white) – a wheel brake temperature is in high range (a value of 5 or above on the status page).

2 DOORS Light

Illuminated (amber) – a door is not closed.

3 Landing Gear Down Lights (NOSE, LEFT, and RIGHT)

Illuminated (green) – the associated landing gear is down and locked.

4 TAILSKID Light

Illuminated (amber) – the tailskid position disagrees with the landing gear lever position.

5 Landing GEAR Disagree Light

Illuminated (amber) – the gear position disagrees with the lever position.

[Option-Brake Temp light not installed]

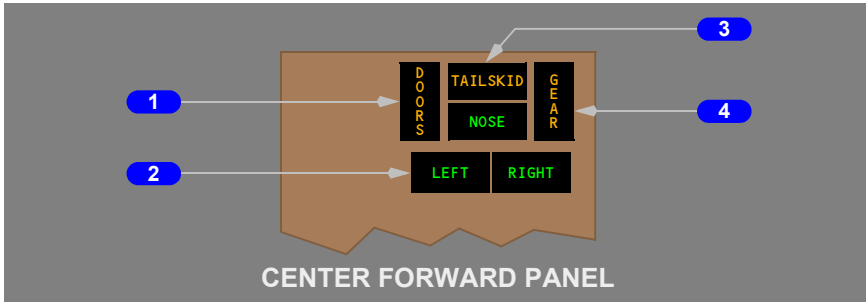

1 DOORS Light

Illuminated (amber) – a door is not closed.

2 Landing Gear Down Lights (NOSE, LEFT, and RIGHT)

Illuminated (green) – the associated landing gear is down and locked.

3 TAILSKID Light

Illuminated (amber) – the tailskid position disagrees with the landing gear lever position.

4 Landing GEAR Disagree Light

Illuminated (amber) – the gear position disagrees with the lever position.

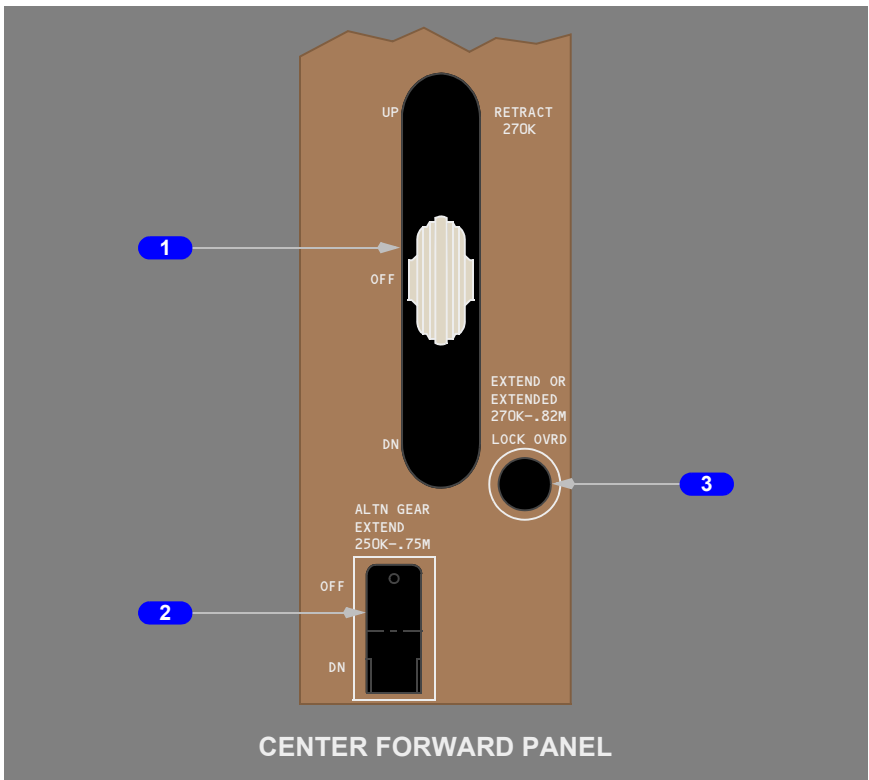
Gear Extension/Retraction**1 Landing Gear Lever**

UP – the landing gear retracts.

OFF – hydraulic pressure is removed from landing gear system.

DN – the landing gear extends.

2 Alternate Gear Extend (ALTN GEAR EXTEND) Switch

OFF – the landing gear lever operates normally.

DN (down) – the landing gear extends by the alternate extension system.

3 Landing Gear Lever Lock Override (LOCK OVRD) Switch

Push – releases the landing gear lever lock.

Nose Wheel Steering Tiller

A nose wheel steering tiller is installed on the left sidewall.

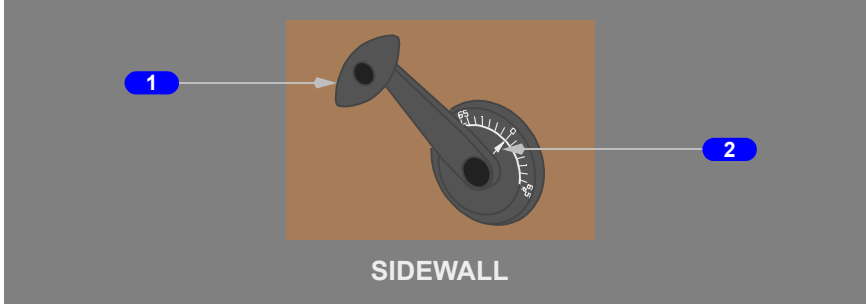

1 Nose Wheel Steering Tiller

Rotate –

- turns the nose wheels up to 65 degrees in either direction
- overrides rudder pedal steering

2 Tiller Position Indicator

Shows tiller displacement from the straight-ahead, neutral position.

Brake System

Rudder/Brake Pedals

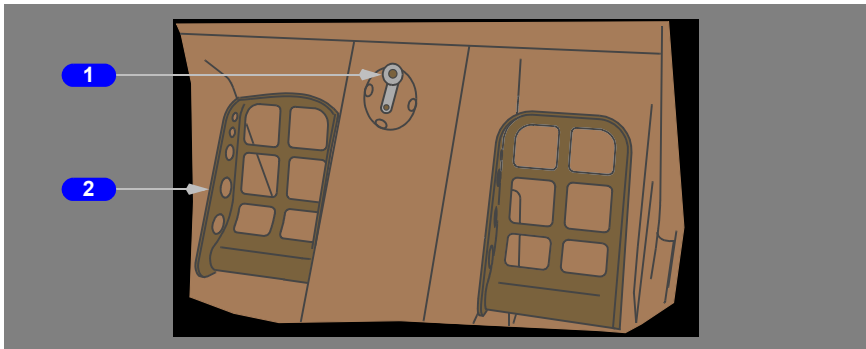

1 Rudder Pedal Adjust Crank

Pull and Rotate – adjusts the rudder pedals forward or aft.

2 Rudder/Brake Pedals

Push the full pedal –turns the nose wheel up to seven degrees in either direction.

767 Flight Crew Operations Manual

Push the top of the pedals – actuates the wheel brakes.

Refer to Chapter 9, Flight Controls for the description of rudder operation.

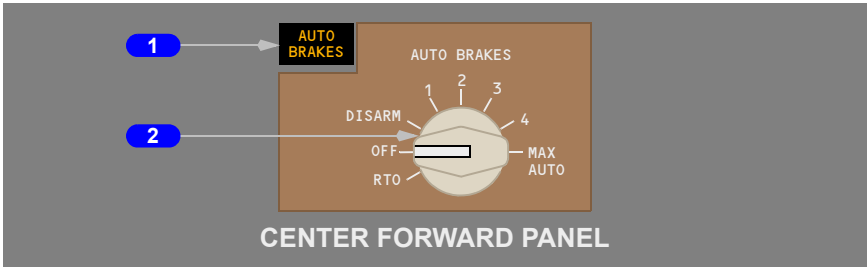
Auto Brakes Selector**1 AUTO BRAKES Light**

Illuminated (amber) – the auto brakes are disarmed or inoperative.

2 AUTO BRAKES Selector

OFF – deactivates the autobrake system.

DISARM –

- disengages the auto brake system
- releases brake pressure

1,2,3,4, MAX AUTO – selects the desired deceleration rate.

RTO – automatically applies maximum brake pressure when the thrust levers are retarded to idle above 85 knots.

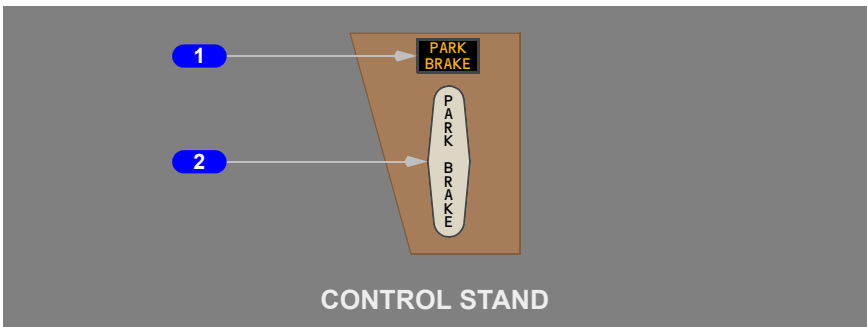
Parking Brake Handle**1 Parking Brake (PARK BRAKE) Light**

Illuminated (amber) – the parking brake is set.

2 Parking Brake (PARK BRAKE) Handle

Pull – sets the parking brake when both brake pedals are simultaneously depressed.

Release – simultaneously depress both brake pedals.

Brake Accumulator Pressure Indicator

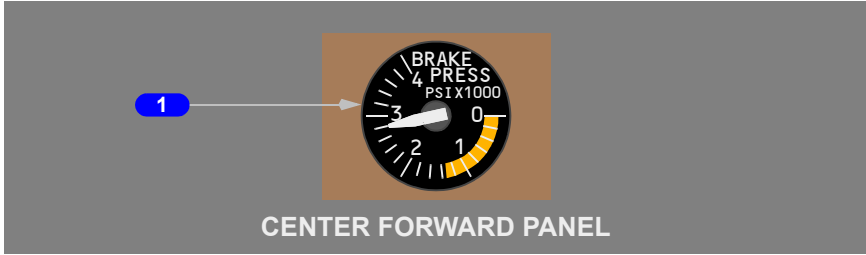

1 Brake Accumulator Pressure (BRAKE PRESS) Indicator

Indicates brake accumulator pressure (psi x1000).

Brake Source Light

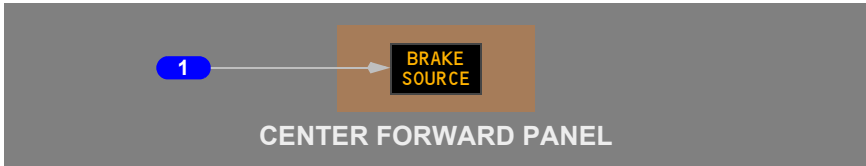

1 BRAKE SOURCE Light

Illuminated (amber) – both normal and alternate brake system pressures are low.

Reserve Brakes and Steering Switch

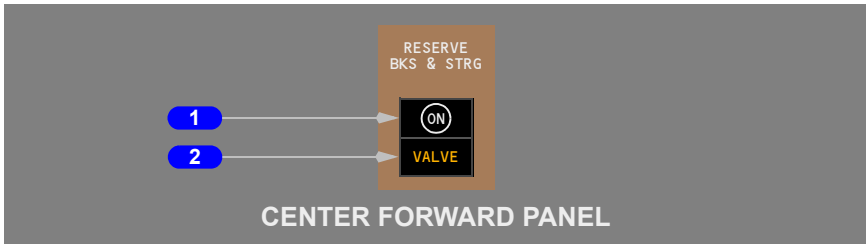

767 Flight Crew Operations Manual

1 RESERVE Brakes and Steering (BKS & STRG) Switch

ON – provides pressure to alternate brake system and nose wheel steering system.

Off – (ON not visible) – the reserve brakes and steering system is commanded off.

2 Reserve Brakes and Steering VALVE Light

Illuminated (amber) –

- switch OFF – valve(s) disagree with commanded position from automatic isolation feature
- switch ON – valve(s) disagree with manually selected switch position

Antiskid Light**1 ANTISKID Light**

Illuminated (amber) – a fault is detected in the antiskid system.

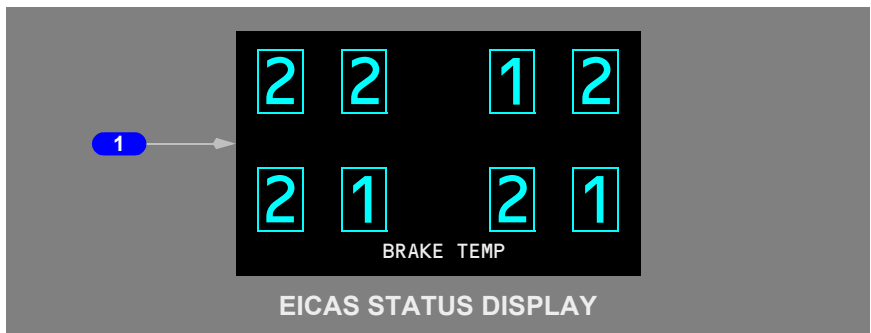
Brake Temperature**[Option-EICAS Status Display Brake Temp]****1 Brake Temperature (BRAKE TEMP)**

Indicates a relative value of wheel brake temperature.

- values range from 0 to 9
- 0 to 2 – initial range, box and number are cyan

- 3 to 4 – normal range, box is white for the first brake per truck that exceeds a value of 2 and number is cyan
- 5 to 9 – high range, box and number are white for each brake with a value of 5 or above

Introduction

The airplane has two main landing gear and a single nose gear. The nose gear is a conventional steerable two-wheel unit. Each main gear has four wheels in tandem pairs.

Hydraulic power for retraction, extension, and steering is supplied by the center hydraulic system. An alternate extension system is also provided.

The normal brake hydraulic system is powered by the right hydraulic system. The alternate brake hydraulic system is powered by the center hydraulic system. Antiskid protection is provided with both systems, but the autobrake system is available only through the normal system.

A brake temperature monitor system displays each brake temperature on the EICAS status display.

Air/Ground Sensing System

In-flight and ground operation of various airplane systems are controlled by the air/ground sensing system and the nose air/ground sensing system.

The air/ground sensing system receives air/ground logic signals from tilt sensors located on each main landing gear. These signals are used to configure the airplane systems to the appropriate air or ground status.

A nose air/ground sensing system receives air/ground logic signals from nose gear strut compression sensors. These signals are for controlling stall warning and portions of the caution and warning system.

An EICAS advisory message AIR/GND SYS or NOSE A/G SYS indicates that some portion of the sensing system failed. Affected equipment and systems will not operate normally and therefore takeoff is not allowed.

Landing Gear Operation

The landing gear are normally controlled by the landing gear lever. On the ground, the lever is prevented from moving to the UP position by an automatic lever lock controlled by the main gear tilt sensors. When the gear is not tilted (aircraft on the ground) the lock is engaged. The lever lock can be manually overridden by pushing and holding the landing gear lever LOCK OVRD switch. In flight, the lever lock is automatically released through air/ground sensing of main gear tilt sensor.

Landing Gear Retraction

After takeoff both main gear tilt, releasing the lever lock. When the landing gear lever is positioned to UP, the tilted landing gear begins to retract. The landing gear doors open and the gear retracts to up position. Automatic wheel braking occurs during gear retraction.

The GEAR and DOORS lights illuminate as the landing gear retracts into the wheel wells. After retraction, the nose gear is held up by uplocks and the main gear is held up by the door structure. The GEAR and DOORS lights extinguish. The landing gear lever is placed in the OFF position to depressurize the landing gear system. The GEAR light remains illuminated and the EICAS caution message GEAR DISAGREE displays if any gear is not up and locked up after the normal transit time. The affected gear's, gear down light, remains illuminated if the gear never unlocked from the down position. The DOORS light remains illuminated and the EICAS advisory message GEAR DOORS displays if any hydraulically actuated main gear door is not closed after normal transit time.

Landing Gear Extension

When the landing gear lever is moved to DN, the landing gear doors open, the gear are unlocked, and the GEAR and DOORS lights illuminate.

The gear are hydraulically powered to the down and locked position. The downlocks are powered to the locked position, all hydraulically actuated gear doors close, and the main gear trucks hydraulically tilt to the flight position. When all gear are down and locked, the gear down lights illuminate and the GEAR and DOORS lights extinguish.

The amber GEAR light remains illuminated and the EICAS caution messages GEAR DISAGREE, L or R SIDE BRACE, L or R DRAG BRACE displays if any gear is not locked down after the normal transit time. The extinguished green gear down light indicates the affected gear. The DOORS light remains illuminated and the EICAS advisory message GEAR DOORS displays if any hydraulically actuated door is not closed after the normal transit time.

Landing Gear Alternate Extension

The alternate landing gear extension system uses an electric motor to trip the locking mechanism for each gear. Selecting DN on the ALTN GEAR EXTEND switch releases all door and gear uplocks. The landing gear free-fall to the down and locked position.

When all gear are down and locked, the gear down lights illuminate and the GEAR light extinguishes. During alternate extension, the DOORS light remains illuminated and the EICAS advisory message GEAR DOORS displays because all the hydraulically powered gear doors remain open.

Nose Wheel Steering

Nose wheel steering is powered by the center hydraulic system. In the event of a center hydraulic system leak, a reserve brakes and steering system can power the nose wheel steering.

Primary steering control is provided by the nose wheel steering tiller. Limited steering control is available through the rudder pedals. The tiller can turn the nose wheel up to 65 degrees in either direction. A pointer on the tiller assembly shows tiller position relative to the neutral setting. The rudder pedals can be used to turn the nose wheels up to seven degrees in either direction. Tiller inputs override rudder pedal inputs.

Brake System

Each main gear wheel has a multiple disc brake. The nose wheels have no brakes. The brake system includes:

- normal brake hydraulic system
- alternate brake hydraulic system
- brake accumulator
- antiskid protection
- autobrake system
- parking brake

Normal Brake Hydraulic System

The normal brake hydraulic system is powered by the right hydraulic system. The brake pedals provide independent control of the left and right brakes.

Alternate Brake Hydraulic System

Alternate brake hydraulic system selection is automatic. If the right hydraulic system pressure is low, the center hydraulic system automatically supplies pressure to the alternate brake system. Pushing a brake pedal then sends hydraulic pressure through the alternate antiskid valves to the brakes.

The BRAKE SOURCE light illuminates and the EICAS advisory message BRAKE SOURCE displays if both normal and alternate brake system pressures are low.

Reserve Brakes and Steering

Pressing the RESERVE BKS & STRG switch provides hydraulic fluid to the center number one electric primary hydraulic pump. Pump pressure is then supplied exclusively to the alternate brake system and nose wheel steering system. The BRAKE SOURCE light and EICAS message extinguish when pressure is available.

The VALVE light illuminates and the EICAS advisory message RSV BRAKE VAL displays if a reserve brake valve disagrees with the commanded position.

Brake Accumulator

If normal and alternate brake hydraulic power is lost, the brake accumulator can provide several braking applications or parking brake application.

Antiskid Protection

Antiskid protection is provided in the normal and alternate brake hydraulic systems.

The normal brake hydraulic system provides each main gear wheel with individual antiskid protection. When a wheel speed sensor detects a skid, the associated antiskid valve reduces brake pressure until skidding stops.

The alternate brake hydraulic system provides antiskid protection to laterally paired wheels.

Touchdown, hydroplaning, and locked wheel protection are provided.

The ANTISKID light illuminates and the EICAS advisory message ANTISKID displays to indicate a fault is detected in the antiskid system.

The ANTISKID light illuminates and the EICAS advisory message ANTISKID OFF displays to indicate the antiskid system is inoperative.

Autobrake System

The autobrake system provides automatic braking at pre-selected deceleration rates for landing.

The system operates only when the normal brake system is functioning. Antiskid system protection is provided during autobrake operation.

The AUTO BRAKES light illuminates and the EICAS advisory message AUTOBRAKES displays if the autobrake system is disarmed or inoperative.

Rejected Takeoff

Selecting RTO prior to takeoff arms the autobrake system. The RTO mode can be selected only on the ground. The RTO autobrake setting commands maximum braking pressure if:

- the airplane is on the ground
- groundspeed is above 85 knots, and
- both thrust levers are retarded to idle

Maximum braking is obtained in this mode. If an RTO is initiated below 85 knots, the RTO autobrake function does not operate.

Landing

Five levels of deceleration can be selected for landing. However, on dry runways, the maximum autobrake deceleration rate in the landing mode is less than that produced by full pedal braking.

After landing, autobrake application begins when:

- both thrust levers are retarded to idle, and
- the wheels have spun up

Autobrake application occurs slightly after main gear touchdown. Deceleration is limited until main landing gear truck untilt occurs, then deceleration increases to the selected level. The deceleration level can be changed (without disarming the system) by rotating the selector.

To maintain the selected airplane deceleration rate, autobrake pressure is reduced as other controls, such as thrust reversers and spoilers, contribute to total deceleration. The system provides braking to a complete stop or until it is disarmed.

Autobrake – Disarm

The system disarms immediately, the AUTO BRAKES light illuminates, and the EICAS advisory message AUTOBRAKES displays if any of the following occur:

- pedal braking applied
- either thrust lever advanced after landing
- speedbrake lever is moved from the full up position after the speedbrakes have deployed on the ground
- DISARM or OFF position selected on the autobrakes selector
- autobrake fault
- normal antiskid system fault

When the autobrakes system disarms after landing:

- the autobrakes selector automatically moves to the DISARM position
- power is removed from the autobrake system
- the AUTO BRAKES light illuminates

When the autobrake system disarms during takeoff, the autobrakes selector remains in the RTO position. After takeoff, the autobrakes selector automatically moves to OFF.

Parking Brake

The parking brake can be set with the normal or alternate brake hydraulic system pressurized. If the normal and alternate brake systems are not pressurized, parking brake pressure is maintained by the brake accumulator. The brake accumulator is pressurized by the right hydraulic system. Accumulator pressure is shown on the BRAKE PRESS indicator.

The parking brake is set by fully depressing both brake pedals, pulling the parking brake handle up, then releasing the pedals. This mechanically latches the pedals in the depressed position and commands the parking brake valve to close.

The parking brake is released by depressing the pedals until the parking brake handle releases.

The PARK BRAKE light illuminates and the EICAS advisory message PARKING BRAKE displays when the parking brake is set.

Brake Temperature Indication

Wheel brake temperatures are displayed on the EICAS status page. Numerical values related to wheel brake temperature are displayed for each main gear brake. Brake temperature values range from 0 to 9. Temperature values are not instantaneous and tend to build for 10 to 15 minutes after the brakes are applied. Initial range values of 0 to 2 are cyan numbers in a cyan box. For normal range values of 3 and 4, the number is cyan and the box is white for the first brake per truck that exceeds a value of 2. Values in the high range of 5 to 9 have a white number and box. The BRAKE TEMP light illuminates for values of 5 and above.

Tailskid

The airplane is equipped with a tailskid system. The tailskid extends for takeoff and landing and retracts during flight. It helps to protect the pressurized part of the airplane from contact with the runway. The tailskid uses the main landing gear actuation system.

The TAILSKID light illuminates and the EICAS advisory message TAILSKID is displayed when the tailskid position disagrees with the landing gear lever position.

Landing Gear EICAS Messages

The following EICAS messages can be displayed.

Note: Refer to Chapter 15, Warning Systems, for configuration warning messages.

Brakes

| Message | Level | Light | Aural | Condition |
|---------------|----------|--------------|-------|--|
| ANTISKID | Advisory | ANTISKID | | A fault is detected in the antiskid system. |
| ANTISKID OFF | Advisory | ANTISKID | | Antiskid system is inoperative. |
| AUTOBRAKES | Advisory | AUTO BRAKES | | Auto brakes are disarmed or inoperative. |
| BRAKE SOURCE | Advisory | BRAKE SOURCE | | Normal and alternate brake system pressures are low. |
| PARKING BRAKE | Advisory | PARK BRAKE | | The parking brake is set. |
| RSV BRAKE VAL | Advisory | VALVE | | Valve(s) position disagrees with the commanded position. |

Landing Gear

| Message | Level | Light | Aural | Condition |
|------------------------------|----------|-------|--------|---|
| AIR/GND SYS | Advisory | | | Air/ground sensing system failed. |
| GEAR DISAGREE | Caution | GEAR | Beeper | Gear position disagrees with landing gear lever position. |
| GEAR DOORS | Advisory | DOORS | | One or more gear doors are not closed. |
| L DRAG BRACE R DRAG BRACE | Caution | GEAR | Beeper | The main gear drag brace is not locked down. |
| L SIDE BRACE R SIDE BRACE | Caution | GEAR | Beeper | The main gear side brace is not locked down. |

| Message | Level | Light | Aural | Condition |
|--------------|----------|-------|-------|--|
| NOSE A/G SYS | Advisory | | | Nose air/ground sensing system failed. |

Tailskid

| Message | Level | Light | Aural | Condition |
|----------|----------|----------|-------|---|
| TAILSKID | Advisory | TAILSKID | | Tailskid position disagrees with landing gear lever position. |

Warning Systems**Chapter 15****Table of Contents****Section 0**

| | |
|---|--------------|
| Controls and Indicators | 15.10 |
| Engine Indication and Crew Alerting System (EICAS) | 15.10.1 |
| Primary EICAS Display | 15.10.1 |
| Secondary EICAS Display | 15.10.3 |
| EICAS Message Display | 15.10.4 |
| EICAS Status Display | 15.10.7 |
| EICAS Control Panel | 15.10.9 |
| Caution Cancel/Recall Switches | 15.10.9 |
| Warning System Switches and Lights | 15.10.11 |
| Master Warning/Caution Reset Switches and Lights | 15.10.11 |
| Miscellaneous Lights | 15.10.11 |
| Ground Proximity Warning System (GPWS) | 15.10.13 |
| GPWS Controls | 15.10.13 |
| GPWS Immediate-Alert Annunciations | 15.10.14 |
| Enhanced GPWS | 15.10.15 |
| GPWS with Look-Ahead Display and Alerting | 15.10.15 |
| Windshear Warning System | 15.10.20 |
| Windshear Immediate-Alert Annunciations | 15.10.20 |
| Predictive Windshear (PWS) | 15.10.21 |
| Traffic Alert and Collision Avoidance System (TCAS) | 15.10.23 |
| TCAS Controls | 15.10.23 |
| TCAS Displays | 15.10.24 |
| TCAS Vertical Guidance | 15.10.27 |
| Miscellaneous Switches | 15.10.28 |
| Configuration (CONFIG) Test Switches | 15.10.28 |
| Stall Warning Test Switches | 15.10.29 |
| EICAS Test Switch | 15.10.29 |
| System Description | 15.20 |
| Introduction | 15.20.1 |

| | |
|--|----------|
| Engine Indication and Crew Alerting System (EICAS) | 15.20.1 |
| System Alert Messages | 15.20.1 |
| System Alert Level Definitions | 15.20.2 |
| Communication Alerts | 15.20.2 |
| Status Messages | 15.20.2 |
| Alert Message Displays | 15.20.3 |
| Master Warning/Caution Reset Switches and Lights | 15.20.3 |
| Flight Deck Panel Annunciator Lights | 15.20.4 |
| Aural Alerts | 15.20.4 |
| Alert Inhibits | 15.20.5 |
| Message Consolidation | 15.20.6 |
| Engine Start Message Inhibits | 15.20.6 |
| Takeoff Inhibits | 15.20.6 |
| Landing Inhibits | 15.20.7 |
| Engine Shutdown Inhibits | 15.20.8 |
| Alert Message Inhibits | 15.20.8 |
| Altitude Alerting Inhibits | 15.20.8 |
| Master Caution Lights and Beeper Inhibit | 15.20.9 |
| EICAS Event Record | 15.20.9 |
| EICAS Failure Indications | 15.20.9 |
| Warning System | 15.20.9 |
| Configuration Alerts | 15.20.10 |
| Airspeed Alerts | 15.20.11 |
| Altitude Alerts | 15.20.12 |
| Ground Proximity Warning System (GPWS) | 15.20.14 |
| Introduction | 15.20.14 |
| GPWS Alert Prioritization | 15.20.15 |
| GPWS Immediate-Alerts | 15.20.16 |
| GPWS Voice Callouts | 15.20.18 |
| GPWS Look-Ahead Alerts and Display | 15.20.18 |
| Windshear Warning System | 15.20.23 |
| Windshear Immediate-Alerts | 15.20.23 |
| Predictive Windshear (PWS) | 15.20.23 |

767 Flight Crew Operations Manual

| | |
|---|--------------|
| Traffic Alert and Collision Avoidance System (TCAS) | 15.20.27 |
| Normal Operations | 15.20.27 |
| Resolution Advisories (RA) and Displays | 15.20.27 |
| Traffic Advisories (TA) and Displays | 15.20.28 |
| Automatic TA and RA Display | 15.20.29 |
| Proximate Traffic and Other Traffic Displays | 15.20.29 |
| TCAS Voice Annunciations | 15.20.30 |
| Inhibits | 15.20.32 |
| Non-Normal Operations. | 15.20.32 |
| EICAS Messages. | 15.30 |
| Warning Systems EICAS Messages | 15.30.1 |
| GPWS | 15.30.1 |
| TCAS | 15.30.1 |
| Configuration | 15.30.1 |
| Miscellaneous | 15.30.2 |

Intentionally
Blank

Engine Indication and Crew Alerting System (EICAS)

Primary EICAS Display

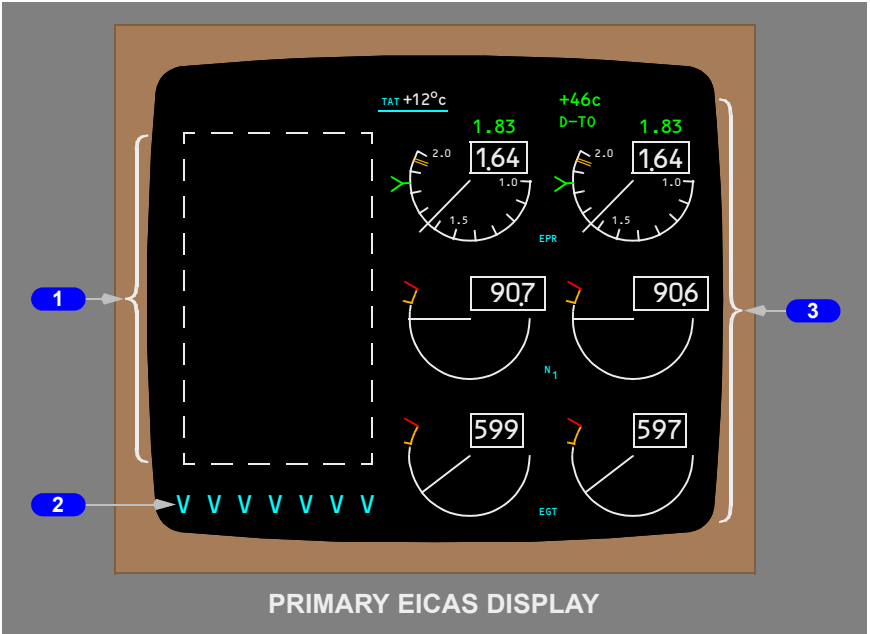

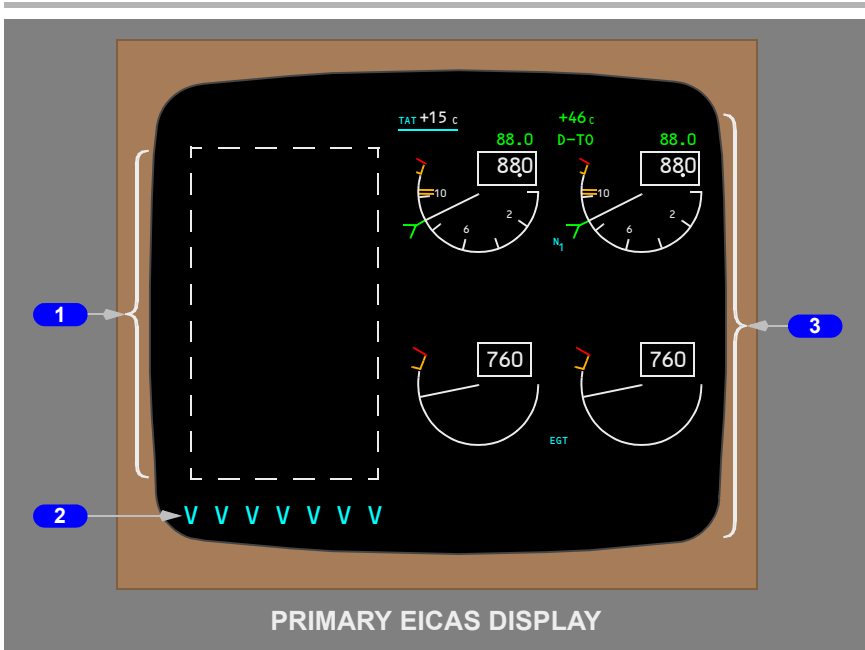

1 EICAS Message Field

Eleven lines are available for system and communications alerts. Additional pages are available.

2 Engine Secondary Data Cue

Displays (cyan) – secondary engine data should be displayed on lower CRT

3 Primary Engine Indications

Displays full time on the EICAS display.

Secondary EICAS Display

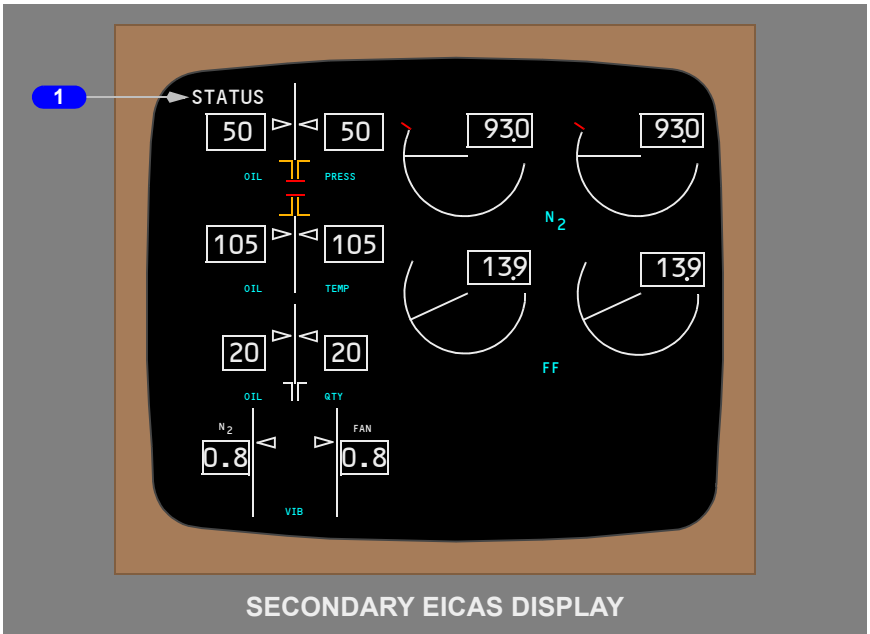
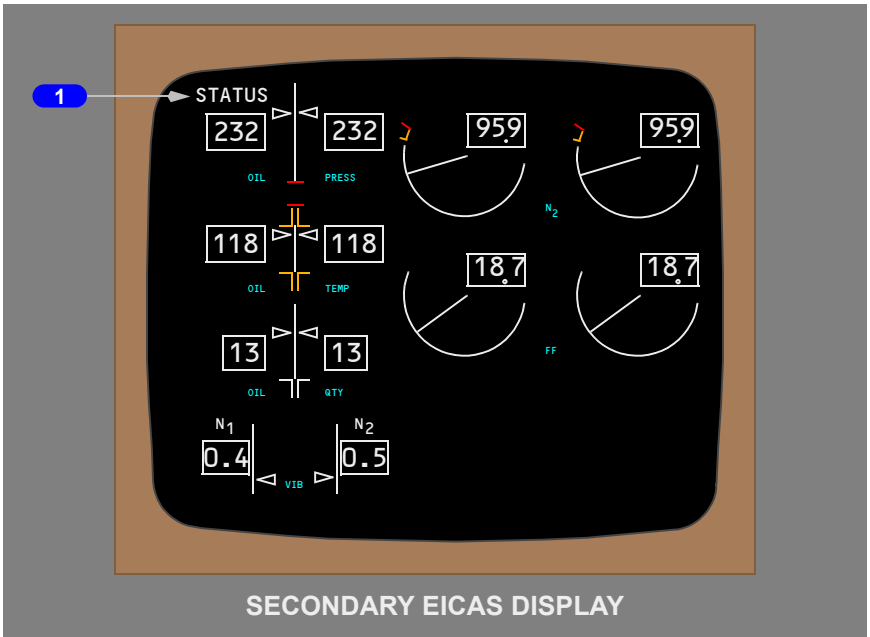

1 Status Cue

Displays when a new status message exists

Removed when the status page is displayed.

EICAS Message Display





PRIMARY EICAS DISPLAY

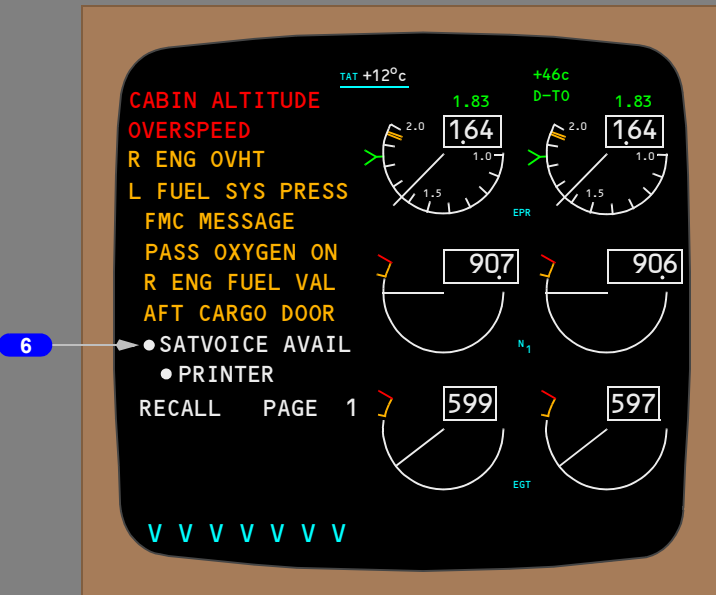

PRIMARY EICAS DISPLAY

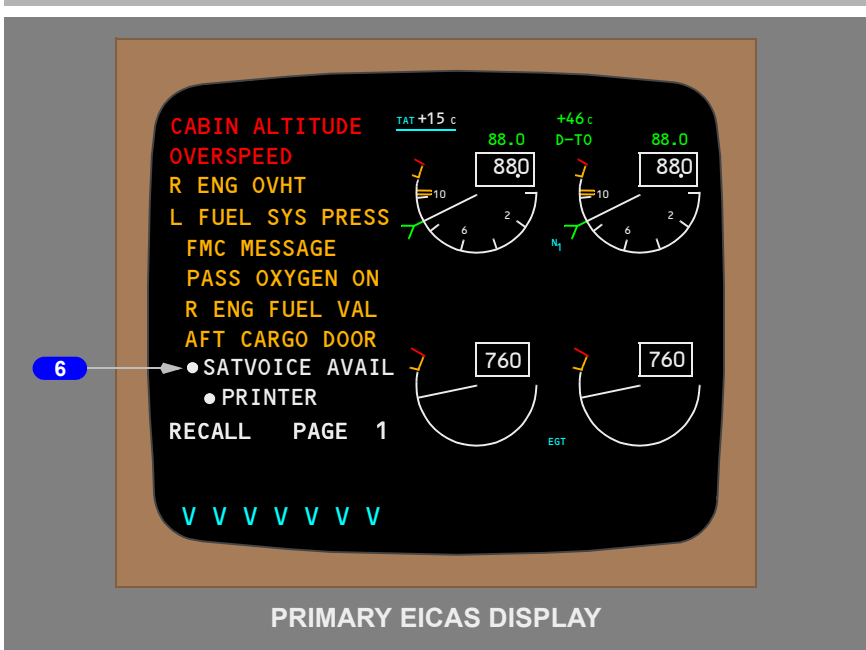

PRIMARY EICAS DISPLAY

1 Warning Messages

Displays (red) – the highest priority alert messages

2 Caution Messages

Displays (amber) – the next highest priority alert messages after warning messages

3 Advisory Messages

Displays (amber) –

- the lowest priority alert messages
- indented one space

4 Recall Indication

Displays when the RECALL switch is pushed

Remains displayed for one second after the switch is released

5 Page Number

Displays (white) –

- more than one page of alert or communication messages exists
- indicates the number of the page selected

6 Communication Messages

Displays (white) –

- indicates incoming communication messages
- preceded by a white dot
- COMM LOW messages are indented one space

EICAS Status Display

[Option -- EICAS Status Display with Brake Temperature]

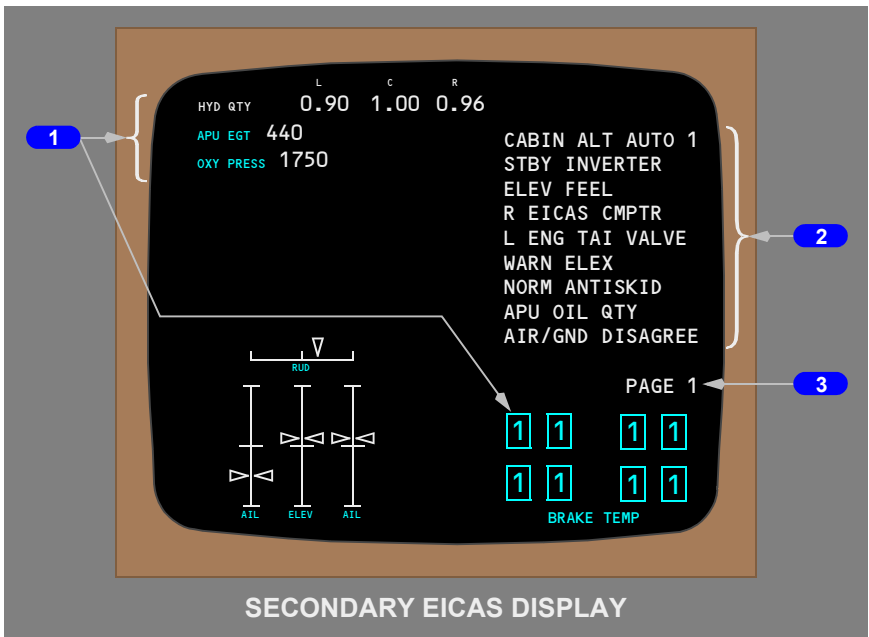

[Basic -- EICAS Status Display]

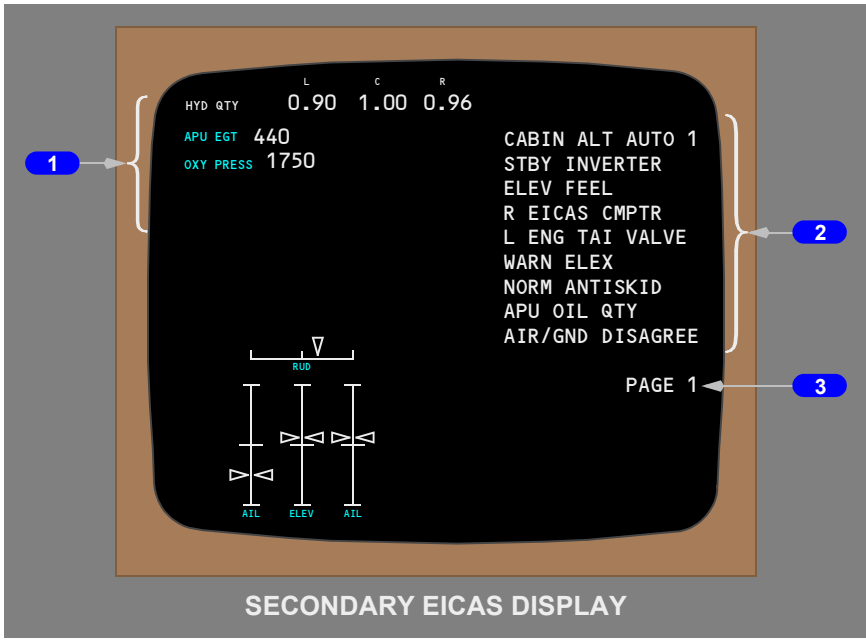

1 System Indications

System indications are displayed.

2 Status Messages

Status messages indicate conditions requiring minimum equipment list (MEL) reference for dispatch.

3 Page Number

A page number appears if additional pages of status messages exist.

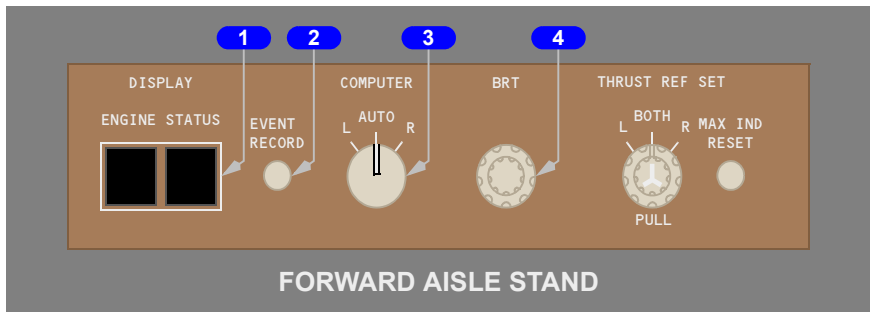
EICAS Control Panel**1 STATUS Display Switch**

Push – displays the status display on the lower EICAS CRT.

Subsequent pushes –

- displays the next page of status messages when additional pages exist
- the status display blanks after the last page of status messages is displayed.

2 EVENT RECORD Switch

Push – records the last EICAS event into memory.

3 COMPUTER Selector

L – left EICAS computer controls displays.

AUTO – EICAS display control automatically transfers to the right EICAS computer if the left computer fails.

R – right EICAS computer controls displays.

4 Brightness (BRT) Control

Rotate –

- Outer control – adjusts brightness of lower display
- Inner control – adjusts brightness of upper display

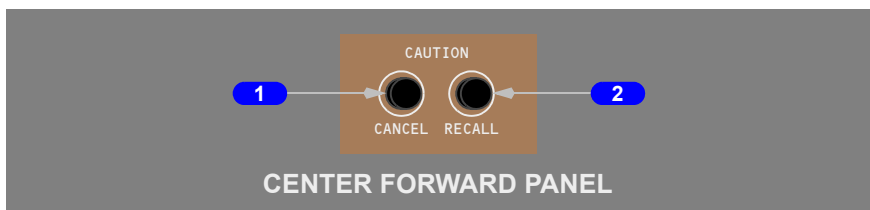
Caution Cancel/Recall Switches

1 CANCEL Switch

Push –

- displays the next page of EICAS messages when additional pages exist
- cancels caution and advisory messages when the last page is displayed

Note: Warning messages remain

Note: Communication messages remain

2 RECALL Switch

Push –

- displays the previously cancelled EICAS messages, if the associated condition(s) still exist
- displays the first page of messages when multiple pages exist.

Warning System Switches and Lights

Master Warning/Caution Reset Switches and Lights

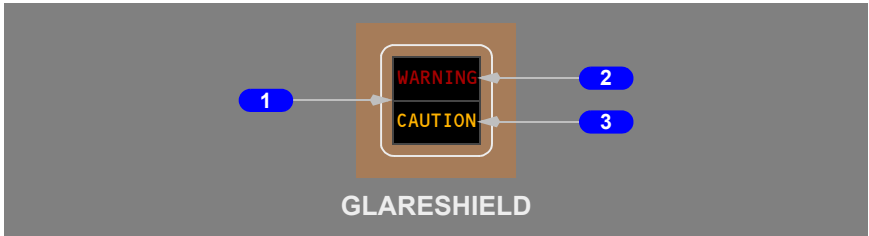

1 Master WARNING/CAUTION Reset Switch

Push –

- extinguishes the master WARNING lights
- extinguishes the Master CAUTION lights
- silences most associated aural alerts (for exceptions, see Section 20, Master Warning/Caution Reset Switches and Lights)

2 Master WARNING Light

Illuminated (red) – a time critical warning or warning condition exists

3 Master CAUTION Light

Illuminated (amber) – a caution condition exists

Miscellaneous Lights

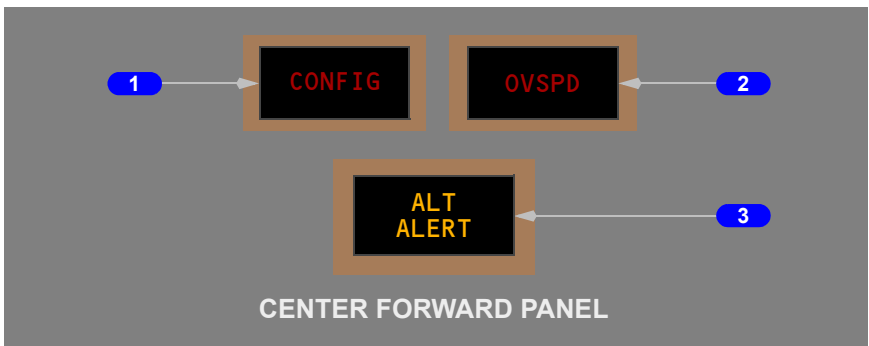

1 Configuration (CONFIG) Light

Illuminated (red) – a configuration warning exists

2 Overspeed (OVSPD) Light

Illuminated (red) – airplane is exceeding Mmo or Vmo

3 Altitude Alert (ALT ALERT) Light

Illuminated (amber) –

- between 300 and 900 foot deviation from selected altitude

Ground Proximity Warning System (GPWS)

GPWS Controls

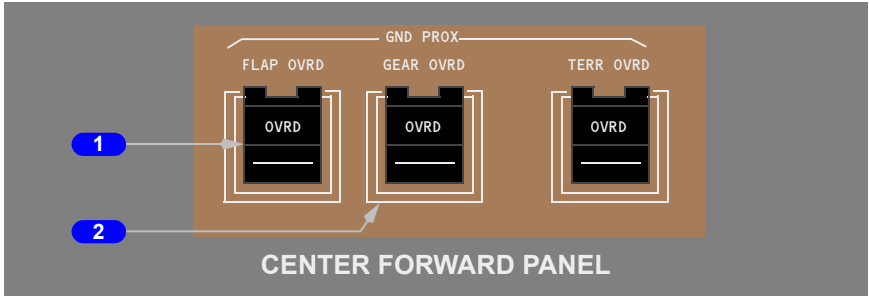

1 Ground Proximity Flap Override (GND PROX FLAP OVRD) Switch Push (OVRD visible) –

- inhibits the ground proximity TOO LOW FLAPS caution
- inhibits the ground proximity TOO LOW TERRAIN caution

Note: The EICAS advisory message GND PROX SYS is displayed when FLAP OVRD is selected for more than 60 seconds while airspeed is greater than 250 knots.

2 Ground Proximity Configuration Gear Override (GND PROX/CONFIG GEAR OVRD) Switch

Push (OVRD visible) –

- inhibits the ground proximity TOO LOW GEAR caution
- inhibits the ground proximity TOO LOW TERRAIN caution
- inhibits the landing configuration warning siren

Note: The EICAS advisory message GND PROX SYS is displayed when GEAR OVRD is selected for more than 60 seconds while airspeed is greater than 290 knots.

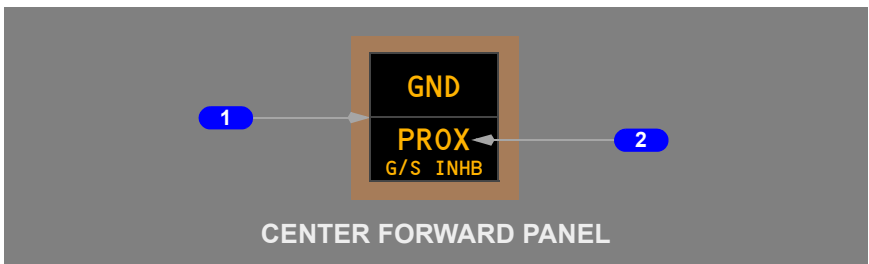

1 Ground Proximity Glide Slope Inhibit (GND PROX G/S INHB) Switch

Push (momentary) –

- inhibits the ground proximity GLIDE SLOPE caution when below 1,000 feet radio altitude

2 Ground Proximity (GND PROX) Light

Illuminated (amber) –

- a ground proximity caution exists
- an enhanced GPWS look-ahead caution exists

GPWS Immediate-Alert Annunciations

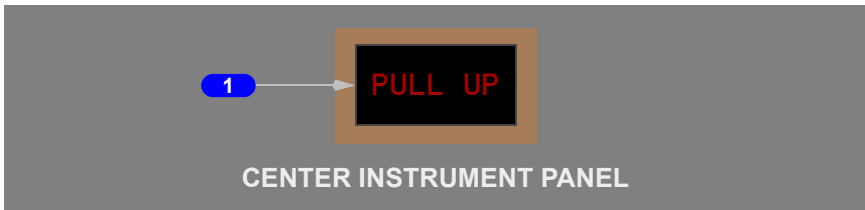

1 PULL UP Light

PULL UP (red) –

- the airplane descent rate is severe
- the airplane closure rate is excessive with the landing gear and/or flaps not in the landing configuration
- an enhanced GPWS look-ahead warning exists

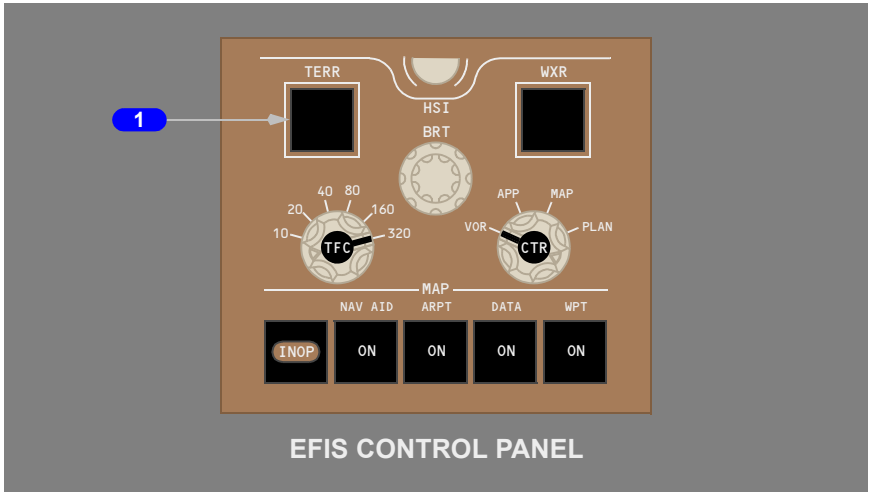
Enhanced GPWS**GPWS with Look-Ahead Display and Alerting****Look-Ahead Display Switches****1 Terrain (TERR) Display Select Switch**

Push –

- displays GPWS look-ahead data in VOR, APP, MAP, and CTR MAP modes
- arms GPWS look-ahead data in CTR VOR, CTR APP, and PLAN modes
- deselects the weather radar display regardless of the HSI mode selector position
- second push deselects GPWS look-ahead display

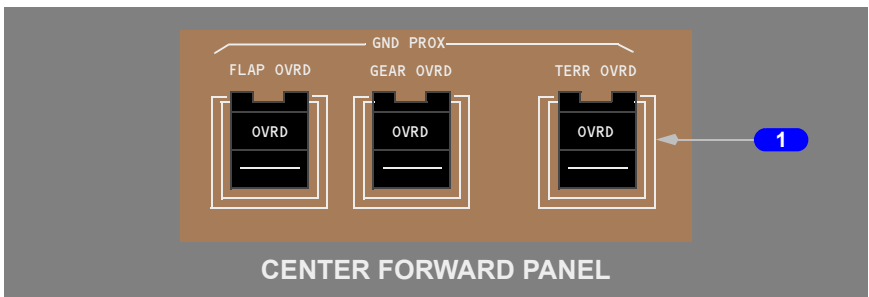
Look-Ahead Inhibit Switches

1 Terrain System Override Switch

Push – (OVRD visible)

- inhibits GPWS look-ahead alerts and displays
- second push deselects inhibit

Obstacles and Terrain Display

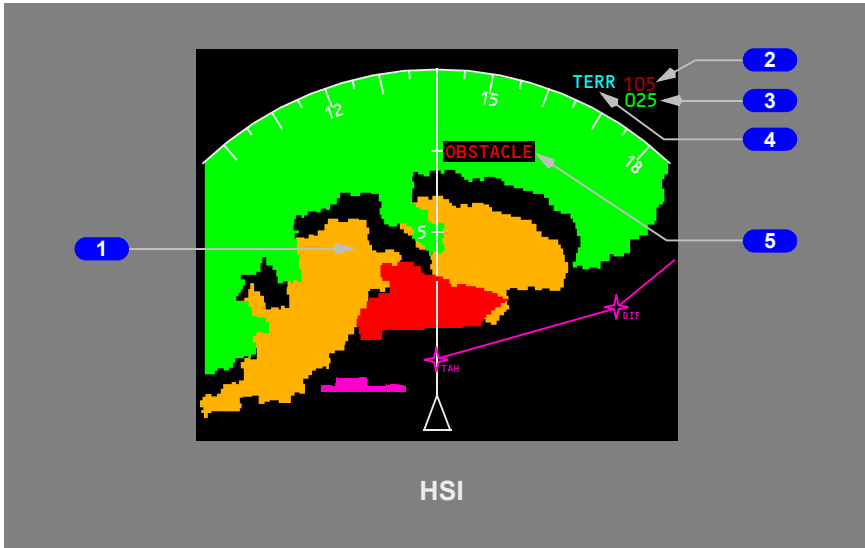

1 Obstacle and Terrain Display

When the airplane is higher than 2,000 feet above the terrain, display color density depends on obstacle or terrain height:

- solid green – highest obstacles or terrain displayed
- high density green – intermediate height obstacles or terrain displayed
- low density green – lowest obstacles or terrain displayed

When the airplane is at or lower than 2,000 feet above the terrain, color and density depends on obstacle height, terrain height, and airplane altitude:

- dotted green – obstacles or terrain from 2,000 feet below to 500 feet (250 feet with gear down) below airplane altitude
- dotted amber – obstacles or terrain 500 feet (250 feet with gear down) below to 2,000 feet above airplane altitude
- dotted red – obstacles or terrain more than 2,000 feet above airplane altitude
- dotted magenta – no terrain data available

- solid amber – look-ahead obstacle or terrain caution is occurring
- solid red – look-ahead obstacle or terrain warning is occurring

Note: In areas without obstacle or terrain data, look-ahead obstacle or terrain alerting and display functions are not available. GPWS immediate-alert modes function normally.

Obstacles or terrain are displayed automatically when:

- a look-ahead obstacle or terrain alert occurs; and
- Terrain (TERR) Display Select Switch is not selected by either pilot; and
- HSI Mode Selector in the VOR, APP, MAP, or CTR MAP mode

The look-ahead display updates with a sweep similar to the weather radar display.

2 Highest Elevation of Obstacle or Terrain Displayed

Highest elevation within selected map range expressed in hundreds of feet above sea level. Color (amber, green, or red) same as color of corresponding obstacle or terrain displayed.

3 Lowest Elevation of Obstacle or Terrain Displayed

Lowest elevation within selected map range expressed in hundreds of feet above sea level. Color (amber, green, or red) same as color of corresponding obstacle or terrain displayed. Blank above level terrain or if all terrain is within 400 feet of nearest airport elevation.

4 Terrain Mode Annunciation

TERR (cyan) – GPWS look-ahead display enabled

5 TERRAIN/OBSTACLE Annunciations

TERRAIN (red):

- terrain warning is occurring
- 20-30 seconds from projected impact with terrain

OBSTACLE (red):

- obstacle warning is occurring
- 20-30 seconds from projected impact with an obstacle

TERRAIN (amber):

- terrain caution is occurring
- 40-60 seconds from projected impact with terrain

OBSTACLE (amber):

- obstacle caution is occurring
- 40-60 seconds from projected impact with an obstacle

Displays in all HSI navigation modes.

Note: If an obstacle alert occurs while a TERRAIN alert message is displayed, the OBSTACLE alert message replaces the TERRAIN alert message. Both messages can not be displayed at the same time.

Look-Ahead HSI Systems Annunciations

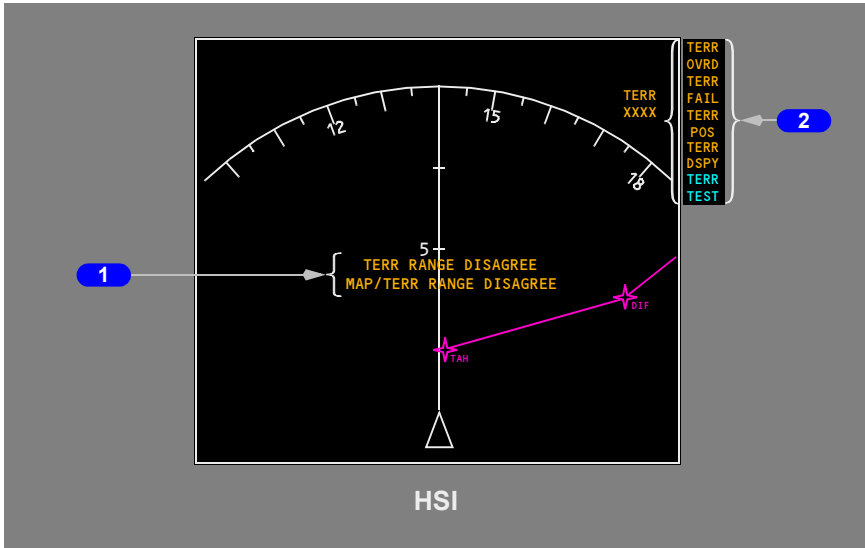

1 Terrain Range Disagree Annunciation

TERR RANGE DISAGREE (amber) –

- GPWS look-ahead display enabled
- GPWS look-ahead display output range disagrees with the HSI Range Selector

MAP/TERR RANGE DISAGREE (amber) –

- GPWS look-ahead display enabled
- GPWS look-ahead display output range disagrees with the HSI Range Selector
- map display output range disagrees with the HSI Range Selector

2 GPWS Status/Mode Annunciation

TERR OVRD (amber) – GND PROX TERR OVRD switch pushed

TERR FAIL (amber) – GPWS look-ahead alerting and display have failed

TERR POS (amber) – GPWS look-ahead alerting and display unavailable due to FMS position uncertainty

767 Flight Crew Operations Manual

TERR DSPY (amber) - HSI overheat or loss of distribution unit cooling.

TERR TEST (cyan) – GPWS operating in self-test mode

Windshear Warning System

Windshear Immediate-Alert Annunciations



1 WINDSHEAR Light

WINDSHEAR (red) – encountering a windshear condition

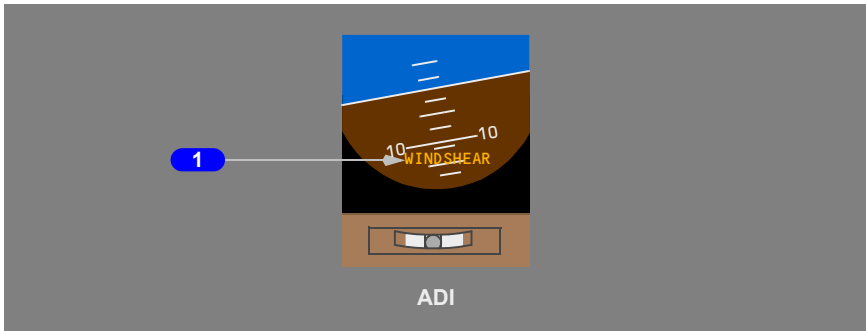

1 WINDSHEAR Annunciation

WINDSHEAR (red) – encountering a windshear condition

Predictive Windshear (PWS)

PWS Displays

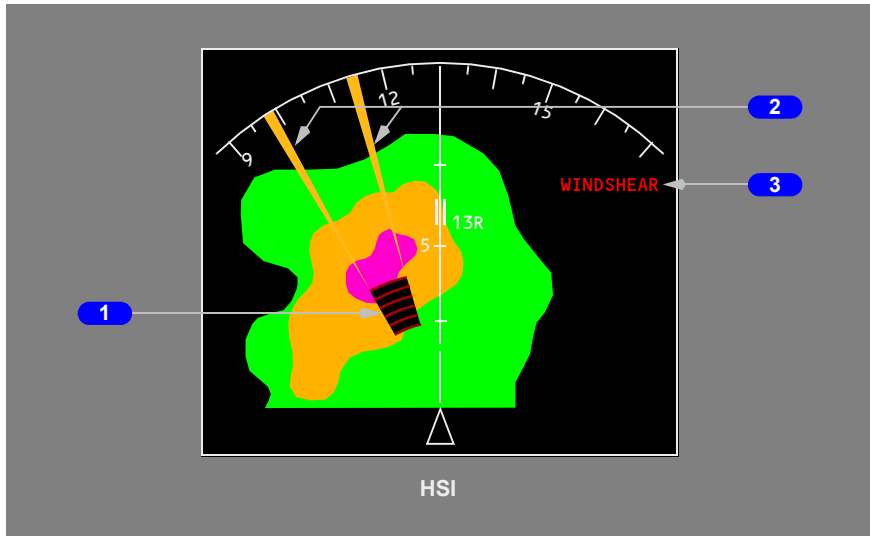

1 Predictive Windshear Symbol

Displayed (red and black) – PWS alert active

Shows predicted windshear location and approximate geometric size (width and depth).

Symbol, radials and weather radar returns display automatically on an HSI when:

- the aircraft is below 1200' AGL
- a PWS alert occurs
- weather (WXR) display select switch is not selected by either pilot; and
- respective HSI Mode Selector in the VOR, APP, MAP, or CTR MAP mode

Note: If a PWS alert occurs when terrain (TERR) is selected on both pilot HSI displays and there is not an active terrain alert occurring, weather radar display replaces terrain display. The weather radar display, including PWS symbology, can be deselected by pushing the TERR switch for the respective HSI.

2 Predictive Windshear Symbol Radials

Displayed (amber) – PWS alert active

Extend from predictive windshear symbol to help identify location of the PWS event.

3 WINDSHEAR

WINDSHEAR (red) – PWS warning is active

WINDSHEAR (amber) – PWS caution is active

Note: The size of the PWS symbol is proportional to the geographic size of the PWS event it represents and bears no relationship to its intensity.

Traffic Alert and Collision Avoidance System (TCAS)

TCAS Controls

Transponder Panel



1 TCAS Mode Selector

STBY – places transponders and TCAS system in standby

- displays TCAS OFF on HSI

ALT RPTG OFF – deactivates altitude reporting, TCAS system in standby

- displays TCAS OFF on HSI

XPDR – activates transponder only mode, TCAS system in standby

- displays TCAS OFF on HSI

TA ONLY – enables TCAS in Traffic Advisory mode

- display of Traffic Advisory (TA) symbols
- voice alerts
- displays TA ONLY on HSI

TA/RA – enables TCAS in Traffic Advisory and Resolution Advisory mode

- display of Traffic Advisory (TA) and Resolution Advisory (RA) symbols
- voice alerts
- vertical guidance for RAs
- displays TFC on HSI

EFIS Control Panel

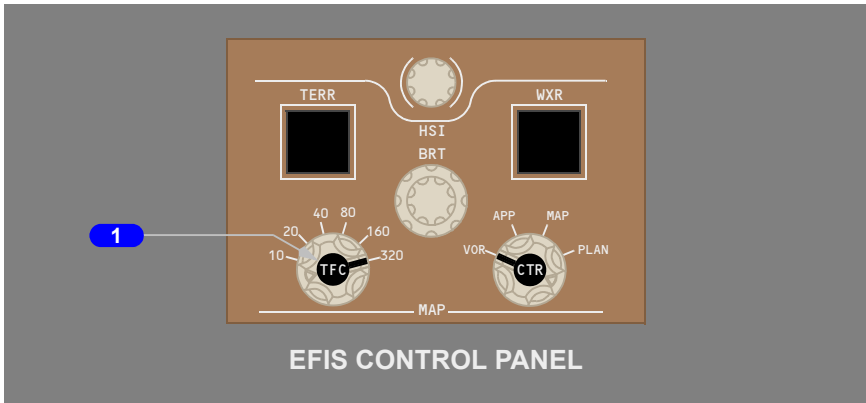

1 Traffic (TFC) Switch

Note: TCAS must be enabled on the Transponder Panel.

Push –

- displays or removes TCAS traffic information on HSI

TCAS Displays

HSI

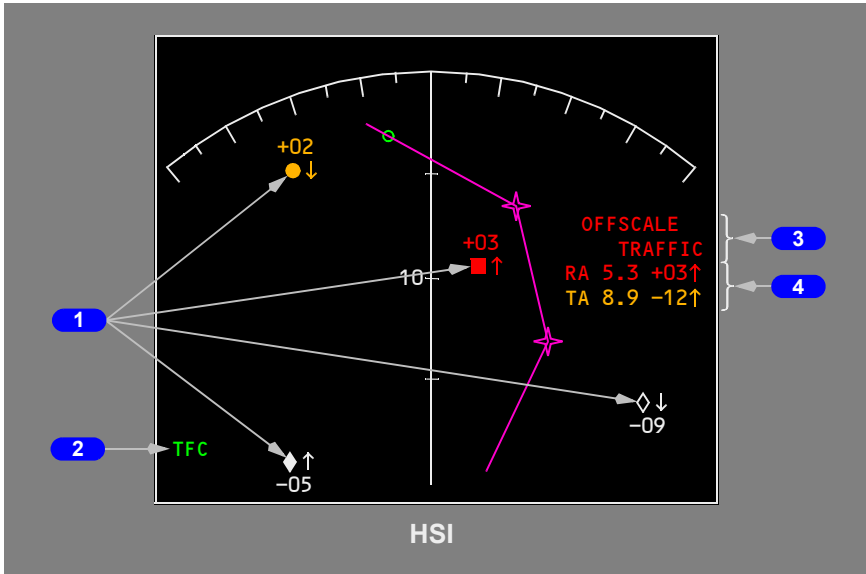









Note: See HSI TCAS symbology tables for description.

1 Traffic Aircraft Symbolology

Indicates the relative position of traffic aircraft.

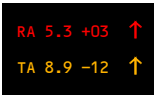
2 Mode Annunciations**3 Traffic Messages****4 No-Bearing Symbolology****HSI TCAS Symbolology**

| Symbol | Name (Color) | Applicable Mode(s) | Remarks |
|--|--|------------------------------|--|
|  | TCAS resolution advisory (RA), relative altitude (R) | MAP CTR MAP APP VOR | These symbols are displayed only when the EFIS control panel traffic (TFC) switch is selected on. |
|  | TCAS traffic advisory (TA), relative altitude (A) | | The arrow indicates traffic climbing or descending at a rate greater than or equal to 500 fpm. At rates less than 500 fpm, the arrow is not displayed. |
|  | TCAS proximate traffic, relative altitude (W) | | The number and associated signs indicate altitude of traffic in hundreds of feet relative to the airplane. |
|  | TCAS other traffic, relative altitude (W) | | The number is below the traffic symbol when the traffic is below, and above the traffic symbol when the traffic is above the airplane. Absence of the number implies altitude unknown. |

| Symbol | Name (Color) | Applicable Mode(s) | Remarks |
|--|---|------------------------------|---|
|  | TCAS no bearing message (RA-R, TA-A) | MAP CTR MAP APP VOR | <p>A TA (amber) or RA (red) is occurring and bearing information is not available</p> <ul style="list-style-type: none"> • maximum of two messages • data tag provides distance (nm), relative altitude (hundreds of feet), and vertical motion (in excess of 500 feet per minute) <p>Only displayed when the EFIS control panel traffic (TFC) switch is selected on.</p> |
|  | TCAS traffic alert message (RA-R, TA-A) | All | <p>Displayed whenever a TCAS RA or TA is active.</p> <p>EFIS control panel TFC switch does not have to be selected on.</p> |
|  | TCAS off scale message (RA-R, TA-A) | MAP CTR MAP APP VOR | <p>Displayed whenever RA or TA traffic is outside the traffic area covered by the HSI range.</p> <p>Displayed only if the EFIS control panel TFC switch is selected on.</p> |
|  | TCAS mode (G) | MAP CTR MAP APP VOR | <p>Indicates the HSI TCAS display is active and the EFIS control panel TFC switch is selected on.</p> <p>Not displayed when TCAS TEST, TCAS FAIL, or TCAS OFF is annunciated.</p> |

767 Flight Crew Operations Manual

| Symbol | Name (Color) | Applicable Mode(s) | Remarks |
|------------------|-----------------------|------------------------------|---|
| TA ONLY | TCAS mode (G) | All | TCAS control panel Mode Selector in: <ul style="list-style-type: none"> • TA ONLY Indicates TCAS computer is not computing RAs. Displayed whether the EFIS control panel TFC switch is selected on or off. |
| TCAS TEST | TCAS mode (W) | All | Indicates TCAS is operating in the test mode. Displayed whether EFIS control panel TFC switch is selected on or off. |
| TCAS OFF | TCAS off message (W) | MAP CTR MAP APP VOR | Displayed when the TCAS/ATC mode switch is not in TA ONLY or TA/RA. Not displayed if TCAS is failed. |
| TCAS FAIL | TCAS fail message (A) | MAP CTR MAP APP VOR | Indicates TCAS failure. |

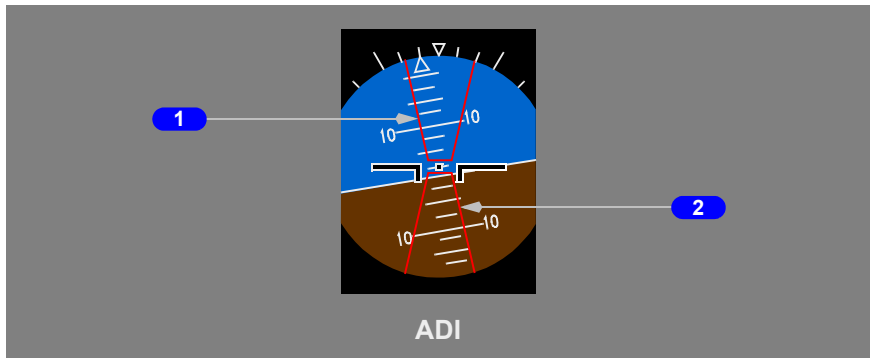
TCAS Vertical Guidance**ADI**

1 Vertical Guidance (Down Advisory)

Displayed (red) –

- a RA is occurring
- indicates pitch attitude region to be avoided for traffic-avoidance maneuver

2 Vertical Guidance (Up Advisory)

Displayed (red) –

- a RA is occurring
- indicates pitch attitude region to be avoided for traffic-avoidance maneuver

Note: Both of the TCAS RA pitch commands (above and below) may be displayed at the same time and are shown for clarity.

Note: The area inside the red lines indicates the pitch region to avoid in order to resolve the traffic conflict. The center of the airplane symbol must be outside the red RA pitch command area to ensure traffic avoidance.

Miscellaneous Switches

Configuration (CONFIG) Test Switches

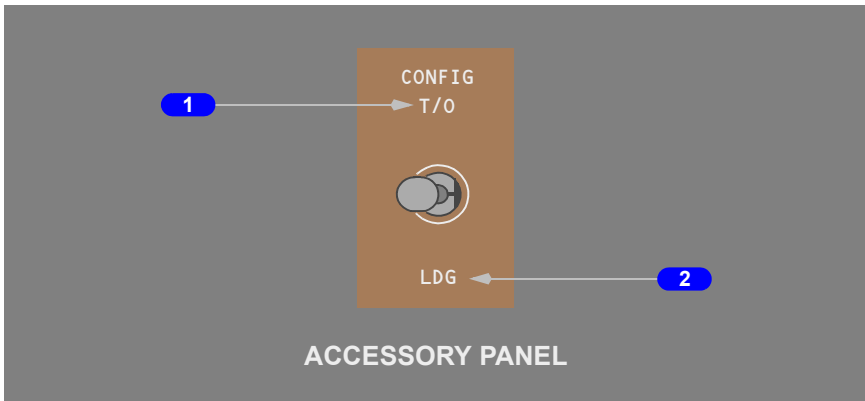

1 Takeoff (T/O) Test Switch

Spring-loaded to center

T/O – activates configuration warning if improper takeoff configuration exists

2 Landing (LDG) Test Switch

Spring-loaded to center

LDG – activates a landing configuration warning

Stall Warning Test Switches

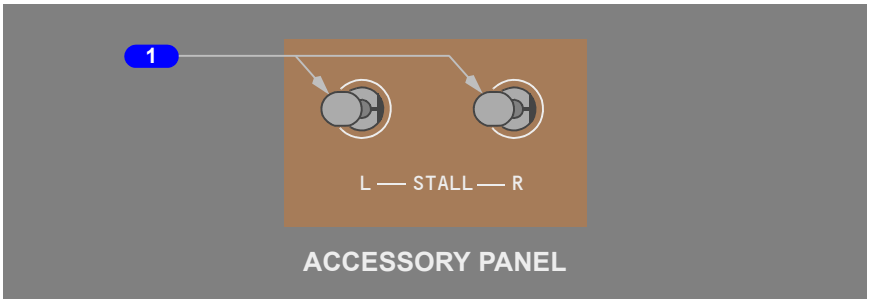

1 Stall (STALL L/R) Warning Test Switch

Spring-loaded to center

Activates stall warning system

EICAS Test Switch

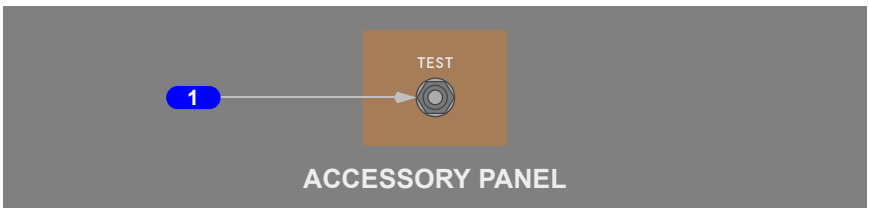

1 TEST Switch

Push – activates EICAS test

Intentionally
Blank

Introduction

The warning system consists of the following separate systems:

- engine indication and crew alerting system (EICAS)
- warning system
- ground proximity warning system (GPWS)
- traffic alert and collision avoidance system (TCAS)

These systems provide all airplane crew alerting.

Alert is defined as a visual, tactile and/or aural alert requiring crew awareness and possible crew action.

Engine Indication and Crew Alerting System (EICAS)

EICAS consolidates engine and subsystem indications and provides a centrally located crew alerting message display. EICAS also displays some system status and maintenance information. EICAS provides:

- system alerts
- maintenance information
- status messages
- communication alerts

System Alert Messages

System alert messages are associated with aircraft-system failures or faults. These may require performance of non-normal procedures, or affect the way the flight crew operates the airplane. There are four categories of system alert messages:

- time-critical warning
- warning
- caution
- advisory

System alert messages not associated with aircraft-system failures or faults but which may affect the way the flight crew operates the airplane include the following:

- configuration
- airspeed
- altitude
- windshear
- ground proximity warning system (GPWS)
- traffic alert and collision avoidance system (TCAS)

-
- communication alert messages such as SELCAL, ACARS, ATC or PRINTER
 - FMC messages (See Chapter 11, Flight Management, Navigation)

Non-normal airplane system conditions not affecting the normal airplane operations are annunciated using status or maintenance messages.

System Alert Level Definitions

Time Critical Warnings

Time critical warnings alert the crew of a non-normal operational condition requiring immediate crew awareness and corrective action to maintain safe flight. Time critical warnings are usually associated with primary flight path control. Master WARNING lights, voice alerts, and ADI indications or stick shakers announce time critical warning conditions.

Warnings

Warnings alert the crew to a non-normal operational or system condition requiring immediate crew awareness and corrective action.

Cautions

Cautions alert the crew to a non-normal operational or system condition requiring immediate crew awareness. Corrective action may be required.

Advisories

Advisories alert the crew to a non-normal operational or system condition requiring routine crew awareness. Corrective action may be required.

Communication Alerts

Communication alerts are triggered by the communication management system. These alerts direct the crew to the appropriate message display:

There are three levels of communication alert:

- low – identifies an incoming communication requiring timely awareness and response
- medium – identify an incoming communication requiring immediate awareness and a prompt response. It is accompanied by an aural chime
- high – reserved for future use.

A detailed description of the communication management system is described in Chapter 5, Communications.

Status Messages

Status messages identify system faults affecting airplane dispatch and are not considered crew alerts. The messages are displayed on the EICAS STATUS page.

Alert Message Displays

Alert messages are displayed in both prioritized and chronological order. The priority in descending order is:

- warning (red)
- caution (amber)
- advisory (amber, indented)
- medium level communication (white, preceded by a dot)
- low level communication (white, indented, preceded by a dot)

Warnings, cautions, and advisories are displayed from the top down in the EICAS display message area.

The most recent message is displayed at the top of its respective level.

If the number of messages exceeds eleven, the area below the alert field displays a page cue, indicating more than one page of messages is available for display. Paging is accomplished by pushing the CANCEL/RECALL switch on the display select panel.

Warning alerts can only be cleared by correcting the condition causing the warning. All caution and advisory alerts can be cleared. When the last page is displayed, pushing the CANCEL/RECALL switch clears all displayed caution and advisory alerts. Cleared caution and advisory alerts whose conditions still exist can be recalled by pushing the CANCEL/RECALL switch again. This also recalls the first page for review.

Communication alert messages are displayed at the bottom of the message area. Except for the Communication Alert Line, an overflow of system alert messages displaces communication alerts.

The Communication Alert Line, the bottom line of the EICAS message field (line 11), is reserved for a communication alert (medium or low) if one is active. The Communication Alert Line can not be displaced by a system alert even if more than 10 lines are active.

Communication alerts are removed when a pilot selects the appropriate switch on the Pilot's call panel.

Master Warning/Caution Reset Switches and Lights

Two Master WARNING/CAUTION reset switches each contain a Master WARNING light and Master CAUTION light.

The red Master WARNING lights illuminate when any warning alert or time critical warning occurs (except a stall warning). The lights remain illuminated as long as the warning alert exists or until either Master WARNING/CAUTION reset switch is pushed. Pushing either switch:

- extinguishes both Master WARNING lights
- resets the lights for future warning alerts.

Pushing either Master WARNING/CAUTION reset switch also silences the warning siren and fire bell except for the following warnings:

- landing configuration (for example, when the flaps are in a landing position and landing gear are not down)
- autopilot disconnect
- takeoff configuration

[Basic -- Overspeed warning siren not resettable]

- overspeed warning

[Option -- Overspeed warning siren resettable]

Pushing either Master WARNING/CAUTION reset switch also silences the overspeed warning siren.

The amber Master CAUTION lights illuminate when any caution alert occurs. The lights remain on as long as the caution alert exists or until either Master WARNING/CAUTION reset switch is pushed. Pushing either switch:

- extinguishes both Master CAUTION lights
- resets the lights for future caution alerts.

Flight Deck Panel Annunciator Lights

Flight deck panel annunciator lights are used in conjunction with EICAS messages to:

- help locate and identify affected systems and controls
- reduce the potential for error.

The annunciator lights provide system feedback in response to flight crew action. The lights also assist in fault detection and system preflight configuration when the engines are shut down and to supplement EICAS information.

Aural Alerts

Aural alerts are provided to ensure crew attention, recognition, and response. Aural alerts include synthetic voices and tones. Aural voice alerts are the most direct and rapid method of communicating a specific alert condition to the crew. Aural tones are used to alert the crew and to discriminate between the different alert types and levels.

767 Flight Crew Operations Manual

Aural alerts annunciate warnings and cautions. There are no aural annunciations associated with advisories.

Aural alerts also annunciate medium level communication alerts. There are no aural alerts associated with low level communication alerts.

The aural alerts are:

- **Beeper** – used for all system alert caution level messages. The beeper consists of a tone that sounds four times in a second. The beeper automatically silences after one series of four beeps
- **Bell** – used for fire warnings. The bell sounds repeatedly until crew action is initiated
- **Voice** – synthetic voices annunciate time critical warning alert conditions. Synthetic voices also annunciate certain normal but time critical operational information, such as approach phase altitude callouts.

[Basic -- Autopilot disconnect siren]

- **Siren** – used to annunciate cabin altitude, configuration, autopilot disconnect, and overspeed warning alerts. The siren consists of alternating high and low tones
- **Siren** – used to annunciate cabin altitude, configuration and overspeed warning alerts. The siren consists of alternating high and low tones

[Option -- Autopilot disconnect wailer]

- **Wailer** – used to annunciate autopilot disconnect warning.
- **Chime** – a high–low tone chime used for medium level communication alerts. The chime sounds once for each communication alert.

All continuous aural alerts are silenced automatically when the respective alert condition no longer exists.

Alert Inhibits

Alerts are inhibited during part of the takeoff in order not to distract the crew. Alerts are also inhibited when they are operationally unnecessary or inappropriate.

Alert messages, except for warnings and messages directly relevant to flight operations, are inhibited during engine start to eliminate nuisance messages.

Alert messages are inhibited individually at other times, such as during the preflight and postflight phases or engine shutdown, when they are operationally unnecessary.

Message Consolidation

On the ground with both engines shut down, certain caution and advisory alert messages are inhibited by collecting them into more general alert messages. These include individual fuel, hydraulic, door, and electrical messages. For example, two or more individual entry, cargo, and access door EICAS messages are replaced by the EICAS advisory message DOORS.

Engine Start Message Inhibits

During ground engine start, most new caution and advisory alerts are inhibited from engine start switch engagement until one of the following occurs:

- the engine reaches idle RPM
- the start is aborted, or
- 2 minutes elapse from engine start switch engagement.

The following messages are not inhibited:

- ENG FUEL VAL
- ENG SHUTDOWN
- ENG STARTER
- STARTER CUTOUT.

Takeoff Inhibits

Warning Inhibits

The Master WARNING lights and fire bell are inhibited for fire during part of the takeoff. The inhibit begins at nose gear extension during rotation and continues until the first to occur:

- 400 feet AGL, or
- 20 seconds elapsed time

If a fire occurs during the inhibit, an EICAS warning message appears, but the fire bell and Master WARNING lights do not activate. If the warning condition still exists when the inhibit is removed, the fire bell and Master WARNING lights activate immediately.

Note: Takeoff configuration warnings are terminated at rotation.

Caution Inhibits

The Master CAUTION lights and aural annunciations are inhibited for all cautions during part of the takeoff. The inhibit begins at 80 knots and continues until the first to occur:

- 400 feet AGL, or
- 20 seconds elapsed time following nose gear extension

If a caution occurs during the inhibit and exists on the ground when the airspeed decreases below 75 knots, both Master CAUTION lights and aural activate.

Note: EICAS caution messages are not inhibited during takeoff.

Advisory Inhibits

The following EICAS advisory messages are inhibited on takeoff:

- WINDSHEAR SYS to indicate windshear alerting functions are inoperative.

The inhibit begins from the time either engine is advanced to takeoff thrust until the first to occur:

- 400 feet AGL, or
- 20 seconds elapsed time following nose gear extension

All other EICAS advisory messages are not inhibited on takeoff:

Communication Inhibits

The following are inhibited during takeoff:

- EICAS communication alert messages such as SELCAL, ACARS, ATC or PRINTER and associated aural chimes. The CABIN ALERT message is not inhibited. The chime associated with the CABIN ALERT message is inhibited.

The inhibit begins from the time either engine is advanced to takeoff thrust until the first to occur:

- 400 feet AGL, or
- 20 seconds elapsed time following nose gear extension

Inhibits are cleared on the ground with both engines below takeoff thrust. If a message alert occurs during the inhibit and exists when the inhibit ends, the EICAS alert message and aural chime activate.

Landing Inhibits

Communication Inhibits

The following are inhibited during landing:

- EICAS communication alert messages such as SELCAL, ACARS, ATC or PRINTER and associated aural chimes. The CABIN ALERT message is not inhibited. The chime associated with the CABIN ALERT message is inhibited.

The inhibit begins on descent at 800 feet AGL and terminates at:

- less than 75 knots groundspeed
- 900 feet AGL on missed approach

If a communication alert message occurs during the inhibit and exists when inhibit ends, the EICAS alert message and associated aural chime activate.

Engine Shutdown Inhibits

Engine-driven pumps, generators, and other components whose alert messages would result from an engine shutdown are inhibited by the ENG SHUTDOWN message. When an engine is shutdown (FUEL CONTROL switch in cut off or fire handle pulled), the EICAS alert message L ENG SHUTDOWN or R ENG SHUTDOWN is displayed and the following L or R alerts are inhibited:

- ENG ANTI-ICE
- ENG BLEED OFF
- GEN DRIVE
- GEN OFF
- ENG OIL PRESS
- HYD PRIM PUMP
- ENG CONTROL

When the airplane is on the ground and both FUEL CONTROL switches are in the CUT OFF position, the Master CAUTION lights and the caution alert beeper are inhibited. This prevents alerts associated with routine gate operations from triggering nuisance lights and aural alerts.

When the shutdown inhibit is removed, the Master CAUTION lights and alert beeper do not activate for alerts that existed prior to its removal. For example, if the right hydraulic system is depressurized with both engines shutdown, and the left engine is then started, the Master CAUTION lights and beeper do not activate. The Master CAUTION lights and beeper activate only when the alert first occurs, provided no other inhibit is in effect.

Alert Message Inhibits

Alert message inhibits are those inhibits where one message is inhibited by the presence of another alert message. For example, individual fuel or hydraulic pump pressure messages are inhibited by higher priority system pressure messages.

Certain alert messages are time delayed, even though discrete system lights may illuminate. Time delay inhibits prevent normal in-transit indications from appearing as EICAS system alert messages. For example, valves are generally only sensed open and/or closed, not in-transit. When a valve is in-transit, the alert message indicating the valve has failed to open or close is inhibited to allow the valve time to move to the commanded position. If the valve is not in the commanded position at the end of the inhibit period, an EICAS system alert message is displayed.

Altitude Alerting Inhibits

Altitude alerting is inhibited in flight with all landing gear down and locked.

Master Caution Lights and Beeper Inhibit

The Master CAUTION lights and the associated alert beeper are inhibited for the L and R ENG SHUTDOWN caution level message.

EICAS Event Record

The flight crew can manually capture and record any suspect condition into EICAS memory using the EICAS EVENT RECORD switch.

Systems which provide recorded information when the switch is activated include:

- anti-ice, ice detection
- air systems
- APU
- electrical
- electronic engine control
- fire protection
- flight controls/flaps and slats
- fuel quantity and fuel management
- hydraulic
- landing gear and brakes
- performance.

Only the last manual event recorded will be retained for future retrieval. The event record function also has an automatic feature. When an EICAS event occurs, conditions are automatically written to EICAS memory.

EICAS Failure Indications

If a fault is detected in one of the cathode ray tubes (CRTs), the faulty display is blanked. Engine indications and crew alerting messages appear on the operable display. An EICAS DISPLAY advisory message displays when one CRT fails.

To ensure that all engine indications can be displayed with a CRT failure, an EICAS compacted display mode is available. The compacted display mode is described in the Engines, APU chapter.

If the EICAS control panel fails an EICAS CONT PNL advisory message displays and the EICAS full up engine mode automatically displays. The full engine mode is described in Chapter 7, Engines, APU. The cancel and recall switches will not operate when the EICAS control panel fails, however, brightness and computer select controls remain operative.

If both EICAS computers or CRTs fail, a standby engine indicator (SEI) is automatically activated. The SEI, system lights and indicators are used to monitor the engines and system operation when a total EICAS failure occurs.

Warning System

The warning system consists of flight deck speakers, Master WARNING/CAUTION lights, EICAS alert messages, and stick shaker motors.

The warning system controls and activates alerts for:

- fire (See Chapter 8, Fire Protection)
- cabin altitude (See Chapter 2, Air Systems)
- autopilot disconnect (See Chapter 4, Automatic Flight)
- configuration
- airspeed
- altitude
- ground proximity warning system (GPWS)
- windshear
- traffic alert and collision avoidance system (TCAS)

Configuration Alerts

Takeoff

Takeoff configuration warnings are armed when the airplane is on the ground and thrust is in the takeoff range on either engine. Takeoff configuration warnings consist of:

- Master WARNING lights illuminate
- CONFIG warning light illuminates
- aural warning siren sounds
- applicable EICAS configuration warning alert message(s) are displayed.

Takeoff configuration warning messages include:

- FLAPS
- PARKING BRAKE
- SPOILERS
- STABILIZER

Takeoff configuration warnings are disarmed at rotation.

Existing takeoff configuration warning are:

- cancelled when the configuration error is corrected
- terminated at rotation

When a takeoff configuration warning occurs, pushing either Master WARNING/CAUTION reset switch resets the Master WARNING lights but does not silence the siren or clear the EICAS alert message. Before reaching rotation, the siren can be silenced and the EICAS alert message cleared only by retarding both thrust levers or correcting the condition. If thrust is reduced, the EICAS takeoff configuration message remains displayed for 10 seconds so the crew can positively identify the configuration problem.

Holding the configuration test switch in the takeoff (T/O) position simulates accelerating an engine to takeoff power. No warnings occur when testing an airplane properly configured for takeoff. If the airplane is not configured for takeoff a configuration warning results. Releasing the test switch cancels the test.

Landing

The landing configuration warning system alerts the crew that the landing gear is not extended for landing. The landing configuration warning activates if:

- the airplane is in flight, and
- any landing gear is not down and locked, and
- either of the following conditions exists:
 - flaps in a landing position (25 or 30), or
 - any thrust lever is at idle with radio altitude below 800 feet.

The landing configuration warning consists of:

- Master WARNING lights illuminate
- CONFIG warning light illuminates
- aural warning siren activates
- the GEAR NOT DOWN EICAS warning alert message is displayed.

With the flaps in a landing position, the siren and alert message cannot be deactivated with the Master WARNING/CAUTION reset switches. The siren and message continue until the condition is corrected or the gear override switch is pushed.

If the warning is due to an idle thrust setting at low altitude, pushing either Master WARNING/CAUTION reset switch silences the siren and extinguishes the Master WARNING lights. The EICAS message remains displayed until the configuration error is corrected.

Holding the configuration test switch in the landing (LDG) position results in a configuration warning regardless of landing gear position. All warning indications disappear when the switch is released.

Airspeed Alerts

Stall Warning

Warning of an impending stall is provided by left and right stick shakers, which independently vibrate the left and right control columns. If the flaps are in the retracted position and the angle of attack continues to increase, a control column nudger moves the control column forward. Both systems are energized in flight and deactivated on the ground through air/ground logic.

Holding the stall warning tests switches to either the L or R position checks the left and right stall warning systems, respectively. If the systems are tested at the same time, both columns vibrate and the control column nudger activates.

Overspeed Warning

An overspeed warning occurs if V_{mo}/M_{mo} limits are exceeded. The overspeed warning consists of:

- Master WARNING lights illuminate
- OVSPD light illuminates
- the EICAS warning alert message OVERSPEED is displayed
- aural warning siren sounds

All warning indications remain activated until airspeed is reduced below V_{mo}/M_{mo}.

The aural warning can be silenced by pushing either Master WARNING/CAUTION reset switch.

Altitude Alerts

Altitude alerting occurs when approaching or departing the MCP-selected altitude.

Approaching A Selected Altitude

At 900 feet prior to reaching the selected altitude, the ALT light on each pilot's altimeter illuminates. At 300 feet prior to reaching the selected altitude, the ALT lights extinguish.

Deviating From A Selected Altitude

When deviating 300 feet from the selected altitude:

- the Master CAUTION lights illuminate
- the caution aural sounds
- the EICAS caution message ALTITUDE ALERT is displayed
- the ALT ALERT light illuminates.

When deviating more than 900 feet from the selected altitude, or upon returning to within 300 feet of the selected altitude:

- the Master CAUTION lights extinguish
- the EICAS caution message ALTITUDE ALERT is no longer displayed
- The ALT ALERT light extinguishes.

Resetting To A Selected Altitude

Altitude alerting is reset when:

- the airplane returns to within 300 feet of the altitude selected or deviates more than 900 feet from the altitude selected
- the MCP-selected altitude is changed

Altitude Alert Inhibits

Altitude alerting is inhibited in flight with all landing gear down and locked.

Altitude Alert Profile

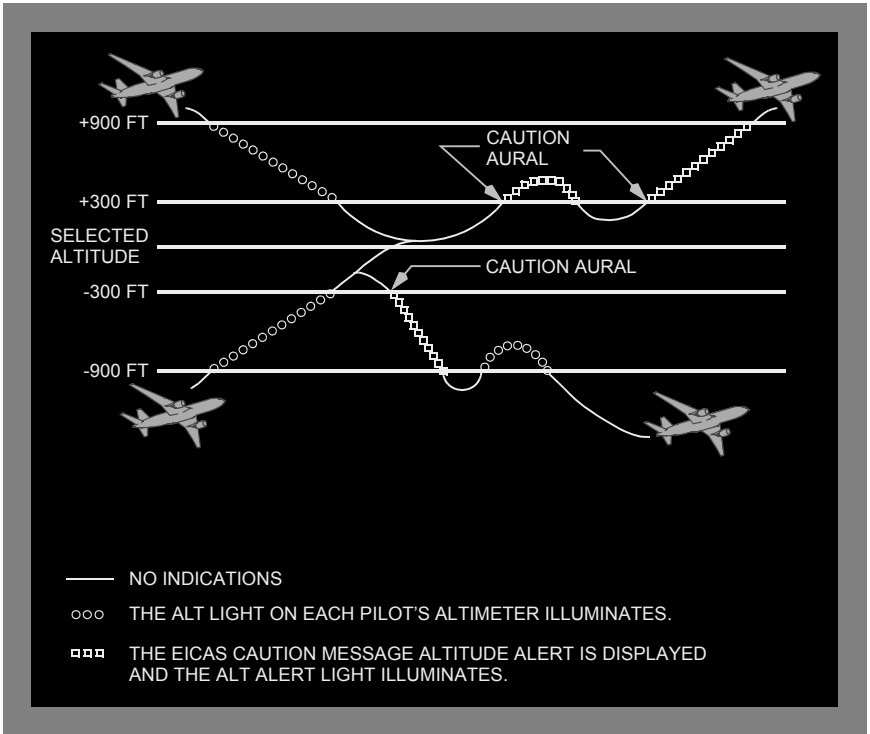

Ground Proximity Warning System (GPWS)

Introduction

The ground proximity warning system (GPWS) provides time-critical alerts for potentially hazardous flight conditions involving imminent impact with the ground. GPWS is enabled whenever power is applied to the airplane. Override or inhibit switches allow the flight crew to inhibit certain GPWS alerts.

GPWS provides voice callouts (Mode 6) to assist the flight crew with situational awareness and to advise the flight crew of the aircraft's approximate height above the ground.

In addition to aircraft configuration, GPWS requires inputs from the following for proper operation:

- air data system
- inertial reference system
- instrument landing system
- radio altimeters

Note: Loss of an input does not necessarily inhibit operation of the entire GPWS.

Standard GPWS alerts are radio altitude based and provided for the following:

- excessive and severe descent rate (Mode 1)
- excessive terrain closure rate (Mode 2)
- altitude loss after takeoff or go-around (Mode 3)
- unsafe terrain clearance when not in the landing configuration (Mode 4)
- excessive deviation below an ILS glide slope (Mode 5)
- windshear (Mode 7)

GPWS (Enhanced)

In addition to standard alerts, enhanced GPWS provides look-ahead terrain awareness, including alerting and display functions. These functions compare the airplane's geographic position and altitude against an internal terrain database to predict and display potential conflicts between the airplane flight path and terrain.

The enhanced GPWS internal database also provides prediction and display of potential conflicts between the airplane flight path and man-made obstacles.

In addition to standard GPWS inputs, enhanced GPWS requires inputs from the following for proper operation:

- global positioning system

Note: Loss of an input does not necessarily inhibit operation of the entire GPWS.

GPWS Alert Prioritization

GPWS and Windshear Warning System alerts are prioritized based on the level of hazard and the required flight crew response. The following are listed in order of decreasing priority:

GPWS Alerts

| Condition | Alert Level | Description |
|------------------------------|--------------------|---|
| Windshear - Immediate | Warning | Mode 7 - Actual windshear conditions (downdraft) A windshear immediate-alert warning inhibits all other GPWS and windshear alerts. |
| Ground proximity - Immediate | Warning | Mode 1 - Severe decent rate |
| Ground proximity - Immediate | Warning | Mode 2 - Severe terrain closure rate |
| Terrain - Awareness | Warning | Look-Ahead - Terrain along flight path (Near) |
| Obstacle - Awareness | Warning | Look-Ahead - Obstacle along flight path (Near) |
| Windshear - Awareness | Warning | Predictive - Windshear condition along flight path |
| Ground proximity - Immediate | Caution | Mode 2 - Excessive terrain closure rate |
| Terrain - Awareness | Caution | Look-Ahead - Terrain along flight path |
| Obstacle - Awareness | Caution | Look-Ahead - Obstacle along flight path |
| Ground proximity - Immediate | Caution | Mode 4 - Unsafe terrain clearance |
| Altitude - Awareness | | Mode 6 - Altitude callouts |

| Condition | Alert Level | Description |
|------------------------------|-------------|--|
| Ground proximity - Immediate | Caution | Mode 4 - Unsafe terrain clearance - Gear |
| | | Mode 4 - Unsafe terrain clearance - Flaps |
| | | Mode 1 - Excessive decent rate |
| | | Mode 3 - Decent (sink rate) after takeoff |
| | | Mode 5 - Below glideslope - ILS deviation |
| Windshear - Awareness | Caution | Predictive - Windshear adjacent to flight path |

GPWS Immediate-Alerts

GPWS immediate-alert warnings (Modes 1-2) are accompanied by:

- visual alerts (see tables)
- aural alerts (see tables)

If illuminated, pushing a Master WARNING/CAUTION Reset switch resets the Master WARNING lights but does not inhibit the GPWS warning.

GPWS immediate-alert cautions (Modes 1-5) are accompanied by:

- visual alerts (see tables)
- voice aural alerts (see tables)

GPWS Immediate-Alert Warnings

| Aural Alert | Visual Alert | Description |
|-------------|-----------------------|--|
| PULL UP | PULL UP light (red) | Follows SINK RATE alert if descent rate becomes severe. (Mode 1) |
| | Master WARNING lights | Follows TERRAIN alert if excessive terrain closure rate continues and landing gear and/or flaps are not in landing configuration. (Mode 2) |

767 Flight Crew Operations Manual

GPWS Immediate-Alert Cautions

| Aural Alert | Visual Alert | Description |
|-------------------|---------------------------|--|
| TERRAIN | GND PROX light (amber) | Excessive terrain closure rate. (Mode 2) |
| DON'T SINK | GND PROX light (amber) | Excessive altitude loss after takeoff or go-around. (Mode 3) |
| GLIDE SLOPE | GND PROX light (amber) | Deviation below glide slope. (Mode 5) Volume and repetition rate increase as deviation increases. Note: Pushing the GND PROX G/S INHB switch cancels or inhibits the alert below 1,000 feet radio altitude. |
| SINK RATE | GND PROX light (amber) | Excessive descent rate. (Mode 1) |
| TOO LOW, FLAPS | GND PROX light (amber) | Unsafe terrain clearance at low airspeed with flaps not in landing configuration. (Mode 4) Note: Pushing the GND PROX FLAP OVRD switch to OVRD inhibits the alert. |
| TOO LOW, GEAR | GND PROX light (amber) | Unsafe terrain clearance at low airspeed with landing gear not down. (Mode 4) Note: Pushing the GND PROX/CONFIG GEAR OVRD switch to OVRD inhibits the alert. |

| Aural Alert | Visual Alert | Description |
|---------------------|---------------------------|--|
| TOO LOW, TERRAIN | GND PROX light (amber) | <p>Follows DON'T SINK if another descent is initiated after initial alert and before climbing to the altitude where the initial descent began. (Mode 3)</p> <p>Unsafe terrain clearance at low airspeed with either landing gear not down or flaps not in landing position. (Mode 4)</p> <p>Note: Pushing the GRND PROX FLAP OVRD switch to OVRD inhibits the alert, when the alert is due to flaps not in landing position.</p> <p>Note: Pushing the GND PROX/CONFIG GEAR OVRD switch to OVRD inhibits the alert, when the alert is due to gear not down.</p> |

GPWS Voice Callouts

GPWS provides voice callouts (Mode 6) to assist the flight crew with situational awareness and to advise the flight crew of the aircraft's approximate height above the ground.

| Callout | Description |
|------------------------|---|
| BANK ANGLE, BANK ANGLE | <p>Voice callout occurs when airplane roll angle reaches:</p> <ul style="list-style-type: none"> • 35 degrees • 40 degrees • 45 degrees <p>Note: Callout is reset when roll angle decreases below 30 degrees.</p> |

GPWS Look-Ahead Alerts and Display

GPWS provides look-ahead alerts for potentially hazardous flight conditions involving impact with the ground. GPWS monitors terrain proximity and generates a display from a world-wide terrain data base in the GPWS computer. The data base contains detailed terrain data near major airports and data in lesser detail for areas between airports.

In addition to terrain alerting, GPWS provides look-ahead alerts for potentially hazardous flight conditions involving impact with human-made obstacles (minimum height of approximately 100 feet). GPWS monitors obstacle proximity and generates a display from a separate obstacle data base in the GPWS computer. The data base contains detailed obstacle data near major airports and data in lesser detail for areas between airports.

Note: The obstacle data base is not yet world wide.

Airplane horizontal position is determined using the:

- global positioning system. If GPS data is intermittently unavailable, GPWS derives horizontal position from the IRS.

Barometric altitude errors induced from temperature extremes or from non-standard pressure altitudes are minimized. Airplane vertical position is determined using a blended solution calculated from the following:

- GPS altitude
- barometric altitude
- radio altitude
- static air temperature

Look-Ahead Displays

When the EFIS control panel terrain (TERR) display select switch is pushed on, the TERR annunciation is displayed on the HSI and terrain contours may be displayed.

GPWS look-ahead data and weather radar returns cannot be displayed simultaneously on an HSI. If either pilot selects terrain while the other selects weather radar, each display updates on alternating sweeps. All other navigation displays can be simultaneously displayed with terrain data.

When the airplane is lower than 2,000 feet above the terrain, terrain within 2,000 feet of airplane barometric altitude is displayed on the HSI. Non-threat terrain is depicted as several densities of dot patterns in green, amber, or red depending on relative vertical distance between the airplane and the terrain.

The HSI may also display man-made obstacles. When the airplane is higher than 2,000 feet above the terrain, non-threat obstacles and terrain peaks are displayed using solid, high density, and low density contours of green. The highest obstacle or terrain is represented by solid green, and the lowest obstacle or terrain displayed is represented by low density green.

When the enhanced GPWS look-ahead display is selected the HSI displays a digital indication of the highest and lowest terrain or obstacle within the selected map range. The elevation numbers are expressed in hundreds of feet above sea level (e.g. 125 is 12,500 ft. MSL) with the highest elevation on top and the lowest on the bottom. The color of the elevation numbers match the color of the represented terrain or obstacle.

Note: The GPWS look-ahead display is not designed to be used as an independent navigation aid.

Look-Ahead Alerting

The enhanced GPWS computer continuously computes clearance envelopes looking down and ahead of the airplane. Estimated time to impact is calculated from airplane position, barometric altitude, present track, vertical path, and ground speed. FMC VNAV or LNAV (Refer to Chapter 11, Flight Management, Navigation) paths are not considered in the estimated time to impact.

When the terrain clearance boundaries are crossed the GPWS issues alerts. Alert levels, warning or caution, are based on estimated time to impact. Look-ahead alerts will cause the GPWS look-ahead awareness display to "pop-up" when:

- the HSI display is in an appropriate mode (see tables)
- neither terrain (TERR) display select switch is ON

Note: Obstacles or terrain ahead of the airplane may exceed available climb performance. A GPWS caution or warning alert does not guarantee obstacle or terrain clearance.

Look-Ahead Alerting - Warnings

GPWS look-ahead warning alerts are accompanied by:

- visual alerts (see tables)
- voice aural alerts (see tables)
- solid red obstacles or solid red terrain displayed on HSIs

767 Flight Crew Operations Manual

If illuminated, pushing a Master WARNING/CAUTION Reset switch resets the Master WARNING lights but does not inhibit the GPWS warning.

| Aural Alert | Visual Alert | Description |
|---------------------------------|---|--|
| TERRAIN TERRAIN PULL UP | PULL UP light (red) Master WARNING lights Solid red terrain on HSI Red TERRAIN annunciation on both HSIs | 20 to 30 seconds from projected impact with terrain shown in solid red on the HSI. Pop-up look-ahead display is only available in the following modes: <ul style="list-style-type: none"> • VOR, APP, MAP and CTR MAP Note: Pushing the TERR OVRD switch to OVRD inhibits the alert. |
| OBSTACLE OBSTACLE PULL UP | PULL UP light (red) Master WARNING lights Solid red obstacle on HSI Red OBSTACLE message on both HSIs | 20 to 30 seconds from projected impact with an obstacle shown solid red on the HSI. Pop-up look-ahead display is only available in the following modes: <ul style="list-style-type: none"> • VOR, APP, MAP and CTR MAP Note: Pushing the TERR OVRD switch to OVRD inhibits the alert. Note: If an obstacle alert occurs while a TERRAIN annunciation is displayed, the OBSTACLE annunciation replaces the TERRAIN annunciation. Both annunciations can not be displayed at the same time. |

Look-Ahead Alerting - Cautions

GPWS look-ahead caution alerts are accompanied by:

- visual alerts (see tables)
- voice aural alerts (see tables)

- solid amber obstacles or solid amber terrain displayed on HSIs

| Aural Alert | Visual Alert | Description |
|---------------------|--|---|
| CAUTION TERRAIN | GND PROX light (amber) Solid amber terrain on HSI Amber TERRAIN annunciation on both HSIs | 40 to 60 seconds from projected impact with terrain shown in solid amber on the HSI. Pop-up look-ahead display is only available in the following modes: • VOR, APP, MAP and CTR MAP Note: Pushing the TERR OVRD switch to OVRD inhibits the alert. |
| CAUTION OBSTACLE | GND PROX light (amber) Solid amber obstacle on HSI Amber OBSTACLE annunciation on both HSIs | 40 to 60 seconds from projected impact with an obstacle shown in solid amber on the HSI. Pop-up look-ahead display is only available in the following modes: • VOR, APP, MAP and CTR MAP Note: Pushing the TERR OVRD switch to OVRD inhibits the alert. Note: If an obstacle alert occurs while a TERRAIN annunciation is displayed, the OBSTACLE annunciation replaces the TERRAIN annunciation. Both annunciations can not be displayed at the same time. |
| TOO LOW, TERRAIN | GND PROX light (amber) | Terrain Clearance Floor (TCF) alert indicating unsafe terrain clearance based on current airplane location, nearest runway center point and radio altitude. Similar to Mode 4 but available in all flight modes. Note: Pushing the TERR OVRD switch to OVRD inhibits the alert. |

Windshear Warning System

Windshear Immediate-Alerts

The GPWS takes additional data from the stall warning computer (STC) and determines if decreasing-performance windshear conditions are occurring in the immediate vicinity of the airplane. GPWS issues Windshear Immediate-Warnings whenever decreasing-performance windshear conditions are present during takeoff, approach and landing.

Warnings

Windshear warnings are accompanied by:

- visual alerts (see tables)
- voice or aural alert (see tables)

If illuminated, pushing a Master WARNING/CAUTION reset switch resets the Master WARNING lights but does not deactivate the windshear warning.

Windshear Immediate-Alert Warnings

| Aural Alert | Visual Alert | Description |
|--------------------------------------|--|--|
| Two-tone siren followed by WINDSHEAR | WINDSHEAR light (red) Master WARNING lights Red WINDSHEAR on both ADIs | Excessive windshear at the current airplane position detected by GPWS. Enabled below 1,500 feet radio altitude. GPWS Windshear detection begins at rotation. |

Predictive Windshear (PWS)

The weather radar (See Chapter 11, Flight Management, Navigation) provides PWS alerts when it detects disturbed air ahead of the aircraft which contains moisture or particulate matter and which fits a known pattern of windshear activity.

The PWS alert area ahead of the aircraft is shown as follows:

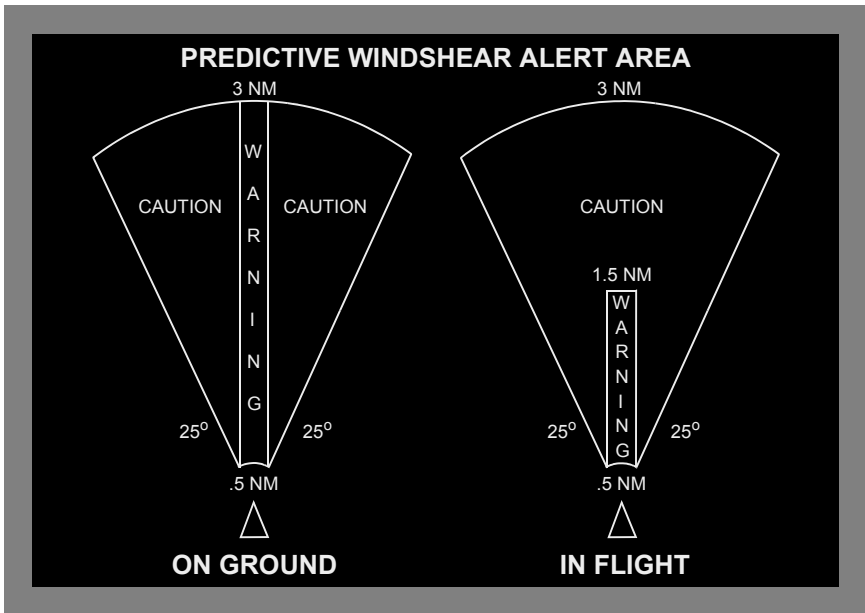

When the PWS mode is enabled, the radar system is time-shared between the weather display and the PWS display. During the time-share:

- the weather display is slower to update
- PWS alerts are available approximately 12 seconds after the system begins scanning
- PWS automatically, regardless of actual Weather Radar Control Panel settings, adjusts the antenna TILT and the system GAIN for optimum windshear detection

The PWS mode is automatically enabled when:

- on the ground, the thrust levers are set for takeoff
- in flight, the aircraft is below 2,300 feet AGL

PWS alerts are automatically enabled below 1,200 feet AGL. If a PWS alert occurs when weather (WXR) is not selected on either pilot HSI displays and there is not an active terrain alert occurring; the weather radar display, including PWS symbology, automatically pops-up on the HSI.

Note: PWS does not provide alerting for all types of windshear. The flight crew must continue to rely on traditional windshear avoidance methods.

Warnings

PWS warnings are accompanied by:

- visual alerts (see tables)
- voice or aural alerts (see tables)

If illuminated, pushing a Master WARNING/CAUTION reset switch resets the Master WARNING lights but does not deactivate the windshear warning.

Predictive Windshear Warnings

| Aural Alert | Visual Alert | Description |
|------------------------------------|---|---|
| WINDSHEAR AHEAD WINDSHEAR AHEAD | WINDSHEAR light (Red) MASTER WARNING lights Red WINDSHEAR annunciation on both ADIs RED and BLACK PWS symbol on HSI Red WINDSHEAR annunciation on HSI (all modes) | Enabled during takeoff, below 1,200 feet AGL. Windshear within 3.0 miles and directly ahead of the airplane. If weather (WXR) is not selected on either HSI, the weather display, including PWS symbology, will automatically pop-up on the HSI. PWS symbol on the HSI shows windshear position and size only when the HSI Mode Selector is in the VOR, APP, MAP or CTR MAP mode. |
| GO AROUND, WINDSHEAR AHEAD | WINDSHEAR light (Red) MASTER WARNING lights Red WINDSHEAR annunciation on both ADIs RED and BLACK PWS symbol on HSI Red WINDSHEAR annunciation on HSI (all modes) | Enabled during approach, below 1,200 feet AGL. Windshear within 1.5 miles and directly ahead of the airplane. If weather (WXR) is not selected on either HSI, the weather display, including PWS symbology, will automatically pop-up on the HSI. PWS symbol on the HSI shows windshear position and size only when the HSI Mode Selector is in the VOR, APP, MAP or CTR MAP mode. |

Cautions

PWS caution alerts are accompanied by:

- visual alerts (see tables)
- voice or aural alerts (see tables)

Predictive Windshear Caution

| Aural Alert | Visual Alert | Description |
|-----------------------------|---|---|
| MONITOR RADAR DISPLAY | RED and BLACK PWS symbol on HSI Amber WINDSHEAR annunciation on HSI | Windshear within 3 miles and not directly ahead of the airplane. Enabled during takeoff and approach, below 1,200 feet AGL. If weather (WXR) is not selected on either HSI, the weather display, including PWS symbology, will automatically pop-up on the HSI. PWS symbol on the HSI shows windshear position and size only when the HSI Mode Selector is in the VOR, APP, MAP or CTR MAP mode. |

Inhibits

PWS alerts are inhibited during takeoff and landing as follows:

- WARNINGS, between 100 knots and 50 feet AGL
- CAUTIONS, between 80 knots and 400 feet AGL

Note: These inhibits do not remove existing PWS alerts.

PWS alerts are also inhibited by:

- Windshear Immediate-Alert Warnings
- GPWS Immediate-Alert Warnings
- GPWS Look-Ahead-Alert Warnings

Traffic Alert and Collision Avoidance System (TCAS)

TCAS alerts the crew to conflicting traffic. The system identifies a three-dimensional airspace around the airplane where a high likelihood of air traffic conflicts exist. These dimensions depend upon closure rates between the airplane and potentially conflicting traffic.

TCAS interrogates operating transponders in other aircraft, analyzes the replies, predicts flight paths and designates possible conflicting traffic as a "traffic aircraft."

When the system designates a traffic aircraft, TCAS provides the flight crew with a situational display. Additionally, TCAS may provide an aural annunciation and flight path guidance.

Note: Other aircraft that do not have an operating transponder can not initiate situational displays, aural annunciations or flight path guidance.

Note: TCAS is independent of ground-based air traffic control.

During normal operations, when TCAS designates a traffic aircraft, the system provides the following advisories and displays:

- Resolution Advisories (RA) and Displays
- Traffic Advisories (TA) and Displays
- Proximate Traffic and Other Traffic Displays

Normal Operations

TCAS is enabled from the Transponder Panel. The system is normally operated with the TCAS Mode Selector in the TA/RA mode.

The TA ONLY mode may be used:

- during engine out operations to prevent RAs when adequate thrust may not be available to follow the RA commands
- when intentionally operating near other traffic that may cause RAs, such as during parallel approaches or during VFR operations.

Resolution Advisories (RA) and Displays

A Resolution Advisory (RA) is an immediate-threat prediction that traffic aircraft will enter the TCAS collision airspace within approximately 20 to 30 seconds. If altitude data from the traffic aircraft's transponder is not available, no RA can be provided.

When TCAS issues a RA:

- a voice alert sounds
- vertical guidance is displayed
- symbology is displayed

Voice Alert

When a RA is predicted, one of several initial RA voice alerts will sound. These voice alerts aurally elaborate on the displayed Vertical Guidance and are described in this Chapter under:

- Voice Annunciations for ADI Guidance

Vertical Guidance

Vertical guidance is displayed for a traffic-avoidance maneuver. Traffic avoidance is ensured by adjusting or maintaining:

- an ADI pitch attitude outside the displayed red RA regions

Note: If the traffic aircraft also has TCAS and an operating mode S transponder, vertical guidance is coordinated with the traffic aircraft.

Display Symbology

The RA traffic symbol is a filled red square with an accompanying data tag when the traffic aircraft is providing altitude information.

The data tag appears in red and contains the following information about the traffic aircraft:

- a two-digit number preceded with a "+" or a "-" sign and positioned above or below the RA symbol. This number represents, in hundreds of feet, the relative vertical position and altitude difference between the airplane and the traffic aircraft.
- a vertical arrow appears to the right of the RA symbol when the traffic aircraft is either climbing or descending in excess of 500 feet per minute.

The RA is displayed as follows:

HSI

- When the red TRAFFIC message appears and the traffic aircraft is within the selected display range, the traffic symbol's relative position is displayed.
- When the traffic aircraft is outside the selected range, the red OFFSCALE message appears.
- When TCAS is unable to track the traffic aircraft's bearing, the red RA symbol is displayed below the TRAFFIC message.

Traffic Advisories (TA) and Displays

A Traffic Advisory (TA) is a prediction that traffic aircraft will enter the TCAS collision airspace within approximately 35 to 40 seconds. TAs are intended to assist the crew in establishing visual contact with the traffic aircraft.

When TCAS issues a TA:

- a voice alert sounds
- symbology is displayed

Voice Alert

When a TA is predicted, TRAFFIC, TRAFFIC sounds once.

Display Symbology

The TA traffic symbol is a filled amber circle with an accompanying data tag when the traffic aircraft is providing altitude information.

The data tag appears in amber and contains the following information about the traffic aircraft:

- a two-digit number preceded with a "+" or a "-" sign and positioned above or below the TA symbol. This number represents, in hundreds of feet, the relative vertical position and altitude difference between the airplane and the traffic aircraft.
- a vertical arrow appears to the right of the TA symbol when the traffic aircraft is either climbing or descending in excess of 500 feet per minute.

The TA is displayed as follows:

HSI

- When the amber TRAFFIC message appears and the traffic aircraft is within the selected display range, the traffic symbol's relative position is displayed.
- When TCAS is unable to track the traffic aircraft's bearing, the amber TA symbol is displayed below the TRAFFIC message.
- When the traffic aircraft is outside the selected range, the amber OFFSCALE message appears.

Automatic TA and RA Display

TCAS automatically displays RA and TA symbols on the HSI when:

- a RA or TA occurs, and
- neither pilot has pushed the EFIS Traffic (TFC) Switch, and
- the HSI Mode Selector is in the VOR, APP, or MAP mode, and
- the TCAS Mode Selector is in TA ONLY or TA/RA

Proximate Traffic and Other Traffic Displays

Proximate Traffic is a traffic aircraft that is neither a RA nor a TA but is within:

- six miles laterally, and
- 1,200 feet vertically

Other Traffic is a traffic aircraft that is neither a RA, TA, or Proximate Traffic

When TCAS identifies Proximate Traffic or Other Traffic:

- symbology is displayed

Display Symbology

The Proximate Traffic symbol is a filled diamond and the Other Traffic symbol is a hollow diamond. Both Proximate Traffic and Other Traffic symbols are displayed with an accompanying data tag when the traffic aircraft is providing altitude information.

The data tag contains the following information about the traffic aircraft:

- a two-digit number preceded with a "+" or a "-" sign and positioned above or below the Proximate or Other Traffic symbol. This number represents, in hundreds of feet, the relative vertical position and altitude difference between the airplane and the traffic aircraft.
- a vertical arrow appears to the right of the Proximate or Other Traffic symbol when the traffic aircraft is either climbing or descending in excess of 500 feet per minute.

Proximate Traffic and Other Traffic are displayed as follows:

HSI

- When Proximate Traffic is within the selected display range, the traffic aircraft's relative position is displayed as a filled white diamond.
- When Other Traffic is within the selected display range, the traffic aircraft's relative position is displayed as an unfilled white diamond.

TCAS Voice Annunciations

Voice Annunciations for ADI Guidance

| Voice Annunciation | Condition | Response |
|---------------------------------|---|--|
| TRAFFIC, TRAFFIC | TCAS has issued a TA | Attempt to visually locate the traffic |
| CLIMB, CLIMB | Present ADI pitch attitude is within the red RA regions | Adjust ADI pitch attitude to remain outside the red RA regions |
| DESCEND, DESCEND | Present ADI pitch attitude is within the red RA regions | Adjust ADI pitch attitude to remain outside the red RA regions |
| ADJUST VERTICAL SPEED ADJUST | TCAS requires change in pitch attitude Present ADI pitch attitude is within the red RA regions | Adjust ADI pitch attitude to remain outside the red RA regions |
| MONITOR VERTICAL SPEED | Present ADI pitch attitude is outside the red RA regions | Continue to keep ADI pitch attitude outside the red RA regions |

767 Flight Crew Operations Manual

| Voice Annunciation | Condition | Response |
|--|--|---|
| MAINTAIN VERTICAL SPEED MAINTAIN | Present ADI pitch attitude is outside the red RA regions | Continue to keep ADI pitch attitude outside the red RA regions |
| CLIMB, CROSSING CLIMB CLIMB, CROSSING CLIMB | Present ADI pitch attitude is within the red RA regions Airplane will climb through the traffic aircraft's altitude | Adjust ADI pitch attitude to remain outside the red RA regions |
| MAINTAIN VERTICAL SPEED CROSSING MAINTAIN | Present ADI pitch attitude is outside the red RA regions Airplane will pass through the traffic aircraft's altitude | Continue to keep ADI pitch attitude outside the red RA regions |
| DESCEND, CROSSING DESCEND DESCEND, CROSSING DESCEND | Present ADI pitch attitude is within the red RA regions Airplane will descend through the traffic aircraft's altitude | Adjust ADI pitch attitude to remain outside the red RA regions |
| INCREASE CLIMB, INCREASE CLIMB | TCAS requires change in pitch attitude | Adjust ADI pitch attitude to remain outside the red RA regions |
| INCREASE DESCENT, INCREASE DESCENT | Present ADI pitch attitude is within the red RA regions | |
| CLIMB, CLIMB NOW CLIMB, CLIMB NOW | Previous vertical guidance was to descend Present ADI pitch attitude is within the red RA regions | Climb and adjust ADI pitch attitude to remain outside the red RA regions |
| DESCEND, DESCEND NOW DESCEND, DESCEND NOW | Previous vertical guidance was to climb Present ADI pitch attitude is within the red RA regions | Descend and adjust ADI pitch attitude to remain outside the red RA regions |
| ADJUST VERTICAL SPEED ADJUST | Minimum ADI pitch attitude required to ensure separation has decreased Present ADI pitch attitude is outside the red RA regions | Adjust ADI pitch attitude Continue to keep ADI pitch attitude outside the red RA regions |

| Voice Annunciation | Condition | Response |
|--------------------|---|---|
| CLEAR OF CONFLICT | <p>Vertical guidance is no longer displayed and traffic symbology changes to TA</p> <p>Separation between the airplane and the traffic aircraft is increasing</p> <p>CLEAR OF CONFLICT will not sound if TCAS can no longer predict the track of the traffic aircraft</p> | Attempt to visually locate the traffic aircraft |

Inhibits

INCREASE DESCENT RAs are inhibited below approximately 1,450 feet radio altitude.

DESCEND RAs are inhibited below approximately 1,100 feet radio altitude.

RAs are inhibited below approximately 1,000 feet radio altitude. Below approximately 1,000 feet when the TA/RA mode is selected on the transponder panel, the TA mode is enabled automatically. All TCAS voice annunciations are inhibited below approximately 500 feet radio altitude.

Note: All TCAS alerts are inhibited by the following

- PWS Annunciations
- GPWS Immediate-Alert Annunciations
- Windshear Immediate-Alert Annunciations

Non-Normal Operations

HSI Messages

When the HSI message:

- TCAS OFF is displayed, neither TA ONLY nor TA/RA is selected with the TCAS Mode Selector. The system cannot display symbology or vertical guidance. Voice Annunciations will not occur.
- TCAS FAIL is displayed, the system cannot display symbology or vertical guidance. Voice Annunciations will not occur.
- TCAS OFF does not display if TCAS FAIL is annunciated.

EICAS Messages

When the EICAS advisory message:

- TCAS is displayed, the system cannot display symbology or vertical guidance. Voice annunciations will not occur.
- TCAS OFF is displayed, neither TA ONLY nor TA/RA is selected with the TCAS Mode Selector. The system cannot display symbology or vertical guidance. Voice annunciations will not occur.

Note: The TCAS OFF message is inhibited below approximately 400 feet radio altitude.

Intentionally
Blank

Warning Systems EICAS Messages

The following EICAS messages can be displayed.

GPWS

| Message | Level | Light | Aural | Condition |
|---------------|----------|-------|-------|--|
| ALT CALLOUTS | Advisory | | | Altitude callouts are no longer provided. |
| GND PROX SYS | Advisory | | | Ground proximity alerts may not be provided. |
| TERR OVRD | Advisory | | | Ground proximity terrain override switch is in OVRD. |
| TERR POS | Advisory | | | Terrain position data has been lost. |
| WINDSHEAR SYS | Advisory | | | Windshear alerts may not be provided. |

TCAS

| Message | Level | Light | Aural | Condition |
|----------|----------|-------|-------|--|
| TCAS | Advisory | | | The TCAS system is inoperative. |
| TCAS OFF | Advisory | | | The TCAS system is off. Inhibited below 400 feet radio altitude. |

Configuration

| Message | Level | Light | Aural | Condition |
|---------|---------|--------|-------|--|
| FLAPS | Warning | CONFIG | Siren | Flaps are not in a takeoff position when either engine's thrust is in the takeoff range on the ground. |

| Message | Level | Light | Aural | Condition |
|---------------|---------|--------|-------|---|
| GEAR NOT DOWN | Warning | CONFIG | Siren | Any landing gear is not down and locked when either thrust lever is closed below 800 feet radio altitude or when flaps are in a landing position. |
| PARKING BRAKE | Warning | CONFIG | Siren | Parking brake is set when either engine's thrust is in the takeoff range on the ground. |
| SPOILERS | Warning | CONFIG | Siren | Speedbrake lever is not DOWN when either engine's thrust is in the takeoff range on the ground. |
| STABILIZER | Warning | CONFIG | Siren | Stabilizer is not within the greenband when either engine's thrust is in the takeoff range on the ground. |

Miscellaneous

| Message | Level | Light | Aural | Condition |
|----------------|----------|-----------|--------|---|
| ALTITUDE ALERT | Caution | ALT ALERT | Beeper | Airplane has deviated from the selected altitude. |
| EICAS CONT PNL | Advisory | | | EICAS control panel is inoperative. |
| EICAS DISPLAY | Advisory | | | One EICAS CRT is inoperative. |
| OVERSPEED | Warning | OVSPD | Siren | Airspeed has exceeded Vmo/Mmo. |