

# **A330 & A340**

## ***Flight Crew Training Manual***





## MODEL NUMBERS

The aircraft models listed in the table below are covered in this Flight Crew Training Manual.

MODEL	
A330-300	A333
A340-300	A343
A340-600	A346

Model numbers are used to distinguish information peculiar to one or more, but not all of the aircraft. Where information applies to all models, no reference is made to individual model numbers.

## DESCRIPTION

The Flight Crew Training Manual provides information and recommendations on manoeuvres and techniques. The manual is divided into 10 chapters:

1. FCTM Presentation.
2. General Information.
3. Pre-start, Start And Taxi.
4. Take-off And Initial Climb.
5. Climb, Cruise And Descent.
6. Holding And Approach.
7. Landing, Go-around & Taxi-in.
8. Non-normal Operations.
9. COMMS & NAV.
10. Training Guide.

Chapter 2 covers procedures and techniques not associated with a particular manoeuvre or phase of flight. Chapters 3 to 7 are titled by phase of flight and contain information about aircraft operations in that phase including, where appropriate, operations in adverse weather conditions. Chapter 8 covers non-normal situations and manoeuvres associated with all phases of flight. Chapter 9 covers operational information on use of communications and navigation equipment and TCAS. Chapter 10 contains further information to clarify standard call-outs, the Company briefing guide and visualisations of the flow patterns of the Nps.



The FCTM describes how to operate the Airbus with descriptions of operational techniques. It also includes background information of a more technical nature for reference. Some of the chapters have a preface, describing the chapter in detail for ease of reference. There is an alphabetical index at the back of the manual. The FCTM supplements the FCOM and other Company publications and must be read in conjunction with those manuals. If areas of conflict are encountered, the FCOM and other Company publications are the over-riding authorities.

CX Policy is contained in FCOM 3, where applicable and Operations Manual Volume 2 Part 2.

The FCTM is intended to provide information in support of procedures detailed in the Operations Manuals and techniques to help the pilot accomplish these procedures safely and efficiently. The FCTM is written in a format that is more general than the Operations Manual. It does not account for aircraft configuration differences, unless these differences have an impact on the procedure or technique being discussed.

In the case where a procedure or technique is applicable only to an aircraft with a specific configuration, colour coding is used referring to the specific model.

## **SUGGESTIONS AND FEEDBACK**

All FCTM holders and users are encouraged to submit questions and suggestions regarding this manual via GroupWise to CP(A) or through IntraCX > FOP > All Fleets: Home > Crew Tools > Manuals Feedback.

<https://iconnect.cathaypacific.com/flightcrew/0,8385,14771,00.html>



## **TABLE OF CONTENTS**

### **General Information**

#### **General**

Preface.....	2.10.1
Manual Structure.....	2.10.1
Operational Philosophy.....	2.10.2

#### **Autopilot/Flight Director**

General.....	2.20.1
AP And A/THR Disconnect.....	2.20.1
Flight Mode Annunciator.....	2.20.2
Reversion And Automatic Speed Protection Modes.....	2.20.2
Triple Click.....	2.20.3
Interface.....	2.20.3
FCU Handling.....	2.20.3
Flight Directors.....	2.20.3
Non-normal Configurations.....	2.20.4

#### **ECAM Philosophy And Use**

General.....	2.30.1
Flight Phase Specific Pages.....	2.30.2
ECAM Handling.....	2.30.2
Use Of Summaries.....	2.30.9

#### **CRM And TEM**

Crew Resource Management (CRM).....	2.40.1
Threat And Error Management (TEM).....	2.40.1

#### **Operating Policy**

Callouts.....	2.50.1
Standard FMA Callouts.....	2.50.1
Standard Phraseology.....	2.50.1



## **Flight Controls**

General.....	2.60.1
Normal Law .....	2.60.1
Alternate Law .....	2.60.10
Direct Law .....	2.60.11
Backup System .....	2.60.11
Abnormal Attitude Law .....	2.60.12

## **Thrust Control**

General.....	2.70.1
Manual Thrust Control.....	2.70.1
Autothrust.....	2.70.2
Autothrust Operational Aspects.....	2.70.5

## **Flight Path Vector**

General.....	2.80.1
Information Presentation .....	2.80.1
Practical Uses Of The FPV .....	2.80.2
FPV Considerations .....	2.80.4



## **PREFACE**

This chapter provides the following general information on Airbus design concepts and features:

- Manual Structure
- Operational Philosophy
- Autopilot/Flight Director
- ECAM Philosophy and Use
- CRM/TEM
- Operating Policy
- Flight Controls
- Thrust Control
- Flight Path Vector

## **MANUAL STRUCTURE**

FCOM 1 provides technical system information.

FCOM 2 provides selected performance and loading data for flight preparation.

FCOM 3 contains the Limitations, Non-normal Procedures, Bulletins, Normal Procedures (NPs), Supplementary Procedures (SPs), Operational Engineering Bulletins (OEBs) and FCOM Bulletins. The NPs set out the policy and philosophy for the Airbus operation. The NPs ensure a standard operation based on common phraseology and techniques whereas SPs cover situations that do not occur on a regular basis, e.g. manual engine start.

FCOM 4 contains information relating to the design philosophy and operation of the FMGS.

The QRH contains Non-Normal checklists, OEBs and Non-Normal manoeuvres.

The MEL details which aircraft systems may be unserviceable prior to flight and must be consulted if a reference is specified in the Aircraft Maintenance Log. The MEL is a Company document that uses the Airbus Master MEL (MMEL) as its source. Regulatory requirements dictate that the MEL must be at least as restrictive as the MMEL.



## **OPERATIONAL PHILOSOPHY**

The NPs are set out in a logical sequence and provide the structure around which crew base their operation in order to provide a common standard. Flow patterns are designed to allocate actions to each crew member to share the workload. By following the flow patterns, each crew member ensures that all actions necessary for any particular phase of flight have been accomplished prior to the completion of the relevant checklist. Normal checklists are of the "non-action" type, i.e. all actions should be completed from memory prior to the checklist being called for. The response to a checklist item confirms that the correct action has already been carried out.

SPs are accomplished only when required.

Non-Normal checklists are provided to deal with and resolve non-normal situations on the ground or in flight and are located in FCOM 3. By contrast to normal checklists, Non-Normal checklists are of the "action" type, i.e. the "read and do" philosophy applies.



## **GENERAL**

The autopilot is designed to fly the aircraft within the normal flight envelope. It can be engaged shortly after take-off and is certified to Cat 3B limits. The autopilot is engaged using the push-buttons (pbs) on the FCU and should be disconnected using the take-over pb on the sidestick.

The autopilot automatically disengages if the aircraft flies significantly outside the normal flight envelope limits.

## **AP AND A/THR DISCONNECT**

When the AP is disconnected using the takeover pb on the sidestick, the audio and visual alerts (cavalry charge, master warning light, ECAM message) are cancelled by a second push of the sidestick priority pb. Similarly, when the A/THR is disconnected using the instinctive disconnect pb on the thrust levers, the audio and visual alerts (single chime, master caution light, ECAM message) are cancelled by a second push of the instinctive disconnect pb. In both cases, allow sufficient time between these successive actions to ensure that the alerts are triggered, thereby ensuring that all crew are clearly alerted to the AP or A/THR disconnect action.





## FLIGHT MODE ANNUNCIATOR

The FMA is located at the top of the PFD screens. It is divided into 5 columns which indicate the operational modes of the AP, A/THR and FD. The columns are numbered from the left and indicate the following:

A/THR Mode and Messages	AP/FD Vertical Mode	AP/FD Lateral Mode	Approach Capability and DH or MDA	AP/FD and A/THR Engagement Status
-------------------------------	---------------------------	--------------------------	--	--

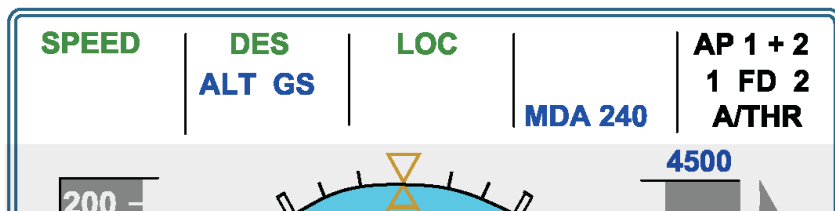

FMA Overview

Mode changes on the FMA are called by the PF, then cross-checked and confirmed by the PNF.

As a means of attracting the crew's attention to a change on the FMA, a white box is displayed for 10 seconds around each new annunciation. In the case of a mode reversion, e.g. LOC/GS to HDG/V/S, the box is displayed for 15 seconds and is accompanied by a "triple click" aural warning.

## REVERSION AND AUTOMATIC SPEED PROTECTION MODES

A mode reversion is when the AP and/or A/THR modes change automatically to ensure mode compatibility. The new mode is displayed on the FMA and depending upon the reversion, is sometimes accompanied by triple click. When a mode reversion occurs, the FMA should be announced in the normal manner. If required, take the appropriate action to correct the flight path.

In some circumstances, to prevent an inappropriate speed trend, the AP may temporarily abandon a vertical speed target to prevent the speed from either reducing below VLS or from exceeding VMAX. In this case, the FMA modes do not change, however the V/S indication on the FMA pulses and is boxed amber, and a triple click is generated.

FCOM 1.22.30 refers.



## TRIPLE CLICK

The "triple click" is an aural alert designed to draw the pilots attention to the FMA. The FMA highlights a mode change or reversion with a white box around the new mode, and the pulsing of its associated FD bar.

The triple click aural alert also occurs in the following less common cases:

- Reversion to CLB (OP CLB) mode, if the pilot selects a speed on the FCU while in SRS.
- Inhibition of V/S mode engagement, if the pilot pulls the V/S knob while in ALT\*.
- Automatic speed protection at VLS/VMAX if the V/S target is not followed because the selected target is too high.

## INTERFACE

The AP can be handled in two ways; "selected" for short-term guidance and "managed" for long-term guidance. Short-term guidance applies to actions that are carried out by the pilot on the FCU, e.g. in response to an ATC instruction. Long-term guidance applies to instructions that have been programmed into the FMGS, e.g. the flight plan. Whichever method of management is being used, the crew must monitor AP performance through FMA indications and aircraft response.

## FCU HANDLING

When making selections on the FCU, locate the appropriate selector and then make any change with reference to the PFD, ND or FMA as appropriate. This method ensures that the correct target is set for the AP and/or FD.

When the AP is flying the aircraft, the PF makes the selections on the FCU. When hand flying the aircraft, the PF requests the PNF to make the required selections on the FCU.

## FLIGHT DIRECTORS

The FDs are normally selected on when the aircraft is being flown by the AP. The FDs give a visual indication of the AP performance. If it is suspected that the AP/FD is not giving correct or accurate guidance, disconnect the AP, request the PNF to select both FDs off and fly the aircraft manually. In this case, the FPV should be selected.

When flying manually, either follow the FDs or direct the PNF to select them both off. This ensures that the A/THR, if active, will operate in SPEED mode.



## **NON-NORMAL CONFIGURATIONS**

With one engine inoperative, the AP can be used throughout the entire flight envelope without any restriction, including autoland.

In non-normal configurations, e.g. no flaps or no slats, the AP can be used down to 500 ft AAL on approach. In such cases, be ready to intervene manually should AP performance be unsatisfactory.



## GENERAL

The ECAM monitors and displays all information concerning aircraft systems as well as system failures. It is a system which, through text and graphic displays, enables the crew to accomplish a variety of tasks, from monitoring cabin temperature to dealing with multiple failures, without the need for paper checklists.

Most warnings and cautions are inhibited during critical phases of flight (TO INHIBIT and LDG INHIBIT), because most system failures will not affect the aircraft's ability to continue a take-off or landing.

One of the major advantages of the ECAM is that it displays specific information only when required, including flight phase specific pages. The ECAM provides the following:

- System monitoring as follows:
  - Normal mode, which is flight phase related for system and memo display.
  - Failure mode, which automatically displays the appropriate non-normal procedure along with the associated system synoptic.
  - Advisory mode, which automatically displays the appropriate system synoptic associated with a drifting parameter. FCOM 3 and QRH contain recommended actions in the event of certain advisory conditions.
  - Manual mode, which enables the pilot to manually select any system synoptic via the ECAM control panel.
  - Memo, which displays the take-off and landing memos at the appropriate time as well as the status of a number of systems that are selectable by the crew, e.g. Engine Anti-Ice. Memo should be included in the pilots routine scan.
  - ECAM warnings – in the event of a failure, the E/WD displays crew actions necessary to deal with the failure, replacing the traditional QRH. When the correct action has been carried out the applicable line of the ECAM checklist will, on most occasions, be cleared. However, be aware that not all action lines are cleared by carrying out the required switch/pb action, e.g. GPWS OFF is non-reactive.
  - Status – the STATUS page provides an operational summary of the aircraft systems at any stage of the flight and specifically following a failure. If STS is displayed on the E/WD, the STATUS page is automatically displayed on the SD when Flap 1 is selected for the approach or when QNH is set during descent, whichever occurs first.



The ECAM control panel is described in FCOM 1.31.30. The operational use of the Emergency Cancel (EMER CANC) and Recall (RCL) pbs is as follows:

- The EMER CANC pb may be used to cancel any cautions that are considered nuisance cautions, or are displayed as a result of an acceptable defect with the aircraft having been dispatched under the MEL. This is indicated on the STATUS page under the CANCELLED CAUTION title.
- The RCL pb is used to either recover cancelled cautions suppressed by the EMER CANC pb or to review warnings or cautions which have been cleared using the CLR pb.
- The EMER CANC pb may also be used to inhibit any aural alert associated with a red warning, but it does affect the warning itself on the E/WD.

## FLIGHT PHASE SPECIFIC PAGES

On the SD, some pages are phase specific, e.g. the WHEEL page is automatically displayed after engine start. The CRUISE page is not selectable but is continuously displayed from 1500 ft after take-off to landing gear extension unless a warning or caution is displayed, or a system page has been manually selected.

The Take-off and Landing memos are only displayed at the appropriate time. The final item on either the Before Take-off checklist or the Landing checklist is to confirm that no blue item is present on the memo, which would indicate that a particular action had not been carried out. Before responding "no blue", ensure that the correct memo is displayed by reference to the memo title, i.e. T.O. or LDG. In certain circumstances, e.g. a base training circuit, the LDG MEMO will not automatically appear. In this case, the PNF shall read the FINAL ITEMS, including each item of expanded LDG MEMO, from the checklist when the aircraft is fully configured for landing.

## ECAM HANDLING

### General

When carrying out ECAM procedures, both pilots must be aware of the present display. Before any "clear" action, both pilots shall crosscheck the ECAM display to confirm that no blue action lines remain that can be eliminated by direct action, other than those actions that are not sensed by ECAM, e.g. thrust lever at idle when the FADEC is not powered.

### Advisories

The crew should review the drifting parameter on the corresponding SYSTEM page. If time permits, the PNF may refer to QRH Part 2, which contains the recommended actions for the various advisory indications.



## Cautions And Warnings

When the ECAM displays a warning or caution the first priority is to maintain a safe flight path. The successful outcome of any ECAM procedure is dependent on the precise reading and actioning of the procedure, maintenance of correct task sharing and deliberate monitoring and cross-checking. It is important to remember the following:

- In case of a failure during take-off, approach or go-around, ECAM actions should be delayed until the aircraft reaches at least 400 ft AAL and is stabilised on a safe trajectory. However, any aural warning should be cancelled using the MASTER WARN pb.
- The PF is to fly the aircraft, navigate and communicate. The use of the AP is strongly recommended.
- The PNF is to deal with the failure on command of the PF. He is responsible for reading aloud and executing the ECAM or checklist actions, which includes manipulation of thrust levers and engine master switches when directed by ECAM or checklist.
- Monitoring & crosschecking remain primary tasks for both PF and PNF.
- ECAM actions may be stopped by the PF at any time, if other specific actions must be performed; e.g. normal checklist, application of an OEB, computer reset. When the action is completed, the PF shall direct to "Continue ECAM".
- At any time, the Captain may take control of the aircraft or order ECAM ACTIONS if he considers it necessary.

Either pilot may cancel an aural warning associated with an ECAM warning or caution, but to initiate the procedure, the PNF reads the message on the E/WD, e.g. "Air, Pack 1 overheat". The PF confirms the failure and states "Confirmed" and then, depending on circumstances, either "Standby" or "I have control, ECAM actions". Before applying ECAM procedures, the fault should be confirmed on the system display.

During ECAM procedures, some selectors must be positively cross-checked by both pilots before movement or selection to prevent the crew from carrying out inadvertent or irreversible actions. These are:

- Thrust lever
- Engine master switch
- Fire switch
- ADIRS panel controls
- All guarded pbs and switches



The PF shall monitor all ECAM/checklist actions. Actions associated with memory items shall be confirmed by the PF when all memory items are complete and the aircraft is stabilized on the desired flight path. This can normally be done by reference to ECAM MEMO. If overhead panel pbs or switch selections are to be made, identification of the correct panel is aided by reference to the system name, written in white at the side of each system panel. The PNF uses the terminology of "System, Procedure/Selector, Action", e.g. "Air, Cross Bleed, close". By using this method and announcing the intended selection prior to execution, the PNF keeps the PF aware of the progress of the procedure. Following a system failure, the associated amber fault light in the system pb on the overhead panel will be illuminated to aid proper identification. When carrying out system switch or pb selection, verify on the SD that the required action has occurred, e.g. closing the Cross Bleed valve changes the indications on the SD.

OEBs are issued by Airbus and contain information that may have implications for crew actions in the event of system failures. The OEBs are located in the QRH. Depending on FWC modification status, some aircraft are fitted with an OEB reminder function and consequently some ECAM procedures have a line that states "REFER TO QRH PROC" rather than an ECAM checklist. In this case, the failure should be handled with reference to the applicable OEB procedure.

When reviewing secondary failures follow the same discipline of request and confirmation before action on the CLR pb.

When all ECAM checklist actions have been completed, the STATUS page is automatically displayed and should be reviewed by both pilots. A green overflow arrow indicates further pages of status messages. To access the remaining lines, press the STS key on the ECP.

Following certain failures, or after multiple failures, the STATUS page may contain an excess of information. In order to extract the information essential for landing the aircraft safely, use the following guide:

- CONFIG – flap/slat setting, approach speed increment, landing distance factor and control law for landing.
- GEAR – when to lower the gear and whether normal or gravity lowering.
- BRAKES – normal, alternate or alternate without anti-skid.
- REVERSE – availability.

When carrying out such ECAM procedures, it is important that both crew members cross-check the applicable landing configuration, approach speed increment and landing distance.

Having completed the ECAM procedures and prior to reviewing the STATUS, ensure that any relevant normal checklists have been actioned. After reviewing the STATUS, refer to OEBs and consider any applicable computer resets.



ECAM procedures and STATUS, supplemented by a check on the PFD/ND are sufficient for handling the fault. If time permits, and when ECAM actions have been completed, refer to FCOM 3 procedure for supplementary information. However in critical situations, do not prolong the flight for the sole purpose of consulting FCOM 3.

When reviewing the STATUS prior to descent, aircraft configuration for landing should be emphasised. During the descent and approach, the PNF should advise the PF of the next abnormal event at a time that will keep crew workload to a minimum. This sequence should be repeated until all items have been reviewed and/or completed. The STATUS page is automatically recalled during descent when QNH is set on the FCU and when slats are extended.

If an ECAM warning disappears during the completion of a procedure, it can be assumed that the warning is no longer relevant and the applicable procedure can be stopped. An example of this would be during an engine fire procedure and the fire was extinguished successfully with the first fire bottle. The Engine Fire warning would go out and the procedure can be stopped. Any remaining ECAM procedures should be handled in the normal manner.

If an ECAM caution disappears during the completion of a procedure, the CLR lights extinguish on the ECP and the STATUS page will not be displayed automatically. If the STS reminder prompt is displayed, the STATUS page will need to be manually selected to check the status items.

## Multiple Cautions And Warnings

Most failures are straightforward and should not present any difficulty when handling the related ECAM procedure. Some failures, however, can produce multiple ECAM procedures and in these cases the following points should be considered:

- Complete all required actions (blue) associated with the first red or amber title.
- Clear the title of the first failure before dealing with next failure. Carry out the second drill until its red/amber title can be cleared, before starting on the third etc.
- Do not leave red or amber titles on the E/WD when all actions associated with that failure have been completed. Clear the title when the applicable actions have been completed.
- When all necessary actions have been completed there will be no red or amber titles displayed on the lower part of the E/WD.





## **ECAM Handling In Single Screen Mode**

All screens are identical, providing redundancy either automatically or by switching. The various options to allow switching of screens in the event of screen failure are detailed in FCOM 1.31.05. In the case of single ECAM display the remaining screen displays the E/WD.

There is no automatic display of the SD page associated with a failure or an advisory and so further analysis of the failure requires the relevant system page pb to be pressed and held. The SD page will temporarily replace the E/WD. This also applies when reviewing secondary failures.

The STATUS page is only displayed when the STS pb is pressed and held. The STATUS page will temporarily replace the E/WD. In order to view more pages of status messages the STS pb must be released for less than 2 seconds and then pressed and held again.

If the STS or system page pb is held for longer than 3 minutes, the display automatically reverts back to the E/WD. Alternatively, the SD and STATUS pages may be transferred to either pilot's ND using the ECAM/ND Transfer Selector. With dual screen mode reestablished once again, ECAM operation is normal.

In the case of failure of both ECAM displays, the E/WD may be transferred to either pilots ND using the ECAM/ND Transfer Selector to establish single screen mode.

In the case of failure of all DMC ECAM channels, the engine parameters can be monitored through the engine standby page, which can be displayed on the ND by selection on the EFIS control panel.



### Example Of Crew Coordination And Crosschecking

WARNING DISPLAY		PILOT FLYING	PILOT NOT FLYING
Master Caution & Single Chime HYDB RSVR OVHT - BLUE ENG 1 PUMP. OFF		<i>Note :</i> Either pilot may press the Master Warning/Caution to reset the warning and cancel any audio.	PRESS MASTER CAUTION READ FAILURE (i.e. "Hydraulics, Blue Reservoir Overheat")
		"Confirmed":  - Confirm the failure. It is not necessary for the PF to repeat the failure title. - If it is necessary to delay the ECAM procedure to a more appropriate time: "Standby" - When ready to initiate the ECAM procedure: "I have control, ECAM actions"	
			ECAM ACTIONS – Read and Do (i.e. "Blue Engine 1 pump ... OFF")
MC and SC  - HYD B RSVR OVHT B SYS LO PR	* F/CTL		PRESS MASTER CAUTION Read resultant failure: (i.e. "Blue System Low Pressure")
			ECAM ACTIONS – Read and Do (i.e. "No action required") Request Clear: "Clear ECAM?"



WARNING DISPLAY		PILOT FLYING	PILOT NOT FLYING
		Confirm Clear: "Clear"	PRESS CLR Pb.
	*F/CTL		Identify Secondary Failure (i.e. "Secondary Failure – Flight Controls") Review Systems Display (i.e. F/CTL) Request Clear: "Clear ECAM?"
		Confirm Clear: "Clear"	PRESS CLR Pb.  – Status page is displayed on SD. "Status?"
STATUS		"Read Status"	Read Status line by line ensuring both pilots understand each item. Note items of specific relevance to the Approach and Landing.
APPR PROC IF BLUE OVHT OUT: – BLUE ENG 1 PUMPON CAT 2 ONLY SLATS SLOW	INOP SYS  BLUE HYD PART SPLR REV 1 CAT 3 ALTN BRK		
			Request Clear: "Clear Status?"
		Confirm Clear: "Clear"	Confirm Clear PRESS CLR Pb.
System display returns to flight phase related page. [STS] remains on E/WD as a reminder that items are listed on the status page.			"ECAM actions complete"



## **USE OF SUMMARIES**

### **General**

The summaries consist of QRH procedures. They have been created to help the crew handle the actions associated with complex failures that involve considerable interaction between ECAM and several paper procedures.

In any case, the ECAM procedure and STATUS review should be applied first. The PNF should refer to the corresponding QRH summary only after announcing "ECAM actions complete".

After performing ECAM actions, the PNF should begin the QRH summary by referring to the CRUISE section, in order to determine the landing distance factor. Since normal landing distances are also given on this page, compute the landing distance taking failure(s) into account, in order to decide whether a diversion is required due to insufficient runway length.

### **Approach Preparation**

As always, approach preparation includes a review of ECAM STATUS. After reviewing the STATUS page, the PNF should once again refer to the CRUISE portion of the summary to determine the  $\Delta VREF$  correction, and compute the VAPP using VLS CONF FULL (VREF) on the MCDU updated for the new destination. A VREF table is also provided in the summary for failure cases leading to the loss of the MCDU.

The LANDING and GO-AROUND sections of the summary should be used for the approach briefing.

### **Approach**

The APPR PROC actions, announced on ECAM STATUS, should be performed by reading the APPROACH section of the summary. This section has been added primarily due to the flap extension procedure, which is not fully addressed by the ECAM. The recommendations provided in this section are comprehensive, and it is not necessary to refer to the "LANDING WITH FLAPS/SLATS JAMMED" paper procedure

After referring to the APPROACH section of the summary, the crew should review the ECAM STATUS, and confirm that all APPR PROC actions have been completed.



### QRH Summary Sequence

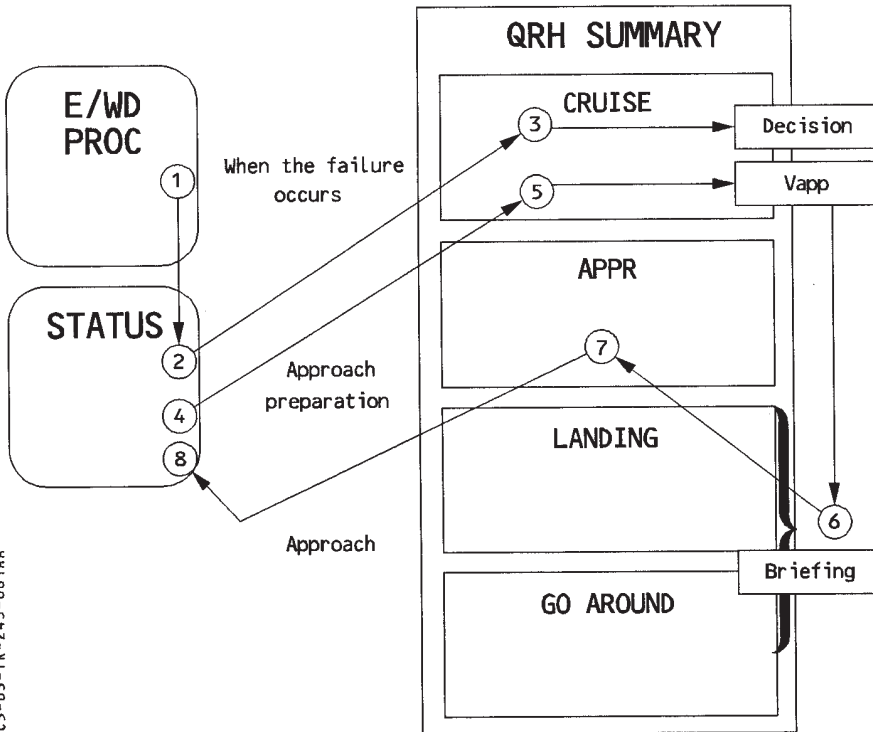

GFC5-03-TR-243-001AA



## **CREW RESOURCE MANAGEMENT (CRM)**

Crew resource management is the application of team management concepts and the effective use of all available resources to operate a flight safely. In addition to the aircrew, it involves all other groups who are involved in the decisions required to operate a flight. These groups include, but are not limited to, aircraft dispatchers, flight attendants, maintenance personnel and air traffic controllers.

Throughout this manual, techniques that help build good CRM habit patterns on the flight deck are discussed. Situational awareness and communications are stressed. Situational awareness, or the ability to accurately perceive what is going on in the flight deck and outside the aircraft, requires on-going questioning, cross-checking, communication and refinement of perception.

It is important that all flight deck crew identify and communicate any situation that appears unsafe or out of the ordinary. Experience has proven that the most effective way to maintain safety of flight and resolve these situations is to combine the skills and experience of all crew members in the decision making process to determine the safest course of action.

## **THREAT AND ERROR MANAGEMENT (TEM)**

### **General**

Threat and error management is the process that effective crews follow to manage the safe and efficient operation of their aircraft. This is the first time that the industry has been able to define airmanship in a practical and simple manner and has now become the governing philosophy that helps guide everything we do in flight operations.

Threats are those contingencies that add additional complexity to the operation and increase the potential for error. They can be obvious ones such as a thunderstorm off the end of the runway or can be seemingly insignificant, such as an ACARS printer failure. All, however, increase the potential for error and all have to be properly managed. Good threat management requires good anticipation, sharing the threat with the other crew and the development of a strategy.

Error management (Resolve Phase) is the tool that the crew use to minimise the consequence of an error. This involves the use of a combination of non-technical (CRM) and technical (operational) skills. At its very core is the importance of monitoring and the ability to challenge once an unsafe situation is detected.



## Monitoring

Effective monitoring requires sensible workload management to ensure that the PNF is not overloaded at a critical phase of flight. This may involve delaying certain tasks to a more appropriate time (Aviate, Navigate, Communicate). Effective monitoring also involves the sharing of a mental model with the PNF. This principle is known as communication of intent. In its simplest form, communications of intent is achieved through the C-TWO departure and arrival briefing.

## Challenge

All crew members have the responsibility to advise the Commander any time that an unsafe or potentially unsafe condition exists. The following strategy is recommended:

- Supportive statement: express personal concern, using standard calls if possible.
- Question: determine the PF's plan, e.g. "Will you be fully stabilised by 1000 ft?".
- Solution: offer an alternative, e.g. "Would you like some extra track miles?".
- Action: "Captain you MUST LISTEN" or, if circumstances require, take over.

However, we must never become over assertive to the extent that we challenge routine decisions. The strategy recommended above is for dealing with unsafe situations only.



## **CALLOUTS**

Avoid casual and non-essential conversation during critical phases of flight, particularly during taxi, take-off, approach and landing. The PF makes callouts based on FMA changes appropriate to the flight mode. The PNF verifies the condition from the FMA and acknowledges. If the PF does not make the required callout, the PNF should make it. There is no competition to see who can be the first to call these changes; the PNF should allow reasonable time for the PF to call and not pre-empt him with every change. The PF should alert the PNF prior to disconnecting the autopilot.

One of the basic fundamentals of CRM is that each crew member must be able to supplement or act as a back-up for the other crew member. Correct adherence to standard callouts is an essential element of a well-managed flight deck. These callouts provide both crew members with the required information about aircraft systems and confirmation of the other crew member's involvement. The absence of a standard callout at the appropriate time may indicate a system malfunction or the possibility of pilot incapacitation.

## **STANDARD FMA CALLOUTS**

FCTM Ch 10 refers.

## **STANDARD PHRASEOLOGY**

FCOM 3 and Vol 2 Pt 2 refer.



INTENTIONALLY  
BLANK



## GENERAL

The Airbus flight control surfaces are moved by commands from several flight control computers in response to pilot input. This system is referred to as "fly-by-wire" as there is no mechanical connection between the sidestick and the control surfaces. The relationship between sidestick input and the aircraft response is called the flight control law. Depending upon the status of the fly-by-wire system, three sets of control laws are provided, i.e. Normal Law, Alternate Law and Direct Law. In the unlikely event of a failure causing a complete loss of the fly-by-wire system, the aircraft can be flown safely through a backup system while the crew complete actions to recover one of the control laws.

Each law has a set of protections and/or warnings which are discussed below.

## NORMAL LAW

Under most circumstances, the aircraft is operated in Normal Law. Normal law is designed to accommodate single system failures and has three modes:

- Ground Mode
- Flight Mode
- Flare Mode

The transition from one mode to the next is transparent to the pilot.

## Ground Mode

On the ground and at low speeds, the sidesticks have full authority over the controls in pitch and roll. Ground mode is progressively blended out after take-off as the flight mode becomes active.

When the aircraft is on the ground, the PFD includes a symbol (1) that is the sum of the sidestick positions given to the flight control computers. It permits the PNF to check that the PF is making the appropriate control input during the take-off roll.

Small limit marks (2) indicate the limits of stick travel ( $\pm 16^\circ$  in pitch,  $\pm 20^\circ$  in roll).

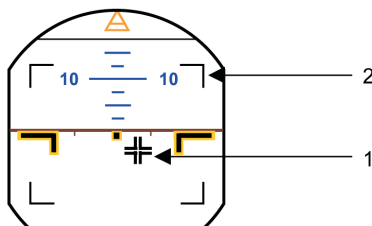

Do not use this display for flight control checks because it does not indicate flight control position.



## Flight Mode

In pitch, when an input is made on the sidestick, the flight control computers interpret this input as a “g” demand/pitch rate. Consequently, elevator deflection is not directly related to sidestick input. The aircraft responds to a sidestick order with a pitch rate at low speed and a flight path rate or “g” at high speed. When no input is made on the sidestick, the computers maintain a 1g flight path. Pitch changes due to changes in speed, thrust and/or configuration, which in a conventional aircraft would require the pilot to re-trim the aircraft, are compensated for by the computers repositioning the THS. The pitch trim wheel moves as the control law compensates for these changes. Sometimes, changes of trim due to changes in thrust may be too large for the system to compensate, and the aircraft may respond to them in pitch in the conventional sense and then hold the new attitude at which it has stabilised after the trim change.

Due to its neutral static stability, the aircraft maintains the selected flight path. Should it deviate however, only small sidestick inputs are required to regain the desired flight path.

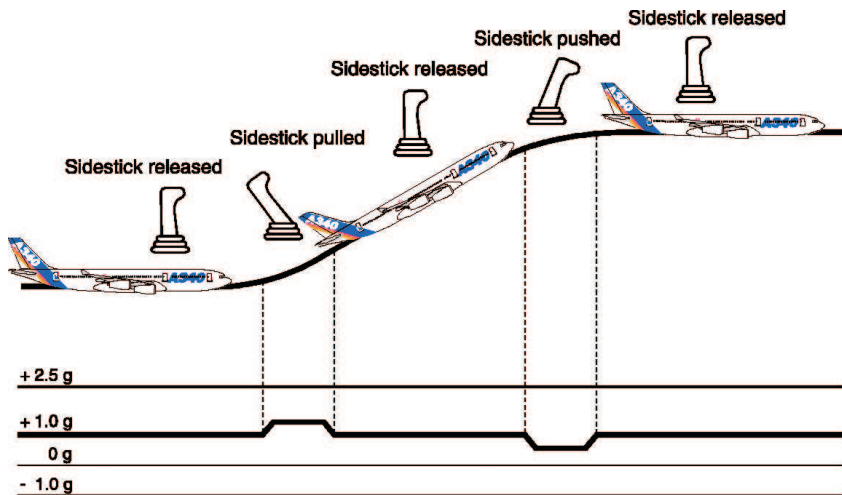

Sidestick Input vs Flight Path



In roll, when an input is made on the sidestick, the flight control computers interpret this input as a roll rate demand. Consequently, aileron and/or spoiler deflection is not directly related to sidestick input. When no input is made on the sidestick, the computers maintain a zero roll rate. At bank angles less than 33° with no input being made on the sidestick, the computers maintain a zero roll rate and, consequently, the aircraft will maintain a constant bank angle. Within this range, there is no need to make a correction in pitch, as this will be compensated for by the computers. Beyond 33° angle of bank, pitch compensation is no longer available. On releasing the sidestick to neutral, the aircraft rolls back to 33° angle of bank.

Due to its neutral static stability, within 33° angle of bank, the aircraft maintains the selected flight path. Should it deviate however, only small inputs are required on the sidestick to regain the desired flight path. The control law provides turn co-ordination, so there is no need to use the rudder.

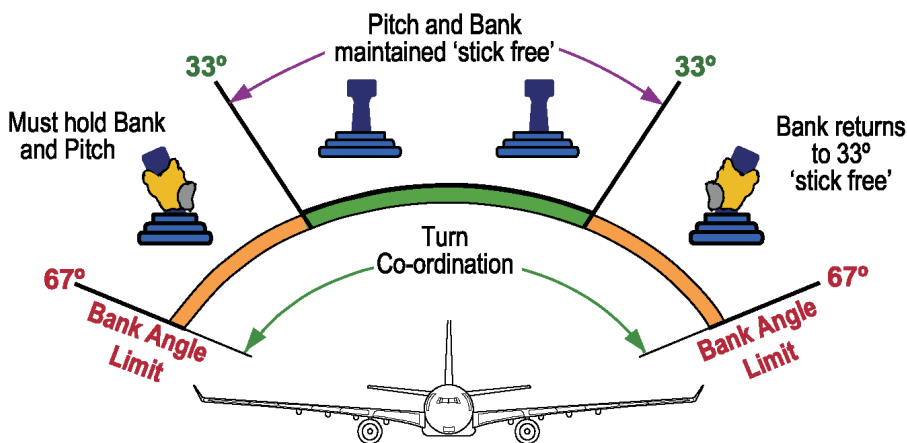

Normal Law - Normal Speed Envelope

As the flight mode is always aiming to achieve the selected flight path, avoid the temptation to over-control. The recommended method to avoid over-controlling is to make a small sidestick input, hold for a short period and then return the sidestick to neutral. Even in turbulent conditions, the control law resists the disturbances well without pilot inputs. The pilot should try to limit his control inputs to that necessary to correct the flight path trajectory and leave the task of countering air disturbances to the flight control system. If the pilot senses an over-control, the sidestick should be released.

In climb, cruise, descent and approach, all these basic rules remain in effect.



## Flare Mode

To perform the flare and landing, the flight controls need to be responsive and linear. Therefore on reaching 100 ft on the approach the pitch law is modified to be a full authority direct law with no auto-trim. A nose down term is introduced which requires the pilot to maintain a backpressure on the sidestick to achieve a progressive flare, as in a conventional aircraft. After touchdown, the control law progressively reverts to ground mode.

## Protections

Normal Law provides five different protections:

- High Angle of Attack Protection
- Load Factor Protection
- High Pitch Attitude Protection
- High Speed Protection
- Bank Angle Protection

The protections are complementary and together work to maintain the aircraft in the safe flight envelope. If an extreme manoeuvre is required, the pilot can make full sidestick inputs in normal law at any speed. This normal law protection does not apply to the rudder as it is not normally used in symmetrical flight.

However, it is important to remember that the normal flight envelope is defined as VLS to VMO/MMO. Pilots should not deliberately fly at a speed outside of the normal envelope unless absolutely necessary for operational reasons.

## High Angle Of Attack Protection

The high angle of attack (AOA) protection allows the pilot to consistently achieve the best lift while preventing the aircraft from stalling.

The following description illustrates a sequence of events that would lead to the activation of the various stages of high AOA protection.

In level flight, if the A/THR is disengaged and thrust set to idle, the aircraft decelerates until the auto-trim stops. This occurs at a predetermined angle of attack called Alpha Prot. The speed that equates to Alpha Prot ( $V_{\alpha}$  PROT) is displayed as the top of a black and amber strip on the PFD speed scale. If no input is made on the sidestick, the aircraft will descend to maintain its current AOA ( $V_{\alpha}$  PROT). To maintain the flight path, the pilot must increase the backpressure on the sidestick, which also provides a tactile indication that auto-trim has stopped. At  $V_{\alpha}$  PROT, AOA protection becomes active and, if the sidestick is released to neutral and no thrust applied, the aircraft will gently descend maintaining  $V_{\alpha}$  PROT. When AOA protection is active, the speed brakes retract automatically, if previously extended, and the bank angle limit is reduced from 67° to 45°.

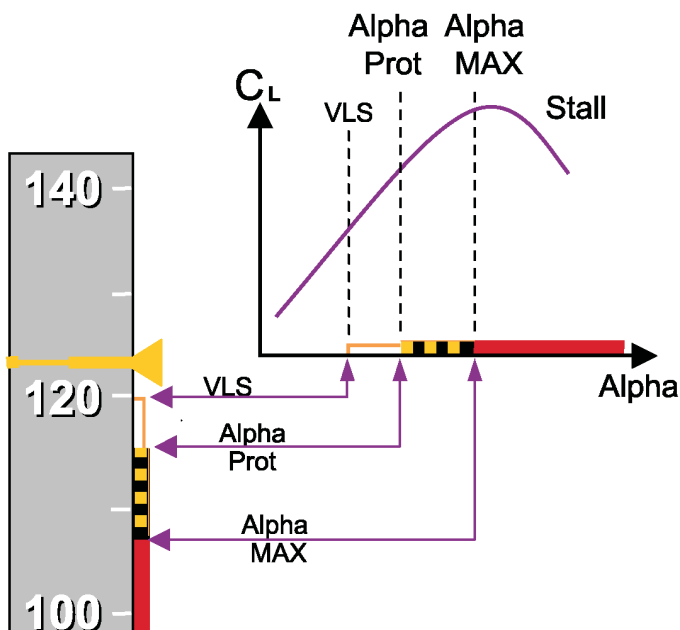

High Angle of Attack Protection Airspeed Tape Indications

If the pilot maintains the backpressure, Alpha Floor (covered below) will activate. If the pilot disconnects the A/THR while maintaining full back stick, Alpha Max may be reached. The speed which equates to Alpha Max ( $V_{\alpha \text{ MAX}}$ ) is displayed as the top of the red strip on the PFD speed scale. Alpha Max is close to, but short of the 1g stall. When flying at  $V_{\alpha \text{ MAX}}$ , the pilot can make gentle turns if necessary. In turbulence, airspeed may fall temporarily below  $V_{\alpha \text{ MAX}}$  without significant effect.

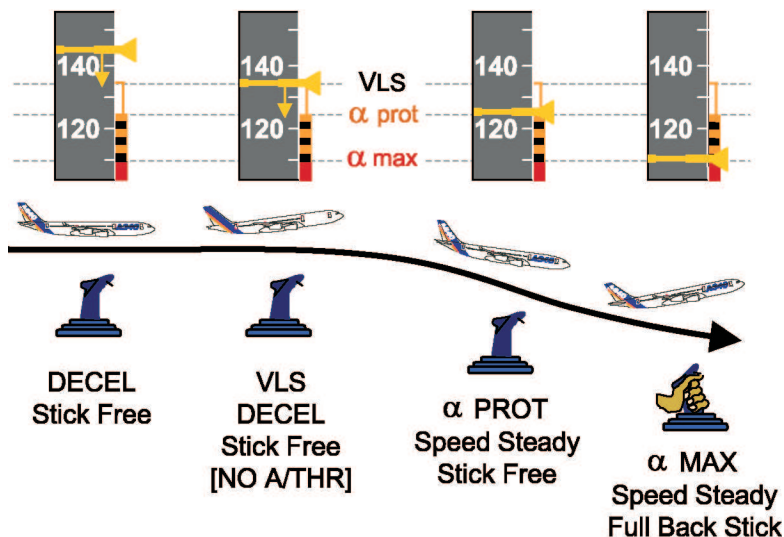

### Airspeed Tape Indications (Deceleration with no A/THR)

These features are aerodynamic protections. Additionally, there are three energy features that enhance these protections:

- With the A/THR engaged, the aircraft will not decelerate below VLS (displayed as top of amber strip) even if the target speed is selected below VLS.
- A low energy aural warning is triggered when the aircraft energy level is below a given threshold. This energy level is a function of several parameters including aircraft configuration, speed, horizontal deceleration rate, flight path angle and altitude. (FCOM 1.27.20 refers) The aural warning "SPEED, SPEED, SPEED" alerts the pilot of the requirement to adjust thrust and flight path. It is triggered during deceleration before Alpha Floor (unless Alpha Floor is triggered by stick deflection). The delay between the aural warning and Alpha Floor activation is a function of deceleration rate.
- If Alpha Prot is reached and the pilot still maintains aft sidestick, Alpha Floor protection (set between Alpha Prot and Alpha Max) will be reached. This protection triggers the application of TOGA thrust and the aircraft will start to climb at a relatively constant low airspeed. Alpha floor protection is inhibited in some cases. FCOM 1.22.30 refers.

The aircraft can also enter alpha protection at high altitude, where it protects the aircraft from the buffet boundary. The PFD shows that alpha protection is active in the same way as at low speed and low level: the amber and black strip rises to the actual speed of the aircraft. As at low speed and low level, if the stick is merely released to neutral the aircraft maintains the alpha for alpha protection.



## Load Factor Protection

On most commercial aircraft, the maximum load factor range is 2.5g/-1g clean and 2g/0g with slats and/or flaps extended. The load factor protection is designed to maintain the aircraft within these limits while allowing the crew to consistently achieve the best achievable aircraft performance, if required.

On commercial aircraft, high load factors are most likely to be encountered when the pilot responds to a GPWS warning. Airline pilots are not accustomed to using "g" as a flying parameter and experience has shown that, in emergency situations, the application of "g" is initially hesitant and then aggressive. If a GPWS alert is generated which requires an immediate pull-up, full back stick should be applied and maintained. The load factor protection will allow maximum "g" to be achieved in the shortest time while preventing the aircraft from being overstressed.

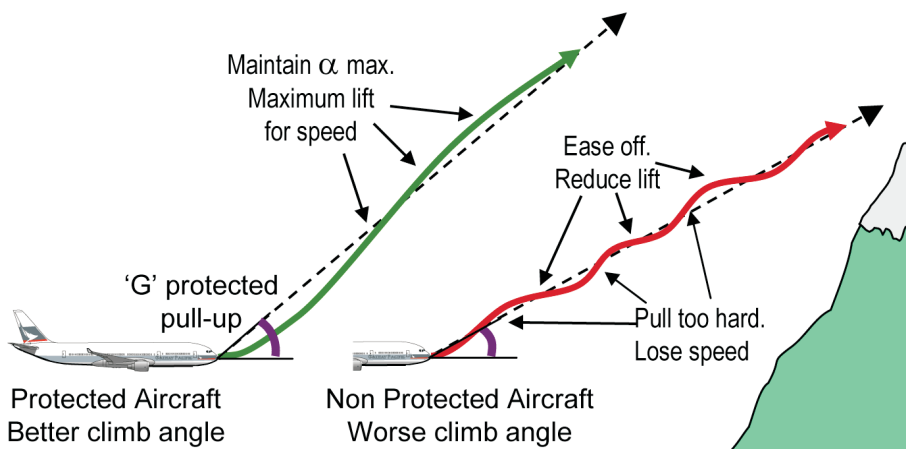

### Protected/Non-Protected Aircraft Climb Angle Comparison

If the pilot maintains full aft stick because the danger still exists, the high AOA protection will eventually take over. This is one instance where load factor protection is enhanced by the high angle of attack protection.



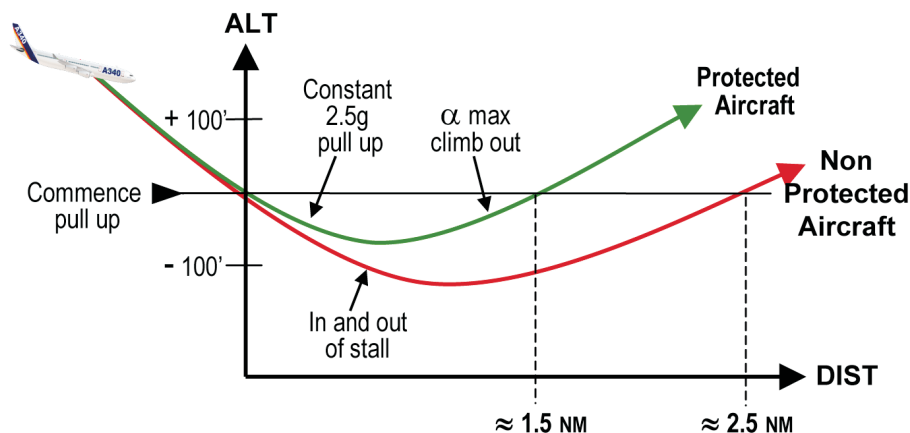

**CIFT Escape Manoeuvres on Protected and Non-Protected Aircraft**

### High Pitch Attitude Protection

Excessive pitch attitudes, caused by upsets or inappropriate manoeuvres, lead to hazardous situations. Even the most extreme emergency situations do not require flying at excessive pitch attitude. For this reason, high pitch attitude protection has been designed to be part of the flight control system. The high pitch attitude protection limits the pitch attitude to  $+30^{\circ}/-15^{\circ}$ . The  $30^{\circ}$  limit decreases to  $25^{\circ}$  at low speed. If the aircraft approaches these limits, the pitch and roll rates start to decrease  $5^{\circ}$  before the limit so that it will stop at the limit without overshooting.

### High Speed Protection

Beyond the maximum design speed of the aircraft,  $V_{D}/M_{D}$  (which is greater than  $V_{M}/M_{M}$ ), there are potential aircraft control problems due to high air loads. Therefore the margin between  $V_{D}/M_{D}$  and  $V_{M}/M_{M}$  must be such that any possible overshoot of the normal flight envelope does not cause controllability problems.

In order to protect the aircraft from dangerous phenomena at high speed, a positive nose up "g" demand up to  $1.75g$  is added to the pilot demand on the sidestick when exceeding  $V_{M}/M_{M}$ . Additionally, if the side stick remains forward, the sidestick nose down pitch authority is smoothly reduced to zero at approximately  $V_{M} + 16/M_{M} + 0.04$ . With reference to the diagram below, if a dive is achieved with stick free, the aircraft will slightly overshoot  $V_{M}/M_{M}$  and fly back into the flight envelope. If a dive is achieved with the sidestick fully forward, the aircraft will significantly overshoot  $V_{M}/M_{M}$  but without reaching design speed limits,  $V_{D}/M_{D}$ .



When high speed protection is triggered, the autopilot disconnects, the pitch trim is frozen, the spiral static stability is reduced from 33° to 0° of bank and the limit bank angle is reduced from 67° to 45°. If high speed protection is active with the aircraft established in a turn, when the sidestick is released the aircraft will roll wings level. This increased spiral stability reduces the risk of a spiral dive.

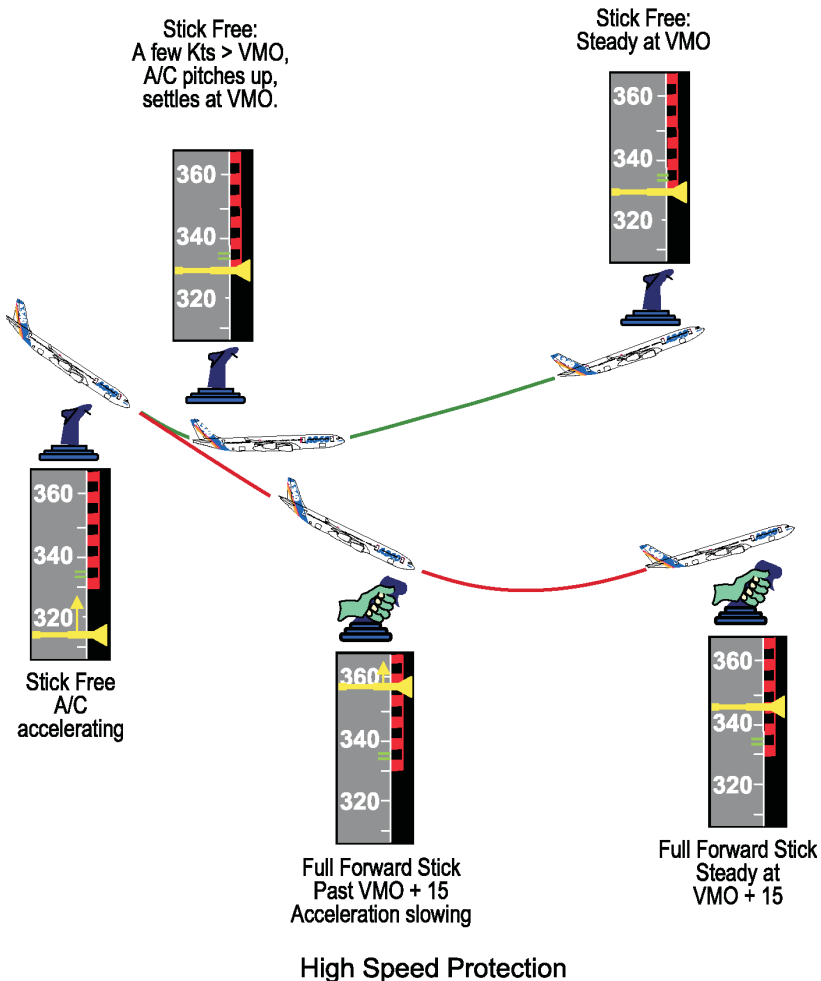



## Bank Angle Protection

On commercial aircraft, 30° bank angle is normally not to be exceeded. A bank angle of 67° in level flight corresponds to the aircraft limit of 2.5 g. Therefore, 67° has been established as the bank angle limit. Approaching this limit, the roll rate is progressively reduced to avoid over-banking.

This 67° bank angle limit is reduced to 45° in case of high speed protection.

## ALTERNATE LAW

In some cases of double failure, e.g. double hydraulic failure, the integrity and redundancy of the computers and other required systems are not sufficient to achieve normal law with its protections. In this case, Alternate Law is triggered. VLS remains, but  $\alpha$  prot and  $\alpha$  max disappear, replaced by a single black and red strip, the top of which is the stall warning speed VSW. Unlike VLS which is stable, VSW is g sensitive so as to indicate margin above stall during turns. The autopilot may be available depending on the cause and type of failure(s). During landing, alternate law reverts to direct law at 100 ft RA.

If the aircraft is operated outside the normal flight envelope, the pilot must take appropriate corrective action to avoid losing control and/or to avoid high speed excursions, since the normal law protection features may not be available.

## Handling Characteristics

In pitch, handling remains similar to normal law.

In roll, depending on the failure level, control is either normal (ALTN 1) or direct (ALTN 2). In roll direct, the aircraft appears to be very sensitive and bank stability is no longer active.

## Protections

In Alternate Law the protections change as follows:

- High angle of attack protections are replaced by stall warning at 1.03 VS1g
- The load factor protection is maintained
- The pitch attitude protection is lost
- The high speed protection is replaced by overspeed warning
- The bank angle protection is maintained if roll is normal (ALTN 1) but lost in roll direct (ALTN 2)



## **DIRECT LAW**

In most cases of triple failure, e.g. triple ADR failure, direct law is triggered. Autopilot and auto-trim are not available.

### **Handling Characteristics**

The handling characteristics are similar to a conventional aircraft. Any tendency to roll stick free can be corrected by conventional use of the rudder. Rudder trim can be used in the conventional way, but note that the sideslip index may be slightly displaced from the centre once the rudder forces have been trimmed out. Rapid speedbrake application and large thrust changes will result in significant pitching moments, i.e. nose-up with thrust increase and nose down with thrust reduction.

In pitch, elevator deflection is proportional to sidestick deflection. It is important to note that the controls are very powerful. Consequently, use small inputs when at high speed. As there is no auto-trim, use manual trim making small inputs on the trim wheel.

In roll, aileron and spoiler deflection is proportional to sidestick deflection. Direct law works with the yaw damper to provide a minimal turn coordination.

### **Protections**

No protections are available but overspeed and stall aural warnings remain available.

## **BACKUP SYSTEM**

The purpose of the backup system is to allow control of the aircraft following a total loss of electrics, flight control computers, elevators, or ailerons and spoilers. It is designed to allow the crew to safely stabilise the flight path while attempting to recover a control law or restore a lost system(s). It is not intended that an approach and landing should be flown in this configuration.

### **Handling Characteristics**

Stabilise the aircraft flight path using the rudder and manual pitch trim while attempting to recover a flight control law. Thrust considerations regarding pitching moments are similar to those described above in Direct Law.

Pitch control is achieved through the pitch trim wheel. Make small inputs on the trim wheel and wait for the aircraft response before making a further correction.

Lateral control is achieved through the rudder. The rudder induces a significant roll with a slight delay. Make small inputs on the rudder pedals and wait for the aircraft response before making a further correction. Wings level stabilisation needs some anticipation.



## ABNORMAL ATTITUDE LAW

If the aircraft is far outside the normal flight envelope and reaches some abnormal attitudes, the flight control law is modified to allow the crew to regain normal attitude efficiently. This is the abnormal attitude law. FCOM 1.27.30 refers.

### A346 Tailstrike Protection

The A346, being longer than the A333 and A343, has a higher risk of tailstrike. Consequently, several new features have been incorporated. These include an added rotation law plus an additional auto-callout, PFD indication and ECAM warning.

A pitch rotation law has been added for take-off and is engaged during the rotation phase. A pitch demand depending on pitch rate and sidestick position is added to the ground law orders. Within certain parameters this law minimises tailstrike risk if there is inappropriate sidestick input from the pilot.

Below 14 ft RA an auto-callout "PITCH, PITCH" is triggered in case of excessive pitch attitude.

For both take-off and landing, a tailstrike Pitch Limit Indicator (PLI) is provided on the PFD. The PLI indicates the maximum pitch attitude in order to avoid a tailstrike. FCOM 1.31.40 refers.

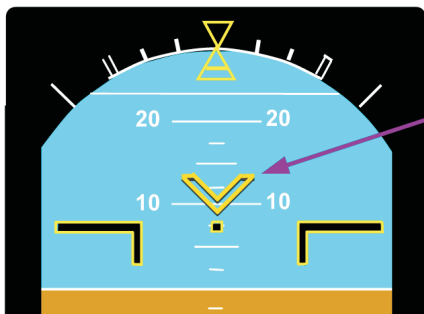

PITCH LIMIT INDICATOR

**Take Off:** shown when TLs in FLEX/TOGA detent until 3 seconds after liftoff

**Landing:** shown below 400RA



Below 14 ft on Approach,  
Pitching too high. Lower A/c nose.

Tailstrike Protection System



## GENERAL

Console mounted levers are used to control engine thrust. Thrust can be controlled either manually, or automatically through the A/THR. Each lever sends electrical signals to the FADEC of the engine it controls. The FADEC responds to the thrust lever position or autothrust command by setting engine thrust.

The thrust lever quadrant is effectively a thrust-rating panel. The thrust levers move over the range of the quadrant in a conventional sense. For each lever there are four detents:

- Idle
- CL
- FLX/MCT
- TOGA

The significance of CL and FLX/MCT detents is described in detail later. Moving a thrust lever to the TOGA detent always selects maximum take-off or go-around thrust as appropriate. In the same way, moving a thrust lever to the idle detent always selects idle thrust.

A/THR status can be monitored through the FMA and the engine instrument display on the E/WD. The E/WD gives readout of:

- The engine thrust limit mode (CL, MCT, etc)
- The applicable engine limits
- Thrust lever position
- FADEC command
- The maximum engine rating

## MANUAL THRUST CONTROL

With autothrust off, thrust control between the idle detent and the TOGA detent is entirely conventional. Thrust lever angle (TLA) determines the thrust demanded. The thrust setting selected by the pilot and the actual engine limit is indicated on the E/WD. With the thrust lever at less than the CL detent, the E/WD displays the CL limit, except before take-off when it displays the take-off thrust limit programmed through the MCDU. If the thrust lever is set between two detents then the FADEC selects the rating limit corresponding to the higher detent. With the thrust lever(s) positioned in a detent, the detent setting controls the engine(s) to that limiting parameter, e.g. with the thrust levers in the CL detent, the engines will be at climb thrust.



## AUTOTHRUST

One of the unique features of the Airbus A/THR system is that the thrust levers are not back-driven, i.e. they do not move as the thrust changes. This being the case, other cues must be used to monitor A/THR performance, e.g. the speed trend vector on the PFD or the transient and commanded N1/EPR indications on the engine instruments. The A/THR normally remains active from the thrust reduction altitude after take-off until the flare.

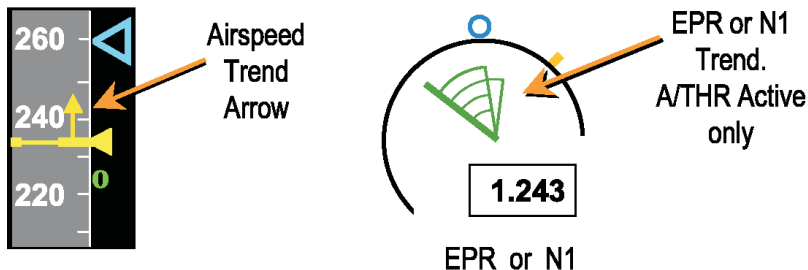

### Auto Thrust Cues

#### Autothrust Modes

With A/THR active, one of the following modes will be engaged as appropriate:

- Speed or Mach mode, where the A/THR modulates thrust to achieve a target speed or Mach.
- Thrust mode, where the A/THR commands a specific thrust setting, e.g. climb thrust or idle.
- Retard mode, where the A/THR commands a reduction to idle thrust during the flare. This mode only operates automatically during an autoland. The thrust levers must be retarded manually in the flare following a manual approach.

#### Engagement Status

The A/THR system can be in one of the following three states:

- Armed
- Active
- Off



OFF



ARMED



ACTIVE

### Auto Thrust Status

When armed, the A/THR is ready to control the thrust once the thrust levers are moved into the active range. Normally the A/THR is armed on the application of take-off thrust, at which point "A/THR" is displayed in blue in the right hand column of the FMA. After take-off, A/THR is activated by selecting the thrust levers to the CL detent.

When active, the A/THR automatically controls the engine thrust. The TLA determines the maximum thrust that can be commanded by the A/THR. This maximum thrust available is displayed on the thrust gauge by a TLA blue circle. "A/THR" is displayed in white in the right hand column of the FMA. The operating mode of the A/THR is displayed in the left hand column of the FMA.

When the A/THR is off, thrust must be controlled manually. In this case, the A/THR FMA indications will be blank.

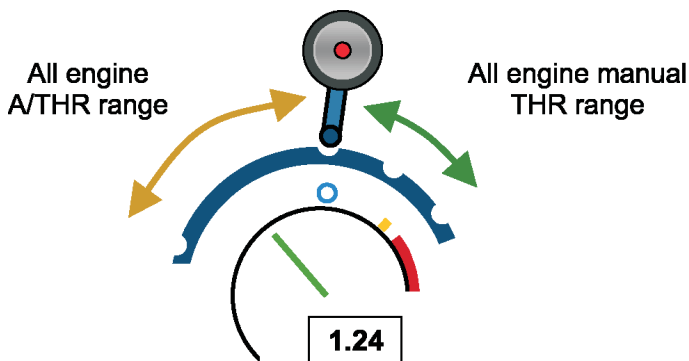

A/THR active.  
Less than CLB THR required

Thrust Lever Position: Autothrust





## Thrust Lever Quadrant

The active range of the A/THR depends on whether or not all engines are operative.

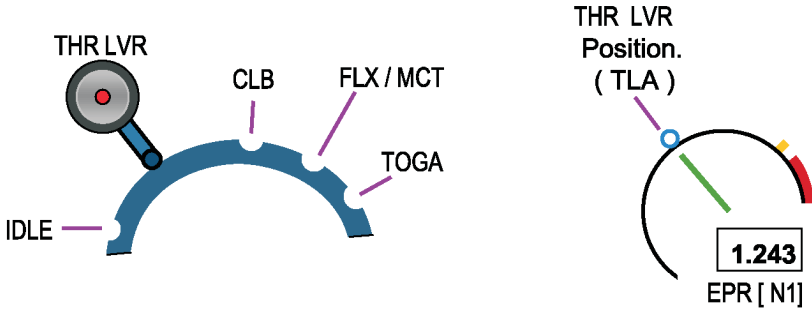

## Thrust Lever Quadrant

In the all engines case, A/THR is active between the idle and the CLB detents. With all thrust levers above the CLB detent, A/THR becomes armed.

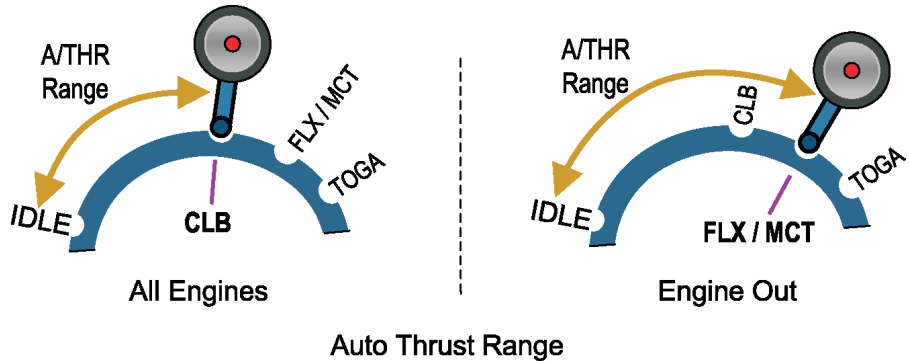

With one engine inoperative, the A/THR is active between the idle and FLX/MCT detent. Similarly, with the remaining thrust levers above the FLX/MCT detent, A/THR becomes armed.



## AUTOTHRUST OPERATIONAL ASPECTS

The operational aspects of the A/THR system can be divided as follows:

- Take-off
- Climb, Cruise, Descent and Approach
- Go-around
- Warnings and messages

### Take-off

To initiate take-off, the Captain advances the thrust levers to either the FLX/MCT or TOGA detent depending upon performance requirements:

- For a TOGA thrust T/O, set the thrust levers to the TOGA detent.
- For a FLEX thrust T/O, set the thrust levers to the FLX/MCT detent.
- For a DERATED thrust T/O, set the thrust levers to the FLX/MCT detent. TOGA thrust should not normally be selected on a derated T/O. FCTM Ch 4 refers.

The thrust is controlled by the FADEC to the applicable limit and the A/THR is armed. The thrust setting will be displayed on the FMA, e.g. FLX 50, as well as on the E/WD.

At the thrust reduction altitude entered in the PERF T/O page, the message "LVR CLB" flashes on the FMA. Smoothly move the thrust levers to the CL detent where they will normally remain until the flare. The A/THR is now active.

### Climb, Cruise Descent And Approach

During the climb, the A/THR is in thrust mode and commands the thrust setting displayed on the FMA, e.g. THR CLB.

In the cruise, the A/THR is in speed mode and modulates the thrust to maintain a speed or Mach target.

During descent and approach, the A/THR can be in either thrust or speed mode. Use of the A/THR on approach will be covered in greater detail in Chapter 6.

### Go-around

To select go-around thrust, advance the thrust levers to the TOGA detent. TOGA thrust is commanded and the A/THR becomes armed. The message "MAN TOGA" appears on the FMA and the A/THR indication becomes blue. The A/THR becomes active again when the thrust levers are returned to the CL detent, (or the FLX/MCT detent if engine inop).



## Warnings And Messages

There are a number of warnings, cautions and messages associated with the operation of the A/THR. The warnings, cautions and messages can be classified as follows:

- Take-off
- All Engines Operative
- One Engine Inoperative
- Disconnection
- Protection

### Take-off

The three thrust setting options available for take-off are Flexible Thrust (FLX), Derated Thrust (DRT) and Take-off and Go-around Thrust (TOGA). The corresponding thrust lever quadrant detents are FLX/MCT for FLX and DRT take-offs and TOGA for TOGA take-offs. The FLX temperature and DRT level are entered via the MCDU. The ECAM provides an element of protection against the use of incorrect thrust settings for take-off by generating the warning "ENG THR LEVERS NOT SET" if the thrust levers position disagrees with the MCDU input. The corrective action for this warning is different depending on the situation. All CX aircraft have the DRT function enabled and the situations that will generate this warning are:

- If no FLX temperature or DRT level has been inserted and the thrust levers are set to the FLX/MCT detent
- If a DRT level has been inserted and the thrust levers are set beyond the FLX/MCT detent
- Thrust levers are set to below FLX/MCT detent.



### **All Engines Operative**

With the A/THR active, if one of the thrust levers is set below the climb detent, the message "LVR ASYM" is displayed in amber on the FMA. In this case, each engine will be limited to its appropriate TLA position. This allows the continued use of autothrust if one engine has to be RPM limited for an operational reason, e.g. excessive vibration.

With the A/THR active, if all thrust levers are set below the CL detent, the warning "AUTO FLT A/THR LIMITED" appears on the E/WD and the message "LVR CLB" flashes in white on the FMA. This situation is brought to the crew's attention as a caution, with a single chime repeated every 5 secs until the thrust levers are returned to the CLB detent or the A/THR is disconnected. There should be no operational requirement for the pilot to limit A/THR authority on all engines.

With the A/THR active, if all thrust levers are set above CL detent, the message "LVR CLB" flashes in white on the FMA beneath the boxed "MAN THR" message. The engine power will increase to the thrust corresponding to the TLA.

### **One Engine Inoperative**

With the A/THR active, if the thrust lever(s) of the remaining engine(s) are set below the MCT detent, the caution "AUTO FLT A/THR LIMITED" appears on the E/WD and the message "LVR MCT" flashes in white on the FMA.



## DISCONNECTION

Intentional A/THR disconnection is accomplished by:

- Depressing the instinctive disconnect pb
- Setting all thrust levers to IDLE

The normal method of disconnecting the A/THR is through the instinctive disconnect pb on the thrust levers. The PF should announce his intention to disconnect the A/THR and then use the following sequence:

- Set the thrust levers to the current thrust setting by adjusting the levers until the N1 (EPR) TLA blue circle is adjacent to the actual N1/EPR. If this step is not carried out prior to pressing the instinctive disconnect pb, the thrust will increase rapidly to the current TLA, e.g. climb thrust.
- Disconnect the A/THR using the instinctive disconnect pb.
- The "AUTO FLT A/THR OFF" caution will be annunciated on the E/WD on the first press of the instinctive disconnect pb and will be cleared by a second press of the pb. The caution will also disappear after a 9 sec time-out following a single press of the disconnect pb.
- Adjust the thrust as required.

Disconnection of the A/THR by setting the thrust levers to idle is the normal method of disconnection during the flare.

Disconnection due to a failure is uncommon but should it occur, react to the ECAM warnings in the normal manner. It may be possible to regain A/THR by selecting the other AP. If the A/THR cannot be restored, manual thrust must be used. Speed and thrust awareness following a failure is extremely important, as Alpha Floor protection is no longer available.

Disconnection by the use of the FCU A/THR pb is not recommended due to the associated cautions. This method should only be used if the instinctive disconnect pb is inoperative.

If the A/THR disconnects due to a failure, or is disconnected using the A/THR pb on the FCU, the cautions "AUTO FLT A/THR OFF" and "ENG THRUST LOCKED" will appear on the ECAM and the message "THR LK" will flash in amber on the FMA. In this instance, promptly align the TLA blue circle to the current thrust setting and adjust thrust manually.

The A/THR can be reactivated by pressing the A/THR pb on the FCU and returning the thrust levers to the applicable detent.

## Protection

Even with A/THR selected off, high angle of attack protection (Alpha Floor) is provided by the A/THR. Alpha Floor is not available in the certain cases. FCOM 1.22.30 refers.



## GENERAL

The FPV indicates performance and does not direct or command. It displays information on the aircraft trajectory relative to the ground. Because of inertia, there will always be a lag between an attitude change and the resultant change in flight path. Therefore, use of the bird should be limited to non-dynamic manoeuvres. However, it is particularly useful in those operations where a stable, accurate flight path is important, e.g. non-precision approaches or visual circuits. When using the bird, make an attitude change first, as with other aircraft types and then check the outcome with reference to the bird.

FCOM 1.31.40 refers.

## INFORMATION PRESENTATION

The vertical flight path angle can be read directly from the PFD pitch scale. If the aircraft is stable and the wings of the bird are on the PFD horizon, then the aircraft is in level flight.

The track is displayed on the PFD as a green diamond indicator on the compass, as well as by the lateral displacement of the bird from the fixed aircraft symbol. On the ND, the track is displayed as a green diamond indicator on the compass scale. The angular difference between track and heading indicates the drift.

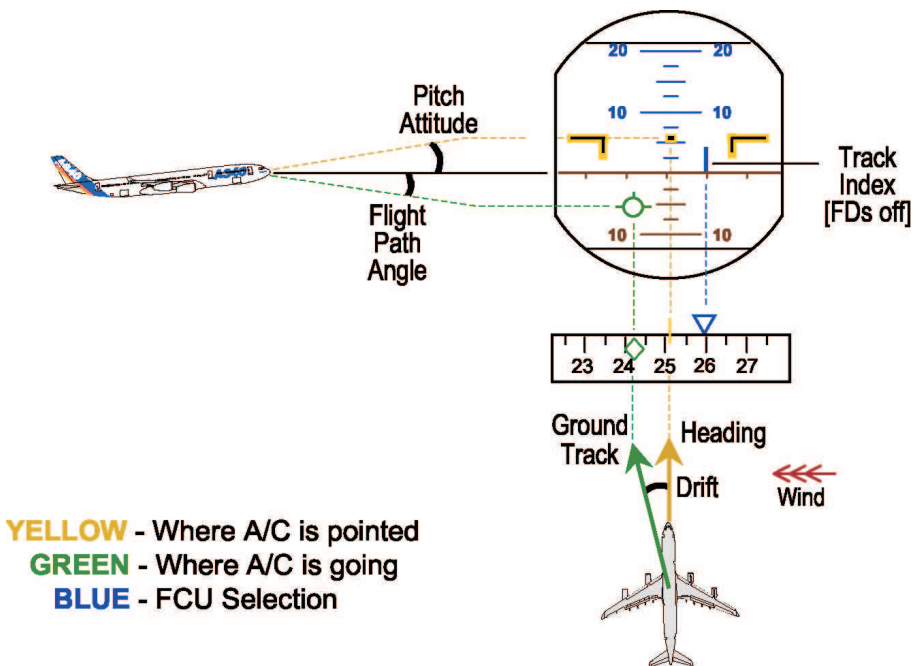

### Attitude/Heading/Flight Path Vector

#### PRACTICAL USES OF THE FPV

The FPV displays information on the aircraft trajectory relative to the ground. Because of inertia, there will always be a lag between an attitude change and the resultant change in flight path. Therefore, use of the bird should be limited to non-dynamic manoeuvres. However, it is particularly useful in those operations where a stable, accurate flight path is important, e.g. non-precision approaches or visual circuits.

When using the bird, make an attitude change first, as with other aircraft types and then check the outcome with reference to the bird.



## Non-Precision Approach

The FPV is particularly useful on non-precision approaches as the pilot can select values for the inbound track and final descent path angle on the FCU. Once established inbound, only minor corrections should be required to maintain an accurate approach path. Tracking and descent flight path can be monitored by reference to the track indicator and the bird. Be aware, however, that the bird only indicates a trajectory and not guidance to a ground based facility. For example, when selecting FPA to create a synthetic glide path, the aircraft will be correctly positioned only if it commences descent at the right point in space. Therefore, although the bird may indicate that the aircraft is on the correct trajectory, it does not necessarily mean that the aircraft is on the correct final approach path, since it may only be paralleling the intended path. When the aircraft is disturbed from the original trajectory, the pilot must adjust either its track or its flight path angle or both in order to obtain guidance back to the original trajectory.

## Visual Circuits

The FPV is useful as a cross-reference when flying visual circuits. On the downwind leg, put the wings of the bird on the horizon to maintain level flight. The downwind track should be set on the FCU. Place the tail of the bird on the blue track index on the PFD to maintain the desired track downwind.

On the final inbound approach, the track index should be set to the runway final approach course. A standard 3° approach path is indicated by the top of the bird's tail being just below the horizon and the bottom of the bird being just above the 5° pitch down marker.

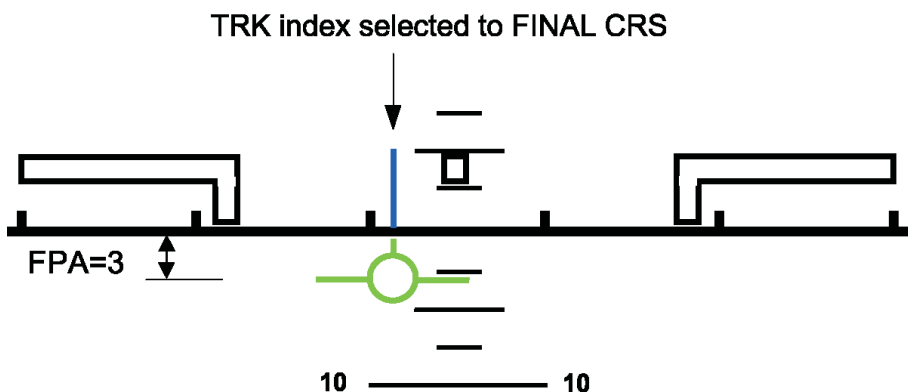

Use of FPV (crosswind from the right)





## **FPV CONSIDERATIONS**

### **Dynamic Manoeuvres**

The pilot must take care when performing a go-around with the FPV selected, as on some aircraft the HDG-V/S FD is not automatically displayed upon the selection of TOGA. In this case, it is important to use pitch attitude as the primary reference for the go-around and avoid any temptation to select the target attitude using the bird. The pitch attitude targets for a go-around are  $15^\circ$  for all engines operating and  $12.5^\circ$  for one engine inop. If not automatically displayed, selection of HDG-V/S should be made without delay during the go-around. The FPV is not used for take-off.

### **Reliability**

As the FPV is derived from IRS data, it is therefore affected by the errors of the ADIRS. This may be indicated by a slight track error, typically in the order of up to  $\pm 2^\circ$ .



## TABLE OF CONTENTS

### Pre-start, Start And Taxi

#### Pre-start

Seating Position .....	3.10.1
Safety Exterior Inspection .....	3.10.2
Exterior Inspection.....	3.10.2
Cockpit To Ground Communication .....	3.10.2
Pushback.....	3.10.3
Backing With Reverse Thrust.....	3.10.3

#### Start

Engine Start.....	3.20.1
-------------------	--------

#### Taxi

Prior To Brake Release .....	3.30.1
Brake Check.....	3.30.1
Thrust Use.....	3.30.1
Flight Control Check.....	3.30.2
Steering .....	3.30.3
Steering Technique And Visual Cues.....	3.30.3
A346 Taxi Camera .....	3.30.5
Taxi Speed And Braking.....	3.30.5
Carbon Brakes .....	3.30.5
Brake Temperature .....	3.30.5
180° Turn On The Runway .....	3.30.6
Late Change Of Runway And/Or Take-off Data.....	3.30.7
Take-off Briefing Confirmation.....	3.30.7
Adverse Weather.....	3.30.8
Taxi With Engines Shut Down.....	3.30.8
Line-up Technique.....	3.30.8

INTENTIONALLY  
BLANK



## SEATING POSITION

As in all aircraft, achieving the correct seating position is very important. The correct seating position not only allows the pilot to have the best possible view of the instruments and outside the cockpit, but also ensures that he can operate all controls in both normal and non-normal situations. It is critical during Low Visibility Procedures (LVP) that the pilot's eyes are positioned correctly so that he maximises the visual segment, thus increasing the possibility of achieving the required visual reference for landing as early as possible.

To achieve correct eye position, the aircraft is fitted with an indicator located on the centre windscreen post. It comprises two balls which, when superimposed one on the other, indicate that the pilot's eyes are in the correct position. Adjust the seat horizontally, vertically and in recline to ensure correct eye position. The adjustments to the seat should be made when sitting in a normal posture. A common error is sitting too low which decreases the cockpit cut-off angle, reducing the visual segment.

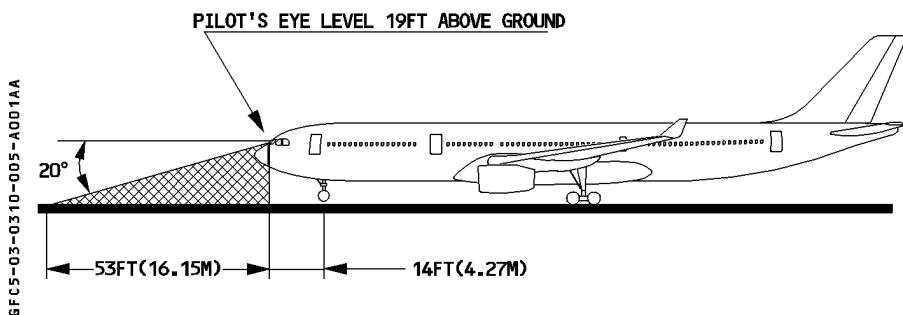

### Visual Ground Geometry

After seat adjustment, the outboard armrest should be adjusted such that the forearm rests on it comfortably when holding the sidestick. There should be no gaps between the forearm and the armrest and the wrist should not be bent when holding the sidestick. This ensures that flight manoeuvres can be accomplished by movement of the wrist rather than having to lift the forearm from the rest. Symptoms of incorrect armrest adjustment include over-controlling and the inability to make small, precise inputs.

The rudder pedals must then be adjusted to ensure that both full rudder pedal displacement and full braking can be achieved simultaneously on the same side.

The armrest and the rudder pedals have position indicators. These positions should be noted and set accordingly for each flight.



## **SAFETY EXTERIOR INSPECTION**

An assessment should be made of the aircraft external environment before applying pneumatic or hydraulic power. Items to check include:

- Wheel chocks (the Park Brake must be applied if chocks are not in place)
- Landing gear door positions
- APU inlet and exhaust areas
- Connection of external electrics
- Connection of external air-conditioning or HP air

This visual assessment is normally made when approaching the aircraft from ground level. However, where such an assessment is not feasible, co-ordination with the ground engineer must be established before starting the APU or activating aircraft pneumatic, electric or hydraulic systems.

Double chocks should be positioned approx 2 inches forward and aft of the nose wheel. Main wheels must also be chocked if wind or ramp slope conditions require and/or if single type chocks only are used on the nose wheel. Be aware that the parking brake efficiency is significantly reduced if ACCU PRESS falls below 1500 psi (amber sector).

## **EXTERIOR INSPECTION**

The objective of the exterior inspection is to get a global assessment of the aircraft status. Any missing parts or panels should be checked against the CDL for possible dispatch and operational consequences. Ensure that the main aircraft control surfaces are in the correct position relative to cockpit control selection and that there is no evidence of fuel, oil or hydraulic leaks.

Check the status of essential visible sensors; e.g. AOA, pitot and static probes.  
Check the landing gear status; e.g. wheel/tyre condition, safety pins removed, brake wear, and oleo extension.

Check engine condition; e.g. fan blades, turbine exhaust, engine cowl and pylon status. Check all access panels are closed.

FCOM 3.03.05 refers

## **COCKPIT TO GROUND COMMUNICATION**

It is essential that good communication is established with the ground personnel prior to engine start or pushback. It is important that standard terminology is used to avoid confusion and ensure safety.

To attract the attention of the ground mechanic from the flight deck, use the "Mech Call" pb. To speak to the mechanic, use either the "INT" key on the ACP when wearing headsets or the "INT" pb on the ACP and the hand-mike. Establish communication with the mechanic before commencing any action that may compromise safety, e.g. powering a hydraulic circuit.

Vol 2 Pt 2 refers.



## **PUSHBACK**

During this potentially hazardous phase of the operation, the NPs should be strictly followed to minimise the possibility of injury to ground personnel or damage to the aircraft/ground equipment. Consequently, ATC clearance should neither be requested nor copied during pushback.

Once the doors are closed and ATC clearance has been obtained, the START checklist should be completed and the PF can order the pushback. Prior to aircraft movement, the PF should ensure that the nosewheel steering is disconnected by checking the ECAM memo. Engines may be started during pushback in accordance with local regulations. Ground personnel should be on the headset throughout the pushback to communicate any possible safety hazards.

## **BACKING WITH REVERSE THRUST**

Backing, or assisting pushback, with reverse thrust is prohibited.

INTENTIONALLY  
BLANK



## ENGINE START

The thrust levers must be confirmed at idle prior to engine start. If the thrust levers are not at idle, the thrust will increase above idle after start, creating a potentially hazardous situation. However, an ECAM caution ENG START FAULT prompts the PF to set the thrust levers to idle.

The normal method of starting the engines is through the auto-start system, controlled by the FADECs. Selecting the Engine Start Selector to “START” energises the FADECs and the start sequence is initiated by selecting the Engine Master switch to “ON”. Pilots should monitor the start sequence, however the FADEC controls the engine start and takes appropriate action should engine parameters be exceeded. Should a start malfunction occur, the ECAM should be handled in the normal manner in order to avoid possibly interrupting a FADEC controlled sequence, e.g. instinctively selecting the master switch to “OFF” whilst the engine is being motored following a hot start. For this reason, the PF should remove his hand from the master switch during an auto-start on the ground.

The next engine start sequence should be initiated once engine parameters have stabilised and AVAIL is displayed for the engine on the EW/D.

Once the engine start is complete, check the stabilised parameters. Once the Engine Start Selector has been selected to the “NORM” position, the PNF should select the APU Bleed off without delay to avoid engine exhaust gas ingestion.

### Manual Engine Start

The FADECs have limited authority during a MAN start. They ensure passive monitoring of engine parameters and provide ECAM alerts, but they do not have the authority to abort a MAN start. The FADECs do provide start valve closure at 50% (A333/A346: N3) (A343: N2).

FCOM 3.04.70 refers.



INTENTIONALLY  
BLANK



## PRIOR TO BRAKE RELEASE

The Park Brake shall not be released until:

- Ground crew "thumbs up" signal has been received indicating all personnel and equipment are clear.
- Following a pushback, the NWS pin has been sighted.
- ATC taxi clearance has been received.
- The NOSE light is set to TAXI.
- Both pilots have visually confirmed and cross-checked, no obstructions in the taxi path.

## BRAKE CHECK

When cleared to taxi select the Park Brake to "OFF". Check the brake triple indicator to ensure that the brake pressure drops to zero, indicating a successful changeover to the normal braking system. Once the aircraft starts moving, prove the efficiency of the normal braking system by gently pressing the brake pedals and checking that the aircraft slows down. The brake pressure should remain near zero on the brake triple indicator.

(A346: If the brake pedals are pressed before releasing the park brake, the alternate braking mode remains active and the brake triple indicator will continue to display blue system pressure. When the brake pedals are released, normal braking mode resumes and the brake triple indicator should then read near zero.)

## THRUST USE

To begin taxi, release the brakes and, if required, smoothly increase thrust to the minimum required for the aircraft to roll forward. If thrust above idle is required to achieve taxi speed, be aware that engines are slow to accelerate from ground idle and allow time for aircraft response before increasing thrust further. Engine noise level in the flight deck is low and not indicative of engine thrust. Excessive thrust application may result in exhaust blast damage or foreign object ingestion (FOD). Thrust should normally be used symmetrically.



## FLIGHT CONTROL CHECK

At a convenient stage, prior to or during taxi, but before arming the autobrake, the PF announces "Flight Control Check" and applies full longitudinal and lateral sidestick deflection. On the F/CTL page, the PNF checks and calls full deflection and correct sense of movement of elevators and ailerons and correct extension and retraction of spoilers. As each full travel/neutral position is reached, the PNF announces:

- "Full up, full down, neutral".
- "Full left, full right, neutral".

The PF then presses the PEDAL DISC pb on the steering handwheel and applies full left and full right rudder and then returns the rudder to neutral. As each full deflection/neutral position is reached, the PNF responds:

- "Full left, full right, neutral".

Full control input must be held for sufficient time for full travel to be reached and indicated on F/CTL page.

The PNF then repeats the same procedure for the sidestick only, whilst monitoring the F/CTL page. On completion, the PNF calls "Neutral".

The PF then checks the F/CTL page to confirm the correct position of all flight controls and that the pitch trim indication is in close agreement with the actual THS setting. On completion, the PF calls "Check".



## STEERING

The nosewheel steering system is "fly-by-wire" with no mechanical connection between the steering handwheel and the nosewheel. The relationship between steering handwheel deflection and nosewheel angle is non-linear and the steering handwheel forces are light and independent of deflection. Anticipation is required when entering or exiting a turn. Make a smooth input on the steering handwheel and hold that input for sufficient time to assess the outcome. If required, any correction should be smooth and progressive, as being over-active on the steering handwheel will induce uncomfortable oscillations.

On straight taxiways and for shallow turns, use the rudder pedal steering, but be prepared to use the steering handwheel if required.

When exiting a tight turn allow the aircraft to roll forward for a short distance before stopping to minimise the stress on the main gears. Asymmetric thrust may be used in order to initiate a tight turn and to keep the aircraft moving during the turn, but should not be used to tighten the turn. Avoid stopping the aircraft in a turn, as excessive thrust will be required to start the aircraft moving again.

Simultaneous use of rudder pedal steering and steering handwheel inputs should be avoided.

## STEERING TECHNIQUE AND VISUAL CUES

On straight taxiways, taxi as close to the centreline as possible while keeping the nosewheel off the taxiway centreline lights. Taxiing over the centreline lights, particularly at high speeds, is noisy and uncomfortable for the passengers. If the pilot displaces the aircraft such that his body is over the centreline, this should allow sufficient displacement from the taxiway centreline.

There are a number of factors that govern when a turn should be initiated. The main gear on the inside of a turn always cuts the corner and tracks inside of the nosewheel track. For this reason, the "over-steer" technique must be used. As the turn is commenced, steer the nosewheel far enough outside the centreline to keep the main gear evenly straddling the centreline. Be aware that the nose gear is 5m behind the flight deck and the main gear (A333/A343: 30m)(A346: 35m) behind the flight deck.

For turns of 90° or more, speed should be below 10 kt. Smoothly initiate the turn as the intersecting taxiway centreline (or intended exit point) approaches the centre of the nearside window or aft edge of the offside windshield.



**Just Before Starting a Left Turn as seen from the RH Seat**



**Just Before Starting a Right Turn as seen from RH Seat**



## **A346 TAXI CAMERA**

The Taxi Aid Camera System (TACS) can be useful in observing areas beneath the aircraft. The TACS is designed to aid in determining the nose and main gear position prior to and during taxiing and its use should be limited to these functions. Direct visual observation out of the cockpit window remains the primary means of determining when to initiate turns and verifying the aircraft's position relative to the intended ground track. The oversteer technique is required before entering a turn. Once stable in the turn, the magenta square on the upper section of the TACS display tracks close to the taxiway centre line. The TACS display may be used sparingly to determine the proximity of the gear to taxiway edges and when the main gear has cleared the turn. Do not fixate on the TACS display at the expense of aircraft control.

No crew procedure or action, except use while taxiing, is predicated on the use of TACS. The ECAM remains the primary means of alerting crew to non-normal situations. TACS use during take-off, approach and landing is prohibited. Certain state authorities prohibit the display of the TACS view within the cabin.

## **TAXI SPEED AND BRAKING**

On long straight taxiways and with no ATC or other ground traffic constraints, allow the aircraft to accelerate towards 30 kt and then use one smooth brake application to decelerate towards 15 kt. Do not "ride" the brakes. The ND ground speed read out should be used to assess taxi speed.

## **CARBON BRAKES**

Carbon Brake wear is a function of the number of brake applications and brake temperature. The wear is not a function of the pressure applied or the duration of the braking. The only way to minimise brake wear is to reduce the number of applications.

## **BRAKE TEMPERATURE**

The FCOM limits brake temperature to 300°C before commencement of take-off. This limit ensures that any hydraulic fluid which might come into contact with the brake units would not be ignited after gear retraction. It does not provide protection against an elevated brake temperature after gear retraction resulting from a dragging brake. Experience indicates that brake temperatures close to 300°C tend to reduce during taxi-out provided correct braking technique is used and no mechanical abnormality exists.



## 180° TURN ON THE RUNWAY

Do not attempt a 180° turn on a runway that is less than 56 m wide.

The following procedure is recommended for making a 180° turn:

For the Captain:

- Taxi on the right hand side of the runway and turn left to establish a 20° divergence from the runway axis (using the ND or PFD) with a maximum ground speed of 10 kt.
- When physically over the runway edge, smoothly initiate a full deflection turn to the right.
- Asymmetric thrust should be used during the turn. Anticipation is required to ensure that asymmetric thrust is established before the turn is commenced, (50% N1 or 1.05 EPR), to maintain a continuous speed of approximately 5 to 8 kt throughout the manoeuvre.
- Differential braking is not recommended due to gear assembly stress. Moreover, a braked pivot turn is NOT permitted (i.e. braking to fully stop the wheels on one main gear).

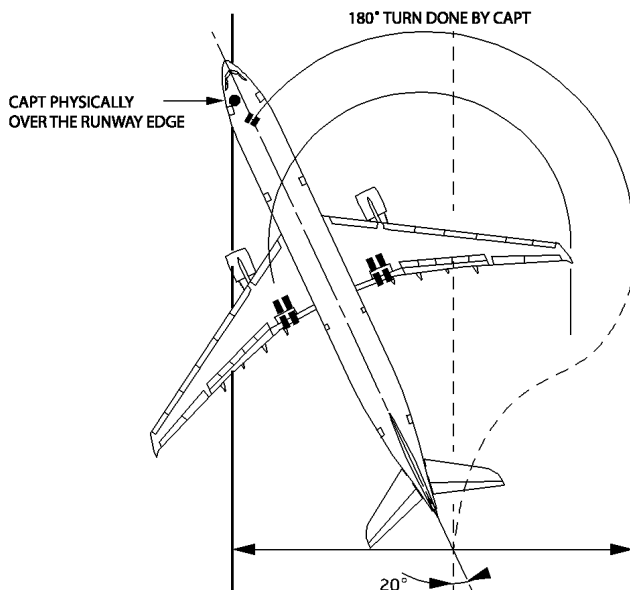

GFC5-03-0310-006-A100AA

For the First Officer, the procedure is symmetrical (taxi on the left hand side of the runway).



## **LATE CHANGE OF RUNWAY AND/OR TAKE-OFF DATA**

At airports where the opportunity for a late runway change could be expected, such as BKK, obtain ACARS RTOW for both runways prior to pushback. Provided performance is not limiting, input the same flap configuration for the secondary runway as that generated by the ACARS T/O data printout for the primary runway. Selection of the same flap configuration will reduce the chance of an incorrect configuration for takeoff.

Any modification to data shall be inserted and crosschecked following the same process defined in Normal Procedures. If take-off data has changed, or in the case of a runway change:

- Obtain new ACARS RTOW. Again the Captain shall check the ACARS RTOW.
- Modify the F-PLN to reflect the new ATC clearance for the runway, SID and transition.
- Select appropriate nav aids for the SID.
- Insert the new PERF TO data; the MCDU may not clear the original PERF data when the runway is changed. Check PERF CLB data (speed PRESELECT requirement).
- Confirm FLAPS LEVER set to new configuration.
- Set revised V2 and Green Dot speed bugs on Standby ASI or ISIS.
- Using the EFIS Control Panel, confirm selection of EFIS display for both ND mode and nav aids.
- Set first stop altitude on FCU. Preset FCU HDG bug if necessary.
- Check transponder code is still correct.

## **TAKE-OFF BRIEFING CONFIRMATION**

This briefing should normally be a brief confirmation of the thorough take-off briefing made at the parking bay. Any major changes that may have occurred should be reflected in a comprehensive re-briefing.

FCOM 3.03.10 refers.





## **ADVERSE WEATHER**

The major adverse weather factors affecting taxiing techniques are poor visibility and contaminated taxiways. In both instances, the taxi speed should be limited to 10 kt and any action which might divert the full attention of the crew from taxiing should be delayed until the aircraft is stopped. The Before Take-off checklist should be performed either before taxi or when reaching the holding point.

On a contaminated taxiway there are a number of additional factors that should be taken into account:

- At speeds below 10 kt, the anti-skid is de-activated
- Engine anti-ice increases ground idle thrust
- Avoid large steering handwheel inputs to minimise the risk of skidding during turns
- On slippery taxiways, it might be necessary to use differential braking and/or thrust to augment the nosewheel steering

On slush or snow covered taxiways, delay flap selection until reaching the holding point to avoid contamination of the flap/slat actuation mechanism.

When holding on the ground in icing conditions for extended periods of time or if engine vibration is encountered, thrust should be increased periodically and just before take-off to shed any ice from the fan blades. Detailed information on this procedure can be found in FCOM 3.

## **TAXI WITH ENGINES SHUT DOWN**

On A343 and A346 aircraft, taxi out for departure with one or two engines shut down may be operationally beneficial. FCOM 3.04.90 refers.

## **LINE-UP TECHNIQUE**

It is important, particularly on limiting runways, not to sacrifice an excessive amount of runway length during the line-up, as a fixed distance is assumed for performance calculations relating to this manoeuvre.



## TABLE OF CONTENTS

### Take-off And Initial Climb

#### Take-off

Thrust Setting .....	4.10.1
Take-off Roll .....	4.10.1
Rotation .....	4.10.2
Rotation Performance Differences .....	4.10.3
Crosswind Take-off .....	4.10.3
Tailstrike .....	4.10.5
Flex Thrust Take-off .....	4.10.6
Derated Thrust Take-off .....	4.10.7
Adverse Weather.....	4.10.9

#### Initial Climb

Preface .....	4.20.1
Lift-off .....	4.20.1
AP Engagement .....	4.20.1
Vertical Profile .....	4.20.1
Lateral Profile .....	4.20.1
Thrust Reduction Altitude .....	4.20.2
Acceleration Altitude.....	4.20.2
Take-off At Heavy Weight .....	4.20.4
Tracking The Localiser Of The Opposite Runway.....	4.20.6
Low Altitude Level-off .....	4.20.7
Close-in Turn After Take-off.....	4.20.7

INTENTIONALLY  
BLANK



## THRUST SETTING

Following line up and after brake release, the PF announces "Set Thrust". The Captain then applies power in two stages:

- From idle to (A333: 1.15 EPR), (A343: 50% N1), (A346: 1.05 EPR) in a rapid and continuous movement by reference to the TLA indicator on the EPR/N1 gauge. On the A333, there is protection between 1.16 -1.28 EPR to protect the engine from blade flutter. The FADEC will not allow fan speed acceleration above 1.16 EPR until the demanded EPR exceeds 1.28 EPR.
- When the engine parameters have stabilised, the thrust levers should be advanced without delay to the FLX/MCT or TOGA detent as appropriate.

Modified Engine Acceleration Schedule for Take-Off (MEASTO) is installed on the A333 engines. This logic automatically controls engine acceleration by preventing high N1 at low speed during the take-off roll to avoid fan stall. As a consequence, take-off thrust takes longer to reach than on other engines (approximately 10 seconds more) and is achieved around 60 kt IAS.

Once the thrust levers are set, the PF announces the indications on the FMA. The PNF checks that the thrust is set by 80 kt, by checking that the actual EPR/N1 of each engine has reached the rating limit displayed on the E/WD, and calls "Thrust Set". The Captain must keep his hand on the thrust levers until V1.

If the thrust levers are set fully forward to the TOGA detent, TOGA thrust is applied regardless of any FLEX or DERATE entry in the MCDU PERF TO page.

## TAKE-OFF ROLL

On a normal take-off, to counteract the pitch up moment during thrust application, apply half forward sidestick at the start of the take-off roll until reaching 80 kt. At this point, gradually reduce the input to be zero by 100 kt.

Use rudder to keep the aircraft straight. Nosewheel steering authority decreases as the groundspeed increases and the rudder becomes more effective. Normally, there should be no need to use the tiller once aligned with the runway centreline, but if it is needed, its use should be avoided above 20 kt.

Normally there should be no requirement to use lateral sidestick. If its use is required however, avoid using an excessive application, as spoilers will deploy, decreasing the lift and increasing the tendency of the aircraft to turn into wind.

The "ONE HUNDRED KNOTS" call by the PNF requires the PF to crosscheck speed on his PFD and respond "CHECK". This response also serves as an incapacitation check. "V1" is an Auto Call Out; if the auto-call fails, the PNF calls "V1". At V1, the Captain removes his hand from the thrust levers. The PNF calls "VR" and "V2" in sequence as each speed is reached.



## ROTATION

At VR, promptly and smoothly apply and hold approximately 2/3 aft sidestick to achieve a rotation rate of approximately 2 to 3°/sec, assessed primarily by outside visual reference. Avoid rapid and large corrections that will result in a sharp reaction in pitch from the aircraft. The rotation rate may take time to establish but for a given stick input, once it has developed it remains relatively constant. If the established pitch rate is not satisfactory, make a smooth correction on the sidestick, however avoid further aft sidestick inputs near the point of liftoff. The rotation rate is important as too low a rate would compromise take-off performance, whereas too high a rate would increase the risk of tailstrike. It is also important to be well prepared for an engine failure case and therefore it is appropriate to habitually rotate at a rate that would cater for the engine failure case, i.e. about 2.5°/sec. As the rotation progresses and the runway environment disappears from view, transfer attention to the PFD to establish the initial pitch attitude. The FD pitch bar is not to be used as an initial target since it does not provide any pitch rate order, instead rotate initially towards the following target pitch attitudes:

Aircraft type	Target pitch attitude
A333	15°
A343	12.5°
A346	15°

An indication of the correct rotation rate is achieving the target pitch attitude approximately 5 seconds after rotation commences (not 5 seconds after sidestick input). Once airborne, adjust the pitch attitude to follow the SRS command. Flight mode is progressively blended in about 5 seconds after passing 50 ft RA. This allows the sidestick to be returned to the neutral position, and the subsequent use of small control inputs as required to follow the FD commands. Automatic pitch trim normally begins above 50 ft RA.



## ROTATION PERFORMANCE DIFFERENCES

With both engines operative the A333 has considerable excess thrust, even at maximum flex temperatures. It is normal for a correctly flown rotation to result in a stabilised speed in excess of  $V_2+10$  kt. The rotation rate should not be increased in an effort to contain the speed increase. With both engines operative, the performance of the aircraft is not compromised by this additional speed.

At heavy weights, the aircraft has much greater inertia and is therefore slower to commence rotation. As the aircraft starts to rotate, maintain back-pressure to achieve a steady rotation to the target pitch attitude. Main wheel lift-off can be expected at  $9 - 10^\circ$  pitch attitude and there will be a tendency for the aircraft to stop rotating at this attitude unless the back-pressure is maintained. The slower initial rotation and shallower climb will result in a later establishment of flight mode.

Compared to shorter aircraft, the sensory feedback to the pilot during the rotation on the A346 is different due to the length of the aircraft and its flexibility. For the same rotation rate, the pilot will *sense* a delay in the rotation and a higher local vertical acceleration. Do not allow this sensory feedback to induce large changes in sidestick inputs which can lead to pitch oscillations. The A346 rotation law has been adapted to take into account the different characteristics of the aircraft.

For aircraft geometry, FCTM 7.10 refers.

## CROSSWIND TAKE-OFF

Maintain the runway centerline using rudder and use aileron to keep the wings level. In normal crosswind conditions, routine use of into wind aileron is not necessary. In strong crosswind conditions, some lateral input may be needed to keep wings level. Care should be taken to avoid using excessive lateral sidestick input, as this could result in spoiler deployment, increasing the tendency to weathercock into wind and consequently decreasing lift and increasing drag. Spoiler deployment starts to become significant with more than half sidestick deflection.

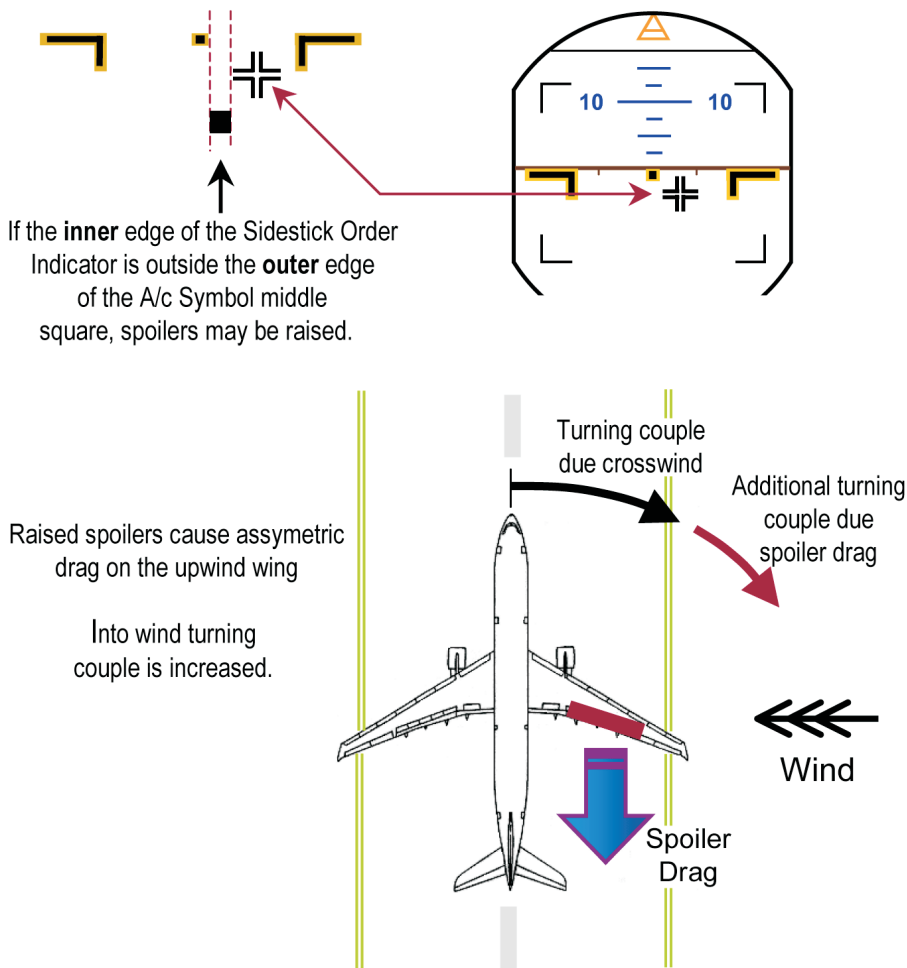

Ground mode lateral law gives a direct relationship between sidestick input and aileron deflection proportional to airspeed. During rotation the aircraft will react in the same manner as any conventional swept wing aircraft. With increasing angle of attack, the aircraft will naturally roll downwind so more aileron input will be required to maintain wings level. As the aircraft becomes airborne the rudder should be neutralised. Above approximately 100 ft RA, normal roll law becomes active and the aircraft will start to roll in response to any lateral sidestick input. The correct and instinctive response at this stage is to remove any lateral input. The aim is to maintain wings level throughout the ground-roll, rotation and initial departure.

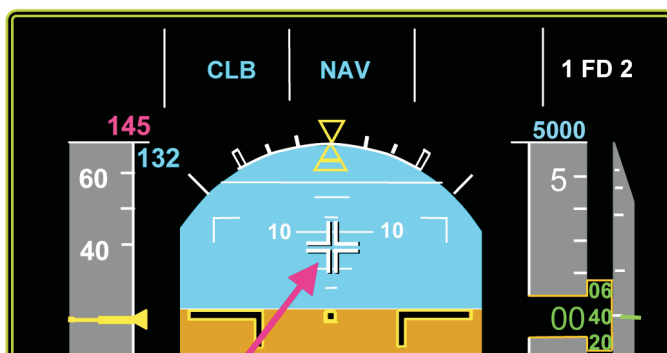

### Sidestick Order Indicator

To aid directional control in crosswinds greater than 20 kt, or with a tailwind, apply full forward sidestick at the start of the take-off roll until 80 kt. At this point gradually reduce the input to be zero by 100 kt.

## TAILSTRIKE

An inappropriate take-off technique could result in a tailstrike. Factors that might cause a tailstrike include:

- Early rotation
- Over-rotation
- Excessive rotational pitch rate
- Increased aft sidestick input at a late stage in the rotation; i.e. above about 8° pitch attitude, when the aircraft is near the point of lift-off and tail clearance is at a minimum
- Immediately rotating to the SRS pitch bar
- Excessive spoiler extension during rotation
- Turbulence and windshear

Using the take-off technique described earlier will minimise the risk of tailstrike. FCOM bulletin refers.

In general, the higher the take-off flap configuration, the greater the tailstrike margin.

In the event of a tailstrike, identified by ECAM or any other means, flight at high altitude must be avoided and the aircraft landed as soon as practicable. The aircraft must not be pressurised.

The A346, being longer than the A333 and A343, has a higher risk of tailstrike. Consequently, Flap 3 is normally used for take-off.





In addition, some new features have been incorporated on the A346:

- Pitch Limit Indicator (PLI) on the PFD. This indicates the pitch limits when the aircraft is on, or close to, the ground.
- Modification to the rotation law to account for the characteristics of the aircraft.

## FLEX THRUST TAKE-OFF

The FLEX take-off reduces EGT thus increasing engine life and reliability while reducing maintenance and operating costs. The FLEX take-off can be used when the actual take-off weight is lower than the maximum permissible take-off weight for the actual temperature. As the MTOW decreases with increasing temperature, it is possible to assume a temperature at which the actual take-off weight would become limiting. This assumed temperature is called the FLEX Temperature.

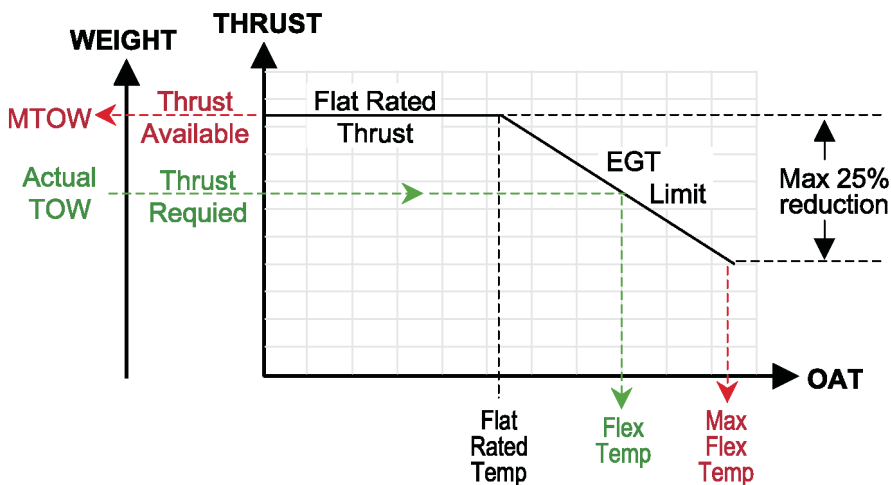

Flex Temperature Take-off

The minimum control speeds associated with the FLEX take-off are related to VMCG/VMCA at TOGA thrust. Therefore, should the aircraft suffer an engine failure at V1, there is no limitation on selecting TOGA thrust on the remaining engine(s).



## DERATED THRUST TAKE-OFF

A reduction in take-off thrust leads to lower VMCG/VMCA and hence, a lower V1. When taking off from short or contaminated runways where ASDA is the limiting factor, a reduction in the minimum control speeds may generate a take-off performance benefit and a higher MTOW.

A derated take-off is defined as a take-off at a thrust setting less than TOGA. Six (A346: 8) derated levels are defined, (A333/A343: D04, D08, D12, D16, D20, D24) (A346: D28, D32), each corresponding to a specific percentage reduction from the maximum take-off thrust. Derated procedures should only be used on a runway where the weight is limited by VMCG. Derating the thrust to a level below that necessary to meet the performance requirements is not permitted.

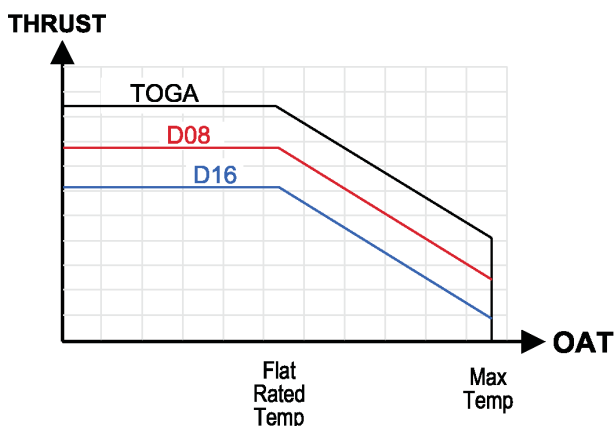

Derated T/O Thrust Ratings

During flight preparation, the appropriate derate should be entered in the DRT TO/FLX TO field in the PERF TO page on the MCDU, e.g. D04. The MCDU logic requires specific confirmation of this entry. Derated thrust is selected by setting the thrust levers to the FLX/MCT detent.

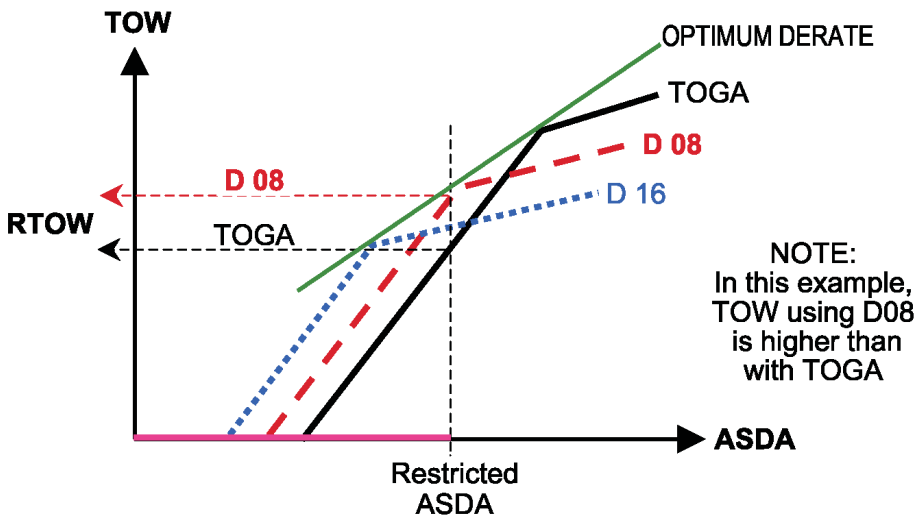

### TOW vs Thrust Setting for Restricted ASDA

As opposed to a FLEX take-off, the selection of TOGA following an engine failure during a derated thrust take-off is prohibited as long as speed remains below the first flap/slat retraction speed for the take-off configuration. The selection of TOGA below this speed in these configurations may result in loss of control due to VMCA considerations.



## ADVERSE WEATHER

Adverse weather that can be encountered during the take-off and initial climb includes:

- Cold weather
- Contaminated runway
- Windshear

### Cold Weather

When icing conditions exist at 0°C and below, the take-off must be preceded by an engine static run-up to 50% N1 or greater and stable engine operation checked before the start of the take-off run. FCOM 3 refers. If the aircraft has been either de-iced or anti-iced, a pre take-off inspection of the wing upper surfaces must be carried out just prior to take-off for evidence of ice, snow or frost accretion. If the anti-icing holdover time has expired, a visual inspection of the wings for contamination must be performed within the 5 minutes immediately prior to take-off.

### Contaminated Runway

Take-off from an icy runway is not recommended. The minimum friction co-efficient for take-off is:

- 0.2 FC (ICAO)
- 0.26 CRFI (Canada)
- 20 ACBA (USA)

Operations from contaminated runways require a higher level of attention. Slush, standing water, or deep snow, reduce the aircraft take-off performance due to increased rolling resistance and the reduction in tyre-to-ground friction. Refer to FCOM 2 for recommended maximum depth of contaminant.

The use of FLEX thrust for take-off is prohibited. However, DRT thrust may be used as required to optimise aircraft performance. During operations on contaminated runways, ensure that engine thrust advances symmetrically. This will help minimise potential directional control problems.

Before applying thrust, ensure that the nose wheel is straight. Any tendency to deviate from the runway centreline must be immediately countered with rudder. Avoid over-controlling on the rudder, as this may induce lateral control difficulties.

Precipitation drag reduces the initial acceleration. A higher flap setting increases the RTOW for a particular runway, but reduces the second segment climb gradient.



## Windshear

Awareness of the weather conditions which result in windshear will reduce the risk of an encounter. Studying meteorological reports and listening to tower reports will assist in the assessment of the weather conditions to be expected during take-off.

If a windshear encounter is likely, the take-off should be delayed until the conditions improve, e.g. until a thunderstorm has cleared the airport. If the winds affecting the airport are not necessarily associated with a temporary short-term weather phenomenon, then choose the most favourable runway and thrust setting. i.e. TOGA thrust.

Before take-off, use the weather radar and PWS to ensure the planned flight path is clear of any problem areas.

On aircraft fitted with PWS, an alert may be generated on the runway before take-off, in which case the take-off should be delayed. The PWS is described in detail in FCOM 1.34. Additionally, after liftoff, the FMGEC reactive windshear warning system may be triggered in the event of a shear being experienced by the aircraft. The reactive windshear warning system is described in detail in FCOM 1.22.

On the take-off roll, closely monitor airspeed and airspeed trend. Without PWS, windshear can be detected by significant and rapid speed variation on the PFD speed tape. If this occurs below V<sub>1</sub>, the Captain should reject the take-off only if he considers that there is sufficient runway remaining to stop the aircraft. If a rejected take-off is not possible, select TOGA thrust, continue the take-off and apply the checklist actions from memory.

On receipt of a reactive "WINDSHEAR" warning, select TOGA thrust and apply the checklist actions from memory.

If windshear is encountered and the take-off is continued, the PF calls "Windshear Go", implying that no configuration change will occur until clear of the shear. The following points should be stressed:

- If encountered above V<sub>1</sub> but below VR, a normal rotation should be initiated no later than 2000 ft before the end of the runway, even if airspeed is low.
- The configuration should not be changed until positively out of the shear as the operation of the landing gear doors induces additional drag.
- Follow the SRS, even if this requires the use of full back stick. As the speed begins to recover, the pilot can reduce back stick while still following SRS orders until well clear of the shear.
- The PNF should call RA, RA trend and V/S and significant related trends.
- When clear of the shear, report the encounter to ATC.



On receipt of a predictive “WINDSHEAR AHEAD” warning, apply the checklist actions from memory. If the warning occurs before 100kt, stop. If the warning occurs once airborne, select TOGA and follow the SRS. Continue the departure and clean up as normal unless windshear is encountered or a “WINDSHEAR” warning occurs.

Selection of the TERR ON ND pb will inhibit the display of the WINDSHEAR AHEAD display on that pilot’s ND.

### **Strong Crosswind and Gusty Conditions**

For take-off in strong, variable crosswinds and/or gusty conditions the use of TOGA thrust is recommended. The use of a higher thrust setting reduces the required runway length and minimizes the aircraft’s exposure to gusty conditions during rotation, lift-off and initial climb.

When the reported wind is at, or near to, 90° to the runway, the possibility of wind shifts, that may result in gusty tailwind components during rotation, or lift-off, increase. The influence of the airport terminal, aircraft hangars, and topographical features can have a significant effect on the crosswind and produce additional turbulence.

INTENTIONALLY  
BLANK



## **PREFACE**

For the purpose of this manual, initial climb is considered to be from the take-off through to the completion of flap retraction.

## **LIFT-OFF**

A positive rate of climb should be confirmed on the VSI and RA before ordering "Gear Up". After confirming increasing RA and positive V/S, the PNF calls "Positive Rate, Gear Up" and then selects the gear up.

## **AP ENGAGEMENT**

The AP can be engaged 5 seconds after takeoff and above 100 ft RA. Trim the aircraft and satisfy the FD commands prior to AP engagement. This will prevent undesirable excursions from the desired flight path.

## **VERTICAL PROFILE**

SRS engages when the thrust levers are set to the FLEX/TOGA detent for take-off and will remain engaged until the acceleration altitude. SRS orders provide a speed target of  $V_2+10$  (or with one engine inop, the IAS at the time of failure with a minimum of  $V_2$  and a maximum of  $V_2+15$ ), but within pitch and gradient limits. Consequently, it is possible that the IAS demanded by the FDs may be higher than  $V_2+10$  (or  $V_2$  with one engine inop).

## **LATERAL PROFILE**

Under most circumstances, expect to follow the programmed SID. In this case, NAV is armed on selecting the thrust levers to the applicable detent for take-off and engages once above 30 ft RA.

ATC may require the aircraft to maintain a specific heading after take-off. In this case, and prior to commencing the take off roll, turn the FCU HDG selector to the required heading. This process will disarm NAV. Once airborne and above 30 ft RA, RWY TRK engages. When required, pull the FCU HDG knob to establish the required heading.





## **THRUST REDUCTION ALTITUDE**

At the thrust reduction altitude, "LVR CLB" flashes on the FMA. Follow the FD pitch command before selecting the thrust levers to the CL detent, at which point A/THR becomes active. The FD pitch down order depends on the amount of thrust decrease between TOGA /FLEX and CLB.

Following thrust reduction with all engines operating, the PNF selects Pack 1 on, pauses 5 to 10 sec, and then selects Pack 2 on. With an engine failure before thrust reduction altitude, this procedure is delayed until MCT is set and the aircraft climbing at Green Dot.

## **ACCELERATION ALTITUDE**

At the acceleration altitude, the FD pitch mode changes from SRS to CLB, (or OP CLB if HDG were pre-selected prior to take off). The speed target becomes either the preset climb speed, if one had been entered on the PERF CLB page, or the managed climb speed. At heavy weights, Green Dot speed is normally higher than the managed speed target. In this case, when Flaps 0 is selected, the aircraft will accelerate past the managed speed target to Green Dot.

The minimum speed for moving the flap lever to 1 is displayed as F on the PFD speed tape. The minimum speed for moving the flap lever to 0 is displayed as S on the PFD speed tape. The PNF positively cross checks that the speed is above the minimum before moving the flap lever.

Flaps 1 should only be selected when:

- No longer in SRS
- Above F speed and accelerating

Flaps 0 should only be selected when:

- No longer in SRS
- Above S speed and accelerating with the next speed target at least Green Dot

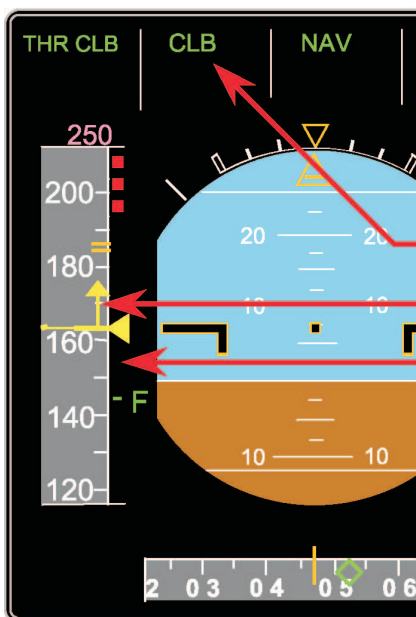

**Prerequisites for Flap Retraction:**

Not in SRS

Accelerating

Speed above 'F' or 'S'.

**NOTE:**

Flap handle in the '2' or '3' detent, 'F' is in view.

Flap handle in the '1' detent, 'S' is in view.

If the take-off configuration was CONF 2 or 3, then F will be displayed on the PFD speed tape. Once above F speed and accelerating (it is not necessary that the target speed be S or faster), the PF requests "Flaps 1". The PNF confirms that the speed is above F, repeats the call and then selects Flaps 1. The PNF visually confirms that the E/WD displays "1+F" in blue while the surfaces are in transit. He then checks that both the "1+F" and the flap position indication turn green when the surfaces reach their commanded position. Once above S speed and accelerating to a target speed of green dot or greater, the PF request "Flaps zero". The PNF confirms that the speed is above S, repeats the call and then selects Flaps 0. The PNF visually confirms that the E/WD displays "0" in blue while the surfaces are in transit. He then checks that both the "0" and the slat/flap position indication disappear when the surfaces are fully retracted. Manoeuvring in the clean configuration with the speed below Green Dot is not recommended.

Once the aircraft is in the clean configuration, the PNF disarms the ground spoilers and turns off the NOSE and RWY TURN OFF lights. Above the applicable sector MSA, the TERR ON ND pb should be deselected if used during take-off. When workload permits, call for the After Take-off checklist. Once clear of any significant weather, call for the seatbelt sign to be cycled, signalling that the cabin crew can commence the cabin service.



Obstacle clearance, noise abatement, or departure procedures may require an immediate turn after take-off. Provided FD commands are followed accurately, the flaps and slats may be retracted using the normal procedure as FD orders provide bank angle limits with respect to speed and configuration. However, without FD guidance, bank angle must be limited to 15° until S speed with Flaps 1 selected, or Green Dot in the clean configuration.

## TAKE-OFF AT HEAVY WEIGHT

At heavy weights, F speed may be close to VMAX CONF 2 and S speed will be above VMAX CONF 1+F (A333/A343: 215 kt) (A346: 233 kt), which is displayed on the PFD speed tape as a red and black strip in accordance with flap lever position. In this case, three protection systems are available:

- The Flap Load Relief System (FLRS)
- The Automatic Retraction System (ARS)
- The Alpha Lock Function

### The Flap Load Relief System

While in CONF 2 and when IAS reaches VMAX CONF 2, the FLRS is activated. The FLRS automatically retracts the flaps to the next further retracted position. VMAX CONF 2 remains unchanged on PFD speed scale in accordance with the flap lever position. "RELIEF" is displayed on the E/WD Flap/Slat indication. If IAS decreases below VMAX CONF 2, the flaps will re-extend.

### The Automatic Retraction System

While in CONF 1+F, as the aircraft accelerates towards VMAX CONF 1+F, the Automatic Retraction System retracts the flaps to 0° (CONF 1) (A333/A343: 200 kt) (A346: 215 kt). VMAX displayed on the PFD changes from VMAX CONF 1+F to VMAX CONF 1. As the aircraft accelerates above S speed, the flap lever can be selected to 0, provided the target speed is Green Dot or greater. F and S speeds are minimum speeds for flaps and slats retraction and not the speeds at which the selection must be made. If IAS decreases below (A333/A343: 200 kt) (A346: 215 kt), the flaps will not re-extend.

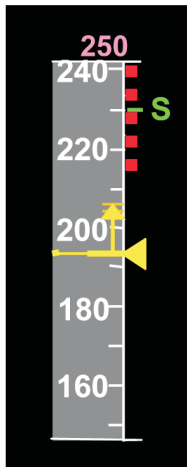

V<sub>MAX</sub> 215

Below  
200KT

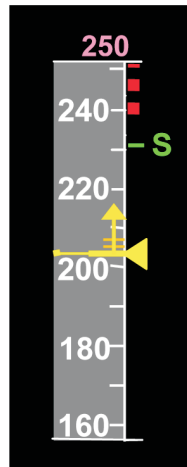

V<sub>MAX</sub> (240)

Above  
200KT

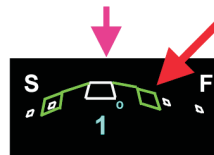
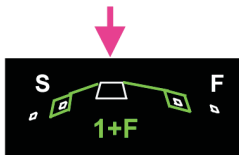

Flap Auto  
Retract

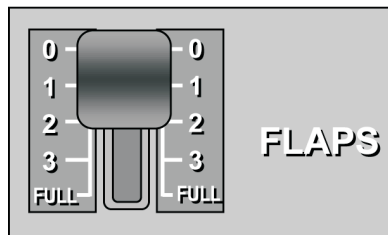

Flap Handle  
at '1'.

Flaps Auto Retraction Indications  
(Example for A333)



## The Alpha Lock Function

The slats alpha/speed lock function will prevent slat retraction at high AOA or low speed at the moment the flap lever is moved from Flaps 1 to Flaps 0. "A LOCK" pulses in green above the E/WD slat indication. This is possible if maneuvering during a heavy weight take-off. Continue with the scheduled acceleration that will eventually trigger slats retraction.

The inhibition is removed and the slats retract when both alpha and speed fall within normal values. This protection feature is no longer available once the flap lever has been selected to zero.

## TRACKING THE LOCALISER OF THE OPPOSITE RUNWAY

If the aircraft is required to track the localiser of the opposite runway, the ILS must be correctly set on the MCDU RADNAV page to allow monitoring of localiser deviation in the correct sense.

If the ILS is in the database, the FMGC should automatically tune the correct frequency and course, which should be the take-off runway course preceded by a "B".

If the ILS is not stored in the database or the FMGC fails to tune the correct frequency and course, manually insert the ILS frequency (or ident), and the take-off runway course preceded by a "B". For example, if the ILS frequency and associated course of the opposite runway were 109.9/073°, and the take-off direction was therefore 253°, insert frequency 109.9 and course B253. "B/C" will be displayed on the ND (ROSE LS) and PFD (LS) in magenta.

If the RWY/ILS MISMATCH message is displayed in the MCDU scratchpad, it may be disregarded.

Use NAV mode for departure and monitor localiser tracking on the PFD by pushing the LS pb on the EFIS CTL panel, or on the ND by selecting ROSE LS. Both the PFD and ND will display localiser deviation in the correct sense. Do not select the LS pb on ISIS, since the ISIS displays localiser deviation in the reverse sense.



## **LOW ALTITUDE LEVEL-OFF**

If the aircraft is required to level-off below the acceleration altitude, ALT\* engages and SRS disengages. The "LVR CLB" message flashes on the FMA and the target speed goes to the initial climb speed. Thrust levers should be selected to the CLB detent to engage SPEED mode. In this case expect a faster than normal acceleration and be prepared to retract the flaps and slats promptly.

## **CLOSE-IN TURN AFTER TAKE-OFF**

Where limited acceleration is required to comply with SID tracking or altitude requirements, pre-select a suitable speed in the PERF CLB page. The pre-selected speed should be above F speed to allow initial flap retraction to CONF 1. Delaying the acceleration by inserting a higher ACCEL ALT in the MCDU is not recommended.

INTENTIONALLY  
BLANK



## TABLE OF CONTENTS

### Climb, Cruise And Descent

#### Climb

Preface .....	5.10.1
Climb Thrust .....	5.10.1
Lateral Navigation .....	5.10.2
Vertical Navigation .....	5.10.2
Speed Considerations .....	5.10.3
Altitude Considerations .....	5.10.3
Adverse Weather .....	5.10.4

#### Cruise

Preface .....	5.20.1
FMS Use .....	5.20.1
Cost Index .....	5.20.2
Speed Considerations .....	5.20.3
Altitude Considerations .....	5.20.4
Lateral Navigation .....	5.20.5
Vertical Navigation .....	5.20.6
Fuel .....	5.20.8
Adverse Weather .....	5.20.9
Polar Operations .....	5.20.10
Descent Preparation .....	5.20.11
Approach Briefing .....	5.20.12





## **Descent**

TOD Computation .....	5.30.1
Lateral Navigation .....	5.30.2
Vertical Navigation .....	5.30.2
Speed Considerations .....	5.30.5
Descent Monitoring .....	5.30.5
Descent Adjustment .....	5.30.6
Descent Constraints .....	5.30.6
Arrival Operating Speeds .....	5.30.6
Adverse Weather .....	5.30.6



## PREFACE

For the purpose of this manual, the climb phase is considered to be from the end of the flap retraction to the top of climb. Note however, that the FMGS enters the climb phase when SRS disengages.

## CLIMB THRUST

During the climb with the thrust levers in the CL detent, the A/THR is active in thrust mode and the FADECs manage the thrust to a maximum value depending upon ambient conditions.

Engine life is extended by operating the engines at less than maximum climb rated thrust. Two levels of derated climb thrust can be selected on the PERF CLB page:

- D1, which reduces the maximum climb thrust by 5 to 10 %
- D2, which reduces the maximum climb thrust by 10 to 15 %

If a derated climb has been entered prior to departure, "THR DCLB 1(2)" will be displayed on the FMA when the thrust levers are set to the CL detent at the thrust reduction altitude. The FADEC progressively reduces the derate with increasing altitude until it is zero at approximately (A343: FL250) (A333/A346: FL340). Climb performance is reduced when using derated climb thrust but the ceiling is not affected. The use of D1 is encouraged at all times and the use of D2 whenever operationally feasible. The level of derate may be modified or cancelled at any stage via the PERF CLB page.



## LATERAL NAVIGATION

With the AP/FD in NAV, the aircraft will follow the programmed SID. If a deviation from the programmed SID is required, e.g. ATC vectors or weather avoidance, select HDG. If HDG is selected, the climb mode reverts to OP CLB. When cleared to a specific waypoint, perform a DIR TO to ensure correct waypoint sequencing, and re-engage CLB mode.

## VERTICAL NAVIGATION

The AP/FD climb modes may be either

- Managed
- Selected

Both climb modes can be flown with either managed or selected speed.

### Managed Climb Mode

The managed AP/FD mode in climb is CLB. Its use is recommended as long as the aircraft is cleared along the F-PLN. Although CLB mode will try to observe altitude constraints, the next climb altitude is always set on the FCU. CLB mode will not adjust aircraft speed to achieve altitude constraints.

### Selected Climb Mode

The selected AP/FD modes in climb are OP CLB or V/S.

OP CLB is to be used if ATC gives radar vector or clears the aircraft direct to a given FL without any climb constraints. Any programmed FMGS climb constraints will be ignored.

The use of low values of V/S, e.g. 1000 fpm or less, may be appropriate for small altitude changes as it makes the guidance smoother and needs less thrust variation. In areas of high traffic density, low values of vertical speed will reduce the possibility of nuisance TCAS warnings. As a guide, a value of +1000 ft/min is appropriate when in close proximity to other aircraft. The A/THR mode will automatically revert to SPEED and adjust thrust to maintain the target speed.

Whenever V/S is used, pay particular attention to the speed trend as V/S takes precedence over speed requirements. If the pilot selects too high a V/S, the aircraft may be unable achieve both the selected V/S and target speed with Max Climb thrust. In this case, the AP/FD will guide to the target V/S, and the A/THR will command up to Max Climb thrust and allow the speed to decelerate. When VLS is reached the AP will pitch the aircraft down so as to fly at a V/S to maintain VLS.



## **SPEED CONSIDERATIONS**

### **Managed**

The managed climb speed, computed by the FMGS, provides the most economical climb profile as it takes into account weight, actual and predicted winds, ISA deviation and Cost Index (CI). The managed climb speed also takes into account any speed constraints, e.g. the default speed limit, which is normally 250 kt up to 10000 ft. At heavy weights, Green Dot can be greater than 250 kt. In this case, the aircraft accelerates to Green Dot even though the magenta speed target on the PFD indicates 250 kt. When the default speed limit no longer applies, the magenta speed target becomes ECON climb speed and the aircraft will accelerate.

### **Selected**

If necessary, the climb speed can be selected on the FCU. This may be required to comply with climb constraints, ATC clearances or during weather avoidance or penetration.

The speed to achieve the maximum rate of climb, i.e. to reach a given altitude in the shortest time, is situated between ECON climb speed and Green Dot. There is no specific indication of this speed on the PFD. A rule of thumb to achieve maximum rate climb is to select 285 kt/0.78M.

The speed to achieve the maximum gradient of climb, i.e. to reach a given altitude in a shortest distance, is Green Dot. The PERF CLB page displays the time and distance required to achieve the selected altitude by climbing at Green Dot speed under the "Expedite" heading. Avoid reducing to Green Dot at high altitude, particularly at heavy weight, as it can take a long time to accelerate to cruise mach number. There is no operational benefit from selecting a speed lower than green dot. When IAS is selected, there is no automatic changeover to Mach.

## **ALTITUDE CONSIDERATIONS**

The PROG page provides:

- REC MAX FL
- OPT FL



## **REC MAX FL**

The recommended maximum flight level is computed as a function of present gross weight and temperature. It provides a 0.3 g buffet margin, a 300 ft/min rate of climb at maximum climb thrust and level flight at maximum cruise thrust. It is limited to FL411. If a FL higher than REC MAX is inserted into the MCDU, it will be accepted only if it provides a buffet margin greater than 0.2 g. Otherwise, it will be rejected and the message "CRZ ABOVE MAX FL" will appear on the MCDU scratchpad. Flight above FL411 is prohibited and MCDU entries above FL411 will be rejected with the message "ENTRY OUT OF RANGE".

## **OPT FL**

The optimum flight level is computed as a function of present gross weight, CI, temperature, winds and a minimum estimated cruise time of 15 min. The optimum flight level will never be greater than the recommended maximum flight level. Provided there are no operational constraints, fly as close as possible to the optimum flight level.

## **Altitude Constraint**

The altitude constraints in the F-PLN are observed only when the climb is managed, i.e. when CLB is displayed on the FMA. Any other vertical mode will disregard altitude constraints. During all climbs, ensure that the next altitude restriction is set on the FCU.

## **ADVERSE WEATHER**

Adverse weather which may be encountered during the climb includes:

- CB activity
- Icing
- Turbulence



## CB Activity

Areas of known turbulence associated with CBs should be avoided. Good radar tilt management is essential to accurately evaluate the vertical development of CBs. Normally the gain should be left in AUTO. However, selective use of manual gain may help in the assessment of the overall weather situation. Manual gain is particularly useful when operating in heavy rain if the radar picture has become saturated. In this instance, reduced gain will help the crew identify the areas of heaviest water droplet concentration, normally associated with active CB cells. After using manual gain, it should be re-selected to AUTO to recover optimum radar sensitivity. A decision to avoid a CB should be made as early as possible and lateral avoidance should ideally be 20 nm.

Cathay Pacific Weather Radar manual refers.

## Icing

Whenever icing conditions are encountered or anticipated, ENG ANTI-ICE should be selected on. Even though the actual TAT prior to entering cloud might not require engine anti-ice, crews should be aware that the TAT often decreases significantly when entering cloud. When the SAT reduces to below -40°C, engine anti-ice should be selected off, unless flying in the vicinity of CBs. Failure to follow the recommended anti-ice procedures may result in engine stall, over-temperature or engine damage.

Wing anti-ice should be selected if either severe ice accretion is anticipated or there is an indication that airframe icing exists.

## Turbulence

If turbulence is anticipated or encountered, consider reducing speed towards turbulence speed for passenger comfort. If severe turbulence is anticipated or encountered, reduce speed to turbulence speed.

A333	A343	A346
240 kt up to FL 200 then 260 kt / M0.78	260 kt up to FL 200 then 280 kt / M0.78	280 kt up to FL 220 then 300 kt / M0.81

### Severe Turbulence Speeds

The flight control law is designed to cope with turbulence. If flying manually, avoid the temptation to over-control on the sidestick in an attempt to overcome the turbulence.

INTENTIONALLY  
BLANK



## **PREFACE**

Once the cruise flight level is reached, “ALT CRZ” is displayed on the FMA, and cruise Mach number for best economy based on cost index is targeted by the A/THR system. On reaching cruise level, the PF shall confirm the commanded thrust is set correctly and the desired speed/mach target is properly maintained.

If ATC limits CRZ FL to a lower level than that displayed on the PROG page, insert this lower CRZ FL. Otherwise, there is no transition into CRZ phase: consequently the managed speed and Mach targets are not modified and A/THR SOFT mode is not available. FMA will display ALT instead of ALT CRZ in the second column.

When established in the cruise, conduct an abbreviated flow pattern to ensure correct switch positions. In addition, relevant SD pages are selected to monitor system operation and trends. This scan of panels and system pages should be repeated at least once per hour during the cruise. In addition, ECAM MEMO should be routinely scanned as it serves as a reminder of system functions or crew actions that are normally only required for a relatively short period of time.

VLS shown on the PFD ensures 0.3 g buffet margin, and therefore no additional margin is necessary in cruise.

## **FMS USE**

When reaching cruise FL, ensure that the wind and temperatures are correctly entered and that the lateral and vertical F-PLN reflect the CFP. This is normally done by the PNF. Wind entries should be made at waypoints when there is a difference of either 30° or 30 kts for the wind data and 5°C for temperature deviation. These entries should be made for as many levels as possible to reflect the actual wind and temperature profile. This will ensure that the FMS fuel and time predictions are as accurate as possible and provide an accurate OPT FL computation.

Sensible use of the ETP function will assist the crew in making a decision should an enroute diversion be required. Suitable airport pairs should be entered on the ETP page and the FMS will then calculate the ETP. Each time an ETP is sequenced, insert the next suitable diversion airfield. Additionally, the PROG page can be used to provide an indication of direct track to any selected en-route diversion airfield.

The SEC F-PLN is a useful tool and should be used practically. By programming a potential enroute diversion, workload would be reduced should a failure occur. This is particularly significant when terrain considerations apply to the intended diversion route.



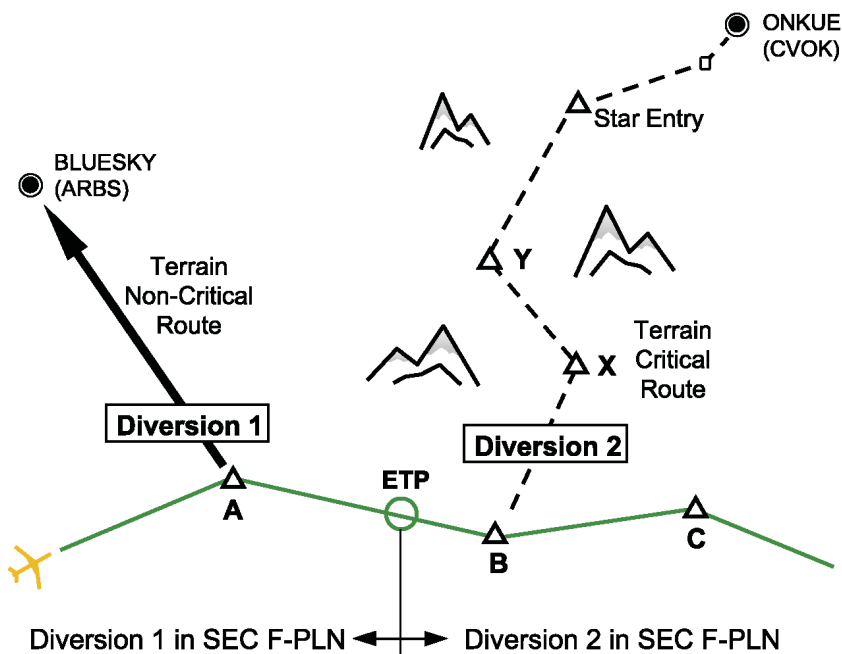

### Example of SEC F-PLN Use During the Cruise

The DATA > STORED ROUTES function in the MCDU can be used to store up to five possible diversion routes. These routes can be entered into the SEC F-PLN using the SEC INIT prompt. This prompt will only be available if the SEC F-PLN is deleted. FCOM 4.04.30 refers.

### COST INDEX

The CI is calculated by the Company, taking into account several parameters. From an operational point of view, the CI affects speeds and cruise altitude. CI 0 corresponds to minimum fuel consumption whereas CI 999 corresponds to minimum flight time. From a practical point of view, CI 0 equates to maximum range. The CI should be considered as a means of long-term speed management rather than a means of short-term speed control. For example, if a speed reduction is required for the entire flight to comply with curfew requirements, then it would be appropriate to reduce the CI. CI for LRC are approximately **A333: 40**, **A343: 50** and **A346: 140**.

The SEC F-PLN can be used to check the predictions associated with a new CI. However, be aware that any modification of the CI in the primary F-PLN will affect trip cost.



## **SPEED CONSIDERATIONS**

With "ALT CRZ" annunciated on the FMA, the A/THR engages in "soft" mode, which means that small deviations around the target Mach (typically  $\pm 4$  kt) are tolerated before a thrust adjustment occurs. This minimises cruise fuel consumption.

The cruise speed may be either:

- Managed
- Selected

### **Managed**

When the cruise altitude is reached, i.e. "ALT CRZ" on the FMA, the A/THR operates in SPEED/MACH mode. The optimum cruise Mach number is automatically targeted. Its value depends on:

- Cl
- Cruise flight level
- Temperature deviation
- Weight
- Headwind component.

The optimum Mach number will vary according to the above-mentioned parameters, e.g. it will increase with an increasing headwind. If there is no overriding operational constraint, e.g. ATC speed control, the managed Mach should be maintained as it provides the optimum trip cost.

Should ATC require a specific time over a waypoint, enter a time constraint at that waypoint via a vertical revision. The managed Mach number will be modified accordingly, between Green Dot and M0.84, in an attempt to achieve this constraint. If the constraint can be met within the defined tolerance, a magenta asterisk will be displayed on the MCDU. If the constraint cannot be met, an amber asterisk will be displayed. Once the constrained waypoint is sequenced, the ECON Mach is resumed. FCOM 4 refers.



## **Selected**

Should ATC require a specific cruise speed, or turbulence penetration is required, select the new cruise speed on the FCU. FMS predictions are updated accordingly until reaching either the next step climb or TOD, at which point the programmed speeds apply again. The FMS predictions are therefore realistic.

At high altitude, the speed should not be reduced below Green Dot as this may create a situation where it is impossible to maintain speed and/or altitude as the increased drag may exceed the available thrust.

## **ALTITUDE CONSIDERATIONS**

The PROG page displays:

- REC MAX FL
- OPT FL

### **REC MAX FL**

REC MAX reflects aircraft performance and does not take into account the cost aspect. Unless there are overriding operational considerations, REC MAX should be considered as the upper cruise limit.

### **OPT FL**

OPT displayed on the PROG page is the cruise altitude for minimum cost when ECON MACH is flown and should be followed whenever possible. It is important to note that the OPT FL displayed on the PROG page is meaningful only if the wind and temperature profile has been accurately entered. Flying at a level other than the OPT FL adversely affects the trip cost.

For each different Mach number, there will be a different OPT FL. Should an FMGS failure occur, the crew should refer to the FCOM to determine the OPT FL. FCOM charts are only provided for two different Mach numbers.

### **RVSM**

At intervals of approximately one hour, cross check the validity of primary altimeters. A minimum of two must agree within  $\pm 200$  ft. Failure to meet RVSM requirements should be notified to ATC and recorded in the Aircraft Maintenance Log. Vol 2 Pt 2 refers.



## LATERAL NAVIGATION

When approaching each waypoint, visually check track and distance to the next waypoint on the F-PLN page against CFP or enroute chart. It is not necessary to verbalise this check. Make optimum use of MCDU (FCOM 4 refers).

On aircraft equipped with GPS, a navigation accuracy check is not required as long as GPS PRIMARY is available.

Without GPS PRIMARY, navigation accuracy should be monitored, particularly when any of the following occurs:

- IRS only navigation
- The PROG page displays LOW accuracy
- "NAV ACCUR DOWNGRAD" appears

If HIGH ACCURACY is displayed on the PROG page, the FM accuracy meets the required criteria. Nevertheless, perform a check periodically when navigation aids are available to allow any FM position error to be quantified against the raw data on the ND. There are two methods of performing an accuracy check:

- On the RAD NAV page, manually tune a VOR/DME to a station that is within range and select the associated needle on the ND. Check that the needle (which is raw data) overlies the corresponding blue navaid symbol (which is FM computed) and that the DME distance is equal to the distance showing between the aircraft symbol and the navaid symbol on the ND.
- Insert a VOR/DME ident in BRG/DIST TO field on the PROG page and compare the FM computed BRG/DIST with the raw data on the ND.

When operating on routes with Required Navigation Performance (RNP), ensure that the ESTIMATED navigation accuracy indicated on the PROG page is better than the RNP value for the route.



## **VERTICAL NAVIGATION**

### **Step Climb**

Since the optimum altitude increases as fuel is consumed during the flight, from a cost point of view, it is preferable to climb to a higher cruise altitude every few hours. This technique, referred to as a Step Climb, is typically accomplished by initially climbing approximately 2000 ft above the optimum altitude and then cruising at that flight level until approximately 2000 ft below the new optimum altitude. In RVSM airspace, it is possible to bracket the optimum altitude by 1000 ft.

Step climbs can either be planned at waypoints or be optimum step points calculated by the FMGS. The FMGS computed step climb provides for minimum trip cost for the flight. The CFP tends to indicate a step climb as soon as the predicted aircraft weight would allow. Constraints in the CFP design mean that climbs can only be designated at waypoints and not at the ideal point. For most flights, one or more step climbs may be required. It may be advantageous to request an initial cruise altitude above optimum, if altitude changes are difficult to obtain on specific routes. This could minimise the possibility of being held at a low altitude and high fuel consumption condition for a long period of time. The requested/cleared cruise altitude should be compared to the REC MAX altitude. Before accepting an altitude above optimum, determine that it will continue to be acceptable considering the projected flight conditions such as turbulence, standing waves or temperature change.

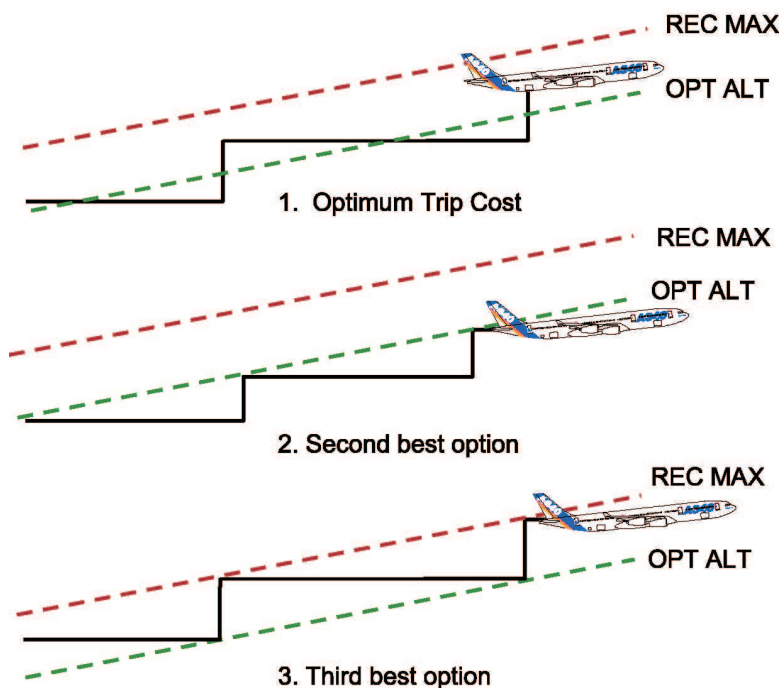

### Step Climb Strategies

The selected cruise altitude should normally be as close to optimum as possible. As deviation from optimum cruise altitude increases, economy decreases.

The following diagram shows an approximation of the fuel penalties for flying at cruise levels other than optimum. Note that these figures only reflect fuel penalties as opposed to overall trip cost. For example, flying at a higher level often increases the flight time and consequently the overall trip costs.

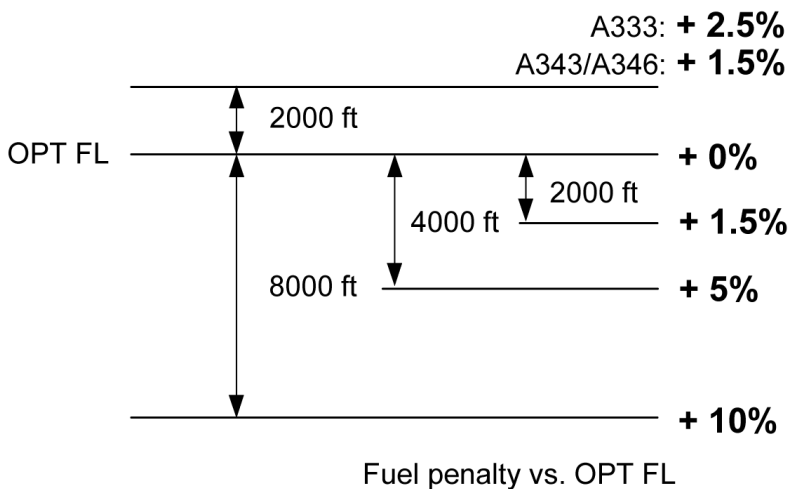

## FUEL

### Fuel Monitoring

The flight plan fuel burn from departure to destination is based on certain assumed conditions. These include gross weight, cruise altitude, planned route, temperature, cruise wind and cruise speed. Actual fuel consumption should be compared with the flight plan fuel consumption at least once every hour.

Many factors influence fuel consumption such as actual flight level, cruise speed, aircraft weight and unexpected meteorological conditions. If fuel consumption appears higher than expected, then calculate the actual kg/gnm and compare this with the planned figure on the Fuel Progress Log. The actual kg/gnm is calculated by dividing the actual fuel burn per hour by the groundspeed.

If planned and actual fuel figures deviate significantly without reason, then suspect a fuel leak and apply the appropriate procedure.

ECAM FOB, Fuel Prediction (FMGC) and CFP should be used to maintain an awareness of the current and predicted fuel state. Both the ECAM FOB and the fuel remaining determined by calculating the difference between BEFORE START fuel and ECAM FUEL USED, are recorded on the Fuel Log. The lesser (more conservative) of these figures is used for decision making.



At least once every hour, when passing over a waypoint, perform the following fuel check:

- Enter ECAM FOB in the GAUGE / TOTALISER column, on the CFP progress log.
- To the right of FOB, enter the F.USED from the ECAM CRZ page.
- Subtract the F.USED from the BEFORE START fuel to obtain the Fuel Remaining, and enter to the right of F.USED.
- Enter the lesser of FOB and Fuel Remaining in the ACTUAL FUEL column.
- From the ACTUAL FUEL subtract the FR X CONT X MAND and enter the result in the 'CONT / MAND / EXTRA' column for the waypoint.
- Compare this result against the CFP planned contingency fuel in the adjacent column.

## Fuel Temperature

Extended cruise operations increase the potential for fuel temperatures to reach the freeze point. Fuel freeze refers to the formation of wax crystals suspended in the fuel, which can accumulate when fuel temperature is below the freeze point. This can prevent proper fuel feed to the engines.

During normal operations, fuel temperature rarely decreases to the point that it becomes limiting. Fuel temperature will slowly reduce towards TAT. If fuel temperature approaches the minimum allowed, attempt to achieve a higher TAT by descending or diverting to a warmer air mass, or increasing Mach number. When flying above the tropopause, TAT may only increase if descent is made to a level below the tropopause. In this case, consider climbing to increase TAT. Below the tropopause, if a descent is required, the CFP step below altitude usually results in sufficient increase in TAT. A 4000 ft descent will normally give a 7°C increase in TAT. An increase of 0.01 Mach will increase TAT approximately 0.7°C. Up to one hour may be required for the fuel temperature to stabilise.

## ADVERSE WEATHER

In addition to the adverse weather phenomena encountered in the climb, a further consideration in the cruise is CAT. CAT can be anticipated by reference to weather charts and pilot reports. As water droplets are not associated with CAT, it cannot be detected by the radar. If appropriate, consider avoiding CAT vertically. Be aware however, that the buffet margin reduces with increasing altitude.

If severe turbulence is encountered and thrust changes become excessive, select the A/THR off and set N1 manually with reference to the severe turbulence table in the QRH.





## **POLAR OPERATIONS**

### **Planning**

During the pre-flight planning stage, operations through extremely cold air masses or at extreme latitudes should be taken into consideration. Certain MEL items may preclude operations at such latitudes. Some routes may require more restrictive navigational capability or redundancy such as MNPS, RNP or RVSM procedures. Consideration should also be given to engine out, decompression and SAROPS contingencies.

### **Communications**

Above 82N, SATCOM is unavailable. HF frequencies and HF SELCAL must be arranged prior to the end of SATCOM coverage. Routine company communications procedures should include "flight following" to enable immediate assistance during a diversion or other emergency. Abnormal solar winds may affect HF communications. During periods of high cosmic or sunspot activity it may be difficult to maintain enroute communications by any method. This will remain the case until datalink upgrades become available. Experience has shown that there may be significant periods enroute when no communications with ATC are possible.

### **Navigation**

In polar regions the magnetic heading reference is completely unusable for navigation purposes. Magnetic variation is typically extreme and often not constant at a certain point. It will also change rapidly as aircraft position changes. TRUE NORTH reference is automatically commanded in the polar zone. The computer flight plan is conventional. For some high latitude airports, grid headings are shown on the instrument approach procedures. Note that unmapped areas in the GPWS terrain database may display MORA as 51.1 on the ND, regardless of the aircraft altitude.

The primary mode for AP/FD lateral navigation for polar operations is NAV, which may be used with the heading reference switch in the either position. HDG mode may be used for deviations from planned route but TRU heading reference should be selected. If the F-PLN crosses either the North Pole or the South Pole, a rapid heading and track reversal occurs passing the polar waypoint. If operating in HDG while near either pole, it is necessary to frequently update the heading selector to reflect the rapidly changing or reversed heading, otherwise the AP/FD may command an unwanted turn. For this reason, NAV is the preferred mode.



Due to differences in the FMGS and IRS positions and split IRS operation near the pole, the AP/FD will disengage if in HDG upon polar waypoint passage. It may be re-engaged and will function normally several miles after passing the polar waypoint. Loss of both GPS units results in an increased Estimated Position Error (EPE) and possible display of the "NAV ACCUR DOWNGRAD" message, but would not normally prevent polar operations. Loss of one or two IRs does not significantly affect navigation accuracy. However, operation with only one IRU would require a diversion to the nearest suitable airport.

True bearing VORs are not stored in the FM database. Such navigation aids may be built using standard three letter idents via Data > Stored NAVAIDS. They must be built referenced to MAG and therefore do not show correct relative bearings on the TRU referenced ND since the bearing is internally corrected by the FMGS.

The correct raw data radial is presented with either ILS or VOR mode selected on the ND. However, MAG is in amber indicating non-compatibility with the ND reference, when it is actually compatible. It is important to be aware of this when using this VOR information for en-route orientation purposes.

The recommended technique is to tune VORs using the frequency option rather than the ident on the RAD NAV page. This will present raw data only with correct relative bearings. NDBs in the Arctic are generally powerful and do provide reliable relative bearings.

If TRUE is selected for the ILS approach, the ILS may be flown to Cat 1 limits only.

## **DESCENT PREPARATION**

Obtain the latest destination weather approximately 15 minutes prior to descent and update the FMGS for the descent and arrival. During FMGS programming the PF will be head down, so it is important that the PNF does not become involved in any tasks that preclude close monitoring of the aircraft. The fuel predictions will be accurate if the F-PLN is correctly entered in terms of arrival, missed approach and alternate routeing. Once the FMGS has been programmed, the PNF should cross check the information prior to the approach briefing. With the descent winds entered and the F-PLN arrival properly validated, the FMGS can compute an accurate TOD position. Pilots should crosscheck the FMGS TOD position against their own independently calculated TOD point, based where possible on a DME distance from a navaid.

Outport stations should be contacted via ACARS preferably or VHF to advise of significant changes to the arrival information, ATA defect codes, or defects which could affect the normal taxi in and shutdown procedures, or dispatch on the next sector, etc. HKG need only be advised if Auto ACARS uplink of information is inoperative. Volume 2 Part 2 refers.



## **APPROACH BRIEFING**

The main objective of the approach briefing is for the PF to inform the PNF of his intended course of action for the approach. Additionally, potential threats should be highlighted, along with the strategies to minimise these threats. The briefing should be practical and relevant to the actual weather conditions expected. It should be given at a time of low workload if possible, to enable the crew to concentrate on the content. It is important that any misunderstandings are resolved at this time. FCTM Ch 10 refers.



## TOD COMPUTATION

The FMGS calculates the TOD point backwards from a position 1000 ft on the final approach with speed at VAPP. It takes into account any descent speed and altitude constraints and assumes managed speed is used. The first segment of the descent will always be at idle thrust until the first altitude constraint is reached. The idle segment assumes a small amount of thrust above idle to provide some flexibility to maintain descent profile in the event that engine anti-ice is used or if descent winds vary from forecast. Subsequent segments will be "geometric", i.e. the descent will be flown at a specific angle, taking into account any subsequent constraints. If the STAR includes a holding pattern it is not considered for TOD or fuel computation. The TOD is displayed on the ND track as a symbol: ↷

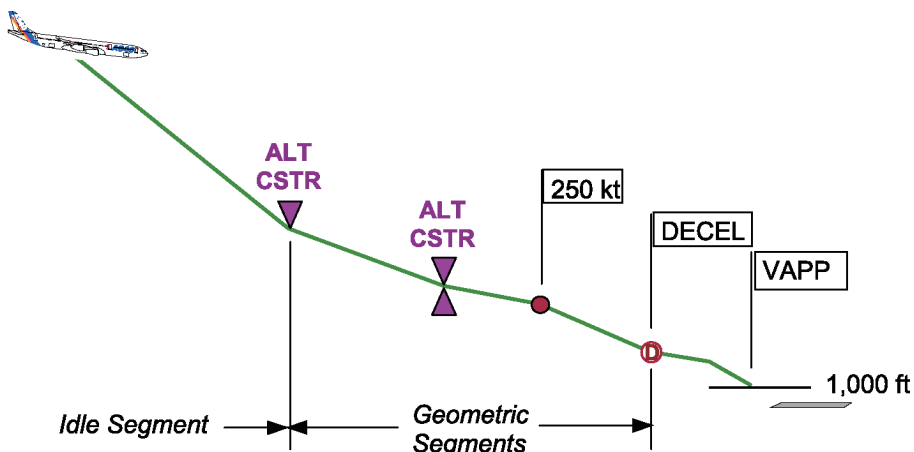

FMGS Descent Profile



## LATERAL NAVIGATION

With the AP/FD in NAV, the aircraft will follow the programmed STAR. If a deviation from the programmed STAR is required, e.g. ATC vectors or weather avoidance, select HDG. If HDG or TRK is selected while in DES mode, reversion to V/S mode occurs at current vertical speed, accompanied by a triple click aural warning. When cleared to a specific waypoint, perform a DIR TO to ensure correct waypoint sequencing, and re-engage DES mode.

## VERTICAL NAVIGATION

The AP/FD descent modes may be either

- Managed
- Selected

Both descent modes can be flown with either managed or selected speed.

### Managed Descent Mode

DES mode is available if NAV is engaged. To initiate a managed descent, set the ATC cleared altitude on the FCU and push the ALT selector at TOD. DES mode engages and is annunciated on the FMA. If an early descent is required by ATC, DES mode gives 1000 ft/min rate of descent until the computed profile is regained.

Be aware that altitude constraints in the flight plan are observed only when the descent is managed, i.e. when DES is displayed on the FMA. Any other vertical mode will disregard altitude constraints.

During a managed descent, with DES displayed on the FMA and the F-PLN accurately reflecting all altitude constraints, it is permissible to select the lowest ATC cleared altitude on the FCU and monitor that the correct profile is flown.

To avoid overshooting the computed descent path, push the FCU ALT selector a few miles prior to the calculated TOD. This method will ensure a controlled entry into the descent and is particularly useful in situations of high cruise Mach number or strong upper winds.

If the descent is delayed, a "DECELERATE" message appears on the PFD and MCDU scratchpad. Consider selecting speed towards Green Dot and when cleared for descent, push for DES and push for managed speed. The speed reduction prior to descent will enable the aircraft to recover the computed profile more quickly as it accelerates to the managed descent speed.



When DES is engaged and speed is managed, the AP/FD guides the aircraft along a pre-computed descent path determined by a number of factors such as altitude constraints, wind and descent speed. However, as the actual conditions may differ from those planned, the DES mode with managed speed operates within a speed range around a target speed to enable the aircraft to maintain the descent path.

If the aircraft gets high on the computed descent path, the speed will increase towards the upper limit of the speed range. If this increase in speed does not allow a descent constraint to be achieved, a message "EXTEND SPEEDBRAKES" is displayed on the PFD and MCDU scratchpad. A path intercept point  $\wedge$ , which assumes half speedbrake extension, will be displayed on the ND descent track. When regaining the descent profile, retract the speedbrakes to prevent the A/THR applying thrust against speedbrakes. If the speedbrakes are not retracted, the "SPD BRK" message on the ECAM memo becomes amber and "RETRACT SPEEDBRAKES" is displayed on the PFD.

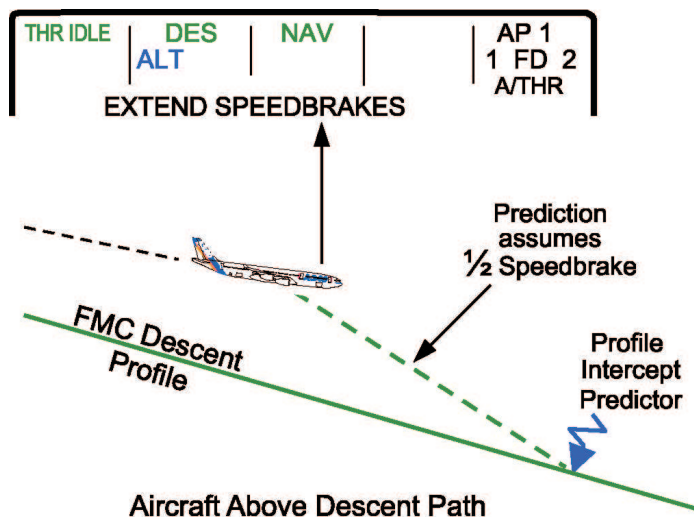

If the aircraft gets low on the computed descent path, the speed will decrease towards the lower limit of the speed range. When the lower speed limit is reached, the A/THR reverts to SPEED/MACH mode and applies thrust to maintain the descent path at this lower speed. A similar path intercept point  $\wedge$  will be displayed on the ND.

The computed descent path remains unchanged if speed is selected. As the selected speed may differ from the speed used for the pre-computed descent path and the speed variation around target no longer applies, the aircraft may deviate from the descent path.



## Selected Descent Mode

The selected AP/FD modes in descent are OP DES, V/S or less commonly FPA. During a selected descent with OP DES, V/S or FPA displayed on the FMA, successive altitude constraints must be set on the FCU. If under radar vectors, set the next ATC cleared altitude on the FCU.

OP DES is used if ATC gives radar vector or clears the aircraft direct to a given FL without any descent constraints. All FMGS descent altitude constraints will be ignored. V/S mode is normally used to recover from a below profile condition.

To initiate a selected descent, set the ATC cleared altitude on the FCU and pull the ALT selector at TOD. OP DES mode engages and is annunciated on the FMA. In OP DES, the A/THR commands THR IDLE and the speed is controlled by the elevators.

Speed may be either managed or selected. In managed speed, the descent speed is displayed as a magenta target only and there is no longer a speed target range. The computed descent path is ignored and consequently the speed will not vary around the target. The AP/FD does not consider any F-PLN descent altitude constraints and will fly an unrestricted descent down to the FCU selected altitude.

V/S can be used to adjust the rate of descent. The use of low values of V/S, e.g. less than 1000 fpm, may be appropriate for small altitude changes as it makes the guidance smoother and needs less thrust variation. In areas of high traffic density, low values of vertical speed will reduce the possibility of nuisance TCAS warnings. As a guide, a value of -1000 ft/min is appropriate when in close proximity to other aircraft. The A/THR mode will automatically revert to SPEED and adjust thrust to maintain the target speed. In this configuration, the use of speedbrakes is not recommended to reduce speed, as it is inconsistent with the A/THR mode. When in V/S mode, pay particular attention to the speed trend, as the AP will attempt to maintain the selected V/S irrespective of the effect this has on the aircraft speed. If the pilot selects a very high V/S, the aircraft may be unable achieve both the selected V/S and target speed with idle thrust. In this case, the AP/FD will guide to the target V/S, and the speed will increase. When VMAX is reached the AP will pitch the aircraft up so as to fly at a V/S to maintain VMAX.

In OP DES or V/S mode, the level arrow ↘ is displayed on the ND to indicate the interception point with the altitude set in the FCU.



## **SPEED CONSIDERATIONS**

### **Managed**

The managed descent speed computed by the FMGS defaults to ECON speed and provides the most economical descent profile as it takes into account weight, actual and predicted winds, ISA deviation and Cost Index (CI). If a speed is inserted into the PERF DES page for operational or policy reasons, then this becomes the managed speed for the descent. Once the descent phase is active, the managed descent speed cannot be modified. The managed descent speed also takes into account any speed constraints, which may be modified during the descent phase, e.g. the default speed limit, which is normally 250 kt below 10000 ft.

In turbulent conditions, adjust the speed or Mach target to allow adequate margin below VMO/MMO. In severe turbulence, select turbulence penetration speed. If the speed rapidly approaches the upper end of the managed speed band with the autopilot engaged, a transient increase above VMO is possible. Monitor the trend vector and, if an exceedance looks likely, either select a lower speed target on the FCU or select OP DES and a suitable speed below VMO. If the rate of exceedance is rapid, fly the aircraft manually. The autopilot will disengage if high speed protection is activated.

### **Selected**

If necessary, the descent speed can be selected on the FCU. This may be required to comply with descent constraints, ATC clearances or during weather avoidance or penetration. In selected speed, there is no longer a target speed range.

## **DESCENT MONITORING**

The PFD displays the magenta Vertical Deviation (VDEV) symbol which, within +/- 500 ft, indicates the aircraft's vertical displacement from the computed descent path. This information is only accurate if the aircraft is close to the lateral flight plan with the waypoints having sequenced correctly. The actual VDEV is also displayed numerically on the PROG page. VDEV information is available both in managed and selected descent.

At lower altitudes, when in HDG or TRK, the energy circle on the ND indicates the required distance to descend, decelerate and land from the present position.

The managed descent profile from high altitude is approximately  $2 \frac{1}{2}^\circ$ . As an estimation of the distance to touchdown is required to enable descent profile monitoring, it is important to ensure that the F-PLN plan page reflects the expected approach routeing. Gross errors in the descent profile are normally a result of either incorrect programming of the MCDU or non-sequencing of F-PLN waypoints, giving a false distance to touchdown.

FCTM Ch 10 refers.





## **DESCENT ADJUSTMENT**

Weather avoidance or ATC vectoring may require descent profile adjustment.

If the aircraft is below the profile, select a lower target speed or adjust the V/S. After regaining the profile, re-engage managed descent to maintain the FMGS computed profile.

If the aircraft is above the profile, an increased rate of descent will be required. Use speedbrake with OP DES, however be alert to the increased VLS at high altitude. ATC and weather conditions permitting, a higher speed may be selected.

## **DESCENT CONSTRAINTS**

Descent constraints may be automatically included in the route as part of an arrival procedure or may be manually entered through the F-PLN page. The aircraft will attempt to achieve the constraints provided DES mode is engaged. A DIR TO action in response to an ATC clearance to a STAR waypoint removes procedural altitude constraints. However, if intermediate waypoints altitude restrictions are relevant, e.g. for terrain awareness, or there is an ATC requirement, then perform the "DIR TO" with ABEAMS. Constraints can be re-entered at these abeam waypoints.

## **ARRIVAL OPERATING SPEEDS**

FCOM 3.03.01 refers.

## **ADVERSE WEATHER**

FCTM 5.10 refers.



## **TABLE OF CONTENTS**

### **Holding And Approach**

#### **Holding**

Preface.....	6.10.1
ICAO/FAA Maximum Holding Airspeeds.....	6.10.1
Holding Speed And Configuration.....	6.10.1
Holding Entry Procedures.....	6.10.1
In The Holding Pattern.....	6.10.2
Adverse Weather.....	6.10.2

#### **Procedural**

Procedure Turns.....	6.20.1
Procedural Approaches.....	6.20.1
Track Establishment.....	6.20.1

#### **Instrument Approaches**

Preface.....	6.30.1
Navigation Accuracy.....	6.30.1
Approach Briefing.....	6.30.1
Approach Category.....	6.30.1
Landing Minima.....	6.30.1
The Flying Reference.....	6.30.1
Delayed Flap Approach (Noise Abatement).....	6.30.2
Approach Phase Activation.....	6.30.2
Approach Speed Considerations.....	6.30.2
Deceleration And Configuration Change.....	6.30.5
F-PLN Sequencing.....	6.30.6
Use Of A/THR.....	6.30.6
FCU Altitude Setting.....	6.30.6
AP Disconnection.....	6.30.6



Adverse Weather.....	6.30.7
One Engine INOP.....	6.30.8

## **ILS Approach**

Initial Approach.....	6.40.1
Interception Of Final Approach Course.....	6.40.1
Final Approach.....	6.40.1
Glideslope Interception From Above.....	6.40.2
Late Runway Change.....	6.40.4
Manual Raw Data ILS.....	6.40.5
Low Visibility Procedures.....	6.40.7
Autoland Operations On Runways Not Approved For LWMO, Or When LVP Are Not In Force.....	6.40.8

## **Non-precision Approach**

Preface.....	6.50.1
Final Approach Strategy.....	6.50.2
Navigation Alerts.....	6.50.4
F-PLN Crosscheck.....	6.50.5
Initial Approach.....	6.50.7
Intermediate Approach.....	6.50.7
Detailed Approach Sequence.....	6.50.8
Minimum Descent Altitude (MDA).....	6.50.10

## **Circling Approach**

Preface.....	6.60.1
MCDU Preparation.....	6.60.1
Detailed Approach Sequence.....	6.60.1
Missed Approach – Circling.....	6.60.2



## Visual Approach

Preface .....	6.70.1
Detailed Approach Sequence.....	6.70.1
Base Turn.....	6.70.1
Final Approach .....	6.70.2

INTENTIONALLY  
BLANK



## **PREFACE**

Whenever holding is anticipated it is preferable to maintain cruise level and reduce speed to Green Dot, with ATC approval, to minimise the holding requirement. However, other operational constraints may make this option inappropriate. A holding pattern can be inserted at any point in the flight plan or may be included as part of the STAR. In either case, the crew can modify the holding pattern if required.

## **ICAO/FAA MAXIMUM HOLDING AIRSPEEDS**

Volume 2 Part 2 refers.

## **HOLDING SPEED AND CONFIGURATION**

If a hold is to be flown, provided NAV mode is engaged and the speed is managed, an automatic speed reduction will occur to achieve a speed close to Green Dot when approaching the holding pattern. Green Dot corresponds to an approximation of the best lift to drag ratio and provides the lowest hourly fuel consumption. If Green Dot is greater than the ICAO or state maximum holding speed, request a higher speed from ATC. If this is not approved, select Flaps 1 and fly at the required speed. Fuel consumption will be increased when holding in anything other than clean configuration.

## **HOLDING ENTRY PROCEDURES**

The FMGS computes the applicable hold entry which should be cross-checked. The hold entry requirements are detailed in PANSOPs. AERAD Guide refers.



## IN THE HOLDING PATTERN

As the number of holding patterns to be flown cannot be inserted in the FMGS, the hold distance is not included in the descent path computation. After the holding fix is sequenced, the FMGS assumes that only the current holding pattern will be flown and updates predictions accordingly. Once in the holding pattern the VDEV indicates the vertical deviation between current aircraft altitude and the altitude at which the aircraft should cross the exit fix to be on the descent path. In DES mode, the aircraft descends at 1000 ft/min whilst in the holding pattern until reaching either the cleared altitude or altitude constraint. To exit the holding pattern, select IMM EXIT. The aircraft will return directly to the holding fix and continue with the FLT PLN. On leaving the hold, the speed will revert to managed descent speed. Selected speed may be required to avoid an undesired acceleration.

In the holding pattern, LAST EXIT UTC/FUEL information is displayed on the HOLD page. These predictions are based on the fuel policy requirements specified on the FUEL PRED page with no allowance for extra fuel assuming the aircraft will divert following a missed approach. This information is computed with defined assumptions, e.g. diversion routeing, flight level, Mach number and wind. Deviation from these assumptions may affect the arrival fuel at the diversion airport.

## ADVERSE WEATHER

The most common adverse weather encountered whilst holding is icing. When holding in icing conditions, maintain clean configuration whenever possible. Use of engine anti-ice and total anti-ice increases fuel consumption as follows:

FCOM 3.05	Engine anti-ice	Total anti-ice
A333	+ 1.5%	+ 3.5%
A343	+ 4%	+ 5.5%
A346	+ 1%	+ 4%



## **PROCEDURE TURNS**

Procedure turns must be flown using selected modes. On some approaches the procedure turn must be completed within specified limits. The turn size is determined by the ground speed at which the fix is crossed. If the fix is crossed at an excessively high ground speed, the procedure turn protected airspace may be exceeded. Initiate the turn at Green Dot and time for 1 min 15 sec from the start of the turn. Select Flaps 1 when turning inbound. Monitor the track to ensure the aircraft remains within the protected airspace. The published procedure turn altitudes are minimum altitudes.

## **PROCEDURAL APPROACHES**

The detailed requirements for procedural approaches are laid down in PANSOPs. AERAD Guide refers.

## **TRACK ESTABLISHMENT**

Outbound descent may be commenced immediately following station or fix passage. Conversely, inbound descent may only be commenced when established within 5° of the published track.



INTENTIONALLY  
BLANK



## **PREFACE**

This section covers general information applicable to all approach types. Techniques which apply to specific approach types are covered later in the chapter.

During the approach phase, the aircraft may be operating at or below MSA, often in adverse weather in a high workload environment. Although ATC may be providing radar vectors to the initial or final approach fix, maintaining good situational awareness during the approach is essential.

## **NAVIGATION ACCURACY**

If GPS PRIMARY is not available, a navigation accuracy check is to be carried out prior to any approach. The navigation accuracy status determines:

- Which AP/FD modes are to be used.
- The non precision approach strategy (guidance modes).
- EFIS display.
- EGPWS TERR pb selection.

The final approach course may be intercepted in NAV mode if GPS PRIMARY is available or if the navigation accuracy check is positive. Without GPS PRIMARY, navigation accuracy should be monitored in accordance with established procedures.

Navigation Accuracy Check, FCOM 3.04.34 refers.

Navigation Accuracy requirements for the various approach guidance modes, FCOM 3.03.18 and 3.03.19 refer.

## **APPROACH BRIEFING**

Vol 2 Pt 2 and FCTM Ch 10 refer.

## **APPROACH CATEGORY**

The Airbus is classified as a category "D" aircraft.

## **LANDING MINIMA**

Vol 2 Pt 2 refers.

## **THE FLYING REFERENCE**

Use of HDG/V/S and the FD is recommended for ILS approaches. It is a requirement to use the FPV and the FPD for non-precision approaches.



## **DELAYED FLAP APPROACH (NOISE ABATEMENT)**

Do not compromise the stabilised approach criteria to satisfy noise abatement procedures. Where airport noise abatement procedures specify the use of minimum flap for landing, full flap should be used unless operational or non-normal procedures require a different configuration.

## **APPROACH PHASE ACTIVATION**

Activation of the approach phase initiates a deceleration from managed descent speed. In NAV or LOC mode, the approach phase activates automatically when sequencing the deceleration pseudo-waypoint. When in HDG mode or if an early deceleration is required, the approach phase can be activated via the PERF page. When the approach phase is activated, the magenta target speed becomes VAPP but the A/THR will maintain the minimum speed for the actual configuration.

## **APPROACH SPEED CONSIDERATIONS**

### **VAPP**

VAPP displayed on the PERF APPR page is equivalent to VLS for gross weight and landing flap configuration, plus an increment based on the inserted tower wind component. This increment is equivalent to the higher of 5 kt or 1/3 of the tower headwind component for the landing runway in the F-PLN. VAPP is computed at the predicted landing weight while in CRZ or DES phase, and using the current gross weight once the approach phase is activated.

The minimum 5 kt increment must be retained if A/THR is ON or if severe icing conditions are anticipated. The pilot can insert a lower VAPP on the PERF APPR page, down to VLS if landing is performed with A/THR OFF, no wind, downburst or icing. A higher VAPP may be inserted if gusty wind or downburst conditions are anticipated but the increment to VLS is limited to 15 kt.

Managed speed should be used for final approach as it provides ground speed mini guidance even when the VAPP has been manually inserted.

### **Ground Speed Mini and VAPP Target**

The purpose of ground speed mini is to keep the aircraft energy level above a minimum value, whatever the wind variation or gust. This allows for more efficient thrust management. Thrust varies in the correct sense, but within a smaller range ( $\pm 15\%$  N1) in gusty conditions.



The minimum energy level is the energy the aircraft will have at landing with the expected tower wind, represented by the groundspeed at that time which is called GS mini:

- $GS\ mini = VAPP - \text{Tower headwind component}$

In order to achieve this, the aircraft groundspeed must never drop below GS mini during the approach while the winds are changing. Therefore, the IAS (VAPP target) must vary in order to cope with the gusts or wind changes to ensure that the groundspeed is at least equal to GS mini. The FMGS uses the instantaneous wind component provided by the IRS to compute the VAPP target speed:

- $VAPP\ Target = GS\ mini + \text{instantaneous headwind component}$

The managed speed target moves on the speed scale as a function of wind variation, e.g. when VAPP target goes up = headwind gust. The pilot should ideally check the reasonableness of the target speed by reference to the groundspeed readout on the top left of the ND.

The VAPP target speed is limited to VFE – 5 kt in the case of strong gusts, and VAPP in case of a tailwind or if the instantaneous headwind component is lower than the inserted tower wind.

Below 400 ft RA, the VAPP target speed computation is modified as the instantaneous headwind component is progressively filtered out to avoid high IAS in the flare. VAPP target computation progressively assumes that the instantaneous wind equals the inserted tower headwind component so that the flare is entered at an IAS near VAPP.

FCOM 1.22.30 refers.



Example of GS MINI

VLS=130 kts  
Tower wind=20 kt Head wind  
 >  $V_{app}=130 + 1/3 HW$   
     =137 kt  
 >  $GS\ mini=V_{app} - HW$   
     =117 kt

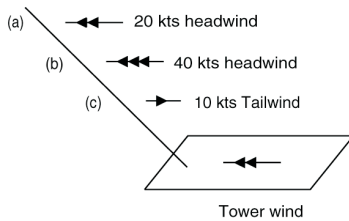

(a)	(b)	(c)
Current wind = tower wind	Head wind gust	Tailwind gust
Vapp is the IAS target	The IAS target increases	The IAS target decreases (not below Vapp)
Ground speed = GS mini	The IAS increases GS mini is maintained	The IAS decreases GS increases
	Thrust slightly increases	Thrust slightly decreases



## DECELERATION AND CONFIGURATION CHANGE

Managed speed is recommended for the final approach. Once the approach phase has been activated, the A/THR controls the speed to the minimum required for the current configuration. These speeds are:

- Green Dot for Flaps 0
- S speed for Flaps 1
- F speed for Flaps 2 and 3 (if Flaps 3 is not selected as the LDG CONF)
- VAPP for Flaps Full (or for Flaps 3 if selected as the LDG CONF)

To achieve a constant deceleration and minimise thrust variation, select the next configuration when reaching the target speed + 10 kt, e.g. when the speed reaches Green Dot + 10 kt, select Flaps 1. The IAS must be lower than VFE Next. Using this technique, the average deceleration rate will be approximately 10 kt/nm in level flight (20 kt/nm with speedbrake extended).

When below VFE CONF 1, the PF calls for "Flaps 1". The PNF visually confirms on the PFD that the speed is below VFE CONF 1, calls "Speed checks, Flaps 1" and then selects the flap lever to Flaps 1. He then monitors the E/WD to confirm that "1" is displayed in blue during transit and becomes green when the slats/flaps reach the correct position. This sequence should be repeated for subsequent flap settings.

If ATC requires a specific speed, select it on the FCU. When the speed control no longer applies, resume managed speed. If flying the intermediate approach in selected speed, activate the approach before resuming managed speed, otherwise the aircraft will accelerate to the previous descent speed.

In certain circumstances, e.g. tailwind or heavy weight, the deceleration rate may be insufficient. In this case, the landing gear may be lowered before selection of Flaps 2 and preferably below 220 kt to avoid undue stress to the gear doors.

Speedbrakes may also be used to increase the deceleration rate but be aware of the following:

- Increase in VLS
- Limited effect at low speeds
- Auto-retraction when selecting (A343: CONF 3), (A333: CONF Full). There is no auto-retraction on A346 and enhanced A333 aircraft. Instead an ECAM caution SPD BRK STILL OUT alerts the crew to this fact if the engines are above idle or if the speedbrakes have been extended for more than 5 seconds when the aircraft is below 800 ft during the approach.

For consistency between types, retract the speedbrakes prior to selection of Flaps 3.



## **F-PLN SEQUENCING**

In NAV mode, the F-PLN will sequence automatically. In HDG/TRK mode, the F-PLN will only sequence automatically if the aircraft flies close to the programmed route. Correct F-PLN sequencing is necessary to ensure that the programmed missed approach route is available in the event of a go-around. If under radar vectors and automatic waypoint sequencing does not occur, the F-PLN should be manually sequenced. This can be achieved by either using the DIR TO RADIAL IN function or by deleting the FROM WPT repeatedly on the F-PLN page until the next likely WPT to be overflowed is displayed as the TO WPT on the ND. However, when established on an ILS or LOC approach, do not perform a DIR TO as this will result in LOC reverting to NAV mode. In this case, the APPR or LOC will have to be re-armed to re-establish on the approach.

## **USE OF A/THR**

A/THR is recommended for all approaches as it provides accurate speed control. If planning to use manual thrust, A/THR should be disconnected by 1000 ft on the final approach.

The use of A/THR does not absolve the pilot from his responsibility to monitor its performance. If A/THR operation is not satisfactory, use manual thrust.

## **FCU ALTITUDE SETTING**

When established on final approach, set the missed approach altitude on the FCU. This can be done at any time after G/S or FINAL APP mode engages. For a selected non-precision approach using FPA, the missed approach altitude must only be set when the aircraft is below the missed approach altitude and no further level segment is required. This will prevent an unwanted ALT capture on final approach.

Do not set the MDA or DH on the FCU. Setting the MDA or DH on the FCU would result in an unwanted ALT\* when approaching MDA or DH, resulting in the approach becoming destabilised at a critical stage.

## **AP DISCONNECTION**

When disconnecting the AP for a manual landing, avoid the temptation to make unnecessary inputs on the sidestick.



## ADVERSE WEATHER

If severe windshear or downburst conditions are expected, consider either delaying the approach or diverting to another airport. Assess conditions for a safe landing by interpreting:

- The weather radar picture and PWS alerts.
- ATIS/actual wind velocity.
- Local terrain characteristics.
- ATC/pilot reports.

Choose the most favourable runway in conjunction with the most appropriate approach navaid (e.g. ILS or GPS) and consider using FLAPS 3 for landing. Should windshear be encountered, FLAPS 3 will allow better aircraft performance during the escape manoeuvre. However, with the decrease in drag associated with flaps 3, speed control during the approach will require close attention to avoid excessive speed on landing. This may also be exacerbated by using an increased VAPP. If the approach is continued however, consider the following:

- Increasing VAPP displayed on the PERF APP page up to a maximum of VLS + 15 kt. This is particularly important in downburst conditions.
- Managed speed should be used as it provides “GS mini” function.
- Engaging the AP for a more accurately flown approach.

The PWS is described in detail in FCOM 1.34. Additionally, the FMGEC reactive windshear warning system may be triggered in the event of windshear being experienced by the aircraft. The reactive windshear warning system is described in detail in FCOM 1.22.

On receipt of a reactive “WINDSHEAR” warning, apply the checklist actions from memory. The PF calls “Windshear Go”, implying that no configuration change will occur until clear of the shear. The following points should be stressed:

- If the AP is engaged, it should remain engaged. It will disengage if and when a prot is reached.
- The configuration should not be changed until positively out of the shear as the operation of the landing gear doors incurs additional drag.
- Follow the SRS, even if this requires the use of full back stick. As the speed begins to recover, the pilot can reduce back stick while still following SRS orders until well clear of the shear.
- The PNF should call IAS, RA, V/S and significant related trends.
- When clear of the shear, report the encounter to ATC.

On receipt of a predictive “WINDSHEAR AHEAD” warning, apply the checklist actions from memory. Select TOGA and follow the SRS. The PF calls “Go-Around Flaps \_\_\_”, reducing the flap setting by one. Continue the go-around and clean up as normal unless windshear is encountered or a “WINDSHEAR” warning occurs.





The checklist actions for predictive “WINDSHEAR AHEAD” warning on approach allow that in the event “a positive verification is made that no hazard exists, the warning may be considered cautionary”. This note to treat the predictive warning as cautionary is included only as an acknowledgement of the PWS system limitations. PWS technology relies on Doppler analysis of water particle movement, and the geographical situation associated with particular wind conditions may generate false warnings where no hazards exist. It should only be treated as cautionary on careful analysis and where an early positive verification can be made that no hazard exists.

Selection of the TERR ON ND pb will inhibit the display of the WINDSHEAR AHEAD display on that pilot’s ND.

In gusty wind conditions, the A/THR response time may be insufficient to cope with an instantaneous loss of airspeed. A more rapid thrust response can be achieved by moving the thrust levers above the CL detent. The thrust will quickly increase towards the corresponding TLA. The A/THR remains armed and becomes active immediately the thrust levers are returned to the CL detent. Therefore, the thrust levers should be returned to CL detent as soon as there is a positive speed trend. There are two important points to note however:

- Selecting the thrust levers above the CL detent below 100 ft AGL will disconnect the A/THR. In this case, returning the thrust levers to the CL detent will set climb thrust.
- Selecting the thrust levers to the TOGA detent, even momentarily, will engage the Go-Around mode.

If A/THR performance is unsatisfactory, it should be disconnected and manual thrust used.

In the event of ice accretion, approach speed increments should be applied. FCOM 3.04.30 refers.

## **ONE ENGINE INOP**

FCTM Ch 8 refers.



## INITIAL APPROACH

Check that the LS pb has been pressed and that the LOC and GS scales are displayed on the PFD, and the ILS ident is correctly displayed.

## INTERCEPTION OF FINAL APPROACH COURSE

The criteria that must be met prior to pressing the APPR pb is detailed in FCOM 3.03.18

Pressing the APPR pb arms the approach mode. LOC and G/S are displayed in blue on the FMA. The second AP, if available, should be selected at this stage.

If the initial ATC clearance is to intercept the localiser only, press the LOC pb on the FCU until cleared for the approach.

Executing some subsequent mode changes through the MCDU (e.g. "Direct to" FAF to update the flight plan), will disengage the armed modes of G/S and LOC blue. Reselection of APPR pb will be necessary.

Monitor aircraft position to anticipate and confirm the correct LOC and G/S beam is being intercepted to protect against false captures. Observe the FMA for the correct modes during the ILS capture process.

## FINAL APPROACH

Plan to intercept the glideslope from below with at least Flaps 1 selected. When approaching one dot below the glideslope select Flaps 2. In managed speed, the aircraft will decelerate to F speed. If the glideslope is intercepted in level flight below 2000 ft AAL the aircraft may need to be configured beyond CONF 2 prior to glideslope capture in order to achieve the stabilised approach criteria.

After glideslope capture, set the missed approach altitude on the FCU and check that it is displayed on the PFD. If the F-PLN has sequenced correctly, either automatically or manually, a blue go-around procedure will be displayed on the ND, indicating that NAV mode is available for the go-around. If there is no go-around procedure displayed, the F-PLN may be incorrectly sequenced and the go-around will have to be flown using selected modes and raw data.

Select the gear down approaching 2500 ft AAL. Selecting L/G down is the cue for PNF to arm ground spoilers and set NOSE switch to TAXI, and RWY TURN OFF switch ON. Once the gear is down, select the remaining stages of flap.



## GLIDESLOPE INTERCEPTION FROM ABOVE

The following procedure should only be applied when established on the localiser, with either LOC\* or LOC displayed in green on the FMA. The best rate of descent is achieved with the landing gear extended, Flaps 2 selected and flying at VFE2 – 5 kt. Speedbrakes may also be used, noting the considerations detailed in Deceleration and Configuration Changes earlier in this chapter. Apply the following procedure without delay:

- Confirm LOC capture and G/S armed.
- Select the FCU altitude above aircraft altitude to avoid unwanted ALT\*.
- Select V/S –1500 ft/min initially. V/S in excess of 2000 ft/min will result in the speed increasing towards VFE.

V/S rather than OP DES must be used to ensure that the A/THR is in SPEED mode rather than IDLE mode. Carefully monitor the rate of descent to avoid exceeding VFE or triggering a GPWS warning. When approaching the G/S, G/S\* engages. Monitor the capture against raw data. Use normal procedures for the remainder of the approach.

If at any stage it becomes apparent that the stabilised approach criteria will not be met, perform a go-around.



1. Ensure Approach Armed, **GS** (blue) and **LOC** or **LOC\*** (**GREEN!**)

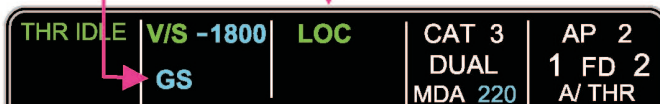

2. Set FCU ALT above present Altitude

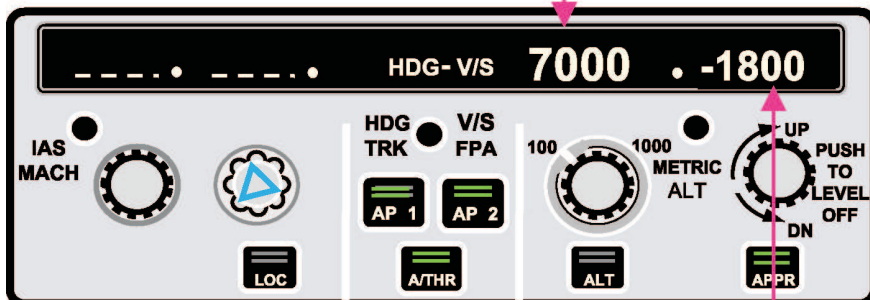

3. Ensure within One Dot of Localizer

4. Select V/S ( Max - 2,500 fpm )

5. Ensure **GS** and **LOC** remain.  
Monitor raw data.



## LATE RUNWAY CHANGE

If an airport has a number of active landing runways, programme the SEC F-PLN with the ILS for an alternative runway during the approach preparation, to cover the possibility of a late runway change. There is no requirement to enter the complete STAR.

If a runway change occurs and there is time available to achieve the approach stabilisation criteria, apply the following procedure:

- Pull HDG. At this point, LOC and G/S revert to HDG and V/S.
- Activate the SEC F-PLN.
- Adjust the HDG to intercept second runway LOC.
- Adjust V/S as required.
- Confirm ILS ident on PFD.
- Press APPR pb on FCU.
- Monitor ILS capture.
- Confirm correct missed approach altitude is set.
- Confirm correct TO waypoint on the ND to ensure NAV mode is available in the event of a missed approach.



## MANUAL RAW DATA ILS

The ILS may be flown using raw data with the FPV as the flying reference. Set the TRK index to the ILS inbound course. When tracking the LOC, the tail of the FPV will be coincident with the TRK index. This allows the drift to be taken into account for accurate LOC tracking. The ILS course pointer and the TRK diamond are displayed on the PFD compass and can be used to assist in accurate tracking once established. Rose LS may also be used for raw data monitoring.

When 1/2 dot below the G/S, initiate the interception of the G/S by smoothly flying the FPV down to the glide path angle. A 3° flight path angle is indicated on the PFD by the top of the tail of the FPV almost touching the horizon. It is also indicated by the bottom of the FPV almost sitting on the -5° pitch scale, but this reference becomes difficult to use in stronger crosswinds.

### TRK index selected to FINAL CRS

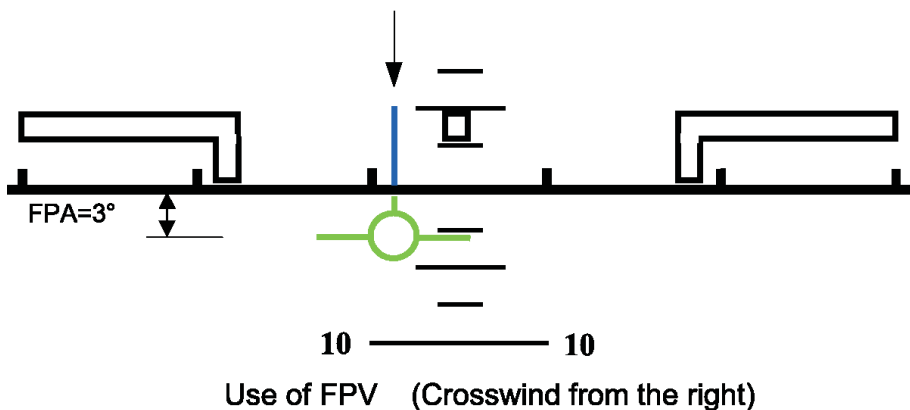

FFC5-03-0322-001-A001AC

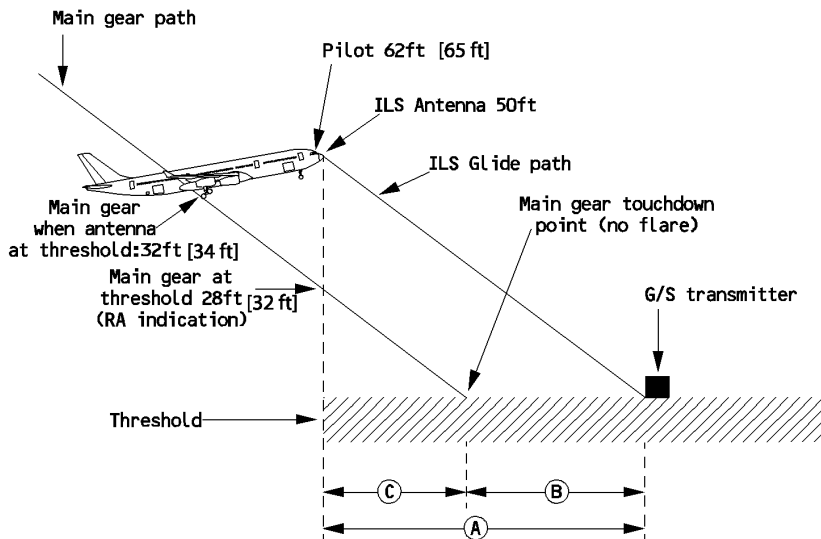

CONDITIONS:	Glide Path (°)	G/S Trans A	B		Touchdown Point C	
			A333/A343	A346	A333/A343	A346
<ul style="list-style-type: none"> <li>Flaps full</li> <li>ILS antenna at 50 ft at threshold</li> <li>No flare</li> <li>Pitch angle (A333/A343: 3.7°) (A346: 3°)</li> </ul>	2°5	348 m 1142 ft	153 m 502 ft	201 m 661 ft	195 m 640 ft	147 m 481 ft
	3°	291 m 955 ft	132 m 433 ft	169 m 555 ft	159 m 522 ft	122 m 400 ft

ILS Final Approach and Landing Geometry



## **LOW VISIBILITY PROCEDURES**

### **Policy**

FCOM 3.04.91 and Volume 2 Part 2 refer.

### **Approach Briefing**

Additional briefing items should be considered before commencing CAT2/3 approaches. FCOM 3.04.91 and Volume 2 Part 2 refer.

### **Additional Factors**

Airport capabilities regarding LWMO and autoland are stipulated on the relevant Port Page. The airport authorities are responsible for establishing and maintaining the equipment required for CAT 2/3 approach and landing. Prior to planning a CAT 2/3 approach, ensure that LVP are in force.

Specific wind limitations for CAT 2/3 approaches and autolands apply. FCOM 3.01.22 refers.

Correct eye position is particularly important during low visibility approaches and landings. When the eye reference position is too low, the visual segment is further reduced by the cut-off angle of the glare shield.

Due to the reflection from water droplets or snow, do not use landing and/or nose lights during low visibility approaches. This will ensure the greatest possibility of achieving the required visual reference at minima.

### **Alert Height**

The alert height is a specified radio height based on the characteristics of the aircraft and its fail-operational landing system. If a failure of a required redundant operational system occurs above this height, the approach must be discontinued unless a reversion to a higher DH is possible. If a failure of a required redundant operational system occurs below the alert height, the approach may be continued. In this context, the alert height concept is relevant when CAT 3 DUAL is displayed on the FMA and the aircraft systems are fail operational. The alert height is 200 ft RA.

### **Cat 3 Dual**

CAT 3 DUAL is annunciated on the FMA when the aircraft systems are fail-operational, which means that in the case of a single failure, the AP will continue to guide the aircraft on the flight path and the autoland system will operate as a fail-passive system. In the event of a failure below the alert height, the approach, flare and landing can be completed by the remaining part of the fail-passive autoland system. In that case, no landing capability degradation is annunciated on the FMA.





## Cat 3 Single

CAT 3 SINGLE is annunciated on the FMA when the aircraft systems are fail-passive, which means that a single failure will lead to AP disconnect without any significant out of trim condition or deviation from the flight path or attitude. However, manual flight is then required.

## System Faults And Failures

The failures that may affect the aircraft's CAT 2/3 capability are listed in the QRH. Most of the systems required for the different autoland capabilities are monitored by the FMGS. If a failure of a monitored system is detected after the APPR pb is pressed, but above the alert height, a new approach capability will be displayed on the FMA along with a "triple click" audio warning. In this case, the reduced approach category will not be displayed on the Status page. In addition, reduced approach capabilities displayed on the Status page are removed and transferred to the FMA when the APPR pb is pushed. The approach capabilities that can be displayed on the FMA are CAT 1, CAT 2, CAT 3 SINGLE or CAT 3 DUAL. There are also a number of failures which affect the aircraft's landing capability that are not monitored by the FMGS and are consequently not reflected on the FMA.

Following any failure that does not incur a landing capability downgrade on ECAM STATUS or FMA, refer to the "Landing Capability Equipment Required" table in the QRH to establish the actual landing capability.

Should a failure occur above 1000 ft RA, all ECAM actions, including DH amendment if required, should be completed before reaching 1000 ft RA. If this is not possible, initiate a go-around. An alert generated below 1000 ft (and down to the Alert Height in CAT 3 DUAL) should normally lead to a go-around and a reassessment of the system capability, unless the required visual reference has been acquired. Below 1000 ft, there is generally insufficient time to properly analyse the consequences of the fault, perform the necessary ECAM actions, check system configuration and any limitations, then carry out a re-briefing. The decision to continue the approach must be based on sound judgement.

## AUTOLAND OPERATIONS ON RUNWAYS NOT APPROVED FOR LWMO, OR WHEN LVP ARE NOT IN FORCE

Automatic landings may be practised in CAT 1 or better weather conditions for training purposes. Fluctuations of the LOC and/or G/S might occur due to the fact that protection of ILS sensitive areas, which applies during LVP, will not necessarily be in force. It is essential that the PF be prepared to take over manually at any time during a practice approach and rollout, should the performance of the AP become unsatisfactory.



## **PREFACE**

Non-precision approaches are defined as:

- VOR
- NDB
- LOC
- LOC-BC
- RNAV
- GPS

An RNAV approach is an instrument approach procedure that relies on aircraft area navigation equipment (FMS) for navigational guidance. The FMS on Airbus aircraft is certified RNAV equipment that provides lateral and vertical guidance referenced from an FMS position. The FMS uses multiple sensors for position updating including GPS, DME-DME, VOR-DME, LOC-GPS and IRS.

A GPS approach is an RNAV approach requiring GPS position update. Airbus aircraft using FMS as the primary means of navigational guidance have been approved to fly GPS approaches provided an RNP of 0.3 or smaller is used.

Non-ILS approaches are flown using FINAL APP or FPA pitch modes and LOC, FINAL APP or TRACK lateral modes.



## **FINAL APPROACH STRATEGY**

### **General**

The type of approach and the navigation accuracy will determine the approach guidance modes. Where possible, it is preferable to fly a managed approach (FINAL APP mode). Whether managed or selected guidance is used, use of the AP is recommended.

### **Requirements For Using FINAL APP Mode**

FCOM 3.03.19 refers.

### **Low Temperature Altimetry**

A managed vertical profile may not be flown if the airport temperature is below  $-15^{\circ}\text{C}$  or, if published, the Baro-VNAV authorised temperature on the approach chart. If the temperature is below the approved limit, the approach may still be flown using selected vertical guidance (NAV/FPA) and the corrected procedural altitudes (Volume 2 Part 2 refers). In this case, the approach is flown to an MDA.

### **VOR, VORDME, NDB And NDBDME Approach**

VOR and NDB approaches are flown using one of the following three strategies:

- Lateral and vertical guidance selected by the crew using TRK-FPA modes
- Lateral guidance managed by the FM and vertical guidance selected by the crew using NAV-FPA modes
- Lateral and vertical guidance managed by the FM in FINAL APP mode

### **LOC And LOC BACK COURSE Approach**

LOC approaches are flown using the LOC signal for lateral navigation and FPA for vertical guidance.

LOC-B/C approaches are flown using the LOC-B/C signal (LOC signal from the opposite runway) for lateral navigation and FPA for vertical guidance.

The LOC pb will arm the LOC or LOC B/C AP/FD mode as appropriate. The LS pb on the EFIS CTL panel will display LOC or LOC B/C deviation on the PFD in the correct sense. The PFDs VDEV symbol should be disregarded since it may be incorrect if the Missed Approach Point is located before the runway threshold

If the LOC B/C approach is stored in the FMS database and inserted into the F-PLN, the ILS frequency and associated back course are automatically tuned and displayed in the RADNAV page. The CRS digits will be preceded by a "B" to indicate back course.



If the LOC B/C is not stored in the FMS database, enter the ILS frequency and the intended final approach course preceded by a “B” in the RADNAV page. “B/C” will be displayed in magenta near the localiser deviation scale on both the PFD and ND. This will provide deviation indications on the PFD and ND in the correct sense, and proper directional guidance by the FG computers. However, do not select the LS pb on ISIS, since the ISIS displays B/C localiser deviation in the reverse sense.

For example:

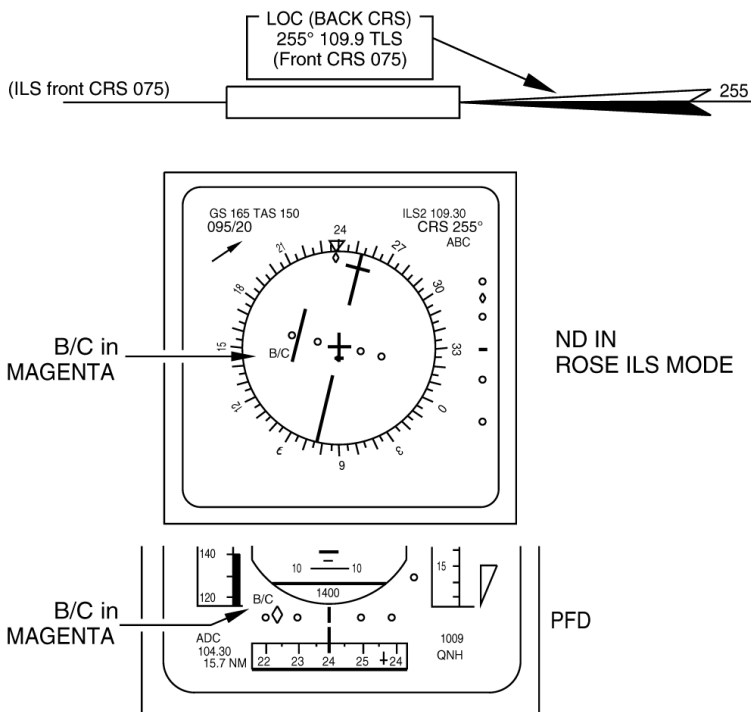

Back Course Approach RW26  
Insert ILS frequency **109.9** and back CRS **B255**

When the LOC pb is pressed, “LOC B/C” is annunciated in blue on the FMA to indicate that the localiser back course is armed.



## **RNAV and GPS Approach**

The following two strategies are available for performing RNAV and GPS approaches:

- Lateral and vertical guidance managed by the FM in FINAL APP mode. This is the recommended strategy. This strategy shall be used for approach with minima defined as a decision altitude (DA).
- Lateral guidance managed by the FM and vertical guidance selected by the crew using NAV-FPA modes. This strategy may be used for approach with minima defined as a minimum descent altitude (MDA), and shall be used for approaches which are conducted when the temperature is below the approved limit.

## **NAVIGATION ALERTS**

### **General**

A managed approach can be continued following a NAV ACCUR DOWNGRAD if raw data indicates that the guidance is satisfactory.

## **RNAV and GPS Approach**

Both GPSs must be available and GPS PRIMARY displayed on both MCDUs prior to commencing the approach. However once the approach has commenced, note that a single failure, such as NAV GPS 1 FAULT, will not cause the loss of GPS PRIMARY, since the remaining GPS will update both FMGS. If GPS PRIMARY LOST is displayed on the ND(s), it will be accompanied by a triple-click aural alert, even though NAV ACCURACY HIGH may still be displayed.

Crew procedures following a NAV FM/GPS POSITION DISAGREE caution, or if GPS PRIMARY LOST is displayed on one or both NDs, depends on whether the approach is standalone, or in overlay to a radio navaid procedure. FCOM 3.03.19 and QRH refer.



## F-PLN CROSSCHECK

The approach in the navigation database must be validated by scrupulous comparison between the database profile and the published procedure.

The following graphics show a particular case in which the final descent approach path is equal to zero and the MAP is beyond the runway threshold. This approach may not be flown in managed vertical modes. FCOM 3.03.19 refers.

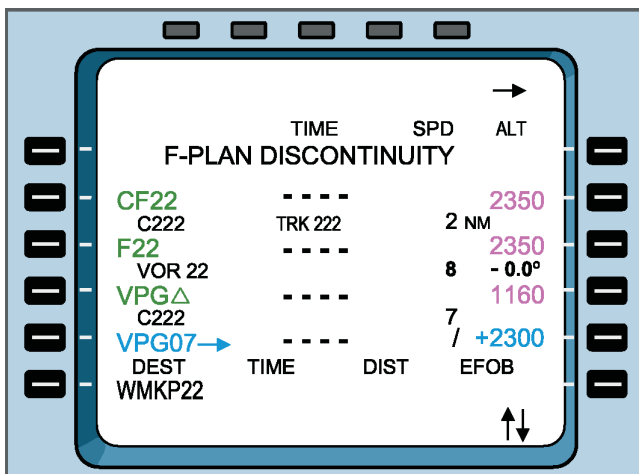

Note: For clarity, approach is shown without predictions.



WMKP  
PENANG INTL

PENANG I, MALAYSIA  
VOR DME Rwy 22

ATIS 126.4		PENANG Tower 121.1		Ground 121.6	
VOR VPG 116.2	Final Appch Crs 222°	No FAF	MDA(H) 1155' (1144')	Apt Elev 11'	RWY 22 11'
MISSED APCH: Climb on 222° to 3000' or D7.5, turn RIGHT to rejoin VPG VOR holding pattern at 4000' or as directed by ATC.					
Alt Set: hPa		Rwy Elev: 0 hPa	Trans level: FL 130	Trans alt: 11000' (10989')	
					MSA VPG VOR

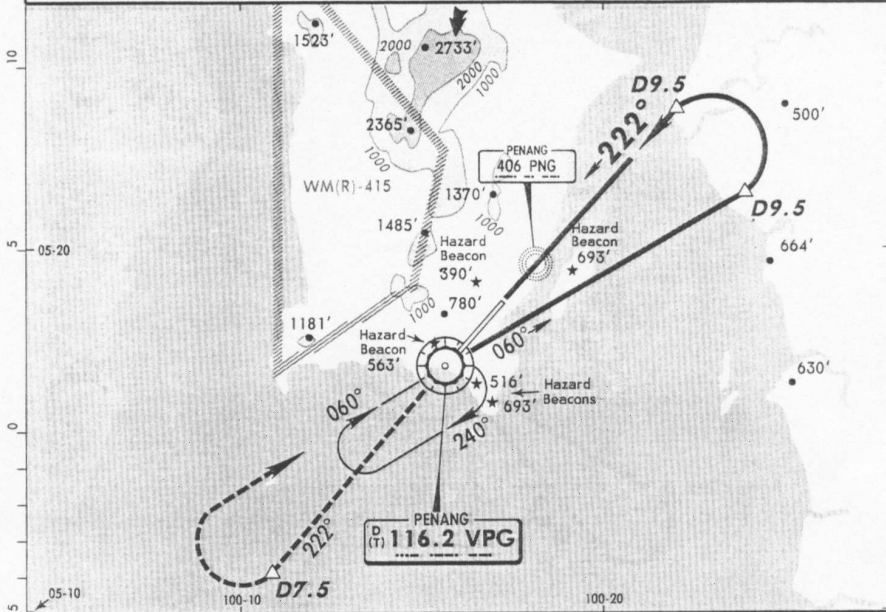
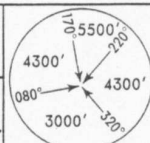

VPG DME	6.0	7.0	8.0	9.0
ALTITUDE (HAT)	1176' (1165')	1494' (1483')	1812' (1801')	2130' (2119')

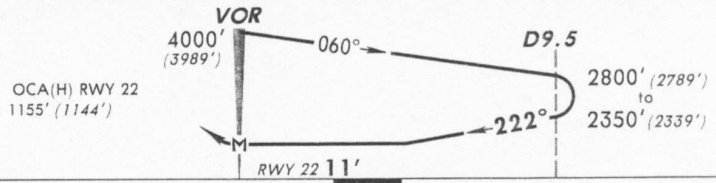



Some charts provide a table of DME versus altitude. On those charts which do not have this table, an expected FPA for the final approach can be calculated by dividing the first 2 digits of the height at the FAF by the distance to go, e.g. 2000 ft at 6 nm equates to a 3.3° approach path. When using this method ensure that the FAF crossing height is used, i.e. the figure in brackets on the chart and not the FAF crossing altitude.

## **INITIAL APPROACH**

### **Navigation Accuracy**

Confirm GPS PRIMARY.

For RNAV and GPS approaches, 2 FMGS and 2 GPS are required to commence the approach. The GPS MONITOR page must display NAV for both GPSs. Both FMGS must be in GPS PRIMARY.

For non-precision approaches referenced to ground based radio aids, if GPS PRIMARY is not available, check the navigation accuracy to confirm that the planned approach strategy remains valid. If managed guidance does not correspond with raw data, the use of selected guidance is mandatory. FCOM 3.03.19 refers.

### **Flying Reference**

The FPV/FPD shall be used for all non-precision approaches.

## **INTERMEDIATE APPROACH**

### **Approach Phase Activation**

Normal approach stability requirements apply to non-precision approaches. However, as non-precision approaches are rarely flown, consider inserting a speed constraint of VAPP at the FAF to ensure a timely deceleration.

### **Final Course Interception**

Do not modify the MCDU F-PLN, either laterally or vertically, from the final approach course fix to the runway threshold or missed approach point.

For RNAV and GPS approach, ensure that the RNP automatically sequences to the approach value. Typically, this occurs approximately 5 nm prior to the intermediate approach fix (IF). The RNP approach value is 0.30 nm for a DCDU equipped aircraft, and 0.37 nm for a non-DCDU equipped aircraft. If the RNP does not automatically sequence, then the approach may be continued provided the relevant RNP is manually entered.





Ensure that the aircraft is laterally stabilised on the final approach course before reaching the final approach fix (FAF). It is acceptable to go direct to the approach fix or use the RADIAL IN function, provided the inbound course is closely aligned with the final approach course and the resulting change to aircraft course at the FAF is small.

To commence a managed approach, press the APPR pb. APP NAV is displayed in green on the FMA with FINAL in blue. The V/DEV scale becomes active and represents the vertical deviation from the managed descent profile, which may include a level segment. The V/DEV scale will only be displayed if the LS pb is not pressed. If the LS pb is pressed, V/DEV will flash in amber on the PFD.

If FINAL APP does not engage at the descent point, select an FPA value to allow convergence with the final approach path. When VDEV is indicating that the vertical profile has been reached (VDEV = 0), attempt to re-engage FINAL APP mode by pressing the APPR pb.

For a selected approach, use TRK mode to establish final course tracking with reference to raw data. When established on the final course, the selected track will compensate for drift.

Should ATC give vectors towards the FAF, the use of the "DIR TO RADIAL IN" function will provide a representation of the extended centreline and cross-track error on the ND.

## **DETAILED APPROACH SEQUENCE**

### **Managed Non-precision Approach**

Fly the intermediate approach conventionally and configure the aircraft in a similar manner to an ILS.

Use the following technique:

- For RNAV and GPS approach, check both GPS in NAV mode on the GPS MONITOR page and GPS PRIMARY is displayed on both MCDUs. Check RNP has sequenced to the approach value (0.30/0.37 nm).
- Check that deceleration occurs at the decel pseudo-waypoint, or if not, activate the approach phase approx 10 nm prior to the FAF.
- Select TRK/FPA display, confirming that the FPV and the FPD are displayed on the PFD.
- Ensure LS is not selected.
- When cleared for the approach, press the APPR pb to arm APP NAV and FINAL. If previously in NAV, APP NAV engages immediately.
- Do not engage the second AP.
- Check that the FMGS computed descent point, represented as a blue arrow, is displayed on the ND. It may not necessarily coincide with the chart descent point because the FMGS attempts to compute a continuous final descent path.



- V/DEV appears in approach phase with FINAL armed.
- Ensure raw data is correctly displayed.
- FINAL APP engages when the aircraft intercepts the vertical flight path.
- Set the go-around altitude.
- Use managed speed unless there are specific ATC requirements.
- Start the chrono at the FAF to check FAF to MAP time.
- Monitor the approach using FPV/FPD and VDEV on the PFD, XTK and F-PLN waypoints on the ND with GPS PRIMARY, and confirmed by nav aids for VOR, NDB and overlay approaches. Cross-check altitudes and distances with those published on the approach chart.

### **Selected Non-precision Approach**

Fly the intermediate approach conventionally and configure the aircraft in a similar manner to an ILS. The approach can be flown fully selected or if navigation accuracy allows, managed laterally and selected vertically.

### **Partially Selected Approach**

For a partially selected approach, i.e. managed laterally and selected vertically, continue as for a managed non-precision approach with the following additional consideration:

- Fly the final approach in NAV and FPA modes (LOC and FPA for LOC or LOC B/C approaches).

### **Fully Selected Approach**

For a fully selected approach:

- Fly the final approach in TRK/FPA modes.

### **Both Partially And Fully Selected Approaches**

For both partially and fully selected approaches, use the following technique:

- Check that deceleration occurs at the decel pseudo-waypoint, or if not, activate the approach phase approx 10 nm prior to the FAF.
- Select TRK/FPA display, confirming that the FPV and the FPD are displayed on the PFD.
- For LOC and LOC B/C approaches, ensure LS is selected. When cleared to intercept the localiser or localiser back course, press the LOC pb to arm the LOC mode.
- 1 nm prior to the final descent point, pre-select the desired FPA.
- Pull the FPA selector 0.2 nm prior to the final descent point to achieve a smooth interception of the final descent path.
- Use managed speed unless there is a specific ATC speed requirement.
- Start the chrono at the FAF to check FAF to MAP time.



- Monitor the approach using FPV/FPD and VDEV on the PFD, XTK and F-PLN waypoints on the ND with GPS PRIMARY, and confirmed by nav aids for VOR, NDB and overlay approaches. For LOC and LOC B/C course approaches, monitor lateral displacement using the LOC pointer on the PFD. Cross-check altitudes and distances with those published on the approach plate.
- When the aircraft is below the missed approach altitude, set the missed approach altitude on the FCU.

### **MINIMUM DESCENT ALTITUDE (MDA)**

When approaching MDA, expand the scan to include outside visual cues. When the required visual conditions to continue the approach are met, disconnect the AP and select the FDs off. If not visual by the MDA or MAP, whichever occurs first, go-around. Do not fly level at MDA whilst attempting to achieve the required visual reference.

MDA is the lowest permitted altitude for AP use. If still engaged following a managed approach, the AP will disconnect at MDA – 50 ft. The modes will revert to TRK/FPA.

Do not set MDA as a target altitude on the FCU since this would cause a spurious ALT\* when approaching MDA and result in the approach becoming destabilised at a critical stage.



## PREFACE

An instrument approach to one runway, followed by a visual pattern to land on another runway, is termed a circling approach. Company circling minima may be more limiting than the circling minima on the approach chart. Vol 2 Pt 2 refers.

## MCDU PREPARATION

If a circling approach is likely, set up the MCDU as follows:

- Programme the instrument approach into the active F-PLN.
- Insert the arrival weather and the circling minima on the PERF APPR page.
- Programme the SEC F-PLN with the landing runway and associated go-around procedure.
- Insert the arrival weather on the SEC PERF APPR page.

## DETAILED APPROACH SEQUENCE

Follow normal procedures for the ILS or non-precision approach to establish inbound on the final segment of the instrument approach. Then use the following technique:

- Fly the inbound instrument approach with Flaps 3 at F speed and gear down.
- When reaching circling minima and with sufficient visual reference for circling, push the FCU ALT pb.
- Select a TRK of 45° (or as required by the published procedure) away from the inbound approach course towards the circling area.
- Select TRK/FPA and when wings level, start the chrono and time for 30 seconds.
- Select ROSE NAV and 10 nm on the EFIS display to assist in positioning the aircraft within the circling area.
- Turn onto a downwind track to parallel the landing runway within the circling area. Early on the downwind leg, activate the SEC F-PLN to display the landing runway on the ND and provide an accurate “GS mini” computation for final approach.
- Abeam landing threshold, start chrono and time for 30 seconds.
- Disengage AP and select both FDs off prior to the base turn.
- Commence the base turn and select Flaps Full leaving the circling altitude.
- Complete the Landing Checklist.

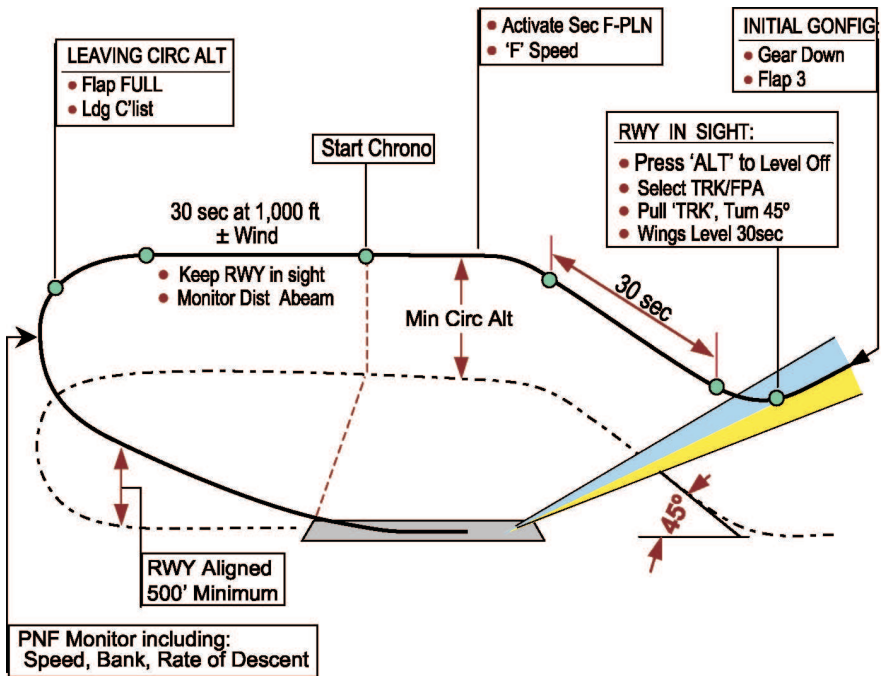

## MISSED APPROACH – CIRCLING

If a missed approach is required at any time while circling, make a climbing turn towards the landing runway. Consider maintaining the missed approach flap setting until close-in manoeuvring is completed. Follow ATC instructions or the applicable missed approach procedure.



## PREFACE

Plan to start a visual approach at 1500 ft AAL, 2.5 nm abeam the upwind threshold. The flight plan selected on the MCDU should include the selection of the landing runway such that managed speed is available. The downwind leg may also be part of the flight plan. This may produce a useful indication on the ND of the aircraft position in the circuit, but visual references must also be used.

## DETAILED APPROACH SEQUENCE

Use the following technique:

- Select ROSE NAV and 10 nm on the EFIS display to assist in positioning the aircraft accurately.
- Activate the APPR phase at the start of the downwind leg.
- Ensure A/THR is on and managed speed is engaged.
- Select TRK/FPA.
- Select Flaps 1 abeam the upwind threshold.
- Set the go-around altitude on the FCU.
- Fly the downwind leg at 1500 ft AAL at S Speed.
- Maintain a track parallel to the landing runway approximately 2.5 nm abeam.
- AP and FD may be used on the downwind leg, but must be selected off prior to the base turn.
- Abeam the landing threshold, select Flaps 2, start the chrono and lower the gear.
- Select Flaps 3 prior to the base turn.
- Time for 45 sec +/- 1 sec/kt of wind.
- Commence the base turn and select Flaps Full when leaving 1500 ft.
- Complete the Landing Checklist.

## BASE TURN

In calm winds, only 15° of bank will be required. In strong tightening crosswinds, up to 30° of bank may be required. Speed, bank angle and rate of descent should be closely monitored by the PNF. If an ILS is being intercepted from a visual circuit, a G/S warning is possible during the turn.

Commence the final turn onto the runway centreline at approximately 0.8 nm before the extended centreline (if displayed on the ND). Initial ROD should be approximately 400 ft/min, increasing to 700 ft/min when established on the correct descent path. Establish a normal 3° approach as per the stabilised approach criteria.



## FINAL APPROACH

Roll out of the turn on the extended runway centreline and maintain VAPP. Thrust should be stable by 1000 ft. Use the speed trend arrow to anticipate thrust changes and the FPV to monitor approach path deviations. Use available G/S and/or PAPIs as well as the visual picture to assist in maintaining a stable approach.

A continuous visual/instrument scan is required to fly a successful approach. An effective scan will assist in highlighting small errors, allowing small, early corrections to be made.

A 3° slope will normally be flown with a ROD of approximately 700 ft/min; a higher ROD is an indication that the aircraft is about to descend below the ideal approach path. A small correction of approx 1° of pitch will change the ROD by approximately 100 ft/min. Azimuth errors will require bank angle changes both to stop the drift and then to recover to the centreline. Avoid using bank angles greater than 10° for small corrections.

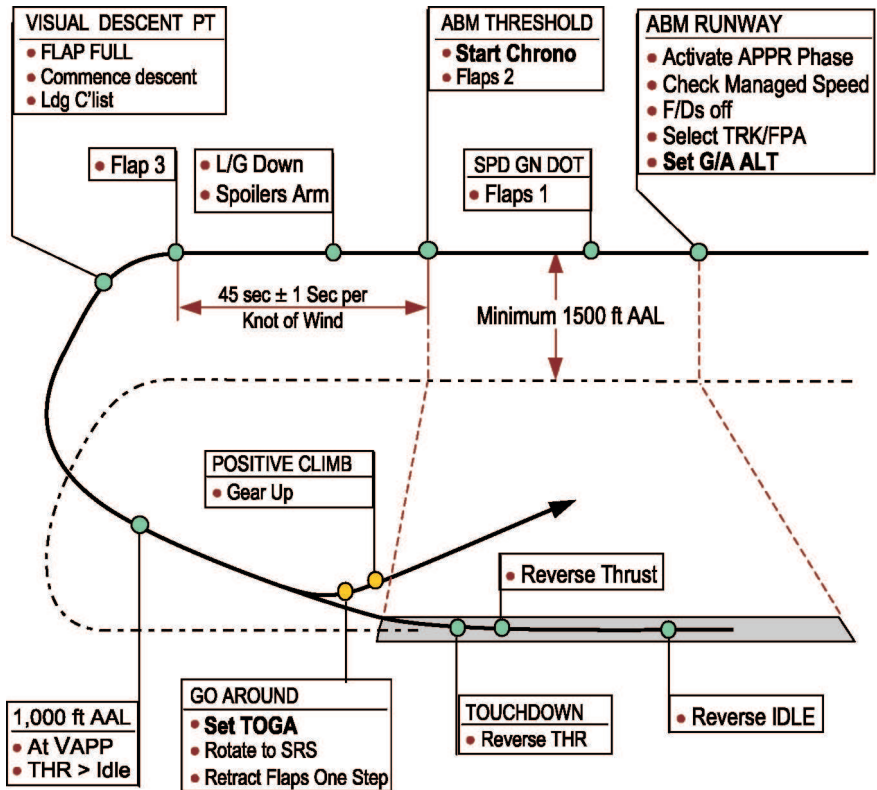

**NOTES:**

1. This pattern assumes use of Mini Ground Speed (Managed).  
If not, manually select speeds appropriate to configuration:  
'S' after Flap 1 selection  
'F' after Flap 2 selection  
'F' after Flap 3 selection
2. Approach prior to Circle to Land is conducted with Gear down and Flap 3.

**VISUAL CIRCUIT**



INTENTIONALLY  
BLANK



## TABLE OF CONTENTS

### Landing, Go-around & Taxi-in

#### Landing

Visual Aim Point .....	7.10.1
Visual Approach Slope Indicator (VASI/T-VASI) .....	7.10.1
Precision Approach Path Indicator (PAPI) .....	7.10.4
Flare .....	7.10.5
Tailstrike Protection And Prevention .....	7.10.7
Derotation .....	7.10.7
Rollout .....	7.10.7
Braking .....	7.10.8
Factors Affecting Landing Distance .....	7.10.10
Crosswind Landing .....	7.10.12
Bounced Landing Recovery .....	7.10.13
Ground Clearance .....	7.10.13
Adverse Weather .....	7.10.17

#### Go-around

Preface .....	7.20.1
AP/FD Go-around Mode Activation .....	7.20.1
Leaving The Go-around Phase .....	7.20.2
Rejected Landing .....	7.20.3

#### Taxi-in

Brake Temperature .....	7.30.1
Park Brake Use .....	7.30.1
Adverse Weather .....	7.30.1

INTENTIONALLY  
BLANK



## **VISUAL AIM POINT**

When available, PAPI, VASI or ILS glideslope, provide cues to assist in maintaining the correct path in the latter stages of the approach. The correct approach path brings the aircraft to 1000 ft beyond the runway threshold. This is the visual aim point. Assuming a constant speed and attitude, this point should not move relative to the windscreen. Make small control inputs as required to maintain the visual aim point fixed in the windscreen until initiation of the flare.

Close to the ground, high sink rates must be avoided even at the expense of maintaining glideslope or the visual aim point. Priority should be given to correct attitude and sink rate. If runway length is limiting, a go-around should be initiated.

## **VISUAL APPROACH SLOPE INDICATOR (VASI/T-VASI)**

The VASI is a system of lights arranged to provide visual descent guidance information during the approach. Flying the VASI glideslope to touchdown is the same as selecting a visual aim point on the runway adjacent to the VASI installation.

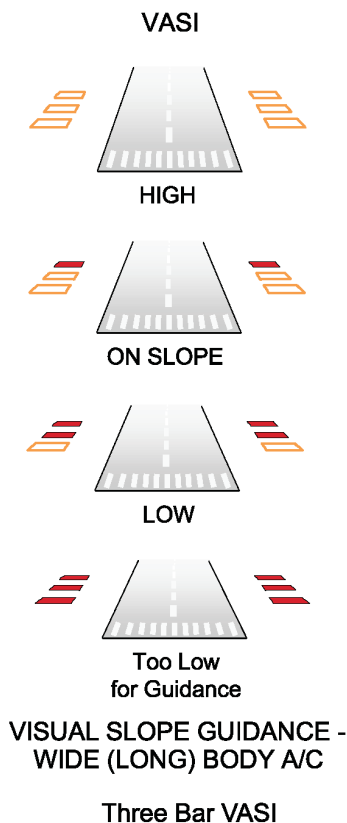

## VASI Landing Geometry

### Three-bar VASI

Three-bar VASI installations provide two visual glide paths. The lower glide path is provided by the near and middle bars and is normally set at  $3^\circ$  while the upper glide path, provided by the middle and far bars, is normally  $1/4^\circ$  higher ( $3.25^\circ$ ). This higher glide path should be used in order to provide sufficient threshold crossing height.



## Two-bar VASI

On rare occasions, a two bar VASI system may be encountered. These systems are not compatible with widebody aircraft and their use is not recommended.

## T-VASI

When flying an approach using a T-VASI system, an indication of one light high will provide additional wheel clearance.

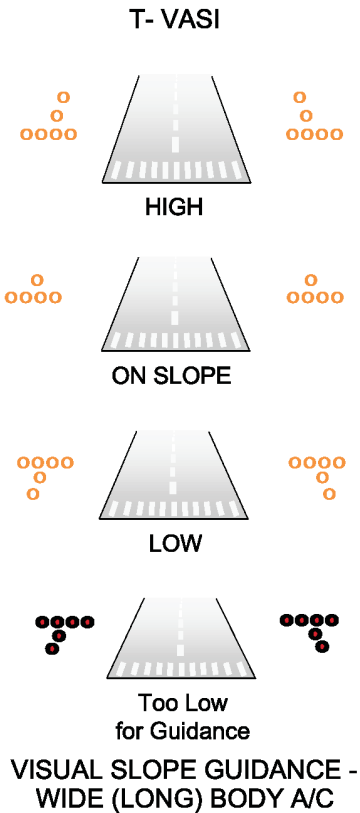

T-VASI Landing Indications



## PRECISION APPROACH PATH INDICATOR (PAPI)

The PAPI is a system of 4 lights which are normally installed on the left side of the runway. The principle of operation is similar to the VASI but using a single row of lights.

When the aircraft is on a normal 3° glide path, the pilot sees two white and two red lights. The PAPI may be safely used with respect to threshold crossing height. The standard PAPI installation is arranged such that the approach path intersects runway at 1300 ft. Do not follow PAPI guidance below 200 ft.

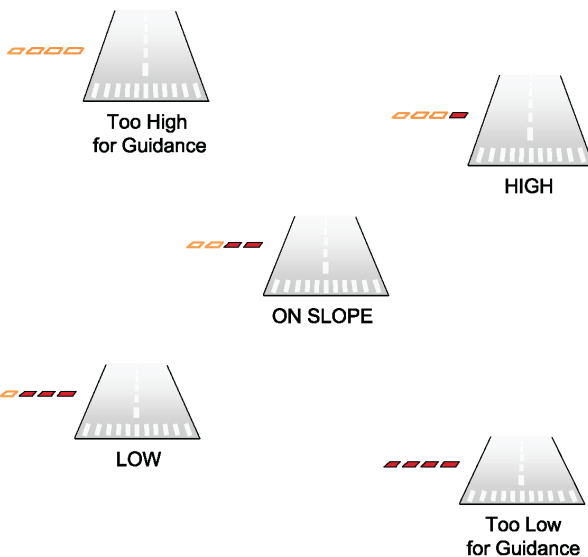

PAPI SLOPE GUIDANCE - WIDE (LONG) BODY A/C  
PAPI Landing Indications



## FLARE

The techniques below assume a stabilised approach at VAPP and on the glidepath. Unless an unexpected or sudden event occurs, e.g. windshear, it is not appropriate to use sudden or abrupt control inputs during landing. Additional considerations applicable to landings in crosswind and slippery runway conditions are described later in this chapter.

Autotrim ceases at 100 ft and the pitch law is modified to the flare mode, as described in FCTM Ch 2. At this point, a backpressure on the sidestick is required to maintain a constant flight path.

The flare technique is conventional. Commence a gentle, progressive flare just after the 40 ft auto-callout. The typical pitch increment in the flare is approximately 2 – 3°, associated with about a 5 kt speed decay in the manoeuvre. Retard the thrust levers to idle and allow the aircraft to touchdown without a prolonged float. A prolonged float increases both the landing distance and the risk of tailstrike. In order to assess the rate of descent in the flare and the aircraft position relative to the ground, look well down the runway.

At 20 ft the "RETARD" auto-callout occurs. This is a reminder rather than an order. If thrust is required, e.g. due to sinking windshear, do not retard the thrust levers immediately. The A/THR will then add thrust during the flare to maintain target speed.





FFC5-03-0322-002-A001AC

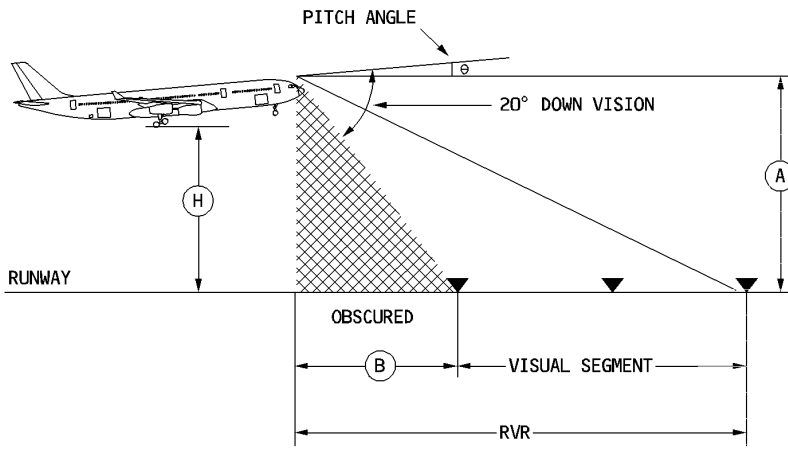

Minimum Visual Ground Segment (Flare Phase)

	CAT III			CAT II
H	0 ft ( $\theta = 8^\circ 4'$ ) [TBD]	15 ft ( $\theta = 2^\circ 9'$ ) ( $\theta = 4^\circ 2'$ )	50 ft ( $\theta = 2^\circ 1'$ ) ( $\theta = 3^\circ 0'$ )	100 ft ( $\theta = 2^\circ 1'$ ) ( $\theta = 3^\circ 0'$ )
Visual Segment	60 m (197 ft) [TBD]			120 m (394 ft) [TBD]
A	38 ft	44 ft	77 ft	127 ft
Obscured B	56 m (185 ft) [TBD]	44 m (143 ft) [47 m (155 ft)]	73 m (238 ft) [78 m (255 ft)]	120 m (394 ft) [128 m (419 ft)]

**Note:**

- Where different, A346 values are shown in [ ].



## TAILSTRIKE PROTECTION AND PREVENTION

Tailstrike can occur on landing due to:

- VAPP being decreased below the calculated value
- A high flare with engine power at idle
- A high sink rate just prior to flare
- Attempting to touchdown too smoothly (higher pitch attitude)
- A prolonged flare and float
- Pitching up following a bounce to avoid a second hard touchdown

On A333 and A343 aircraft, the PNF should call "PITCH" if pitch attitude exceeds 7.5° in the flare.

The A346 tailstrike protection system provides pitch limit indication on the PFD below 400 ft RA on approach and an aural alert of "PITCH, PITCH" below 14 ft RA in case of excessive pitch attitude in the flare. In the event of a tailstrike, an ECAM TAILSTRIKE caution is generated. FCOM 1.27 refers.

## DEROTATION

On landing, the rear main wheels touchdown first. The aft sidestick input applied for the flare should then be relaxed towards the neutral position. This allows the aircraft to derotate naturally until front main gear contact. After main gear touchdown, fly the nose down conventionally, controlling the derotation rate to ensure a smooth nosewheel touchdown. Lower the nosewheel without delay. Do not keep the nose high in order to increase aircraft drag during the initial part of the rollout. This technique is inefficient as it reduces braking efficiency by delaying full weight-on wheels, increases the risk of a hard nosewheel touchdown and also increases the risk of tailstrike. If braking is applied with the nose high, up to full back stick may be required to control the nose down pitching moment.

After touchdown, with reverse thrust selected on at least one engine and one main landing gear strut compressed, the ground spoilers partially extend to further establish ground contact. The ground spoilers fully extend when both main landing gears are compressed. A small nose down input on the elevators is introduced by the control law, which compensates the pitch up tendency with ground spoiler extension.

## ROLLOUT

During the rollout, use the rudder pedals to maintain the aircraft on the runway centreline. At high speed, directional control is achieved with rudder. As the speed reduces, nosewheel steering becomes active. The steering handwheel is not to be used until taxi speed is reached.



## **BRAKING**

The importance of the timely use of all means of stopping the aircraft cannot be overemphasised. Execution of the following actions without delay permits stopping the aircraft with the least landing roll. Three systems are involved in the aircraft deceleration:

- Ground spoilers
- Thrust reversers
- Wheel brakes

### **Ground Spoilers**

The ground spoilers contribute to aircraft deceleration by increasing aerodynamic drag and so are more effective at high speed. Ground spoiler extension also markedly decreases lift. This increases load on the wheels and therefore improves braking efficiency. Additionally, the ground spoiler extension signal is used for autobrake activation.

### **Thrust Reversers**

Select reverse thrust immediately after main gear touchdown. Thrust reverser efficiency is proportional to the square of the speed and is therefore most efficient at high speeds. Below 70 kt, reverser efficiency decreases rapidly. Below 60 kt with maximum reverse selected, there is a risk of engine stall. Smoothly reduce the reverse thrust to idle at 70 kt. However, in case of emergency, maximum reverse thrust is permitted down to aircraft stop.

Normally full reverse thrust should be used. However, on long, dry runways with no tailwind component, idle reverse may be used. Stow the reversers when taxi speed is reached and before leaving the runway.

If airport regulations restrict the use of reverse thrust, select and maintain reverse idle until taxi speed is reached.

### **Wheel Brakes**

Wheel brakes contribute the most to aircraft deceleration on the ground. Many factors may affect braking efficiency, e.g. load on the wheels, tyre pressure, runway pavement characteristics, runway contamination and braking technique. The only factor over which the pilot has any control is the use of the correct braking technique.



## Antiskid

The antiskid system adapts pilot applied brake pressure to runway conditions by sensing an impending skid condition and adjusting the brake pressure to each individual wheel as required. The antiskid system maintains the skidding factor (slip ratio) close to the maximum friction force point. This provides the optimum deceleration with respect to the pilot input. When braking manually, antiskid performance is optimised by smoothly applying and maintaining the desired braking command.

## Use Of Autobrake

Manual braking often involves a delay between main gear touchdown and brake application, even when actual conditions dictate the need for a more rapid initiation of braking. This delay in brake application adversely affects the landing distance. Brake application may be further delayed by the increased workload associated with a crosswind, LWMO, or operations on short, wet, or contaminated runways. The use of autobrake is therefore recommended in preference to manual braking.

The use of LO (A346: LO, 2, 3) should be preferred on long dry runways whereas the use of MED (A346: 4, HI) should be preferred on short or contaminated runways. The use of MAX autobrake on A333/A343 is not recommended for landing.

On very short runways, the use of manual braking may be envisaged since the pilot may apply full manual braking without delay after main gear touchdown. However this should not preclude arming of the autobrake for landing.

As the autobrake system maintains a pre-determined deceleration rate, reverse thrust reduces the amount of wheel braking required. This results in reduced brake temperatures.

Brake wear is related to the number of brake applications. The use of autobrake minimises the number of brake applications and consequently brake wear.

The green DECEL light on the AUTO/BRK panel enables the monitoring of the deceleration rate. It illuminates when approximately 80% of the selected deceleration rate is achieved. In some cases it may illuminate without application of brakes, e.g. if the effect of reverse thrust is sufficient to achieve the deceleration rate. In other cases, e.g. on contaminated runways, it may not illuminate because antiskid is unable to achieve the deceleration rate despite proper operation of the autobrake. (A346: The ACTIV light illuminates to indicate that the autobrake is functioning but has yet to achieve the desired deceleration.)



Autobrake may be disengaged by brake pedal application or by (A333/A343: deselecting the AUTO/BRK pb) (A346: rotating the selector to DISARM). The normal method of disarming the autobrake is by applying even pressure on both brake pedals. Disconnect the autobrake when the desired speed is attained and in any case above 20 kt to avoid brake shudder at low speed. Failure to disconnect will result in the aircraft stopping on the runway.

The use of autobrake does not absolve the pilot of the responsibility of achieving a safe stop within the available runway length.

## Manual Braking

Normally delay manual braking until after nosewheel touchdown to vacate the runway at the appropriate turn-off. To reduce brake wear, the number of brake applications should be limited.

Manual braking may be applied prior to nosewheel touchdown e.g. on a limiting runway. Anticipate an increased nose down pitch rate. Apply brakes smoothly and symmetrically with moderate-to-firm pedal pressure until a safe stop is assured. Do not ride the brakes but apply manual braking when required and modulate the pressure without releasing to minimise brake wear.

## Deceleration Monitoring

The PNF monitors and calls:

- Spoiler deployment (ECAM WHEEL page).
- Reverse thrust operation(E/WD).
- Autobrake operation (green DECEL light on AUTO/BRK panel).

He should advise the PF of any non-normal indications.

## FACTORS AFFECTING LANDING DISTANCE

The field length requirements are contained in the Landing Performance section of FCOM 2. The landing distance margin is reduced if the correct landing technique is not used. Factors that affect stopping distance include:

- Height and speed over the threshold
- Glideslope angle
- Landing flare technique
- Delay in lowering the nose onto the runway
- Improper use of available deceleration devices
- Runway conditions (discussed in adverse weather)



Height of the aircraft over the runway threshold has a significant effect on total landing distance. For example, on a 3° glide path, passing over the runway threshold at 100 ft rather than 50 ft could increase the total landing distance by approximately 300 m/950 ft. This is due to the length of runway used before the aircraft touches down.

A 5 kt speed increment on VAPP will result in a 5% increase to the distance extracted from the Landing Distance with Autobrake table in the QRH.

A prolonged period of level flight above the runway prior to touchdown must be avoided as it uses a significant amount of the runway length available. Land the aircraft as near to the normal touchdown point as possible. Deceleration on the runway is approximately three times greater than in the air.

The minimum stopping distance is achieved by applying maximum manual antiskid braking with maximum reverse thrust selected and ground spoilers fully deployed.

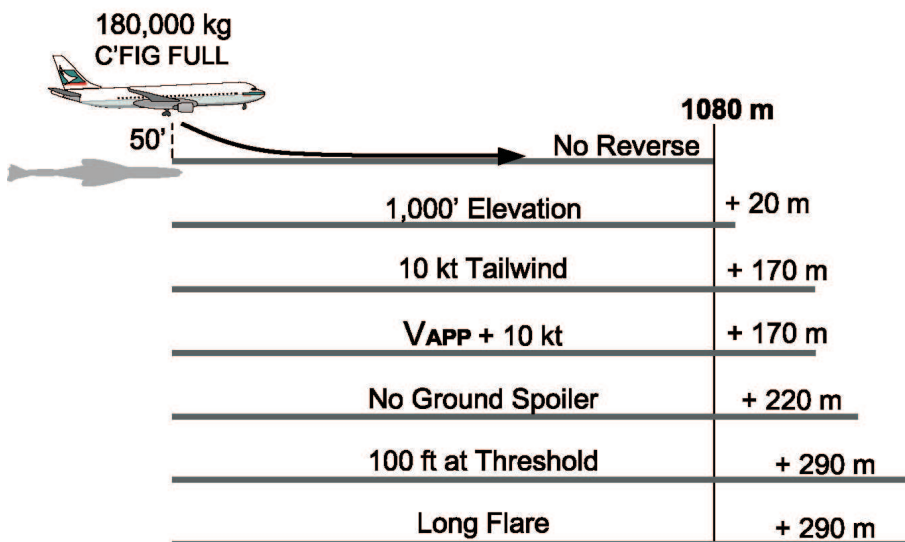

**Operational Factors Affecting Landing Distance  
(For Guidance Only)**



## CROSSWIND LANDING

A maximum crosswind for landing is specified in FCOM 3.01.20. The figures are equally applicable to dry or wet runways. The maximum crosswind values for automatic landings are autoland system limitations. FCOM 3.01.22 refers.

The recommended technique to fly an approach in a crosswind is to track the runway centreline with drift applied and wings level. This is called the crabbed approach.

During the flare, apply rudder to align the aircraft with the runway centreline. Counteract any tendency to roll downwind by an appropriate sidestick input. It is possible that a very small amount of into-wind sidestick may be required to maintain the aircraft on the runway centreline prior to touchdown.

In the case of a very strong crosswind, a full de-crab prior to the flare may lead to the development of a significant downwind drift. The amount of bank required to arrest this drift may reach the aircraft lateral geometry limit. In this case, the combination of a partial de-crab and wing down technique may be required.

The crabbed approach prior to landing has several advantages:

- Both main gear struts are compressed simultaneously resulting in full spoiler extension
- If touchdown occurs with drift, the load is more evenly spread across all main gear
- The risk of an engine pod strike is reduced

## Rollout

Minimise into wind sidestick input as this would increase the weathercock effect and create a disproportionate down force on the upwind main gear.



## **BOUNCED LANDING RECOVERY**

A bounced landing may be caused by either one, or a combination, of the following:

- Pitch rate not stopped after touchdown
- Backpressure on the sidestick not released after touchdown
- Pitch up effect of spoiler extension not controlled
- Automatic spoiler deployment inhibited due to thrust levers higher than idle

Should a shallow bounce occur, hold the pitch attitude. Do not attempt to soften the second touchdown by either increasing pitch or adding thrust.

Should a significant bounce occur, do not attempt to continue the landing but hold the pitch attitude and go-around. Do not try and avoid a second touchdown during the go-around by increasing pitch attitude. Should a second touchdown occur, the go-around must be continued. Delay flap retraction until the normal go-around procedure is established with a positive climb confirmed. Due to the possibility of on-ground sensing, with TOGA thrust applied and full flap extended, a CONFIG warning may occur.

## **GROUND CLEARANCE**

The most common causes for the aircraft structure making ground contact on landing are:

- Unstable approach
- Inappropriate flare and landing technique
- Windshear

The landing technique described above minimises the risk of ground contact.

Ground contact occurs if the figures shown in the following charts are exceeded at touchdown:





6FC5-03-0322-003-A030AA

TOUCHDOWN ON ONE MAIN LANDING GEAR

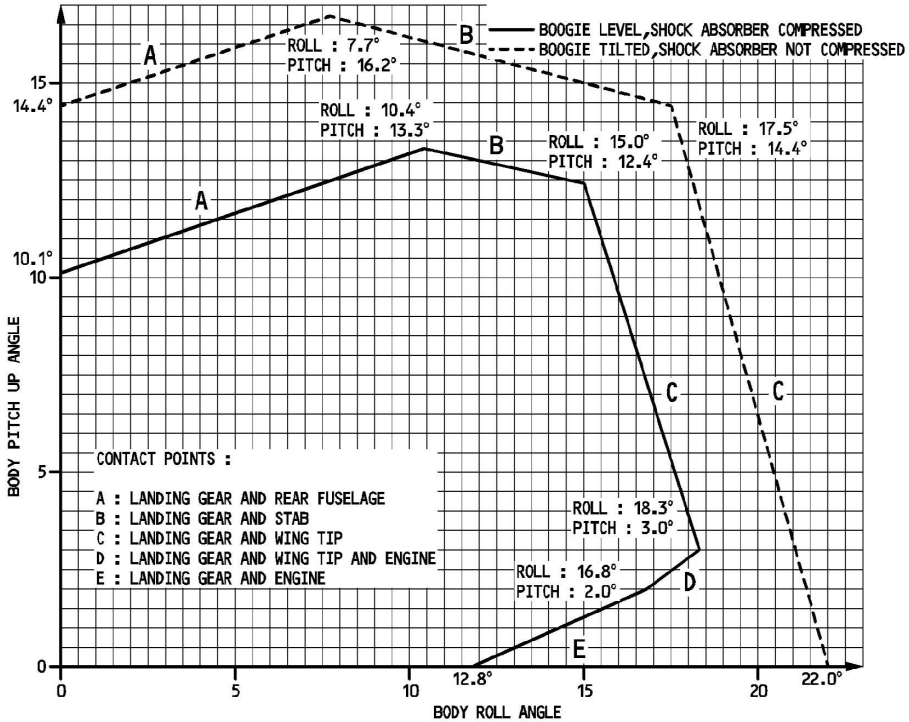

Ground Clearance (A333)



FFCS-03-0322-003-A001AC

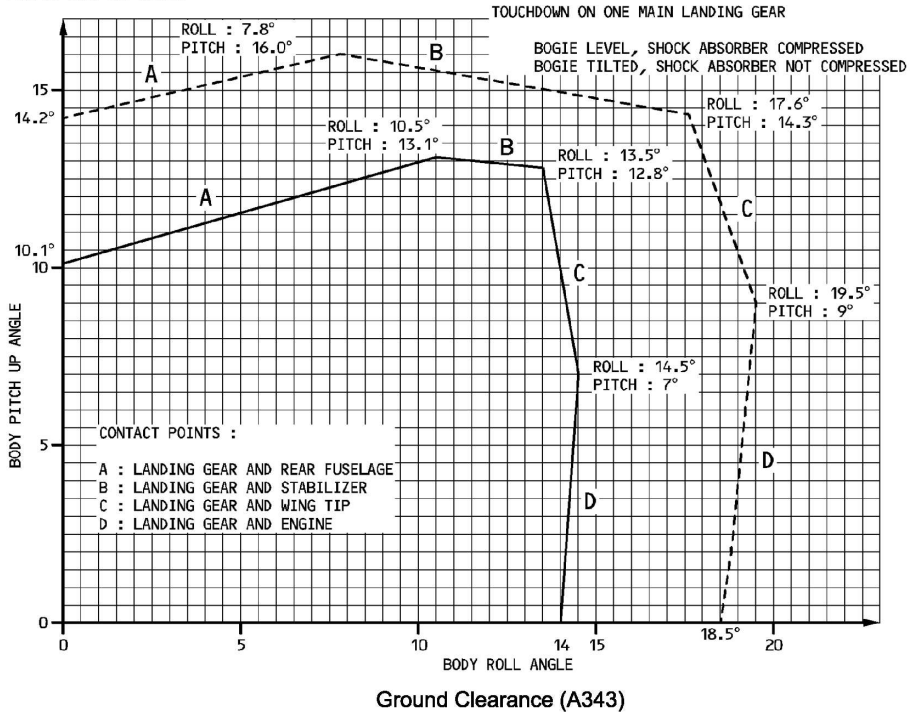



FFC5-03-0322-003-A112AA

TOUCHDOWN ON ONE MAIN LANDING GEAR

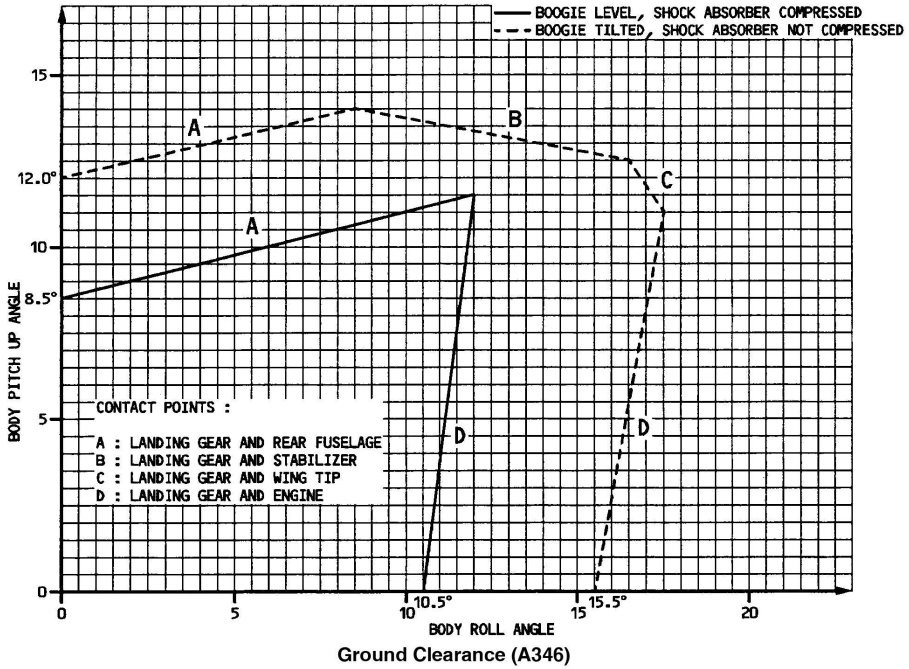



## ADVERSE WEATHER

Operations on slippery or contaminated runways have a significant impact on landing considerations, including:

- Braking action
- Directional control
- Crosswind limit determination

### Braking Action

The presence of fluid contaminant on the runway adversely affects the braking performance by reducing the friction force between the tyres and the runway surface. It also creates a fluid layer between the tyres and the runway surface thus reducing the contact area. The landing distances provided in FCOM 2.03.10 give an indication of the actual landing distances for various levels of contamination.

The use of LO or MED (A346: LO/2 or 3/4) autobrake is recommended when landing on an evenly contaminated runway. The DECEL light on the AUTO BRK panel may not illuminate, as the pre-determined deceleration might not be achieved. This does not mean that the autobrake is not working.

Make a positive touchdown and select maximum reverse as soon as possible thereafter.

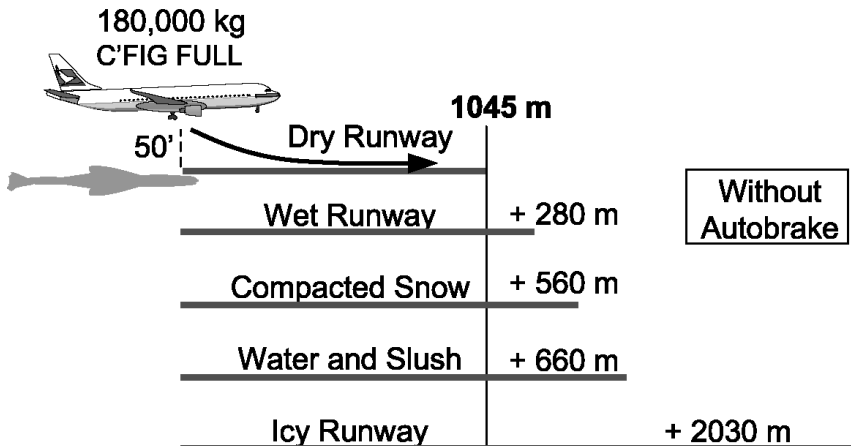

Runway Conditions Affecting Landing Distance (Without Autobrake)  
(For Guidance Only)

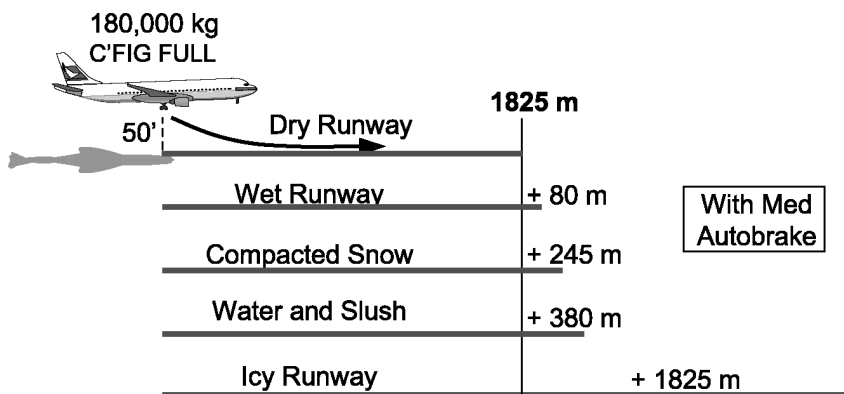

Runway Conditions Affecting Landing Distance (With MED Autobrake)  
(For Guidance Only)

## Slippery Or Contaminated Runway Landing Performance

When landing on runways contaminated with ice, snow, slush or standing water, the reported braking action must be considered. Terms used include GOOD, FAIR, POOR and NIL. Vol 2 Pt 2 refers.

The braking performance associated with "GOOD" is representative of a wet runway, while "POOR" is representative of an ice covered runway. Exercise extreme caution to ensure adequate runway length is available when POOR braking action is reported.

Contaminated runway landing performance data is presented in FCOM 2.03.10. Uniform contamination over the entire runway is assumed. This means a uniform depth for slush/standing water for a contaminated runway or a fixed braking coefficient for a slippery runway. The data cannot cover all possible slippery/contaminated runway combinations and does not consider factors such as rubber deposits or heavily painted surfaces near the end of most runways.



A term commonly used to describe runway conditions is coefficient of friction. The runway coefficient of friction is normally determined using vehicles towing measuring equipment. For a variety of reasons, the coefficient measured by the ground equipment may not necessarily relate to the coefficient that the aircraft may experience on landing. Coefficient of friction values provide additional information to be taken into consideration when determining the runway conditions for landing. Evaluate these readings in conjunction with pilot reports and the physical description of the runway condition when planning the landing. Take special care in evaluating all the information available when braking action is reported as POOR or if slush or standing water is present on the runway.

Unless emergency or operational circumstances dictate otherwise, use the following minimum friction co-efficient for landing:

- 0.2 FC (ICAO)
- 0.26 CRFI (Canada)
- 20 ACBA (USA)

## **Directional Control**

As for a normal landing, use rudder for directional control after touchdown. Use of the steering handwheel must be avoided above taxi speed as its use may result in aquaplaning of the nosewheel, leading to reduced cornering force and consequently, reduced directional control.

A crosswind landing on a contaminated runway requires careful consideration. If the aircraft touches down with some crab or is allowed to weathercock into wind after landing, the reverse thrust side force component and the crosswind component can combine to cause the aircraft to drift to the downwind side of the runway. Additionally, as the antiskid system will be operating at maximum braking effectiveness, the main gear tyre cornering forces available to counteract this drift will be reduced.

To correct back to the centreline, reduce reverse thrust to reverse idle and release the brakes. This minimises the reverse thrust side force component, without the requirement to go through a full reverser actuating cycle again and increases the tyre cornering force available. Rudder and differential braking should be used to correct back to the runway centreline, if required. When re-established on the runway centreline, re-apply braking and reverse thrust as required.

On wet and contaminated runways, directional control is most problematic at low speed. Differential braking may be used as necessary in conjunction with brake pedal deflection. If differential braking is used, the pilot should fully release the brake pedal input on the opposite side to the intended turn direction.



## **Crosswind Limitations**

Due to the potential directional control problems associated with landing on contaminated runways in crosswind conditions, the crosswind limitations are reduced. FCOM 2.04.10 and the QRH refer.

## **Autolands**

The automatic ROLLOUT mode, has not been demonstrated on snow covered or icy runways. The ROLLOUT mode relies on a combination of aerodynamic rudder control and nosewheel steering to maintain the runway centreline using localizer signals for guidance. On a contaminated runway, nosewheel steering effectiveness and therefore aircraft directional control capability, is reduced. Use the more restrictive of the autoland or contaminated runway landing crosswind limitations to determine the maximum permitted crosswind.

If an autoland is accomplished on a contaminated runway, be prepared to disengage the AP should ROLLOUT directional control become inadequate.

## **Landing Technique Summary**

The following chart summarises the recommended procedures for landing on slippery or contaminated runways:



PHASE	RECOMMENDED PROCEDURE	REMARKS
Approach	<ul style="list-style-type: none"> <li>• Fly a well-executed final approach with the aircraft positioned on glidepath, on runway centreline and at the speed recommended for existing conditions.</li> <li>• Arm autobrake system by selecting LO or MED (A346: LO/2 or 3/4)</li> <li>• With a crosswind, do not be misled by the relative bearing of the runway due to crab angle when breaking out of overcast.</li> </ul>	<p>Go-around if approach stability criteria not met.</p> <p>Autobrake is recommended provided contamination is evenly distributed.</p>
Flare	<ul style="list-style-type: none"> <li>• Do not float or allow drift to build up during the flare.</li> <li>• Drifting snow can lead to an illusion of aircraft drift.</li> <li>• With a crosswind, do not de-crab prior to touchdown.</li> </ul>	<p>Use runway lighting and markings as drift reference in drifting snow.</p> <p>A touchdown in a crab establishes main gear crab effect and actuates the auto spoilers and the autobrakes more quickly.</p>
Touchdown	<ul style="list-style-type: none"> <li>• Accomplish a positive touchdown as near to the centreline as possible at approximately 1,500 ± 500 ft.</li> <li>• The aircraft should be flown positively onto the runway even if the speed is excessive.</li> <li>• If a long touchdown is likely, go-around.</li> </ul>	<p>A positive touchdown improves wheel spin up on slippery runways.</p> <p>Deceleration on the runway is about three times greater than in the air. Do not allow the aircraft to float.</p>





PHASE	RECOMMENDED PROCEDURE	REMARKS
Deceleration Phase (Expedite All Items)	<ul style="list-style-type: none"> <li>• Select maximum reverse thrust.</li> <li>• Immediately lower the nose gear onto the runway and hold light forward sidestick pressure.</li> <li>• Check the speedbrakes deploy immediately after main gear touchdown.</li> <li>• The autobrake system begins symmetrical braking at ground spoiler deployment.</li> <li>• Without autobrake, use moderate-to-firm, steady brake pedal pressure after nose gear touchdown.</li> </ul>	Do not cycle brake pedals. Both main gear bogies must be in GND POS for antiskid operation. Antiskid is deactivated below 10 kt ground speed.
Rollout	<ul style="list-style-type: none"> <li>• Keep the wings level.</li> <li>• Maintain light forward sidestick pressure.</li> <li>• Use nosewheel steering with care.</li> <li>• Maintain directional control with rudder for as long as possible.</li> </ul>	Improves directional control and traction.



## PREFACE

Failure to execute a go-around, when required, is a major cause of approach and landing accidents. As a go-around is an infrequent occurrence, it is important to be "go-around minded". The decision to go-around should not be delayed, as an early go-around is safer than one carried out at the last minute at low altitude.

## AP/FD GO-AROUND MODE ACTIVATION

The go-around phase is activated when the thrust levers are set to TOGA, provided the flap lever is at Flap 1 or greater. The FDs are displayed automatically.

The SRS provides guidance to either the speed at go-around engagement or VAPP, whichever is higher, until the acceleration altitude. The speed is further limited to maximum of VLS + 25 with all engines operative or VLS + 15 with one engine inoperative. If the go-around is manually flown, the initial pitch targets are 15° with all engines operative and 12.5° with one engine inoperative. If FPV/FPD has been used for the approach, it may be necessary to press the HDG V/S-TRK FPA pushbutton to restore pitch and roll bars.

To initiate the go-around, the PF simultaneously applies TOGA thrust, announces the go-around, calls for the required flap setting and rotates to the required pitch attitude. Before moving the flaps, the PNF should check that the speed is greater than VLS and not reducing. For normal operations, the required flap setting is one step less than the approach configuration, e.g. Flap 3 following a Flap Full approach. If the go-around is carried out early in the approach with Flap 1 selected, do not retract flap until above S speed. PF then checks for correct FD presentation and once a positive ROC is confirmed requests landing gear retraction. Before making the requested configuration change, the PNF checks the required parameters and repeats the PF command. The PNF confirms that the correct thrust is set and then the PF reads the FMA and requests the required lateral modes (NAV or HDG). If the AP is engaged the PF can make the lateral mode selection.

Above the acceleration altitude, the target speed becomes green dot.



GA TRK guides the aircraft on the track memorised at the time of TOGA selection. The missed approach route becomes the ACTIVE F-PLN provided the waypoints have been correctly sequenced on the approach. The previously flown approach is placed back into the F-PLN. If a second approach is required, it becomes available when the approach phase is re-activated. Pushing for NAV enables the missed approach F-PLN to be followed. If both APs had been engaged prior to the selection of TOGA, the go-around will be flown with both APs remaining engaged. Whenever any other mode engages, AP 2 disengages. The FMGS makes no predictions in the go-around phase. Consequently CLB mode is not available and the pilot must observe constraints.

Subsequent procedures, including thrust handling and flap retraction, are in accordance with the take-off phase. FCTM Ch 4 refers. Thrust reduction and acceleration will be sequenced at the altitudes programmed in the PERF GA page.

A late go-around may result in ground contact. If touch down occurs after TOGA is engaged, the AP will remain engaged and the A/THR remains in TOGA. The ground spoilers and autobrake are inhibited.

### **Go-Around From An Intermediate Approach Altitude**

To interrupt an approach, or perform a go-around from an intermediate altitude in the approach where TOGA thrust is not required, set the thrust levers to the TOGA detent and then retard them as required, normally back to the CL detent. Provided the flap lever is at Flap 1 or greater, the go-around mode will activate with the associated AP/FD modes. If the thrust levers are not briefly set to the TOGA detent, the FMGS will not engage the go-around phase, and flying within 7 nm of the airport will sequence the destination waypoint. In this case, the active F-PLN will be erased and only PPOS – F-PLN DISCONTINUITY will be displayed.

If necessary, select the applicable AP/FD and A/THR modes on the FCU to manage the subsequent flight profile.

### **LEAVING THE GO-AROUND PHASE**

During the missed approach, choose either of the following strategies:

- Fly a second approach
- Carry out a diversion

The chosen strategy will depend upon the reason for the go-around, e.g. poor weather. The purpose of leaving the go-around phase is to obtain the proper target speed and predictions for the chosen strategy.



## Second Approach

If a second approach is to be flown, activate the approach phase via the PERF GO-AROUND page. The target speed moves according to the flaps lever setting, e.g. Green Dot for Flaps 0.

Ensure correct waypoint sequencing during the second approach in order to have the missed approach route available, should a further go-around be required.

## Diversion

Once the aircraft path is established and clearance has been obtained, modify the FMGS as required.

If the ALTN F-PLN is in the active F-PLN perform a lateral revision, preferably at the TO WPT, to access the ENABLE ALTN prompt. On selecting the ENABLE ALTN prompt, the lateral mode reverts to HDG if previously in NAV. Fly the aircraft towards the next waypoint using HDG or perform a DIR TO to engage NAV.

If the ALTN F-PLN is in the SEC F-PLN, activate the SEC F-PLN and perform a DIR TO as required. The ACTIVATE SEC F-PLN prompt will only be displayed in HDG mode.

If the ALTN F-PLN is not stored, make a lateral revision at any waypoint to insert a NEW DEST. Amend the route and CRZ FL as required.

## REJECTED LANDING

A rejected landing is defined as a go-around manoeuvre initiated after touchdown of the main landing gear.

Once the decision is made to reject the landing, commit to the go-around manoeuvre and do not be tempted to retard the thrust levers in a late decision to execute a landing.

Apply TOGA thrust. Ground spoilers will auto-retract and autobrake will disarm as a consequence. A CONFIG warning will be generated when the aircraft is still on the runway, with thrust applied and the flaps at FULL. Disregard this warning. If the AP was engaged, it will disconnect. If on the ground, continue de-rotation. Rotate only when the PNF has confirmed the thrust is set and the speed is above VAPP. When clear of the ground, with a positive ROC, select Flaps 3 if approach was made with Flaps FULL. The landing gear should be retracted when a positive ROC has been established with no risk of further touchdown. Thereafter proceed as for a standard go-around.

If reverse thrust has been applied, a full stop landing is mandatory.

INTENTIONALLY  
BLANK



## **BRAKE TEMPERATURE**

Thermal oxidation is accelerated at high temperature. Therefore, if the brakes absorb too much heat, carbon oxidation will be increased. This is the reason why the brakes should not be repeatedly cycled above 500°C during normal operation. Furthermore, after heavy braking, the use of brake cooling fans could increase oxidation of the brake surface hot spots if the brakes are not thermally equalised. Thermal equalisation is achieved about 5 minutes after the high energy absorption event.

## **PARK BRAKE USE**

When parked during normal operations, the Park Brake should be left ON.

Releasing the Park Brake does not have a significant effect on brake cooling. The very small air gap created between the discs hinders the transfer of heat energy through the brake unit. Leaving the Park Brake on allows the heat to be dissipated through the entire mass of the wheel assembly. This is not the case if brake cooling is used. The Park Brake should be released as this will enable cooling air to be forced through the gap between the discs and across the brake surface.

Unless operationally required, park brake use should be avoided if any brake temperature exceeds 500°C. In this case, brake cooling should be applied. FCOM 3.04.32 refers.

Any decision to release the Park Brake must be done in consultation with the ground engineer and only after confirmation that the wheel chocks are in place.

## **ADVERSE WEATHER**

The techniques outlined in FCTM Ch 3 concerning operations on contaminated taxiways are applicable. Additionally, the flaps/slats should not be retracted after landing to avoid damage that might be caused by crushing any ice present in the flap/slat tracks. On arrival at the gate a visual inspection should be carried out, after engine shutdown, to ensure that the flap/slat areas are free of any contamination prior to retraction.

INTENTIONALLY  
BLANK



## TABLE OF CONTENTS

### Non-normal Operations

#### General

Preface.....	8.10.1
Use Of Autopilot.....	8.10.1
Monitoring And Cross-Checking.....	8.10.1
Memory Items.....	8.10.1
Landing Distance Procedure.....	8.10.2
Vapp Determination.....	8.10.2
Landing Distance Calculations.....	8.10.4
Land ASAP.....	8.10.4

#### Operating Techniques

Low Speed Engine Failure.....	8.20.1
Rejected Take-off.....	8.20.1
Engine Failure After V1.....	8.20.6
Engine Failure During Initial Climb-Out.....	8.20.9
Engine Failure During Cruise.....	8.20.9
One Engine Inoperative Landing.....	8.20.11
Circling One Engine Inoperative.....	8.20.11
One Engine Inoperative Go-Around.....	8.20.12
Two Engines Inoperative Landing (A343/A346).....	8.20.12
Recovery From Alpha Protection And Alpha Floor.....	8.20.14
Stall Recovery.....	8.20.15
Recovery From High Speed Protection.....	8.20.15

#### Electrical

Emergency Electrical Configuration.....	8.30.1
---	--------





## **Fire Protection**

Fire Protection .....	8.40.1
Smoke .....	8.40.1
Cargo Smoke .....	8.40.2

## **Flight Controls**

Non-Normal Flaps/Slats Configuration .....	8.50.1
Elevator Redundancy Lost .....	8.50.3

## **Fuel**

Fuel Leak.....	8.60.1
Fuel Jettison .....	8.60.1
Handling Of Expected Low Fuel Levels At Destination .....	8.60.2
Avoidance Of Non-standard Fuel Distributions On Arrival .....	8.60.2
Avoidance Of Fuel Induced Wing Icing On Arrival .....	8.60.2

## **Hydraulic**

Double Hydraulic Failures .....	8.70.1
---------------------------------	--------

## **Landing Gear**

Landing With Non-normal Gear.....	8.80.1
-----------------------------------	--------

## **Navigation**

FMGC Failure.....	8.90.1
IRS/ADR Failures .....	8.90.1
Dual Radio Altimeter Failure .....	8.90.2

## **Power Plant**

All Engine Flameout .....	8.100.1
Tail Pipe Fire .....	8.100.2

## **Miscellaneous**

Overweight Landing .....	8.110.1
Emergency Descent.....	8.110.2
Unreliable Airspeed Indications.....	8.110.2



## PREFACE

This chapter highlights techniques to be used in some non-normal operations. Some of the procedures discussed in this chapter are the result of double or triple failures. Whilst it is very unlikely that any of these failures will be encountered, it is useful to have a background understanding of the effect that they have on the handling and management of the aircraft. In all cases, handle the ECAM as described in FCTM Ch 2.

## USE OF AUTOPILOT

The use of the autopilot is strongly recommended:

- In the case of engine failure, without any restriction including autoland or Cat 2/3 ILS.
- In case of other failures, down to 500 ft AGL in all modes, however the AP has not been certified in all configurations and its performance cannot be guaranteed. If the AP is used in such circumstances, remain vigilant and be prepared to disconnect the AP if the aircraft deviates from the desired or safe flight path.

## MONITORING AND CROSS-CHECKING

Monitoring and cross-checking are essential components of effective procedures and remain primary tasks for all crew members. The PF shall monitor all ECAM/checklist actions.

## MEMORY ITEMS

The following procedures are to be applied from memory:

- WINDSHEAR
- WINDSHEAR AHEAD
- TCAS
- EGPWS
- LOSS OF BRAKING
- EMER DESCENT (initial actions)
- UNRELIABLE AIRSPEED INDICATIONS (initial actions)

On completion of the memory items and when the aircraft is stabilised on the correct flight path, the PNF shall ensure that all the required memory actions have been carried out by reference to ECAM or checklist, and then complete the remainder of the procedure.



## LANDING DISTANCE PROCEDURE

Should a failure occur with a “LDG DIST PROC APPLY” action displayed on the ECAM STATUS page, the pilot should enter the LDG CONF/APP SPD/LDG DIST/CORRECTIONS FOLLOWING FAILURES table in QRH Part 2 to establish:

- The flap lever position for landing
- $\Delta VREF$  if required for VAPP determination
- The landing distance factor for landing distance calculation

## VAPP DETERMINATION

Certain failures affect the approach speed:

- Some failures (typically slat or flap) increase the VLS. In this case, the VLS displayed on the PFD takes into account the actual configuration. VLS on the PERF APPR page is not modified.
- For some other failures, there is a requirement to fly at speed higher than VLS to improve the handling characteristics of the aircraft. In this case, ECAM provides a speed increment, called  $\Delta VLS$ , which is displayed on the STATUS page. This speed increment is to be added to the VLS displayed on the PFD when the landing configuration is reached.

In all cases,

$$V_{app} = VLS \text{ (PFD)} + \underbrace{\Delta VLS \text{ (ECAM)} + \text{Wind correction}}_{\text{When required}}$$

In order to prepare the approach and landing, the pilot needs to know VAPP in advance. The appropriate VLS is not necessarily available at that time on the PFD, because the landing configuration has not yet been established. Therefore, VAPP is determined using VREF, which is the VLS of CONF FULL, and is available both on MCDU PERF APPR page and in the QRH.  $\Delta VREF$ , if required, is then extracted from the QRH and added.

$$V_{app} = V_{ref} + \underbrace{\Delta V_{ref} + \text{Wind correction}}_{\text{When required}}$$



Notes:

1. When computing VAPP, wind correction is normally 1/3 of the tower headwind component. If  $\Delta VREF/\Delta VLS < 20$  kt, then  $\Delta VREF/\Delta VLS +$  wind correction should not exceed 20 kt. No wind correction should be applied if  $\Delta VREF/\Delta VLS \geq 20$  kt.
2. Ensure CONF FULL is selected for the landing configuration when using VLS on the PERF APPR page to determine VREF. If CONF 3 is required for landing, it may then be selected on the MCDU.

**$\Delta VREF$  IN QRH VERSUS  $\Delta VLS$  ON PFD**

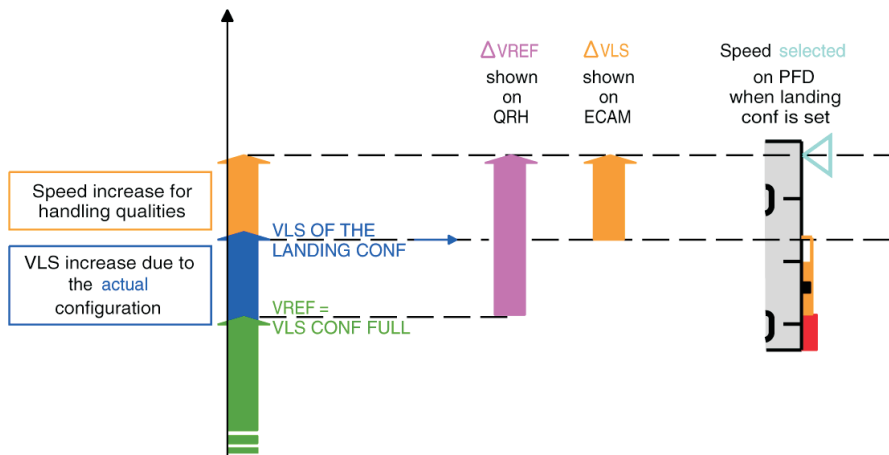

If the QRH requires a  $\Delta VREF$ , determine VAPP as described above and insert it on the PERF APPR page. When fully configured for landing, check the reasonableness of the pilot computed final approach speed against the VLS on the PFD.

If the QRH does not require a  $\Delta VREF$ , then proceed as for normal operations using the VAPP on the PERF APPR page as computed by the FMGC.



## LANDING DISTANCE CALCULATIONS

The actual landing distance is measured from 50 ft above the runway surface until the aircraft comes to a complete stop. This distance is measured during flight testing and represents the maximum aircraft performance. It is called LANDING DISTANCE WITHOUT AUTOBRAKE in the QRH. These distances are calculated at VLS. The tables provide corrections for VAPP or other speed increments above VLS.

Should a failure occur in flight, which requires the actual landing distance to be multiplied by a factor, then apply the factor to the LANDING DISTANCE WITHOUT AUTOBRAKE CONFIGURATION FULL figure.

Conversely, the AUTOLAND LANDING DISTANCE WITH AUTOBRAKE table available in the QRH gives a realistic indication of the aircraft performance during normal operations. Therefore, refer to this table if an enroute diversion is required and no landing distance factor is to be applied.

## LAND ASAP

In a non-normal situation the Captain, being responsible for the operation and the safety of the flight, must make the decision to continue the flight as planned or divert. In all cases, the Captain is expected to take the safest course of action.

The ECAM assists the crew in making this decision by indicating LAND ASAP either in amber or red:

- If a non-normal procedure causes a LAND ASAP to appear in amber on the ECAM, the crew should consider the seriousness of the situation and the selection of a suitable airport.
- If an emergency procedure causes LAND ASAP to appear in red on the ECAM, the crew should land at the nearest suitable airport.

Following the failure of an engine on a twin-engined aircraft, an emergency situation exists and the Captain shall land at the nearest suitable airfield. The relative suitability of airports is at the Captain's discretion based on a number of factors including, but not limited to, weather, navigation aids, runway length and fire and rescue support facilities. The Captain may determine that, based on the nature of the situation and an examination of the relevant factors, it is preferable not to divert to the nearest airport but to continue to a more suitable airport at a greater distance.

For a fire that cannot be confirmed as extinguished, or persistent smoke, the safest course of action is to descend and carry out an Emergency Landing with consideration being given to a possible passenger evacuation.

In the case of a LAND ASAP in red, consider an Overweight Landing rather than delaying to jettison fuel.



## LOW SPEED ENGINE FAILURE

If an engine failure occurs at low speed, the resultant yaw may be significant, leading to rapid displacement from the runway centreline. For this reason, it is essential that the Captain keep his hand on the thrust levers once take-off thrust has been set. Directional control is achieved by immediately closing the thrust levers and using maximum rudder and braking, as required. If necessary, use the steering handwheel to prevent runway departure.

## REJECTED TAKE-OFF

Experience has shown that a rejected take-off can be hazardous, even if correct procedures are followed. Some factors that can detract from a successful rejected take-off are:

- Tyre damage
- Worn or defective brakes
- Error in gross weight determination
- Incorrect performance calculations
- Incorrect runway line-up technique
- Initial brake temperature
- Delay in initiating the stopping procedure
- Runway friction coefficient lower than expected

Thorough pre-flight preparation and a conscientious exterior inspection can eliminate the effect of some of these factors.

During taxi-out, review the take-off briefing. During this briefing, confirm that the computed take-off data reflects the actual take-off wind and runway conditions. Any changes to the planned conditions require re-calculation of the take-off data. In this case, do not be pressured into accepting a take-off clearance before being fully ready. Similarly, do not accept an intersection departure until the take-off performance has been re-calculated and checked.

The line-up technique is very important. Use the recommended technique to minimise field length loss and consequently, to maximise the accelerate-stop distance available. FCTM Ch 3 refers.

A rejected take-off is a potentially hazardous manoeuvre and the time for decision making is limited. To minimise the risk of inappropriate decisions to reject a take-off, many ECAM warnings and cautions are inhibited between 80 kt and 1,500 ft. Therefore, any warnings received during this period must be considered as significant.



To assist in the decision making process, the take-off is divided into low and high speed regimes, with 100 kt being chosen as the dividing line. The speed of 100 kt is not critical, but was chosen in order to help the Captain make the decision and to avoid unnecessary stops from high speed. Below 100 kt, the Captain should seriously consider discontinuing the take-off if any ECAM warning is activated. Above 100 kt and approaching V1, the Captain should be "go-minded" and only reject the take-off in the event of a major failure such as a fire warning or severe damage, sudden loss of thrust, any indication that the aircraft will not fly safely, or if an ECAM warning occurs. Examples of ECAM warnings that may occur are ENG or APU FIRE, ENG FAIL, CONFIG, SIDESTICK FAULT, REVERSER UNLOCKED, and L+R ELEV FAULT. If a tyre fails within 20 kt of V1, unless debris from the tyre has caused noticeable engine parameter fluctuations, it is advisable to get airborne, reduce the fuel load and land with a full runway length available.

V1 is the maximum speed during the take-off roll at which the pilot must take the first action to stop the aircraft within the accelerate-stop distance. For certification purposes, an engine failure recognition time of 1 second is allowed between the engine failure and V1. Additionally a distance margin, equivalent to 2 seconds at a constant speed equal to V1, is added to the accelerate-stop distance. This increases the safety margin.

V1 is also the minimum speed in the take-off roll, following a failure of the critical engine at V1, at which the pilot can continue the take-off and achieve the required height above the take-off surface within the take-off distance. The RTO Operational Margins diagrams below, give an indication of the consequences of rejecting the take-off after V1 and/or using improper procedures.

The decision to reject the take-off is the responsibility of the Captain and must be made prior to V1. If a malfunction occurs before V1, for which the Captain does not intend to reject the take-off, he announces his intention by calling "GO". If the Captain decides to reject the take-off, he calls "STOP". This call both confirms the decision to reject the take-off and also indicates that the Captain now has control. This is the only time that hand-over of control is not accompanied by the phrase "I have control".



During the rejected take-off, the First Officer monitors and calls "Spoilers, Rev Green, Decel" as appropriate and "70 kt" during deceleration. It is important to remember the following:

- If the take-off is rejected prior to 72 kt, the spoilers will not deploy and the autobrake will not be activated.
- If the autobrake response does not seem appropriate for the runway condition, apply and maintain full manual braking.
- If the autobrake is unserviceable, the Captain should simultaneously apply maximum pressure on both pedals as the thrust levers are set to idle. The aircraft will stop in the minimum distance only if the brake pedals are kept fully depressed until the aircraft comes to a stop.
- If normal braking is inoperative, immediately select the A/SKID & N/W STRG (A346: A/SKID) switch to OFF and modulate brake pressure as required below 1000 psi.
- Full reverse may be used until complete stop. However if there is sufficient runway available for the deceleration, reduce reverse thrust preferably when passing 70 kt.
- Do not attempt to clear the runway until it is absolutely clear that an evacuation is not necessary and that it is safe to do so. If the aircraft comes to a complete stop using autobrake, release the autobrake prior to taxi by disarming the spoilers.

The Captain brings the aircraft to a complete stop, sets the parking brake and advises the cabin crew to "REMAIN SEATED" prior to commencing ECAM actions. If the take-off has been rejected due to a fire, consider positioning the aircraft to keep the fire away from the fuselage, taking into account the wind direction. The First Officer carries out the ECAM actions and the Captain decides on the next course of action, depending on the circumstances. Give consideration to:

- Possible passenger evacuation of the aircraft on the runway
- Vacating the runway as soon as possible
- Communicating intentions or requests to ATC

If the take-off has been rejected due to an engine fire, ECAM actions should be completed down to and including discharging the fire agents into the affected engine. If the fire remains out of control after having discharged the fire agents, the on ground EMERGENCY EVACUATION paper checklist should be actioned. On the ground, the right hand dome light automatically illuminates in case of a rejected take-off whatever the dome switch position allowing the EMERGENCY EVACUATION checklist to be completed even if normal electrical supply is lost.

If required, the EMERGENCY EVACUATION checklist is on the back page of the plasticised Normal Checklist. When the aircraft is on battery power alone, the crew seats can only be operated manually.





### Dry runway baseline

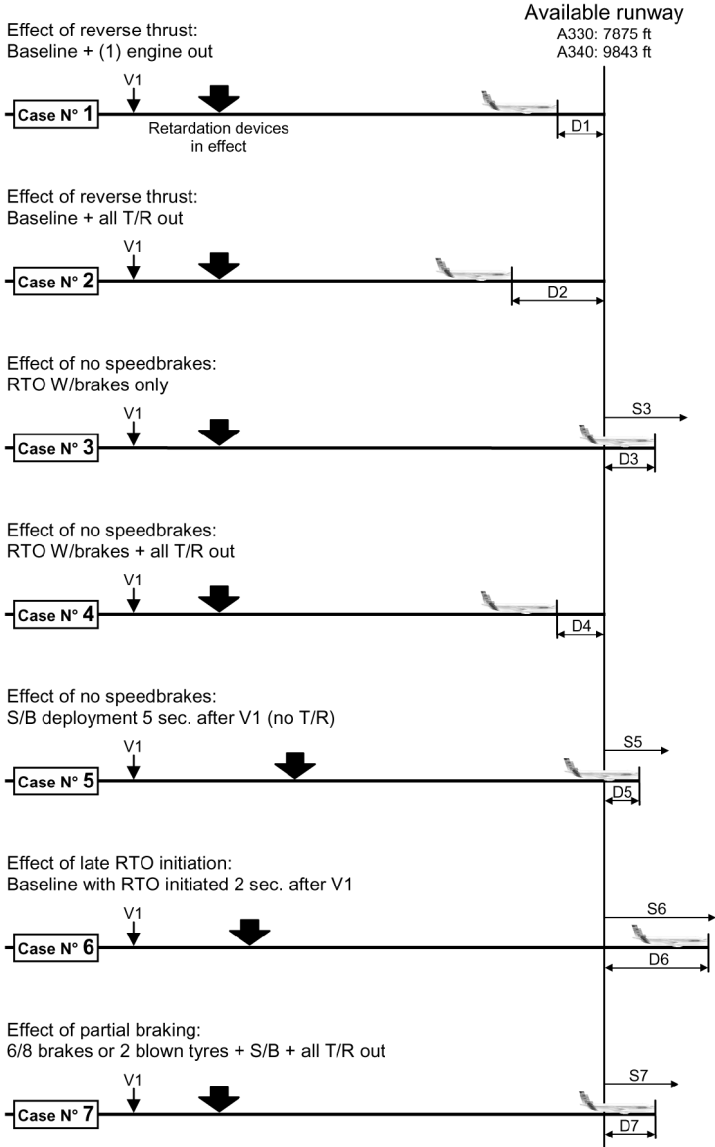

RTO Operational Margins (Dry Runway)



**Wet runway**

Wet runway at dry runway  
Limit weight and V1.  
Brakes + S/B + engine failure  
VEF = Point of failure

Available runway  
A330: 7875 ft  
A340: 9843 ft

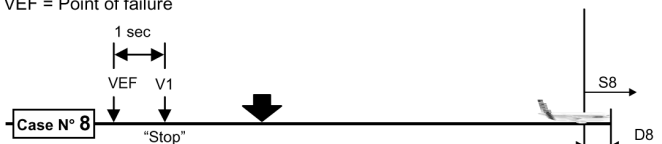

Wet runway at dry runway  
Limit weight and V1. Brakes + S/B + (1) T/R

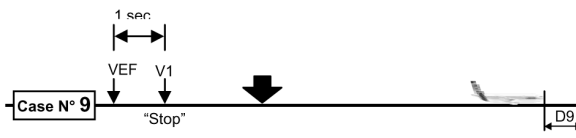

**RTO Operational Margins (Wet Runway)**

Case		1	2	3	4	5	6	7	8	9
A 3 3 0	Overrun Speed (kt)	—	—	40	—	30	55	35	—	—
	Distance Variation (ft)	-240	-450	+250	-250	+160	+470	+275	-20	-175
A 3 4 0	Overrun Speed (kt)	—	—	45	—	35	50	3	25	—
	Distance Variation (ft)	-470	-600	+400	-320	+230	+480	+190	+100	0

A successful rejected take-off, at or near V1, is dependent upon the Captain making a timely decision and using the correct procedures.



## ENGINE FAILURE AFTER V1

If an engine fails after V1 the take-off must be continued. Stabilise the aircraft at the correct pitch attitude and airspeed and establish correct tracking prior to the initiation of the ECAM procedure.

The use of the autopilot is strongly recommended. Following an engine failure, trim out the rudder forces prior to autopilot engagement. This requires approximately 20° of rudder trim, which takes approximately 7 sec to apply.

On the ground, use the rudder conventionally to maintain the aircraft on the runway centreline. At VR, rotate smoothly using a continuous, yet slightly slower pitch rate than with all engines operating, to an initial pitch attitude of 12.5°. The combination of high FLEX temperatures and low V speeds requires precise handling during the rotation and lift-off. The 12.5° pitch target will ensure the aircraft becomes airborne. Avoid following the SRS immediately after take-off as it will initially be commanding too high an attitude. Once the FD pitch bar comes down towards the aircraft symbol, follow the SRS order. This may demand a lower pitch attitude to acquire or maintain V2. When safely airborne with a positive ROC and RA increasing, retract the landing gear.

Use rudder to prevent yaw. Shortly after lift-off the blue Beta ( $\beta$ ) target replaces the normal sideslip indication on the PFD. Adjust rudder to zero the  $\beta$  target. When the  $\beta$  target is centred, total drag is minimised even though there is a small amount of sideslip. The calculation of the  $\beta$  target is a compromise between drag produced by deflection of control surfaces and airframe drag produced by a slight sideslip. Centring the  $\beta$  target produces less total drag than centring a conventional ball, as rudder deflection, aileron deflection, spoiler deployment and aircraft body angle are all taken into account.

Control heading conventionally with bank, keeping the  $\beta$  target at zero with rudder. Accelerate if the  $\beta$  target cannot be zeroed with full rudder. Trim the rudder conventionally.

Once airborne with a positive rate of climb and the radio altitude increasing, the PF calls for "Gear Up".



Consider the use of TOGA thrust taking into account the following:

- For a FLEX take-off, selecting the operating engine(s) to TOGA provides an additional performance margin, but is not a reduced thrust take-off certification requirement. The application of TOGA very quickly provides a large thrust increase. However, this comes with a significant increase in yawing moment and an increased pitch rate. The selection of TOGA restores thrust margins but it may increase aircraft handling workload
- ALT/NAV mode changes may occur if TOGA is selected after the ALT pb is pressed with flaps/slats retracted. HDG mode will engage and command the aircraft heading at the time of TOGA selection
- For a DRT take-off, asymmetric TOGA thrust must not be selected if the speed is below F speed in CONF 2 and 3 due to VMCA considerations. FCTM Ch 4 refers
- TOGA thrust is limited to 10 minutes

The PNF closely monitors the aircraft's flight path and cancels any Master Warning or Caution. At 400 ft RA, the PNF reads the ECAM title displayed on the top line of the E/WD. Once the PF has stabilised the flight path, he confirms the failure. If it is necessary to delay the ECAM procedure, he orders "Standby". Otherwise he announces "I have control, ECAM actions". It is not necessary to rush into the ECAM actions and 400 ft RA is the minimum height at which commencement of the actions should be considered.

Normally, only those actions involving movement of the THRUST LEVER and/or ENG MASTER and those actions required to clear RED warnings are carried out prior to level acceleration and flap retraction. However, in the event of ENG FAILURE WITH DAMAGE or ENG FIRE, the ECAM procedure is continued until the engine is secured. For less critical failures, ECAM actions can be interrupted when necessary to allow both pilots to monitor normal operational requirements.

At the engine-out acceleration altitude, select ALT to level off and accelerate. If the aircraft is being flown manually, the rudder input needed to keep the  $\beta$  target centred reduces as airspeed increases. Retract the flaps as normal. When the flap lever is at zero, the  $\beta$  target reverts to the normal sideslip indication which should be centred conventionally using rudder. As the speed trend arrow reaches Green Dot speed in clean configuration, pull for OP CLB.

Select THR MCT when the LVR MCT message flashes on the FCU, triggered as the speed index reaches Green Dot and resume the climb using MCT. If the thrust levers are already in the FLX/MCT detent, move them to CL and then back to MCT to engage the A/THR. After MCT is set, both packs are selected on by the PNF (if previously off for take-off).



When an engine failure occurs after take-off, noise abatement procedures no longer apply. The acceleration altitude provides a compromise between obstacle clearance and engine thrust limiting time. It allows the aircraft to be configured to Flap 0 and Green Dot speed. This provides the best climb gradient.

Once established on the final take-off flight path, continue the ECAM until the STATUS is displayed. At this point, carry out the AFTER T/O checklist. Finally, review the STATUS and consult the OEB for applicability.

GFC5-03-0210-005-A100AA

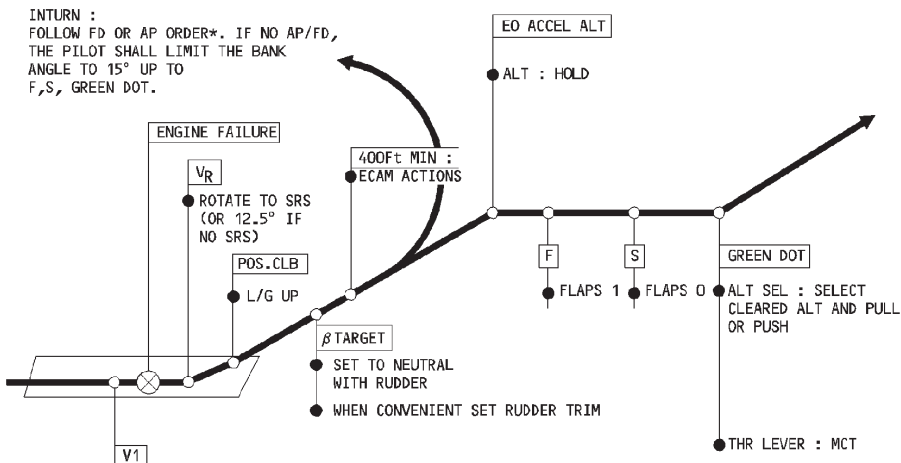

**NOTE :** FOR APPROACH AND LANDING, APPLY STANDARD APPROACH PROCEDURE.

- \* BANK ANGLE IS LIMITED TO
- 15° UP TO (MANEUVERING SPEEDS - 10KTS)
  - THEN, LINEAR INCREASE TO 25° UP TO (MANEUVERING SPEEDS - 3KTS)
  - 25° ABOVE (MANEUVERING SPEEDS - 3KTS)



## ENGINE FAILURE DURING INITIAL CLIMB-OUT

Proceed as above. If the failure occurs above V<sub>2</sub> however, the SRS will command an attitude to maintain the speed at which the failure occurred. In any event the minimum speed is V<sub>2</sub>.

When an engine failure is detected, the FMGS predictions are based on the engine-out configuration and any pre-selected speeds entered in the MCDU are deleted. Consider the use of the EOSID, if one exists in the database.

## ENGINE FAILURE DURING CRUISE

There are three strategies available for dealing with an engine failure in the cruise:

- Standard strategy
- Obstacle strategy
- Fixed speed strategy

Unless a specific procedure has been established before dispatch (considering ETOPS or mountainous areas), the standard strategy is recommended.

As soon as an engine failure is recognised, the PF should call for the ECAM actions and simultaneously:

- Set MCT on the remaining engine(s).
- Disconnect the A/THR.
- Select the SPEED according to the strategy.
- Select a HDG to keep clear of the airway, preferably heading towards an alternate, if appropriate. Consider the aircraft position relative to any relevant critical or equi-time point.
- Select the LRC ceiling or driftdown ceiling according to strategy in the FCU ALT window and pull for OP DES when target speed is reached.

Placing the thrust lever(s) to MCT and carrying out the ECAM actions should not be rushed, as it is important to complete the procedure correctly. Generally, there is sufficient time to cross-check all actions. However, at high levels close to limiting weights, more urgency is required, as speed decays more quickly.

The FCU selections for an engine failure run from left to right:

- SPD select.
- HDG select.
- FCU altitude insert.
- ALT selector pull (when target speed is reached).



## **Standard Strategy (Long Range Strategy)**

Set .82M/300 kt. The speed of .82M/300 kt is chosen to ensure the aircraft is within the stabilised windmill engine relight in-flight envelope. The thrust is fixed at MCT with A/THR disconnected and speed is controlled by the elevator. The REC MAX EO cruise level displayed on the EO PROG page, equates to LRC with anti-icing off. The nearest semi-circular or RVSM cruise level at or below this level should be set on the FCU. Once established in the descent, the PERF CRZ page shows time to descend and predicted descent distance. These can also be checked on the relevant performance table in the QRH. If V/S becomes less than 500 ft/min, select V/S -500 ft/min and A/THR on. This is likely to occur approaching level off altitude, or at light weight.

Cruise altitude and speed are also available in the QRH in case of double FM failure.

## **Fixed Speed Strategy**

For ETOPS operations, a fixed speed strategy is adopted for planning purposes to establish the maximum diversion distance and the diversion fuel requirements for the single engine ETOPS critical scenario. Two fixed speed strategies are considered:

- VMO (M.82/330/MCT)
- 310 kt (M.82/310/MCT)

During an ETOPS diversion the Captain may choose to adopt any suitable strategy and is not required to fly the fixed speed strategy unless operationally required.

ETOPS is taught as a separate course. Volume 2 Part 2 refers.

## **Obstacle Strategy**

To minimise the rate and angle of descent and enable the aircraft to clear high terrain or obstacles on the intended flight path, the drift down procedure should be adopted. The procedure is similar to the standard strategy, except that the speed target is Green Dot.

The PERF CRZ page displays the drift down ceiling, assuming Green Dot speed. Conversely, the PROG page displays the EO REC MAX ALT assuming LRC speed. The drift down ceiling at Green Dot is higher than the EO REC MAX ALT and the aircraft should be able to stabilise at this altitude. When clear of obstacles, set the LRC ceiling on the FCU and descend if required. Accelerate to LRC speed and engage A/THR.



## **ONE ENGINE INOPERATIVE LANDING**

Autoland is available with one engine inoperative. Maximum use of the AP should be made to minimise crew workload.

If an autoland is not possible, e.g. due to airport equipment limitations, fly a manual approach. A manual approach and landing with one engine inoperative is conventional. Use rudder trim to keep the sideslip indication centred. The sideslip indication remains yellow as long as N1 on the remaining engine(s) is below 80%. With flap selected and thrust above 80% N1, the indicator changes to the engine-out mode blue  $\beta$  target. This visual cue indicates that the aircraft is approaching its maximum thrust capability. Although the A/THR is available, some pilots may prefer to use manual thrust as they find it easier to anticipate rudder inputs as the power changes.

Avoid selecting the gear down in level flight, as high thrust settings will be required, increasing the handling workload.

To make the landing run easier, it is recommended to reset the rudder trim to zero in the later stages of the approach. Anticipate the increased rudder force required as the trim is removed when the rudder trim reset button is pressed. With rudder trim at zero, the neutral rudder pedal position corresponds to zero rudder and zero nose wheel deflection.

After touchdown, use any remaining reverser(s).

## **CIRCLING ONE ENGINE INOPERATIVE**

A circling approach with one engine inoperative requires the downwind leg to be flown in CONF 3, with landing gear extended. In hot and high conditions, the aircraft may not be able to maintain level flight in CONF 3 with landing gear down. In this case, landing gear extension should be delayed until leaving the circling altitude. Until the gear is locked down and depending on the circling altitude, it is possible to receive the L/G GEAR NOT DOWN ECAM warning (below 750 ft RA) or a GPWS "TOO LOW GEAR" (below 500 ft RA). However, with a minimum circling altitude of 1000 ft AAL it is unlikely that this problem will be encountered.





## ONE ENGINE INOPERATIVE GO-AROUND

A one engine inoperative go-around is similar to that flown with all engines operating. On the application of TOGA, rudder must be applied promptly to compensate for the asymmetric increase in thrust and to keep the  $\beta$  target centred. Smoothly increase pitch to follow the SRS. If SRS is not available, the initial target pitch attitude is 12.5°. As a one engine inoperative approach is flown with Flaps 3, the initial flap retraction is to Flaps 2. With a positive ROC and an increasing RA, retract the gear. The lateral FD mode is initially GA TRK, which guides the aircraft on the track at TOGA selection. If there are terrain considerations on the go-around path or specific tracking requirements, select NAV without delay. Select ALT at the engine inoperative acceleration altitude and retract the flap using the same technique as described in the Engine Failure after V1.

At certain weights and CG positions, it may not be possible to satisfy  $\beta$  target demands at VLS. Consequently, when obstacle clearance is assured, accelerate to a speed at which the  $\beta$  target can be satisfied.

## TWO ENGINES INOPERATIVE LANDING (A343/A346)

### General

Operational requirements following a second engine failure are detailed in Volume 2 Part 2. Continued flight may be complicated by driftdown, lateral navigation requirements to ensure terrain clearance, fuel jettison to achieve desired performance and other factors.

It is recommended that weather at the selected ERA should permit visual flight on approach from at least 500 ft AGL to the runway. The primary consideration for approach, landing and go-around is one of control. Go-arounds in particular require careful planning, briefing and execution to ensure controllability margins are not compromised.

The nature of the failure also needs to be considered, particularly which combination of engines and associated hydraulic systems have been lost.

### Loss Of One Engine On Each Wing

For the loss of any two engines from opposite wings, VLS on the MCDU and PFD is limited to VMCL (A343: 125 kt), (A346: 132 kt). The loss of engines 1 and 4 does not have a major effect on control, however without the green hydraulic system a manual landing gear extension is required and there is no retraction capability. Consequently a go-around is not possible after L/G extension and the aircraft is committed to land. Landing must be assured prior to L/G extension.



## Loss Of Two Engines On The Same Wing

Control of the aircraft is more complicated following the loss of two engines on a single wing. The critical factor is speed, which must not reduce below VMCL-2 (157 kt) until landing is assured. VLS displayed on the PFD will never be lower than VMCL-2. Speed reduction below VMCL-2 is permissible once landing is assured. L/G retraction is available in the event of a go-around, but failure to maintain VMCL-2 with TOGA thrust applied and an insufficient bank angle, will result in loss of directional control.

### Approach

A “Commit Altitude” is established for any two engine approach. The equivalent height should never be below 500 ft AGL. It serves two purposes; to establish a decision point on approach from which a “land or go-around” decision can be made, and because it is well above the Cat 1 minima (200 ft AGL), it provides a 300 ft buffer. In the event of a performance-limited go-around, this buffer can be used to descend and clean up whilst easily ensuring that speed will be well above VMCL-2 when the nose is raised to climb away.

The Commit Altitude should be inserted on the MCDU PERF APPR page as the MDA, but is not a “not below” altitude in the conventional sense.

Autothrust is disconnected once stabilised on final approach. At the Commit Altitude with the landing assured, speed may be reduced to normal VAPP. In the case of two engines inoperative on the same wing, VAPP will be below the VLS displayed on the PFD (VMCL-2), e.g based on the MCDU VLS in case of loss of two engines on the same wing. Speed reduction below VMCL-2 is acceptable at this stage, as VMCL-2 is based on the use of TOGA thrust on the remaining engines, and adequate margins remain at normal approach speeds and thrust settings.

### Go-Around

If a landing is not assured by the Commit Altitude (or immediately prior to L/G extension with engines 1 and 4 inoperative), then a go-around should be initiated. If the approach has been flown accurately, the speed will be at VLS.

TOGA thrust should be selected. At certain weights and CG positions, it may not be possible to satisfy the  $\beta$  target demands at VLS. If two engines are inoperative on the same wing, this may require leading with the inboard thrust lever. TOGA should be achieved on the outboard engine as soon as directional control permits, but without undue delay. When obstacle clearance is assured, accelerate to a speed at which the  $\beta$  target can be satisfied.



As TOGA is selected, PF calls “Go Around, Flaps 1, Gear Up”. These directives may be actioned simultaneously by the PNF as landing gear retraction from above the Commit altitude does not require confirmation of a positive rate of climb. The important thing is to reduce drag as quickly as possible. If necessary, the descending approach path may be maintained while these actions are performed, but not below 200 ft AGL. In normal circumstances, this will be in VMC.

If a go-around is required in IMC, the aircraft may descend below the Commit Altitude, but should not descend below the minima for the approach aid in use to ensure obstacle clearance is maintained. If such a go-around is envisaged, the briefing should cover crew intentions regarding the use of autoflight systems, as the FD will command a pitch up to SRS as soon as the first thrust lever reaches the TOGA detent.

## **RECOVERY FROM ALPHA PROTECTION AND ALPHA FLOOR**

### **General**

If alpha protection or alpha floor is triggered inadvertently, recover from these protection modes as soon as other considerations allow by easing forward on the sidestick to reduce the angle of attack below the value set for alpha protection, while simultaneously increasing thrust.

### **Alpha Protection**

Pitch control will resume the normal load factor law if the stick is pushed forward of neutral, but will re-enter alpha protection if the stick is released with the indicated airspeed still below  $V_{\alpha}$  PROT. Consequently, to exit alpha protection properly, reduce the angle of attack to a value less than that set for alpha protection.

The PFD shows the recovery clearly, because the indicated speed will be above the black and amber strip when out of alpha protection. When no longer in alpha protection, increase speed above VLS (top of the amber strip) as soon as other considerations allow.

### **Alpha Floor**

Alpha floor will normally be triggered just after alpha protection is entered, and TOGA thrust will be applied automatically. To recover to a normal flight condition, alpha protection should be exited by easing forward on the sidestick, as described above. The “alpha floor” thrust condition should be canceled by using the A/THR disconnect pushbutton on either thrust lever as soon as a safe speed above VLS is regained.



## **STALL RECOVERY**

In alternate and direct laws, an aural stall warning “STALL, STALL, STALL” sounds at low speeds. Recovery is conventional. Apply the following actions simultaneously:

- Set TOGA thrust
- Reduce pitch attitude to 10° below FL200 or 5° at or above FL200
- Roll wings level
- Check that the speedbrake is retracted

Below FL200 and in the clean configuration, select Flaps 1. If ground contact is possible, reduce pitch attitude no more than necessary to allow airspeed to increase. After the initial recovery, maintain speed close to VSW until it is safe to accelerate.

When out of the stall condition and no threat of ground contact exists, select the landing gear up. Recover to normal speeds and select flaps as required.

In case of one engine inoperative use thrust and rudder with care.

The aural stall warning may also sound at high altitude, where it warns that the aircraft is approaching the angle of attack for the onset of buffet. To recover, relax the back pressure on the sidestick and if necessary reduce bank angle. Once the stall warning stops, back pressure may be increased again, if necessary, to get back on the planned trajectory.

## **RECOVERY FROM HIGH SPEED PROTECTION**

### **On Descent**

In managed descent, if the speed is accelerating towards VMO/MMO due to descending out of a tailwind, or there is an encounter with windshear, pull for OPN DES. This action will immediately command thrust idle and the target speed will be the managed descent speed in the FM, or the speed selected on the FCU. Speed brake may also be used to assist in controlling the speed.

If the aircraft accelerates above VMO/MMO and triggers the high-speed protection the autopilot will disengage. If VMO/MMO is exceeded significantly the associated overspeed aural warning may have overwhelmed the autopilot disconnect aural warning.

The high-speed protection will provide a nose-up order in addition to any pilot input during the recovery. It is not usually necessary to use a pull force to recover. If a quicker recovery is required for operational reasons, pull back smoothly and progressively, monitoring the “g” indication on the ECAM. It is important to consider the effect of increased “g” on the people who may be standing in the cabin.

When below the high-speed protection range, check autopilot engagement status and re-engage it if necessary.



## Cruise

In the cruise an encounter with CAT, windshear, or standing waves may cause the speed to increase rapidly. The recommended technique for recovery is to initially select a lower speed on the FCU, but not below green dot. This will have the effect of commanding the autothrust system to reduce the thrust, which may be sufficient to stop a VMO/MMO exceedance.

If the aircraft accelerates above VMO/MMO and triggers the high-speed protection the autopilot will disengage and the high-speed protection will provide a nose-up order. If VMO/MMO is exceeded significantly the associated overspeed aural warning may have overwhelmed the autopilot disconnect aural warning.

The pilot should not pitch up to reduce speed, but should attempt to maintain the cruise altitude by making smooth inputs on the sidestick. The autothrust system will be reducing the thrust, and it should not be necessary to disconnect the autothrust. It is preferable to leave the autothrust engaged to reduce workload once the cause of the overspeed is passed. In extreme cases the speedbrakes may be used, but they should be used with caution at high altitudes.

When below the high-speed protection range, check autopilot engagement status and re-engage it if necessary.



## EMERGENCY ELECTRICAL CONFIGURATION

The Emergency Electrical Configuration is triggered by the loss of all AC busbars. This results in the automatic engagement of the Emergency Generator, driven by the Green hydraulic system and powered by either the Engine Driven Pump (EDP) or the RAT, depending upon the cause of the failure. It is most unlikely that this configuration will ever be encountered, but be aware that workload is immediately increased in Emergency Electrical Configuration, The handling of this failure is referred to as a "complex procedure". A summary for handling the procedure is included in the QRH, which should be referred to upon completion of the ECAM procedure.

The electrical distribution network has been designed to enable the crew to fly the aircraft, navigate and communicate. The list of equipment available in Emergency Electrical Configuration is detailed in the QRH. The available systems of particular interest prior to selection of LAND RCVY are:

### A333

	EMER GEN Powered by EDP	EMER GEN Powered by RAT
<b>FLY</b>	AP1, PFD 1, Pitch trim, Rudder trim, ALTN LAW, Upper ECAM, ECP, ISIS/STBY INST	PFD 1, ALTN LAW, Upper ECAM, ECP, ISIS/STBY INST
<b>NAV</b>	ND 1, FMGC 1, MCDU 1, DDRMI (VOR/DME 1 or ADF 1), FCU, WXRDR 1	FCU, STBY NAV (via RMP 1), DDRMI (VOR 1 or ADF 1)
<b>COMM</b>	VHF 1, HF 1, RMP 1, ACP 1 & 2, Loudspeakers 1 & 2	VHF 1, RMP 1, ACP 1 & 2, Loudspeakers 1 & 2

### A343/A346

	EMER GEN Powered by EDP	EMER GEN Powered by RAT
<b>FLY</b>	PFD 1, Pitch trim, Rudder trim (without centre pedestal position indication), ALTN LAW, Upper ECAM, ECP, ISIS/STBY INST	PFD 1, ALTN LAW, Upper ECAM, ECP, ISIS/STBY INST
<b>NAV</b>	MCDU 1 (B/U NAV), STBY NAV (via RMP 1), DDRMI (VOR/DME 1 or ADF 1), FCU	FCU, STBY NAV (via RMP 1), DDRMI (VOR 1 or ADF 1)
<b>COMM</b>	VHF 1, RMP 1, ACP 1 & 2, Loudspeakers 1 & 2	VHF 1, RMP 1, ACP 1 & 2, Loudspeakers 1 & 2



Only PFD 1 is available. The AP will disengage when the failure occurs but AP 1 can be reengaged on the A333 if the EMER GEN is powered by an EDP. As there is no AP available in this configuration in the A340, the Captain must take control and fly the aircraft manually. The A340 aircraft is out of trim in roll due to right outboard aileron upfloat, caused by no power being available to Prim 3 or Sec 2, and neither pitch trim or rudder trim is available. The aircraft is in ALTN law (A333 due loss of slat/flap position; A340 due loss of 2 ADRs). Consequently, pay close attention to bank angle and heading. A333/A346: is in N1 degraded mode. Once a safe flight path is established and the aircraft is under control, carry out the ECAM actions.

It is important to correctly identify the failure, as it is possible to confuse Emergency Electrical Configuration with an All Engine Flameout. Therefore, it is very important that the ECAM title is read accurately before starting the ECAM actions. The procedure is lengthy and complicated and, as only one ECAM display is available, disciplined use of the ECP is essential. FCTM Ch 2 refers. Consider starting the APU.

Although the ECAM displays LAND ASAP in red, it is unwise to attempt an approach at a poorly equipped airfield in marginal weather. Consider the power source for the Emergency Generator as the emergency generator outputs approximately twice as much electrical power when powered by the EDP. The aircraft is better configured when the EDP rather than the RAT, powers the Emergency Generator. In either case, prolonged flight in this configuration is not recommended.

TRK/FPA should be selected and FDs turned off. This allows the display of the blue track index on the Captain's PFD to assist in maintaining track. Navigation should be achieved using all available means. VOR/DME1 or ADF1 only are available on the DDRMI. The navigation facilities available depend on the aircraft type and the cause of the failure. QRH refers.

A MAYDAY should be declared. Radar headings to the nearest suitable airfield may be available and separation from other traffic can be increased.

To ensure proper fuel feed to the engines in ELEC EMER CONFIG, (A333/A343: one) (A346: two) fuel pump(s) is/are powered and the cross-feed(s) automatically open. The Engine Anti-Ice is on.



Press the LAND RECOVERY pb prior to commencing the approach. This allows the recovery of a number of systems required for landing, e.g. ILS 1, SFCC 1, LGCIU 1 (and A333: BSCU 1, LH WHC 1, LH Landing Light). It also sheds a number of systems that are no longer required, e.g. the operative fuel pump(s) (and A333: WX RDR 1, HF 1, ADR 3 hence AP 1).

During the approach, the characteristic speeds may not be displayed on the PFD and can be extracted from the QRH prior to descent. Only raw data is available for the approach. The landing gear is extended using the gravity system to prevent fluctuations in the green hydraulic system whilst the Emergency Generator is operating, thereby preventing it from possibly disconnecting. Consequently, as the doors remain open, the NWS is not available. When the gear is extended, the aircraft reverts to Flare Law (Direct) and "USE MAN PITCH TRIM" is displayed on PFD 1. Thrust reversers autobrake and antiskid are not available.

If the RAT powers the Emergency Generator, the available systems are further reduced and the requirement to land is more urgent. Of particular note is that there is no pitch trim, no rudder trim, no FMGC 1 and no AP 1. Upon selecting LAND RECOVERY, only the slat channel of SFCC 1 is recovered, so the flaps are not available for the landing. At slat extension, the Emergency Generator is inhibited, and the aircraft is supplied by batteries only.

### **Restoring Normal Electrical Power After EMER ELEC CONFIG**

When ELEC EMER CONFIG occurs, the LAND RECOVERY AC and DC BUSES are initially shed and will remain shed until the LAND RECOVERY pb is selected ON. This is true even if normal electrical configuration is restored. Consequently, after restoring normal electrical power, the LAND RECOVERY pb will still need to be selected ON for approach.



INTENTIONALLY  
BLANK



## **FIRE PROTECTION**

Fire and/or smoke in the fuselage present the crew with potentially difficult situations. Not only will they have to deal with the emergency itself, but also the passengers are likely to panic should they become aware of the situation. It is essential therefore, that action to control the source of combustion is not delayed. Consider an immediate diversion.

## **SMOKE**

If smoke or fumes are detected in the flight deck, the crew should immediately don their oxygen masks with 100% selected.

Smoke in the cabin should be easily identifiable and thus easier to fight. The source is identified either by a local warning, e.g. lavatory fire, or by direct observation by the cabin crew. In every case, the aim is to isolate the source of the smoke and extinguish any fire. When fighting a fire in the cabin, wear a PBE to avoid smoke inhalation.

It is not so easy to identify the source of smoke from either the air conditioning or avionics. If the source of the smoke is immediately obvious, isolate the faulty equipment without delay.

Air conditioning smoke can be transported to other cabin areas and some difficulty may be encountered in identifying the origin of the smoke. Avionics smoke requires the crew to isolate the faulty equipment, which can also be quite difficult to ascertain. There may not be any ECAM warning. If this is the case, apply the QRH procedure.

The QRH procedure is designed to cover all cases even where the source of the smoke or fumes is unknown. It should be applied if smoke and/or fumes are detected with or without AVNCS VENT SMOKE ECAM activation. If the AVNCS VENT SMOKE ECAM procedure is displayed, suspect avionics smoke.

The single procedure layout is organised in three steps:

- Common actions (before the text box). These should be applied immediately, whatever the origin of the smoke, and before trying to identify this origin. They are designed to protect the crew, extract the smoke overboard, prevent smoke recirculation and isolate potential sources.
- Smoke removal procedure (text box). At any time during the procedure, if dense smoke exists, the crew may apply the boxed items for smoke removal. The SMOKE REMOVAL procedure will eventually direct the crew back to complete the SMOKE/FUMES/AVNCS SMOKE procedure.
- Specific actions to identify and isolate potential smoke sources (below text box).



## **CARGO SMOKE**

The cargo smoke detectors are sensitive to the extinguishing agent. Therefore, even after successfully extinguishing a cargo fire, the SMOKE FWD (AFT/BULK) CRG SMOKE warning can be expected to remain. LAND ASAP in red is displayed on the ECAM. As there is no method of checking whether a cargo fire has been extinguished, divert to the nearest suitable airport.

On the ground, instruct the ground crew not to open the cargo door until the passengers have disembarked and fire services are present.

On the ground, smoke warnings may be triggered due to high levels of humidity or following spraying of a compartment to comply with quarantine regulations. If a SMOKE warning occurs on the ground with cargo compartment doors open, do not immediately discharge the extinguishing agent without first ordering the ground crew to investigate and eliminate the smoke source. If the warning is confirmed to be false, then once extinguished, it will be necessary to reset VENT CONT 1 & 2 reset buttons to restore normal cargo ventilation (FCOM 3.02.26 refers).



## NON-NORMAL FLAPS/SLATS CONFIGURATION

Non-normal operation of the flaps and/or slats may be due to one of the following problems:

- Double SFCC failure
- Double hydraulic failure (B+G or Y+G)
- Flaps/Slats jammed (operation of the WTB)

Non-normal operation of the flaps and slats has significant operational consequences since the control laws may change. The attitude on approach changes, approach speeds and landing distances increase and the go-around procedure may have to be modified. The most significant failure is a double SFCC fault, which leads to not only the loss of AP and A/THR but also a complete loss of speed limit information on the PFD.

Flap/slat problems are normally considered in the context of the landing phase. However, it is possible to encounter a problem during retraction after take-off. In this case, use selected speed in order to avoid exceeding VFE. The landing distance available at the departure airport and the aircraft gross weight will determine the next course of action.

The most probable time for the detection of a slat failure is on the selection of Flaps 1 for the approach. With the A/THR operative and the flaps lever at 1, the managed speed target becomes S speed. If the slats fail to extend, select Green Dot to avoid deceleration in the clean configuration, as the aircraft automatically decelerates to S speed even if the slats do not extend. Multiple failures are highly improbable, however appreciate that the initial ECAM F/CTL SLATS FAULT/LOCKED gives no indication of potential flap problems. Thus it is possible to spend time determining the appropriate landing configuration before the complete extent of the flap/slat problem has been identified. If possible, delay the approach to complete the ECAM procedure, refer to the LANDING WITH SLATS OR FLAPS JAMMED paper checklist, determine the VAPP and landing distance and to update the approach briefing.

During the ECAM procedure, Flaps 2 will be selected, as the Flap Lever Position table in the QRH directs the use of a minimum of CONF 2. If at this point there is an additional FLAPS FAULT/LOCKED message, then the full extent of the failure can be determined and the appropriate checklist actioned. If both flaps and slats are jammed at zero, the QRH directs the crew to the NO FLAPS NO SLATS LANDING checklist. Setting the flap lever back to Flaps 1 during this particular checklist is to enable the use of SRS during a go-around. VFE displayed on the PFD will be incorrect since it based on flap lever position and not the actual configuration.



In the QRH LANDING WITH SLATS OR FLAPS JAMMED checklist, the line;

"SPEED SEL.....VFE NEXT PLACARD SPD – 5 kt"

can be slightly confusing but is designed to allow the extension of the flaps/slats to the required landing configuration while controlling the speed in a safe manner. This is particularly relevant at heavy weights. The paper checklist appears to circumvent normal use of the ECAM procedure associated with the initial slats locked message. However, its intent is to resolve all SFCC issues, rather than just the initial slats SFCC issue and thus more quickly identify the achievable landing configuration. Use the lower of VFE Next or Placard Speed. (VFE Next on the PFD and placard speeds are identical, except for Flap 2 where the PFD initially displays VFE NEXT for CONF 1\* against a placard speed for CONF 2). The speed reduction and configuration changes should be carried out in non-maneuvring flight.

The following scenario on an A333 assumes a failure with the slats locking between 0 and 1 and flaps operating normally:

- Select Green Dot and use selected speed for the rest of the approach. Green Dot is used initially since the aircraft is effectively still in the clean configuration.
- With Flap 1 selected, VFE NEXT is 205 kt, Placard Speed would be 196 kt.
- Select 191 kt and when below Placard Speed of 196 kt, select Flap 2.
- While multiple failures are improbable, this is the point when any flap SFCC problems will be indicated.
- If the flaps extend, VLS reduces and the selected speed can be reduced. Do not reduce speed below VLS.
- Repeat the procedure until landing configuration is reached, using the applicable VFE NEXT.

At high weights, this procedure may involve reducing speed below the manoeuvring speed for the current configuration. In a non-normal situation this is acceptable on a short-term basis, provided the speed remains above VLS.

The landing distance factors and approach speed increments are available in the QRH. Determine the values of each as follows:

- $LDG\ DIST = Actual\ Landing\ Distance\ Without\ Autobrake, CONF\ FULL \times factor.$
- $VAPP = VREF + \Delta VREF + Wind\ correction.$

Assuming VLS is displayed on the PFD, the approach speed should be close to VLS plus wind correction, as VLS is computed using the actual slat/flap position.

The use of AP down to 500 ft AAL and A/THR (if available) is recommended. The AP is not optimised for non-normal configurations and so its performance must be closely monitored. The PF should be ready to take over manually if AP performance becomes unsatisfactory.



The QRH NO FLAPS NO SLATS LANDING checklist is a relatively simple procedure. However, more distance is required for manoeuvring. During the approach the aircraft pitch attitude is high, increasing the risk of a tailstrike. Consequently, only make a small pitch adjustment in the flare to reduce the rate of descent prior to a positive touchdown. Due to the high touchdown speed, avoid a prolonged float. The use of (A333/A343: MED) (A346: 3/4) autobrake is strongly recommended.

During the approach briefing, emphasise the configuration, calls to be made and speeds to be flown in the event of a missed approach. At the acceleration altitude, use selected speed to control the acceleration to the required speed for the configuration.

Consider the fuel available and the increased consumption associated with a diversion when flying with flaps and/or slats jammed. Cruise altitude is limited to 20000 ft when diverting with flaps/slats extended.

## ELEVATOR REDUNDANCY LOST

The F/CTL ELEV REDUND LOST procedure, which is triggered in case of dual failures affecting the flight controls, is designed to prepare the aircraft for a third related failure which would result in the simultaneous loss of one or both elevators and some ailerons. The procedure has two entry points depending on the combination of dual failures:

- Ailerons are preset (if a third related failure would result in the loss of both elevators)
- Ailerons are not preset (if a third related failure would result in the loss of only one elevator)

In anticipation of a third failure that would result in the loss of both elevators, the ailerons are preset 12° up, and the resulting pitch up moment compensated for by the elevators, which are still available, and then trimmed by the THS. This preset is a compromise between the increased fuel consumption (approximately 16%) and the pitch up moment that would occur following a third failure. The aileron preset is displayed on ECAM F/CTL page.

If a third failure would result in the loss of only one elevator, there is no aileron preset since the remaining elevator will compensate for the pitch up moment.

Depending on the combination of failures, the AP may not be available. If the ailerons are preset, the AP automatically disconnects, as its performance is less than optimum. However, below 2000 ft or when in CONF 2, the aileron preset is inhibited to facilitate the landing and permit the use of AP if available.

The F/CTL ELEV REDUND LOST procedure imposes both speed and FL limitations to ensure structural integrity and to maintain stabiliser authority should a third failure occur. It requires the application of a LDG DIST PROC and since it is the result of multiple failures, the QRH table must be carefully interrogated for the correct LDG CONF,  $\Delta VREF$  and LDG DIST factors.



The Flight Envelope computer computes CG as a function of the THS position, and this value is used to monitor the FCMC-computed CG and trigger the AFT CG warning. In the case of aileron preset, the FE-computed CG value is erroneous because the THS will be abnormally displaced to counteract the pitch up moment. Consequently any AFT CG warning should be disregarded. GWCG, computed by the FCMC and displayed on ECAM, remains reliable.

If a third failure does occur and results in the loss of both elevators, the failed ailerons reset to their zero hinge moment, equivalent to 14° up. As the ailerons were previously preset up 12°, the transition is smooth with only a slight pitch up moment that can be controlled with the THS. MAN PITCH TRIM ONLY is displayed on the top of PFD. If desired, the A/THR may be disconnected to enable smoother longitudinal control with manual pitch trim. The FL and speed limitations now no longer apply.

Flight Control Architecture, QRH Part 5 refers.



## FUEL LEAK

Significant fuel leaks, although rare, are sometimes difficult to detect. Maintaining the fuel log and comparing fuel on board to expected flight plan fuel during regular fuel checks, will alert the crew to any discrepancy. This should then be investigated without delay. Fuel checks should be carried out when sequencing appropriately spaced waypoints and at least once every hour. Any time an unexpected fuel quantity indication, ECAM fuel message or imbalance is noted, a fuel leak should be considered. Initial indications should be carefully cross-checked by reference to other means. If possible, conduct a visual inspection of the wings and engines to check for signs of a leak.

If a leak is suspected, action the non-normal checklist. If the leak is from the wing or cannot be located, it is **IMPERATIVE** that the cross-feed valve(s) is (are) not opened.

Fuel Check Procedure, FCTM Ch 5 refers.

## FUEL JETTISON

If there is no critical reason to land immediately it is desirable to jettison fuel and land as close to maximum landing weight as practicable. On the A340, with an engine secured after a failure, or with a non-critical failure, such as jammed flaps, there is no requirement to land as soon as possible.

Do not delay the landing because the aircraft is overweight if there is a critical reason to land immediately. Some valid reasons include:

- An abnormal situation on take-off that casts doubt on the continued safe operation of the flight.
- Any fire that will not extinguish.
- A life that will be endangered unless immediate medical attention is received.
- A time critical in-flight situation that requires an immediate diversion and landing.

The planning and execution of an overweight landing requires good judgement and due consideration of the many factors involved. The jettison decision must balance the urgency of an immediate landing against the demands and risks of the overweight landing.

At high landing weights the flare must be carefully judged, since the increased inertia of the aircraft requires more anticipation to achieve a normal touchdown. Any turbulence on the approach will also contribute to the possibility of a firm landing. A firm landing when the aircraft is significantly overweight increases the chance of permanent damage to the aircraft landing gear due to the increased energy absorbed by the landing gear.

The Overweight Landing checklist in QRH section 2 provides further information and guidance.





## **HANDLING OF EXPECTED LOW FUEL LEVELS AT DESTINATION**

FCOM 3.04.28 refers.

## **AVOIDANCE OF NON-STANDARD FUEL DISTRIBUTIONS ON ARRIVAL**

FCOM 3.04.28 refers.

## **AVOIDANCE OF FUEL INDUCED WING ICING ON ARRIVAL**

FCOM 3.04.28 refers.



## DOUBLE HYDRAULIC FAILURES

Single hydraulic failures have very little effect on the handling of the aircraft but cause a degradation of the landing capability to Cat 3 Single. However, double hydraulic failures are significant due to the following:

- Loss of AP
- Flight control law degradation (ALTN)
- Landing in non-normal configuration
- Extensive ECAM procedures with associated workload and task-sharing considerations
- Significant considerations for approach and landing

The electrical pumps supply only limited power and should not be used to replace the engine driven pumps to supply the flight controls as they cannot cover any high transient demands. Consequently, aircraft handling could be degraded due to flight control “jerk”. As a general rule, do not select the ELEC HYD PUMP on except temporarily to retract the spoilers if they remain out after a hydraulic failure.

The RAT is designed to supply the Emergency Generator and flight controls using the green hydraulic system, and can cover high transient demands. However, the RAT flow is significantly less than an engine driven pump flow and is dependent on the aircraft speed. The RAT may still pressurise the green hydraulic system even in the case of LO LVL. It must not be used in case of green hydraulic system overheat. At low speed, the RAT stalls. Consequently, some anticipation is required from the crew to carry out a safe landing.

A double hydraulic failure is an emergency situation, with LAND ASAP displayed in red. Declare a MAYDAY to ATC and land as soon as possible, however ECAM actions should be completed prior to the approach.

FD and A/THR are available, however the AP will be lost. Therefore, the PF will have a high workload in flying the aircraft and handling the communications, with the flight controls in Alternate Law. Additionally, depending on the exact reason for the failure, aircraft handling characteristics may be different due to the loss of some control surfaces. This failure is termed a “complex procedure”. Consequently, after completing ECAM actions, refer to the QRH summary during the handling of the procedure. It is essential that the roles of PF and PNF are clearly defined and understood. Efficient task sharing is crucial as procedures are lengthy and the approach briefing may be extensive.

As there are many tasks to complete, clear priorities must be established. If sufficient fuel remains, take time to plan carefully and brief fully. While there is no need to remember the following details, an understanding of the structure of the hydraulic and flight control systems would be an advantage. The F/CTL SD page and the OPS DATA section of the QRH provide an overview of the flight controls affected by the loss of hydraulic systems.



The following summarises the condition of the aircraft following the possible combinations of double hydraulic failure:

- With a HYD B + Y failure, the stabiliser and most of the spoilers are lost. There will be no NWS, as the landing gear will have been extended using the gravity system (to protect the green system integrity for the flight controls). Due to the loss of the stabiliser and the partial loss of spoilers, VLS is increased by 10 kt. However, the elevators still operate normally and autotrim is still available through the elevator. Normal braking is available on the ground.
- With a HYD G + B failure, the slats, most spoilers, the left elevator, the inner ailerons, normal and alternate braking, anti-skid and (A333/A343: NWS) are all lost. Braking is only available using the blue system accumulator. If this failure occurs before any slat has been selected, a long runway will be required. After stopping, the parking brake may be inoperative due to low blue system accumulator pressure.
- With a HYD G + Y failure, the flaps, most spoilers, the right elevator, outer ailerons, normal braking and NWS are lost. Again, if this failure occurs before any flap has been selected, a long runway will be needed. Braking is available using the alternate braking system with anti-skid.

The PNF should note the calculated VAPP speed and landing distance. The table in the QRH gives increments for different slat/flap configurations and it is essential the correct figures are used.

The approach briefing should concentrate on safety issues, with emphasis on the following:

- When the gear will be selected down, noting that it will be a gravity extension, regardless of the failure. Gear retraction will not be possible.
- Approach configuration and Flap Lever position.
- Use of selected speeds on the FCU.
- Landing, braking and steering considerations.
- Go-around calls, configuration and speeds.

Although the ECAM procedure guides the crew through the steps, the workload is high. Attention must be given to the selected speeds on the FCU. The landing is manually flown to Cat 1 limits only.



## **LANDING WITH NON-NORMAL GEAR**

This situation might occur following completion of a L/G GEAR NOT DOWNLOCKED procedure. It is always better to land with any available gear rather than carry out a landing without any gear. The exception to this is the A343, when it is prohibited to extend the centre gear with one MLG not fully extended as it was not designed to support the aircraft weight in the case of main landing gear abnormal configuration. In all cases, reduce weight as much as possible to provide the slowest possible touchdown speed. Although foaming of the runway is not a requirement, take full advantage of any ATC offer to do so.

Inform the passengers and cabin crew of the situation in good time. This allows the cabin crew to prepare the cabin and perform their emergency landing and evacuation preparation.

In order to retain as much roll authority as possible, do not arm the ground spoilers since ground spoiler extension would prevent the spoilers from acting as roll surfaces. Use manual braking as it enables better pitch and roll control. Autobrake is not armed, and is inhibited if any main landing gear is not fully extended. The reference speed used by the antiskid system is not correctly initialised if one main landing gear is not fully extended. Consequently, switch off the antiskid system to prevent permanent brake release. Since engine contact with the ground is likely during the rollout, and in order to prevent ground spoiler extension, do not use reverse thrust.

In all cases, fly a normal approach and use the control surfaces as required to maintain wings level and a normal pitch attitude for as long as possible after touchdown. Try to prevent nacelle contact on first touchdown. Shut down the engines early enough to ensure that fuel is cut off prior to nacelle touchdown, but late enough to ensure that hydraulic power remains available for the flight controls. Under normal load, hydraulic power remains available for approximately 30 seconds after shutdown of the related engine.

Carry out the passenger evacuation checklist if required.

INTENTIONALLY  
BLANK



## **FMGC FAILURE**

Should a single FMGC failure occur, the AP/FD on the affected side will disconnect. It is possible to restore the AP/FD using the other FMGC. The A/THR remains engaged. Furthermore, flight plan information on the ND and MCDU can be recovered by using the FM switching to establish FMGC SINGLE MODE operation. Consider a FMGC reset as detailed in the QRH.

Should a double FMGC failure occur, depending on the specific failure, flight management, flight guidance and flight envelope computers may be lost. The AP/FD and A/THR will disconnect. It is possible to restore AP/FD and A/THR provided a flight guidance computer is available.

Without AP/FD and A/THR, deselect the FD pbs. Select TRK/FPA to allow the FPV and blue track index to be displayed. Move the thrust levers to recover manual thrust, select NAV B/UP on the MCDU MENU page to establish backup navigation and use the RMPs to tune the navigation aids. Refer to the QRH for computer reset considerations. If a reset is successful, procedures are available to reload both FMGCs. FCOM 4.06.20 refers.

Following a double FMGC failure, consider the RNP requirements.

## **IRS/ADR FAILURES**

Each ADIRS has two parts, ADR and IRS, that may fail independently of each other. Additionally the IRS part may fail totally or may be available in ATT mode. Single ADR or IRS failures are simple procedures and only require action on the switching panel as indicated by the ECAM.

Dual IRS or ADR failures cause the loss of A/P and A/THR. and flight controls revert to ALTN law. Triple IRS or ADR failure is very unlikely and is not displayed on the ECAM. Should a triple failure occur, two double failures would be displayed, i.e. ADR 1 + 2 FAULT and ADR 2 + 3 FAULT. The subsequent ECAM actions would give conflicting instructions. In this case, apply the QRH procedure for ADR 1 + 2 + 3 failure. This is one of the few cases where the crew will not follow the ECAM procedure.

There is no procedure for IRS 1 + 2 + 3 failure but the ECAM status page gives approach procedure and inoperative systems. The standby instruments are the only attitude, altitude, speed and heading references available.



## DUAL RADIO ALTIMETER FAILURE

The radio altimeters (RAs) provide inputs to a number of systems, including the GPWS and FWC for auto-callouts. They also supply information to the AP and A/THR modes, plus inputs to switch control laws at various stages. Although the ECAM procedure for a RA 1 + 2 FAULT is straightforward, the consequences of the failure on the aircraft operation require consideration.

Instead of using RA information, the flight control system uses inputs from the LGCIU to determine mode switching. Consequently, mode switching is as follows:

- At take-off, normal law becomes active when the MLG is no longer compressed and pitch attitude becomes greater than 8°
- On approach, the flare law becomes active in manual flight when the L/G is extended. If the AP is engaged when the L/G is extended, flare law becomes active at AP disconnect. As and when flare law activates, manual pitch trim is required and "USE MAN PITCH TRIM" is displayed on the PFD.
- After landing, ground law becomes active when the MLG is compressed and the pitch attitude becomes less than 2.5°

It is not possible to capture the ILS using the APPR pb and the approach must be flown to CAT 1 limits only. However, it is possible to capture the localiser using the LOC pb. Since the autopilot gains are no longer updated by signals from the radio altimeter, the AP/FD behaviour may be unreliable near the ground. Consequently, the final stages of the approach should be flown using raw data in order to avoid excessive roll rates with LOC still engaged. There are no auto-callouts on approach and no "RETARD" call in the flare.

The GPWS/EGPWS will be inoperative. Therefore increased terrain awareness is necessary. Similarly, the "SPEED, SPEED, SPEED" low energy warning is also inoperative, again requiring increased awareness.



## ALL ENGINE FLAMEOUT

Following an All Engine Flameout, the flight deck indications change significantly as the generators drop off-line. The RAT is deployed, the EMER ELEC CONFIG warning is inhibited and the ECAM prioritises the checklists. Control of the aircraft must be taken immediately by the left seat pilot and a safe flight path established. Significant aircraft systems available include:

	EMER GEN Powered by the RAT
<b>FLY</b>	PFD 1, ALTN LAW, Upper ECAM, ECP, ISIS/STBY INST
<b>NAV</b>	FCU, STBY NAV (via RMP 1), DDRMI (VOR 1 or ADF 1)
<b>COMM</b>	VHF 1, RMP 1, ACP 1 & 2, Loudspeakers 1 & 2

The AP, pitch trim and rudder trim are not available. If engine windmilling is sufficient, additional hydraulic power may be recovered from the EDP supplying the emergency generator, which improves the electrical configuration.

Depending on the exact situation, assistance may be available from ATC regarding information such as presence of other aircraft and safe headings. In this case and when convenient, make contact using VHF 1.

ECAM does not distinguish whether fuel is available or not, and therefore provides a procedure which covers all cases. Furthermore, the ECAM procedure refers to the QRH for OPERATING SPEEDS and L/G GRAVITY EXTENSION. Consequently, apply either the ALL ENG FLAME OUT FUEL REMAINING or ALL ENG FLAME OUT NO FUEL REMAINING paper procedure in the QRH which are optimised for each case and include any required ancillary paper procedures e.g. L/G GRAVITY EXTENSION. On completion of the QRH procedure and if time permits, clear the ECAM warning and read the ECAM STATUS page.

Commence the procedure with attention to the optimum relight speed without starter assist which is initially (A333/A343: 300 kt/.82M) (A346: 270 kt). If there is no relight within 30 seconds, the QRH/ECAM orders engine master off for 30 seconds and then on again. This is to permit ventilation of the combustion chamber. Without starter assist, all engine master switches may be selected on at the same time.

Start the APU below FL 250. Below FL 200, attempt an engine relight using APU bleed for starter assist. When using APU bleed for starter assist, only one engine must be started at a time. The optimum speed for starter assist is green dot, which is not displayed on the PFD. Consequently, use the optimum speed with APU bleed available from the checklist until the QRH Part 4 can be consulted to accurately determine green dot speed.





## **TAIL PIPE FIRE**

An engine tail pipe fire typically occurs at engine start and results from excess fuel in the combustion chamber or an oil leak in the low-pressure turbine race. A tail pipe fire is an internal fire contained within the engine where no sensitive areas are affected.

Should a tail pipe fire be reported, apply the checklist procedure, which requires the engine to be shut down and ventilated.

The FIRE pb must not be pushed as this would de-energise the FADECs and prevent the motoring sequence. The AGENT pbs must not be pushed as they provide no benefit with extinguishing an internal fire. The priority must be given to engine ventilation.

If a tail pipe fire is reported with no bleed air readily available, a ground fire extinguisher should be used as last resort.

FCOM 3.02 70 refers



## OVERWEIGHT LANDING

Should an overweight landing be required, a long straight in approach, or a wide visual pattern, should be flown in order to configure the aircraft for a stabilised approach. Plan to be at VAPP by the final approach fix.

There are no adverse handling characteristics associated with overweight landings. Landing distance with CONF 3 or FULL at all gross weights is normally less than take-off distance. However, verify runway field length requirements from the landing distance charts in the QRH or FCOM 2. Tyre deflation may occur if brake temperatures exceed 800°C.

Automatic landing has been demonstrated up to the weights specified in FCOM 3.01.32. CONF FULL is the preferred landing configuration provided that the approach climb gradient criteria can be achieved using CONF 3 for the go-around. At high weights and temperatures, a CONF 3 approach is required to satisfy go-around criteria (QRH Maximum Weight For Go-Around in CONF 3 table refers). In all cases, if the landing configuration is different from CONF FULL, select Flaps 1 (CONF 1+F) at initiation of the go-around. The approach climb gradient criteria is never limiting in CONF 1+F. To ensure that maximum thrust is available in the event of a go-around, select the packs off, or use the APU as the bleed source.

If a go-around is performed using CONF 1+F, VLS CONF 1+F may be higher than VLS CONF 3 + 5 kt (VAPP). In this case, follow the SRS order, which will accelerate the aircraft up to the displayed VLS. VLS CONF 1+F equates to 1.23 VS1g whereas the minimum speed for go-around required by regulation is 1.13VS1g. Consequently, this requirement is always satisfied.

A normal approach is flown except that in the final stages of the approach, the target speed is VLS and the max V/S at touchdown is 360 ft/min. At main gear touchdown, select max reverse and after nosewheel touchdown, apply brakes if autobrake is not active.

Use the longest available runway and consider wind and slope effects. Where possible avoid landing in tailwinds, on runways with negative slope, or on runways with less than normal braking conditions. Do not carry excess airspeed on final approach. This is especially important when landing during an engine inoperative or other non-normal condition.

At high weight, the manoeuvring speed for the current configuration may be close to, or even above the VFE for the next configuration. In this case, the procedure is to select the speed to VFE next – 5 kt (but not below VLS) and then select the next configuration as the speed decreases through VFE next. As the slats/flaps extend, VLS reduces. Flap load RELIEF may annunciate momentarily as the speed reduces. Repeat if required, until the landing configuration is achieved. Once completed, select managed speed. The flare and derotation technique as described in FCTM Ch 7 applies.



Taking into account the runway landing distance available, modulate the use of brakes to avoid very hot brakes and the risk of tyre deflation. In general for A333/A343, brake energy and tyre speed considerations are not limiting even in an overweight condition.

## **EMERGENCY DESCENT**

Initiate the emergency descent only upon positive confirmation that cabin altitude and rate of climb is excessive and uncontrollable. Carry out this procedure from memory. The use of AP and A/THR is strongly recommended for an emergency descent. The FCU selections for an emergency descent progress from right to left, starting with ALT, HDG and then SPD.

At high flight levels, extend the speed brake slowly while monitoring VLS to avoid the activation of angle of attack protection. This would cause the speedbrakes to retract and may also result in AP disconnection. If structural damage is suspected, caution must be used when using speedbrakes to avoid further airframe stress. When the aircraft is established in the descent, the PF requests the ECAM actions.

When at idle thrust, at high speed and with speedbrake extended, the rate of descent is approximately 6000 ft/min. It takes approximately 5 minutes and 40 nm to descend from FL400 down to FL100. The MORA value displayed on the ND is the highest MORA value within a circle of 40 nm radius around the aircraft.

The passenger oxygen MASK MAN ON pb should be pressed only when it is clear that cabin altitude will exceed 14000 ft.

## **UNRELIABLE AIRSPEED INDICATIONS**

Unreliable airspeed indications can result from blocked or frozen lines in the pitot/static system.

Most failure modes of the airspeed/altitude system are detected by the ADIRS and lead to the loss of the corresponding cockpit indication(s) and the triggering of associated ECAM procedures. The fault sensing logic relies on a voting principle whereby if one source diverges from the average value, it is automatically rejected and the system continues to operate normally with the remaining two sources. This principle applies to flight controls and flight guidance systems.

However, there may be some cases where the airspeed or altitude output is erroneous without being recognised as such by the ADIRS. In these cases, the cockpit indications appear normal but are actually false and pilots must rely on their basic flying skills to identify the faulty source and take the required corrective action. When only one source provides erroneous data, a simple crosscheck of the parameters generated by the three ADRs allows the faulty ADR to be identified. This identification becomes more difficult in extreme situations when two or all three ADR sources provide erroneous information.



Normally, each PRIM receives speed information from each ADIRU and compares the three values. Pressure altitude information is not used by the PRIM. Each FE computer receives both speed and pressure information from each ADIRU and compares the three values.

In a failure situation, various combinations of ADR faults may occur, each interpreted differently by the PRIM and FE computers:

- **One ADR output is erroneous and the two remaining ADRs are correct.** The PRIMs and the FEs reject the faulty ADR. On basic A333/A343 aircraft, there is no ECAM alert, however one PFD will display some incorrect parameters. On the A346 and enhanced A333 aircraft, if one ADR output is erroneous, and if this ADR is used to display the speed information on either PFD, a NAV IAS DISCREPANCY caution is triggered. In all cases, CAT3 DUAL will be displayed as an INOP SYS on the STATUS page.
- **Two ADR outputs are erroneous but different and the remaining ADR is correct, or if all three ADR outputs are erroneous but different.** The AP and A/THR will disconnect. If the disagreement lasts for more than 10 seconds, the PRIM triggers the NAV ADR DISAGREE ECAM caution. Flight controls revert to ALTN 2 law. The SPD LIM flag is displayed on both PFDs, however VLS and VSW are not displayed. This condition is latched until a PRIM reset is performed on ground without any hydraulic pressure. However, if the disagreement was transient, the AP and A/THR can be re-engaged when the NAV ADR DISAGREE message has disappeared.
- **One ADR is correct but the other two ADRs provide the same erroneous output, or if all three ADRs provide consistent and erroneous data.** The PRIMs and FEs will reject the “good” outlier ADR and will continue to operate normally using the two consistent but faulty ADRs.

Any erroneous speed/altitude indication will always be associated with one or more of the following cues:

- Fluctuations in airspeed indications
- Abnormal correlation of basic flight parameters (IAS, pitch, attitude, thrust, climb rate); e.g IAS increasing with large nose-up pitch attitude, IAS decreasing with large nose down pitch attitude, IAS decreasing, with nose down pitch attitude and aircraft descending
- Abnormal AP/FD/A/THR behavior
- Stall or overspeed warnings
- Reduction in aerodynamic noise, with increasing IAS
- Increase in aerodynamic noise, with decreasing IAS



The ADRs provide a number of outputs to many systems and a blockage of the pitot and/or static systems may also lead to the following:

- SPD LIM flag on PFD
- Alpha floor activation (because AOA outputs from the sensors are corrected by speed inputs)
- Wind shear warning (due to Mach input)
- Flap load-relief activation
- Flap auto-retraction from 1+F to 1
- Alpha lock on slats retraction (due to the speed logic part of the alpha lock function)
- ALTI DISCREPANCY on ECAM
- RUD TRV LIM FAULT ON on ECAM

Always apply the ECAM procedure. If the failure is not annunciated on ECAM, crosscheck all IAS/ALTITUDE sources (ADR 1, 2, & 3, and ISIS/STBY INST).

Early recognition of erroneous airspeed indications requires some familiarity with the relationship between attitude, thrust setting and airspeed. If it is positively confirmed that the outlier ADR is at fault and that the other two ADRs are correct, select the faulty ADR OFF. This action will generate an ECAM procedure, which should be applied in order to reconfigure the PFD to display correct information.

However, in very extreme circumstances, two or all three ADRs may provide identical but erroneous data. If there is any doubt, then do not instinctively reject the outlier ADR, although the temptation may exist if the other two ADR outputs are consistent. In most cases, this decision would be correct, but not in the case where two speed/altitude indications are consistent but wrong. Apply the initial actions of the UNRELIABLE SPEED INDICATION QRH procedure from memory as they quickly provide a safe flight condition in all phases of flight and aircraft configuration. Rely on the primary flight parameters of pitch attitude and thrust setting.

Because the displayed information may be erroneous, the flying accuracy cannot be assumed. Incorrect transponder altitude reporting could cause confusion. Therefore, declare a MAYDAY to advise ATC and other aircraft of the situation. Reference to the QRH should only be made when a safe flight path has been established. The QRH provides pitch attitude and thrust settings for each flight phase and for different weights.

After applying the QRH procedure, and when the aircraft flight path is stabilised, attempt to identify the faulty ADR(s). Once the faulty ADR(s) has/have been positively identified, it/they should be switched OFF. This will trigger the corresponding ECAM procedure, which should be applied.



Depending of the cause of the failure, the altitude indication may also be unreliable. However, there are a number of correct indications available to the crew:

<b>Unreliable Parameter</b>	<b>Disregard</b>	<b>Use</b>
Altitude	Altimeter IAS/TAS Wind V/S FPA	GPS altitude (on GPS monitor page)  RA (low level)
Speed	IAS/TAS Wind	GPS GS (on GPS monitor page)

When flying the aircraft with unreliable speed and/or altitude indications, it is recommended to change only one flying parameter at a time; e.g. speed, altitude or configuration. Consequently, plan to be at VAPP by the final approach fix.

INTENTIONALLY  
BLANK



## **TABLE OF CONTENTS**

### **COMMS & NAV**

#### **General**

Preface.....	9.10.1
--------------	--------

#### **RMP And ACP**

Radio Management Panel (RMP) .....	9.20.1
------------------------------------	--------

Audio Control Panel (ACP).....	9.20.1
--------------------------------	--------

#### **ACARS**

AIRINC Communication Addressing And Reporting System (ACARS) .....	9.30.1
--	--------

#### **SATCOM**

Satellite Communication (SATCOM).....	9.40.1
---------------------------------------	--------

Air To Ground Communication .....	9.40.1
-----------------------------------	--------

Ground To Air Communication .....	9.40.2
-----------------------------------	--------

Hold Function .....	9.40.2
---------------------	--------

Call Termination .....	9.40.3
------------------------	--------

#### **ATSU And CPDLC**

Air Traffic Service Unit (ATSU).....	9.50.1
--------------------------------------	--------

Controller/Pilot Datalink Communication (CPDLC).....	9.50.6
--	--------

#### **WGS 84**

World Geodetic Survey 1984 (WGS 84) .....	9.60.1
---	--------

#### **Honeywell ID Conventions**

Un-named Oceanic Control Area Reporting Points.....	9.70.1
---	--------

Un-named Terminal Area Fixes .....	9.70.2
------------------------------------	--------

Fixes With One Word Names.....	9.70.2
--------------------------------	--------

Fixes With Multi-word Names.....	9.70.3
----------------------------------	--------





## **TCAS**

Traffic Alert And Collision Avoidance System (TCAS) .....9.80.1

## **RNP**

RNP .....9.90.1

RNP Capability .....9.90.1

Radial Equivalence.....9.90.2



## **PREFACE**

This chapter discusses various communication systems, including SATCOM and CPDLC, the monitoring of navigation accuracy, RNP criteria, the Honeywell Naming Convention and TCAS displays. Some techniques related to equipment handling are described in detail, whereas other information is intended to provide a background working knowledge of the operation and philosophy of various systems.

INTENTIONALLY  
BLANK



## **RADIO MANAGEMENT PANEL (RMP)**

The RMP is used to tune all VHF and HF radios as well as allowing manual tuning of ILS, VOR and ADF frequencies. There is a detailed description of the RMP and its functions in FCOM 1.23. The outside RMP should normally be used to tune any one of the VHF or HF desired radios.

If tuning the radio results in the illumination of the SEL lights, the outside VHF should be reselected. This will extinguish the SEL lights. The SEL light should not remain illuminated for longer than is necessary to select the new frequency or to set up the next expected frequency in the standby window.

The SEL light will come on both RMPs if:

- VHF1 is selected on RMP2 or 3
- VHF2 is selected on RMP1 or 3
- VHF3, HF1, HF2 is selected on RMP1 or 2

## **AUDIO CONTROL PANEL (ACP)**

The ACP allows the control of the transmission and reception of all communication equipment as well as allowing aural identification of navigation aids. FCOM 1.23.20 refers. On some aircraft, the ACP allows transmission and reception of SATCOM calls.

The normal settings for ACP 1 and 2 are:

- VHF1/VHF 2/INT reception knobs "up" and set to 12 o' clock position
- MKR reception knob "up" and set to 9 o' clock position
- INT/RAD switch in the central position. When using headsets, select the INT/RAD switch to INT
- VOICE to "OFF"

Do not use VHF3 for voice communications if ACARS is installed unless VHF1 and VHF2 are inoperative.

INTENTIONALLY  
BLANK



---

## **AIRINC COMMUNICATION ADDRESSING AND REPORTING SYSTEM (ACARS)**

ACARS enables communication between the aircraft and ground stations without the direct involvement of the crew. The system is used in the delivery of operational information, e.g. Loadsheets and RTOW data. It also provides a timely and accurate means of disseminating information on the flight status. Consequently, the ACARS should be initialised before each sector. FCOM 1.23.40 refers.

INTENTIONALLY  
BLANK



## SATELLITE COMMUNICATION (SATCOM)

This section details how to use the different cockpit SATCOM functions for air to ground or ground to air communication. The examples below illustrate typical scenarios. However, the menus shown do not necessarily reflect those found in CX system specification. FCOM 1.23.45 refers.

### AIR TO GROUND COMMUNICATION

The crew selects the phone number via the MCDU, then initiates and terminates the call via the ACP.

#### Phone Number Selection

- PRESS the SAT key on the MCDU main page.  
*To access the SATCOM MAIN MENU page.*
- PRESS the DIRECTORY key.  
*For air to ground communication, the Directory contains a list of pre-recorded phone numbers.*

#### Pre-recorded (Pre-stored) Phone Number

On the SATCOM DIRECTORY page:

- PRESS 1L, 2L, 3L or 4L  
*The MCDU switches to the CATEGORY NUMBER page, where phone numbers have been stored according to their priority, (e.g. SATCOM SAFETY):*

GFC5-03-0423-004-A.110AA

SATCOM SAFETY 1/3		SAT 1/2	
1L	*IOR CONTROL		1
	00495218796214		
2L	*CDG ARPT		
	[0098564721336985]		
3L	*HGK ARPT		
	004632189752123		
4L	*ORD ARPT	SORT*	
	4533356722268		
5L	*ORY ARPT	FIND*	
	[004433566213]	[ ]	
6L	<RETURN		

- PRESS 1R to modify the SATCOM channel.  
*After having entered the desired SATCOM channel in the scratchpad.*
- PRESS the key (1L, 2L, 3L, 4L or 5L) facing the required phone number.  
*The MCDU then switches automatically to the SATCOM MAIN MENU page where the title (of the selected phone number) is displayed. READY TO CONNECT is displayed in front of the selected SATCOM channel.*





## Call Initiation

Once all information regarding the phone number is entered in the MCDU, the crew uses the ACP to initiate the SATCOM call. On the SATCOM MAIN MENU page:

- CHECK 2L or 4L field displays the phone number.
- CHECK the availability of the relevant SATCOM channel.  
*The SATCOM channel, used to initiate the call, is displayed above the phone number.*
- PRESS the SAT 1(2) transmission key.  
*On the ACP, PRESS the SAT transmission key corresponding to the selected SATCOM channel. The green lines on the SAT 1(2) transmission key flash. On the SATCOM MAIN MENU page, the DIALING indication replaces the READY TO CONNECT indication in front of SAT 1(2). When the call is established, the green lines on the SAT 1(2) transmission key become steady on the ACP. On the SATCOM MAIN MENU page, CONNECTED indication replaces the DIALING indication in front of SAT 1(2).*

PROCEED as for a VHF or HF call. However, with SATCOM, the transmit button may be held down throughout the call, with no affect on reception.

## GROUND TO AIR COMMUNICATION

In case of an incoming call, the amber lines on the ACPs SAT 1(2) transmission key flash and the SATCOM ALERT green memo is triggered on the ECAM, when the priority level is below 4.

- PRESS the SAT 1(2) transmission key to establish the communication  
*On the ACP, the green lines on the SAT 1(2) transmission key become steady. On the SATCOM MAIN MENU page, the CONNECTED indication replaces the DIALING indication in front of SAT 1(2).*

## HOLD FUNCTION

If the crew selects a radio for communication (HF or VHF) when a SATCOM call is established, the SATCOM audio transmission is temporarily interrupted.

On the ACP:

The green lines on the SAT 1(2) transmission key flash. The green lines on the selected radio (HF or VHF) transmission key come on. To recover the SATCOM call reselect the same radio (HF or VHF) or the SAT 1(2) transmission key. This terminates the radio call.



## CALL TERMINATION

For an air to ground call:

- PRESS the corresponding SAT 1(2) transmission key on the ACP.  
*The green lines on the selected SAT 1(2) transmission key go out.  
After 3 seconds, the call is terminated.  
If the SATCOM call is on HOLD, the crew must cancel the HOLD before terminating the call.*

For a ground to air call:

The ground initiates the call termination.

The green lines of the corresponding SAT1 (2) transmission key go out.

Do not select the PA immediately after a SATCOM call. This may result in the PA being permanently selected. First select another system on the ACP, e.g. VHF, and then the PA.

INTENTIONALLY  
BLANK



## AIR TRAFFIC SERVICE UNIT (ATSU)

### Initialization

Successful datalink communications requires that all information is correctly entered in accordance with the ICAO flight plan during ATSU initialisation. ATSU is automatically initialised provided a list of service providers has been scanned and provided the following parameters have been received and validated by the ATSU:

- Aircraft Registration Number (ARN)
- Airline two letter Identification Code (A/L ID for datalink service providers)
- Airline three letter Identification Code (A/L ID for ATC)

If one of the above conditions is not fulfilled, the ATSU or datalink is not available and the following occurs:

- The ECAM displays an ATSU FAULT warning, with the ATSU INIT FAULT line procedure
- The MCDU scratchpad displays a message to request crew action

A manual entry of the missing parameter re-initialises the ATSU and clears the ECAM and MCDU message.

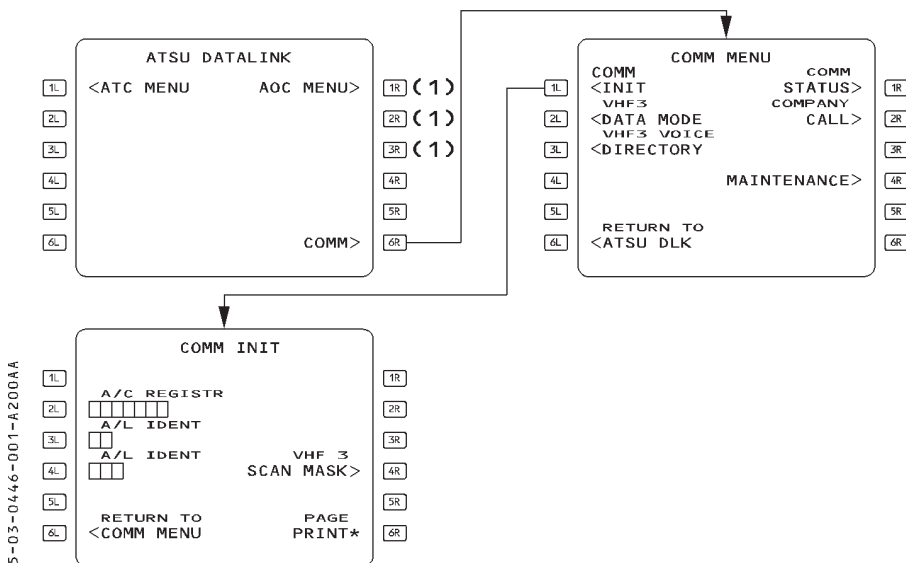

GFC5-03-0446-001-A200AA

(1) THESE FIELDS ARE CUSTOMIZED ACCORDING TO THE AOC PROGRAMMING



If the ARN is not valid, the MCDU scratchpad displays the "ENTER A/C REGISTER" message. After having cleared the scratchpad, the crew inserts the ARN in the scratchpad. Pressing the 2L key on the COMM INIT page enters the ARN in the 2L field.

If the A/L ID is not valid, the MCDU scratchpad displays the "ENTER A/L IDENT" message. After having cleared the scratchpad, the crew writes the two-letter A/L ID code in the scratchpad. Pressing the 3L key enters the A/L ID code in the 3L field. The crew should repeat the same operation for the three-letter A/L ID code using the 4L key, instead of the 3L key.

If no VHF Service Providers have been selected, the MCDU scratchpad displays the "ENTER VHF3 SCAN MASK" message. On the VHF3 SCAN MASK page, select a service providers list, in the airline priority order, and activate the VHF SCAN MASK function. An example of the process for the selection of the service providers SITA 725 and ARINC is as follows:

- Press the 5L key. The star next to the ERASE indication disappears then reappears.
- Press the 1L key to select SITA 725. The SELECT indication goes off and the priority number of selection E1 comes into view.
- Press the 1R key to select ARINC. The SELECT indication goes off and the priority number of selection E2 comes into view.
- Press the 5R key to activate the VHF SCAN MASK function. The star next to the SCAN MASK LOAD indication disappears and then reappears.

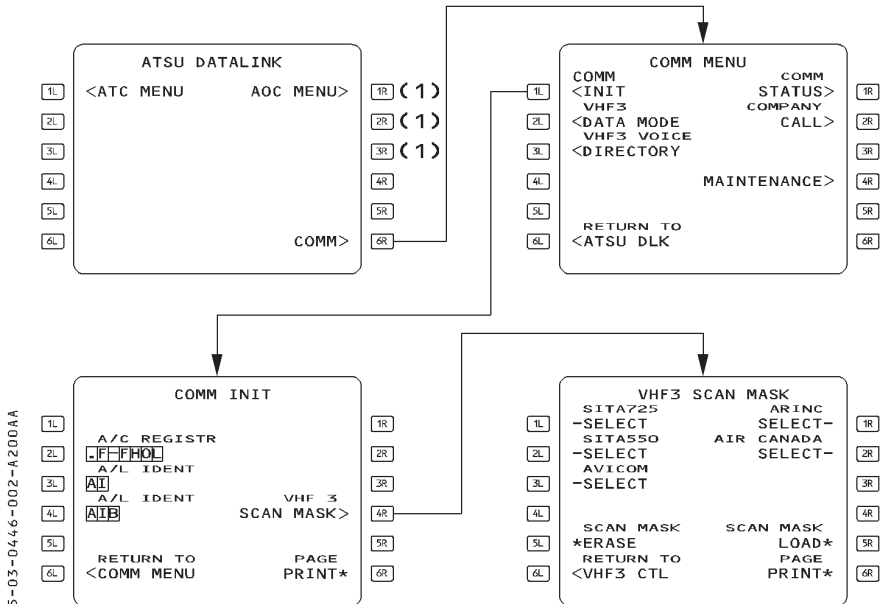

GFC5-03-0446-002-A.200AA

(1) THESE FIELDS ARE CUSTOMIZED ACCORDING TO THE AOC PROGRAMMING

## Notification

Notification is made through the NOTIFICATION page as follows:

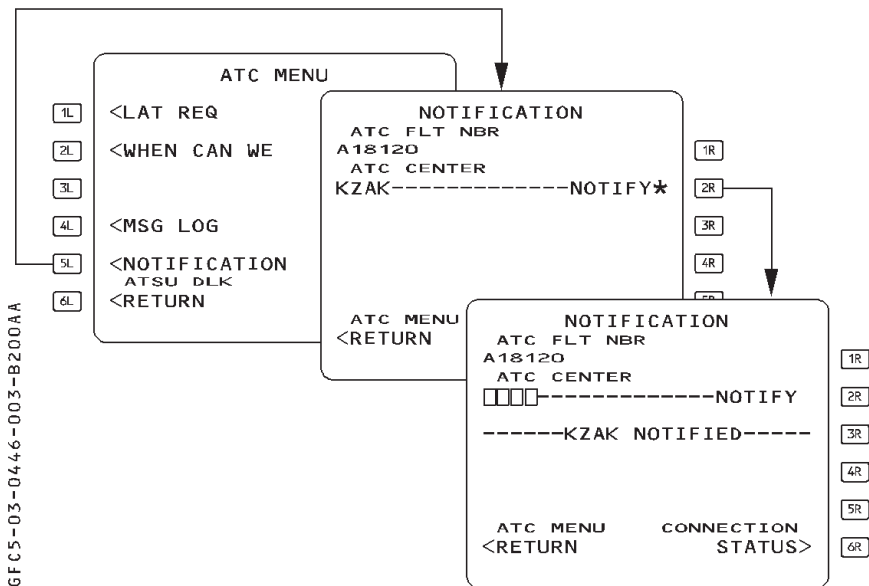

The FMGC provides the ATC FLT number. The notification procedure is used by the ATC to correlate the aircraft with the ICAO flight number. Consequently, it is essential to enter exactly the same number, shown on the ICAO flight plan (with the same number of letters), on the INIT page.

The ATC CENTRE field defaults to the centre that was connected during the previous flight. It can be changed, if applicable.

Once the ATC centre has been notified, "NOTIFIED" is displayed on the NOTIFICATION page. The ATC centre will then initiate the CPDLC and/or Automatic Dependent Surveillance (ADS) connection. Therefore, re-notifications should be avoided.

For ADS operations, check on the CONNECTION STATUS page that the ADS is set to ON prior to performing a notification.



## Connection

Before connection, the DCDU screen appears as below:

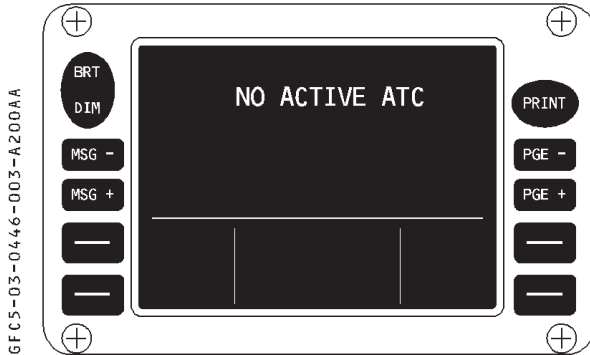

Once notified, the connection is made at the ATC's discretion. When the connection is established in a CPDLC or CPDLC/ADS environment, the active centre is displayed on the DCDU and the pilot should verify that the appropriate centre is connected.

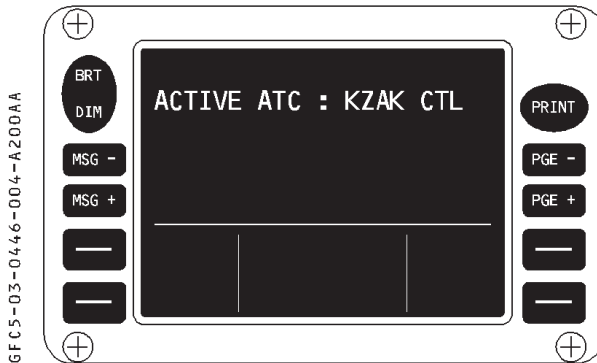

For operations in an ADS only environment (i.e. no CPDLC), "NO ACTIVE ATC" remains displayed on the DCDU and does not reflect the ADS contract status. This is due to the fact that the DCDU is the interface that sustains CPDLC communication, whereas the ADS is an additional feature which is transparent to the crew.





## **CONTROLLER/PILOT DATALINK COMMUNICATION (CPDLC)**

This section gives only a few typical examples of the messages that are exchanged between the crew and ATC. To avoid ambiguity, the following is recommended:

- Avoid sending multiple clearance requests in the same message
- Avoid duplicating messages. Consequently:
  - Answer incoming messages as soon as possible
  - Do not re-send your message if ATC does not answer immediately. If, after a reasonable period of time, you feel it is necessary to re-send a message, e.g. a clearance request, do not re-send the same request. Use a negotiation query, such as "WHEN CAN WE..."
- Close messages when they have been answered or sent to keep the screen free for additional messages
- Avoid using free text. If it is necessary to use free text because pre-formatted messages do not allow for a specific message element, use standard ATC phraseology
- Avoid non-standard abbreviations

## **Position Reports**

As for voice communications, a position report is required when passing a waypoint. This is entirely automatic when the ADS function is active. In other cases, or if manual reports are required in addition to ADS reports, the pilot must send position reports by using the DCDU. Position report messages can either be:

- Automatically generated on the DCDU by the FMGS, if the AUTO POS REPORT function has been set to on
  - Manually prepared by the pilot on the ATC REPORTS page
- For the ADS function, or the automatic generation of position reports on the DCDU by the FMGS, it is essential to ensure correct waypoint sequencing. The FMGS offset function should be used, when appropriate. When the heading mode is used, the crew should monitor the waypoint sequencing and clear them when necessary.



## FMGS Generated Position Reports

THIS REQUIRES THAT THE AUTO POS REPORT BE SET ON, ON THE ATC REPORT PAGE.

GFC5-03-0446-006-A200AA

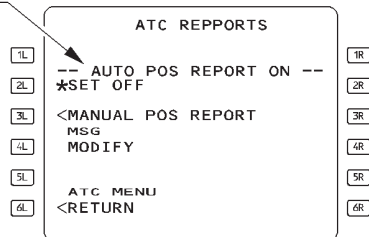

When sequencing a waypoint, the FMGS automatically generates the position report message on the DCDU:

GFC5-03-0446-006-B200AB

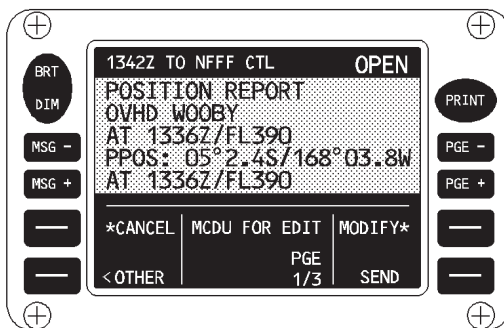

The pilot may modify it by using the MODIFY function key. Then, he sends it to the ATC. He may also use the MODIFY function key to update the parameters displayed on the DCDU before sending the position report.

Carry out the following actions on the DCDU:

- SEND.....SELECT (1)  
*The message is displayed in green letter and the OPEN status disappears.*
- CLOSE .....SELECT (2)  
*The message is removed from the screen.*

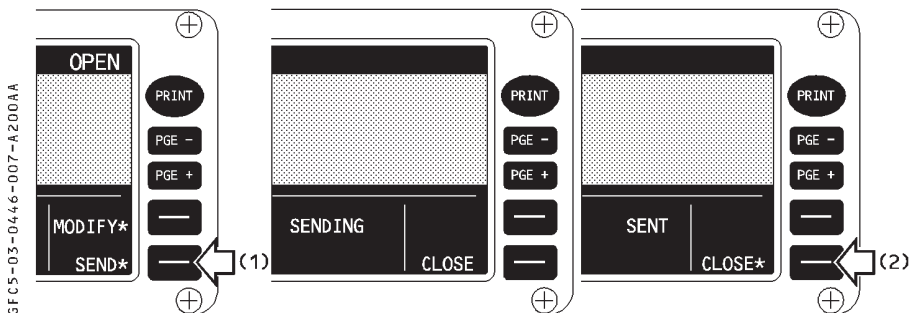

### Pilot Generated Position Reports

This has to be done when the AUTO POS REPORT on the ATC REPORTS page is set to OFF. The POSITION REPORT message must be prepared on the MCDU.

Complete the following actions on the ATC REPORTS PAGE:

- MANUAL POSITION REPORT .....SELECT (1)  
*POSITION REPORTS* pages 1/3, 2/3 and 3/3 show the data that is automatically provided by the FMGS. The crew can manually enter some fields, if desired.
- REP DISPL.....SELECT (2)  
*This message is displayed on the DCDU with a blue background. It is now ready to be sent.*

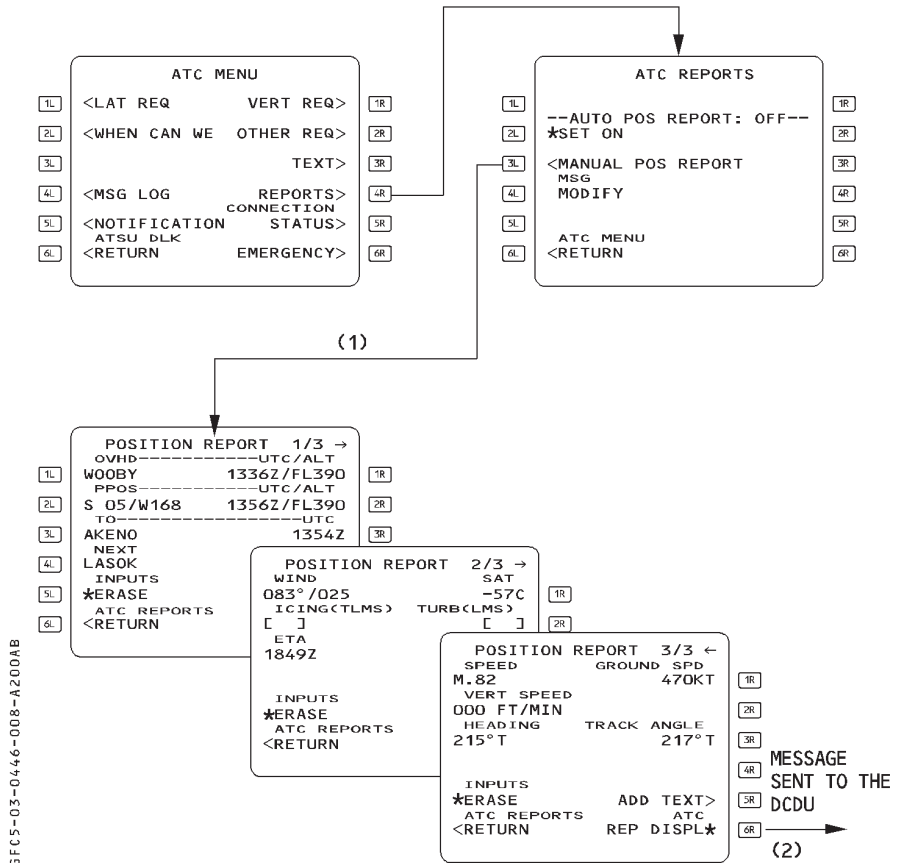

As for reports that are automatically generated by the FMGS, the pilot can modify a message displayed on the DCDU. It is then sent to the ATC by using the SEND function key and is removed from the screen by using the CLOSE function key.



## Crew Request To ATC

In this example, the crew makes a request when a lateral flight plan deviation is desired due to weather reasons. The use of the "WX DEV UP TO" prompt ensures that the ATC attributes priority to this request. The following actions should be carried out:

On the ATC MENU PAGE:

- LAT REQ .....SELECT (1)  
*The ATC LAT REQ page is displayed.*
- Fill the WX DEV UP TO field (2)
- REQ DISPL .....SELECT (3)  
*The request is displayed on the DCDU with a blue background. It is ready to be sent.*

On the DCDU:

- SEND .....SELECT (4)  
*The message is displayed on a green background.*
- CLOSE .....SELECT (5)  
*The message and its status are removed from the screen.*

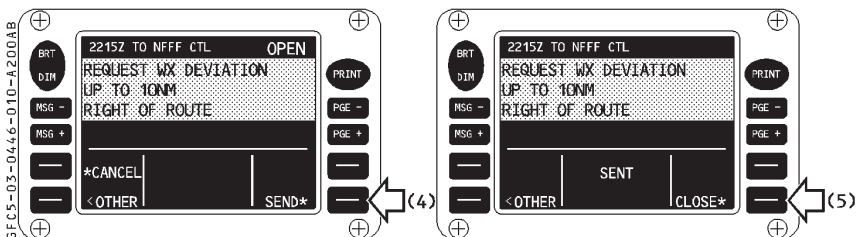
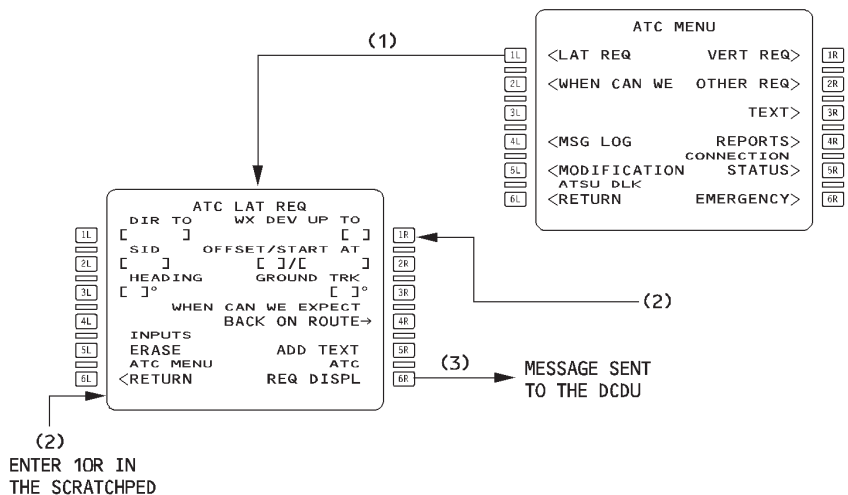

## Clearances From ATC And Pilot Responses

### Immediate Clearance

In this example, an ATC message is received in response to the previous request for weather deviation.

The ATSU triggers visual (ATC MSG light) and aural alerts and displays the message on the screen in white and blue letters. The message status is OPEN and in blue.



GFC5-03-0446-011-A200AA

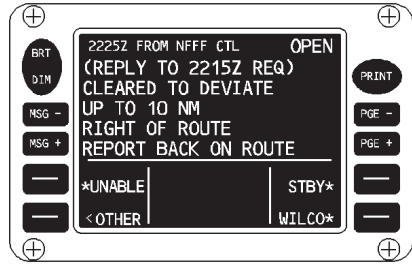
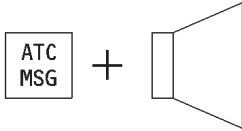

- ATC MSG .....PRESS  
*This will turn off the light and stop aural alert.*

On the DCDU:

- WILCO .....SELECT (1)  
*The message status becomes WILCO, on a blue background. (2)*
- SEND .....SELECT (3)  
*The message is displayed in green letters, and the WILCO status is on a green background. (4)*
- CLOSE .....SELECT (5)  
*The message and its status are removed from the screen.*

GFC5-03-0446-011-B200AA

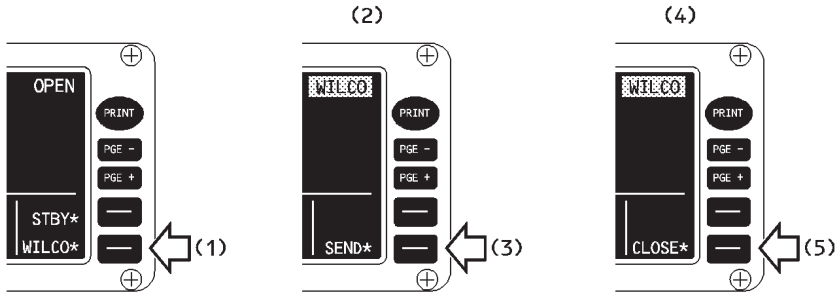

The crew has to insert the offset in the FMGS flight plan.



## Deferred Clearance

In this example, ATC have given a clearance to climb at a specific point. The ATSU triggers visual (ATC MSG light) and aural alerts and displays the message on the DCDU screen in white and blue letters. The message status is OPEN and in blue.

GFC5-03-0446-012-A.200AA

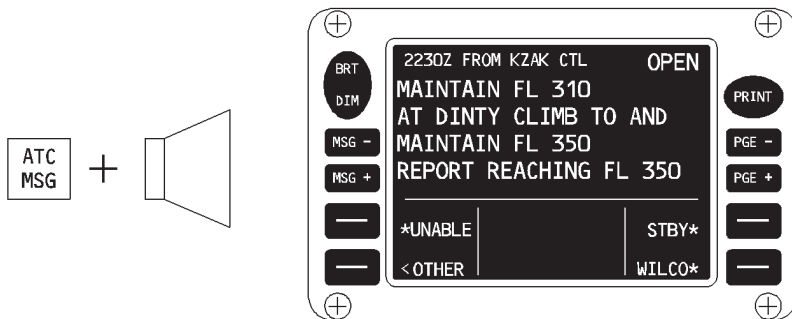

- ATC MSG .....PRESS  
*This will turn off the light and stop the aural alert.*

On the DCDU:

- WILCO .....SELECT  
*The message status becomes WILCO, on a blue background.  
On the DCDU, the waypoint to which clearance is deferred (DINTY) and FL350, turn magenta. This indicates that they will be monitored by the FMGC.*
- SEND .....SELECT  
*The message is displayed in green letters and the WILCO status is on a green background.*
- CLOSE .....SELECT  
*The message and its status are removed from the screen.*





6FC5-03-0446-012-B200A

THE "MONITORING" DISPLAY (IN WHITE) AND THE DINTY AND FL350 DISPLAY IN MAGENTA, INDICATE THAT THESE TWO PARAMETERS ARE MONITORED BY THE FMGS.



About 30 seconds before DINTY the appropriate part of the message (related to the first reached parameter) is automatically recalled by the FMGS.

6FC5-03-0446-013-A200A

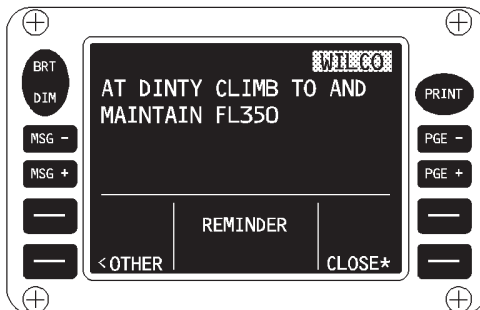
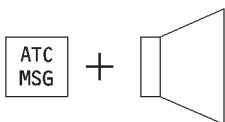

"REMINDER" information and the absence of ATC centre identification indicates that this is not a new incoming message but is only an FMGS recall. Flight plan modification has to be done by the crew.



## Navigation Parameter Request From ATC And Pilot Response

When ATC requests confirmation of a parameter, the ATSU triggers the ATC MSG light and aural alerts and displays the message on the DCDU screen in white letters. The message status is OPEN and in blue.

6FC5-03-0446-014-A200AA

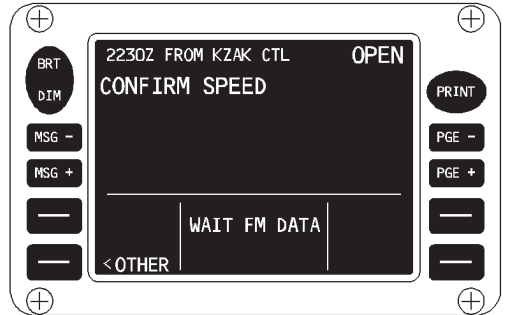
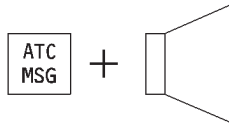

- ATC MSG .....PRESS  
*This will turn off the light and stop the aural alert.*

Automatic answer from the FMGS:

The "WAIT FM DATA" information indicates that the FMGS is preparing an answer. Then it displays it on the DCDU.

6FC5-03-0446-014-B200AA

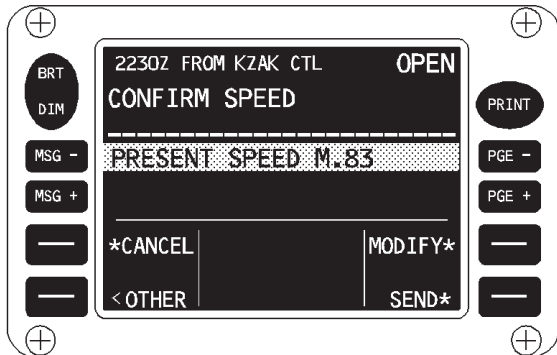



On the DCDU:

- SEND.....SELECT (1)  
*The message is displayed in green letters.*
- CLOSE .....SELECT (2)  
*The message is removed from the screen.*

## Flight Plan Modifications

Flight plan modifications, sent by the AOC, can be loaded in the FMGS secondary F-PLN. The crew can also manually prepare modifications. The crew has to obtain ATC clearance prior to activation.

When the AOC SEC F- PLN UPLINK message is displayed on the scratchpad (1):

On the SEC INDEX page:

- INSERT\* .....SELECT (2)  
*The flight plan sent by the ADC is inserted in the secondary flight plan. The crew can review it and, if necessary, modify it.*
- REQ DISPL\* .....SELECT (3)  
*The DCDU automatically prepares a message. The crew has to send it to ATC and close it.*

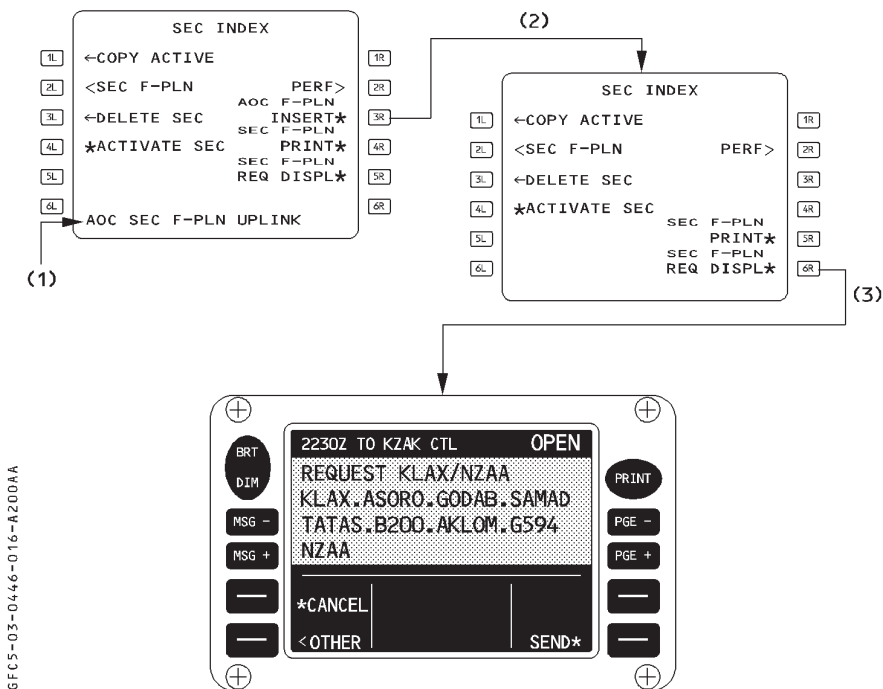

When ATC clearance is received:

- ATC MSG .....PRESS  
*This will turn off the light and stop aural alert.*

On the DCDU:

- OTHER .....SELECT (1)
- LOAD .....SELECT (2)  
*LOAD must be selected at this point. Any other selection may prevent further loading of the clearance. The "LOAD OK" information is displayed to confirm that loading is successful. The clearance can be reviewed on the SEC F-PLN pages.*



If the crew accepts the clearance:

- OTHER .....SELECT
- WILCO .....SELECT  
*This has to be sent and cleared, as for other WILCO answers.  
The crew has to activate the secondary F- PLN.*

If the crew wishes to modify the clearance:

The clearance should be loaded into SEC F-PLN, and then modified.

On the DCDU, the clearance should be rejected (UNABLE).

Another request (modified F-PLN) should be submitted to ATC.

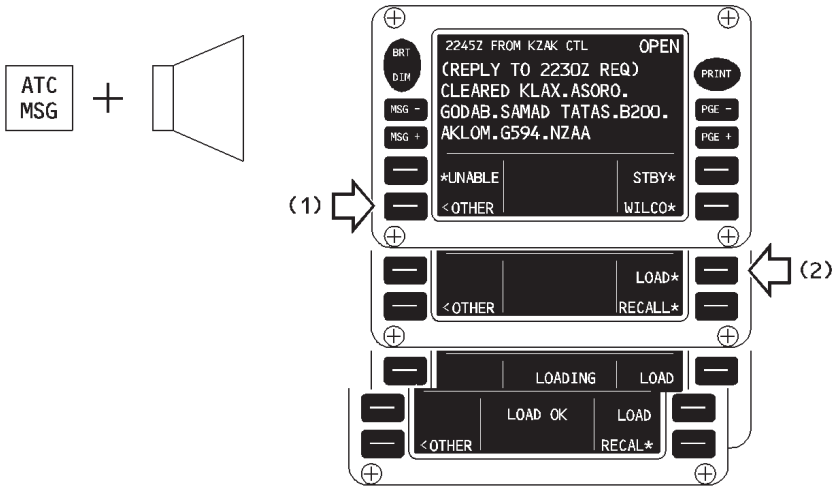



## Emergency Messages

The following describes the procedure for a PAN message.

ON the ATC MENU PAGE:

- EMERGENCY .....SELECT (1)  
*The EMERGENCY Page 1/2 is displayed.*
- PANPAN .....SELECT (2)  
*The PANPAN prompt becomes blue.*
- Fill the DIVERTING/VIA field (3).  
*The VIA field defaults to the present position, if it is not manually entered.*

### Note:

1. The emergency can be cancelled by using the CANCEL EMERGENCY prompt on the EMERGENCY page 2/2 (4).
- EMERG DISPL .....SELECT (5)  
*The message is displayed on the DCDU. The crew has to send it, then close it, as is done with any downlink message.*

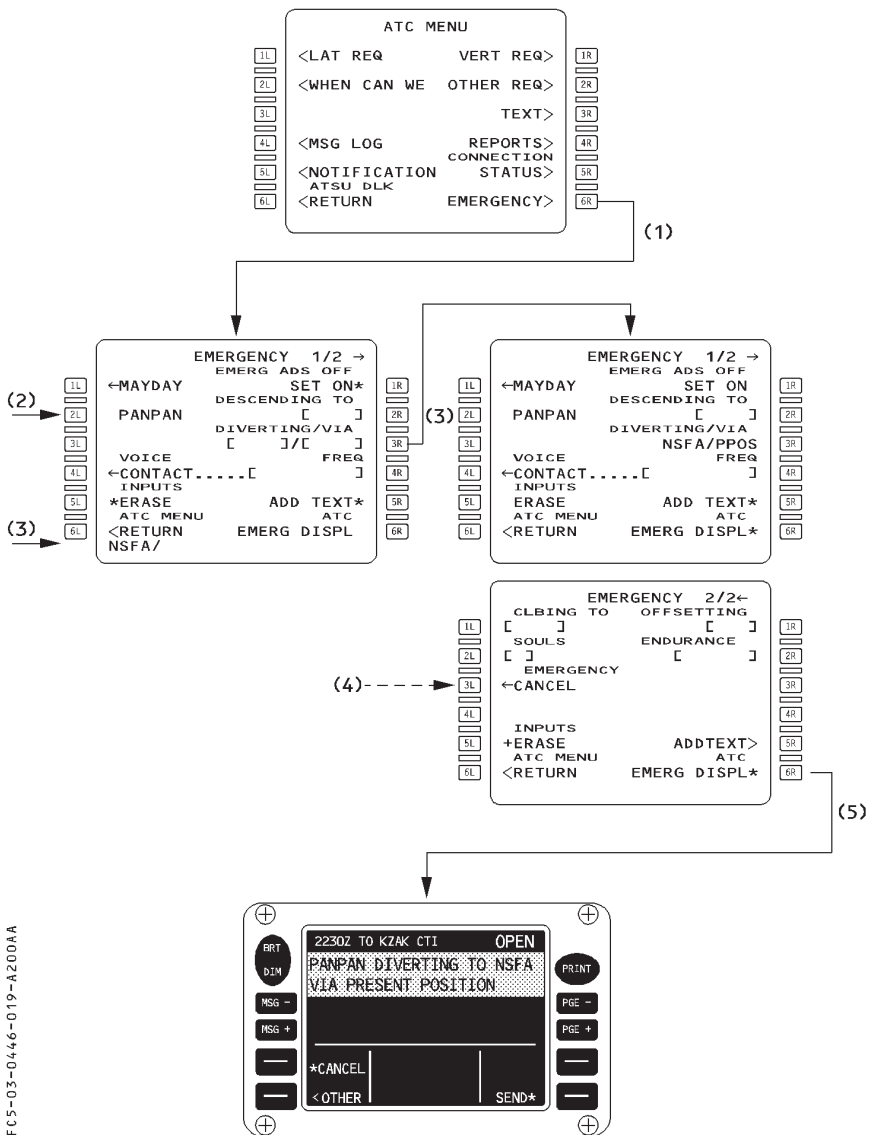



### Automatic Transfer To Next ATC Authority

The current ATC centre sends the "NEXT DATA AUTHORITY" information message. The crew only has to close it.

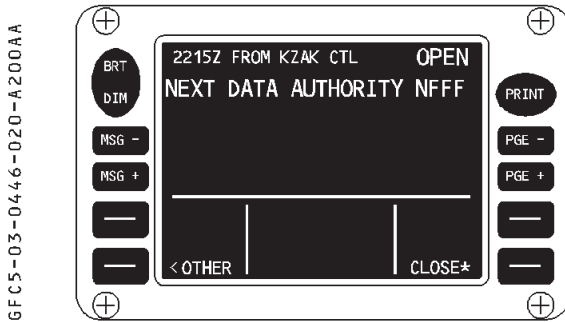

The current ATC centre sends the "END SERVICE" message. It may indicate the frequency to be used for voice backup.

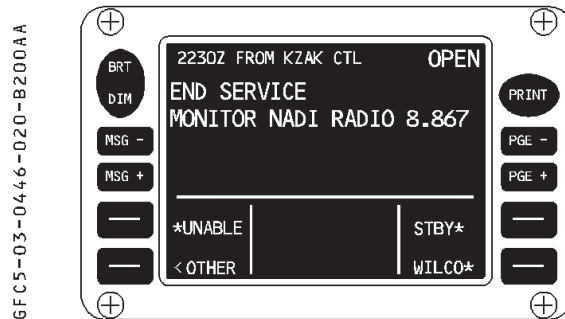

The crew has to answer "WILCO", as is done for other uplink messages.

When the message is closed, the new ATC centre is shown as active.

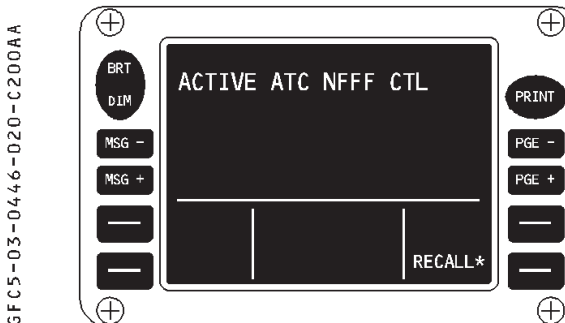



INTENTIONALLY  
BLANK



## **WORLD GEODETIC SURVEY 1984 (WGS 84)**

WGS 84 is the standard used for the accurate position reference used by the GPS system. There are some differences between WGS 84 and the more current geodetic survey systems but these differences are less than 2 cm. ICAO recommends that positions of all navigation references are made with respect to WGS 84 and, in most countries around the world, this recommendation has been complied with. There are some states, however, where the conversion to WGS 84 has not been carried out, leading to the possibility of navigation inaccuracies.

### **Use Of GPS In Non-WGS84 Reference Datum Airspace**

In non-WGS 84 airspace, the local datum (position basis) used to survey the navigation data base position information may result in significant position errors from a survey done using the WGS 84 datum. To the pilot, this means that the position of runways, airports, waypoints, or navigation aids, may not be as accurate as depicted on the map display and may not agree with the GPS position. Crews should consult official sources, e.g. Jeppesen, to determine the current status of airspace in which they operate.

A worldwide survey has been conducted which determined that using the FMGS while receiving GPS position updating during enroute navigation, SIDS and STARS achieve the required navigation accuracy, despite operating in non-WGS 84 airspace. However, this navigation position accuracy may not be adequate for approaches. Therefore, the aircraft flight manual requires the crew to inhibit GPS position updating while flying approaches in non-WGS 84 airspace "unless other appropriate procedures are used."

Provided operational approval has been received and measures to ensure their accuracy have been taken, RNAV approaches may be flown with GPS updating enabled. Options available may include surveys of the published approaches to determine if significant differences or position errors exist, developing special RNAV procedures complying with WGS 84 or equivalent, or inhibiting GPS updating.

For approaches based upon ground-based navigation aids such as ILS, VOR, LOC or NDB, the GPS updating need not be inhibited, provided that appropriate raw data is used as the primary navigation reference throughout the approach and missed approach. Aircraft primary lateral and vertical navigation modes may be used. Provided the FMGS is not used as the primary means of navigation for approaches, this method can be used instead of inhibiting GPS updating.

INTENTIONALLY  
BLANK



## UN-NAMED OCEANIC CONTROL AREA REPORTING POINTS

Positions in the Northern Hemisphere use the letters "N" and "E", while positions in the Southern Hemisphere use the letters "S" and "W". Latitude always precedes longitude.

For longitude, only the last two digits of the three digit value are used.

Placement of the designator in the five character set indicates whether the first longitude digit is 0 or 1. The letter is the last character if the longitude is less than 100° and is the third character if the longitude is 100° or greater. "N" is used for north latitude, west longitude; "E" is used for north latitude, east longitude. "S" is used for south latitude, east longitude. "W" is used for south latitude, west longitude.

Examples:

N50° W040° becomes 5040N

N75° W170° becomes 75N70

N50° E020° becomes 5020E

N06° E110° becomes 06E10

S52° W075° becomes 5275W

S07° W120° becomes 07W20

S50° E020° becomes 5020S

S06° E110° becomes 06S10



## UN-NAMED TERMINAL AREA FIXES

### DME ARC Procedures

Unnamed fixes along a DME arc procedure are identified by a five character designation with the first character being "D".

Characters from two to four indicate the radial on which the fix lies. The last character indicates the arc radius. The radius is expressed by a letter of the alphabet where A = 1 mile, B = 2 miles, C = 3 miles and so forth.

Examples:

EPH 252°/ 24 = D252X

EPH 145°/ 24 = D145X

GEG 006°/ 20 = D006T

An unnamed waypoint along a DME arc with a radius greater than 26 miles is identified by the station identifier and the DME radius.

Examples:

CPR 338°/29 = CPR29

GEG 079°/30 = GEG30

## FIXES WITH ONE WORD NAMES

Waypoints located at fixes with names containing five or fewer characters are identified by the name.

Examples:

DOT, ACRA, ALPHA

Names with more than five characters are abbreviated using the following rules sequentially until five characters remain:

- Delete double letters
- Keep the first letter, first vowel and last letter
- Delete other vowels starting from right to left
- Keep the last letter and then delete consonants from right to left



Examples:

KIMMEL becomes KIMEL  
COTTON becomes COTON  
RABBITT becomes RABIT

Examples:

ADOLPH becomes ADLPH  
BAILEY becomes BAILY  
BURWELL becomes BURWL

Examples:

ANDREWS becomes ANDRS  
BRIDGEPORT becomes BRIDT  
HORSBA becomes HORS A

## **FIXES WITH MULTI-WORD NAMES**

Use the first letter of the first word and abbreviate the last word using the above rules sequentially until a total of five characters remain.

Examples:

CLEAR LAKE becomes CLAKE  
ROUGH ROAD becomes RROAD

INTENTIONALLY  
BLANK



## **TRAFFIC ALERT AND COLLISION AVOIDANCE SYSTEM (TCAS)**

### **Conflict Resolution**

#### **Traffic Advisory (RA)**

If an intruder represents a potential collision threat, a visual and aural TRAFFIC ADVISORY is given. This advisory aids the crew to acquire visually the intruder. Also it prepares the crew for a possible RESOLUTION ADVISORY. However, not every RA has to be preceded by a TA.

#### **Resolution Advisory (RA)**

If the intruder is considered as a real collision threat, an aural and visual Resolution Advisory is given. The TCAS determines the optimum vertical manoeuvre that ensures effective separation with the minimum change of vertical speed. Depending on each situation, the TCAS will generate:

- Preventive advisory. The actual vertical speed may be maintained. A range of vertical speed to avoid is displayed
- Corrective advisory. The actual vertical speed is within the range to be avoided and a range of recommended vertical speed (fly to) is displayed
- Modified corrective advisory which changes RA already displayed, e.g. if the intruder changes its vertical speed

### **Avoidance Generalities**

Always follow the TCAS orders, even if they lead to crossing the altitude of the intruders, as they ensure the best global separation. Failure to respond immediately to TCAS orders may result in loss of separation from the intruder aircraft. TCAS commands override ATC instructions.

For system description, FCOM 1.34.80 refers. For operational procedures, FCOM 3.02.34 and the QRH refer.





SCENARIO	AURAL WARNING and TYPICAL DISPLAY		CREW RESPONSE
	PFD	ND	
<p><b>TRAFFIC ADVISORY</b></p> <ul style="list-style-type: none"> <li>- one intruder is ahead at 12 o'clock beyond 6 NM, 200 ft below your altitude</li> </ul>			<ul style="list-style-type: none"> <li>- Do not maneuver on the traffic advisory symbol.</li> <li>- Attempt to visually acquire the intruder.</li> <li>- Be prepared to maneuver if the TA changes to an RA</li> </ul>
<p><b>RESOLUTION ADVISORY (PREVENTIVE)</b></p> <ul style="list-style-type: none"> <li>- One intruder is ahead at 12 o'clock, 600 ft below your altitude</li> </ul>			<ul style="list-style-type: none"> <li>- Do not descend</li> </ul>
<p><b>RESOLUTION ADVISORY (CORRECTIVE)</b></p> <ul style="list-style-type: none"> <li>- Two intruders are ahead at 12 o'clock                             <ul style="list-style-type: none"> <li>- one, at 500 ft above your altitude</li> <li>- the other, at 500 ft below your altitude</li> </ul> </li> </ul>			<ul style="list-style-type: none"> <li>- Remain in level flight</li> <li>- Do not climb or descend</li> </ul>

6F C5-03-04,34-008-A,10DAB

V/S scale color Legend: : green : red



SCENARIO	AURAL WARNING and TYPICAL DISPLAY		CREW RESPONSE	
	PFD	ND		
<div style="border: 1px solid black; padding: 5px; display: inline-block; margin-bottom: 10px;"> <b>RESOLUTION ADVISORY (CORRECTIVE)</b> </div> <ul style="list-style-type: none"> <li>- The intruder is ahead at 12 o'clock, 400 ft above your altitude</li> <li>- You are already climbing at 2000 ft/mn</li> </ul>			<ul style="list-style-type: none"> <li>- Reduce climb</li> </ul>	
	<ul style="list-style-type: none"> <li>- The intruder is ahead at 12 o'clock, 200 ft below your altitude</li> </ul>			<ul style="list-style-type: none"> <li>- Promptly (within 5 seconds) and smoothly establish a climb rate of 1 500 ft/mn</li> </ul>
	<ul style="list-style-type: none"> <li>- The intruder is ahead at 12 o'clock, 200 ft above your altitude</li> </ul>			<ul style="list-style-type: none"> <li>- Promptly (within 5 seconds) and smoothly establish a descent rate of 1 500 ft/mn</li> </ul>

6 FCS-03-04,34-009-A100AB

V/S scale color legend:



: green



: red

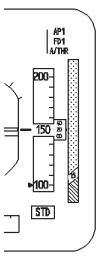
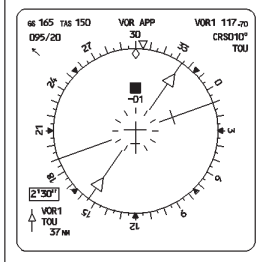
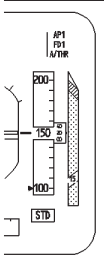
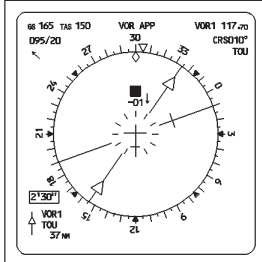
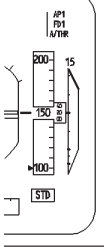
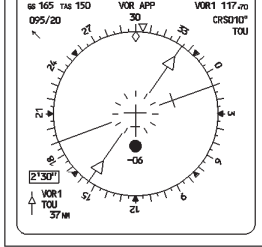

SCENARIO	AURAL WARNING and TYPICAL DISPLAY		CREW RESPONSE
	PFD	ND	
<div style="border: 1px solid black; padding: 5px; width: fit-content; margin-bottom: 10px;">RESOLUTION ADVISORY (ADDITIONAL CORRECTIVE)</div> <ul style="list-style-type: none"> <li>- The intruder is ahead and has stopped its climb</li> <li>- It is now 100 ft below your altitude</li> </ul>			<ul style="list-style-type: none"> <li>- Immediately (within 2.5 seconds) and smoothly increase your descent rate to 2 500 ft/mn</li> </ul>
<ul style="list-style-type: none"> <li>- The intruder ahead and above has changed from level flight to a rapid descent after TCAS issued a DESCEND RA</li> <li>- TCAS is now changing that to a CLIMB RA</li> </ul>			<ul style="list-style-type: none"> <li>- Initiate a change from a descent to a climb maneuver, within 2.5 seconds.</li> </ul>
<div style="border: 1px solid black; padding: 5px; width: fit-content; margin-bottom: 10px;">RA CLEARED</div> <ul style="list-style-type: none"> <li>- The intruder has passed behind and is now 600 ft below your altitude</li> <li>- It is no longer a threat</li> </ul>			<ul style="list-style-type: none"> <li>- Return promptly to the previous ATC clearance.</li> </ul>

6F-C5-03-04334-010-A001AA

V/S scale color legend:  : green  : red



## **RNP**

### **General**

Procedures, FCOM 3.04.34 refers.

The aircraft navigation systems required by regulation to fly within a Required Navigation Performance (RNP) airspace shall comply with RNAV functionality criteria and with navigation position accuracy and integrity criteria.

When referring to RNP-X, the value of X is the navigation accuracy expressed in nautical miles, which has to be met with a probability of 95 %.

A RNP value can be associated with an airspace, route, SID, STAR, RNAV approach or a RNAV missed approach procedure.

Depending on the RNP value and the airspace environment (availability of ground-based radio navaids), different navigation equipment may be necessary.

### **RNP CAPABILITY**

In order to achieve a given RNP criteria, the FMS estimated position accuracy (also called Estimated Position Error) must be better than the associated RNP value. This is dependent on the FMS navigation-updating mode (GPS, DME/DME, VORDME, or IRS).

Both the required and the estimated position accuracy are displayed on the MCDU PROG page, and their relationship determines the HIGH/LOW accuracy indication (FCOM 1.22.20 refers).

The required accuracy can be either the default value, which is a function of the phase of flight, or a value manually entered by the crew. In this case, when flying in a RNP environment, the appropriate RNP value should be inserted in the REQUIRED ACCUR field of the PROG page.

- When HIGH is displayed, the RNP criteria is achieved
- When LOW is displayed, the RNP criteria is not achieved. In this case, use raw data to crosscheck navigation (FCOM 3.04.34 refers). If raw data is not available or the navigation check is negative, advise ATC.

When leaving the RNP environment, clear any manually entered RNP value.



## Without GPS PRIMARY

RNP accuracy criteria are met provided the radio navaid coverage supports it for:

- RNP-1 en route and in the terminal area provided a required accuracy of 1 nm\* is manually entered in MCDU.
- RNP-0.3 in the approach area provided a required accuracy of 0.3nm\* is manually entered in MCDU.

Note:

1. \*It is acceptable to enter the radial equivalent of the specified cross-track (XTK) accuracy, which is the RNP value multiplied by 1.22.

## With GPS PRIMARY

RNP accuracy criteria are met for:

- RNP-1 en route
- RNP-0.5 in the terminal area provided AP or FD in NAV mode is used
- RNP-0.3 in the approach area provided AP or FD in NAV mode is used

## RADIAL EQUIVALENCE

Aircraft fitted with legacy FMS, identified by the absence of the DCDUs on the forward centre instrument panel, display the radial equivalent of the REQUIRED (RNP) navigation performance on the PROG page.

For RNP requirements, the navigation position error is defined in terms of the XTK/ATK error. The legacy FMS computes an estimated accuracy that is a radial value (circle) around the estimated position and displays this equivalent value on the PROG page. To obtain the radial equivalent of a XTK/ATK (RNP) value, multiply the XTK/ATK by 1.22 as follows:

- Radial equivalent = XTK/ATK (RNP) x 1.22

For example, if an airspace or procedure specified an RNP of 0.3 nm, legacy FMS will display the radial equivalent value 0.37 nm on the PROG page (0.3 x 1.22), which equates to the specified RNP.



## **TABLE OF CONTENTS**

### **Training Guide**

#### **General**

Preface ..... 10.10.1

#### **MEL**

General ..... 10.20.1

ATA 100 Format ..... 10.20.1

MEL Description ..... 10.20.1

MEL Operational Use ..... 10.20.2

#### **Briefing Guidelines**

Briefing Procedure ..... 10.30.1

C-TWO Acronym ..... 10.30.1

Briefing Aide-memoire ..... 10.30.3

Expanded “Two” Briefing Items ..... 10.30.3

Briefing Examples ..... 10.30.6

#### **Sidestick**

Sidestick Characteristics ..... 10.40.1

#### **Operating Speeds**

Characteristic Speeds ..... 10.50.1

Protection Speeds ..... 10.50.3

Limit Speeds ..... 10.50.4

Other Speeds ..... 10.50.5

#### **PFD/FMA Call Procedure**

PFD/FMA Changes To Be Called ..... 10.60.1

#### **Descent Management**

Descent Profile Management ..... 10.70.1



## **Touch And Go-around**

General.....	10.80.1
Approach.....	10.80.1
Landing .....	10.80.1



## **PREFACE**

Chapter 10 provides additional data for initial training. The aim of the chapter is to:

- Describe use of the MEL
- Define the requirements of Departure/Arrival Briefings
- Discuss sidestick characteristics and characteristic speeds
- Define FMA changes to be called
- Assist the trainee to visualise cockpit flow patterns – to be issued later
- Provide a basis for the handling of abnormal procedures – to be issued later
- Describe base training procedures
- FAQ – to be issued later

This chapter is not a complete reference and should be read in conjunction with FCTM Ch 2 to 9 and the FCOM.



INTENTIONALLY  
BLANK



## GENERAL

The Master Minimum Equipment List (MMEL) is published by the aircraft manufacturer and is a certified document. It allows an aircraft to be dispatched with some equipment or some functions inoperative. Some limitations, operational procedures and/or maintenance procedures may have to be carried out. The Minimum Equipment List (MEL) is published by CX and approved by the CAD. It is necessarily at least as restrictive as the MMEL. The MMEL cannot be used as an MEL.

The dispatch of an aircraft is possible with some secondary airframe part or parts missing. In such a case, refer to the Configuration Deviation List (CDL) at the rear of the MEL.

## ATA 100 FORMAT

Each item/equipment listed in the MEL is identified using ATA (Air Transport Association) format. It is the official reference for the classification of the aircraft systems and/or functions. This is achieved using six digits. For example 21-52-01 refers to:

- 21: ATA 21: Air conditioning
- 52: Air cooling system
- 01: Air conditioning pack

## MEL DESCRIPTION

The MEL consists of four parts:

- ECAM warnings/ MEL entry
- List of items that may be inoperative for dispatch
- Associated operational procedures
- Configuration Deviation List



## MEL OPERATIONAL USE

The Commander is responsible for ensuring that the aircraft is in every way fit for the intended flight. The MEL represents guidance to the Commander as to what defective items might be reasonably left unrectified, without jeopardizing the safety of the aircraft, when making his decision whether to operate the intended flight.

If a failure occurs during the taxi phase before the start of the take-off roll, any decision to continue the flight shall be subject to pilot judgement and good airmanship. The Commander may refer to the MEL before making a decision to continue the flight.

During the Flight Deck Check, press the RCL pb for at least 3 sec to recall any previous cautions or warnings that have been cleared or cancelled. The Aircraft Maintenance Logbook (AML) should then be consulted to confirm the indications are compatible with the MEL.

MEL section 00E is titled ECAM warnings/MEL entry. The purpose of this section is to help the crew determine the MEL entry point when an ECAM caution or warning message is displayed. If a failed item is not mentioned in the MEL, dispatch is not possible.

If the failed item is mentioned, dispatch is possible provided all dispatch conditions are fulfilled:

- Check the rectification time interval has not expired. Consider location where repair is possible
- (\*) Means that an INOP placard is required
- (O) Means a specific operational procedure or limitation is required. Refer to MEL Chapter 2
- (M) Means a specific maintenance procedure is required

When the MEL indicates a requirement for both maintenance and operational procedures, maintenance procedures must be performed before applying the operational procedures.

Some failures have operational consequences for LWMO and ETOPS. The applicable MEL references are annotated "L" and "E" respectively. Although not necessarily dispatch items, the effect of such failures must be taken into account if they will have an operational effect on the intended sector.



## BRIEFING PROCEDURE

The briefing should take place once the set up and cross-check of the Flight Management System (FMS) is complete. For departure briefings there is no requirement to wait for the loadsheet or take-off data to be entered into the FMS before conducting the briefing. The following actions shall be completed before the briefing commences:

- FCOM procedures with the exception of loadsheet and/or take-off data entry as mentioned above.
- The FMS checked for accuracy against the CFP and the relevant published procedures.
- Navigation Aids set-up. Modifications to existing radio aid selections may be required following an arrival briefing.
- Any PNF questions about the set-up addressed. This can be achieved at the time or during the briefing.

"Are you ready for the briefing?" is typically the question that commences the briefing process. A positive answer from the PNF means that all required actions have been completed and checked and that any anomalies have been raised by the PNF.

## C-TWO ACRONYM

Briefings will consist of 4 modules covered by the acronym "**C-TWO**":

- **C**hart
- **T**errain
- **W**eather
- **O**perational

Each module shall be discussed in every briefing. The "**C**" module identifies the procedure to be flown. There is no need to discuss every detail of the published procedure, as this will have been effectively 'self-briefed' during the data entry and cross-checking phase. However, experience, recency, or training requirements should be taken into consideration when deciding how much to mention in this module.



The "**TWO**" modules will consist of details that the PF considers relevant to the particular departure/arrival to be flown. The PF should consider the intended departure or arrival and incorporate relevant briefing points into an appropriate module. The intent is to incorporate briefing points that generate thought and awareness about the departure/arrival to be flown. A review of pertinent procedures will usually be required in unusual circumstances. Examples include:

- RTO with a thrust-reverser locked out.
- Engine inoperative considerations when arriving with an engine inoperative.
- Missed approach considerations when arriving at an airport where there is an increased chance of a missed approach being flown.

In the simplest case, at a familiar airfield with experienced crew and in good weather, the modules can be covered with a "nil significant" statement with the exception of the Terrain Module. This will always require the "Sector MSA plus Highest MSA" as a minimum statement.

The PF should decide on what material is included in each of the modules. The Commander shall ensure that all relevant details are covered. The intention of the briefing is to generate thought provoking and relevant discussion.

Every Departure and Arrival must be viewed in the context of **THREATS** and how best to overcome them. Threats must be identified and covered in the briefing. An example would be when the Port Page identifies a known problem, e.g. false LOC captures. In this case, the words "nil significant" are clearly inadequate.

Prior to commencing the briefing, the PF conducts a cross-check of the flight instruments. The F-PLN page should be selected before either the departure or arrival briefing is commenced.

The C-TWO module is then initiated by confirming the planned runway, SID, departure transition, STAR, arrival transition and type of approach, as applicable.

The briefing can be conducted prior to receipt of the clearance. In this case, upon receipt of the clearance, the F-PLN page shall be reselected by the PF for confirmation.

An EFIS check is then initiated. This is designed to capture correct settings of the ND, navigation aids and FMA. The RADNAV page should not be referenced. Any short-term navigation aid selections should have been discussed in the C-TWO briefing under Operational.



Departure	Arrival
Chart	
Runway Name of SID / Departure Transition	Name of STAR/Transition Approach Chart ID Type of Approach/Runway Final profile altitude check Minimums Missed Approach. Initial actions only i.e. Tracking and Altitude Navigation Aids for approach and go-around
Terrain	
Relevant Sector MSA and highest MSA	
Weather	
Relevant weather	
Operational	
Relevant Operational Considerations	
	Alternate Relevant Fuel

## BRIEFING AIDE-MEMOIRE

A briefing aide-memoire is available in card form. This details the minimum briefing items required.

## EXPANDED "TWO" BRIEFING ITEMS

Items to be included in the "C-TWO" modules will differ for each flight. Examples of items that may be included in the modules are listed below. This list is not exhaustive and the principle of including relevant, useful information should be employed.



## **Terrain**

Consider the following:

- Area Chart with emphasis on navigation aids to be used to enhance terrain awareness
- Minimum Vectoring Altitude Chart, if available
- Airfield elevation, if significant
- Low transition levels

## **Weather**

- Consider the following:
- Typhoons
- Thunderstorms
- Windshear
- Turbulence
- Rain/runway contamination
- Use of wipers/rain-repellent
- Icing
- Hot weather
- Cold weather
- Altimetry
- Low Visibility Procedures (LVP)
- Wind/crosswind



## Operational

Consider the following:

- Port page details
- Speed control
- Noise abatement requirements
- LVP
- Use of AP
- Use of A/THR
- Flight mode selection
- Non-normal procedures
- Engine inoperative procedures
- Configuration
- Crew duties
- Holding
- Runway characteristics
- Landing weight
- Autobrake/braking
- Taxiing requirements
- Significant elements of the missed approach
- Diversion plan and fuel requirements
- Extra fuel available





## BRIEFING EXAMPLES

### Departure

#### **BKK 21R, CAVOK** (Experienced crew, current at BKK)

- 21R, Bruce 2 departure, Regos transition.
- The sector and highest MSA is 2300 ft.
- No weather or operational considerations.
- Any questions?

#### **BKK 21R, CB's to South, Outboard Reverser Inop, WIP Taxiway C**

- 21R, Bruce 2 departure, Regos transition.
- The sector and highest MSA is 2300 ft.
- Weather avoidance will be required on departure with possible windshear (discuss windshear actions). Cabin crew will not be released till clear of weather.
- Operationally – taxiway C is closed so we can expect routing on Bravo.
- We have #4 thrust reverser inoperative in the event of a rejected T/O.
- Any questions?



## Arrival

### HKG, 07L, CAVOK

- Elato 1A arrival to ILS 07L, chart 11-1, check altitude of 1300 ft at 4.0 DME, IZSL, minimum 222 ft set (confirmed by PNF), missed approach is initially runway heading, 5000 ft. Navigation aids initially NLG, TD then SMT, TD.
- The Sector and Highest MSA is 4300 ft.
- Weather is not a factor.
- No significant operational factors. Macau diversion with 30 minutes holding.
- Any questions?

### HKG, 07L, thunderstorms and moderate rain, visibility 2000 m

- Elato 1A arrival to ILS 07L, Chart 11-1, check altitude of 1300 ft at 4.0 DME, IZSL. Minimum 222 ft set (confirmed by PNF), required RVR 550 m. Missed approach is initially runway heading, altitude 5000 ft. Navigation aids initially NLG, TD then SMT, TD.
- Sector and Highest MSA 4300 ft, high ground south of the airport and in close proximity to the arrival and missed approach procedure.
- Weather avoidance and possible windshear / turbulence (discuss).
- This will be an automatic landing. We may need wipers on finals. In the event of a missed approach I will select TOGA... (discuss all MAP considerations). After landing I will be using max reverse. Shenzhen is our alternate. We require 5.5 tonnes. We have 30 minutes of holding fuel.
- Any questions?

INTENTIONALLY  
BLANK



## **SIDESTICK CHARACTERISTICS**

There is no physical interconnection between the sidesticks. Visual monitoring of the other pilot's sidestick input is significantly reduced because of the sidestick position.









With the AP engaged, the sidesticks are locked in the neutral position. This provides a tactile feedback that the AP is engaged and also prevents simultaneous inputs from the pilot and AP.

When the PF makes a sidestick input, an electrical order is sent to the flight control computers. If the PNF makes a simultaneous sidestick input, both signals are algebraically summed and both PF and PNF green lights flash on the glareshield. This situation might occur in the case of an instinctive PNF reaction on the sidestick. If the PNF needs to take control, he must press and hold the take-over pb in order to avoid simultaneous sidestick inputs and announce, "I have control".

In the case of a SIDESTICK FAULT ECAM warning due to an electrical failure, the affected sidestick order sent to the computers is zeroed. This means that the affected sidestick has been deactivated and there is no further procedure associated with this warning.

In the case of pilot incapacitation where a sidestick input is being made, or in the case of a mechanical failure leading to a jammed sidestick, the inputs are again algebraically summed. There is no associated ECAM caution. In either of these cases, the intervening pilot must press the take-over pb to gain single sidestick authority. The pb must be depressed for at least 40 seconds to permanently deactivate the affected sidestick. However, if a sidestick has been deactivated, it may be reactivated by depressing its take-over pb.

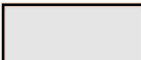

Captain's side		First Officer's side		Audio
Sidestick	Annunciation	Annunciation	Sidestick	
Priority P/B Depressed	 Green	 Red	Sidestick Deflected	PRIORITY LEFT
Priority P/B Depressed		 Red	Sidestick In neutral	
Sidestick Deflected	 Red	 Green	Priority P/B Depressed	PRIORITY RIGHT
Sidestick In neutral	 Red		Priority P/B Depressed	
Simultaneous Inputs on stick	 CAPT	 F/O	Simultaneous inputs on stick	

Sidestick Priority Lights Indications



## CHARACTERISTIC SPEEDS

The characteristic speeds VLS, F, S and Green Dot are displayed on the PFD speed scale and are computed by the Flight Envelope (FE) computer.

VLS, F, S and Green Dot are also displayed on the PERF TAKE OFF, APPR and GO-AROUND pages. The speeds displayed on these pages are computed by the FMGC.

Computations made by the FE and the FMGC are based on the gross weight information transmitted by the Fuel Control Monitoring Computer (FCMC).

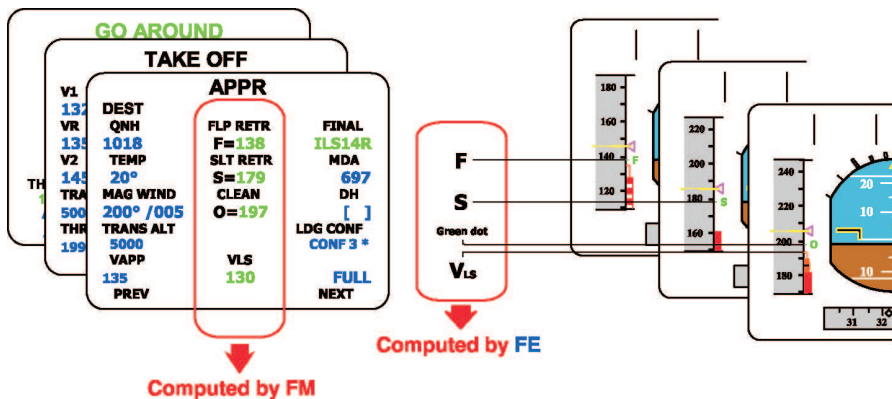

Characteristic Speeds Computation Sources



## VS

VS is the stalling speed and is not displayed. For conventional aircraft, the reference stall speed, VSmin, is based on a load factor that is less than 1g. This gives a stall speed that is lower than the stall speed at 1g. All operating speeds are expressed as functions of this speed, e.g. VREF = 1.3 x VSmin. Because Airbus aircraft have a low speed protection feature which the crew cannot override, the airworthiness authorities have reconsidered the definition of stall speed for these aircraft.

All the operating speeds must be referenced to a speed that can be demonstrated by flight test. This speed is designated as VS1g. Airworthiness authorities have agreed that a factor of 0.94 represents the relationship between VS1g, used as a reference for "fly by wire" Airbus and VSmin for conventional aircraft types. As a result, the authorities allow Airbus aircraft to use the following factors:

- $V_2 = 1.2 \times 0.94 \times VS1g = 1.13 \times VS1g$
- $VREF = 1.3 \times 0.94 \times VS1g = 1.23 \times VS1g$

These speeds are identical to those that the conventional 94% rule would have defined for these aircraft. The Airbus aircraft have exactly the same manoeuvre margin that a conventional aircraft would have at its reference speeds. The FCOM uses VS for VS1g.

## VLS

VLS is the lowest selectable speed. VLS is represented by the top of an amber strip on the airspeed scale on the PFD. It is equal to 1.13 VS at take-off, 1.18 VS when the flaps are retracted and 1.23 VS when in the clean configuration. It remains at 1.23 VS until landing. VLS is corrected for Mach effect to maintain a 0.3g buffet margin. In addition, VLS is increased when the speed brakes are extended. At take-off, until retraction of one step of flaps, VLS is equal to or greater than the lower of  $V_2/1.05$  and 1.05 VMCA. In all other phases of flight, VLS is equal to or greater than VMCL. In the case of two engines inoperative on the same wing, as soon as the slats are extended, VLS on the PFD is  $\geq VMCL-2$ . VLS on the MCDU is not modified.

## F Speed

At take-off, F speed is the minimum speed at which the flaps may be retracted. On approach, F speed is the target speed when the aircraft is in CONF 2 or 3. It is represented by "F" on the PFD speed scale. It is equal to approximately 1.18 VS of CONF 1+F for take-off and is limited to a minimum of VMCL+5 kt. For approach in CONF 2, it is increased by (A333: 14%) (A343: 18%) (A346: 22%). It is limited to a minimum of VMCL+15 kt and to a maximum of VFE CONF 3 – 2 kt. For approach in CONF 3, it is increased by (A333: 4%) (A343: 7%) (A346: 12%). It is limited to a minimum of VMCL+10 kt and to a maximum of VFE CONF FULL – 2 kt.



## S Speed

At take-off, S speed is the minimum speed at which the slats may be retracted. On approach, S speed is the target speed when the aircraft is in CONF 1. It is represented by "S" on the PFD speed scale. It is equal to approximately 1.21 VS of clean configuration and it is limited to VFE CONF 1\* – 2 kt for approach.

## ○ (Green Dot)

Green Dot corresponds to the engine-out operating speed in clean configuration. It provides the speed for the best lift/drag ratio and corresponds to the final take-off speed. It is represented by a green dot on the PFD speed scale. A formula to derive Green Dot for A333/A343 is shown below:

- 0.6 x weight (tonnes) + (A333: 107 kt) (A343: 115 kt) below 20000 ft
- Add 1 kt per 1000 ft above 20000 ft
- Subtract 10 kt with one engine out.

(A346: Green dot speed is not modified with one engine inoperative)

## PROTECTION SPEEDS

The protection speeds  $V_{\alpha}$  PROT,  $V_{\alpha}$  MAX, VSW displayed on the PFD speed scale are computed by the PRIM based on aerodynamic data.

### $V_{\alpha}$ PROT

$V_{\alpha}$  PROT is the speed that corresponds to the angle of attack at which the AOA protection becomes active. In normal law it is represented by the top of a black and amber strip on the PFD speed scale.

### $V_{\alpha}$ FLOOR

$V_{\alpha}$  FLOOR is the speed that corresponds to the angle of attack at which the A/THR triggers TOGA thrust. This value is not displayed on the PFD, but is normally situated between  $V_{\alpha}$  PROT and  $V_{\alpha}$  MAX.

### $V_{\alpha}$ MAX

$V_{\alpha}$  MAX is the speed that corresponds to the maximum angle of attack that may be reached in pitch normal law. In normal law it is represented by the top of the red strip on the PFD speed scale.

### VSW

VSW is the stall warning speed. It is represented by the top of the red and black strip on the PFD speed scale and is only operative when the flight control law is degraded to alternate or direct.





## **VMAX**

VMAX is the maximum permitted speed, represented by the bottom of the red and black strip on the PFD speed scale. It is determined by the FE computer, according to the aircraft configuration and is equal to VMO (or speed corresponding to MMO), VLE or VFE.

## **LIMIT SPEEDS**

### **VMCG**

VMCG is the minimum speed on the ground during take-off, at which the aircraft can be controlled by the use of the primary flight controls only, after a sudden failure of the critical engine, with the other engine(s) remaining at take-off thrust.

### **VMCA**

VMCA is the minimum control speed in flight at which the aircraft can be controlled with a maximum bank angle of 5°, if one engine fails, with the other engine(s) remaining at take-off thrust (take-off flap setting, gear retracted).

### **VMCL**

VMCL is the minimum control speed in flight at which the aircraft can be controlled with a maximum bank angle of 5°, if one engine fails, with the other engine(s) remaining at takeoff thrust (approach flap setting).

### **VMCL-2 (A340)**

VMCL-2 is the minimum control speed in flight at which the aircraft can be controlled with a maximum bank angle of 5°, if two engines fail on the same side, with the other engine(s) at TOGA thrust (approach flap setting).

### **VFE**

VFE is the maximum speed for each flap configuration.

### **VLE**

VLE is the maximum speed with landing gear extended.

### **VLO**

VLO is the maximum speed for landing gear operation.

### **VMO**

VMO is the maximum speed.



## VFE NEXT

VFE NEXT is the maximum speed for the next flap lever selection (further extended position).

## OTHER SPEEDS

### V1

V1 is the highest speed, during take-off, at which there is a choice of either continuing the take-off or stopping the aircraft. It is represented by "1" on the PFD speed scale and is inserted manually via the PERF TAKE-OFF page.

### VR

VR is the speed at which the pilot rotates in order to reach V2 at a height of 35 ft above the end of the runway with one engine inoperative. It is inserted manually via the PERF TAKE-OFF page.

### V2

V2 is the take-off safety speed that the aircraft achieves at a height of 35 ft above the end of the runway with one engine inoperative. V2 is maintained during the second segment. It is represented by the Target Airspeed symbol on the PFD speed scale. The minimum value is 1.13 VS for the corresponding configuration. It is inserted manually via the PERF TAKE-OFF page.

### VREF

VREF is the reference speed used for normal final approach and is equal to 1.23 VS of Landing Configuration FULL. It is represented on the PERF APPR page if landing is planned in CONF FULL (VLS CONF FULL).

### VAPP

VAPP is the final approach speed. It is displayed on the PERF APPR page and calculated by the FMGCs.  $VAPP = VLS + \text{wind correction}$ . The wind correction is limited to a minimum of 5 kt and a maximum of 15 kt. VAPP may be modified on the PERF APP page for operational reasons, e.g. ice accretion

### VAPP TARGET

VAPP target is calculated by the FMGC and is represented on the PFD speed scale by a magenta triangle. It gives effective speed guidance on approach for varying wind conditions. VAPP is computed as follows:

- $VAPP \text{ TARGET} = GS \text{ mini} + \text{actual headwind (measured by ADIRS)}$ .
- $GS \text{ mini} = VAPP - \text{Tower wind (headwind component along runway axis calculated by FMGC from tower wind entered on the MCDU)}$ .

INTENTIONALLY  
BLANK



## PFD/FMA CHANGES TO BE CALLED

All changes on the FMA are to be called by the PF, except "LAND GREEN" which is called by the PNF on AUTOLAND approaches. If any change has not been called, then the PNF shall call the change. There is no competition to see who can be the first to call these changes. The PNF should allow reasonable time for the PF to call and not pre-empt him with every change. Any target changes shall be confirmed on the PFD and ND. The result of any selection on the FCU shall be confirmed on the FMA. The effect on the flight path shall be monitored using raw data. Selection of an autopilot shall be confirmed by reading the AP1(2) annunciation on the FMA.

Examples of standard calls are shown below to demonstrate how FMA changes should be announced. (B) = Blue, (G) = Green and (W) = White.

### Take-off

MAN FLX 50 (W)	SRS (G) CLB (W)	RWY (G) NAV (B)		1 FD 2 (W) A/THR (B)
"Flex 50 SRS Runway"				

### Thrust Reduction Altitude And Acceleration Altitude

THR CLB or THR DCLB1(2)	CLB (G) ALT (B)	NAV (G)		AP1 (W) 1FD2 (W) A/THR (W)
Initially, above 30 ft, NAV will change to green. "NAV" then "Thrust Climb, Climb, Auto Thrust", or "Thrust D Climb 1 (2), Climb, Auto Thrust" When autopilot has been engaged, "Autopilot 1"				

### Climb In Heading Mode

THR CLB	OP CLB (G) ALT (B)	HDG (G)		AP1 (W) 1FD2 (W) A/THR (W)
"Open Climb, Heading"				



### Climbing And Intercepting FCU Altitude

SPEED	ALT* (G)	NAV (G)		AP1 (W) 1FD2 (W) A/THR (W)
"Speed ALT Star"				

### Maintaining FCU Altitude

SPEED	ALT (G)	NAV (G)		AP1 (W) 1FD2 (W) A/THR (W)
"ALT"				

### At Cruise Level In Prog Page

MACH	ALT CRZ	NAV		AP1 (W) 1FD2 (W) A/THR (W)
"ALT Cruise"				

### Descent

THR IDLE	DES (G) ALT (B)	NAV		AP1 (W) 1FD2 (W) A/THR (W)
"Thrust Idle, Descent, ALT Blue 230" (FL 230 set on FCU and indicated blue on the bottom of the altitude scale of the PFD)				



## Approach

SPEED	ALT (G) G/S (B)	HDG (G) LOC (B)	CAT 3 DUAL MDA xxx	AP1+2 (W) 1FD2 (W) A/THR (W)
"Glide Slope, LOC, Blue, CAT 2 Dual, Autopilot 1 and 2" (Radar heading for ILS and Approach Mode has just been armed)				
SPEED	G/S* (G)	LOC (G)	CAT 3 DUAL MDA xxx	AP1+2 (W) 1FD2 (W) A/THR (W)
"LOC, Glide Slope Star"				

## Missed Approach

MAN TOGA	SRS (G) CLB (B)	GA TRK (G)		AP1+2 (W) 1FD2 (W) A/THR (B)
"TOGA, SRS, Go-around Track"				

## Clearance Levels

As each clearance level is given, the PF sets it in the FCU ALT window.
"290 Blue"
At GS capture, GA altitude is set on FCU.
"5,000 Blue"

INTENTIONALLY  
BLANK



## DESCENT PROFILE MANAGEMENT

If the F-PLN were to be followed from TOD to touchdown, the descent profile would be managed by the FMGS. However, ATC requirements or weather avoidance may take the aircraft off the ideal profile. Consequently, it is important to be aware of the aircraft's position relative to the ideal descent profile and the time available for any corrections to take effect. It is relatively easy for the aircraft to correct from being 3000 ft above profile at FL 350, whereas being 3000 ft above profile at 10000 ft will require a prompt, decisive correction.

All descent management revolves around the relationship between altitude and distance to go (DTG) to touchdown. Consequently the F-PLN page must be realistic. Ensure that the TO waypoint is in front of the aircraft and that the F-PLN is representative of the expected route.

Before being able to assess the aircraft's position relative to the ideal descent profile, it is necessary to have a method of calculating the profile. The following method, illustrated with examples, provides a simple set of rules to monitor and manage the descent profile. It assumes that the MCDU is updated to reflect the expected arrival track.

### TOD Cross-check

Multiply the flight level (in thousands of feet) by 4 to calculate the required distance to go (DTG) to touchdown.

- At FL350, the required DTG is approximately  $(35 \times 4) = 140$  nm.

There will be factors for weight and wind but if the FMGC computed descent point is within  $\pm 20$  nm of this figure, then it can be considered acceptable as a gross error check of the FMGC computation.

### Descent Monitoring

From top of descent to 15000 ft, multiply the altitude (in thousands of feet) by 4 to calculate the required DTG.

- At 20000 ft, the required DTG is  $(20 \times 4) = 80$  nm

Below 15000 ft multiply the altitude by 3 and add 1 nm/10 kt above 150 kt.

- At 10000 ft and 300 kt, the required DTG becomes  $(10 \times 3) + 15 = 45$  nm
- At 5000 ft and 250 kt, the required DTG becomes  $(5 \times 3) + 10 = 25$  nm
- At 3000 ft and 180 kt, flap 2, the required DTG becomes  $(3 \times 3) + 3 = 12$  nm.

At this stage, the aircraft will be approaching the glideslope and, hence, a normal  $3^\circ$  slope





## Profile Management

If the required DTG is less than that shown on the MCDU (low on profile), use V/S until actual DTG = required DTG.

If the required DTG is more than that shown on the MCDU (high on profile), use OP DES and speedbrakes until actual DTG = required DTG.

## Summary

The benefit of using this method is its simplicity. It starts with a known quantity (CRZ FL) and works for any speed.

This method does not directly consider wind. As the profile is being regularly re-assessed during the descent, it will naturally show the effect of wind. A tail wind will push the aircraft high and a head wind will drag the aircraft low. Recover the profile using the techniques described above under Profile Management.

There are numerous variations on this method and ways to finesse the calculations. Whatever method you develop is a matter of personal choice. However, it is essential that you develop and use a descent monitoring and management technique.



## GENERAL

The touch and go is primarily employed during approach and landing practice. It is not intended for landing roll and take-off procedure training.

## APPROACH

Carry out a visual circuit as described in FCTM Ch 6. Confirm that the spoilers and autobrake are not armed.

## LANDING

The trainee accomplishes a normal final approach and landing. After touchdown, the instructor selects Flaps 2, directs the trainee to "stand them up", ensures speedbrakes are retracted and confirms the trim resets into the green band. The trainee moves the thrust levers to the vertical position to allow the engines to stabilise before TOGA is selected.

With the nose wheel on the ground, the pitch trim resets automatically to:

- A333: 4° UP
- A343: 5° UP
- A346: 3° UP

This normally occurs 5 seconds after the pitch attitude is less than 2.5° and if the ground spoilers are retracted.

When the engines are stabilised, the instructor calls "go". The trainee then selects TOGA and removes his hand from the thrust levers. At or above VAPP the instructor calls "rotate". The trainee rotates smoothly to approximately 15° of pitch. The thrust levers must always be moved to TOGA to engage the SRS.

Once airborne, if performance is excessive, the thrust levers may be moved to the climb detent. The aircraft may be slightly out of trim, but this should have little effect on the rotation. Once the aircraft is airborne, flight law blends in by 100 ft RA and the autotrim becomes active.

### WARNING:

1. If reverse thrust is selected, a full stop landing must be carried out.

INTENTIONALLY  
BLANK