

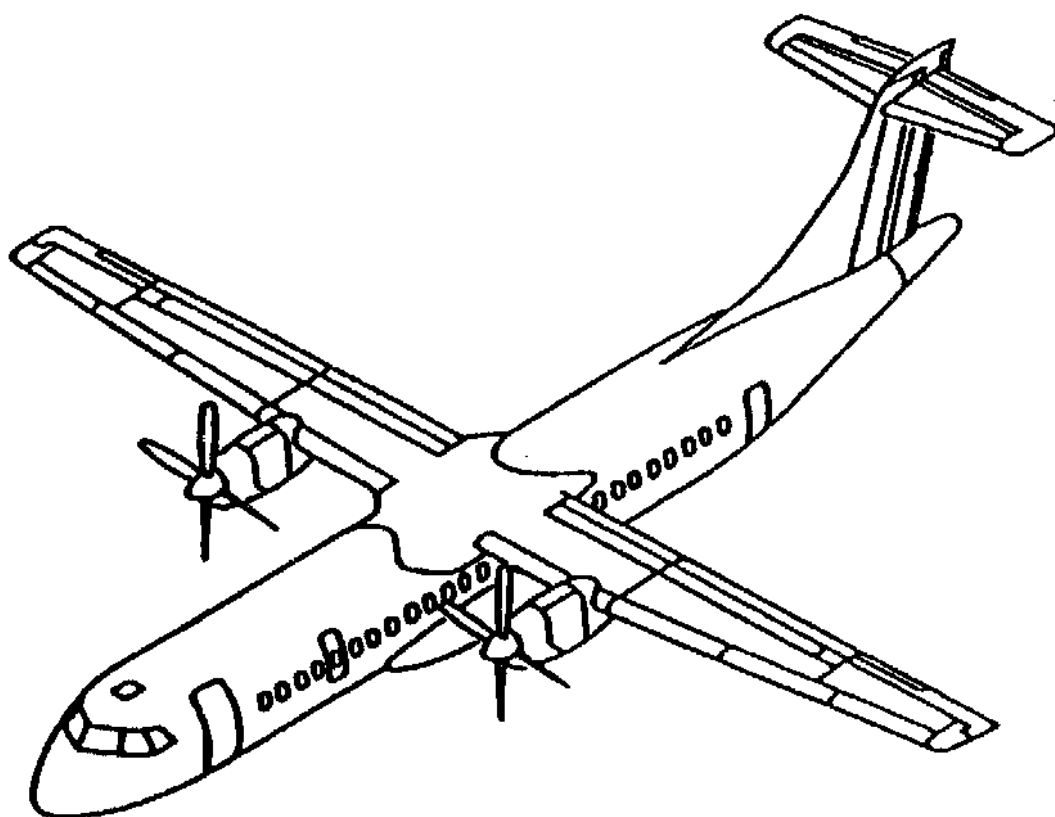



AR72

FLIGHT CREW

OPERATING MANUAL



- INTRODUCTION
- 1st PART SYSTEMS DESCRIPTION
- 2nd PART OPERATING PROCEDURES
- 3rd PART PERFORMANCE

 ATR 72 F.C.O.M.	FLIGHT CREW OPERATING MANUAL PRELIMINARY PAGES CONTENTS	0.00.00		
		P 1	001	
				JUL 99

AA

- 0.00.00 CONTENTS**
- 0.01.00 LIST OF TEMPORARY REVISIONS (L.T.R.)**
- 0.02.00 REASON OF TEMPORARY REVISIONS (R.T.R.)**
- 0.03.00 SHIPPING NOTE TEMPORARY PAGES (S.N.T.P.)**
- 0.04.00 LIST OF EFFECTIVE TEMPORARY PAGES (L.E.T.P.)**
- 0.05.00 LIST OF NORMAL REVISIONS (L.N.R.)**
- 0.06.00 REASON OF THE REVISION**
- 0.07.00 SHIPPING NOTE NORMAL PAGES (S.N.N.P.)**
- 0.08.00 LIST OF EFFECTIVE NORMAL PAGES (L.E.N.P.)**
- 0.09.00 LIST OF MOD / MP / SB (L.O.M.)**
- 0.10.00 CROSS REFERENCE TABLE (C.R.T.)**
- 0.40.00 ORGANIZATION OF THE MANUAL**
- 0.50.00 STANDARD NOMENCLATURE**
- 0.60.00 UNITS CONVERSION TABLE**

 ATR 72 F.C.O.M.	FLIGHT CREW OPERATING MANUAL PRELIMINARY PAGES ORGANIZATION OF THE MANUAL	0.40.00		
		P 1	001	
				JUL 99

AA

The Flight Crew Operating Manual (FCOM) provides operating crew members with information on the ATR 72 technical procedures and performance characteristics. It will be used as a crew manual for training purposes.

The contents are divided into four parts :

- INTRODUCTION
- Part 1 : Systems description
- Part 2 : Procedures and techniques
- Part 3 : Performances.

FCOM is complementary to the approved airplane flight manual.

Any comment or suggestion related to the content of the FCOM should be addressed to

AVION DE TRANSPORT REGIONAL
DIRECTION SUPPORT EXPLOITATION
1, ALLEE PIERRE NADOT
31712 BLAGNAC CEDEX
FRANCE



FOR PRINTING
AND
DISTRIBUTION

ATR TRAINING CENTER
ATC/T/GSO
1, ALLEE PIERRE NADOT
31712 BLAGNAC CEDEX
TEL : 61-93-13-80
FAX : 61-93-13-67



FOR TECHNICAL
OR
PROCEDURAL
CONTENT

ROFA-00-00-10-001-A001AA

AA

DEFINITION OF THE PAGE

A page is defined by :

- a reference : Part / Chapter / Section / page number
Example : 2.05.10 page 20
- effectivity criteria determining the page sequence
Example : Equipment, Modification, Engine...

A page with a given reference may have several sequences :
Example : 2.05.10 page 20

- Sequence 001
- Mod XXXX Sequence 002
- Mod XXXX + YYYY Sequence 003

All the sequences cover, for a given reference, all aircraft of a specific type. These airlines receive a part of these sequences to cover their float.
A sequence can be valid for several aircraft but an aircraft can not have several sequences.

PAGINATION

TOP OF PAGE

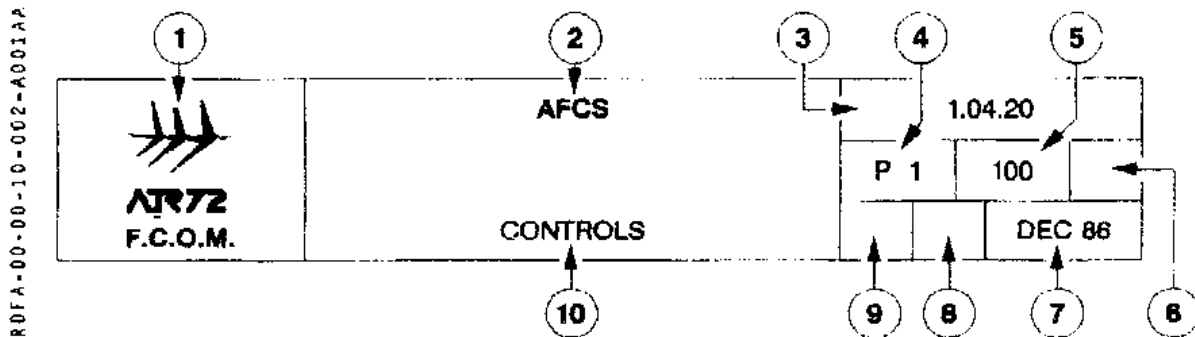

- ① GIE ATR logo (or airline logo)
 - aircraft type
 - manual type
- ② Title of Chapter
- ③ Number of part, chapter and section in the manual
- ④ Page Numbering
Particular case : a page followed by an alphabetic letter must be inserted between 2 pages.
Example : page 11A must be inserted between page 11 and 12.
- ⑤ Sequence number : this code is used by the manufacturer for the manual management. It depends on the modification, engine, unit, etc.



ATR 72
F.C.O.M.

FLIGHT CREW OPERATING MANUAL

PRELIMINARY PAGES ORGANIZATION OF THE MANUAL

0.40.00

P 3

001

JUL 99

AA

- ⑥ Zone for airline : if 2 letters (XX) are indicated on the page, this one is customized to airline XX.
- ⑦ Date of revision (date of page issue)
- ⑧ Zone for standard
- ⑨ Zone for unit
- ⑩ Title of section

BOTTOM OF PAGE

ROFA-00-00-10-003-AD01AA

Mod. : 1175



Eng. :



Model :



- ① This modification zone can contain up to 4 modifications applicable for this page. Above 4 modifications, a GM N° (9 XXX) relative to several modifications will be indicated. This number will also be indicated in the table, page 0.00.45.
- ② Indication of engine type installed on aircraft ; if there is no indication, the page is valid for all engines (PW124, PW127...).
- ③ Indication of aircraft type and model.

MANUAL UPDATE

Your manual comprises 2 types of pages :

- white pages (normal)
- yellow pages (temporary)

These 2 families of pages (white and yellow) have a separated management.

	FLIGHT CREW OPERATING MANUAL PRELIMINARY PAGES ORGANIZATION OF THE MANUAL	0.40.00		
		P 4	001	
				JUL 99

AA

WHITE PAGES (NORMAL)

They are issued for a normal revision.

YOU HAVE JUST RECEIVED A NORMAL REVISION (WHITE)

Refer to SHIPPING NOTE NORMAL PAGES (SNNP) which precises if it is a total shipment. In that case, throw all the pages of your last manual and replace them by the new shipment.

IF IT IS NOT A TOTAL SHIPMENT

You must received :

- the LIST OF NORMAL REVISIONS (LNR)
 - the revised or new white pages
 - the SHIPPING NOTE NORMAL PAGES (SNNP)
- This note lists all revised, new or cancelled white pages, and only these pages, during the last revision. This note serves as guide to update your manual.

Example :

- « » : 1.05.20 p.1 : replace the old page by the revised page
- « ADD » : 1.06.40 p.2 : add new page
- « DESTROY » : 1.10.20 p.3 : delete old page

When you have finished the update, you can throw the SHIPPING NOTE NORMAL PAGES (SNNP)

- a new LIST OF EFFECTIVE NORMAL PAGES (LENP) :

This list sums up all white pages to be found in your manual after the update.

YELLOW PAGES (TEMPORARY)

They are issued during a temporary revision, as it is impossible to wait until the issue of a Normal Revision.

You receive a temporary revision (yellow)

- the LIST OF TEMPORARY REVISIONS (LTR)
- A temporary revision X must remain in your manual as long as a date does not appear in column « Output Date »
- the revised or new yellow pages
 - the SHIPPING NOTE TEMPORARY PAGES (SNTP)
(same action that update of normal white pages).
 - the LIST OF EFFECTIVE TEMPORARY PAGES (LETP) : it lists all yellow pages to be found in your manual after update of your last Temporary Revision.

Note : ① *A Temporary Revision may be cancelled only by a Normal Revision or by another Temporary Revision numerically higher.*

In case you have a yellow page and a white page for one page :

- you keep the white page
- you place yellow page on the white page and until next revision, the information of yellow pages have priority.

In any case, please pay attention to sheets effectivity on the lists of effective pages.



ATR 72
F.C.O.M.

FLIGHT CREW OPERATING MANUAL

PRELIMINARY PAGES
ORGANIZATION OF THE MANUAL

0.40.00

P 5

001

JUL 99

AA

- ② *On your manual, on pages having a technical revision, code « R » may appear on the LH margin. This code identifies the part of the text which has been modified on the page.*

The FCOM is customized for each airline.

In the lists of effective pages, each sheet is represented by 2 lines :

- the first line concerns the recto
- the second line concerns the verso,
when recto and verso are printed.

If only recto sheet is printed, it is represented by a line.

Each sheet is associated with one (or several) number which represents the aircraft FSN (Fleet Serial Number). The sheet is exclusively associated with a specific aircraft in an airline.

At page 0.00.47, you will find the list of the different registrations of your aircraft.

To understand the effectivity of the sheets, you must read :

Example : $XX\ 001 - 003 = XX\ 001\ \text{to}\ 003 \rightarrow 3\ \text{aircraft}\ \text{valid}$

$XX\ 001 + XX\ 003 = XX\ 001\ \text{and}\ 003 \rightarrow \text{only}\ 2\ \text{aircraft}\ \text{valid}$

 ATR 72 F.C.O.M.	FLIGHT CREW OPERATING MANUAL PRELIMINARY PAGES STANDARD NOMENCLATURE	0.50.00		
		P 1	001	
				JUL 99

AA

GLOSSARY OF STANDARD NOMENCLATURE
--

AAS	Anti-icing Advisory System
ABNORM (ABN)	Abnormal
AC	Alternating Current
ACARS	ARINC Communication Addressing and Reporting System
AC BTC	AC Bus Tie Contactor
AC BTR	AC Bus Tie Relay
ACCU	Accumulator
AC EBTC	AC Emer Bus Transfer Contactor
ACW	Alternating Current Wild Frequency
ADC	Air Data Computer
ADF	Automatic Direction Finding
ADI	Attitude Director Indicator
ADS	Air Data System
ADU	Advisory Display Unit
A/EREC	Auto Erection
AFCS	Automatic Flight Control System
A/FEATH	Auto Feathering
AFT	Rear Part
AFU	Auto Feather Unit
AGB	Accessory Gear Box
AGL	Above Ground Level
AH	Ampere – Hours
AHRS	Attitude and Heading Reference System
AHRU	Attitude and Heading Reference Unit
AIL	Aileron
ALT	Altitude
ALTM	Altimeter
ALTN	Alternate
AMP	Ampere
ANN	Annunciator
AOA	Angle of Attack
AP	Auto-Pilot
APC	Active Phase Control
APP	Approach
APU	Auxiliary Power Unit
ARM	Armed
ASAP	As Soon As Possible
ASCB	Avionics Standard Communication Bus
ASD	Accelerate Stop Distance
ASI	Air Speed indicator
ASTR	AC Stand by Bus Transfer Relay
ASYM	Asymmetry
ATC	Air Traffic Control

	FLIGHT CREW OPERATING MANUAL PRELIMINARY PAGES STANDARD NOMENCLATURE	0.50.00		
		P 2	001	
				JUL 99

^{AA} ATE	Automatic Test Equipment
ATPCS	Automatic Take off Power Control System
ATT	Attitude
ATTND	Attendant
AUTO	Automatic
AUX	Auxiliary
AVAIL	Available
AZ	Azimuth
BARO	Barometric
BAT	Battery
BC	Back Course
BITE	Built in Test Equipment
BPCU	Bus Power Control Unit
BPU	Battery Protection Unit
BRG	Bearing
BRK	Brake
B-RNAV	Basic Area Navigation
BRT	Bright
BSC	Battery Start Contactor
BTC	Bus Tie Contactor
BTR	Bus Tie Relay
BXR	Battery Transfer Relay
CAB	Cabin
CAC	Crew Alerting Computer
CAP	Crew Alerting Panel
CAPT	Captain
CAT	Category
C/B	Circuit Breaker
CCAS	Centralized Crew Alerting System
CCW	Counter clockwise
CD	Coefficient of Drag
CDI	Course Deviation Indicator
CFC	Constant Frequency Contactor
CG	Center of Gravity
CHAN	Channel
CHC	Charge Contactor
CHG	Charge
C/L	Check List
CL	Condition Lever
CL	Coefficient of Lift
CLA	Condition Lever Angle
CLB	Climb

 ATR 72 F.C.O.M.	FLIGHT CREW OPERATING MANUAL PRELIMINARY PAGES STANDARD NOMENCLATURE	0.50.00		
		P 3	001	
				JUL 99

AA

CLR	Clear
CM	Crew Member
CMPTR	Computer
COM	Communication
COMPT	Compartment
CONFIG	Configuration
CONT	Continuous
CORRECT	Correction
CPL	Auto Pilot Coupling
CRC	Continuous Repetitive Chime
CRS	Course
CRT	Cathodic Ray Tube
CRZ	Cruise
CTL	Control
CVR	Cockpit Voice Recorder
CW	Clockwise
DADC	Digital Air Data Computer
DADS	Digital Air Data System
DC	Direct Current
DEC	Declination, Decrease
DELTA P	Differential Pressure
DEV	Deviation
DFDR	Digital Flight Data Recorder
DFZ 600	Flight Control Computer
DGR	Degraded
DH	Decision Height
DIFF	Differential
DISCH	Discharge
DIM	Light Dimmer
DIST	Distance
DME	Distance Measuring Equipment
DN	Down
DSPL	Display
EADI	Electronic Attitude Director Indicator
EBCC	Emergency Battery Charge Contactor
EBTC	Emer Bus Transfer contactor
ECU	Electronic Control Unit
EEC	Engine Electronic control
EFIS	Electronic Flight Instrument System
EGHR	External Ground Handling Relay
EHSI	Electronic Horizontal Situation Indicator
EHV	Electro Hydraulic Valve
ELEC	Electrical

 ATR 72 F.C.O.M.	FLIGHT CREW OPERATING MANUAL PRELIMINARY PAGES STANDARD NOMENCLATURE	0.50.00		
		P 4	001	
				JUL 99

AA

ELV	Elevation
EMER	Emergency
ENG	Engine
EPC	External Power Contactor
EQPT	Equipment
ESS	Essential
ET	Elapsed Time
ETOPS	Extended Twin Operations
EXT	Exterior, External
EXC	External Power/Service Bus Contactor
F	Fahrenheit
FAIL	Failed, Failure
FCOC	Fuel Cooled Oil Cooler
FD	Flight Director
FDAU	Flight Data Acquisition Unit
FDEP	Flight Data Entry Panel
FEATH, FTR	Feathered, Feathering
FF	Fuel Flow
FGC	Flight Guidance Computer
FGS	Flight Guidance System
FI	Flight Idle
FLT	Flight
FMA	Flight Modes Annunciators
FMS	Flight Monitoring System
F/O	First Officer
FOS	Flight Operations Software
FQI	Fuel Quantity Indication
FT	Foot, Feet
FTO	Final Take Off
FU	Fuel Used
FWD	Forward
GA	Go Around
GAL	Galley
GC	Generator Contactor
GCU	Generator Control Unit
GEN	Generator
GI	Ground Idle
GMT	Greenwich Mean Time
GND	Ground
GNSS	Global Navigation Satellite System
GPS	Global Positioning System
GPU	Ground Power Unit
GPWS	Ground Proximity Warning System
GRD	Ground
G/S	Glide Slope

 ATR 72 F.C.O.M.	FLIGHT CREW OPERATING MANUAL PRELIMINARY PAGES STANDARD NOMENCLATURE	0.50.00		
		P 5	001	
				JUL 00

AA

GSPD	Ground Speed
GXS	ACW Generator/Service Bus Contactor
HBV	Handling Bleed Valve
HD	Head Down
HDG	Heading
HDLG (HDL)	Handling
HEBTC	Hot Emer Battery Transfer Contactor
HF	High Frequency
HI	High
HLD	Hold
HMBTC	Hot Main Battery Transfer Contactor
HMU	Hydromechanical Unit
HOBV	Handling Overboard Valve
HP	High Pressure
HSI	Horizontal Situation Indicator
HTG	Heating
R HU	Head Up
HYD	Hydraulic
IAF	Initial Approach Fix
IAS	Indicated Air Speed
IDT	Ident
IGN	Ignition
ILS	Instrument Landing System
IMU	Initial Measurement Unit
IN	Inertial Navigation
INC	Increase
IND	Indicator
IN/HG	Inches of Mercury
INHI	Inhibit
INOP	Inoperative
INS	Inertial Navigation System
INST	Instrument
INT	Interphone
INU	Inertial Navigation Unit
INV	Inverter
IRS	Inertial Reference System
ISOL	Isolation
ISV	Isolation Shut-off Valve
ITT	Inter Turbine Temperature
KHZ	Kilo-Hertz
KT	Knot
LAT	Lateral
LAV	Lavatory

AA

LB	Pound
LBA	Lowest Blade Angle
LDG	Landing
L/G	Landing Gear
LH	Left Hand
LIM	Limitation
LNAV	Lateral Navigation
LO	Low
LOC	Localizer
LO-PR	Low Pressure
LP	Low Pressure
LT	Light
LVL	Level
MAC	Mean Aerodynamic Chord
MAN	Manual
MAP	Ground Mapping
MAX	Maximum
MB	Millibar
MBCC	Main Battery Charge Contactor
MBTC	Main Bus Transfer Contactor
MC	Master Caution
MCDU	Multifunction Control Display Unit
MCT	Maximum Continuous
MEA	Minimum En route Altitude
MECH	Mechanic
MFC	Multi Function Computer
MFCU	Mechanical Fuel Control Unit
MGT	Management
MHZ	Megahertz
MIC	Microphone
MIN	Minimum
MISC	Miscellaneous
MKR	Marker
MLS	Microwave Landing System
MLW	Maximum Landing Weight
MM	Millimeter
MMO	Maximum Operating Mach
MOD	Modification
MSG	Messages
MSN	Manufacturer Serial Number
MTOW	Maximum Take off Weight
MW	Master Warning
MZFW	Maximum Zero Fuel Weight
NAC	Nacelle



ATR 72
F.C.O.M.

FLIGHT CREW OPERATING MANUAL

0.50.00

P 7

001

PRELIMINARY PAGES
STANDARD NOMENCLATURE

JUL 99

AA

NAV	Navigation
NDB	Non Directional Beacon
NDB (GPS)	Navigation Data Base
NEG	Negative
NH	High Pressure Spool Rotation Speed
NIL	Nothing, No Object
NL	Low Pressure Spool Rotation Speed
NM	Nautical Mile
NORM	Normal
NP	Propeller Rotation Speed
NPU	Navigation Processor Unit
N/W	Nose Wheel
NWS	Nose Wheel Steering
OAT	Outside Air Temperature
OBS	Omni Bearing Selector
OT	Other traffic
OUTB	Outboard
OVBD	Overboard
OVERTEMP	Overtemperature
OVHT	Overheat
OVRD	Override
OXY	Oxygen
PA	Passenger Address
PB	Push Button
PCU	Propeller Control Unit
PEC	Propeller Electronic Control
PF	Pilot Flying
PFTS	Power Feeder Thermal Sensor
PIU	Propeller Interface Unit
PL	Power Lever
PLA	Power Lever Angle
PNF	Pilot Non Flying
PNL	Panel
POS	Position
PRESS	Pressurization, Pressure
PRIM	Primary
PRKG	Parking
PROC	Procedure
PROP	Propeller
PRV	Pressure Regulating Valve
PSEU	Proximity Switch Electronic Unit
PSI	Pound per Square Inch
PSU	Pax Service Unit
PSV	Propeller Servo Valve
PT	Point
PT (TCAS)	Proximity traffic

AA

PTT	Push To Talk, Push To Test
PTW	Pitch Thumb Wheel
PVM	Propeller Valve Module
PWM	Pulse Width Modulation
PWR	Power
QAR	Quick Access Recorder
QT	Quart
QTY	Quantity
RA (TCAS)	Resolution Advisory
RA	Radio Altitude
RAD/ALT	Radio Altitude
RAD/INT	Radio/Interphone
RAIM	Receiver Autonomous Integrity Monitoring
RCAU	Remote Control Audio Unit
RCDR	Recorder
RCL	Recall
RCU	Releasable Centering Unit
RECIRC	Recirculation
REV	Reverse
RGA	Reserve Go-Around
RGB	Reduction Gear Box
RH	Right Hand
RLY	Relay
RMI	Radio Magnetic Indicator
RNP	Required Navigation Performance
RPM	Revolution Per Minute
RQD	Required
RTO	Reserve Take-Off
RUD	Rudder
SAT	Static Air Temperature
SB	Service Bulletin
SBTC	Stand By bus Transfer Contactor
SBY	Stand By
SC	Single Chime, Starter Contactor
SCU	Signal Conditioning Unit
SDTC	Static Inverter Override Transfer Contactor
SEL	Selector
SGL	Single
SGU	Symbol Generator Unit
SID	Standard Instrument Departure
SMK	Smoke
SMKG	Smoking
S/O (SO)	Shut Off
SOV	Shut Off Valve
SPD	Speed
SPLR	Spoiler



ATR 72
F.C.O.M.

FLIGHT CREW OPERATING MANUAL

0.50.00

P 9

001

PRELIMINARY PAGES
STANDARD NOMENCLATURE

JUL 99

AA

SPLY	Supply
SSR	Service Bus Select Relay
STAB	Stabilizer
STAR	Standard Arrival
STBY	Stand By
STR	Service Bus Transfer Relay
STRG	Steering
SVCE	Service
SW	Switch
SYNPHR	Synchrophaser
SYS	System
TA (TCAS)	TRAFFIC Advisory
TAS	True Air Speed
TAT	Total Air Temperature
TBD	To be Determined
TCS	Touch Control Steering
TEMP	Temperature
TGT	Target
TK	Tank
TLU	Travel Limiting Unit
TM	Torque Motor
T/O (TO)	Take off
TOD	Take-Off Distance
TOR	Take-Off Run
TOW	Take off weight
TQ	Torque
TRU	Transformer Rectifier Unit
TTG	Time To Go
UBC	Utility Bus Contactor
U/F	Underfloor
UHF	Ultra High Frequency
UNCPL	Uncouple
UNDV	Undervoltage
UNLK	Unlock
UTLY	Utility
VC	Calibrated Airspeed
VENT	Ventilation
VERT	Vertical
VHF	Very High Frequency
VMCA	Minimum Control Speed in flight
VMCG	Minimum Control Speed on ground
VMCL	Minimum Control Speed during landing approach
VMO	Maximum Operating Speed
VNAV	Vertical Navigation



ATR 72
F.C.O.M.

FLIGHT CREW OPERATING MANUAL

PRELIMINARY PAGES
STANDARD NOMENCLATURE

0.50.00

P 10







001

JUL 99

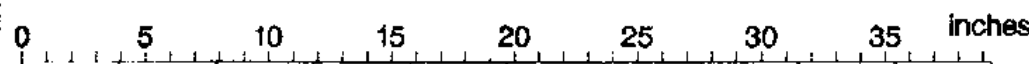
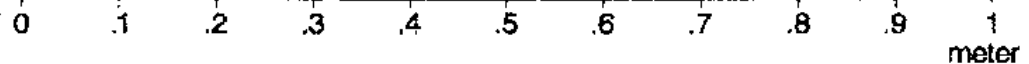
VOR	VHF OMNI Directional Range
VSI	Vertical Speed Indicator
VU	Visual Unit
WARN	Warning
WAT	Weight Altitude Temperature
WBM	Weight and Balance Manual
WOW	Weight On Wheel
XFEED	Cross feed
XFR	Transfer
YD	Yaw Damper
ZA	Aircraft Altitude
ZCTH	Theoretical Cabin Altitude
ZFW	Zero Fuel Weight
ZP	Pressure Altitude
ZRA	Radio Altimeter Altitude

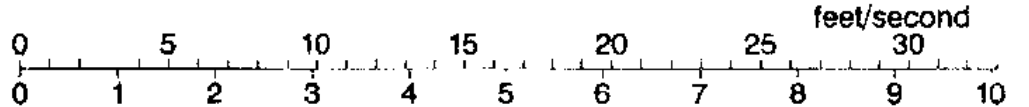
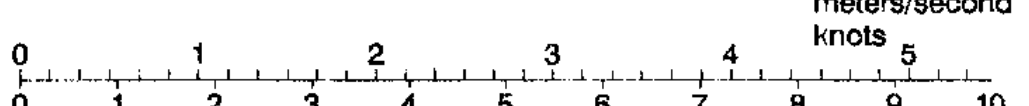
AA

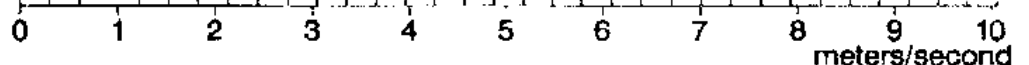
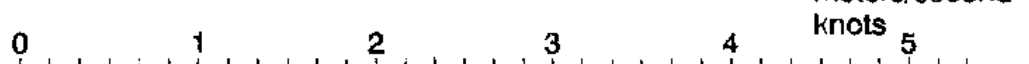
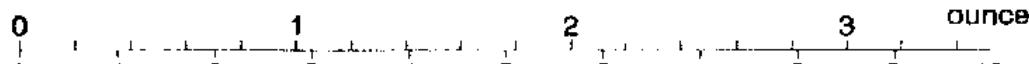
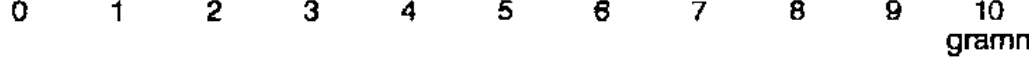
AA

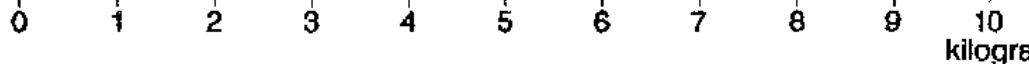
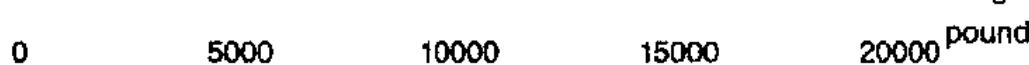
	METRIC → US	US → METRIC
	1 millimeter (mm) = .0394 inch (in) 1 meter (m) = 3.281 feet (ft) 1 meter (m) = 1.094 yard (yd) 1 kilometer (km) = .540 nautical mile (nm)	1 inch (in) = 25.4 millimeters (mm) 1 foot (ft) = .3048 meter (m) 1 yard (yd) = .914 meter (m) 1 nautical mile (nm) = 1.852 kilometer (km)
LENGTH		
		
		
		
		
	1 meter/second (m/s) = 3.281 Feet/second (ft/s) 1 Kilometer/hour(km/h) = .540 knot (kt)	1 foot/second (ft/s) = .3048 meter/second (m/s) 1 knot (kt) = 1.852 kilometer/hour (km/h)
SPEED		
		
		
	1 gramme (g) = 0.0353 ounce (oz) 1 kilogramme = 2.205 pounds (lb) 1 ton (t) = 2.205 pounds (lb)	1 ounce (oz) = 28.35 grammes (g) 1 pound (lb) = .4535 kilogramme (kg) 1 pound (lb) = .0004535 ton (t)
WEIGHT		
		
		
		
		

ROFA-00-00-60-001-A001AA

ROFA-00-00-60-001-B001AA

ROFA-00-00-60-001-C001AA



ATR72
F.C.O.M.

FLIGHT CREW OPERATING MANUAL

PRELIMINARY PAGES
UNITS CONVERSION TABLE

0.60.00

P 2

001

JUL 99

AA

	METRIC → US	US → METRIC
F O R C E	1 Newton (N) = .2248 pound-force (lbf) 1 deca Newton (daN) = 2.248 pound-force (lbf)	1 pound force (lbf) = 4.448 Newtons (N) 1 pound-force (lbf) = .4448 deca Newton (daN)
	ROFA-00-00-60-002-A001AA	
P R E S S U R E	1 bar = 14.505 pound-force per square inch (P.S.I.) 1 millibar (mbar) = .0145 P.S.I.	1 pound-force per square inch (P.S.I.) = .0689 bar 1 P.S.I. = 68.92 millibars (mbar)
	ROFA-00-00-60-002-B001AA	
V O L U M E	1 liter (l) = .2642 U.S. Gallons 1 cubic meter (m ³) = 264.2 U.S. Gallons	1 US Gallon = 3.785 liters (l) 1 US Gallon = .003785 cubic meter (m ³)
	ROFA-00-00-60-002-C001AA	
M O M E N T U M	1 meter x deca Newton (m.daN) = 08.50 pound-force x inch (lbf.in)	1 pound-force x inch (lbf.in) = .0113 meter x deca Newton (mdaN)
	ROFA-00-00-60-002-D001AA	
T E M P E R A T U R E	$t (^{\circ}\text{C}) = \frac{5}{9} (t (^{\circ}\text{F}) - 32)$	$t (^{\circ}\text{F}) = \frac{9}{5} t (^{\circ}\text{C}) + 32$
	ROFA-00-00-60-002-E001AA	

	AIRCRAFT GENERAL		1.00.00	
			P 1	001
	CONTENTS			DEC 96

AA

	1.00.00	CONTENTS
R	1.00.10	GENERAL
	1.00.20	COCKPIT
	1.00.30	DOORS
R	30.1	DESCRIPTION
R	30.2	CONTROLS
R	30.3	ELECTRICAL SUPPLY/MFC LOGIC/SYSTEM MONITORING
	1.00.40	LIGHTING
R	40.1	DESCRIPTION
R	40.2	CONTROLS
R	40.3	ELECTRICAL SUPPLY/MFC LOGIC
	1.00.50	WATER AND WASTE SYSTEM
R	50.1	DESCRIPTION
R	50.2	ELECTRICAL SUPPLY

AIRCRAFT DIMENSIONS AND GROUND CLEARANCES

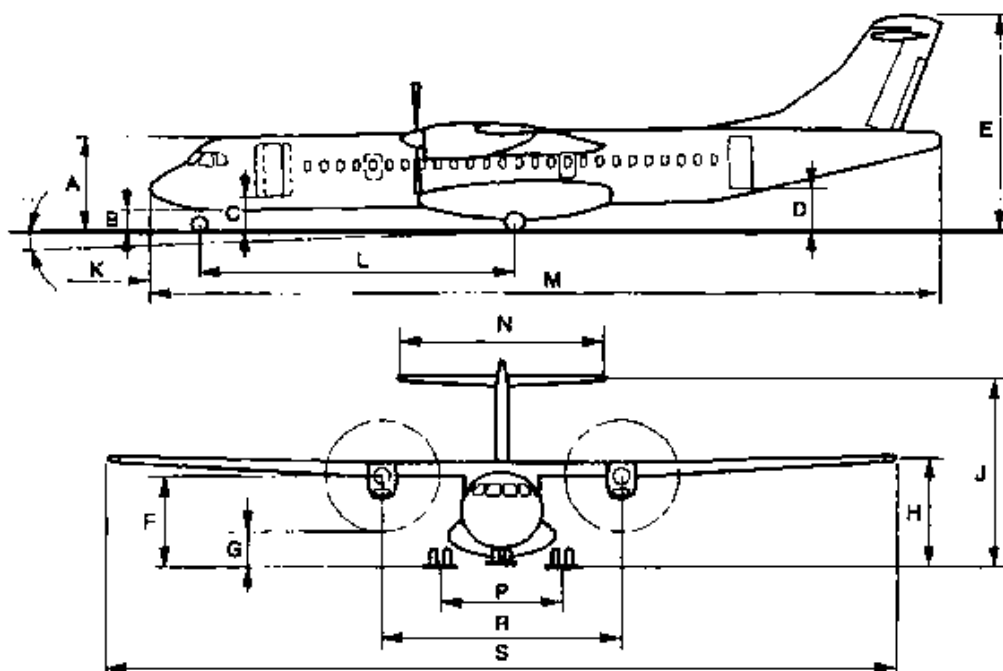

80FA-01-00-10-001-8001AA

VERTICAL CLEARANCES (A → J)						
	OPERATING EMPTY WEIGHT		MAXIMUM RAMP WEIGHT			
	CG 25%		CG 14%		CG 37%	
	ft	m	ft	m	ft	m
A	10.80	3.29	10.43	3.18	10.73	3.27
B	2.16	0.66	1.77	0.54	2.06	0.63
C	4.00	1.22	3.61	1.10	3.90	1.19
D	4.88	1.49	4.66	1.42	4.40	1.34
E	25.33	7.72	25.16	7.67	24.67	7.52
F	10.46	3.19	10.13	3.09	10.23	3.12
G	3.97	1.21	3.64	1.11	3.74	1.14
H	12.50	3.81	12.20	3.72	12.17	3.71
J	22.87	6.97	22.70	6.92	22.24	6.78
α	-1°011		-1°183		-0°550	
K	5 Ft 6.3 in.				1.683 m	
L	35 Ft 4.8 in.				10.79 m	
M	89 Ft 1.5 in.				27.166 m	
N	23 Ft 11.8 in.				7.31 m	
P	13 Ft 5.4 in.				4.100 m	
R	26 Ft 6.9 in.				8.100 m	
S	88 Ft 9 in.				27.050 m	

TURNING CAPABILITY ON GROUND

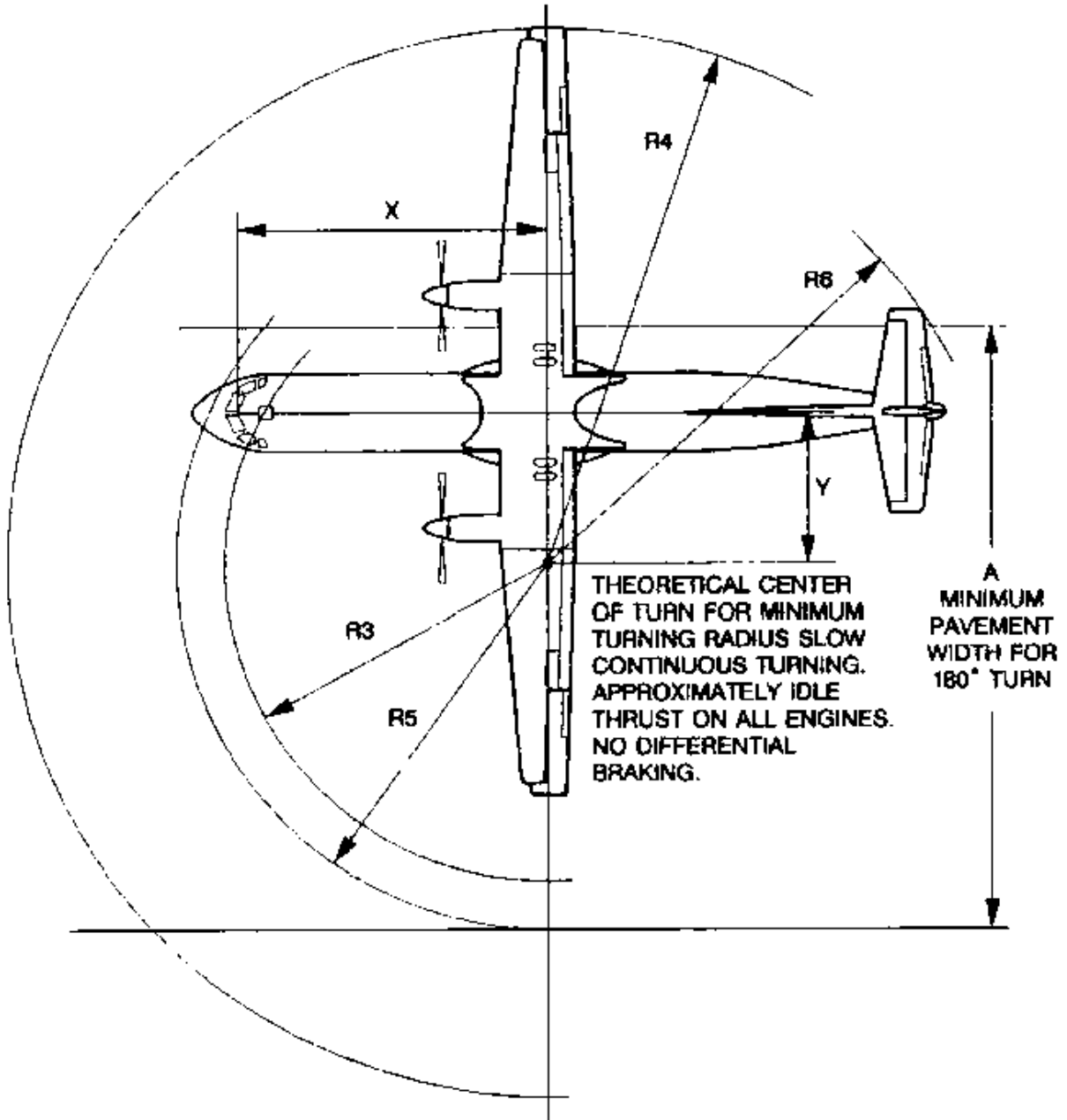

FEET	
INCH	
	METER

TURN-ANGLE	X	Y	A	R3	R4	R5	R6
60°	35Ft 4in.	20Ft 4.5in.	70Ft 2.5in.	40Ft 9.5in.	64Ft 9in.	45Ft 9.5in.	55Ft 10.5in.
	10.77	6.21	21.40	12.43	19.74	13.96	17.03



AR72
F.C.O.M.

AIRCRAFT GENERAL

GENERAL

1.00.10

P 3

001

DEC 96

AA

CABIN CROSS SECTION

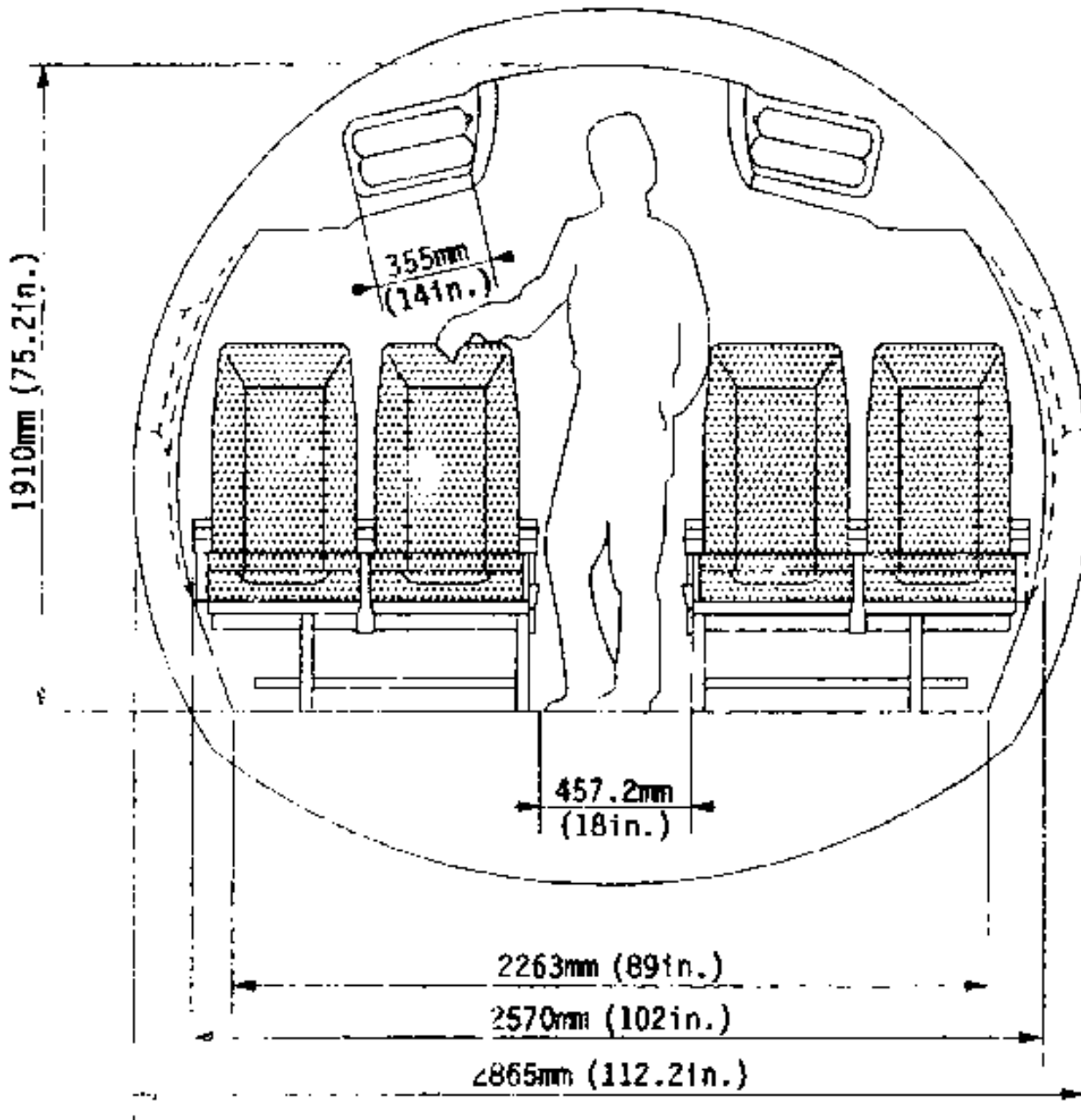

RO. 1.00.10-0 3-4001AA

 AFR 72 F.C.O.M.	AIRCRAFT GENERAL		1.00.10	
			P 4	001
	GENERAL		DEC 96	

AA

LOCATION OF THE TAIL PROP

On ground during passengers boarding/desembarquing, the tail prop must be installed on the tail skid to avoid a possible pulling-up.

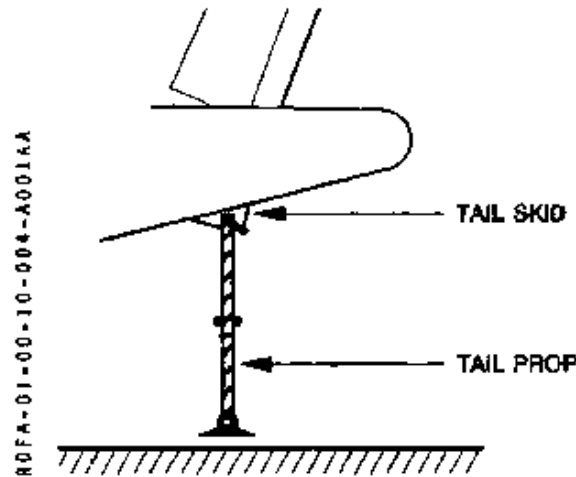

Note : When not used, the tail prop is stored in the rear unpressurized area of the aircraft (beyond the aft bulkhead).

TAIL BUMPER

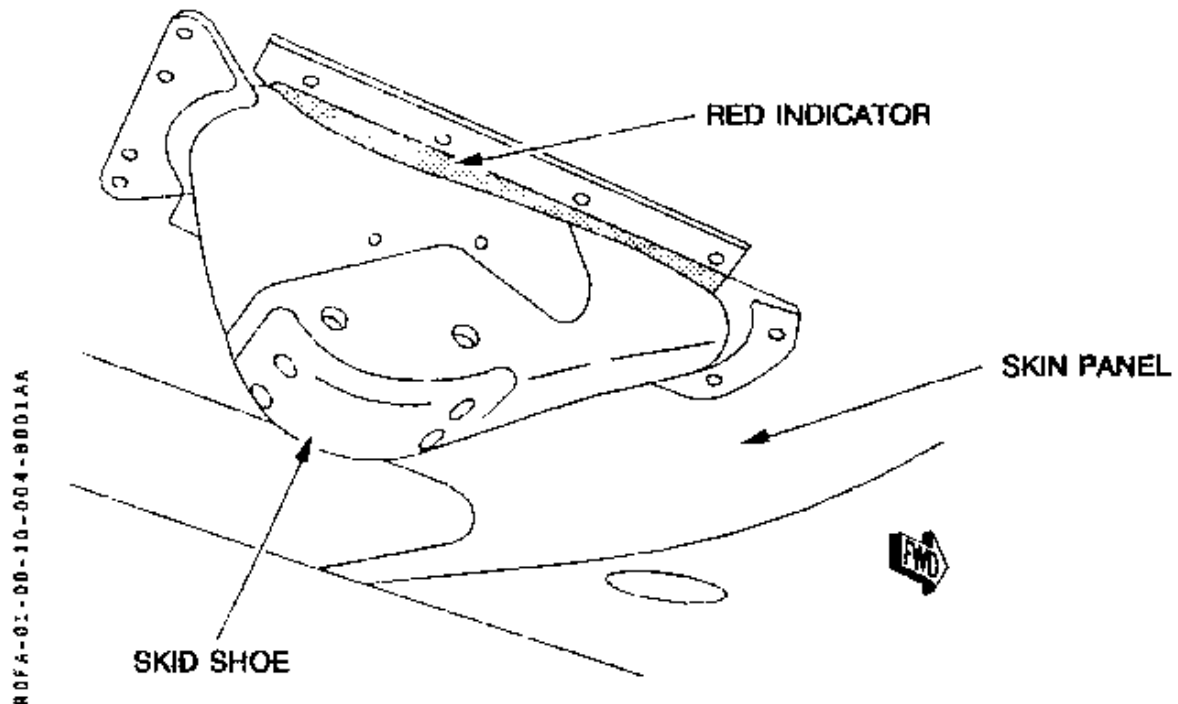

At each walk ground, inspect skid shoe :

If it is stripped, check the red indicator :

- If this indicator does not show evidence of wear, aircraft can be flown.
- If this indicator shows evidence of wear, maintenance action is required.

AA

R LOCATION OF ANTENNAE

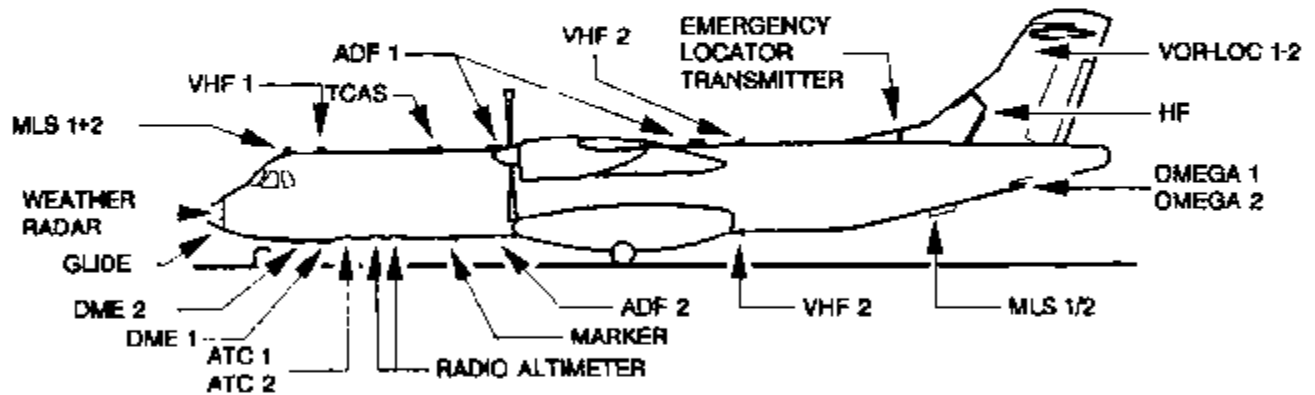

ROFA-01-00-10-005-A001AA

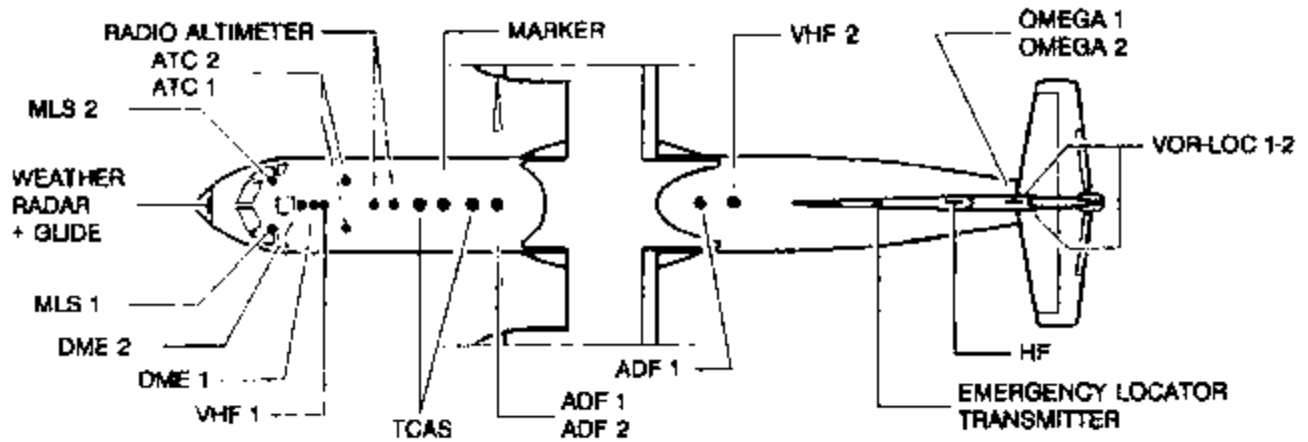

Note : Number and location of antennae may change depending on the versions. All possibilities are drawn on these views.

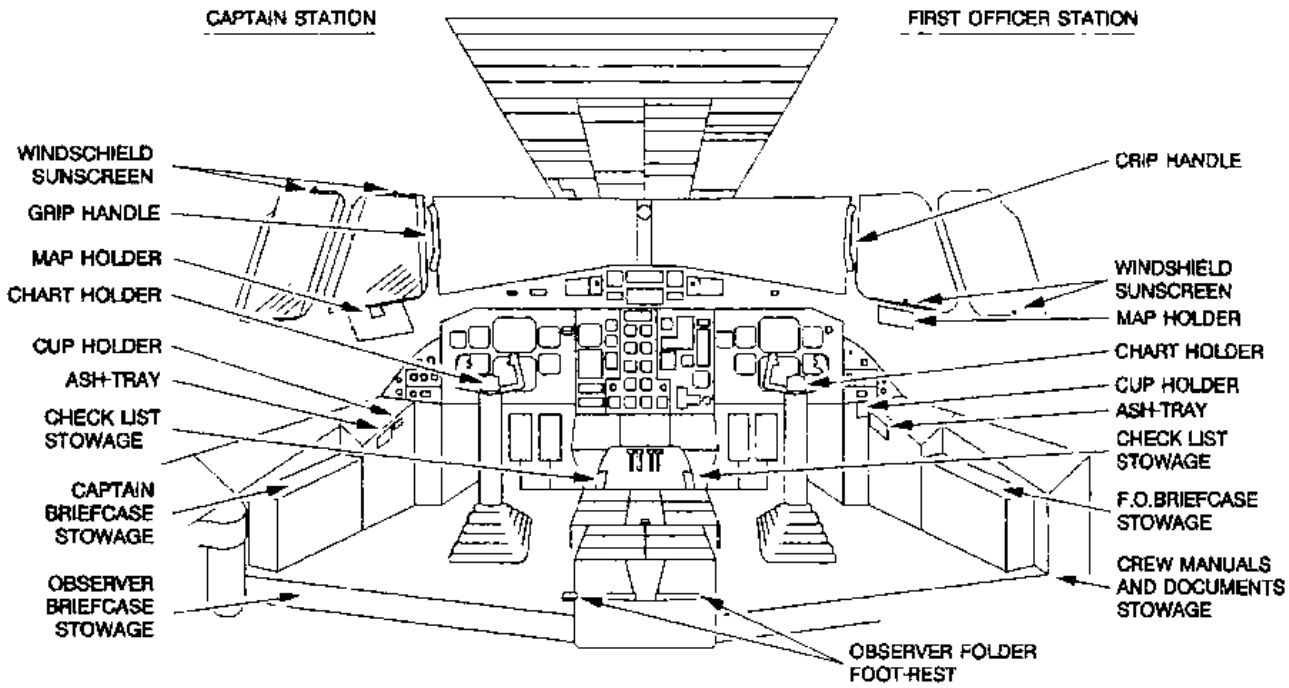

GENERAL
 For comfort, convenience and safety, various furnishings are fitted in the cockpit.

 ATR 72 F.C.O.M.	AIRCRAFT GENERAL	
	COCKPIT	
	P 1	1.00.20
	001	
	DEC 96	



AJR72
F.C.O.M.

AIRCRAFT GENERAL

1.00.20

P 2

001

COCKPIT

DEC 96

SEATS

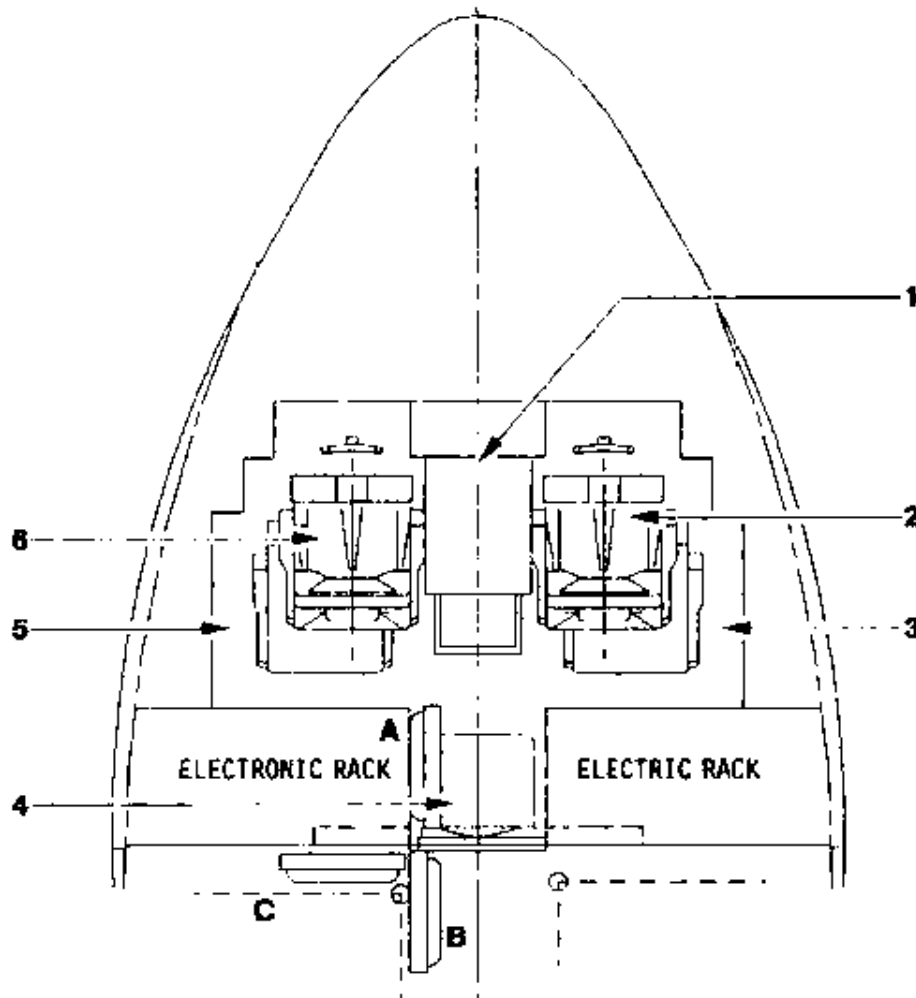

RCFA-01-C0-20-002-A001AA

- 1 - CENTER PEDESTAL
- 2 - F/O SEAT
- 3 - RH SIDE CONSOLE
- 4 - OBSERVER SEAT
- 5 - LH SIDE CONSOLE
- 6 - CAPTAIN SEAT

R CAPT and F/O seats are mounted each on a base secured to the floor on each side
R of the center pedestal. They are mechanically adjustable along the three axes for individual comfort. They are equipped with adjustable folding armrests.

R The observer seat is located behind the pedestal and between electronic and electric racks. When not in use, the observer seat can be stowed facing the electronic rack (position A), in the cargo compartment (position B) allowing the observer to move in the cabin, or transversely along the electronic rack (position C).

Safety pins enable the observer seat to be rocked backward in order to facilitate emergency evacuation in case of jamming.

The three seats are equipped with full harness including an inertial reel with locking handle for the shoulder harness.

	AIRCRAFT GENERAL		1.00.20	
			P 3	001
	COCKPIT		DEC 96	

CAPT/F/O SEATS

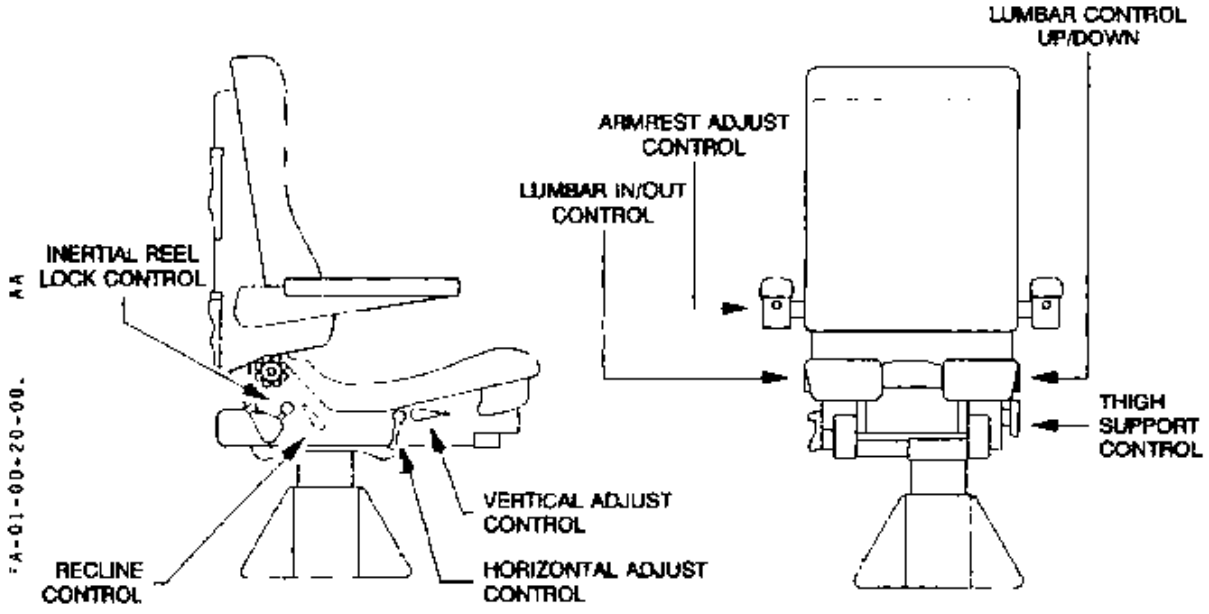

PASSENGER SEAT

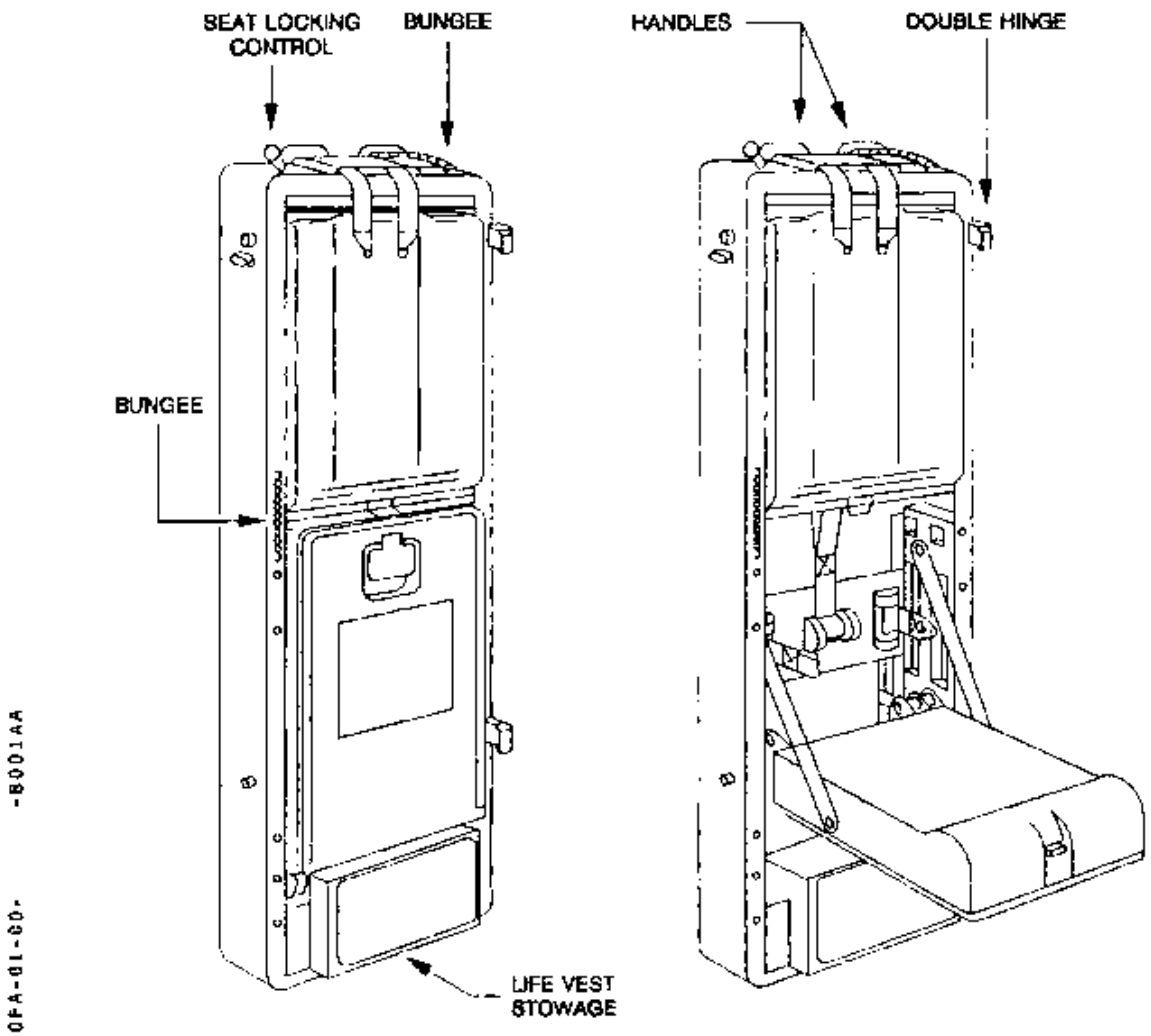

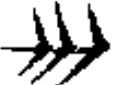
 ATR 72 F.C.O.M.	AIRCRAFT GENERAL COCKPIT	1.00.20		
		P 4	001	
				DEC 96

AA

COCKPIT PHILOSOPHY

Status and failure indications are integrated in the pushbuttons. Pb positions and illuminated indications are based on a general concept with the "light out" condition for normal continuous operation according to the basic rule.

With few exceptions, the light illuminates to indicate a failure or an abnormal condition. Whenever possible, the failure alert is integrated in the pb which has to be operated for corrective action.

PUSH-BUTTONS POSITION	BASIC FUNCTION
IN (DEPRESSED)	ON, AUTO, NORM
OUT (RELEASED)	OFF, MAN, ALTN, SHUT

COLOR	INDICATION
No light illuminated except flow bars	Normal basic operation
BLUE	Temporarily required system in normal operation
GREEN	Back up or alternate system selected
WHITE	Selection other than normal basic operation
AMBER	Caution indication
RED	Warning indication

	AIRCRAFT GENERAL DOORS	1.00.30		
		P 1	160	
				JUN 97

30.1 DESCRIPTION

LOCATION

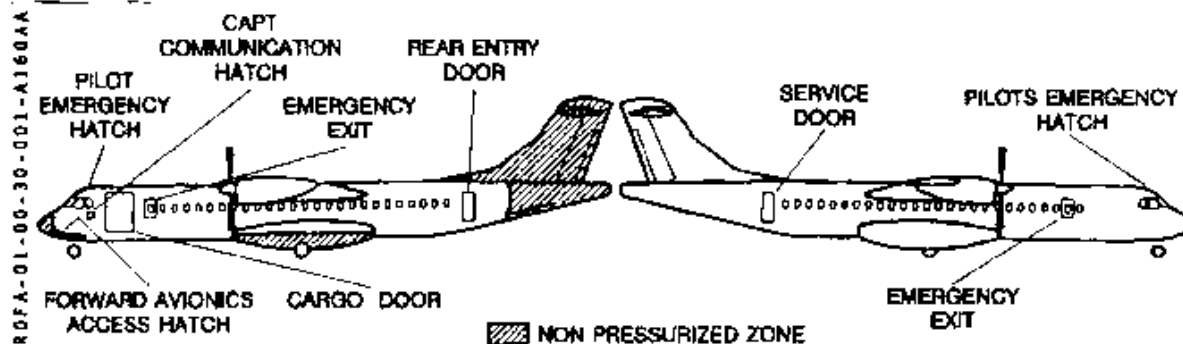

ENTRY DOOR

The entry door is an outward opening, non plug type door with a net opening of 72 cm (28.5") wide (without hand-rail(s)) and 1.75 m (68.8") high.

The mechanism is essentially composed of two handles, a lifting cam and locking shoot bolts placed on the rear part of the door (for door operating, refer to 1.07.30). Attached to the integrated stair structure are folding hand-rails which, by means of a link to the fuselage structure automatically erect when the door is opened.

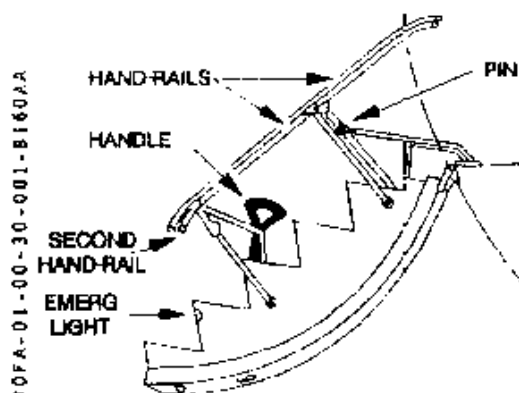

Note: Remove the pin after closing and install it before opening.

SERVICE DOOR

The service door is an outward opening, non plug type door with a net opening of 69 cm (27") wide and 1.27 m (50") high.

Opened position is forward. Door operation can be performed manually from inside or outside of the airplane (refer to 1.07.30).

INTERNAL DOORS

A forward opening hinged door separates the forward cargo compartment and the passenger compartment. A latch operated by a knob on the cabin side and a safety key from the cargo side is provided. In case of emergency it can be forced opened in either direction.

Smoke doors separate the forward cargo compartment from the cockpit. Four safety pins are provided (two on each side) in order to remove the doors in case of emergency.

 AFR 72 F.C.O.M.	AIRCRAFT GENERAL		1.00.30	
	DOORS		P 2	110
			JUN 97	

CARGO DOOR

The cargo door is an outward opening, non plug type door hinged at its upper edge giving a net clear opening of 1.30 m (51") wide by 1.57 m (62") high.

The door is actuated by an electrical actuator.

A hold-open strut maintains the cargo door in the open position. It also protects the door from wind gusts.

ROFA-01-00-30-002-A110AA

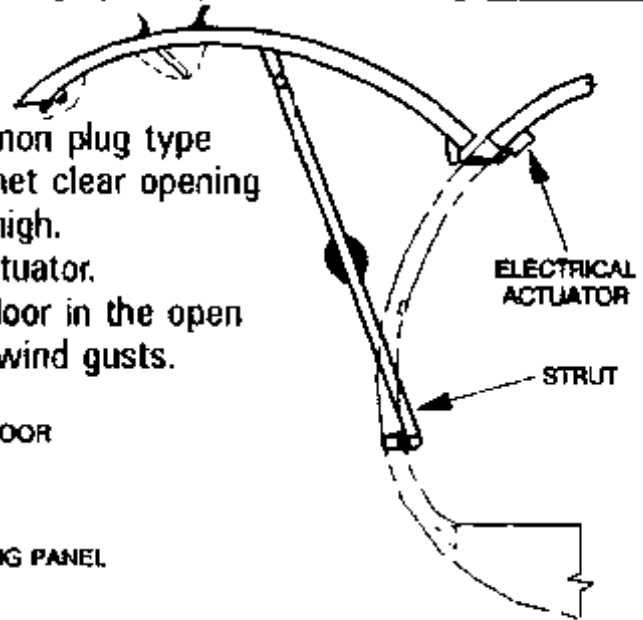
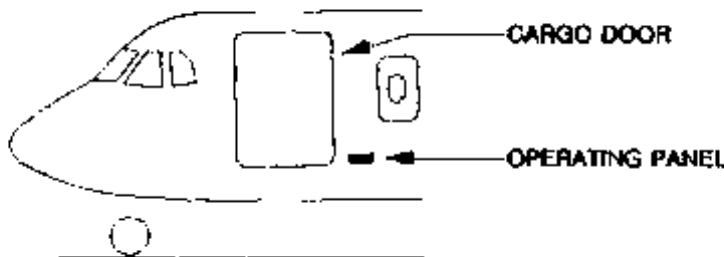



ELECTRICAL OPERATING

The cargo door is unlocked by two levers and operated from a panel located outside.

Operating Panel

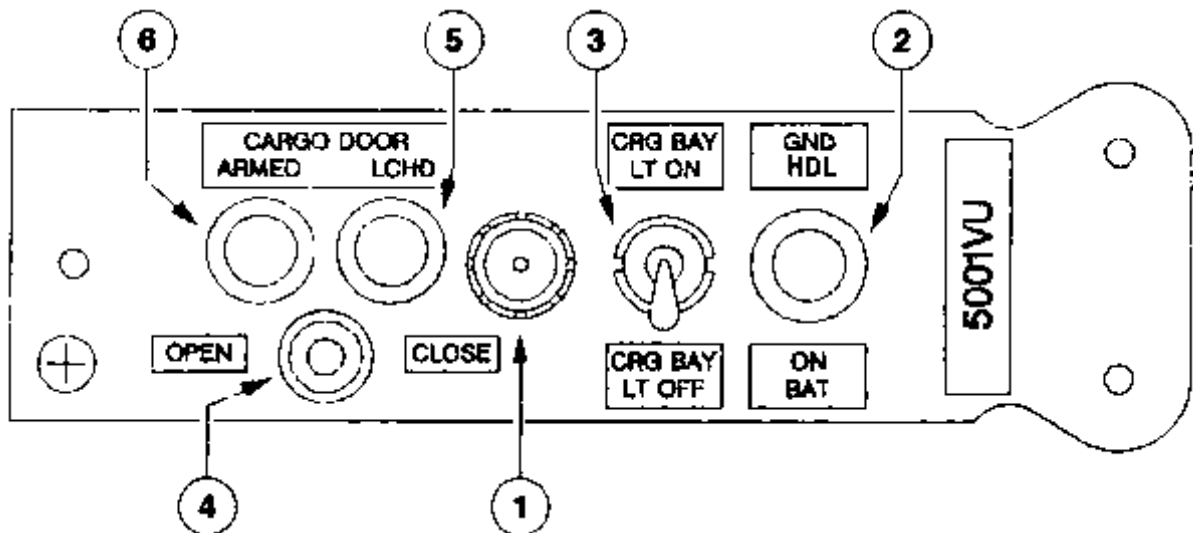
ROFA-01-00-30-002-8110AB



	AIRCRAFT GENERAL DOORS	1.00.30		
		P 3	110	
				JUN 97

① Panel cover switch

Connects the Ground Handling Bus on line when the panel cover is opened.

② Ground Handling Bus "ON BAT" red light

Is ON when Ground Handling Bus is directly supplied by Hot main Bat Bus.

Note : This light shows that the main battery is emptying even if the BAT toggle switch is in "OFF" position (visible even when the panel cover is closed).

③ Cargo Bay light switch

Allows activation of the cargo bay light from outside.

④ Actuator Selection Switch

Is used to operate the door (opening or closing) when the "SELECT ARMED" green light is ON.

⑤ "Cargo Door latched" blue light

Is ON when all door hooks and latch locks are fully engaged.

⑥ "Selector Armed" green light

Is ON when Actuator Selection Switch working conditions are met.

These conditions are

- Panel cover opened
- Door unlocked by operating handle : all hooks are disengaged (and FWD latchlock is unfastened).

 ATR 72 F.C.O.M.	AIRCRAFT GENERAL DOORS	1.00.30		
		P 4	100	
				JUN 97

To open cargo door

- Push flap to grasp handle of the upper lever.
- Depress handle and pull the upper lever fully down.
- Pull the lower lever fully down.
- Open flap for access to cargo door control panel (green light illuminates).
- Press selector to **OPEN** until door is completely opened.
- Make sure selector returns to neutral position.
- Lock folding strut.

To close cargo door

- Unlock folding strut.
- Open flap for access to cargo door control panel.
Press selector to **CLOSE** until door is completely closed.
- Fold back the lower lever in its recess.
- Depress handle or the upper lever and fold it back in its recess.
- Make sure blue light is ON (door locked in closed position) selector has returned to neutral position and green light is OFF.

All the lights of the operating panel may be tested by depressing them.

As long as the cargo door is not closed and all hooks engaged, the "CARGO UNLK" light illuminates amber on the cockpit overhead panel.

MANUAL OPERATING

In case of electrical actuator failure, it is possible to open or close the cargo door with a hand crank, introduced in an adjusted shaft drive of the actuator.

FORWARD AVIONICS COMPARTMENT ACCESS HATCH

An inward opening manually operated hatch in the forward section of the nose landing gear bay gives external access to the avionics compartment behind the main instrument panel.

COCKPIT COMMUNICATION HATCH

A machined door with a net opening of 17.5 cm (7") wide and 15 cm (6") high is located immediately below the CAPT side window.

	AIRCRAFT GENERAL	1.00.30		
		P 5	001	
	DOORS			DEC 96

AA

EMERGENCY EXITS

COCKPIT

One plug type hatch located in the cockpit roof is provided as an emergency exit for the flight crew. One escape rope is located in a compartment on top of the electric rack near the exit. Some steps are provided for hatch access in the corridor RH side.

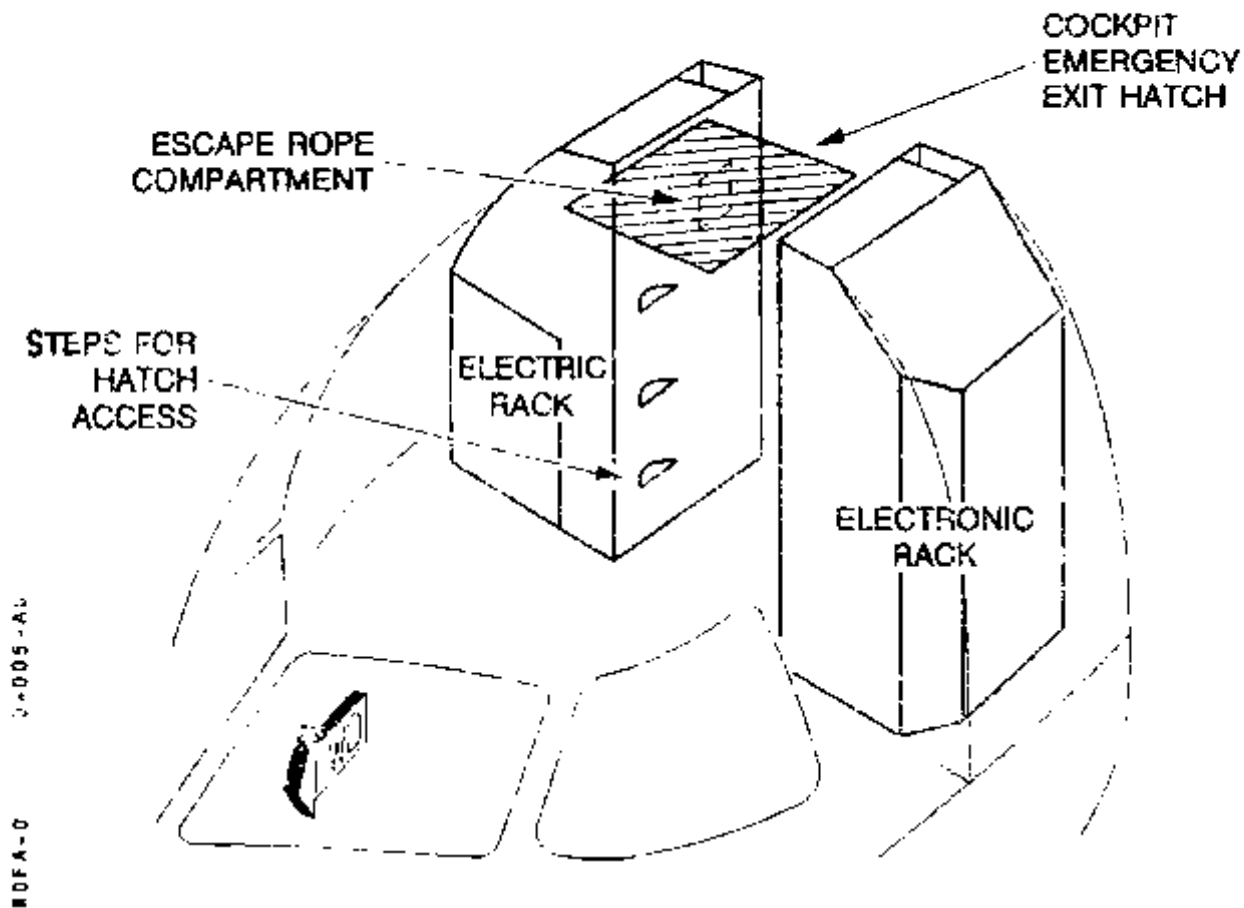

CABIN

In addition to the doors already described, two plug emergency type III exists are provided.

*Note: All emergency exists are operable from inside or outside of the cabin.
See chapter 1.07 for further details.*

 AR72 F.C.O.M.	AIRCRAFT GENERAL	1.00.30		
	DOORS	P 6	100	
			JUN 97	

30.2 CONTROLS

DOORS PANEL

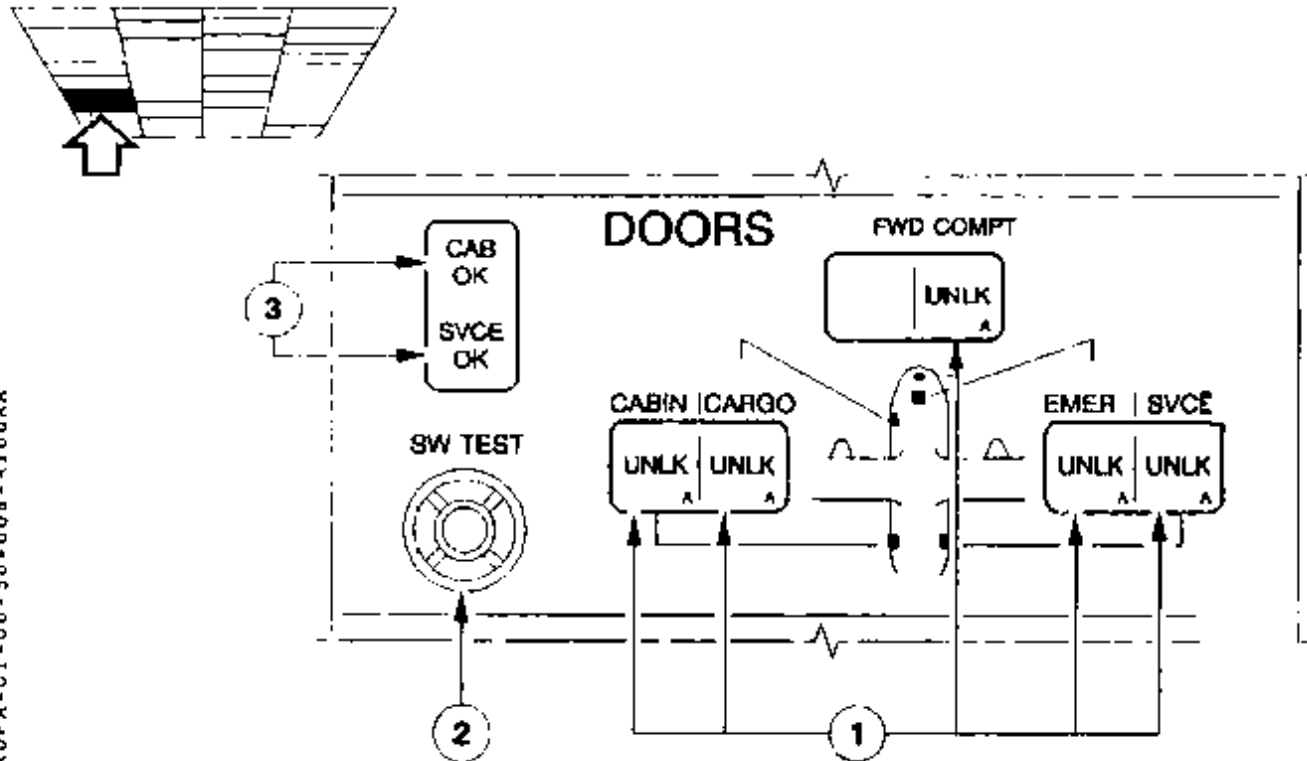

ROFA-01-00-30-005-A100AA

① Doors Alert lights

The light illuminates amber and the CCAS is activated when associated door is not seen locked (one or more micro switches in unlocked position). CARGO, FWD COMPT and EMER doors only are monitored through the MFC.

② Test Pb

Enables to test the microswitches system on cabin door and service door. This test has to be performed on ground, doors open.

③ OK lights

The lights illuminate when depressing test button on ground, only if cabin and service doors are open and if associated microswitches are in unlocked position.

 ATR 72 F.C.O.M.	AIRCRAFT GENERAL DOORS	1.00.30		
		P 7	001	
				JUN 97

30.3 ELECTRICAL SUPPLY/MFC LOGIC/SYSTEM MONITORING

ELECTRICAL SUPPLY

MODEL	EQUIPMENT	DC BUS SUPPLY (C/B)
All	Doors alert	DC BUS 2 (on lateral panel CAUTION)
R 102 or 202 or 212 or 212 A	Cargo door actuator Cargo door actuator control	HOT MAIN BAT BUS (on lateral panel ACTR) GND HDLG XFR BUS (on lateral panel CTL)

MFC LOGIC

See chapter 1.01.

SYSTEM MONITORING

The following condition is monitored by visual and aural alerts :

- Door UNLK in flight
 - See DOOR UNLK IN FLT procedure in chapter 2.05.12.

 AJR 72 F.C.O.M.	AIRCRAFT GENERAL	1.00.40		
	LIGHTING	P 1	100	
				JUN 97

40.1 DESCRIPTION

For aircraft lighting, different systems are installed :

- controlled from the cockpit
 - cockpit lighting
 - cabin signs lighting
 - emergency lighting
 - exterior lighting
- controlled from the cabin attendant panel
 - cabin lighting
 - emergency lighting
 - rear cargo compartment
- controlled from cargo door operating panel
 - FWD cargo compartment

COCKPIT LIGHTING

The cockpit is provided with integral instrument lighting.

For illumination of work surfaces and side consoles, incandescent spot lts and flood lights are installed. The intensity of all instrument and panel lighting can be adjusted. STORM lights located below the glareshield provide an augmentation of the lighting intensity.

As soon as DC NORMAL BUS is supplied, six lights located below the glareshield, and one light on the overhead panel directed to the pedestal illuminate.

The general cockpit illumination is obtained from two dimmable DOME lights.

CABIN SIGNS LIGHTING

"FASTEN SEAT BELTS" cabin signs "RETURN TO SEAT" sign in the toilet and/or "NO SMOKING" cabin signs may be selected. They will be accompanied by a single chime in the cabin.

CABIN AND CARGO LIGHTING

Normal cabin lighting consists of two fluorescent lights rows. In addition a separated lighting is installed into the rear cargo compartment. These lightings are operated from the hostess panel.

The forward cargo bay is lighted from a switch located outside, on the cargo door operating panel.

A switch located RH of the after entrance door provides for 2 min. cockpit lighting and emergency EXIT lights illumination.

An other switch located at the cockpit entrance (40 VU panel) provides the same functions.

 ATR 72 F.C.O.M.	AIRCRAFT GENERAL LIGHTING	1.00.40		
		P 2	001	
				DEC 96

EXTERIOR LIGHTING

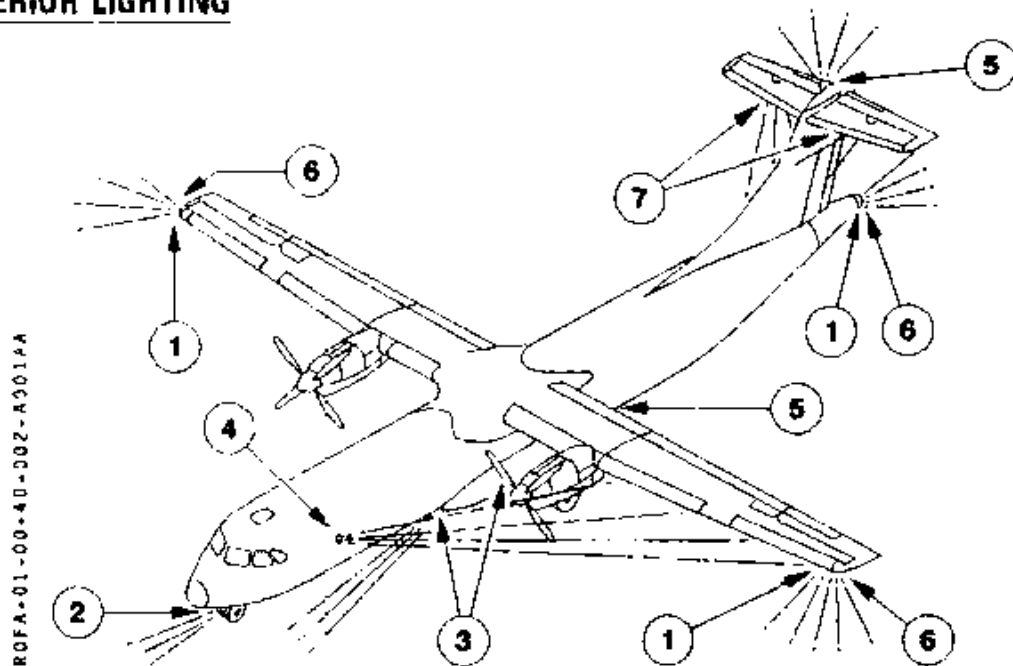

① Navigation lights

Regulatory light are installed on the wing tips (coverage 110°) and on the rear tail cone (coverage 140°).

② Taxi and to lights

Two lights are installed side by side on the nose landing gear leg.

③ Landing lights

Two landing lights are installed laterally in the forward main landing gear fairing bay.

④ Wing lights

Two lights are installed one on each side of the fuselage and are positioned to illuminate the wing leading edges and the engine air intakes in order to allow preventive checking in icing conditions.

⑤ Beacon lights

Two beacon lights are installed :
 one on the top of the vertical stabilizer and one on the bottom of the center fuselage.

⑥ Strobe lights

These lights are installed in each wing tip and in the tail cone. They flash white and are used as supplemental recognition light.

⑦ Logo lights (optional)

Two lights are installed one on each side of the lower surface of the horizontal stabilizer to illuminate the company logo on both sides of the vertical stabilizer.

 ATR 72 F.C.O.M.	AIRCRAFT GENERAL LIGHTING	1.00.40		
		P 3	300	
				JUL 99

AA

EMERGENCY LIGHTING

- "EXIT" EMERGENCY LIGHT
- ⊗ CEILING EMERGENCY LIGHT
- ⌘ EVACUATION PATH MARKING
-  EXTERIOR EMER. LIGHT

90FA-01-00-40-003-A200A4

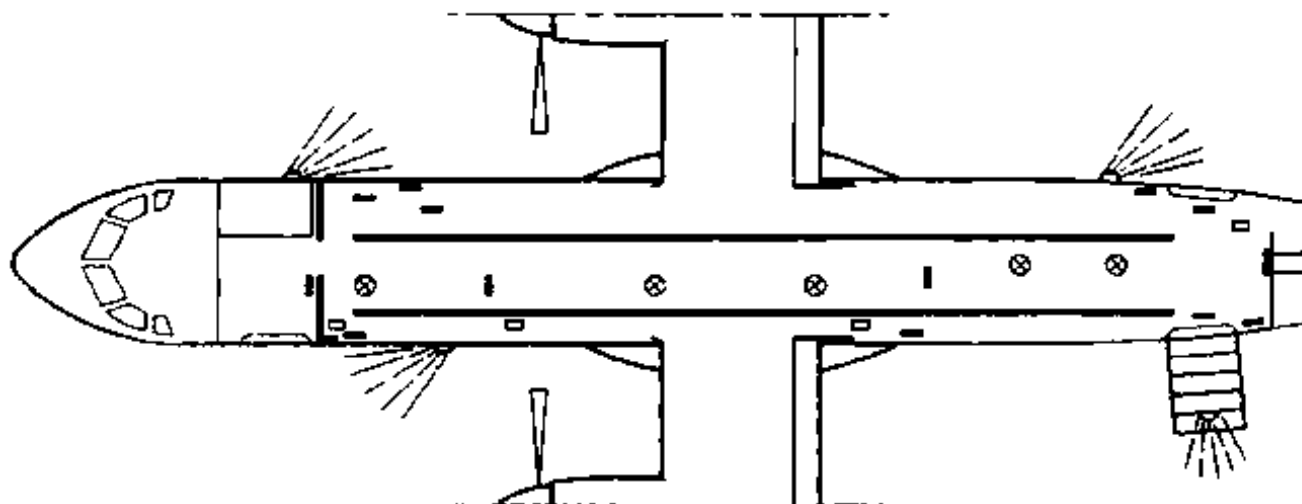

Emergency evacuation path marking near the floor is a photoluminescent system. EXIT, CEILING and EXTERIOR emergency lights are supplied with 6V DC. Two sources are available :

- DC STBY BUS via a voltage divider.
- 6V integral batteries charged from the DC STBY BUS with a 10 mn capacity.

In case of system activation, light will be supplied by DC STBY BUS. If this source fails, the batteries will be utilized automatically.

In case of flight with DC STBY BUS only, the cockpit lighting is restricted to :

- RH DOME light with the possibility to switch it off
- LH three lights located below the glareshield
- overhead panel light illuminating the pedestal.

One light is provided in the toilet, illuminating when associated door is locked.

Note : *Emergency flash lights are provided (see 1.07).*



AR72
F.C.O.M.

AIRCRAFT GENERAL

LIGHTING

1.00.40

P 4

001

DEC 96

AA

40.2 CONTROLS

EXT LIGHT PANEL

ROFA-01-00-40-006-001AA

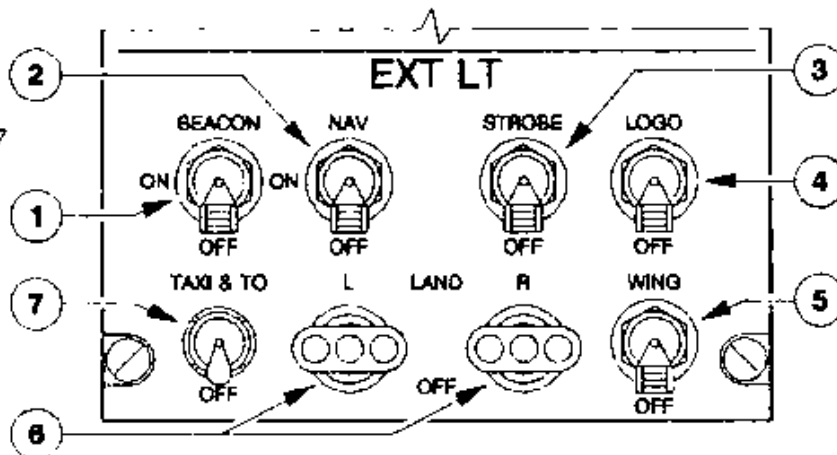

- ① BEACON sw
BEACON Both lights flash
OFF Lights are extinguished
- ② NAV sw
NAV The three navigation lights illuminate steady. Ice evidence probe is enlightened.
OFF Lights are extinguished
- ③ STROBE sw
STROBE Stroboscopic lights flash white
OFF Lights are extinguished
- ④ LOGO sw (when installed)
LOGO Both LOGO lights illuminate steady
OFF Lights are extinguished
- ⑤ WING sw
WING Both lights illuminate steady
OFF Lights are extinguished
- ⑥ L and R LAND sw
Each landing light (L and R) is controlled by an individual switch
LAND Associated light illuminates steady
OFF Associated light is extinguished
- ⑦ TAXI & T. O. sw
TAXI Both TAXI lights illuminate steady
OFF Lights are extinguished

MIN CAB LT SWITCH

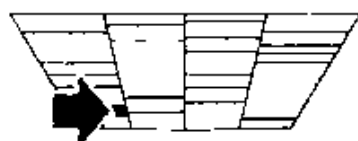

**MIN CAB
LT**



ROFA-01-00-40-006-001AA

Enables to control the minimum cabin lights powered by the main battery.
On the RH side of the cabin only, every second light is illuminated.

 A320 F.C.O.M.	AIRCRAFT GENERAL LIGHTING	1.00.40		
		P 5	001	
				DEC 96

SIGNS PANEL

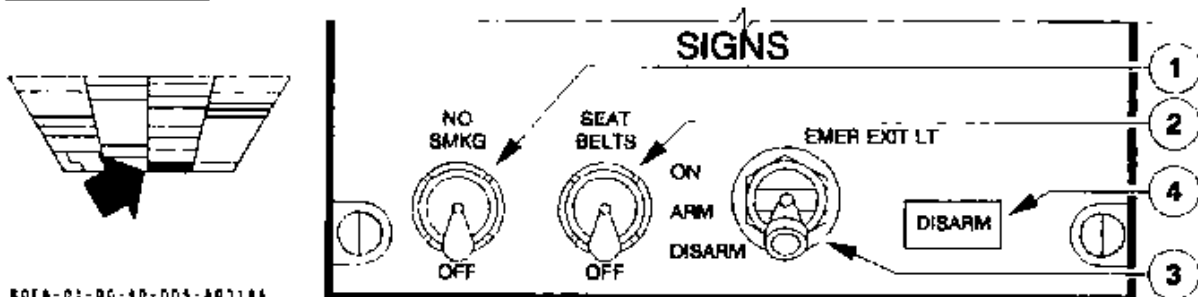

ROFA-01-00-40-005-A001AA

① NO SMOKING sw

NO SMKG Associated signs come on in the cabin, associated with a single chime. The "NO SMOKING" light illuminates blue in the memo panel.
OFF Associated signs and memo panel light are extinguished.

② SEAT BELTS sw

SEAT BELTS "FASTEN SEAT BELTS" signs in the cabin and "RETURN TO SEAT" sign in the toilet come on associated with a single chime upon illumination. The "SEAT BELTS" light illuminates blue in the memo panel.
OFF Associated signs and cockpit light are extinguished.

Note : When switching off "NO SMOKING" or "SEAT BELTS" signs, single chime sounds in cabin.

③ EMER EXIT LIGHT selector

R **ON** Emergency lights illuminate.
R **ARM** Normal selector position in operation. Emergency lights will :
R - Illuminate if DC STBY BUS voltage is below 18V or if the two
R generators are lost.
R - Extinguish if DC STBY BUS voltage is over 20V and at least one
R generator running.
R **DISARM** Normal selector position with engines stopped. Emergency light
R system is deactivated.

Note : Cabin attendant's EMER LIGHT sw will override the ARM and DISARM positions of the selector.

④ DISARM light

R Illuminates amber when the emergency light system is deactivated.

MEMO PANEL



ROFA-01-00-40-005-B001AA

Light illuminate blue when associated switch is selected ON.

 A320 F.C.O.M.	AIRCRAFT GENERAL		1.00.40		
			P 6	001	
	LIGHTING				DEC 96

LT PANEL

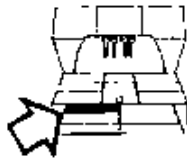

ROFA-01-00-40-006-A001AA

① INST rotary selector

Selects activation and intensity of main panel instrument integral lighting.

② DSPL knob

Selects activation and intensity of all digit lighting.

③ PNL rotary selector

Selects activation and intensity of glareshield, pedestal and overhead panels instrument integral lighting.

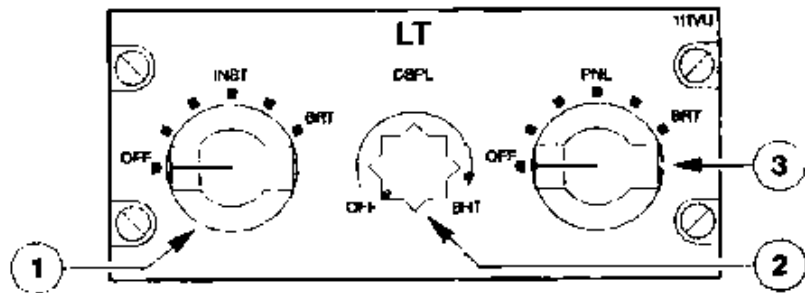

ANN LT PANEL



ROFA-01-00-40-006-B001AA

① ANN LT sw

Allows to check and to control the intensity of :

- the annunciator lights on the overhead and pedestal panels
- the overhead panel flow bars.

TEST : All the associated lights come on bright

BRT : Associate light, when selected, illuminate bright

DIM : Associated light, when selected, are dimmed.



LT and FCOR PANEL



ROFA-01-00-40-006-C001AA

① FLOOD knob

Selects activation and intensity of pedestal panel flood lighting.

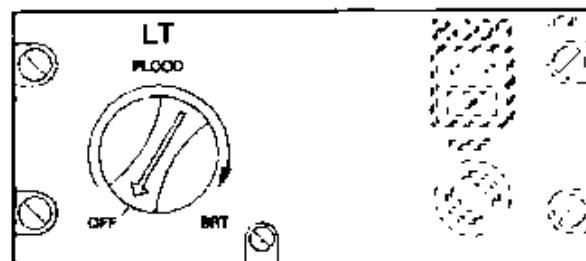

	AIRCRAFT GENERAL	1.00.40		
		P 7	001	
	LIGHTING			DEC 96

SIDE PANEL

R0FA-01-00-40-007-ADD1AA

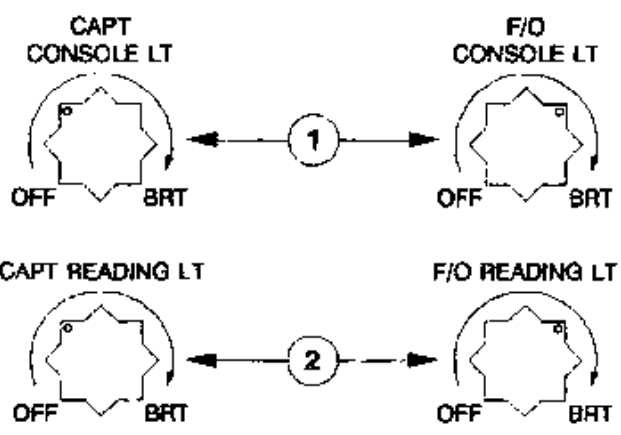
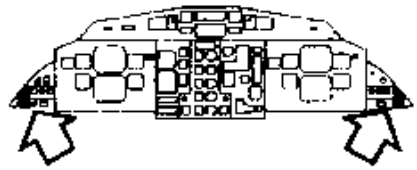

① CONSOLE LT knob

CONSOLE	The light above the associated lateral console is ON.
OFF	Light is extinguished.

② READING LT knob

Selects activation and intensity of the respective spot light.

FLT COMPT LT PANEL

R0FA-01-00-40-007-8001AA

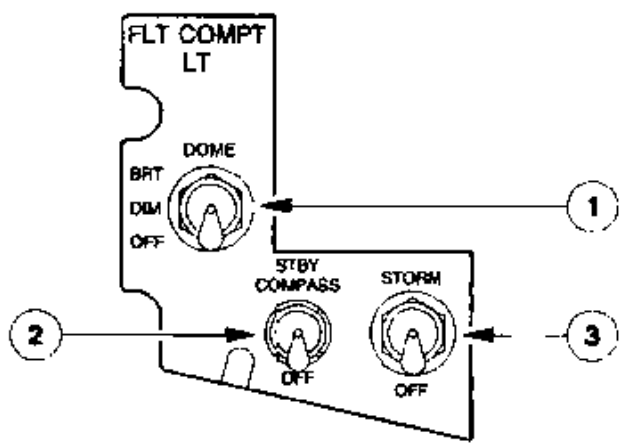

① DOME sw

BRT	Dome lights are supplied with maximum intensity
DIM	Dome lights are dimmed
OFF	Both dome lights are OFF

② STBY COMPASS sw

STBY COMPASS	Integral lighting of standby compass comes ON
OFF	Lighting is OFF

③ STORM sw

STORM	Flood lights are ON with maximum intensity and fluorescent tubes are ON
OFF	Flood lights are ON and fluorescent tubes are OFF

	AIRCRAFT GENERAL		1.00.40		
			P 8	050	
	LIGHTING				JUL 99

AA

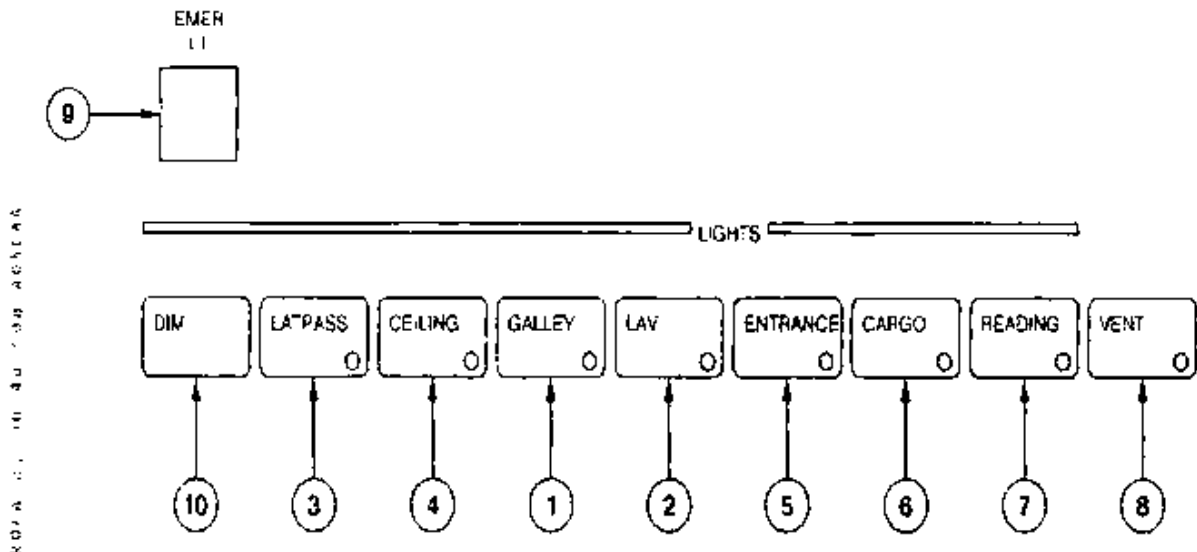
HOSTESS PANEL

- ① Galley sw (when installed)
Monitor galley lighting.
- ② LAV sw
Monitor lavatory lighting. A diffuser switches ON when lavatory latch is closed.
- ③ LAT PASS sw
Monitor lateral passengers lighting.
- ④ CEILING LT SW
Monitor the passengers ceiling lighting.
- ⑤ ENTRANCE sw
Monitor entrance lighting.
- ⑥ CARGO sw
Monitor cargo lighting.
- ⑦ READING LT sw
When depressed passenger reading lights are operational.
- ⑧ VENT sw (when installed)
When depressed, passenger ventilation fan operates.
- ⑨ EMER LT sw
Controls emergency exit light and evacuation path marking causing emergency lights to illuminate (overriding crew switching).
- ⑩ DIM LT sw
Associated light, when selected, are dimmed.

	AIRCRAFT GENERAL	1.00.40	
		P 9	001
	LIGHTING		DEC 96

40.3 ELECTRICAL SUPPLY/MFC LOGIC

ELECTRICAL SUPPLY

EQUIPMENT	DC BUS SUPPLY (C/B)	AC BUS SUPPLY (C/B)
EXTERIOR		
Beacon lights	. DC SVCE BUS (on lateral panel NORM)	- Nil -
Navigation lights	. DC BUS 1 (on lateral panel ALTN) . DC SVCE BUS (on lateral panel NORM) . DC BUS 1 (on lateral panel ALTN)	- Nil -
Wing lights	. DC BUS 2 (on lateral panel WING)	- Nil -
Logo lights (when installed)	. DC SVCE BUS (on lateral panel LOGO)	- Nil -
Landing lights	- Nil -	. ACW BUS 1 (on lateral panel) . ACW BUS 2 (on lateral panel) . ACW BUS 2 (on lateral panel TAXI and TO)
Taxi and Take off lights	DC BUS 2	. ACW BUS 1 (on lateral panel L and RCPR) . ACW BUS 2 (on lateral panel R)
Strobe lights	- Nil -	
SIGNS		
Seat belts - No smoking	DC BUS 2 (on lateral panel SEAT BELT NO SMOKING)	- Nil -
Emergency exit lights	DC STBY BUS (on lateral panel STBY EXIT LIGHT)	- Nil -
Service plugs	. DC SVCE BUS (on lateral panel 28VDC)	ACW SVCE BUS (on lateral panel 115RAC)
COCKPIT		
Capt normal light	DC BUS 1 (on lateral panel NORM)	- Nil -
F/O normal light	DC BUS 2 (on lateral panel NORM)	- Nil -
Emergency light	DC EMER BUS (on lateral panel EMER)	- Nil -
Inst panel normal lights	- Nil -	ACW BUS 1 (on lateral panel NORM SPLY)
Inst panel emergency lighting	- Nil -	AC STBY BUS (on lateral panel EMER SPLY)

	AIRCRAFT GENERAL	1.00.40	
		P 10	001
	LIGHTING		DEC 96

EQUIPMENT	DC BUS SUPPLY (C/B)	AC BUS SUPPLY (C/B)
Inst panel normal lighting control	DC BUS 2 (on lateral panel NORM INST PNL SPLY CTL)	- Nil -
Integrated engine indicator lighting	DC BUS (on lateral panel M30 DSPL)	- Nil -
Annunciator light test	DC BUS 1 (on lateral panel ANN LT TEST)	- Nil -
COMPARTMENT		
Forward and aft cargo	DC SVCE BUS (on lateral panel FWD and AFT CARGO)	- Nil -
Wheels and aft elec compt.	DC SVCE BUS (on lateral panel WHEEL and AFT ELEC)	- Nil -
PASSENGER		
Lateral left	DC BUS 1 (on lateral panel DC BUS 1) DC SVCE BUS (on lateral panel DC SVCE BUS)	- Nil -
MIN cab light	DC ESS BUS (on lateral panel)	- Nil -
Lateral right	DC BUS 2 (on lateral panel DC BUS 2) DC SVCE BUS (on lateral panel DC SVCE BUS) (on lateral panel DC SVCE BUS)	- Nil -
Upper	DC UTLY BUS 1 (on lateral panel) DC UTLY BUS 2 (on lateral panel)	- Nil -
Reading light	- Nil -	ACW BUS 1 (on lateral panel L) ACW BUS 2 (on lateral panel R)
Lavatory light	DC SVCE BUS (on lateral panel LAV LT)	- Nil -

MFC LOGIC

See chapter 1.01.

	AIRCRAFT GENERAL	1.00.50		
	WATER AND WASTE SYSTEM	P 1	030	
				DEC 96

50.1 DESCRIPTION

The aircraft is equipped with a potable water system and a waste disposal system. The potable water system supplies fresh water for the lavatory wash basin. A waste disposal system provides adequate waste capability.

POTABLE WATER SYSTEM

Fresh water for the toilet is stored in a tank located in the pressurized section of the fuselage. The fresh water tank is filled from the fresh water service panel located at the bottom of the rear fuselage. The water system is easily and completely drainable by gravity.

WASTE DISPOSAL SYSTEM

The toilet flushing is obtained from a motorized pump filter unit. The flushing cycle is automatically controlled by an electrical timer. Draining, flushing and charging of the tank is accomplished at the toilet service panel, located underneath the rear fuselage.

50.2 ELECTRICAL SUPPLY

EQUIPMENT	DC BUS SUPPLY	AC BUS SUPPLY
Lavatory flush motor	DC SVCE BUS (on lateral panel FLUSH MOTOR)	- Nil -

	MFC CONTENTS	1.01.00		
		P 1	001	
				DEC 96

AA

R	1.01.00	CONTENTS
R		
R	1.01.10	GENERAL
R		
R	10.1	DESCRIPTION
R		
R	10.2	CONTROLS
R		
R	10.3	OPERATION
R		
R	10.4	ELECTRICAL SUPPLY/SYSTEM MONITORING
R		
R	10.5	LATERAL MAINTENANCE PANEL
R		
R	10.6	SCHEMATIC

 ATR 72 F.C.O.M.	MFC	1.01.10		
	GENERAL	P 1	001	
				DEC 96

10.1 DESCRIPTION (See schematic p 17/18)

On the ATR 72, numerous logic functions are performed by the MFC system. It consists of two independent computers (MFC 1 and MFC 2).

Each computer includes two independent modules (A and B).

Each module includes :

- a 28 VDC dual power supply.
- an input/output circuit.
- a computation unit.
- for modules 1A and 2A only, a hard-wired logic independent of the computation unit.

SIGNAL PROCESSING

Each module receives signals from the various systems and systems controls.

Each signal received by a module is then converted, if necessary, to a digital signal by the input circuit.

Then :

- R - for most of the functions, the signal is sent to the computation unit which processes the data according to the logic programmes.
- R - for some specific functions (stick pusher, flaps), signal processing is performed in a conventional way by the hard-wired card (to avoid computation errors or common failures).

An intercard dialogue is established between all modules to allow each module to use signals processed by other modules.

Signals from each system are taken into account by one or more modules depending on the degree of reliability/safety required for the system.

Each module is equipped with a self test system which monitor correct operation of that module.

FUNCTIONS

After processing, computation unit transmits orders from the output circuit to the various systems in order to :

- monitor, control and authorize operation of the aircraft systems.
- manage system failures and flight envelope anomalies and command triggering of associated warnings in the CCAS.

	MFC	1.01.10	
	GENERAL	P 2	001

AA

10.2 CONTROLS

CONTROL PANEL

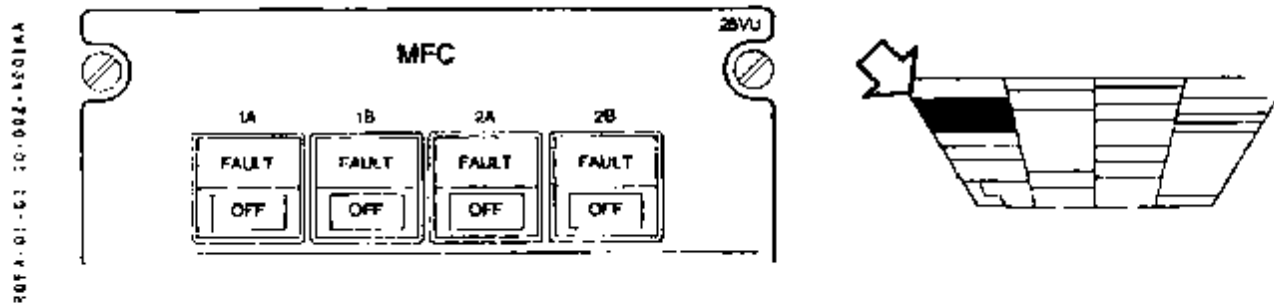

Controls operation of associated module

- R ON** : (pushbutton pressed in) the module operates.
- OFF** : (pushbutton released) the module stops operating.
The OFF white indicator light comes on.
- FAULT** : The amber light comes on and the CCAS is activated when a malfunction or electrical supply fault is detected.
The module automatically becomes inoperative.
This light also flashes during self-test of the module.
- During powering, since all four modules are selected ON, the following sequence is executed :
- MFC 1A and MFC 2A FAULT lights (self-test of these modules) flashing.
- MFC 1A and MFC 2A FAULT lights extinguish. MFC 1B and MFC 2B FAULT lights (self-test of these modules) flashing.
- MFC 1B and MFC 2B FAULT lights extinguish.

	MFC	1.01.10		
	GENERAL	P 3	001	
				DEC 96

10.3 OPERATION

Charts on the following pages list the implementation and availability of the functions insured by each module.

READING OF TABLES

The table uses the following symbols : ●, ◐, ◑, to indicate :

– location of the functions :

A function is integrated in each module denoted by one of these symbols.

availability of the functions :

A function can be treated :

- in one module only,
- in several modules (redundancy),
- partially in two modules, i.e. both modules considered are to be operative to process this function.

Example :

SYSTEM	FUNCTION	MODULE			
		1A	1B	2A	2B
FLIGHT	STICK PUSHER	◐	◐	◑	◑
CONTROLS	STALL WARNING		●		●

The stick pusher function is integrated in modules 1A, 1B, 2A and 2B.

- the stall warning function is integrated in modules 1B and 2B.
- The stick pusher function is available if modules (1A AND 2A) OR (1A AND 2B) OR (1B AND 2A) OR (1B AND 2B) operate. This function is therefore not available if modules (1A AND 1B) OR (2A AND 2B) are lost.

The stall warning is available if modules 1B OR 2B operate.

This function is therefore not available if modules 1B AND 2B are lost.

	MFC		1.01.10		
	GENERAL		P 4	001	
					DEC 96

AA

SYSTEM	FUNCTION	MODULE				
		1A	1B	2A	2B	
AFCS	"AP OFF" WARNING LIGHT	●		●		
	"AP OFF" AURAL WARNING		●		●	
	ALTITUDE ALERT LIGHT	●		●		
	ALTITUDE AURAL ALERT		●		☾	
	GUIDANCE LIGHT	●		●		
	GUIDANCE (AURAL)		●		●	
	AP DISENGAGEMENT IN CASE OF .					
	- STALL WARNING	●			●	
- PITCH TRIM ASYMETRY						
STBY TRIM CONTROL				☾		
- PITCH EFFORT						
COM	MECHANICAL CALL IND	●				
	ATTENDANT CALL IND					
	CREW CALL IND			●		
	CVR ERASE		●		☾	
	RECORDERS (START/STOP)	●		●		
	PUBLIC ADDRESS VOLUME			●		
	MUTING HP GALLEY			●		
E L E C	DC	EMER BAT CHG CTL	●		●	
		MAIN BAT CHG CTL		●		
		BAT DISCHARGE IN FLIGHT		●		●
		DC BUS 1 OFF WARNING	●			
		DC BUS 2 OFF WARNING			●	
		DC STBY BUS UNDV DETECTION		●		
		SUPPLY OF DC EMER BUS FROM HOT EMER BAT BUS OR FROM MAIN BUSES	●		●	
		SUPPLY OF DC ESS BUS FROM HOT MAIN BAT BUS OR FROM MAIN BUSES	●		●	
	EMER BAT PROTECTION	●		●		
	MAIN BAT PROTECTION		●		●	
	LEFT PFTS	●				
	RIGHT PFTS			●		
	AC	SUPPLY OF INV 1 FROM DC BUS 1 OR FROM HOT MAIN BAT BUS	●		●	
		AC BUS 1/INV 1 RELAY	●			
AC BUS 2/INV 2 RELAY				●		
AC BUS TIE RELAY (BTR)			●			
INV 1 FAULT LIGHT		●	☾			
INV 2 FAULT LIGHT				☾	☾	

	MFC	1.01.10		
		P 5	155	
	GENERAL			JUN 97

SYSTEM	FUNCTION	MODULE			
		1A	1B	2A	2B
LIGHT	LIGHT TEST	●		●	
ENGINE BLEEDS	BLEED 1 SHUT-OFF VALVE	●	●		
	BLEED 1 HP VALVE	●			
	BLEED 1 "FAULT" IND		●		
	BLEED 2 SHUT-OFF VALVE			●	●
	BLEED 2 HP VALVE			●	
	BLEED 2 "FAULT" IND				●
	CROSS-FEED VALVE			●	
ATPCS	ATCPS ARM LIGHT		●		●
	ENGINE 1 UPTRIM	●	●		
	PROP 1 A/FEATH	●	●		
	INHIBITION ON GROUND OF ENG 1 ELECTRICAL FEATH PUMP ACTIVATION BY CL 1	●	●		
	ENGINE 2 UPTRIM			●	●
	PROP 2 A/FEATH			●	●
	INHIBITION ON GROUND OF ENG 2 ELECTRICAL FEATH PUMP ACTIVATION BY CL 2			●	●
PROP BRAKE	BRAKING			●	●
	RELEASING			●	●
	PROP BRAKE UNLK IND		●		●
	AUTOMATIC DC AUX PUMP CUT OFF AFTER PROP BRAKE LOCKING				●
	FAULT START 2 ILLUMINATION WHEN PROP BRAKE ENGAGED AND GUST LOCK NOT ENGAGED			●	
	PROP BRK ILLUMINATION ON CAP WHEN GUST LOCK IS RELEASED AND PROP BRAKE STILL ENGAGED		●		●
	DC AUX PUMP				●
ENGINE	INHIBITION OF LOCAL "OIL LOW PRESS" ALERT DURING ENGINE 1 SHUT-DOWN		●		
	INHIBITION OF LOCAL "OIL LOW PRESS" ALERT DURING ENGINE 2 SHUT-DOWN				●
	HIGH FLIGHT IDLE		●		●
IDLE GATE	IDLE GATE CTL	●		●	
	IDLE GATE AMBER ALERT			●	
ENGINE START	START IND LIGHTS	●		●	

AA

SYSTEM	FUNCTION	MODULE				
		1A	1B	2A	2B	
ICE AND RAIN PROTECTION	ENGINES	ENGINE 1 DE (OR ANTI) ICING	●			●
		ENGINE 2 DE (OR ANTI) ICING		●	●	
		ENGINE 1 DE (OR ANTI) ICING FAULT		●	●	
		ENGINE 2 DE (OR ANTI) ICING FAULT	●			●
	AIRFRAME	AIRFRAME DE-ICING (BOOTS A)	●	●		
		AIRFRAME DE-ICING (BOOTS B)			●	●
		AIRFRAME DE-ICING FAULT	●		●	
		MODES AUTO. SEL		●		●
	PROPELLERS	PROP 1 ANTI-ICING	●	●		
		PROP 2 ANTI-ICING			●	●
		PROP 1 ANTI-ICING FAULT	●	●		
		PROP 2 ANTI-ICING FAULT			●	●
	WINDOWS	LEFT SIDE WINDOW ANTI-ICING PWR SPLY	●	●		
		RIGHT SIDE WINDOW ANTI-ICING PWR SPLY			◐	◑
		LEFT SIDE WINDOW ANTI-ICING FAULT DETECTION	●	●		
		RIGHT SIDE WINDOW ANTI-ICING FAULT DETECTION				●
	AAS (IND)				●	
GEAR		LANDING GEAR CONTROL	●		●	
	CENTRAL PANEL	PRIMARY RED UNLK IND	●			
		PRIMARY DOWNLOCK IND	●	●		
OVERHEAD PANEL	SECONDARY RED UNLK IND			◐	◑	
	SECONDARY DOWNLOCK IND			◐	◑	
LANDING		"LDG GEAR NOT DOWN" WARNING		●		●
		BRAKE OVERTEMP ALERT (L/H)		●		
		BRAKE OVERTEMP ALERT (R/H)		◐		◑
		BRAKE OVERTEMP TEST		●		◐
		WEIGHT ON WHEELS (SYSTEM 1)		●		
		WEIGHT ON WHEELS (SYSTEM 2)				●
		NOSE WHEEL STEERING		●		●



NR 72
F.C.O.M.

MFC

GENERAL

1.01.10

P 7

550

JUN 97

AA

SYSTEM	FUNCTION	MODULE				
		1A	1B	2A	2B	
JHT CONTROL	FLAPS	EXTENSION AND ASYM PROTECTION RETRACTION AND ASYM PROTECTION RED "FLAPS UNLK" WARNING AMBER "FLAP ASYM" ALERT IN FLIGHT INHIBITION OF FLAPS UNLK TEST (MAINTENANCE) ASYM TEST (MAINTENANCE)	●	●	●	●
	STALL WARNING	STICK PUSHER STICK PUSHER INHIBITION STICK PUSHER/SHAKER FAULT IND STALL WARNING STICK SHAKER STICK PUSHER TEST	●	●	●	●
	PITCH TRIM	WHOOLER PITCH TRIM ASYM WARNING		●		●
	RUDDER TRIM	RELEASABLE CENTERING UNIT AUTO DISCONNECT DURING YAW TRIM ACTION OR YAW DAMPER ENGAGEMENT	●		●	
	TLU	TRAVEL LIMITATION UNIT AUTOMATIC CONTROL INDICATION	●		●	
	HYDRAULIC	BLUE HYDRAULIC PUMP (CTL) GREEN PUMP LO PR INDICATION	●	●		●
CCAS	AURAL ALERTS MASTER WARNING AND MASTER CAUTION AMBER ALERTS ON CAP RED "CONFIG" "ENG OIL" "PROP BRK" ALERTS ON CAP RED "FLAPS UNLK" ALERT ON CAP		●		●	

	MFC	1.01.10		
	GENERAL	P 8	500	
				JUN 97

AA

SYSTEM	MODEL	FUNCTION	MODULE			
			1A	1B	2A	3
AIR	ALL	PACK 1	●	●		
		PACK 1 FAULT IND	●	●		
		PACK 2			●	●
		PACK 2 FAULT IND			●	●
		GND TURBO FAN 1		●		
		GND TURBO FAN 2				●
		OUTFLOW VALVE AUTO OPENING AFTER LANDING		●		
		OVBD VALVE PWR RLY CTL		●	●	●
		OVBD VALVE FAULT IND				●
		X VALVE			●	
		UNDER FLOOR VALVE PWR RLY CTL			●	
		EXTRACT FAN			●	
		EXTRACT FAN SHUT DOWN RLY COMMAND			●	
DOORS	102 or 202 or 212	CARGO DOOR UNLK IND			●	
		CARGO DOOR CTL	●			
		EMER HATCH UNLK IND			●	
		FWD COMPT DOOR UNLK IND	●			
		CARGO DOOR CTL PANEL	●		●	

	MFC	1.01.10		
		P 9	001	
	GENERAL			DEC 96

10.4 ELECTRICAL SUPPLY/SYSTEM MONITORING

ELECTRICAL SUPPLY

Each module is supplied by two separate electrical sources (primary and alternate). Power supply switching is automatic :

- from primary to alternate if primary V < 19V and if alternate V > 22V,
- from alternate to primary if primary V > 22V.

UNIT	DC BUS SUPPLY (C/B)
MFC 1A	
Primary Supply	DC ESS BUS (Upper Panel PRIM SPLY)
Alternate Supply	HOT EMER BAT BUS (Upper Panel ALTN SPLY)
MFC 1B	
Primary Supply	DC BUS 1 (Upper Panel PRIM SPLY)
Alternate Supply	DC EMER BUS (Upper Panel ALTN SPLY)
MFC 2A	
Primary Supply	DC EMER BUS (Upper Panel PRIM SPLY)
Alternate Supply	HOT MAIN BAT BUS (Upper Panel ALTN SPLY)
MFC 2B	
Primary Supply	DC BUS 2 (Upper Panel PRIM SPLY)
Alternate Supply	DC EMER BUS (Upper Panel ALTN SPLY)

R SYSTEM MONITORING

- R The following conditions are monitored by visual and aural alerts :
- R - MFC Module(s) failed
- R • See MFC "MODULE(S)" FAULT procedure in chapter 2.05.10.

	MFC		1.01.10	
	GENERAL		P 10	100
			JUN 97	

10.5 LATERAL MAINTENANCE PANEL

The right side maintenance panel includes a readout display for failures of system.. linked to MFC.

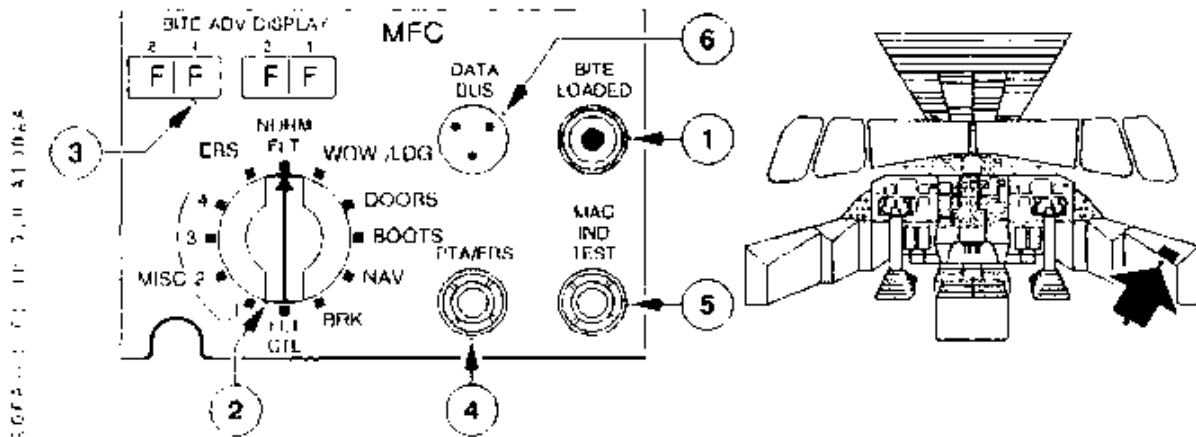

Recording of these failures is performed by the MFC 1A module.

- ① **"BITE LOADED" Magnetic indicator.**
Indicates that a failure has been recorded by the maintenance system.
- ② **SYSTEM SELECTOR switch**
Normally placed in NORM FLT position (in all other positions the "MAINT PNL" light comes on amber on CAP).
During maintenance operations, enables the various systems to be selected, in order to consult the failures which have affected the system involved.
- ③ **BITE ADVISORY DISPLAY (Failure Display)**
Indicates, through illuminated lights, the code of the failure recorded (the combinations of illumination of these four lights enable up to 14 failures per system to be coded : the code/failure relationships are given in the following pages).
- ④ **PTA/ERS pb**
 - when a system is selected, PTA function (Push To Advance) enables recording failures to be run on the failure display. FFFF code indicates the end of the list for the selected system.
 - when ERS position is selected :
 - If PTA/ERS pb is pressed in for less than 2 seconds, ARINC test is performed and "-FF-" code is displayed if successful.
 - If PTA/ERS pb is pressed in for more than 5 seconds, system memory is erased and "F--F" code is displayed during erasing.
- ⑤ **TEST pb**
Used to check operation of the BITE LOADED magnetic indicator.
When pressed for more than 3 s. the magnetic indicator is activated.
- ⑥ **CONNECTOR OUTLET**
Enables the optional MTS (Maintenance Test Set) system to be connected.

	MFC		1.01.10		
			P 11	001	
	GENERAL				JUL 00

AA

SYS		WOW & L/G				
CODE	8	4	2	1		DEFINITION
1				F		Right Main Gear Prime DnLk Prox Switch Fail
2			F			Nose Gear Prime DnLk Prox Switch Fail
3			F	F		Left Main Gear Prime DnLk Prox Switch Fail
4		F				Right Main Gear Sec. DnLk Prox Switch Fail
5		F		F		Nose Gear Sec. DnLk Prox Switch Fail
6		F	F			Left Main Gear Sec. DnLk Prox Switch Fail
7		F	F	F		Left Main Gear WOW 1 Prox. Switch Fail
8	F					Nose Gear WOW 1 Prox. Switch Fail
9	F			F		Right Main Gear WOW 1 Prox. Switch Fail
A	F		F			Left Main Gear WOW 2 Prox. Switch Fail
B	F		F	F		Nose Gear WOW 2 Prox. Switch Fail
C	F	F				Right Main Gear WOW 2 Prox. Switch Fail
D	F	F		F		
E	F	F	F			

SYS		DOORS					
CODE	8	4	2	1	*		DEFINITION
1				F	2		Left Fwd Door Unlock Prox Switch 1 Fail
2			F		2		Left Fwd Door Unlock Prox Switch 2 Fail
3			F	F	2/3		Left Aft Door Unlock Prox Switch 1 Fail
4		F			2/3		Left Aft Door Unlock Prox Switch 2 Fail
5		F		F	2		Right Fwd Door Unlock Prox Switch 1 Fail
6		F	F		2		Right Fwd Door Unlock Prox Switch 2 Fail
7		F	F	F	2/3		Right Aft Door Unlock Prox Switch 1 Fail
8	F				2/3		Right Aft Door Unlock Prox Switch 2 Fail
9	F			F	3		Emergency Hatch Prox. Switch Fail
A	F		F		3		DOB CD HOOKS ENGAGED MAINT IND
B	F		F	F	3		DOB CD LATLK LKD MAINT IND
C	F	F			3		DOB CD HOOKS DISENG MAINT IND
D	F	F		F	2		Emergency Hatch Prox Switch Fail
E	F	F	F				

* : In this column : 2 indicates models 101 or 201 or 211

R

3 indicates models 102 or 202 or 212 or 212A



AR72
F.C.O.M.

MFC

GENERAL

1.01.10

P 12

001

DEC 96

AA

SYS : BOOTS					
CODE	8	4	2	1	DEFINITION
1				F	Left Engine Boot A Fault
2			F		Right Engine Boot A Fault
3			F	F	Left Engine Boot B Fault
4		F			Right Engine Boot B Fault
5		F		F	Left Wing Boot A Fault
6		F	F		Right Wing Boot A Fault
7		F	F	F	Left Wing Boot B Fault
8	F				Right Wing Boot B Fault
9	F			F	Left Median Wing Boot A Fault
A	F		F		Right Median Wing Boot A Fault
B	F		F	F	Left Median Wing Boot B Fault
C	F	F			Right Median Wing Boot B Fault
D	F	F		F	Horizontal Tail plane Boot A Fault
E	F	F	F		Horizontal Tail plane Boot B Fault

SYS : NAV					
CODE	8	4	2	1	DEFINITION
1				F	AHRS 1 Overheat
2			F		AHRS 2 Overheat
3			F	F	AHRS 3 Overheat
4		F			EADI 1 Overheat
5		F		F	EADI 2 Overheat
6		F	F		EHSI 1 Overheat
7		F	F	F	EHSI 2 Overheat
8	F				FMS Overheat
9	F			F	SGU 1 Overheat
A	F		F		SGU 2 Overheat
B	F		F	F	AFCS Anomaly
C	F	F			
D	F	F		F	
E	F	F	F		



NR72
F.C.O.M.

MFC

1.01.10

P 13

100

GENERAL

JUL 98

AA

SYS : BRK					DEFINITION
CODE	8	4	2	1	
1				F	Left Inboard Brake Overheat
2			F		Left Outboard Brake Overheat
3			F	F	Right Inboard Brake Overheat
4		F			Right Outboard Brake Overheat
5		F		F	L.INBD XMITTER PWR LOSS/OUTPUT OPEN
6		F	F		L.OUTB XMITTER PWR LOSS/OUTPUT OPEN
7		F	F	F	R.INBD XMITTER PWR LOSS/OUTPUT OPEN
8	F				R.OUTB XMITTER PWR LOSS/OUTPUT OPEN
9	F			F	L.INBD SNSR/XMITTER TEST FAIL
A	F		F		L.OUTB SNSR/XMITTER TEST FAIL
B	F		F	F	R.INBD SNSR/XMITTER TEST FAIL
C	F	F			R.OUTB SNSR/XMITTER TEST FAIL
D	F	F		F	
E	F	F	F		
3			F	F	RA < 500 FEET DATA PERMANENT (IAS1)
4		F			RA < 500 FEET DATA PERMANENT (IAS2)
5		F		F	RA > 500 FEET DATA PERMANENT (IAS1)
6		F	F		RA > 500 FEET DATA PERMANENT (IAS2)
7		F	F	F	SPRING TAB PIN PROG NOT GROUNDED
8	F				TRIM DIRECTION FAULT
9	F			F	FLAPS POSITION SWITCH FAULT
A	F		F		SPRING TAB PIN PROG NOT GROUNDED
B	F		F	F	
C	F	F			STICK PUSHER: LEFT ALPHA PROBE DISAGREE
D	F	F		F	STICK PUSHER: RIGHT ALPHA PROBE DISAGREE
E	F	F	F		

AA

SYS : MISC 1					
CODE	8	4	2	1	DEFINITION
1				F	AIR BLEED : LH HP VALVE MAINT INDICATION
2			F		AIR BLEED : RH HP VALVE MAINT INDICATION
3			F	F	ELEC. LH OPEN WIRE MAINT IND
4		F			ELEC. RH OPEN WIRE MAINT IND
5		F		F	ELEC. SVCE/UTIL CNTOR FAULT MAINT IND
6		F	F		AIR COND: LH PACK MAINT OVHT IND
7		F	F	F	AIR COND: RH PACK MAINT OVHT IND
8	F				ANTIICE: LH MAIN W/S CTL OPEN FAIL SIGNAL
9	F			F	ANTIICE: RH MAIN W/S CTL OPEN FAIL SIGNAL
A	F		F		FORWARD CARGO EXTINGUISHER 1 FAILED
B	F		F	F	AFTER CARGO EXTINGUISHER 1 FAILED
C	F	F			AUX AFTER CARGO EXTINGUISHER 2 FAILED
D	F	F		F	ADC 1 OR ADC1 & 2 SWITCHES DISAGREE
E	F	F	F		ADC 2 OR ADC2 & 1 SWITCHES DISAGREE

SYS : MISC 2					
CODE	8	4	2	1	DEFINITION
1				F	ELEC: STBY CONTACTOR DEFAULT
2			F		ANTI-ICE: AUTO MODE SWITCHES DISAGREE
3			F	F	COM: FDAU MEMORY FULL
4		F			QUICK ACCESS RECORDER FULL
5		F		F	Engine 1 Feeder Jet Pump Fault
6		F	F		Engine 2 Feeder Jet Pump Fault
7		F	F	F	EEC 1 FAULT LATCH
8	F				EEC 2 FAULT LATCH
9	F			F	Fin optional Boots A Fault
A	F		F		Fin Optional Boots B Fault
B	F		F	F	
C	F	F			PROP BRAKE: SWITCHES DISAGREE
D	F	F		F	ANTI-ICE: LEFT PROP. HEATER FAULT
E	F	F	F		ANTI-ICE: RIGHT PROP. HEATER FAULT

 ATR 72 F.C.O.M.	MFC		1.01.10		
			P 15/16	100	
	GENERAL				JUN 97

AA

SYS : MISC 3					
CODE	8	4	2	1	DEFINITION
1				F	MODULE 1A PIN-PROG DISAGREE
2			F		MODULE 1B PIN-PROG DISAGREE
3			F	F	MODULE 2A PIN-PROG DISAGREE
4		F			MODULE 2B PIN-PROG DISAGREE
5		F		F	MODULE 1A PIN-PROG ACQUISITION FAULT
6		F	F		MODULE 1B PIN-PROG ACQUISITION FAULT
7		F	F	F	MODULE 2A PIN-PROG ACQUISITION FAULT
8	F				MODULE 2B PIN-PROG ACQUISITION FAULT
9	F			F	AIRCRAFT VERSION FAULT
A	F		F		MFC COMPATIBILITY FAULT
B	F		F	F	MFC MIXABILITY FAULT
C	F	F			
D	F	F		F	PROPELLER TYPE DISAGREE
E	F	F	F		UNKNOWN PROPELLER TYPE

SYS : MISC 4					
CODE	8	4	2	1	DEFINITION
1				F	PROPELLER ELECTRONIC CTRL 1 FAIL
2			F		PROPELLER INTERFACE UNIT 1 FAIL
3			F	F	PROPELLER ELECTRONIC CTRL 2 FAIL
4		F			PROPELLER INTERFACE UNIT 2 FAIL
5		F		F	ANC SYSTEM OPERATIVE FAULT
6		F	F		ANC SYSTEM INOPERATIVE FAULT
7		F	F	F	Right Empenage Boot A Fault
8	F				Right Empenage Boot B Fault
9	F			F	
A	F		F		
B	F		F	F	
C	F	F			
D	F	F		F	
E	F	F	F		

10.6 SCHEMATIC

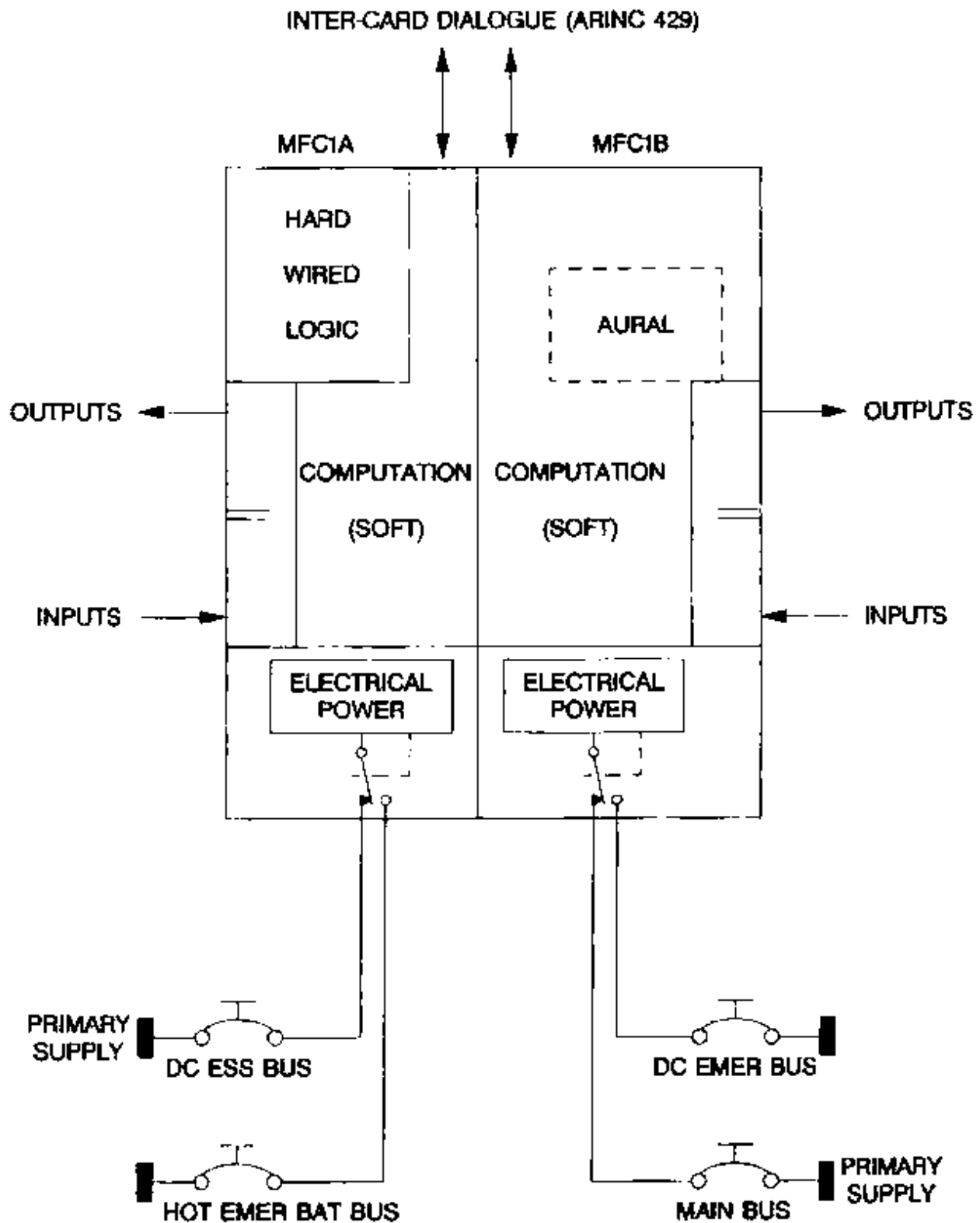

ROFA-01-01-10-017-A001AA

	CCAS	1.02.00		
	CONTENTS	P 1	001	
				DEC 96

AA

1.02.00 CONTENTS

1.02.10 GENERAL

10.1 DESCRIPTION

10.2 CONTROLS

10.3 OPERATION

10.4 ELECTRICAL SUPPLY/MFC LOGIC

10.5 LATERAL MAINTENANCE PANEL

10.6 SCHEMATIC

	CCAS	1.02.10		
		P 1	001	
	GENERAL			DEC 96

10.1 DESCRIPTION (See schematic p 15/16)

- A **CENTRALIZED CREW ALERTING SYSTEM (CCAS)** is continuously monitoring all aircraft systems in order to provide the following functions :

- Alert the crew on the existence of a system malfunction or aircraft hazardous configuration with a clear indication of the urgency of the situation,
- Identify the malfunction or situation without ambiguity,
- Direct the appropriate corrective action without confusion.

Three types of visual devices are used :

- **MASTER WARNING (MW)** and **MASTER CAUTION (MC)** lights.

These flashing lights are used as "ATTENTION GETTERS". Together with aural signals, they allow the crew to detect a failure and identify its degree of urgency. They may be switched off by a push on the light. This crew acknowledgement will also silence the associated aural.

- **CREW ALERTING PANEL (CAP)** lights.

Regrouped on a centrally located panel, these lights are used to identify the origin of a failure. They provide condensed information of system faults or aircraft abnormal configuration.

- **LOCAL ALERT** lights.

These lights are generally integrated in the system central panels. They give detailed information on the failure and also direct the corrective action, being, as much as possible, combined with or adjacent to the corrective action control. A limited number of aural alerts call crew attention through two loudspeakers.

- Logic functions are performed by MFC 1B and 2B modules which acquire and process system failure and flight envelope protection signals and generate visual and aural alerts.

Two kinds of logic are possible :

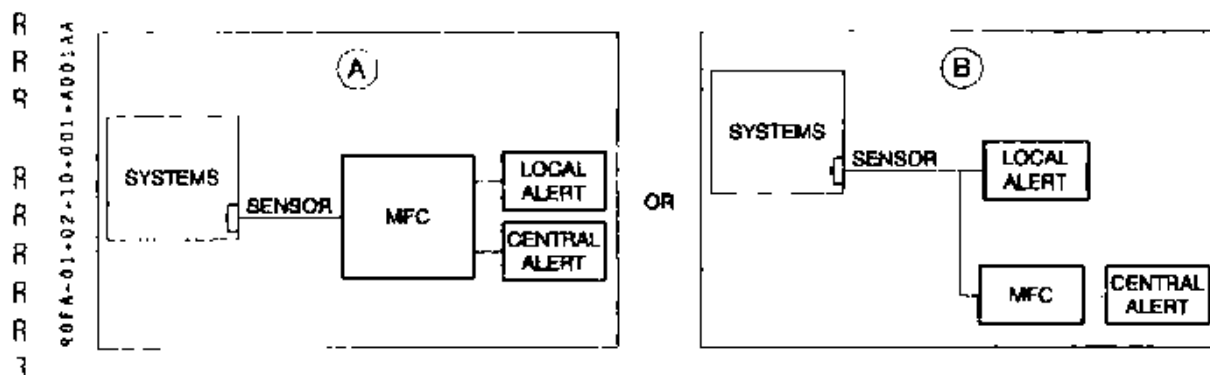

Following warnings are not processed by MFC : ENG FIRE, EXCESS CAB ΔP, EXCESS CAB ALT, NAC OVHT, SMOKE. Corresponding warning lights on CAP are directly illuminated by respective system (independently of MFC).

Note : All alerts requesting a flight crew action are quoted in the emergency and following failure procedures chapters.

	CCAS	1.02.10		
		P 2	001	
	GENERAL			DEC 96

BASIC PRINCIPLES

The following two principles have been adopted :

- "All flight deck lights out" concept

In normal operation, all the lights are extinguished (except sometimes green or blue light for transient phases).

Detection sequence

The detection sequence comprises three different phases.

PHASE	FUNCTION	MEANS OF DETECTION
1	ALERT	AURAL + MW/MC light
2	IDENTIFICATION	CAP
3	ISOLATION	LOCAL ALERT

ALERT LEVELS

The alerts are classified in 4 levels according to their importance and to the urgency of the corrective action required.

LEVEL 3 : WARNINGS

This corresponds to an emergency situation requiring crew prompt corrective action.

The following alerts fall into this category :

- aircraft in hazardous configuration or limiting flight conditions (e.g. stall warning)
- serious system failure (e.g. engine fire)

These warnings are identified by :

- The MW light flashing red associated with a continuous repetitive chime (CRC) and a red warning light on the CAP.
- a specific aural warning.

LEVEL 2 : CAUTIONS

This corresponds to an abnormal situation of the aircraft requiring timely crew corrective action. Time for taking action will be left to crew's discretion.

This level mainly comprises system failures having no immediate impact on safety (e.g. engine overheat).

The cautions are identified by the MC light flashing amber associated with a single chime (SC) and an amber light on the CAP.

LEVEL 1 : ADVISORIES

This corresponds to a situation requiring crew monitoring.

This level mainly comprises failures leading to a loss of redundancy or degradation of a system (e.g. A/ERECT FAIL).

These advisories are identified by an amber local light without chime.

LEVEL 0 : INFORMATION

This corresponds to an information situation (e.g. DME hold).

This information is provided by blue, green or white lights on the control panels.

Note : Levels 1 and 0 are not taken into account by the MFC.

	CCAS	1.02.10		
		P 3	001	
	GENERAL			DEC 96

ALERT INHIBITION

In order to avoid alerts when not desired, inhibition follows the conditions below :

- All the CAP amber lights except PRKG BRK, GPWS FAULT, MAINT PANEL may be extinguished by pressing CLR pb on CAP.
 - ENG oil, smoke warnings and some caution alerts may be inhibited before take off by depressing TO pb.
- R Associated aural alerts are also inhibited.
These inhibitions will be cancelled :
- automatically as soon as one gear leg is not locked down,
 - by pressing RCL pb.
- An emergency audio cancel sw allows the crew to cancel a nuisance aural for a whole flight (except for LDG GEAR, VMO, VFE, VLE, Stall Warning, Whooler, AP Disconnect). Associated aural will be reactivated :
- at next aircraft energization,
 - after MFC 1B/2B reset,
 - after pressing RCL pb.
 - after T.O. Config test.

AURALS

Three types of aurals have been defined to alert the crew :

- A continuous repetitive chime (CRC) is used for all warnings directly identified by a specific CAP light
 - A single chime (SC) is used for all cautions directly identified by a CAP system light
 - Specific aurals for alerts not directly identified by a specific CAP light and which are of a particular operational significance :
- | | | |
|--|---|----------|
| <ul style="list-style-type: none"> • stall (cricket) • overspeed : VMO, VFE, VLE (clacker) • AP disconnect (cavalry charge) • Trim in motion (whooler) | } | warnings |
| <ul style="list-style-type: none"> • altitude alert ("c chord") • calls (door bell) • AP capability downgrading (3 click) | } | cautions |

Note : A priority order has been defined for aurals in case of simultaneous occurrence of warnings :

- | | |
|---|---|
| <ul style="list-style-type: none"> - Stall (cricket) - Overspeed (clacker) - Flaps unlocked (CRC) - Config (CRC) - Propeller brake failure (CRC) - Engine fire (CRC) - Pitch Disconnect (CRC) - Excess cabin altitude (CRC) | <ul style="list-style-type: none"> - Nac OVHT (CRC) - Excess cab ΔP (CRC) - Trim in motion (whooler) - Smoke detection (CRC) - Oil low press (CRC) - Landing gear not down (CRC). - AP disconnection (cavalry charge) |
|---|---|
- R

10.2 CONTROLS

CAP

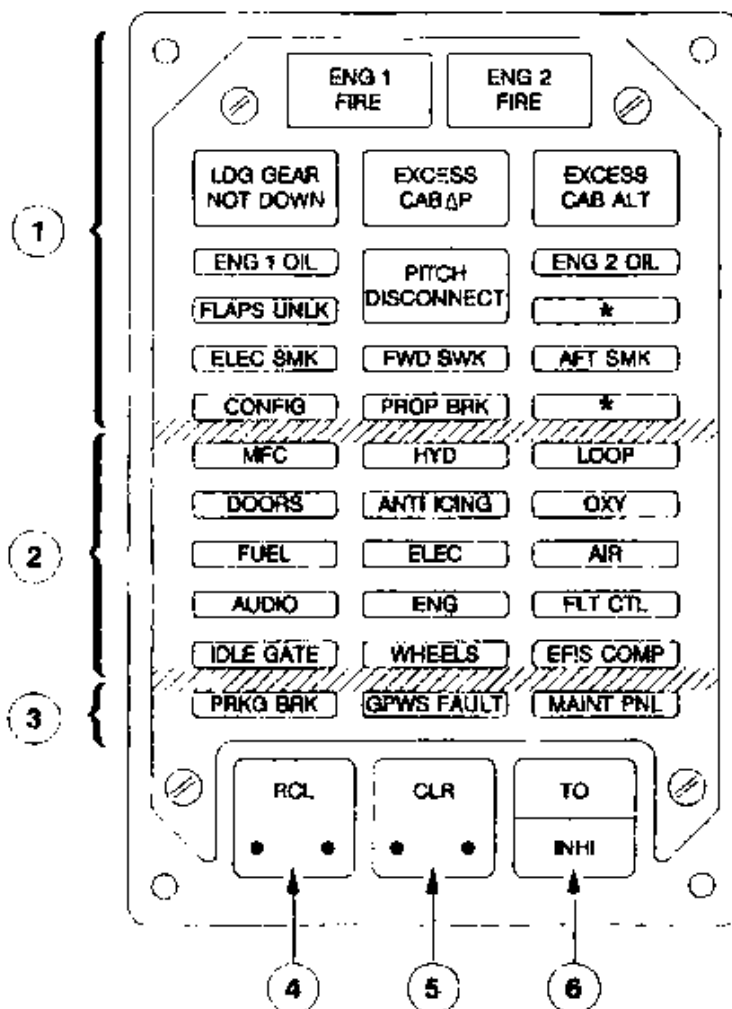

R05A-C1-02-10-004-A001AA

* NAV OVHT, OR NAC 1 OVHT AND NAC 2 OVHT (dépendant on the version)

① WARNING lights

Red lights.

② CAUTION lights (level 2)

Amber lights.

③ CAUTION lights (level 1)

Amber lights that can be cleared only by corrective action.

	CCAS	1.02.10		
		P 5	001	
	GENERAL			DEC 96

AA

④ RCL pb

When depressed :

- All inhibited or cancelled caution lights will illuminate if the respective system is still degraded.
- All aural warnings previously cancelled are reactivated. Recall is possible during all phases of operation.

⑤ CLR pb

R When depressed, certain zone 2 caution lights will be cleared. (see page 3).

⑥ TO pb

When depressed, the INHI light illuminates blue and the ENG OIL warning lights, the smoke warning lights, all CAP amber lights except EFIS COMP, PRKG BRK, GPWS FAULT, MAINT PNL, ENG (for an ADC sw fault alert), FLT CTL (for a TLU fault alert or FLAP ASYM alert), and associated aural warning are inhibited. Other warnings are not inhibited.

The blue light extinguishes when the TO INHI function is cancelled.

MW/MC LIGHT

R0FA-01-02-10-005-ADD1AA

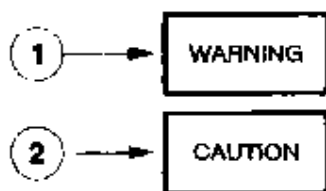

① MW light

Illuminates in case of a warning associated with a CAP red light.

When depressed, light will extinguish and associated aural warning will be cancelled.

② MC light

Illuminates in case of a caution associated with a CAP amber light.

When depressed, light will extinguish.

	CCAS	1.02.10		
		P 6	001	
	GENERAL			DEC 96

CONTROL PANEL

R0FA-01-02-30-C06-AG0.AA

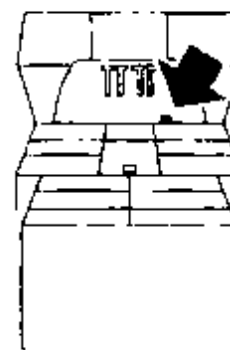
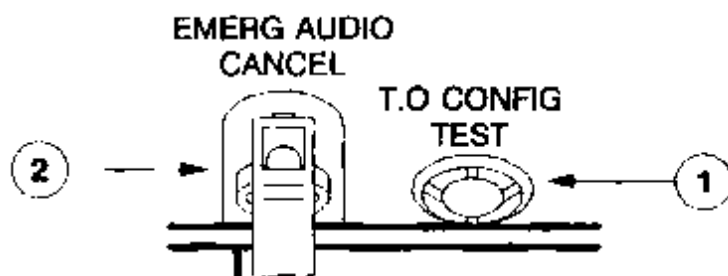

① T.O CONFIG TEST pb

Is used before take-off :

- to check if aircraft configuration is correct for take-off by simulating power levers at TO position (except PARK BRAKE) ;
- to perform an automatic RECALL (thus reactivating all aural warnings previously cancelled by Emerg Audio/Cancel).

② EMER AUDIO CANCEL sw

Is safety wired guarded. If a false system indication generates and undue continuous aural, the use of this SW will cancel the aural specific of this false a'

Example : If the SW is used to cancel a system X failure CRC, CRC is not cancelled for the systems other than system X.

Cancelled aural warning will be reactivated

- at next aircraft energization (MFC reset)
- after MFC 1B/2B reset
- after pressing RCL pb
- following T.O. Config test

Except for aural warning associated with :

- landing gear (landing configuration)
- VMO, VFE, VLE
- Stall warning
- Pitch trim whooler
- AP Disconnect

Which will be rearmed as soon as the triggering condition disappears.

 A320 F.C.O.M.	CCAS	1.02.10		
	GENERAL	P 7	100	
				JUL 00

AA

10.3 OPERATION

NORMAL OPERATION

WITHOUT AIRCRAFT SYSTEM FAILURE

After engines start :

No alert light illuminated in the cockpit except PRK-BRK on the CAP if the parking brake is set.

Before take off :

Press TO CONFIG TEST

- if aircraft is in correct configuration, no light will illuminate.
- if aircraft is not in correct configuration :
 - MW light will flash red,
 - CRC aural will be generated,
 - CONFIG red light will illuminate on the CAP associated with
 - FLT CTL when pitch trim, and/or wing flaps are not in the TO configuration and/or AIL LOCK is illuminated indicating a disagree between the gust lock control and the actuators.
 - ENG when PWR MGT is not set to TO position.
 - the TLU FAULT if the Travel limiting unit is not in LO SPD configuration.

Press TO pb on CAP, INHI light illuminates blue. Take off may be initiated.

At gear retraction, inhibition is disengaged, INHI light extinguishes.

Before starting descent :

Press RCL pb on CAP.

No light will illuminate on CAP provided no failure occurred in flight.

OVERSPEED ALERT

When the aircraft is in overspeed conditions (VMO, VFE, VLE), a specific aural alert is generated which will persist until return into the following flight envelope is performed.

ALERTS	VFE	VLE	VMO
Flaps 0°		180 kt	250 kt
Flaps 15°	180 kt		
Flaps 30°	145 kt		

AA

STALL ALERT

To generate this alert (cricket and stick shaker), aircraft is fitted with two angle attack probes, one on each side of the forward fuselage.

301A-01-12-11-00P 45024A

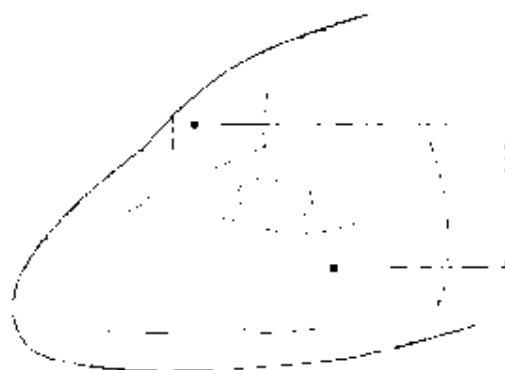

ANGLE OF ATTACK PROBES

Angle of attack probe information is directly processed by CCAS.

Critical angle of attack detected by angle of attack probes leads to aural alert (cricket) stick shaker activation, and then stick pusher activation.

In normal conditions, stick shaker and stick pusher triggering thresholds are elaborated by adding a " $\Delta\alpha$ " value to angles of attack corresponding to the basic protections. $\Delta\alpha$ depends on engine 1 and engine 2 torques and flaps configuration. Engine 1 torque signal is processed by MFC 1A and engine 2 torque signal is processed by MFC 2A. So, two $\Delta\alpha$ are computed, but only the longer one is considered.

The monitoring system uses:

- a microswitch signal on PL handles
- both EECs
- the four MFC modules

The failure of one of these elements invalids the associated $\Delta\alpha$.

If a $\Delta\alpha$ is invalidated, the system takes into account the other one. If both $\Delta\alpha$ are invalidated, system chooses $\Delta\alpha = 0$.

Note : System operation goes unnoticed for the crew.

	AIRCRAFT CRITICAL ANGLE OF ATTACK					
	ALERT and STICK SHAKER ACTIVATION			STICK PUSHER ACTIVATION		
	FLAPS 0°	FLAPS 15°	FLAPS 30°	FLAPS 0°	FLAPS 15°	FLAPS 30°
HIGH POWER	10.9°	10.9°	9.9°	13.4°	14.1°	12.8°
LOW POWER	10.9°	10.9°	10.4°	13.4°	14.1°	14.3°

	CCAS		1.02.10		
			P 9	500	
	GENERAL				JUL 01

Whenever ICING AOA is illuminated, the aircraft is protected by an earlier stall threshold as follows :

	AIRCRAFT CRITICAL ANGLE OF ATTACK					
	ALERT and STICK SHAKER ACTIVATION			STICK PUSHER ACTIVATION		
	FLAPS 0°	FLAPS 15°	FLAPS 30°	FLAPS 0°	FLAPS 15°	FLAPS 30°
TAKE OFF	8.0°	8.4°		10.6°	10.9°	
EN ROUTE	8.0°	8.4°	7.7°	10.6°	10.9°	10.8°

- R **Notes** - *EN ROUTE* values occurs, when 10 mn have elapsed after lift off or when flaps are retracted to 0 whichever occurs first.
- Stall alarm alert and shaker are inhibited when aircraft is on the ground
 - Stick pusher activation is inhibited :
 - on ground
 - during 10 seconds after lift off
 - in flight, provided radio altimeter is operative, when the aircraft descends below 500 ft.

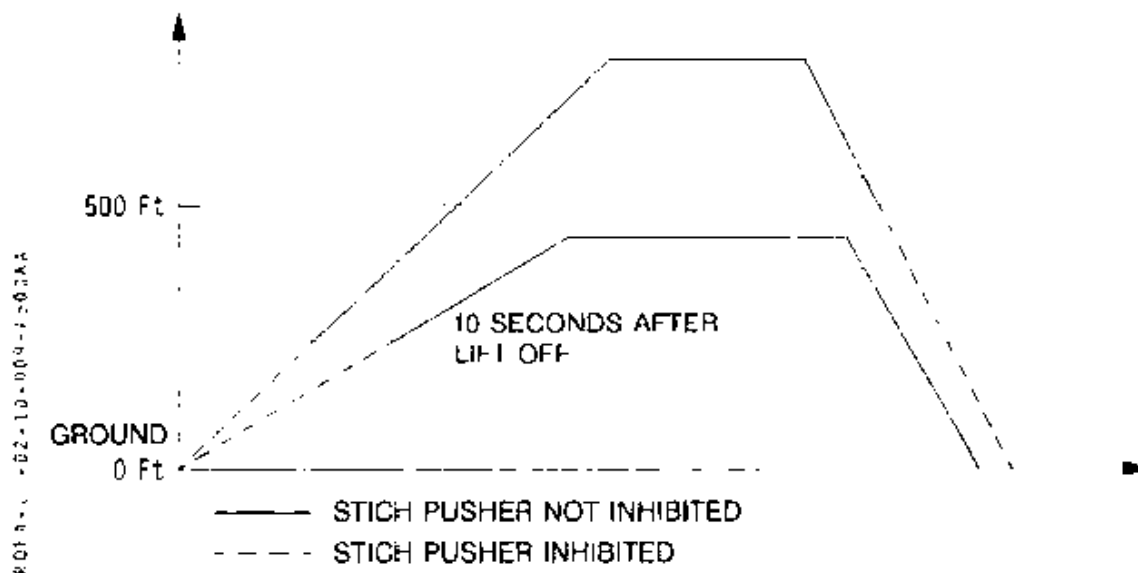

- If radio altimeter gives an erroneous "< 500 ft" signal meanwhile IAS > 185 kt for more than 120 seconds (cruise), STICK PUSHER FAULT amber light will come on to notify the crew that stick pusher is inhibited.

 ATR 72 F.C.O.M.	CCAS	1.02.10		
		P 10	001	
	GENERAL			DEC 96

WITH AIRCRAFT SYSTEM FAILURE

LEVEL 3	LEVEL 2
Failure detection	
aural alert : CRC MW light flashing red - red warning light on the CAP identifying the failure - for some cases, a red light on the affected system control panel	- aural alert : SC - MC light flashing amber - amber caution light on the CA identifying the failure - local alert light on the affected system control panel
Acknowledgement of the failure by the crew	
- Press MW light • MW light extinguishes • aural alert is cancelled	- Press MC light • MC light extinguishes
Corrective action	
■ If the failure disappears, associated local alert light and CAP light extinguish. ■ If the failure does not disappear, associated local alert light and CAP light remain illuminated : Press CLR on CAP (after Check list application)	
CAP light does not extinguish	CAP light extinguishes Before starting descent, press RCL on CAP CAP light, associated with system where a failure persists, or, with a white light illuminated on the associated control panel will illuminate. If necessary, take into account the failure consequences for the landing. Press CLR on CAP

Note : The local alert lights always reflect directly the system status : they never inhibited nor cleared by any other means than restoring normal functioning. When a local alert light disappears, the other alert sequence elements (MW/MC lt, CAP, aural) also disappear.

OPERATION WITH CCAS FAILURE

In case of MFC 1B and 2B failure :

- MC illuminates without flashing
- MFC amber light illuminates on CAP
- MFC 1B and 2B amber FAULT lights illuminate on overhead panel

In these conditions, processing of alerts is as follows :

- All level 2 alerts and "CONFIG" + "ENG OIL" + "PROP BRK" level 3 alerts are not processed. The crew has to monitor the overhead panel where the local alerts are still active.
- All other level 3 alerts are processed on CAP (without MW and CRC).

	CCAS	1.02.10		
	GENERAL	P 11	001	
				DEC 96

AA

10.4 ELECTRICAL SUPPLY/MFC LOGIC

ELECTRICAL SUPPLY

EQUIPMENT	DC BUS SUPPLY (C/B)
MFC 1B Primary supply Alternate supply	DC BUS 1 (Upper panel 1B PRIM SPLY) DC EMER BUS (Upper panel 1B ALTN SPLY)
MFC 2B Primary supply Alternate Supply	DC BUS 2 (Upper panel 2B PRIM SPLY) DC EMER BUS (Upper panel 2B ALTN SPLY)
MW light (2 bulbs) - MC light (2 bulbs) - CAP warning lights (1 bulb) - PRK BRK light (2 bulbs) - MAINT PNL light (2 bulbs) MFC light (1 bulb)	DC EMER BUS (Upper panel 1B ALTN SPLY)
MW light (2 bulbs) - MC light (2 bulbs) - CAP warning lights (1 bulb) - CAP caution lights (2 bulbs) except PRK BRK MAINT PNL - MFC light (1 bulb) - RCL, CLR. To INHI pb lights	DC BUS 2 (Upper panel 2B PRIM SPLY)
CAPT LS	DC ESS BUS (Upper panel AUDIO SYS CAPT)
F/O LS	DC EMER BUS (Upper panel 2B ALTN SPLY)
Stall warning and stick pusher tests	DC EMER BUS (Upper panel 1B ALTN SPLY)

MFC LOGIC

See chapter 1.01.

	CCAS		1.02.10		
	GENERAL		P 12	200	
			JUN 97		

AA

10.5 LATERAL MAINTENANCE PANEL

On LH maintenance panel, a "WARN" section allows testing, on ground, of several warnings which cannot be tested on their own system.

This section includes :

- a rotary selector to select the system to be tested ;
- a Push To Test (PTT) pushbutton to activate the selected test.

Note : The rotary selector must be replaced in NORM FLT position before flight.

WARN SECTION

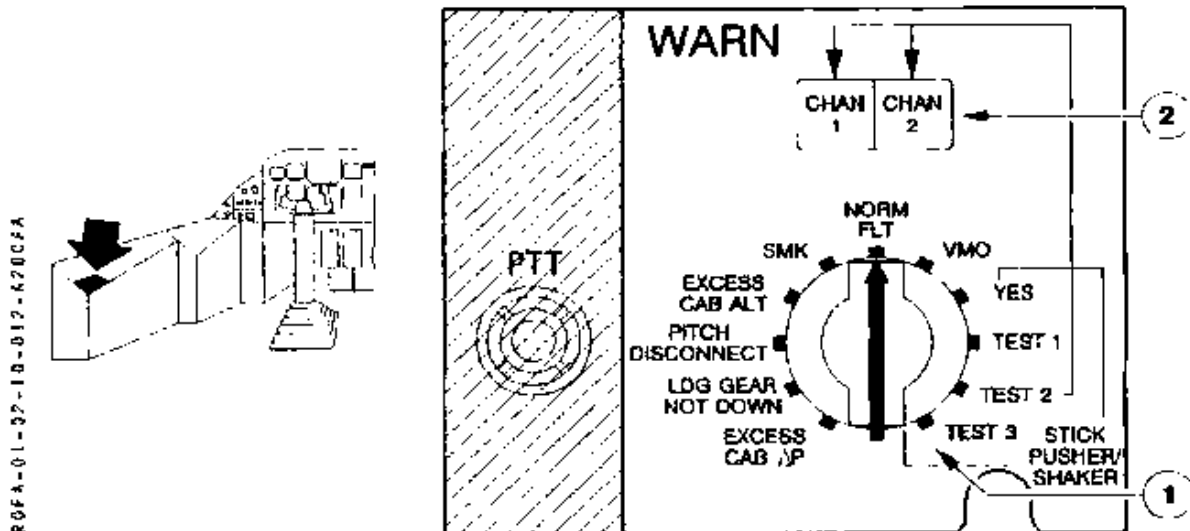

① ROTARY selector

Systems which can be tested :

- EXCESS CAB Δ P : MW, CRC, "EXCESS CAB Δ P" red light on CAP
- LDG GEAR NOT DOWN : MW, CRC, "LDG GEAR NOT DOWN" red light on CAP, red light in landing gear lever.
- PITCH DISCONNECT : MW, CRC, "PITCH DISCONNECT" red light on CAP
- EXCESS CAB ALT : MW, CRC, "EXCESS CAB ALT" red light on CAP
- SMK : MW, CRC, "FWD SMK", "AFT SMK", and "ELEC SMK" red lights on CAP
- VMO : clacker
- STICK PUSHER SHAKER-YES :
 - Stall cricket and both stick shakers are activated
 - After 5 seconds, GPWS FAULT illuminat^r amber on CAP
 - After 10 seconds:
 - CHAN 1, CHAN 2 illuminate
 - Stick pusher is activated
 - Stick pusher indicators illuminate green

	CCAS	1.02.10		
		P 13	200	
	GENERAL			JUN 97

- STICK PUSHER SHAKER - TEST 1 :
 - Stall cricket and left stick shaker are activated
 - After 5 seconds :
 - GPWS FAULT illuminates amber on CAP
 - MC, FLT CTL on CAP and stick pusher FAULT pb illuminate amber
- STICK PUSHER SHAKER - TEST 2 :
 - Stall cricket and right stick shaker are activated
 - After 5 seconds :
 - GPWS FAULT illuminates amber on CAP
 - MC, FLT CTL on CAP and stick pusher FAULT pb illuminate amber
- STICK PUSHER SHAKER - TEST 3 :
 - CHAN 1, CHAN 2 illuminate
 - Stall cricket and both stick shakers are activated
 - After 5 seconds, GPWS FAULT illuminates amber on CAP

Note : If ICING AOA is illuminated:

- YES procedure is the same.
- Test 1 procedure is the same except that CHAN 1, CHAN 2 illuminate.
- Test 2 procedure is the same except that CHAN 1, CHAN 2 illuminate.
- Test 3 procedure is the same except that stick pusher is activated in the same time as shakers.

② "CHAN" lights

Illuminates green to check the two angle of attack channels for correct operation.

 NR72 F.C.O.M.	CCAS	1.02.10		
		P 14	200	
	GENERAL			JUN 97

TEST PUSH-BUTTON

Part 1-01-02-10-01-0210-A

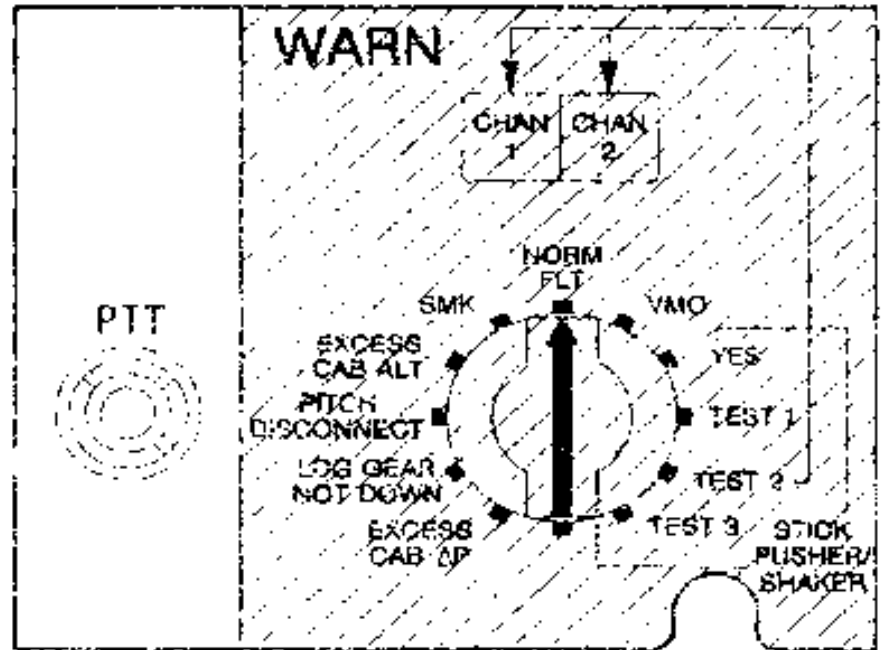

- After having selected a system with the rotary selector, use the PTT pb to activate the test.
- As soon as a test is initiated, MAIN PNL will come on amber on CAP.

1st SCHEMATIC

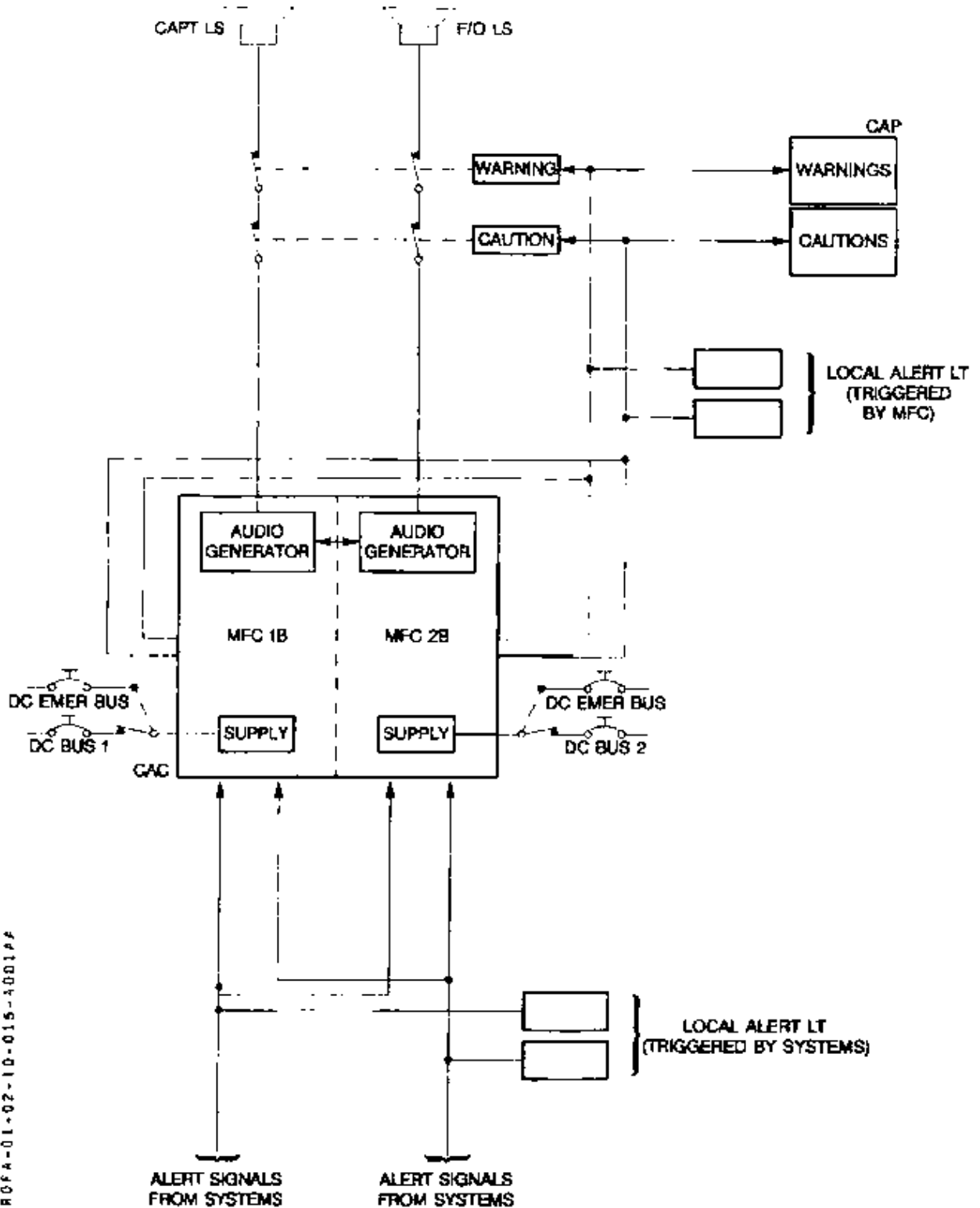

RCPA-01-02-10-015-1001AF

	AIR	1.03.00		
	CONTENTS	P 1	001	
				DEC 96

AA

1.03.00 CONTENTS

1.03.10 GENERAL

1.03.20 PNEUMATIC SYSTEM

20.1 DESCRIPTION

20.2 CONTROLS

20.3 ELECTRICAL SUPPLY/MFC LOGIC/SYSTEM MONITORING

20.4 LATERAL MAINTENANCE PANEL

20.5 SCHEMATIC

1.03.30 AIR CONDITIONING

30.1 DESCRIPTION

30.2 CONTROLS

30.3 ELECTRICAL SUPPLY/MFC LOGIC/SYSTEM MONITORING

30.4 SCHEMATICS

1.03.40 PRESSURIZATION

40.1 DESCRIPTION

40.2 CONTROLS

40.3 ELECTRICAL SUPPLY/MFC LOGIC/SYSTEM MONITORING

40.4 SCHEMATIC

 AR72 F.C.O.M.	AIR	1.03.10		
		P 1/2	080	
	GENERAL			JUN 97

The aircraft uses external air to supply :

- the air conditioning and the ventilation systems
- the pressurization system
- the de-icing system

Air inlets location :

- engines air intakes
- main landing gear fairings
- low pressure ground unit through a connector

The air intended for air conditioning and pressurization is pressurized by engines compressors and delivered through the bleed valves.

It is conditioned by the packs, distributed to the pressurized zones then discharged overboard through two outflow valves. A part of this air is recirculated.

Electric and electronic equipments and the forward cargo compartment are ventilated by cabin ambient air which is then recirculated or discharged outside the aircraft.

The de-icing system is described in the chapter 1.13.

The MFC provides the system monitoring and failures information to crew members.

	AIR	1.03.10	
		P 3/4	080
	GENERAL	JUN 97	

AA

SCHEMATIC

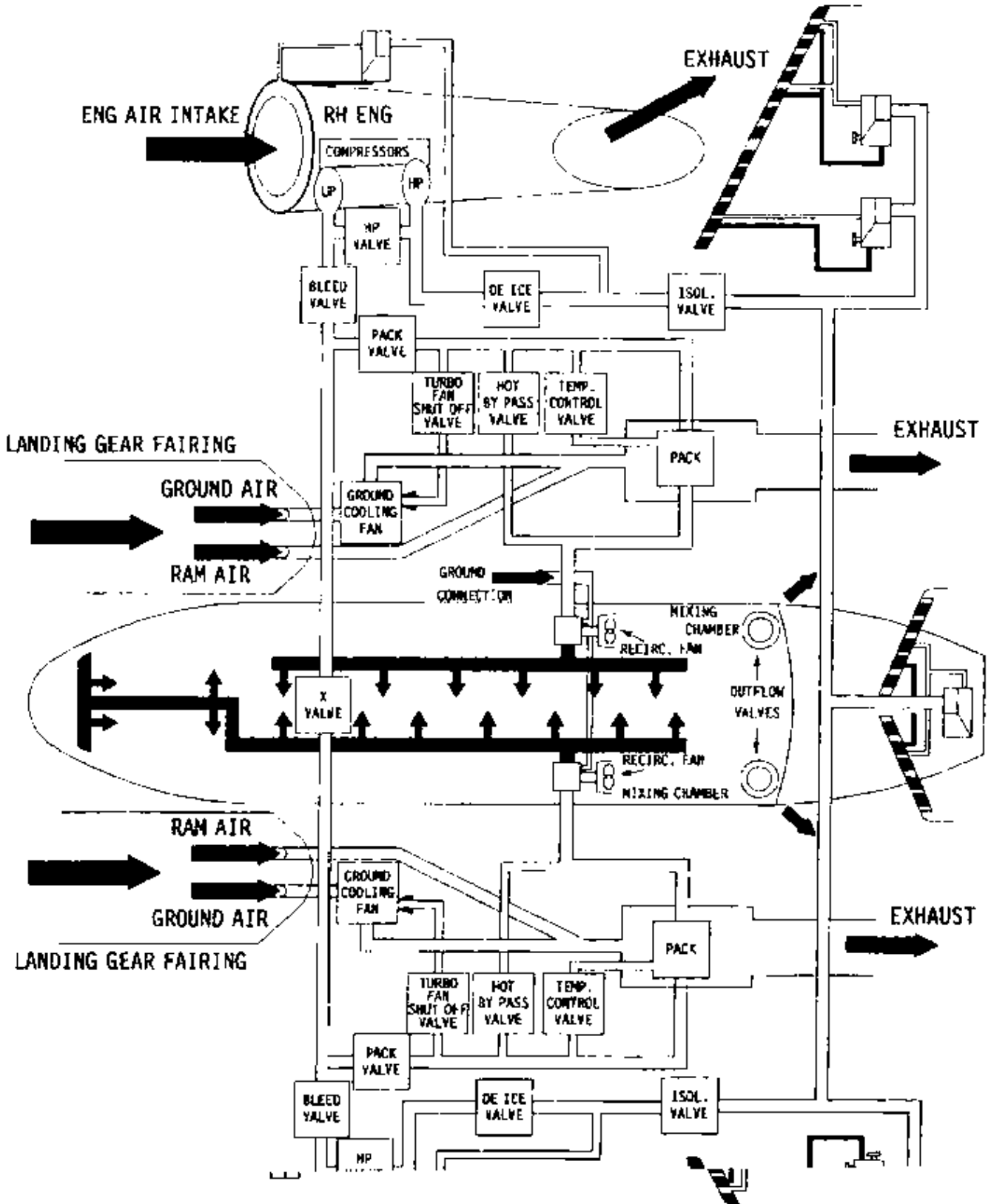

	AIR	1.03.20		
	PNEUMATIC SYSTEM	P 1	070	
				DEC 97

20.1 DESCRIPTION

(See schematic p. 7/8)

Compressed air is bled from the engine compressors at the LP or HP stages.

The pneumatic system consists of all the systems designed to supply air to the various aircraft systems, zones or engines, with associated control, monitoring and indicating components. It supplies under pressure air for air conditioning, pressurization and ice protection system.

A protection against overheat due to possible leakage around the hot air ducts is provided.

AIR BLEED

- Air conditioning and pressurization

The system is designed to :

- select the compressor stage from which air is bled, depending on the pressure and/or temperature existing at these stages.
- regulate air pressure in order to avoid excessive pressures

Air is generally bled from the low compressor stage (LP). At low engine speed when pressure from LP stage is insufficient, air source is automatically switched to the high compressor stage HP. (This may occur on ground and during descent at F.I.). Transfer of air is achieved by means of a pneumatically operated and electrically controlled butterfly valve, (HP valve) which remains closed in absence of electrical supply :

- when the HP valve is closed, air is directly bled from the LP stage through LP bleed air check valves.
- when the HP valve is open, the HP air pressure is admitted into the LP pneumatic ducting and closes the check valves ; air is therefore bled from HP stage only, without any recirculation into the engine.

- Wing and engine de-icing.

Air is bled from the HP compressor stage. Transfer of air is achieved through a pressure regulating valve which is electrically controlled.

ISOLATION

Downstream of the junction of the LP and HP ducting, air is admitted into the duct by a pneumatically operated, electrically controlled butterfly bleed valve which acts as a shut off valve. It includes a single solenoid which locks the valve closed when deenergized. The bleed valve automatically closes in the following cases :

- Bleed duct OVHT
- Bleed duct LEAK
- Actuation of associated ENG FIRE handle
- Engine failure at TQ (UPTRIM signal)
- PROPELLER BRAKE selected ON (for left bleed valve only).

In the absence of air pressure, the valve is spring-loaded closed regardless of electrical power supply.

Note : During a starting sequence, the bleed valves opening is inhibited.

	AIR	1.03.20		
	PNEUMATIC SYSTEM	P 2	150	
				JUN 97

AA

CROSSFEED

The crossfeed valve installed on the crossfeed duct is designed to connect LH and RH air bleed systems.

- R - On the ground, it is always open except when both engines are running and propeller brake is disengaged.
 - R - In flight, the crossfeed valve is normally closed.
- This is a spring loaded closed, solenoid controlled, pneumatic shut off valve. The valve is closed with solenoid deenergized.

LEAK DETECTION SYSTEM

A continuous monitoring system is installed in order to detect overheat due to duct leakage and to protect the structure and components in the vicinity of hot air ducts:

- Wing leading edge and wing to fuselage fairing.
- Upper and lower fuselage floor,
- Air conditioning pack area.

In order to ensure rapid leak sensing, a Kevlar envelope is installed around the major part of the high temperature ducts to collect and direct leaking air to the sensing elements.

The sensing system includes two single loop detection assemblies, one for the RH and one for the LH air duct systems.

The sensing elements comprise a control lead (nickel wire) embedded in an insulating material and are integrated in an inconel tube connected to aircraft ground.

Each sensing element is permanently subjected to the temperature of the compartment it protects. For any temperature higher than a preset value : 124° C (255° F) applied to a part of the sensing element, the resistance of the eutectic mixture rapidly decreases and the central lead is grounded. This results in an alert signal processed in a control unit which triggers illumination of LEAK lt. After one second time delay, the associated pack valve, HP valve and BLEED valve (and GRD X FEED valve if the left loop is affected) are automatically latched closed.

Note : In case of LEAK, the crew must consider the associated bleed system as inoperative for the rest of the flight.

OVERHEAT CONTROL SYSTEM

This system includes switches (thermal resistances) which are installed on the engines, near the HP compressors exit.

These switches, which are duplicated for safety, ensure that the bleed valve and the bleed air shut-off valve are closed whenever any abnormal over temperature conditions occur. They operate at 274° C (525° F) and are controlled by the MFC.

Note : In case of OVHT, the associated bleed system may be recovered after a cooling time.

	<p style="text-align: center;">AIR</p> <p style="text-align: center;">PNEUMATIC SYSTEM</p>	1.03.20		
		P 2A	100	
				JUL 00

AA

LEAK DETECTION SYSTEM (See page 2)

The maximum sensing element temperature is 153°C (307°F) instead of 124°C (255°F).

 A320 F.C.O.M.	AIR	1.03.20		
	PNEUMATIC SYSTEM	P 3	100	
				JUL 00

20.2 CONTROLS

AIR BLEED PANEL

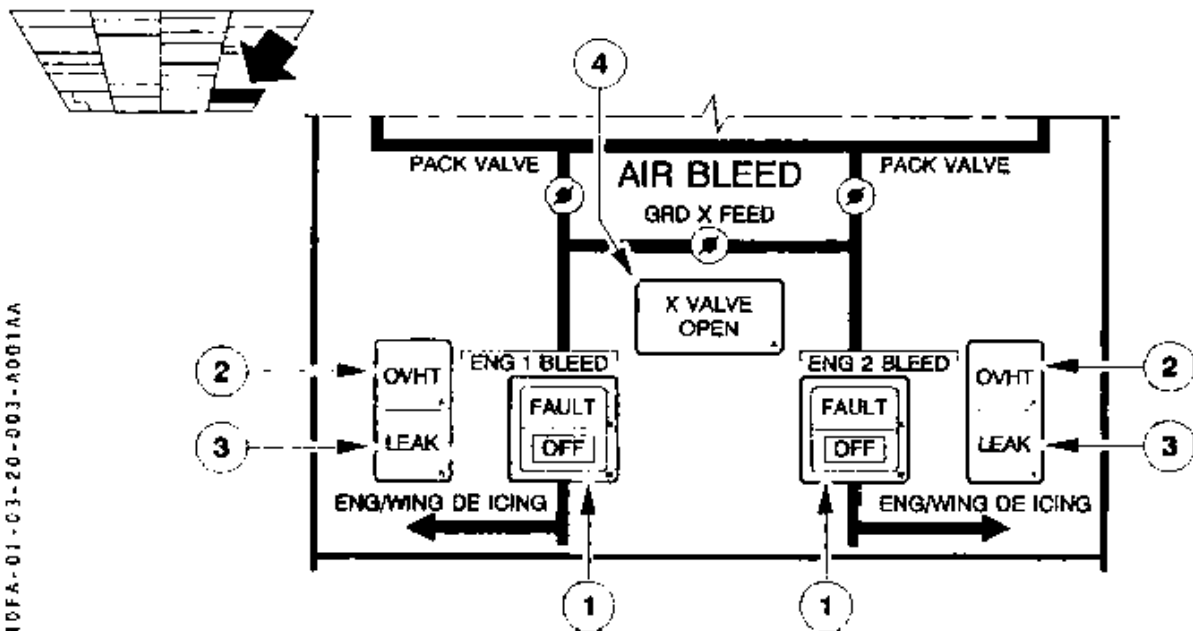

① ENG BLEED pbs

Controls the associated HP valve and BLEED valve.

ON (pb pressed in) associated HP and bleed valves solenoids are energized. The valves will open if pressure is available.

OFF (pb released) associated HP and bleed valves are closed. OFF light illuminates white.

FAULT The light illuminates amber and the CCAS is activated when the bleed valve position disagrees with the selected position, this especially occurs in case of leak or overhaul.

② OVHT light

The light illuminates amber and the CCAS is activated when either of the respective bleed duct dual overheat sw operates ($T > 274\text{ }^{\circ}\text{C}/525\text{ }^{\circ}\text{F}$).

③ LEAK Light

The light comes on amber and the CCAS is activated when respective bleed leak detection system signal an alert ($T\text{ loop} > 153\text{ }^{\circ}\text{C}/307\text{ }^{\circ}\text{F}$).

④ X VALVE OPEN light

The light illuminates amber when the GRD X FEED valve is open.



ATR 72
F.C.O.M.

AIR

1.03.20

P 4

001

PNEUMATIC SYSTEM

DEC 96

20.3 ELECTRICAL SUPPLY/MFC LOGIC/SYSTEM MONITORING

ELECTRICAL SUPPLY

EQUIPMENT	DC BUS SUPPLY (C/B)	AC BUS SUPPLY (C/B)
ENG 1 HP valve	DC BUS 1 (on lateral panel HP NORM)	- Nil -
Bleed valve	DC ESS BUS (on lateral panel BLEED)	- Nil -
Fault and OVHT alert light	DC ESS BUS (on lateral panel CAUTION)	- Nil -
ENG 2 HP valve	DC BUS 2 (on lateral panel HP NORM)	- Nil -
Bleed valve	DC ESS BUS (on lateral panel BLEED)	- Nil -
FAULT and OVHT alert light	DC ESS BUS (on lateral panel CAUTION)	- Nil -
CROSSFEED Crossfeed valve and associated OPEN light	DC BUS 1 (on lateral panel X FEED)	- Nil -
LEAK Bleed leak detection system	- Nil -	115 VAC BUS 1 (on lateral panel BLEED LEAK DET)
LEAK lights	DC BUS 1 (on lateral panel CAUTION)	- Nil -

	AIR	1.03.20		
	PNEUMATIC SYSTEM	P 5	100	
				JUL 00

AA

MFC LOGIC

See chapter 1.01.

SYSTEM MONITORING

The following conditions are monitored by visual and aural alerts :

- Bleed valve position in disagree with command.
 - See BLEED VALVE FAULT procedure in chapter 2.05.08.
- Overheat in bleed duct ($T_{duct} > 274^{\circ}\text{C}/525^{\circ}\text{F}$).
 - See BLEED OVHT procedure in chapter 2.05.08.
- Bleed air leak ($Loop > 153^{\circ}\text{C}/307^{\circ}\text{F}$)
 - See BLEED LEAK procedure in chapter 2.05.08.

 NR72 F.C.O.M.	AIR	1.03.20	
	PNEUMATIC SYSTEM	P 6	001
			DEC 96

20.4 LATERAL MAINTENANCE PANEL

On the RH maintenance panel, a magnetic indicator and a leak test button are provided, for air bleed system maintenance purposes only.

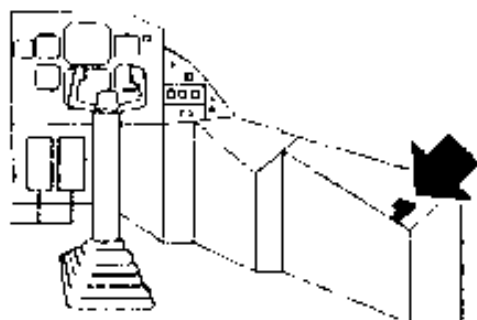
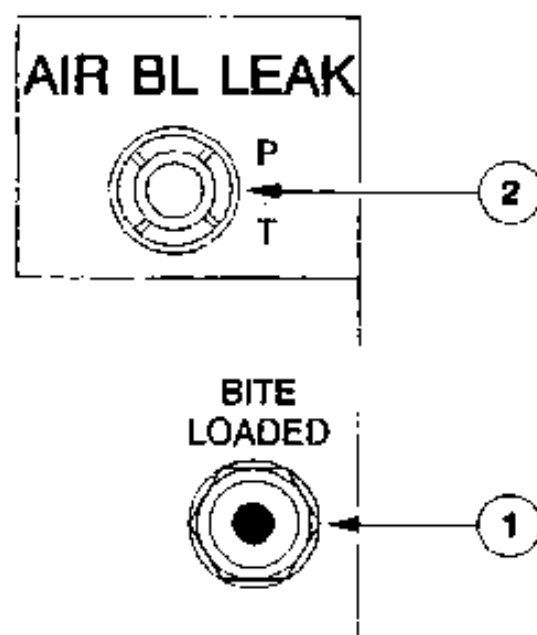

① BITE LOADED magnetic indicator

Indicates that a failure - "LH or RH HP valve position disagrees with the closed selected position" - has been recorded by the maintenance system.

② Push to test button

Is used to check the functioning of both ambient overheat detection circuits along the bleed air ducts. When depressed, both "LEAK" lights illuminate on the overhead panel.

20.5 SCHEMATIC

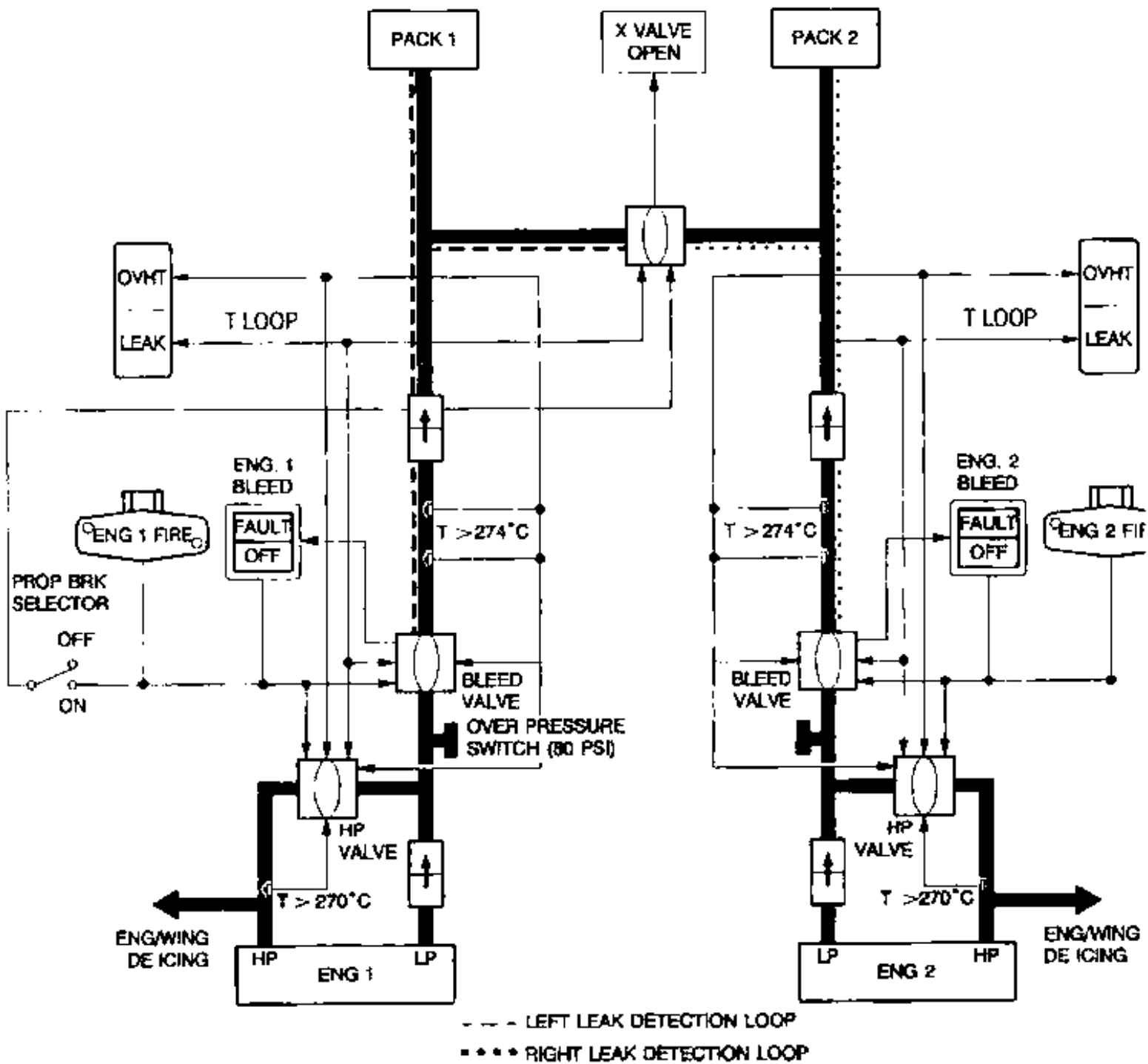

	AIR	1.03.30		
		P 1	500	
	AIR CONDITIONING			JUN 97

30.1 DESCRIPTION (See schematics p. 13/14 and p. 15/16)

AIR PRODUCTION

The air conditioning system is supplied by air processed through two packs which regulate air flow and temperature as required (see page 13/14). The two packs are installed in the main landing gear fairings and operate automatically and independently.

The left pack supplies the cabin and the cockpit air conditioned ; the right pack supplies only the cabin air conditioned.

Note : if one pack is inoperative, the other one supplies both compartments through the mixing chamber, (see page 15/16).

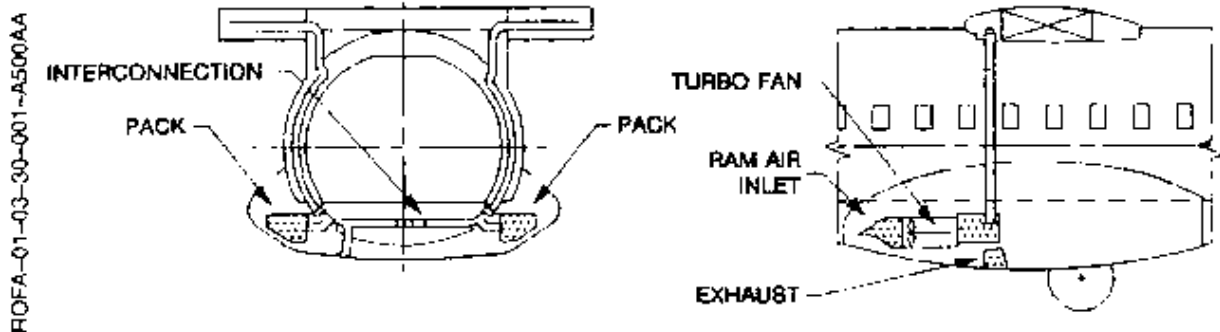

Hot air from the engines is admitted through pack valves and conditioned (cooled, dried, compressed) into the packs.

The pack valve is pneumatically operated and electrically controlled. This butterfly valve has two functions:

- Pack shut off.
- Pressure control and hence flow control. Normal or high flow are available. The selection of the high flow mode increases the pack entrance pressure resulting in conditioning performance improvement.

Without air pressure and regardless of electrical command, the pack valve is spring-load closed. It will also close without electrical supply.

Note : Pack valves will be automatically closed in case of leak detection.

Cooling of air is performed :

- by two ground turbo fans through turbo shut off valves when :
 - . IAS \leq 150 kt and landing gear is retracted for less than 10 min.
 - . IAS \leq 150 kt and landing is extended.
- by ram air when IAS > 150 kt.

Note : Incorrect position of a turbo fan shut off valve leads to closure of associated pack valve.

	AIR	1.03.30		
	AIR CONDITIONING	P 2	001	
				DEC 96

AIR VENTILATION

Conditioned air is blown into the cabin by outlet ramps located under the hot racks. It is then evacuated through guides along the cabin side walls at floor level. A part of it is recirculated by the fans, the other part being evacuated overboard through the outflow valves installed in the rear under floor.

The toilet is ventilated by differential pressure through a vent line.

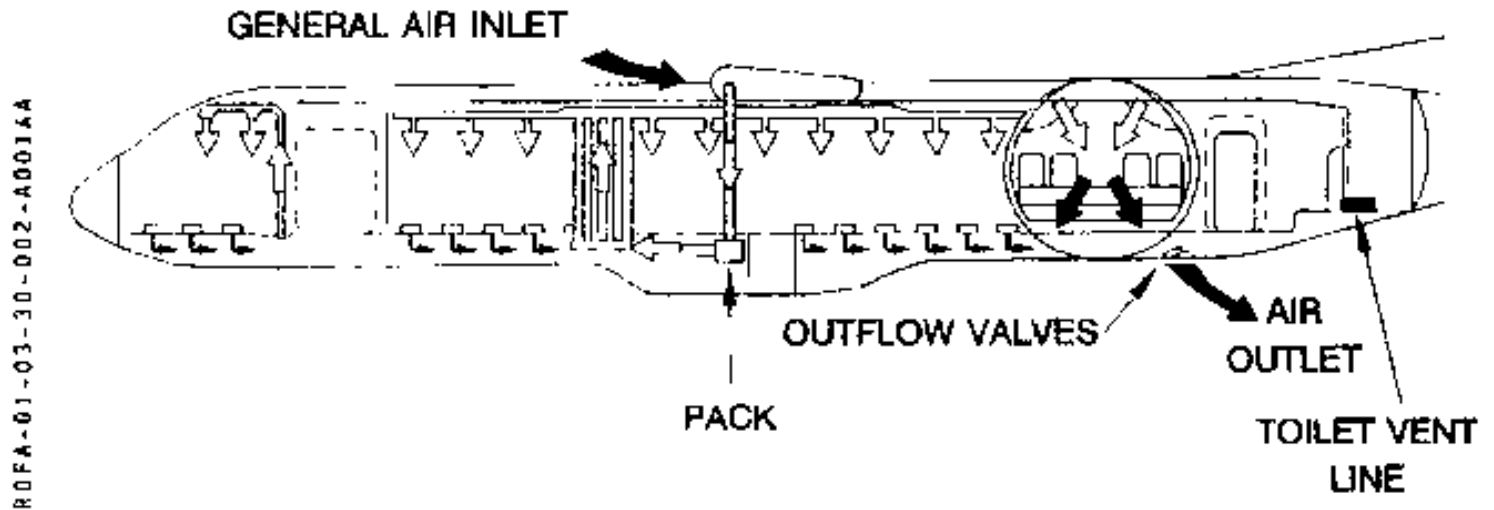

ROFA-01-03-30-002-A001AA

	AIR		1.03.30	
			P 3	200
	AIR CONDITIONING		JUN 97	

Flight deck, forward cargo compartment, electric and electronic equipments are ventilated by flow of ambient air which is :

- Recirculated (underfloor) to the pressurized compartment, or
- Ducted overboard.

The selection is operated by the overboard (OVBD) valve which controls the underfloor (U/F) valve :

- OVBD full closed → U/F open
- OVBD partially or full open → U/F closed
- OVBD NORMAL MODE : Automatic selection
- OVBD MANUAL MODE : to be used in case of AUTO MODE failure or, on ground, to accelerate cabin heating (Full closed position).

Air is extracted by a fan which may operate at different speeds depending on flight deck temperature : Rotation speed is minimum below 20°C (68°F), maximum above 52°C (126°F) and varies linearly between these values.

Only when OVBD valve AUTO MODE is selected, EXHAUST mode pb may be used to control OVBD valve in a partially open position. This action is required in case of fan failure to provide cooling air flow by allowing cabin differential pressure.

In case of smoke in forward cargo compartment, flight deck air extraction duct can be closed with a lever located on right side maintenance panel in order to avoid contaminated air suction to the flight deck.

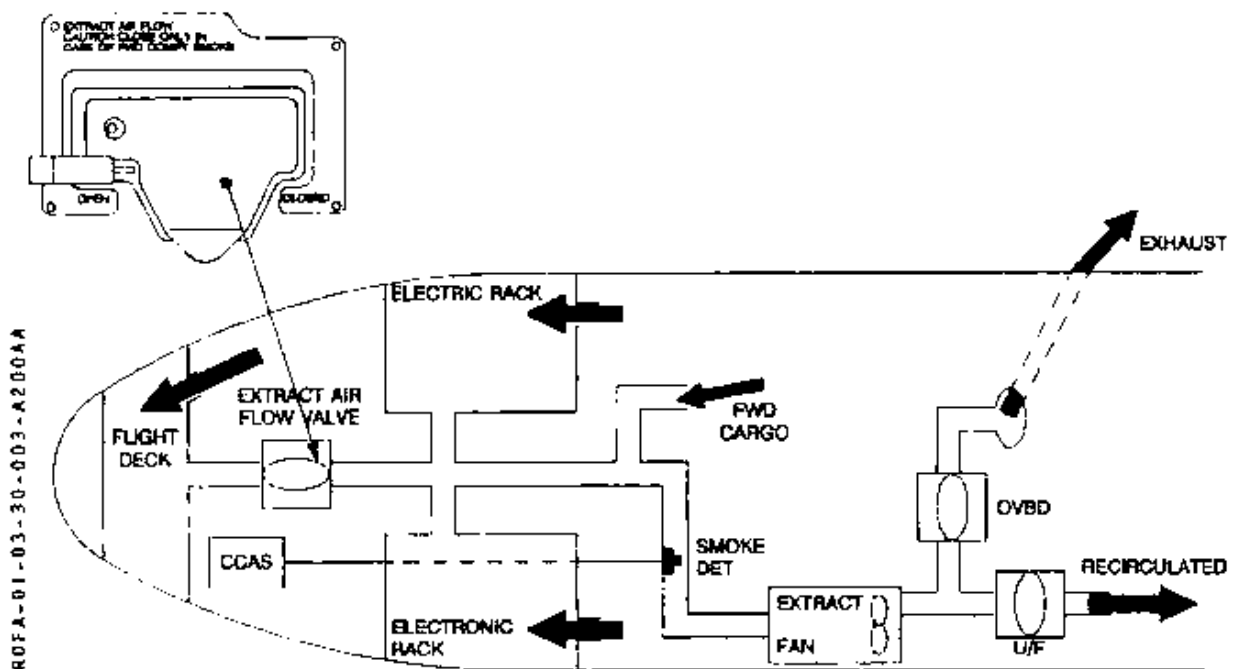

	AIR	1.03.30		
	AIR CONDITIONING	P 4	001	
				DEC 96

AA

TEMPERATURE CONTROL

The system is designed to regulate and limit the temperature of the air discharged from the packs which is supplied to the different zones :

- FLT COMPT by the left pack
- CABIN by the right pack and excess air from the left pack.

To establish the required temperature, the amount of added hot air, mixed with cool air is varied through the pack temperature control valves.

In automatic mode, each pack discharge temperature is controlled by an electronic temperature controller which computes temperature control valve position taking into account :

- Duct temperature
- Zone temperature demand selector
- Associated compartment temperature
- Aircraft skin temperature

In manual mode, each pack temperature control valve is controlled directly by the zone temperature demand selector and limited by the pneumatic temperature sensor.

OVERHEAT PROTECTION

When duct temperature downstream of the mixing chamber increases over $T = 88^{\circ}\text{C}$ (191°F), the limiter closes the temperature control valve progressively by a pneumatic action in order to reduce hot air flow.

An OVHT caution is provided to the pilot when $T_{\text{duct}} > 92^{\circ}\text{C}$ (200°F) (but the pack valve does not close).

In case of overheat downstream of the pack compressor ($T > 204^{\circ}\text{C}$ (399°F)) the pack valve closes automatically.

 AJR72 F.C.O.M.	AIR	1.03.30		
	AIR CONDITIONING	P 5	001	
				DEC 96

AA

30.2 CONTROLS

COMPT TEMP PANEL

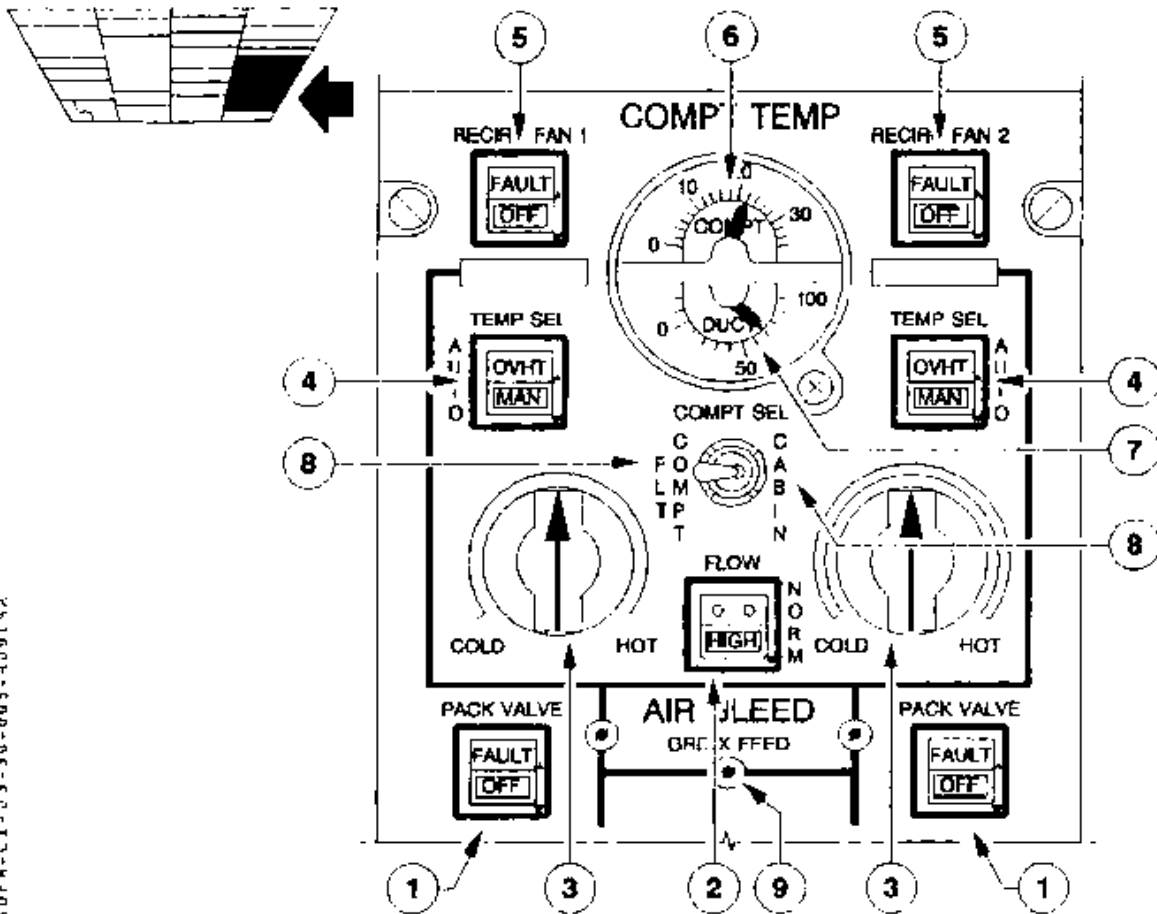

R0FA-C1-03-30-005-009142

① PACK VALVE *pb*

pb pressed in Associated PACK VALVE is open if electrical supply and air pressure are available.

Note : A 6 seconds delay has been provided on right pack valve for passengers comfort purpose.

OFF (*pb* released) Associated PACK VALVE is closed. The OFF light illuminates white.

FAULT Illuminates amber and the CCAS is activated when the PACK VALVE position disagrees with the selected position or in case of overheat downstream of the pack compressor ($T > 204^{\circ}\text{C}/393^{\circ}\text{F}$). In the later case, the valve is latched closed automatically.

	AIR	1.03.30		
		P 6	001	
	AIR CONDITIONING			DEC 96

② FLOW pb

NORM (pb released) Both pack valves are controlled automatically to give 22 PSI regulated pressure.

HIGH (pb pressed in) Both pack valves are controlled to give 30 PSI regulated pressure which increases the flow accordingly. The HIGH light illuminates blue.

③ COMPT TEMP selectors

For the related compartment the temperature is either automatically controlled by the electronic controller taking into account the selector position or manually selected by direct operation of the temperature control valve through the selector.

④ TEMP SEL pb

Selects the temperature control mode of operation.

AUTO : (pb pressed in) Automatic mode is selected. The electronic temperature controller controls the valve position.

MAN : (pb released) Manual mode is selected. The COMPT TEMP selector directly controls the position of the valve.

The pneumatic temperature limiter will limit the max duct temperature below $T = 88^{\circ}\text{C}$ (191°F). The MAN light illuminates white.

OVHT : Illuminates amber and the CCAS is activated when an over temperature is detected in the duct ($T > 92^{\circ}\text{C}/200^{\circ}\text{F}$). It is not inhibited in MAN mode.

⑤ RECIRC FAN pb

Selects operation of the respective recirculation fan.

pb pressed in : (pb depressed) Fan runs. Recirculation of a part of the cabin air to supplement the conditioned air supply is provided.

Fan rotation speed linearly varies from 1500 RPM to 2200 RPM depending on temperature control valve position. If temperature measured at cabin floor level is lower than 18°C (61°F), high speed is automatically selected.

OFF : (pb released) Fan stops. All the air is supplied by the packs without recirculation. The OFF light illuminates white.

FAULT : Illuminates amber and the CCAS is activated in case of either low fan RPM (< 900 RPM) or fan electrical motor overheat conditions.

⑥ COMPT ind.

Air temperature in the selected compartment is indicated in $^{\circ}\text{C}$.

⑦ DUCT ind.

For the selected compartment, the temperature of the conditioned air before leaving the duct is indicated in $^{\circ}\text{C}$.

Duct temperature is automatically limited to max 88°C in AUTO mode or MAN mode.

⑧ COMPT selector

Selects the zone – FLT COMPT or CABIN – for which temperature (COMPT and DUCT) reading is desired.

⑨ GND X FEED

See chapter 1.03.20.

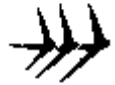
 ATR 72 F.C.O.M.	AIR	1.03.30		
	AIR CONDITIONING	P 7	200	
				JUN 97

AVIONICS VENT PANEL

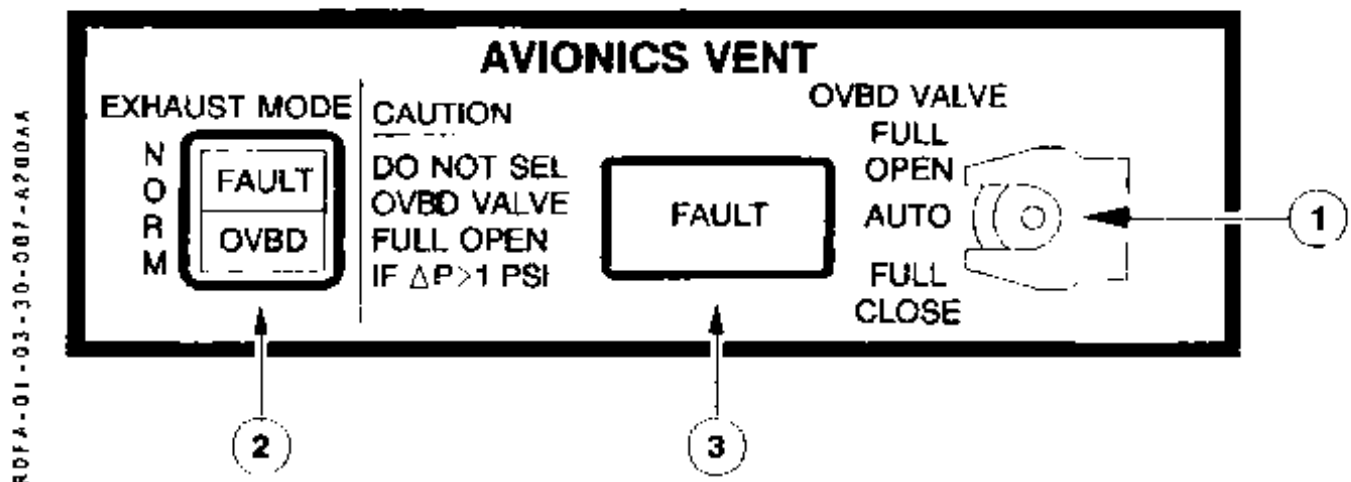

① OVBD VALVE CTL switch

The selector is operated to manually full open or full close the OVBD valve if required. In normal configuration, the selector must be guarded in AUTO position in order to allow proper selection of the EXHAUST mode.

FULL OPEN The OVBD valve is fully open.

CAUTION : DO NOT SELECT OVBD VALVE FULL OPEN IF DIFFERENTIAL PRESSURE EXCEEDS 1 PSI.

AUTO The DVBD valve position is function of :
 . The EXHAUST mode PB selection
 . The aircraft condition (flight or ground)

FULL CLOSE The OVBD valve is fully closed.

	AIR	1.03.30		
	AIR CONDITIONING	P 8	200	
				JUN 97

② EXHAUST MODE PB

Controls the OVBD valve as long as OVBD valve CTL sw is in AUTO position.

NORM

(pb pressed in) :

- On ground, engine 1 not running (OIL LOW PRESS)
 - extract fan runs continuously
 - OVBD valve is full open
 - U/F valve is closed
- in flight (or on ground, engine 1 running)
 - extract fan runs continuously
 - OVBD valve is full closed
 - U/F valve is open

OVBD

(pb released) :

- extract fan is OFF 200
- OVBD valve is partially open (in flight only)
- U/F valve is closed
- OVBD light illuminates white

FAULT

Illuminates amber and the CCAS is activated in case of fan failure or overheat.

Note 1 : Aircraft on ground and external power available :

if exhaust mode is set on OVBD position, a ground mechanic call is generated and intermediate position is inhibited.

Note 2 : When start sequence is initiated, extract fan stops for 120s to avoid pressure shocks. Exhaust mode fault illuminates, however the ground mechanic call is not generated.

③ FAULT LIGHT

Illuminates amber and the CCAS is activated when there is an OVBD VALVE position disagreement :

- when on ground, engine 1 not running (OIL LOW PRESS) OVBD valve is not fully open (except with CTL sw on FULL CLOSE)
- when, in flight or, on ground engine 1 running, OVBD valve is fully open (except with CTL sw ON FULL OPEN)

The LIGHT goes off when the OVBD VALVE reaches the selected position.

	AIR	1.03.30		
	AIR CONDITIONING	P 9	200	
				JUN 97

FLIGHT DECK VENTILATION ISOLATION

EXTRACT AIR FLOW

CAUTION : Close only in case of FWD COMPT smoke.

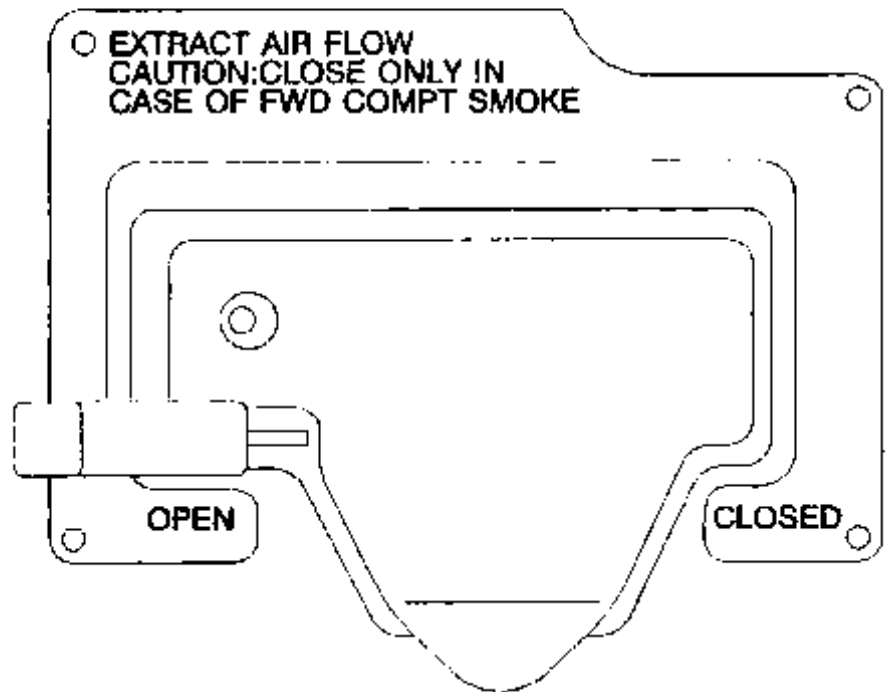
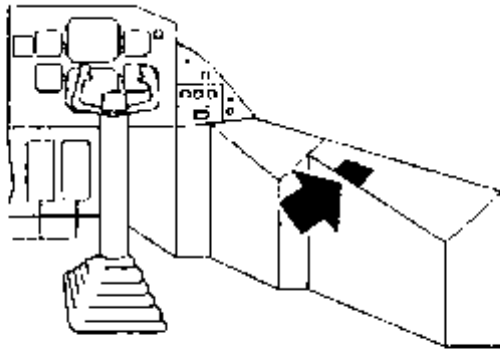

R2FA-01-03-30-009-A200AA

Enables, in case of smoke in the forward cargo compartment, to isolate the flight deck ventilation preventing smoke to enter the flight compartment.

	AIR	1.03.30	
		P 10	001
	AIR CONDITIONING		DEC 96

30.3 ELECTRICAL SUPPLY/MFC LOGIC/SYSTEM MONITORING

ELECTRICAL SUPPLY

EQUIPMENT	DC BUS SUPPLY (C/B)
<i>LH SIDE</i> Pack valve	DC ESS BUS (on lateral panel PACK VALVE)
Recirculation fan	DC UTIL BUS 1 (on lateral panel PWR SUPPLY CTL)
Pack and recirculation fan alert	DC ESS BUS (on lateral panel PACK and RECIRC FAN CAUTION)
FLT COMPT automatic temperature control	DC ESS BUS (on lateral panel AUTO)
FLT COMPT Manual temperature control	DC ESS BUS (on lateral panel MAN)
<i>RH SIDE</i> Pack valve	DC ESS BUS (on lateral panel PACK VALVE)
Recirculation fan	DC UTIL BUS 2 (on lateral panel PWR SUPPLY CTL)
Pack and recirculation fan alert	DC ESS BUS (on lateral panel PACK and RECIRC FAN CAUTION)
Automatic temperature control	DC ESS BUS (on lateral panel AUTO)
Manual temperature control	DC ESS BUS (on lateral panel MAN)
Compartment and duct temperature ind.	DC BUS 1 (on lateral panel COMPT and DUCT TEMP IND)
TURBO FAN SHUT OFF VALVE 1 CTL	DC BUS 1 (On lateral panel)
TURBO FAN SHUT OFF VALVE 2 CTL	DC BUS 2 (On lateral panel)

 A320 F.C.O.M.	AIR	1.03.30		
	AIR CONDITIONING	P 11/12	001	
				DEC 96

AA

EQUIPEMENT	DC BUS SUPPLY (C/B)
OVBD valve, U/F valve	DC EMER BUS (on lateral panel VALVES)
Extract fan control relay	DC ESS BUS (on lateral panel CTL)
EXTRACT FAN Contactor	DC BUS 2 (on lateral panel EXTRACT FAN)
EXTRACT FAN Contactor	DC BUS 1 (on lateral panel EXTRACT FAN)

MFC LOGIC

See chapter 1.01

SYSTEM MONITORING

The following conditions are monitored by visual and aural alerts :

- Pack valve position in disagree with command or overheat downstream of the compressor ($T > 204^{\circ}\text{C}/393^{\circ}\text{F}$).
 - See PACK VALVE FAULT procedure in chapter 2.05.08.
- Overheat in bleed duct ($T_{\text{duct}} > 274^{\circ}\text{C}/525^{\circ}\text{F}$).
 - See BLEED OVHT procedure in chapter 2.05.08.
- Recirculation fan low RPM or internal overheat.
 - See RECIRC FAN FAULT procedure in chapter 2.05.08.
- Underspeed or overheat of extract fan ($T > 90^{\circ}\text{C}/194^{\circ}\text{F}$).
 - See AVIONICS VENT EXHAUST MODE FAULT procedure in chapter 2.05.08.
- OVBD VALVE position not corresponding with aircraft condition.
 - See OVBD VALVE FAULT procedure in chapter 2.05.08.

Note : In case of overheat downstream of the compressor, alert is maintained on magnetic indicator (RH maintenance panel) even if fault disappears (See chapter 1.03.20).

30. SCHEMATICS

PACK

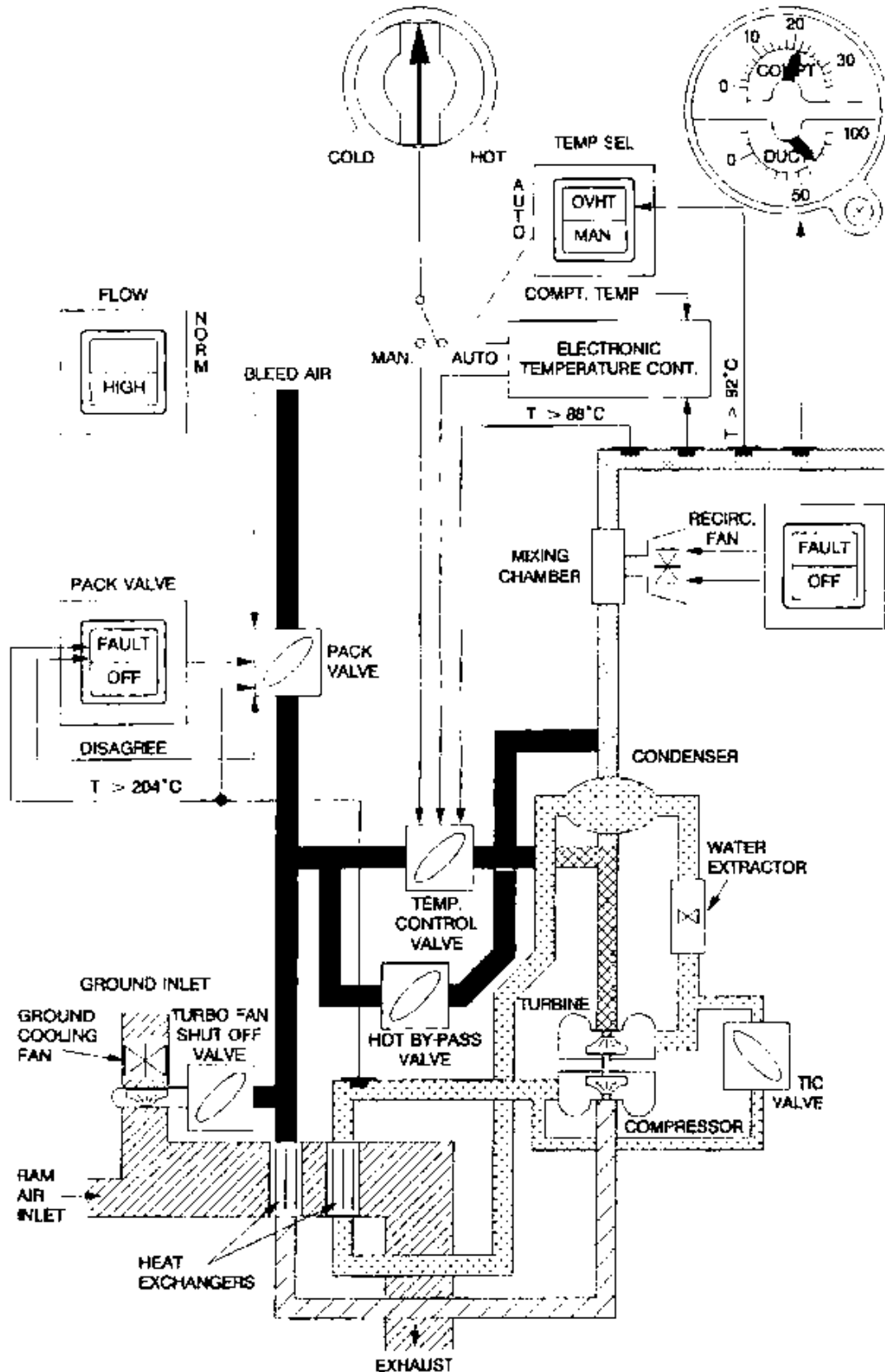

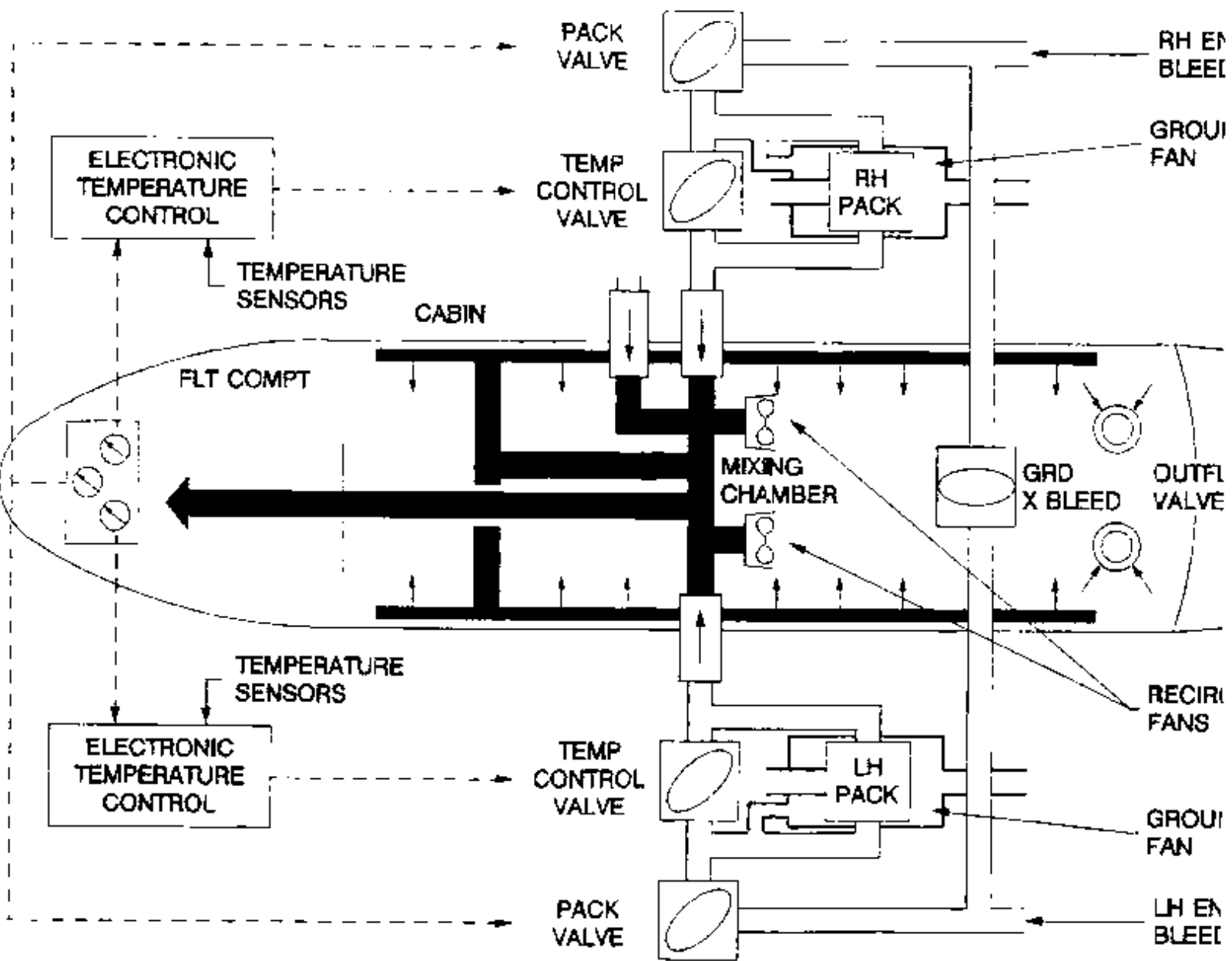

 NR72 F.C.O.M.	AIR PRESSURIZATION	1.03.40		
		P 1	001	
				DEC 96

AA

40.1 DESCRIPTION

Cabin pressure and rate of change control is obtained through :

- A fully automatic digital electronic controller, or
- A manual pneumatic controller,

which control the outflow of conditioned air to a level compatible with passenger and crew members comfort.

Two outflow valves are installed :

- An electropneumatic,
- A pneumatic.

In Auto Mode, the pneumatic valve is slaved to the electropneumatic one. Their opening will be the same.

Each outflow valve includes devices for the required safety function in case of controller failure :

- The positive differential pressure is limited to 6.35 PSI by a manometric capsule.
- The negative differential pressure is limited to - 0.5 PSI by a non return valve.

Note : The manual controller knob must be selected to NORM position in order not to disturb the automatic regulation.

 AR72 F.C.O.M.	AIR	1.03.40		
		P 2	001	
	PRESSURIZATION			DEC 96

AA

AUTO MODE

The digital controller generates a signal for positioning outflow valves during all phases of flight. The parameters received by the controller for signal computation are :

- Landing elevation from landing elevation selector
- Take off elevation memorized by the controller
- Cabin pressure
- Aircraft static pressure generated by ADC 1 with CAPT altimeter baro setting or, in case of ADC 1 failure, aircraft static pressure generated by ADC 2 with a 1013.2 HPa reference (29.92 in Hg).

The controller computes a theoretical cabin altitude and then, sends a signal to the electropneumatic outflow valve torque motor in order to adjust the actual cabin altitude by opening or closing the two outflow valves.

The loss of electrical signal causes closing of the valve.

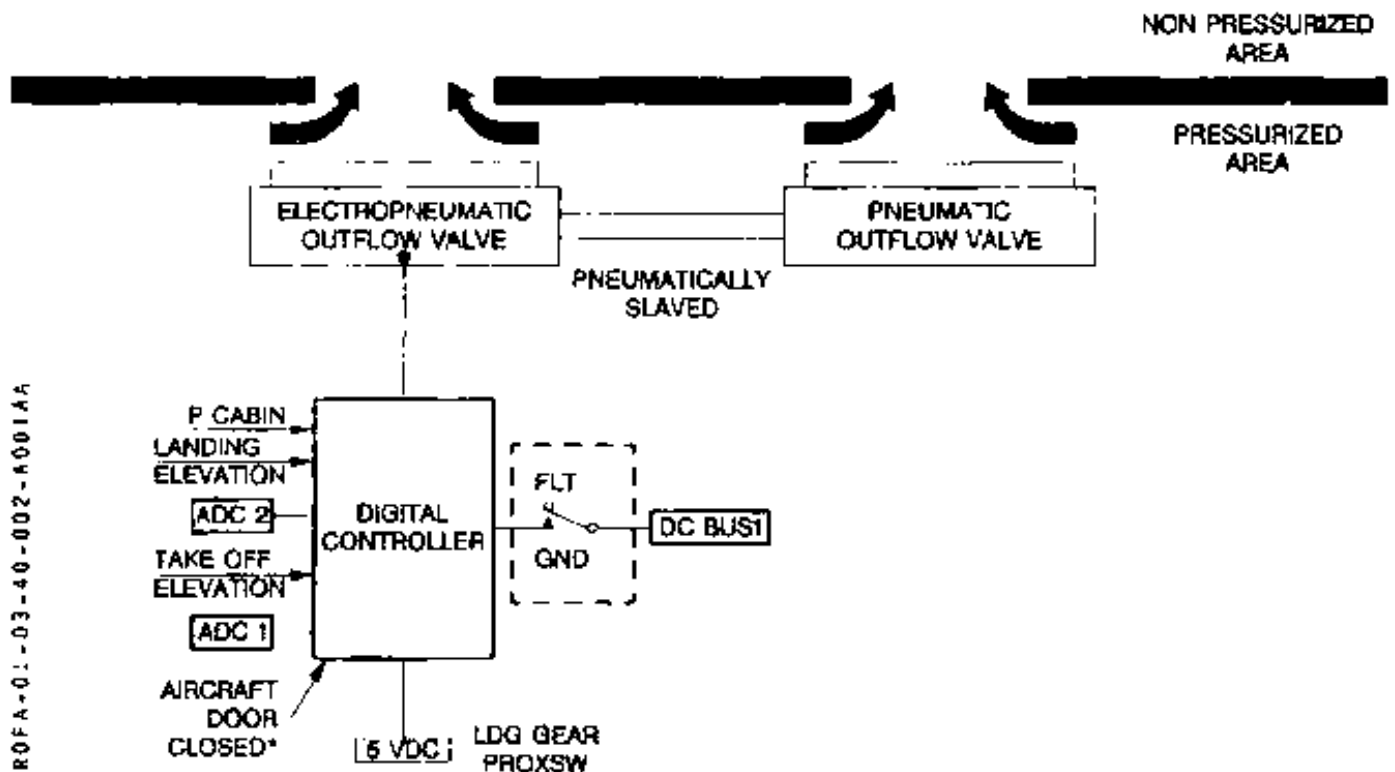

	AIR	1.03.40		
		P 3	001	
	PRESSURIZATION			DEC 96

DUMP FUNCTION

A DUMP function is available to send a fully open electrical signal to the electropneumatic outflow valve.

DUMP function is available as long as pressurization system is in AUTO mode.

CAUTION : The DUMP PB is mechanically protected. No other safety device protects DUMP function from inadvertent use.

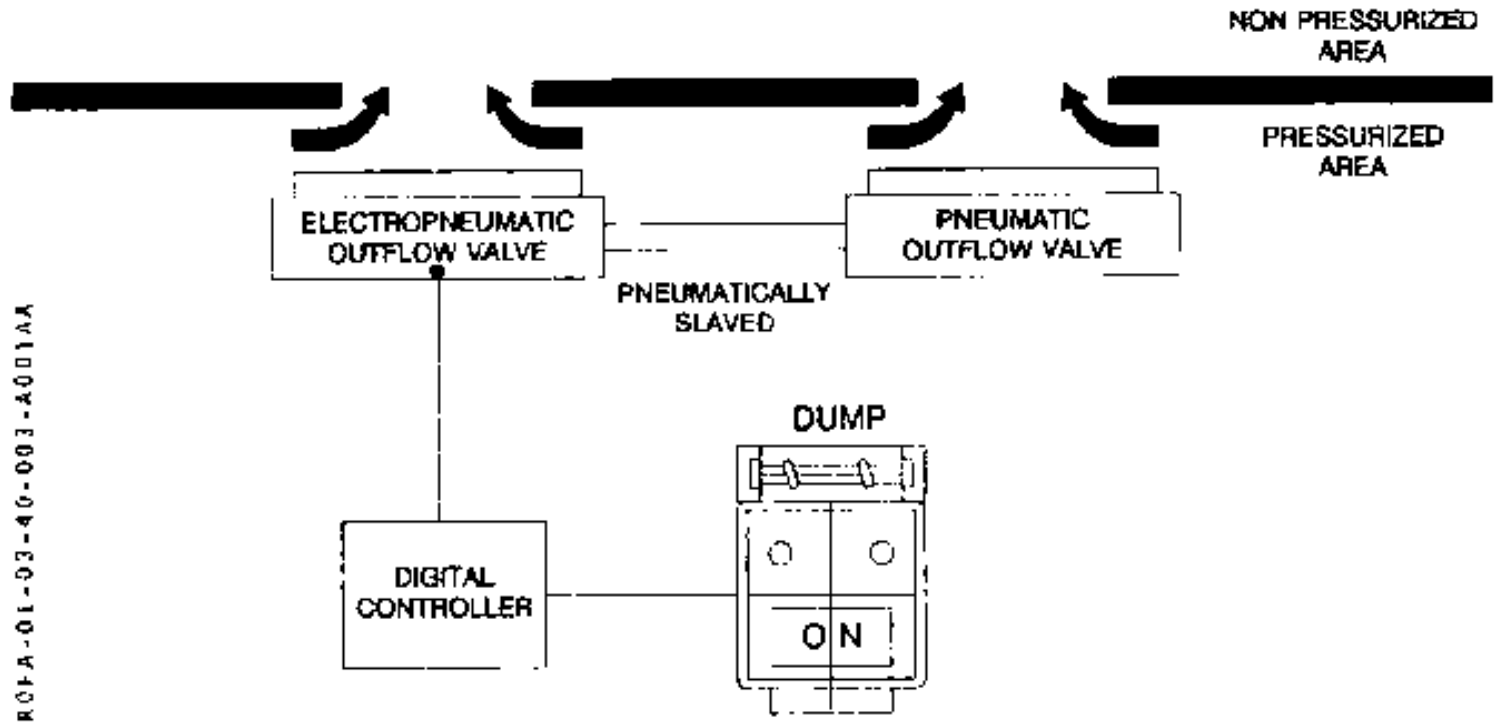



R01A-01-03-40-003-A001AA

	AIR	1.03.40	
		P 4	001
	PRESSURIZATION		DEC 96

MANUAL MODE

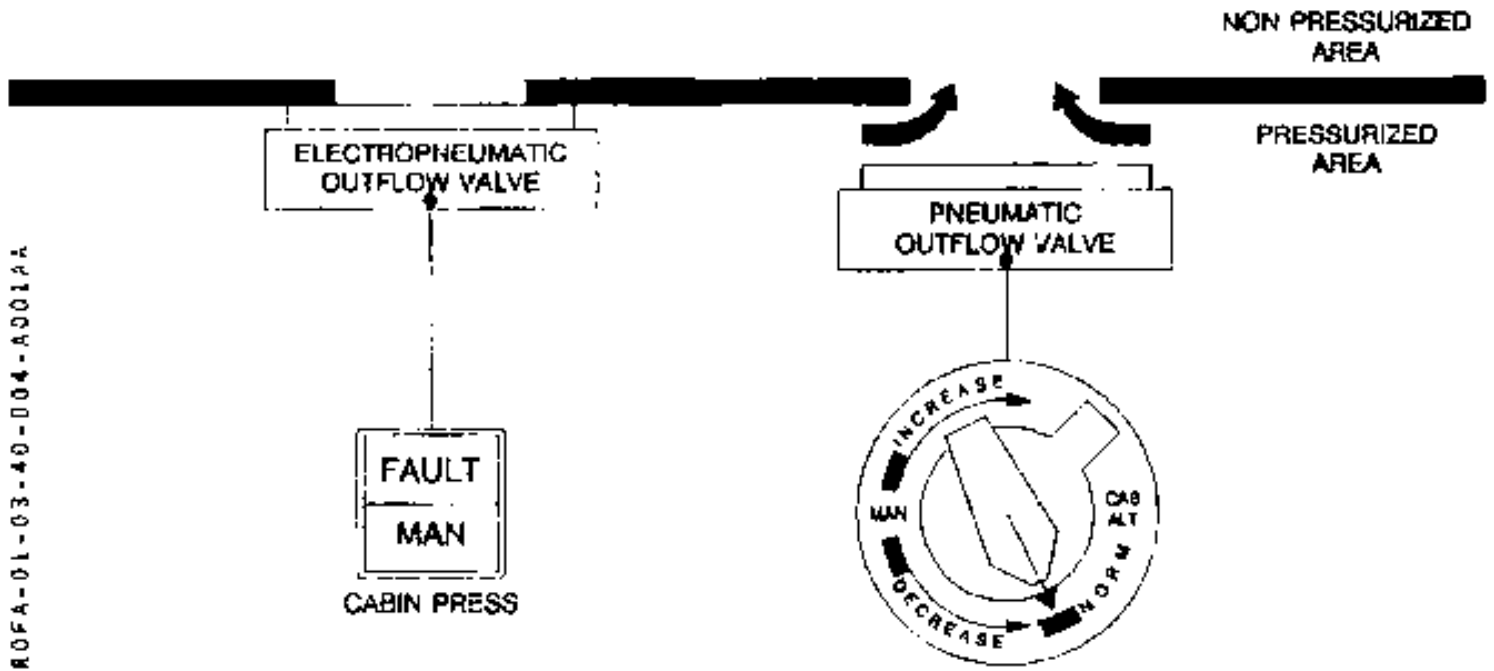
The electropneumatic outflow valve is maintained closed and the pneumatic outflow valve controls the cabin outlet air flow. Its control servo pressure is function of the manual controller demand. The control knob is used to select any cabin rate of change from - 1500 ft/mn to + 2500 ft/mn.



	AIR	1.03.40		
	PRESSURIZATION	P 5	001	
				DEC 96

DITCHING MODE

Two electrical motors (one for each outflow valves) maintain both outflow valves in closed position.

Ditching mode is available in both automatic and manual modes.

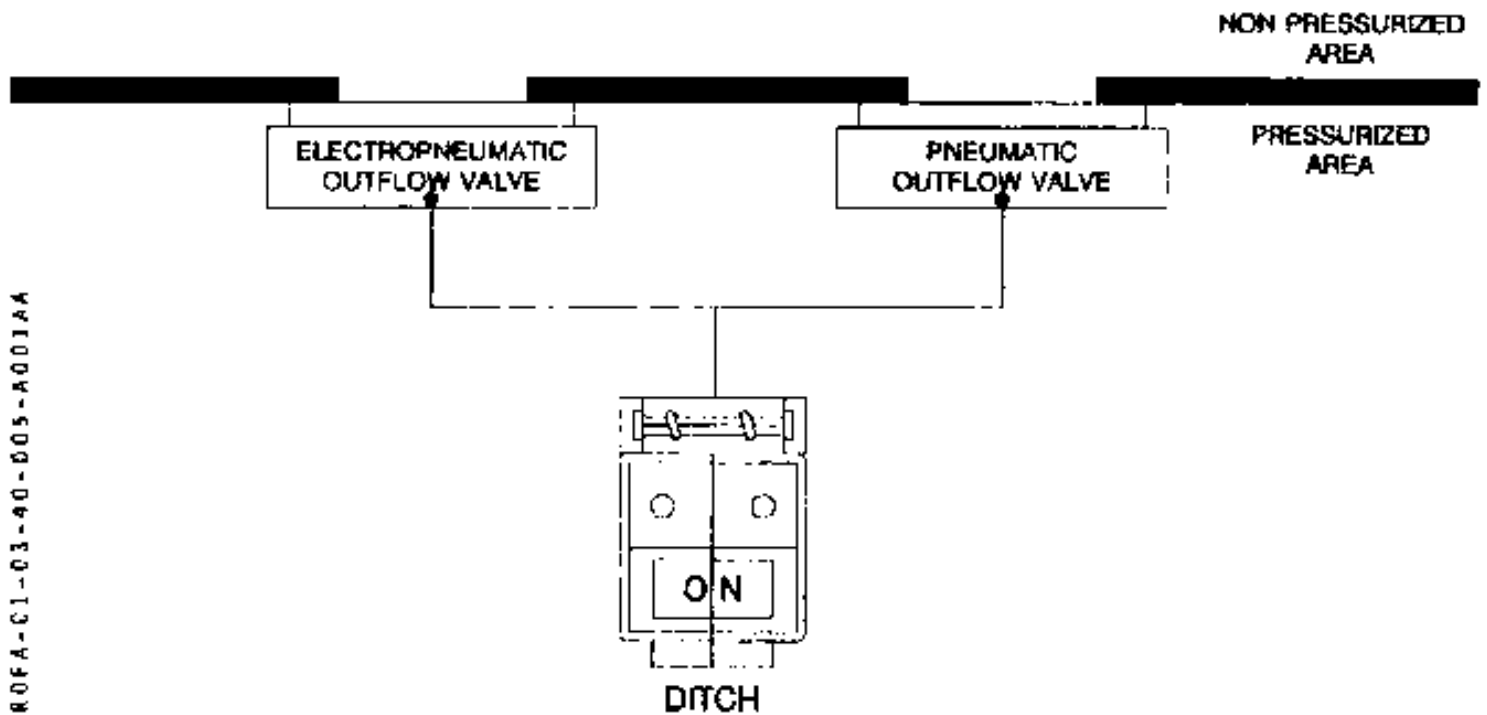

	AIR	1.03.40	
	PRESSURIZATION	P 6	001
		DEC 96	

40.2 CONTROLS

AUTO PRESS PANEL

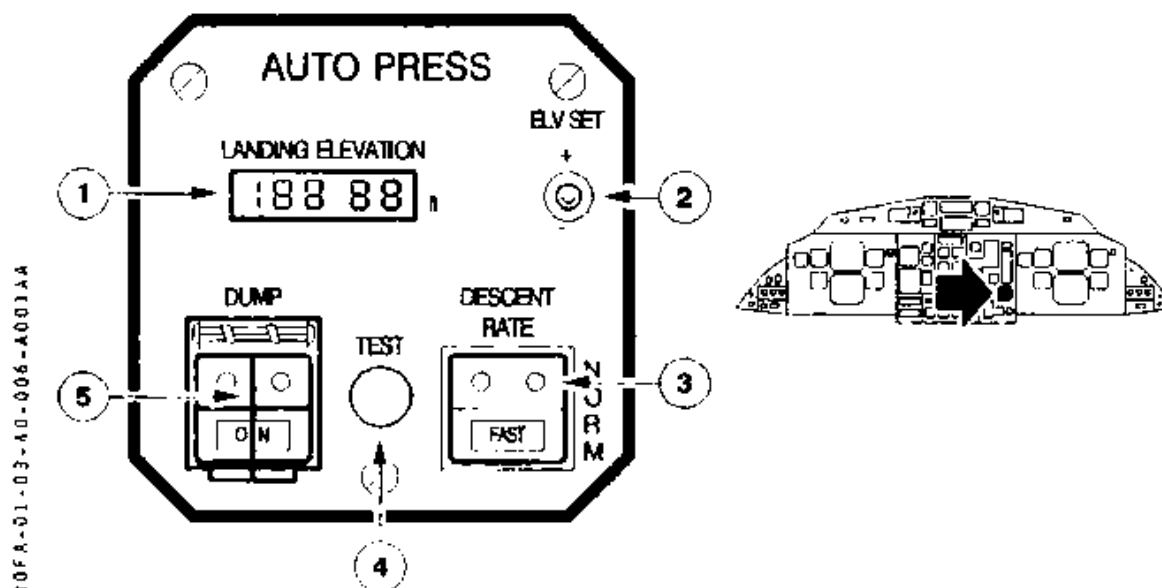

① LANDING ELEVATION ind.

Displays in ft the landing elevation setting. The two last digits always display 0. All digits will extinguish in case of automatic system failure.

② ELV SET trigger switch

Allows selection of the elevation of the planned destination airport in 100 ft increments. The landing altitude ranges between - 1500 ft and 9900 ft.

③ DESCENT RATE pb

Is operated to allow a fast cabin descent.

NORM (pb released) The max cabin vertical speed in descent is - 400 ft/mn.

FAST (pb pressed in) The max cabin vertical speed in descent is - 500 ft/mn. The FAST LIGHT illuminates blue.

④ TEST pb

When depressed, the system is electrically tested. If the system is ready to use, the LANDING ELEVATION ind. displays alternately 18800 and - 8800. Fault light illuminates amber on MAN pb.

In flight, this test is inhibited.

⑤ DUMP guarded pb

This guarded pb allows selection of the dump function when in AUTO mode.

NORMAL (pb released) The digital controller operates normally.

ON (pb pressed in) The digital controller is out of circuit and an electrical opening signal is sent to the electropneumatic outflow valve. Both outflow valves will fully open. The ON light illuminates white.

 ATR72 F.C.O.M.	AIR	1.03.40		
	PRESSURIZATION	P 7	001	
				DEC 96

MAN PRESS CONTROLS

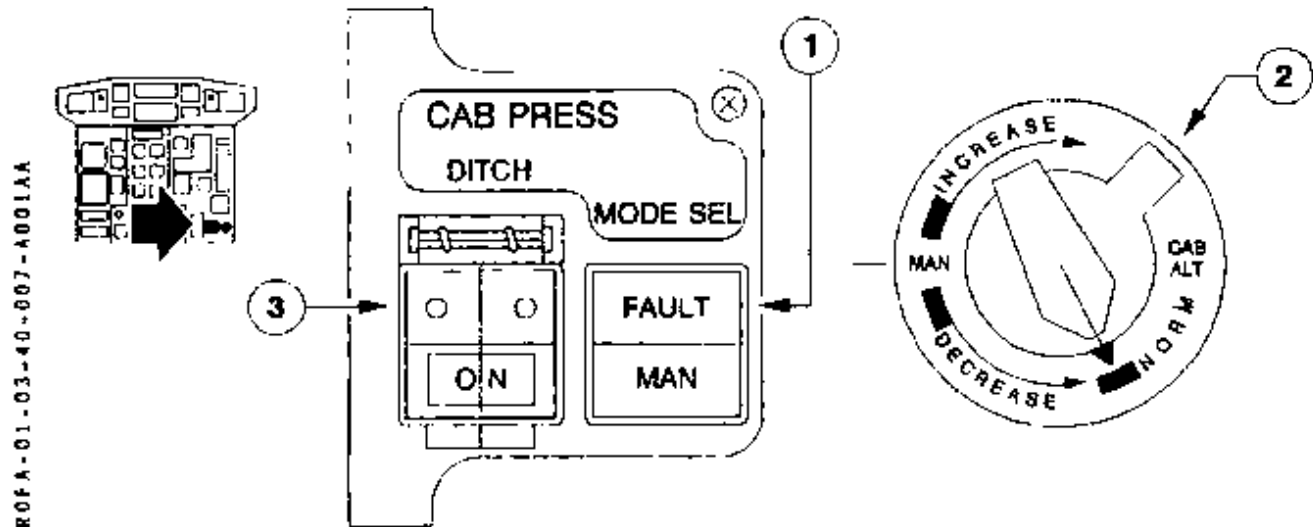

① MODE pb

Selects the pressure control mode :

pb pressed in : The digital controller is in operation (AUTO mode).

MAN : (pb released) The digital controller is out of operation, digits extinguish and the manual controller regulates the pressure. The MAN light illuminates white.

FAULT : The light illuminates amber to indicate a digital controller failure, associated with a CCAS alert through the MFC.

② MAN RATE knob

In manual mode, the control knob is used to select any cabin rate of change from 1 500 ft/mn to + 2 500 ft/mn.

NORM This position must be used when in AUTO mode.

③ DITCH guarded pb

Selects the ditch mode.

ON : (pb pressed in) both outflow valves are forced to closed position regardless of the pressure control mode. The ON light illuminates white.

CABIN PRESS IND

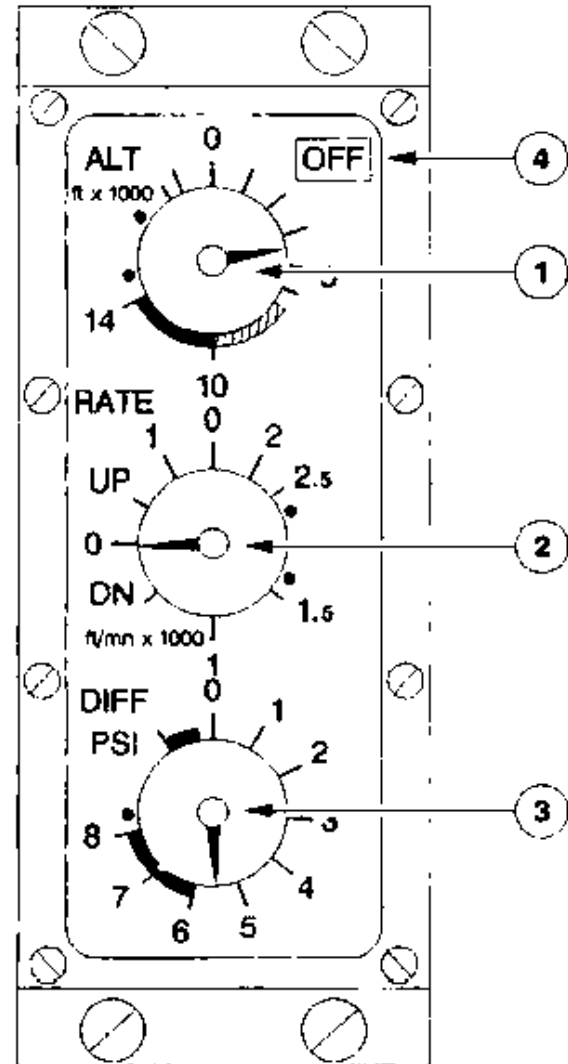
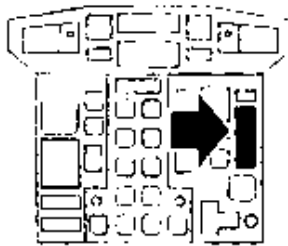

ROFA-01-03-40-008-ADD1AA

① ALT indication

Indicates the cabin pressure in thousands of feet altitude based on 1013.2 HPa (29.92 in Hg).

② RATE indication

Indicates the cabin altitude rate of change in ft/mn X 1 000.

③ DIFF indication

Indicates the differential pressure between cabin and aircraft static pressure from - 1 to + 8 PSI.

④ A red flag appears on the right top of the ind. to indicate the loss of power supply.

	AIR	1.03.40		
	PRESSURIZATION	P 9/10	001	
				DEC 96

AA

40.3 ELECTRICAL SUPPLY/MFC LOGIC/SYSTEM MONITORING

ELECTRICAL SUPPLY

EQUIPMENT	DC BUS SUPPLY (C/B)	AC BUS SUPPLY (C/B)
Digital controller	DC BUS 1 (on lateral panel AUTO PRESS)	- Nil -
Cabin pressure ind.	DC EMER BUS (on lateral panel CAB PRESS IND and WARN)	- Nil -
Pneumatic OUTFLOW Valves	DC EMER BUS (on lateral DITCH)	- Nil -

MFC LOGIC

See chapter 1.01.

SYSTEM MONITORING

The following conditions are monitored by visual and aural alerts :

- Cabin altitude above 10 000 ft.
 - See EXCESS CAB ALT procedure in chapter 2.05.08.
- Differential pressure exceeds 6.35 PSI.
 - See EXCESS CAB Δ P procedure in chapter 2.05.08.
- Digital controller failure.
 - See AUTO PRESS FAULT procedure in chapter 2.05.08.
- Both outflow valves selected in DITCH position.
 - VISUAL alerts are :
 - MC light flashing amber
 - AIR amber light on CAP
 - ON white light on DITCH pb
 - AURAL alert is the single chime.

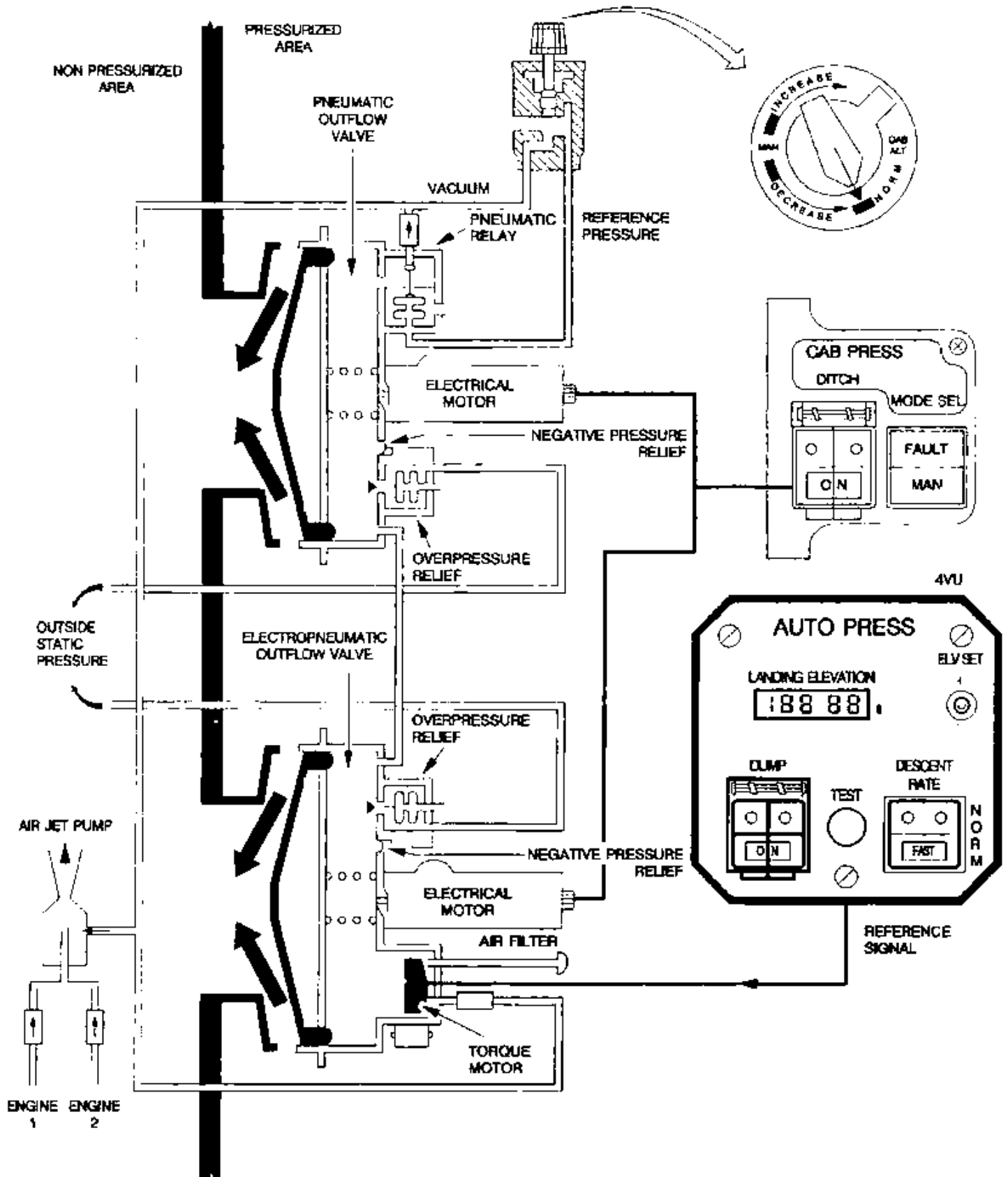

	AFCS CONTENTS	1.04.00		
		P 1	001	
				DEC 96

1.04.00 CONTENTS

1.04.10 GENERAL

R 10.1 DESCRIPTION

R 10.2 CONTROLS

R 10.3 ELECTRICAL SUPPLY / MFC LOGIC

R 10.4 LATERAL MAINTENANCE PANEL

R 10.5 SCHEMATIC

R **1.04.20 AUTOPILOT / YAW DAMPER**

R **1.04.30 FLIGHT DIRECTOR**

R **1.04.40 OPERATION**

R 40.1 SYSTEM OPERATION

R 40.2 AUTOPILOT / FLIGHT DIRECTOR MODES

R **1.04.50 ALTITUDE ALERT**

 ATR 72 F.C.O.M.	AFCS	1.04.10		
		P 1	001	
	GENERAL			JUL 98

AA

10.1 DESCRIPTION (See schematic p 11/12)

The aircraft is provided with an automatic flight control system. It achieves :

- Autopilot function and/or yaw damper (AP and/or YD)
- Flight director function (FD)
- altitude alert

Main components are :

- one computer
- one control panel
- one advisory display unit (ADU)
- three servo-actuators (one for each axis).

The computer receives data from the two Air Data computers (ADC), the two Attitude and Heading Reference Systems (AHRS), the two SGU, the radio-altimeter , the GPS (if installed) and from some sensors.

It generates commands to the flight control actuators and to the FD bars.

Dual microprocessor architecture and digital servo-monitoring technique are used to provide an adequate safety level.

COMPONENT LAYOUT

R0FA-01-04-10-001-A001AA

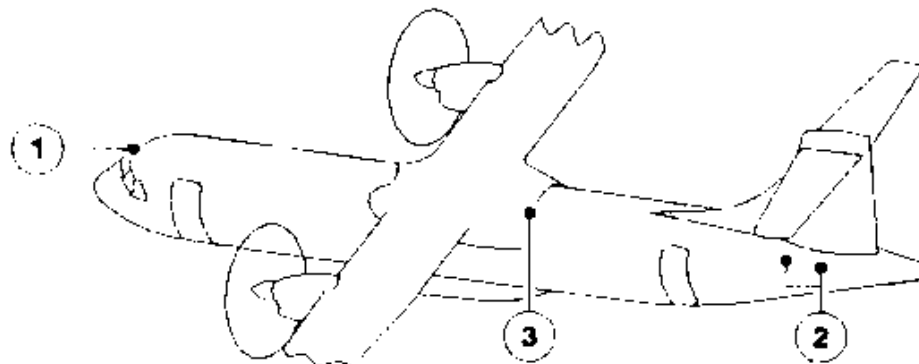

- ① AFCS advisory display, control box and computer (cockpit and electronic rack).
- ② Yaw and pitch servo actuators.
- ③ Roll servo actuator.

	AFCS		1.04.10	
	GENERAL		P 2	001
			DEC 96	

10.2 CONTROLS

AFCS CONTROL PANEL

R01A-01-04-10-002-AC01AA

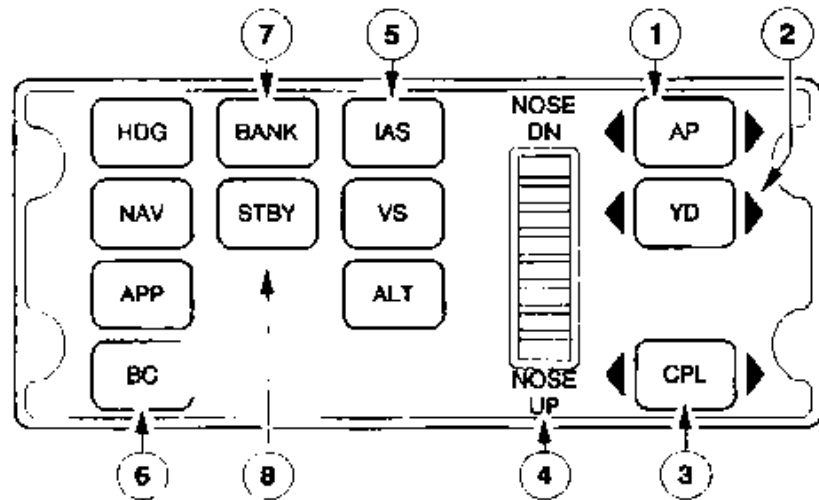
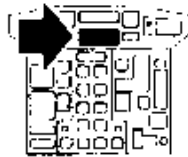

- ① AP pb
Action on the pb engages autopilot and yaw damper functions simultaneously. All four associated arrows illuminate white. A repeat action on the pb disengages only the autopilot function.
- ② YD pb
Action on the pb engages the yaw damper function. Both associated arrows illuminate white. A repeat action on the pb disengages the yaw damper function (and the autopilot if engaged).
- ③ CPL pb
Enables selection of the panel (CAPT or F/O) to be coupled to the AP/FD computer. At power up, selected side is CAPT side.
- ④ Pitch wheel (PW)
Operation of the pitch wheel when the system is flying VS, IAS will resynchronize the air data command reference (or pitch reference) without disengaging the mode. The pitch wheel is inhibited in GS, ALT SEL CAPTURE, ALT HOLD modes.
- ⑤ Vertical modes pbs
Enable selection of vertical modes : IAS HOLD, VS HOLD, ALT HOLD.
- ⑥ Lateral modes pbs
Enable selection of lateral modes : HDG SEL, NAV, APP, BC.
- ⑦ BANK pb
Permits selection of the bank angle limit, in the HDG SEL mode only. Alternate action on the pb causes alternate selection of a high bank angle limit (27°) and a low bank angle limit (15°), power up state is high bank angle.
- ⑧ STBY pb
Cancels all FD modes (both armed and active). When AP is engaged, resets to basic modes.

	AFCS	1.04.10	
		P 3	001
	GENERAL		DEC 96

AA

ADU



R0FA-DJ-0410-003-A001AA

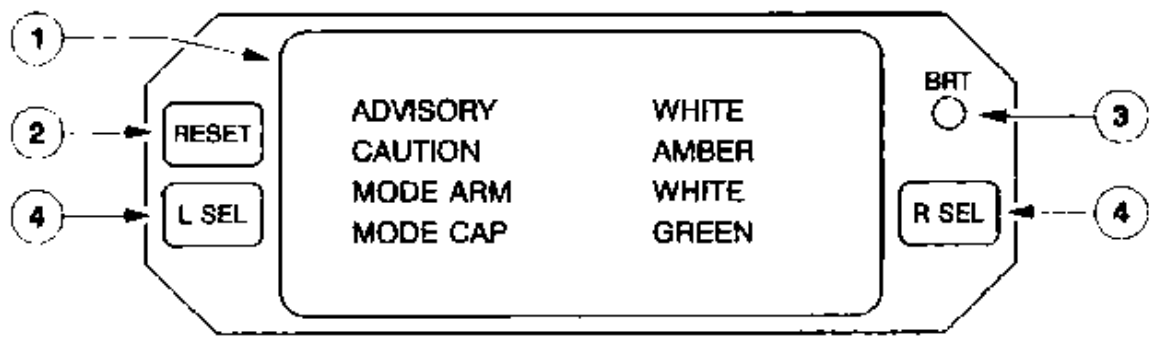

- ① **Display**
 The first line gives advisory messages in white letters
 The second line gives caution messages in amber letters
 The third line shows armed modes in white letters
 The fourth line shows active modes in green letters.
- ② **RESET pb**
 This button is used to cancel a caution message or to confirm an AFCS automatic choice.
- ③ **BRT knob**
 Is used to adjust ADU Brilliance.
- ④ **L SEL-R SEL pb**
 Is used in A.P. ground maintenance test.

	AFCS	1.04.10		
	GENERAL	P 4	001	
				DEC 96

CRS 1/HDG PANEL



R0FA-01-04-10-004-A001AA

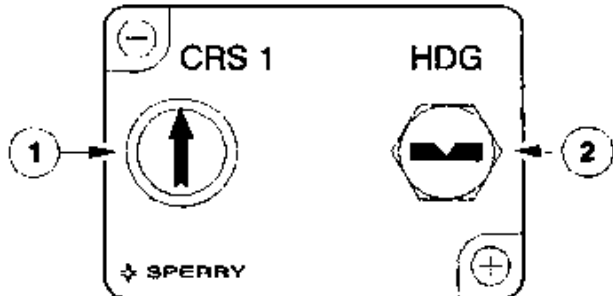

- ① CRS 1 Knob
selects course on the CAPT EHSI.
- ② HDG knob
selects on both EHSIs, the heading which is used as a reference by the AFCS.

ALT/CRS 2 PANEL

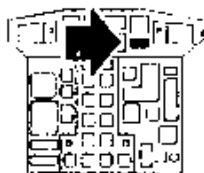

R0FA-01-04-10-004-B001AA

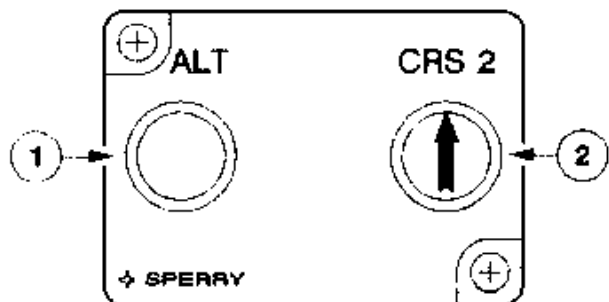

- ① ALT knob
controls the preselected altitude which is shown on the advisory display.
- ② CRS 2 knob
selects course on F/O EHSI

AP OFF LT

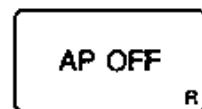

R0FA-01-04-10-004-C001AA

Both lights illuminate or flash red and the CCAS is activated through the MFC when AP is disengaged.

 NR72 F.C.O.M.	AFCS	1.04.10		
		P 5	001	
	GENERAL			DEC 96

AA

EADI

R0FA-01-04-10-005-A003AA

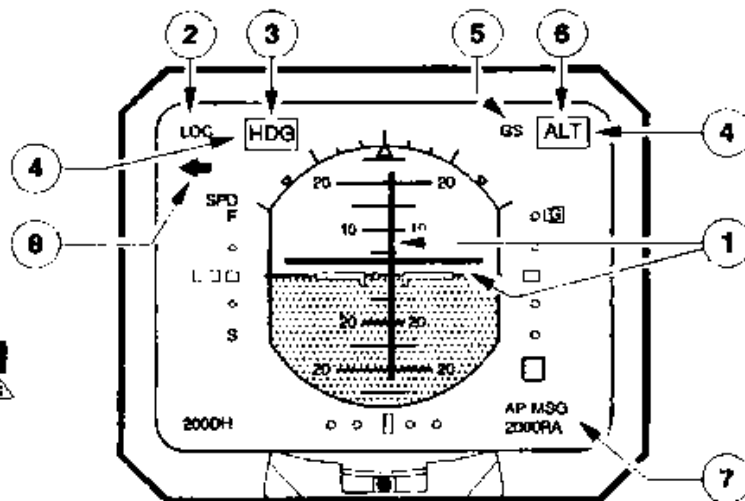

- ① Flight Director Command bars (Magenta)
display computed commands to capture and maintain a desired flight path.
- ② Lateral armed mode annunciator (white)
displays in white the lateral AP/FD armed mode ; the annunciator extinguishes when this mode is captured.
Available lateral armed modes : VOR, LOC, BC, LNAV (if omega installed)
- ③ Lateral active mode annunciator (green)
displays in green the lateral AP/FD active mode ; the indication is followed by a star while capture of an armed mode is in progress. The star disappears when capture is achieved.
Available lateral active modes : VOR, LOC, BC, HDG, LNAV (if omega installed)
- ④ Transition box
is displayed in white around the green active mode annunciator for the first 5 seconds of capture of an armed mode.
- ⑤ Vertical armed mode annunciator (white)
displays in white the vertical AP/FD armed mode ; the annunciator extinguishes when this mode is captured.
Available vertical armed modes : ALT, GS.
- ⑥ Vertical active mode annunciator (green)
displays in green the vertical AP/FD active mode ; the indication is followed by a star while capture of an armed mode is in progress. The star disappears when capture is achieved.
Available vertical active mode : VS, ALT, GS, IAS, GA (FD only).
- ⑦ "AP MSG" annunciator
Illuminates amber to indicate that a caution message can be read on the ADU. If no caution message is displayed and the autopilot is engaged "AP ENG" green is displayed.
- ⑧ CPL status annunciator (green arrow)

 ATR 72 F.C.O.M.	AFCS GENERAL	1.04.10		
		P 6	001	
				DEC 96

AA

FD BARS SW

RCPA-01-04-10-006-4001AA

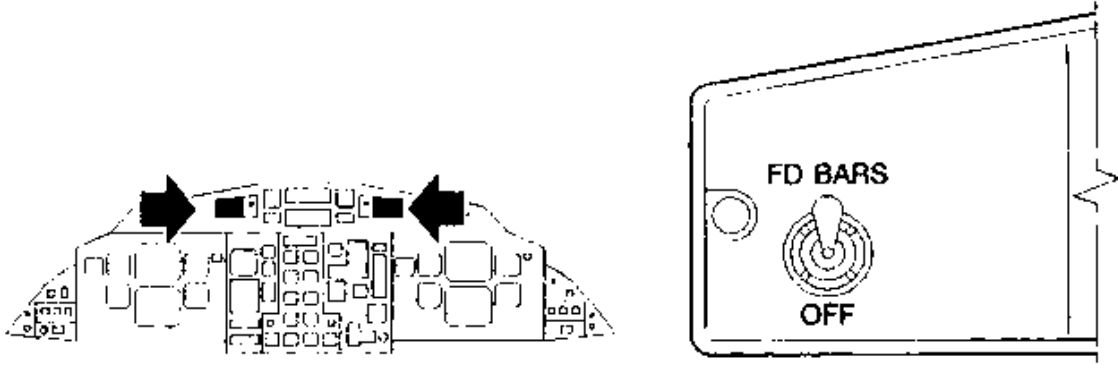

- FD BARS** The Flight Director command bars are operative. Each bar is in view provided relevant axis is not in basic mode.
- OFF** The command bars are out of view.

GO AROUND PB

RCPA-01-04-10-006-3001AA

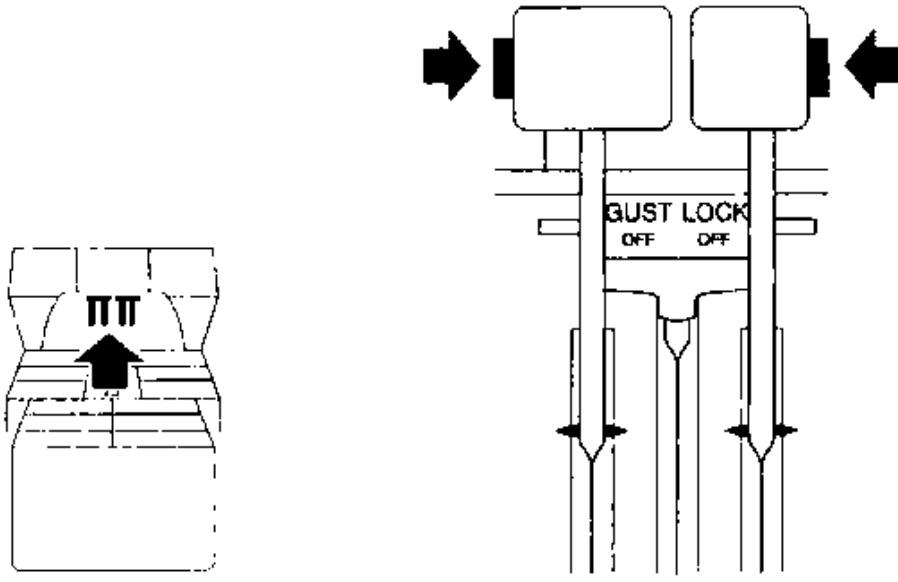

- When one is depressed, the go around mode is selected. It drops all others FD armed and active modes. The AP disengages and the FD will command :
- Laterally, heading hold (on heading followed at GA engagement).
 - Vertically, predetermined minimum safe pitch attitude (flaps function).
- The go around mode is cancelled by using TCS or STBY pb, or by selecting a new vertical mode or engaging AP.

 ATR 72 F.C.O.M.	AFCS	1.04.10	
	GENERAL	P 7	001
		DEC 96	

CONTROL WHEEL

ROFA-01-04-10-007-A001AA

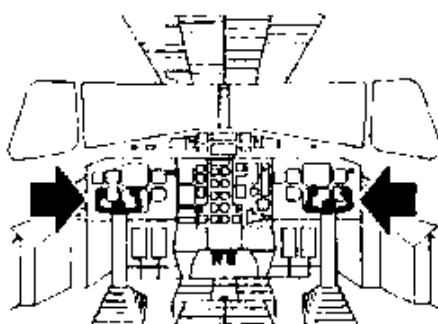

(REAR FACE)

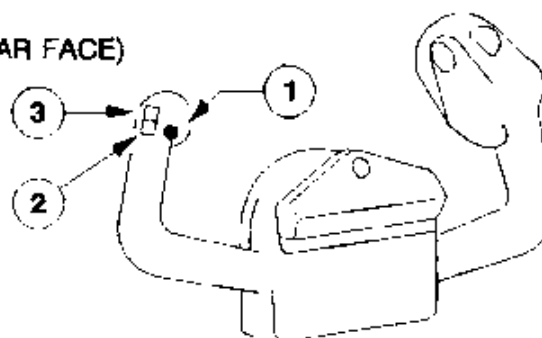

① AP quick disconnect pb

Allows to disconnect AP when depressed once. When depressed again, clears AP OFF alert indication.

② Normal pitch trim *ROCKER* (*ROCKER* actuation will disconnect AP)

③ Touch Control Steering (*TCS*) pb

Depressing the button allows the pilot temporary manual control of the aircraft. AP arrows extinguish on AFCS control panel.

- Basic AP mode : Depressing the TCS button in the basic mode will cause the AP to change the pitch and roll references. The reference attitude will be the aircraft's new pitch and roll attitude (within limits) at the time the TCS button is released. Pitch attitude resynchronization limits are $\pm 15^\circ$. If the button is released with a pitch attitude greater than 15° the aircraft will return to 15° and maintain that attitude.

If the TCS is released at bank angles less than 6° the system will level the wings and, at wings level will fly the existing heading. If the bank angle is greater than 6° but less than 35° at TCS release, the AP will maintain the bank angle. At bank angles greater than 35° the aircraft will return to 35° and the AP will maintain 35° .

- Modes linked to air data reference :
Action on TCS pb during ALT HOLD, VS HOLD or IAS HOLD modes will resynchronize the air data command reference without disengaging the mode.
Action of TCS pb during IAS or VS mode will generate a dashed IAS or VS reference message on ADU.
- In all other modes, a TCS activation will simply allow the pilot to take manual control of the aircraft without disengaging the mode.

	AFCS	1.04.10		
		P 8	001	
	GENERAL			DEC 96

GUIDANCE Indication (if installed)

ROFA-01-04-10-008-A001AA

GUIDANCE

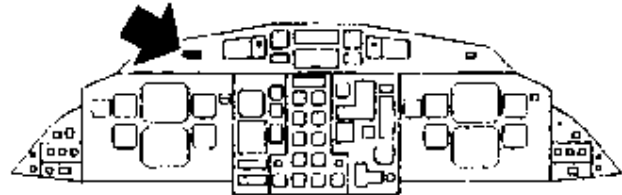

Illuminates amber if CAT II conditions are lost or if an excess deviation is detected.

STBY PITCH TRIM SW

ROFA-01-04-10-008-B001AA

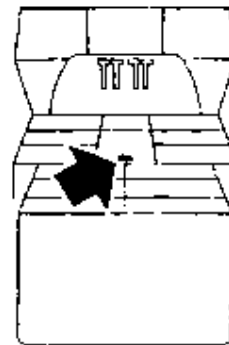
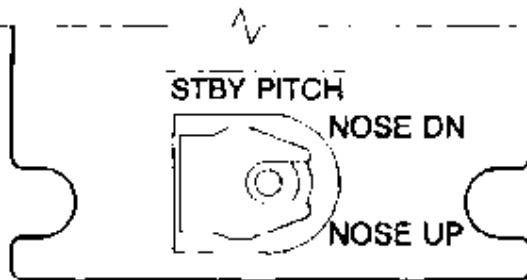

STBY PITCH TRIM will disengage the AP.

	AFCS	1.04.10		
	GENERAL	P 9	070	
				JUN 97

AA

10.3 ELECTRICAL SUPPLY/MFC LOGIC

ELECTRICAL SUPPLY

EQUIPMENT	DC BUS SUPPLY (C/B)	AC BUS SUPPLY (C/B)
AP/FD computer + YD DISC circuit + control box + "GUIDANCE" indication (*)	DC EMER BUS (on overhead panel CMPTR)	- Nil -
ADU	DC STBY BUS (on overhead panel ADU)	- Nil -
Servo controls	DC STBY BUS (on overhead panel SERVO)	- Nil -
AP OFF lights + AP DISC circuit	DC ESS BUS (on overhead panel WARN)	- Nil -

(*) if installed

MFC LOGIC

See chapter 1.01.

	AFCS	1.04.10		
		P 10	001	
	GENERAL			DEC 96

10.4 LATERAL MAINTENANCE PANEL

On LH maintenance panel, a toggle switch allows to test the AFCS with the aircraft on the ground.

If an AFCS failure occurs in flight, the ground maintenance test mode should be entered after landing, and before removing avionics power, in order to retrieve the FLIGHT FAULT SUMMARY data.

ROFA-01-04-10-010-A001AA

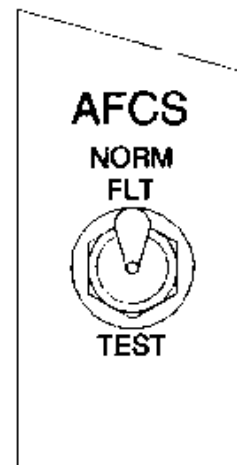
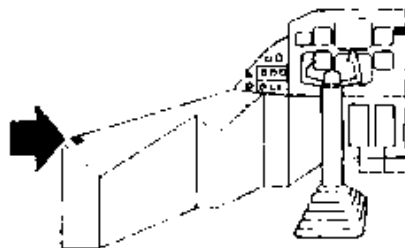

PROCEDURE

- Airspeed less than 50 kts, aircraft on ground.
- Autopilot/Yaw damper disengaged.
- Toggle switch on "test"

The ADU should now display :

01 FGC TEST ?

- Step through the tests using the L SEL button until Test 98 FLIGHT FAULT SUMMARY appears as shown below :

98 FLIGHT FAULT SUMMARY ?

- Push the RESET button and data for the AFCS computer will appear. The alphanumeric codes should be recorded for use by maintenance personnel in trouble shooting the problems.
- Toggle switch on "NORM FLT".

Note : If power is shut down, flight fault summary is lost.

0.5.5 .MATIC

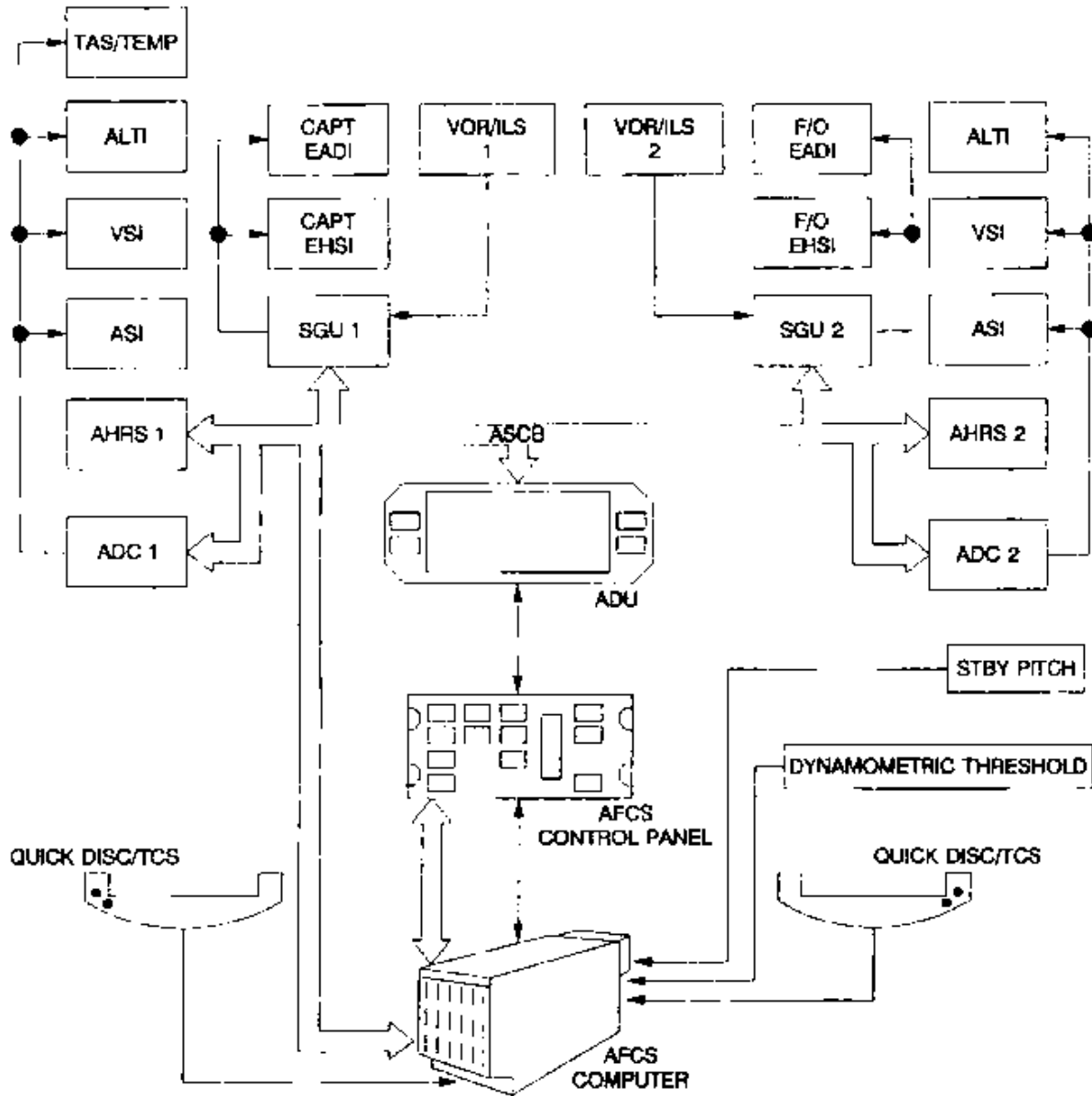

ROFA-01-04-10-D11-AD31A4

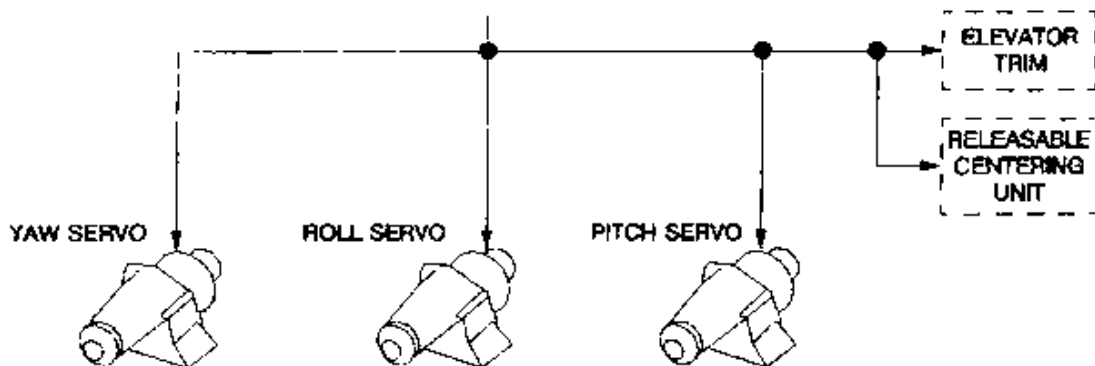

	AFCS AUTO PILOT/YAW DAMPER	1.04.20		
		P 1	050	
				DEC 96

AA

PURPOSE

The YAW DAMPER (YD) provides yaw damping and turn coordination. To achieve these functions, AFCS computer and AP yaw actuator are used.

The AUTO PILOT (AP) allows the following :

- stabilizing the aircraft around its center of gravity while holding pitch attitude and heading or bank angle (AP in basic modes).
- flying automatically any flight director active mode (AP in AP/FD modes) except GO AROUND mode which must be flown manually only.

AUTO PILOT ENGAGEMENT

When the AP is engaged, the pitch, roll and yaw actuators are connected to the flight controls and the pitch autotrim function is activated.

- Engagement with no vertical FD mode selected. The AP flies actual pitch attitude. This is the basic vertical mode. Pitch wheel and TCS can be used to modify the pitch attitude.
- Engagement with no lateral FD mode selected : the AP will first level wings and then maintain the heading reached at this time. This is the basic lateral mode. TCS pb may be used (see 1.04.10).
- Engagement with a lateral or vertical armed FD mode selected : the AP flies basic mode until the armed mode becomes active.
- Engagement with a lateral and/or vertical active F/D mode selected : the AP maneuvers to fly to zero the FD command bars.

AUTO PILOT DISENGAGEMENT

AP can be disengaged manually or automatically.

- Manual disengagement is achieved by action on either one of the following devices :
 - Quick disconnect pb on control wheel
 - Action on Pitch Trim (normal or STBY)
 - AP pb on AFCS control panel.
 - YD pb on AFCS control panel.
 - G A pb on PL
 - Pilot's force on the pedals over 30 daN (66 lb).
 - Pilot's force on the control column (pitch axis) over 10 daN (22 lb)
- Automatic disengagement occurs when :
 - one of the engagement conditions of the AP and/or YD is no longer met
 - stall warning indicator threshold is achieved
 - there is a disagreement between the two AHRS or between the two ADC.
 - there is a mismatch between the two pitch trims.

	AFCS AUTO PILOT/YAW DAMPER	1.04.20		
		P 2	050	
				JUL 01

AA

MANUAL DISENGAGEMENT

- Action on the AP pb on the control panel, or quick disconnect pb on each control column, or GA mode activation, or STBY or NORMAL pitch trim switch activation or effort on control column disengage the AP function without disengaging the YD function. The AP white arrows extinguish, the AP OFF it illuminates red and the "cavalry charge" aural warning is generated.

On the ADU, the RESET pb illuminates amber and the "AP DISENGAGED" message is displayed in amber on the second line. Action on the RESET pb or quick disconnect pb clears the warnings and message.

Note : If a failure occurs, the "PITCH TRIM FAIL", "PITCH MISTRIM" or "AILERON MISTRIM" message is displayed on the ADU.

The crew has to disengage AP and manually fly the aircraft.

- Action on the YD pb on control panel or an effort on pedals disengages the YD and AP. The AP and YD white arrows extinguish. The "AP OFF" it illuminates red and the "cavalry charge" aural warning is generated. On the ADU, the "RESET" pb illuminates amber and the "AP/YD DISENGAGED" message is displayed in amber on the second line. Action on the RESET pb or the quick disconnect pb clears the warnings and message.

AUTOMATIC DISENGAGEMENT

The warnings and messages are the same as those which occur in case of manual disengagement but "AP OFF" light and "AP" or "AP/YD DISENGAGED" message are flashing. Action on "RESET" pb clears warnings and messages.

- R *Note : If PITCH TRIM ASYM it illuminates on central panel, AP automatically disengages and cannot be reengaged.*

AP/YD MONITORING RECOVERY

When a monitored failure is detected, AP and/or YD is disengaged. If the pilot clears messages displayed on ADU (by using RESET pb) the FGC will attempt a "monitor recovery". The AP/YD can be once again engaged.

If initial failure condition still exists, AP/YD is disengaged again.

Conditions which will inhibit all recovery attempts are :

- Loss of AP, YD and AFCS controls panel.
- Trim inoperative monitor failures
- Any APP mode
- GA mode
- LOC or BC modes



The purpose of the FLIGHT DIRECTOR (FD) is to provide information to the pilot through the command bars on the EADI to allow a manual guidance of the A/C :

- In pitch axis if a vertical mode is selected.
- In roll axis if a lateral active mode is selected.

The FD commands are satisfied when the FD bars remain centered on the EADI.

If no vertical and/or lateral active mode is selected, the corresponding command bar is removed. In addition, the two bars can be removed by setting the FD BARS selection sw to OFF.

The following modes are available :

- Vertical modes :
ALT SEL, ALT, VS, IAS
- Lateral modes :
HDG, NAV, BC
- Common modes :
APP (lateral and vertical guidance for approach), G.A

Some modes have an initial arm status before becoming active.

Their active phase is divided into a capture phase followed by a track or hold phase. When AP is engaged, it normally automatically follows the FD commands. If no FD active mode is selected, the system flies basic AP mode (see 1.04.20).

MODE SELECTION

Mode selection is achieved by action on the corresponding pb on the AFCS control panel except for ALT SEL mode and GO AROUND mode :

- ALT SEL mode is automatically armed.
- GO AROUND mode is activated as soon as one of the GA pb located on the PL's is depressed, and is disengaged by using TCS, STBY pb, by selecting a new vertical mode or by engaging AP.

Note : Simultaneous armed status modes is limited to one lateral mode and two vertical modes. Therefore vertical armed modes are prioritized in the following order :

- ILS GS ARM
- ALT SEL ARM

ACTIVATION OF ARMED MODES

Only one lateral and one vertical mode can be activated simultaneously. If two vertical modes are armed, the first which meets the capture conditions becomes first active. The second remains armed.

	AFCS		1.04.30	
			P 2	001
	FLIGHT DIRECTOR			DEC 96

MODE DISENGAGEMENT

Action on the pb of an armed or active mode on the AFCS control panel disengages that mode.

Action on either GA pb on the PI's disengages all other armed or active modes.

Action on the STBY pb on the AFCS control panel disengages all armed and active modes. ALT SEL mode will rearm automatically only if AP is engaged or if a FD mode is selected again and if aircraft flies toward the selected altitude.

When a vertical (or lateral) mode becomes active, the previously active vertical (or lateral) mode is automatically disengaged.

Other automatic disengagement logic conditions are detailed for each mode in chapter 1.04.40.

FLIGHT GUIDANCE DISPLAYS AND ANNUNCIATIONS

- The EHSI displays navigation information. The FD uses information from the coupled EHSI which is selected through the CPL pb on the AFCS control panel.
- Heading bug: the heading bug is controlled by the single heading knob. The heading error between actual heading and selected heading as displayed on the coupled EHSI is sent to the FD.
- Course pointer: the course pointer of each EHSI is controlled by the associated course knob. The course error as displayed on the coupled EHSI is sent to the FD.
- Deviations: deviations displayed on the coupled EHSI and used by the FD are as follows, depending on the selected navigation source.
 - in lateral: VOR, LOC or LNAV (if installed)
 - in vertical: GS
- The EADI displays guidance information through the pitch and roll command bars. It also displays mode status annunciations:
 - Armed modes are displayed in white and captured modes are displayed in green (see 1-04-10).
- The ADU provides mode status annunciations:
 - lateral armed mode status is displayed in white on the left portion of the third line
 - vertical armed mode status is displayed in white on the central and right portion of the third line
 - lateral active mode status is displayed in green on the left portion of the fourth line
 - vertical active mode status is displayed in green on the right portion of the fourth line
 - During capture phase, a star is added to the mode annunciation on EADI and ADU.

	AFCS OPERATION	1.04.40		
		P 1	001	
				DEC 96

AA

40.1 SYSTEM OPERATION

For basic stabilization computations, the AFCS computer receives data from both CAPT and F/O ADC and AHRS. An average value is used.

AP Basic modes are not affected by the selected coupled side.

For guidance computations, the AFCS computer is coupled either to CAPT side or to F/O side. It uses data from the coupled ADC and SGU only and displays the same commands on both sides. Selection of the coupled side is achieved through repeated actions on the CPL pb. At power up, left side is coupled. The coupled side is indicated by illumination of the corresponding arrow located at each side of the CPL pb.

All FD modes not using SGU data (ALT HOLD, ALT SEL, VS, IAS, GO AROUND) will be retained following a CPL transition. The FD will give commands to ensure a smooth transition maneuver if the new data are different (different baro settings in ALT HOLD for example).

All FD modes using SGU data (NAV, BC, APP) will be dropped following the change of selected coupled side.

During ILS approach only :

DUAL CPL automatically occurs after LOC and GS track phase has begun if both NAV receivers are tuned to ILS. In DUAL CPL both arrows are illuminated and both NAV receivers are coupled to the AFCS computer which utilizes average data for guidance computation. When the APP mode is manually cancelled, the FD remains coupled to the side selected prior to dual coupling.

Excess DEV monitoring utilizes ILS data from both SGU (CAT 2 approach)

AP COUPLING WHEN A FAILURE OCCURS

- When one sensor used for guidance computations fails, the pilot can still couple the AFCS to the corresponding side but the FD modes using the invalid sensor cannot be engaged.

Loss of ILS :

- Out of DUAL CPL phase : AP remains engaged on coupled side.
- In DUAL CPL phase : AP operates an automatic selection.

	AFCS		1.04.40	
	OPERATION		P 2	001
			DEC 96	

AA

FAILURES

When a failure appears on AFCS, AP MSG message is displayed on both EADI and corresponding explanation appears on ADU.

CAUSE	MESSAGE	PILOT ACTION
AP/YD Disengagement	AP/YD DISENGAGED YD DISENGAGED AP DISENGAGED	
Monitor	AFCS INVALID or AP INVALID	
CAT I or CAT II capacity	CAT I or CAT II displayed on the first line of ADU	
Loss of CAT II capacity	CAT II INVALID and CCAS is activated through the MFC (3 CLIC)	
Excess LOC or GS deviation	EXCESS DEV (LOC and GS scales flash amber on both EADI)	
Aberrancy on ROLL AXIS	AILERON MISTRIM RETRIM ROLL R(L) WING DN	Refer to 2.05.11 Refer to 2.02.04
AIRCRAFT out of TRIM on PITCH AXIS	PITCH MISTRIM	Use of A/P prohibited
Loss of AUTOTRIM	PITCH TRIM FAIL	Use of A/P prohibited
Excess difference between both AHRS or both ADC	AHRS DATA INVALID ADC DATA INVALID	
Incorrect navigation source/selected mode	CHECK NAV SOURCE	
AP engagement on ground	NO ENGAGEMENT ON GROUND	
Loss of a coupled transmitter	CPL DATA INVALID	
AP engagement with a condition making this engagement impossible	ENGAGE INHIBIT	
Loss of computer	AFCS INVALID	
Loss of ASCB bus	Dashes on ADU	
Incoherence between ASCB AP/YD disengage data and clutches status. FAULT detected by ADU	DISENGAGED ANNUN DATA FAULT	
Mismatch between the two NAV receivers ILS in Dual CPL	NAV MISMATCH (R SEL) or NAV MISMATCH (LSEL)	

 ATR 72 F.C.O.M.	AFCS	1.04.40		
	OPERATION	P 3/4	001	
				DEC 96

40.2 AUTOPILOT/FLIGHT DIRECTOR MODES

VERTICAL MODES

ALTITUDE SELECT MODE

ALT SEL mode is automatically armed when the aircraft is climbing or is descending towards the selected altitude except after action on the STBY pb. In this case, ALT SEL mode rearms only if AP is engaged or if a FD mode is selected, in addition to the previous conditions. ALT SEL is displayed on ADU and ALT is displayed on EADI.

ARM PHASE

The ALT SEL ARM mode is annunciated on the ADU and EADI as a vertical armed mode, by a white ALT message. VS HOLD, IAS HOLD or PITCH HOLD modes can be used to fly to the selected altitude.

- CAPTURE PHASE

When approaching the preselected altitude, the system automatically switches to the ALT SEL CAP mode and the previous vertical mode is cancelled. A command is generated to asymptotically capture the selected altitude. ALT SEL CAPTURE is annunciated on the ADU and EADI by a green ALT'

Note : If preselect altitude value is changed during capture phase, AP will return to basic PITCH HOLD mode.

- HOLD PHASE

When the desired altitude is reached, the ALT SEL CAP mode is automatically cancelled and ALT HOLD mode is automatically selected. The ALT HOLD mode is annunciated on the ADU and EADI by a green ALT.

During the three phases (ALT SEL ARM, ALT SEL CAP, ALT HOLD), a GS capture will override the altitude mode.

ALTITUDE SELECT MODE

10 000FT

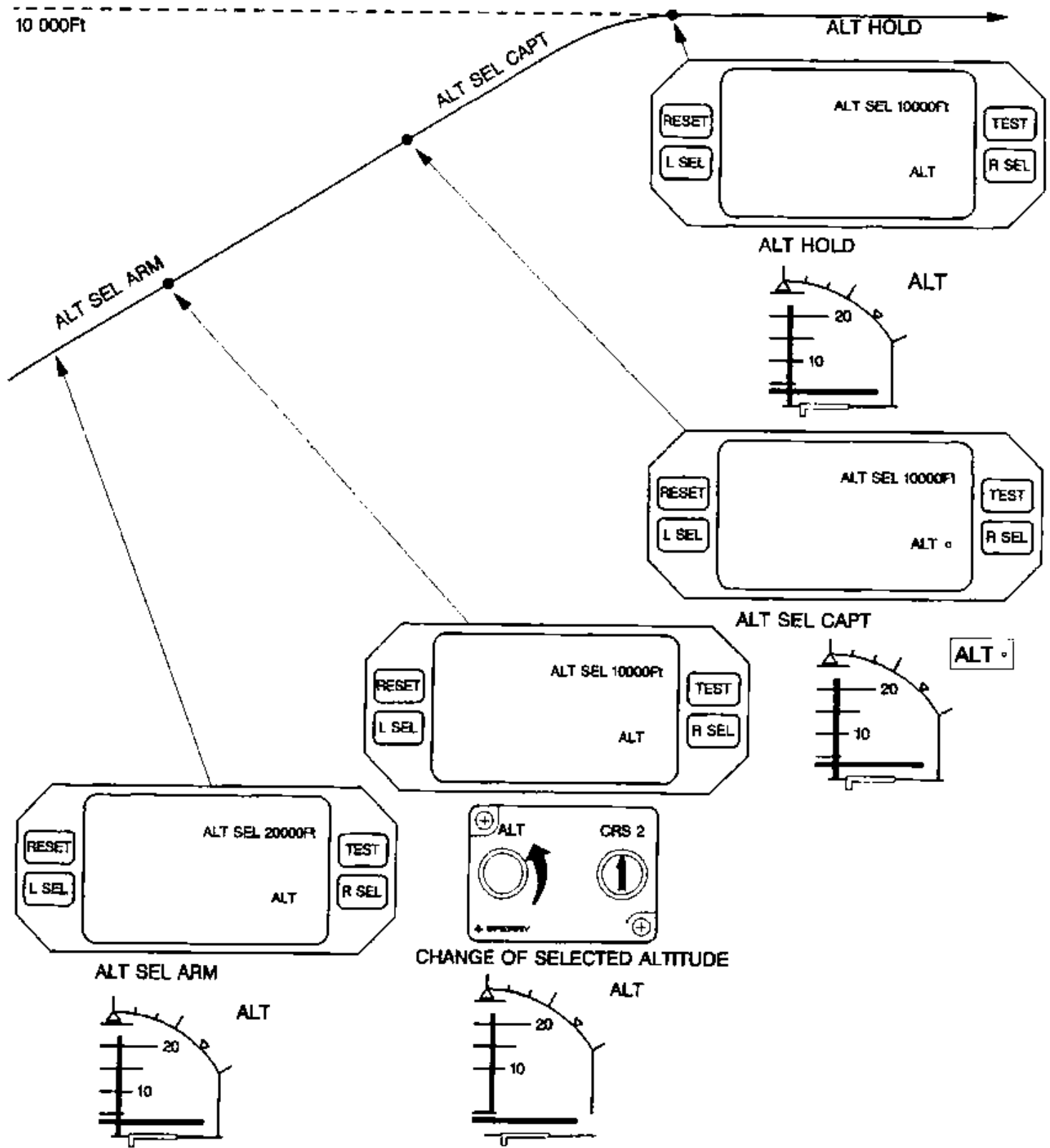

ALTITUDE HOLD MODE

Activation of the ALT pb on the AFCS control panel selects the ALT HOLD mode and overrides all active FD vertical modes.

ALT existing at engagement is maintained.

The ALT HOLD mode is annunciated on both ADU and EADI by a green ALT.

Depressing and holding the TCS button allows the pilot to maneuver the aircraft to a new altitude reference without disengaging the mode.

In the ALT HOLD mode, all armed FD vertical modes are allowed, but a GS capture will override the ALT HOLD mode.

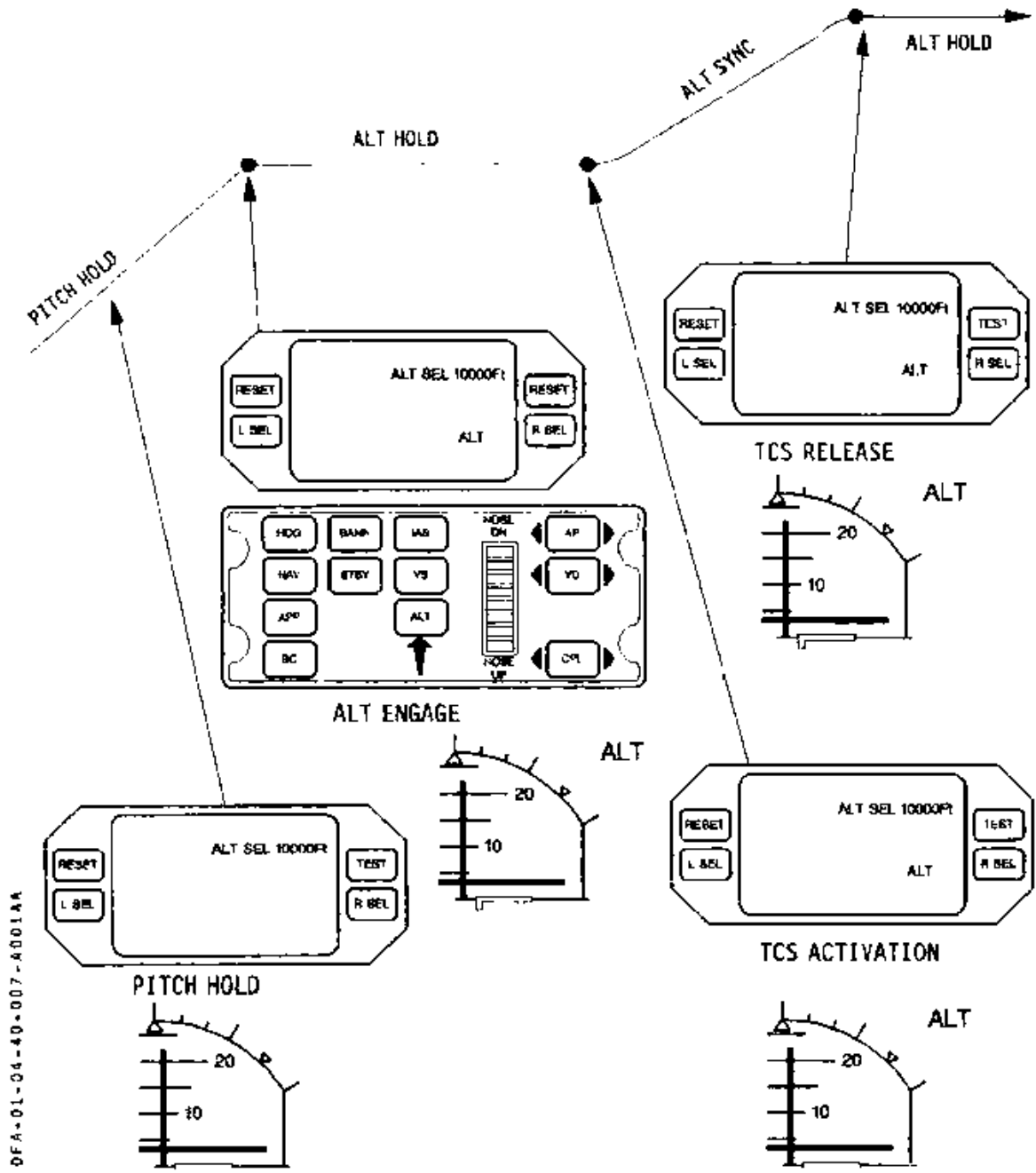

DFA-01-04-40-007-ADD1A

	AFCS	1.04.40		
	OPERATION	P 8	001	
				DEC 96

VERTICAL SPEED HOLD MODE

Action on the VS pb on the control panel selects the VS HOLD mode and overrides all active FD vertical modes. VS existing at engagement is maintained and displayed in green on the ADU. "VS" message is displayed in green on the EADI.

Activation of the PTW will set a new vertical speed reference without disengaging the mode.

Depressing and holding the TCS button allows the pilot to maneuver the aircraft to a new vertical speed reference without disengaging the mode.

In VS HOLD mode any other vertical mode may be armed, and when captured will override VS HOLD mode.

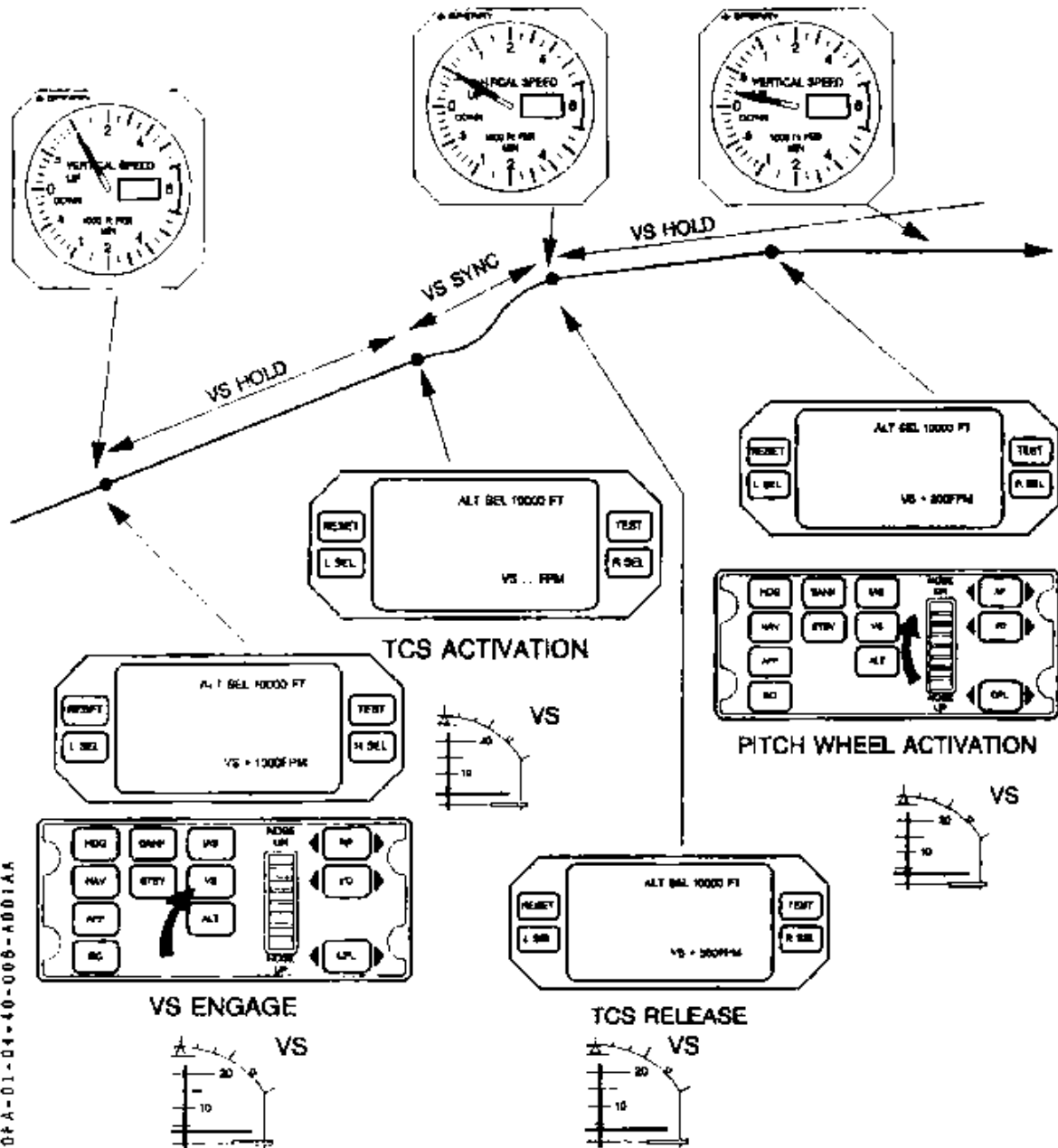

INDICATED AIRSPEED HOLD MODE

Action on the IAS pb on the control panel selects the IAS HOLD mode and overrides all active FD vertical modes.

Airspeed existing at engagement is maintained and displayed in green color on the ADU.

"IAS" message is displayed in green on the EADI.

Actuation of the PTW will set a new IAS reference without disengaging the mode.

Depressing and holding the TCS button allows the pilot to maneuver the aircraft to a new IAS reference without disengaging the mode.

In IAS HOLD mode, any other vertical mode may be armed, and when captured will override IAS HOLD mode.

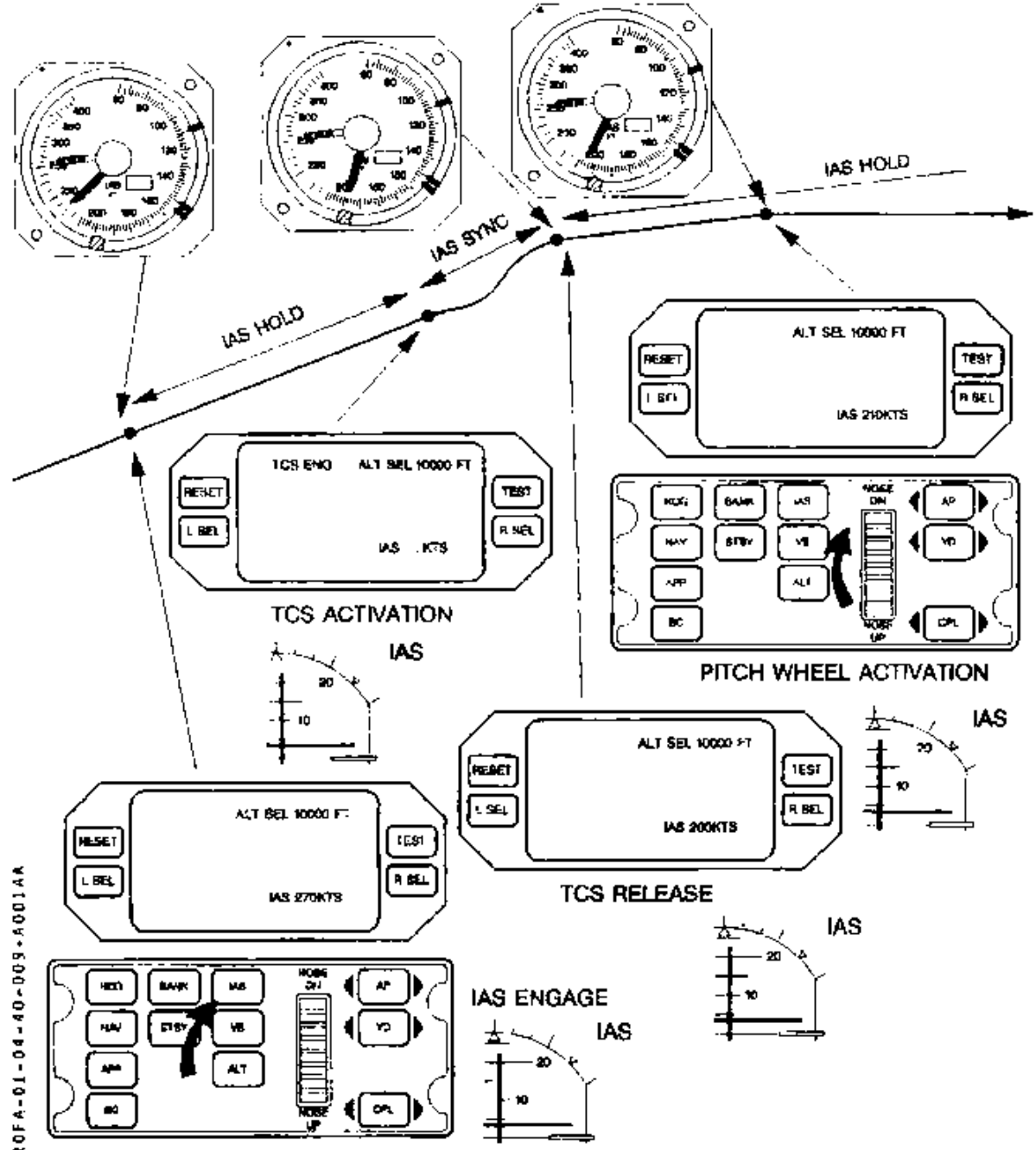

	AFCS	1.04.40		
		P 10	001	
	OPERATION			DEC 96

LATERAL MODES

HEADING SELECT MODE

Action on the HDG pb on the AFCS control panel selects the Heading Select mode and overrides all active lateral FD modes. Selection of heading is made by the heading knob and is displayed on both EHSI's. The heading Select mode is annunciated on the ADU and the EADI by a green "HDG" at the lateral active location.

Selection of turns greater than 180° will lead the system to order a turn as short as possible if selection has been made before HDG mode being engaged. If selection is made after HDG mode engagement, turning command will occur by the side selected by the pilot.

CAUTION: Before take off, A/C lined up at the runway heading, the vertical command bar is to be checked and centered (if necessary).

The BANK pb on the AFCS control panel allows selection of the bank angle limit in the HDG SEL mode only. Alternate action on the Bank pb causes alternate selection of a High bank angle limit (27°) and a low bank angle limit (15°). Power up state is High bank angle. The bank angle limit status is annunciated on the ADU by a green "HDG SEL LO" if low bank is selected.

In the Heading Select mode, all armed roll FD Modes are allowed but the capture of any armed lateral mode will override the Heading Select mode.

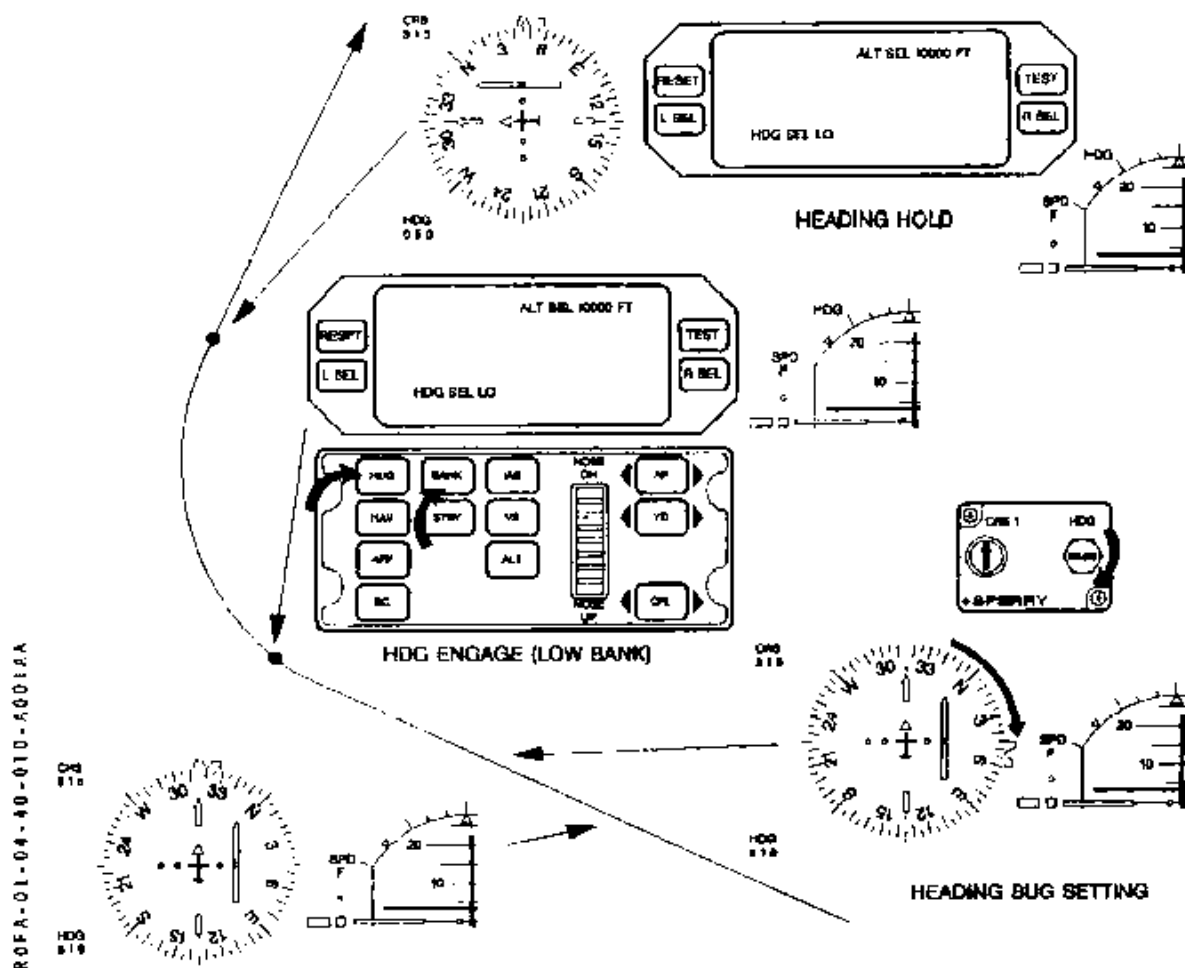

	AFCS		1.04.40		
	OPERATION		P 11/12	001	
					DEC 96

AA

NAVIGATION MODE

Action on the NAV pb on the AFCS control panel arms the lateral guidance for capture of the selected navigation source that is displayed on the active EHSI. Depending on the selected NAV source and the frequency tuning, VOR ARM or LOC ARM, is selected. (L NAV if OMEGA installed and frequency tuned).

- VOR NAVIGATION MODE

VOR ARM is annunciated on the ADU and the EADI by a white "VOR". HDG SELECT, HDG HOLD modes can be used to fly the system during the VOR ARM phase.

At capture, the previous lateral mode is cancelled. VOR CAPTURE is annunciated on the ADU and the EADI by a green "VOR*". For the five first seconds of capture of the armed mode, a white box surrounds the message on the EADI. VOR TRACK mode is annunciated on the ADU and the EADI by the removal of the * symbol.

LOCALIZER MODE

Selection and display are identical to VOR NAV mode except that there is no OVERSTATION and AFTER OVERSTATION capability.

BACK COURSE MODE

The back course mode is set up and flown exactly like a front course localizer approach but selecting BC mode. In this case, glideslope capture is automatically inhibited.

- Set the course pointer on the EHSI for the inbound published track.
- Set the heading bug on EHSI for the desired heading to intercept the course.

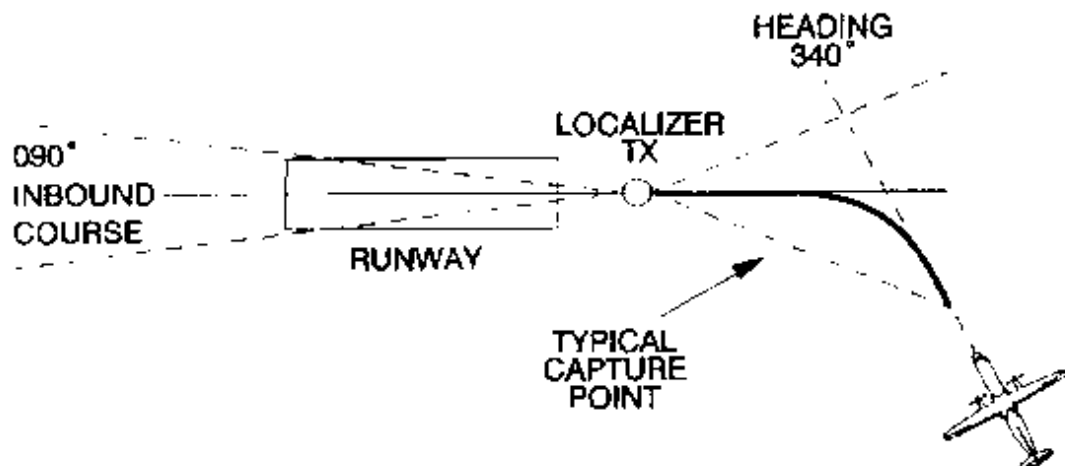

IAV DE

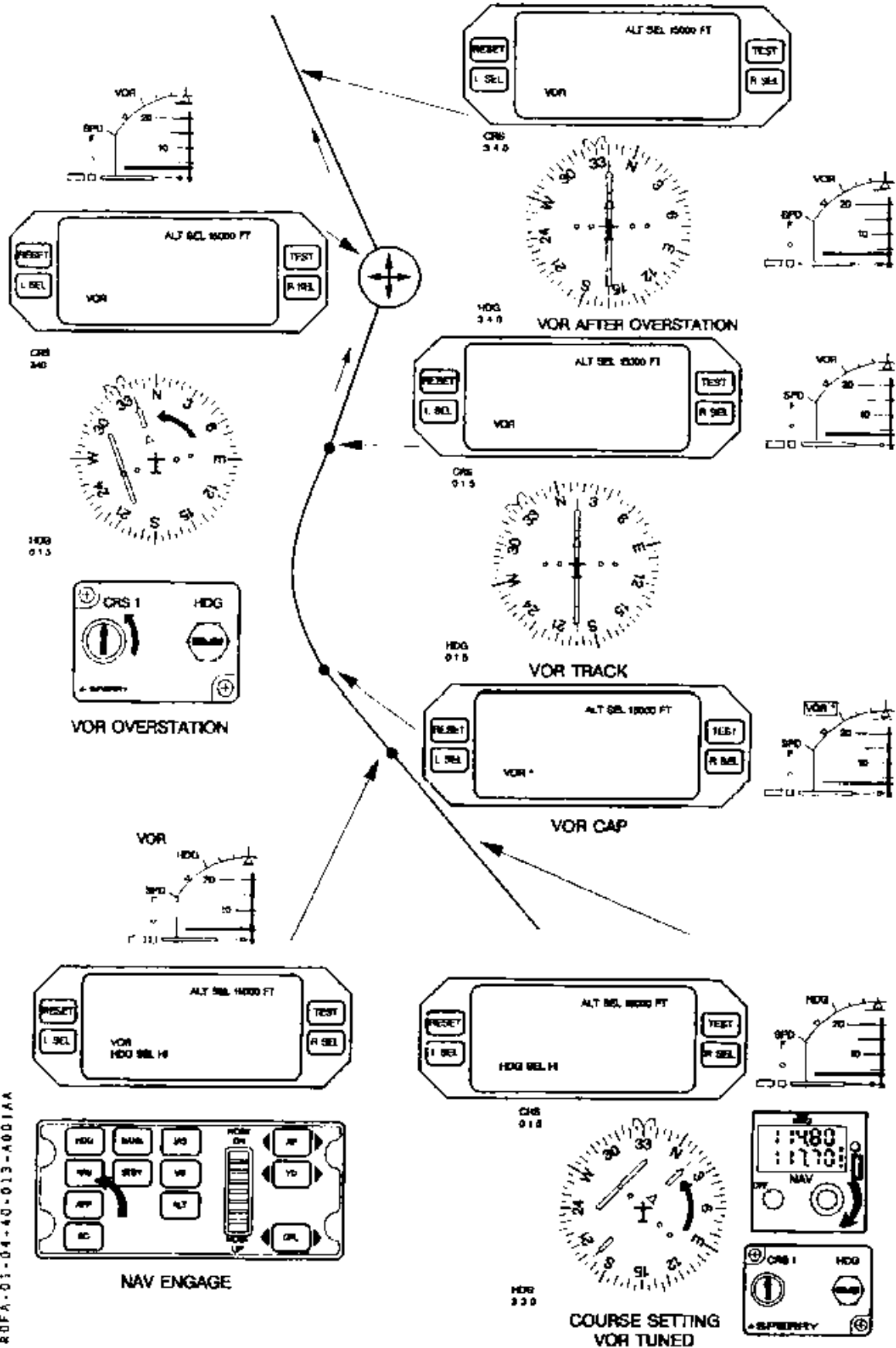

ROFA-01-04-40-013-A001AA



ILS APPROACH MODE

Action on the APP pb on AFCS control panel selects LOC and GS ARM modes provided the coupled NAV receiver is tuned to an ILS frequency.

LOC ARM is annunciated on the ADU and the EADI by a white "LOC". HDG SELECT, HDG HOLD modes can be used to fly the system during the LOC ARM phase.

GS ARM is annunciated on the ADU and the EADI by a white "GS". Any vertical mode is allowed during GS ARM phase.

At LOC CAPTURE the previous lateral mode used to fly is cancelled. LOC CAPTURE is annunciated on the ADU and the EADI by a green "LOC**".

LOC TRACK is annunciated on the ADU and the EADI by the removal of the * symbol.

Glideslope capture is interlocked such that the localizer must be captured prior to glideslope capture. The GS capture overrides all vertical modes which were previously engaged. GS CAPTURE is annunciated on the ADU and the EADI by a green "GS**".

GS TRACK is annunciated on the ADU and the EADI by the removal of the * symbol.

GO AROUND MODE (FD MODE ONLY)

Action on the GA pb selects the GO AROUND mode and drops all armed and active FD modes. The AP disengages and the FD gives commands to maintain predetermined minimum safe pitch attitude and to maintain heading followed at GA engagement.

The GO AROUND mode is annunciated on the ADU and the EADI by a green "GA" at the active vertical location.

The GO AROUND mode is cancelled by selecting another vertical mode, engaging TCS, pushing the STBY pb or engaging the AP.

PP DE

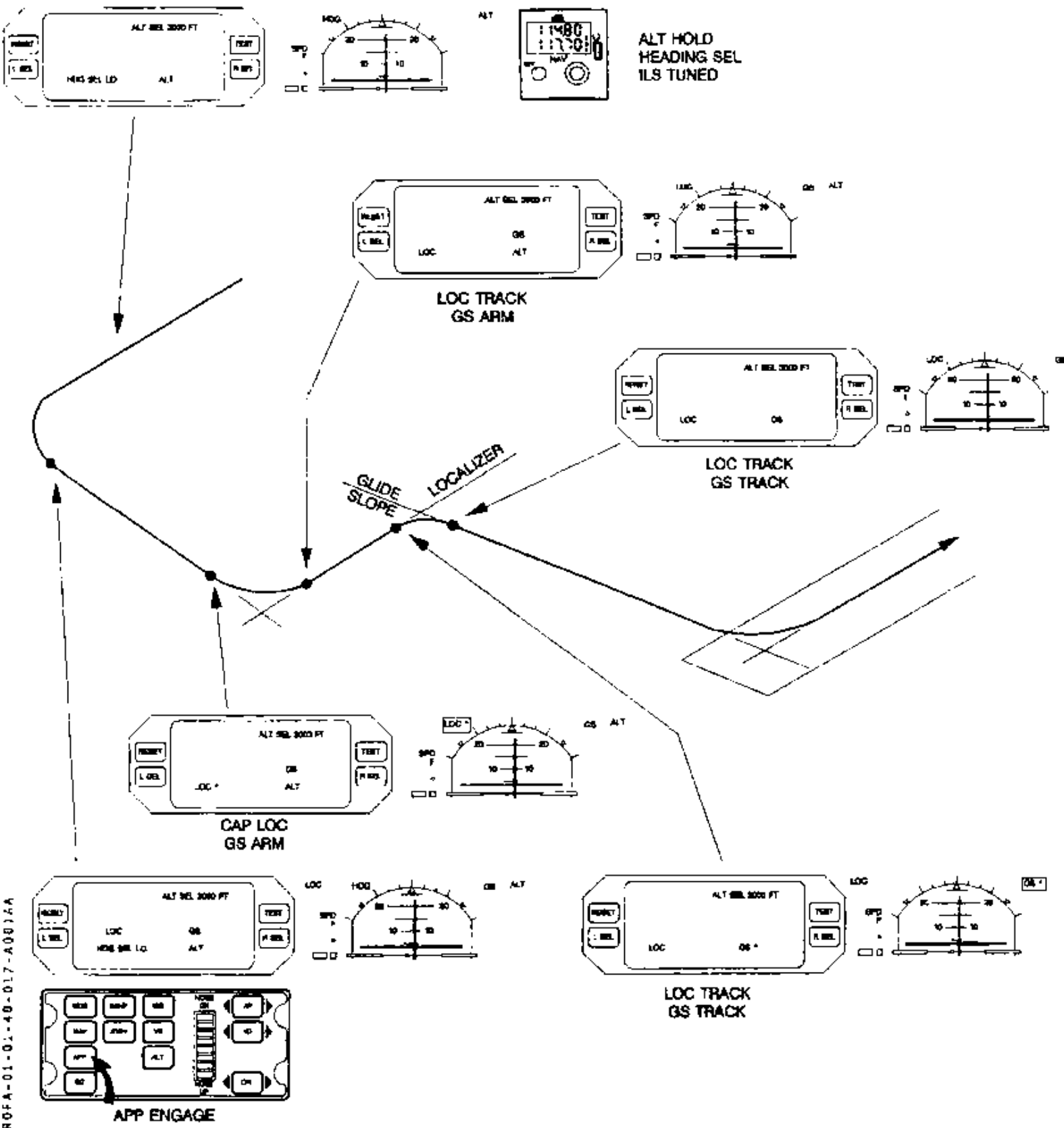

 ATR 72 F.C.O.M.	AFCFS	1.04.50		
		P 1	001	
	ALTITUDE ALERT			DEC 96

AA

The purpose of the altitude alert function is to alert the crew by activation of a visual signal and an aural signal when the aircraft is reaching or leaving the preselected altitude. Preselection is achieved through a rotary knob and displayed in white on the first line of the advisory display.

The visual signal consists of one amber light located on each of the two altimeters which illuminate when altitude is between $H + 250$ ft and $H + 1000$ ft or between $H - 250$ ft and $H - 1000$ ft.

The aural signal consists in a "C chord" signal of 0,75 s duration which is activated each time the aircraft enters one of the two altitude zones defined above.

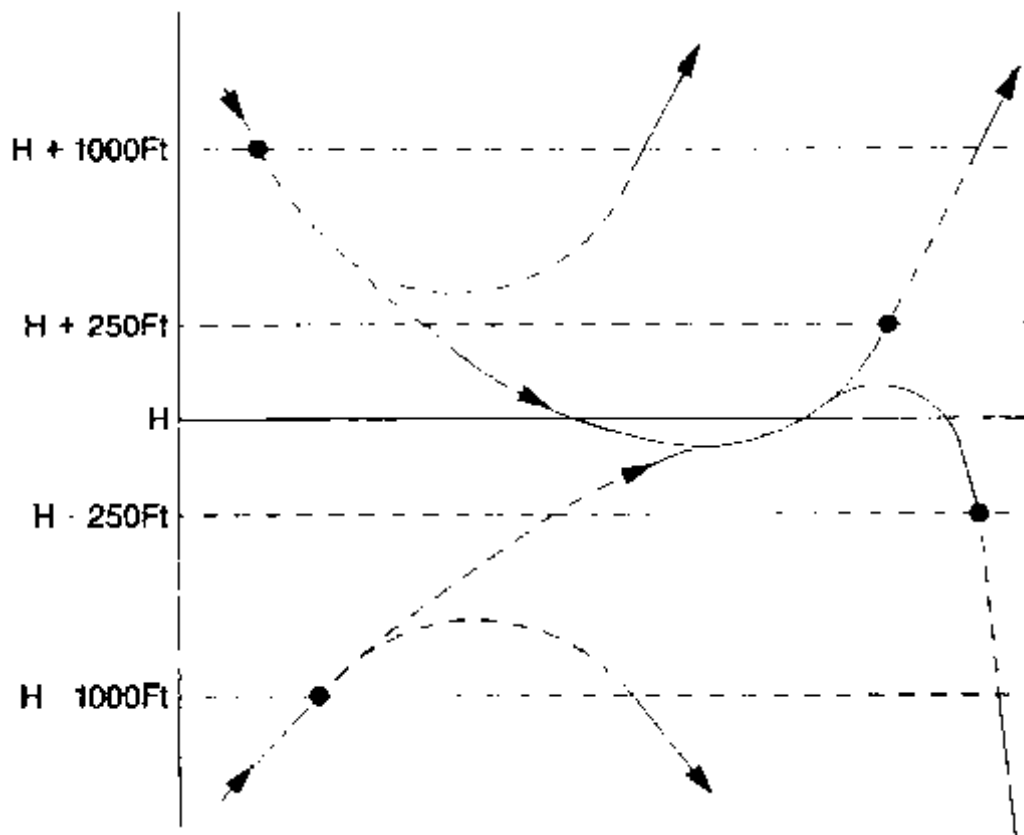

H : PRESELECT ALTITUDE

● AURAL SIGNAL (0.75s)

- - VISUAL SIGNAL

	COMMUNICATIONS		1.05.00	
			P 1	030
	CONTENTS			JUL 01

AA

- 1.05.00 CONTENTS**
- 1.05.10 GENERAL**
 - 10.1 DESCRIPTION
 - 10.2 CONTROLS
 - 10.3 ELECTRICAL SUPPLY/MFC LOGIC/SYSTEM MONITORING
 - 10.4 SCHEMATIC
- 1.05.20 TRAFFIC ALERT AND COLLISION AVOIDANCE SYSTEM (TCAS)**
 - 20.1 DESCRIPTION
 - 20.2 CONTROLS
 - 20.3 OPERATION

	COMMUNICATIONS GENERAL	1.05.10		
		P 1	001	
				DEC 96

10.1 DESCRIPTION

(See schematic p 19/20)

The aircraft communication system provides :

- * radio communications between aircraft and ground stations (an emergency beacon is also provided).
- * interphone between
 - cockpit crew stations
 - cabin attendant station
 - ground crew stations at :
 - hydraulic bay (left main landing gear fairing)
 - ground electrical power receptacle
 - unpressurized bay in the rear fuselage
- * passenger address system
- * distribution, (in the loudspeakers only) of aural alerts generated by the MFC and the GPWS

The main components of the systems are :

- The Remote Control Audio Unit (RCAU)
- The crew audio control panels.

In addition the communication system includes one ATC transponder and as options an other ATC transponder, ATSCALL and ACARS.

OPERATION

To communicate, the crew member select on their audio control panel the desired transmission key and adjust the volume control knob.

Transmission may be performed :

- using the hand mike with integrated switch
- using the boom set mike or the oxy mask mike with :
 - the PTT selector on the control wheel, or
 - the RAD/INT selector on the audio control panel, or
 - the switch located on the nose wheel steering control handle (for CAPT only).

Note : A switch located in the oxygen mask box when in released position (oxygen mask out), automatically transfer transmissions from the boom set mike to the oxygen mask mike. Transmission with hand mike remains available regardless of transfer switch position.

Radio reception is not affected by the transfer switch position.

AA

VHF COMMUNICATION SYSTEM

Two systems are provided.

Each system has its own transceiver to provide communications on more than 2000 channels from 118.000 to 136.975 MHz with 8.33 KHz spacing, and is controlled by a VHF control box with dual channel selection.

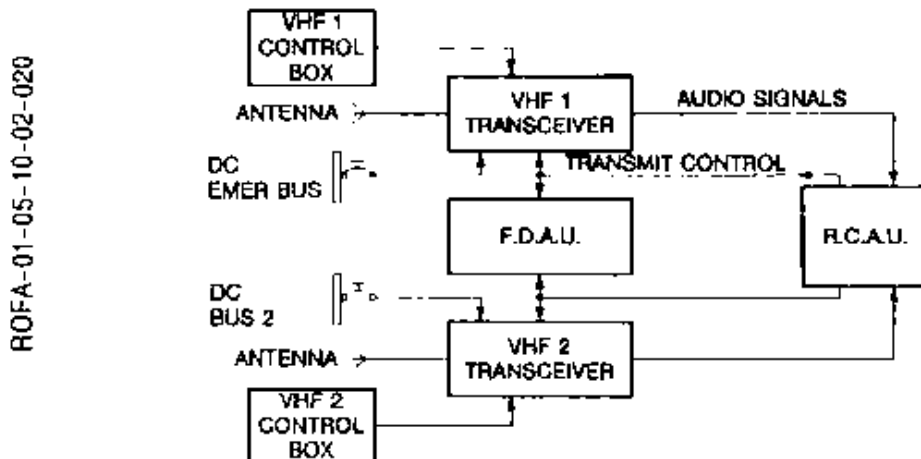



In case of audio control panel loss, two AUDIO SEL pbs allow to select one VHF on each side.

HF COMMUNICATION SYSTEM

The system provides the pilot access to 40 programmable channels, plus a full 280,000 operating frequencies in the 2.0 to 29.9999 MHz range.

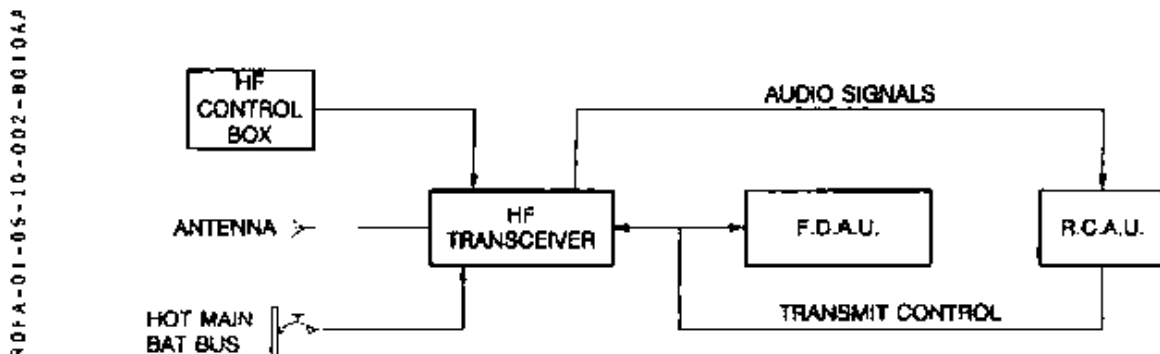
It is controlled by a HF control box through its transceiver.



	COMMUNICATIONS GENERAL	1.05.10		
		P 3	070	
				JUL 99

AA

INTERPHONE SYSTEM

- To interconnect all stations (ground crew stations + cockpit + cabin attendant) :
 - Depress INT transmissions key
 - Use PTT pbs
- Cockpit crew interphone
 - Using boom set or oxy mask :
 - Set the RAD/INT selector on "INT" position without use of PTT pb or,
 - Set the PTT selector (control wheels) in the forward position regardless of the RAD/INT selector position
- To call cabin attendant from the cockpit (see 1.05.10 p 9)
 - Depress the ATTND pb (overhead panel) for a normal call, or press the ATTND pb three times successively for an emergency call.

A single chime (or three for an emer call) is generated in the cabin and the CAPT white light illuminates on the cabin attendant panels. As soon as the cabin attendant selects "INT", the CAPT It extinguishes.

- To call cockpit from cabin attendant station
 - Depress INT pb (besides the hostess panel) for a normal call or press the EMER pb for an emergency call.

Associated ATTND light illuminates on overhead panel and a door bell is generated by the MFC. By pressing RESET, both visual and aural calls will be cancelled.

- To call the ground crew from the cockpit (see 1.05.10 p 9)
 - Depress MECH pb (overhead panel)

A horn call is generated in the nose gear bay.

- In case of ground crew call
 - MECH pb illuminates blue on overhead panel and a door bell is generated by the MFC. By pressing RESET, both visual and aural calls will be cancelled.

PASSENGER ADDRESS SYSTEM

The passenger address system allows the crew and the cabin attendant to make announcements to the passengers. Passenger address system also generates single chime sound in the cabin. The passenger address system is connected to :

- The RCAU which allows the cockpit crew to make announcements to the passengers by selecting PA key on audio control panel.
- The cabin attendant handset
- The cabin attendant call pb distributed in the cabin for the passengers
- The cabin attendant call pb in the cockpit
- The NO SMOKING/FASTEN SEAT BELTS controls
- The cockpit voice recorder
- Loudspeakers distributed in the cabin (one of them being installed in the toilet)

DISTRIBUTION OF AURAL ALERTS

Generated by CCAS (refer to chapter 1.02)

Generated by GPWS (refer to chapter 1.15)

Generated by TCAS (when installed, refer to 1.05.20)

	COMMUNICATIONS		1.05.10	
			P 4	001
	GENERAL			DEC 96

10.2 CONTROLS

AUDIO CONTROL PANEL

40FA-01-85-10-004-AC01AA

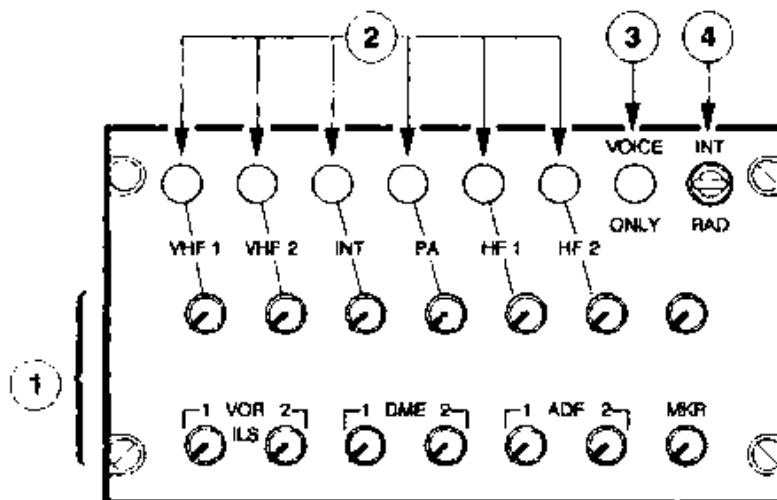
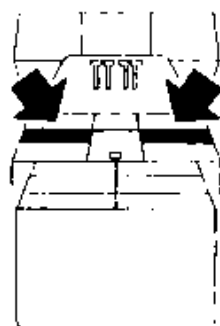

- ① Volume control knob
To control reception volume for associated communication or navigation facilities.
- ② Transmission keys
To select the individual communication facilities for transmission, six interlocked keys are provided. Only one key can be engaged at a time. It illuminates white when selected.
- ③ VOICE ONLY key
When depressed, it inhibits NAV receivers station identification by activating a band cut off filter above 1020 HZ. Light illuminates amber.
- ④ INT/RAD selector
Provides selection of transmission mode when using OXY MASK or BOOM SET mike.

INT	Hot mike position. Interphone is always operative between crew stations. Other transmissions require to select a transmission key and use a PTT pb.
NEUTRAL	Only handmike is usable as long as one transmission key is selected.
RAD	This position is required to automatically connect for transmissions BOOM SET and OXY MASK mikes without using a PTT pb.

Note: Recovering boomset/micro function when the oxygen mask is out of its container: cf 1.07.20.

	COMMUNICATIONS		1.05.10		
	GENERAL		P 5	010	
				DEC 96	

VHF CONTROL BOX

ROFA-01-05-10-205-AC10AA

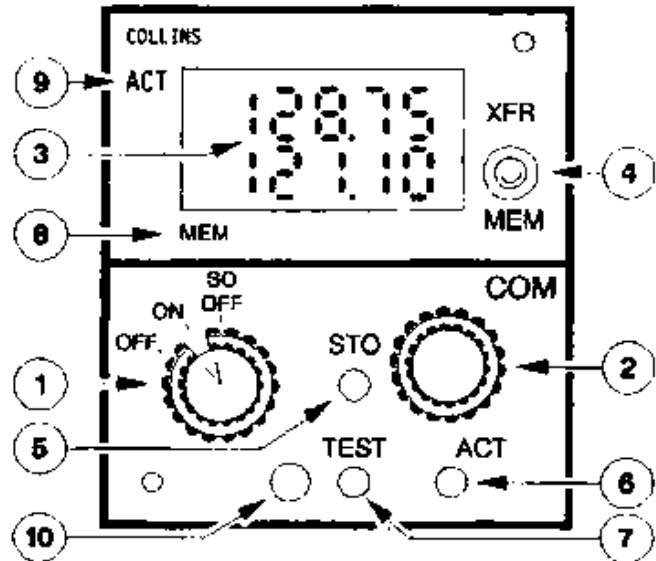
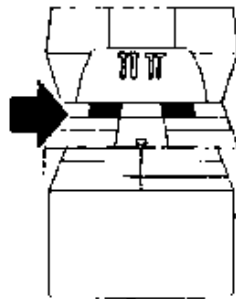

① ON/OFF and volume knob

Energizes the control box and the associated VHF. SQ OFF position disables the receiver squelch circuit.

② Frequency selector

In normal use, controls the preset frequency display :

- an outer knob is used for selection of MHz with an increment of 1 MHz
- an inner knob is used for selection of KHz with an increment of 50 KHz or 25 KHz for the first two steps when the direction of rotation is reversed.

③ Frequencies display

The active frequency is displayed on the first line.
The preset frequency is displayed on the second line.
Annunciators are displayed on both lines.

④ XFR/MEM switch

This is a three positions spring loaded toggle switch.

- NEUTRAL
- XFR : exchanges preset and active frequency.
- MEM : successive actions cycle the six memory frequencies through the display.

	COMMUNICATIONS GENERAL	1.05.10		
		P 6	010	
				DEC 96

AA

⑤ STO button

Allows entering six frequencies in the memory. When depressed, the upper window displays the channel number of available memory (CH1 to CH6). For 5 seconds, the MEM switch may be used to advance through the channel numbers. Push the STO button a second time enters the preset frequency in the selected channel.

After 5 seconds, the control will return to normal operation.

⑥ ACT button

Allows to change the active frequency. When depressed, second line displays dashes, and first line can directly be tuned from frequency selector.

Returns to the initial configuration when depressed a second time.

⑦ TEST button

is used to initiate the radio self-test diagnostic routine.

⑧ Annunciators

Three types of messages can appear in this location.

MEM illuminates when a preset frequency is being displayed on the second line.

RMT illuminates when the VHF is remotely tuned (by an FMS e.g.).

TX illuminates when the VHF is transmitting.

⑨ Compare annunciator

ACT signal illuminates when frequencies are being changed.

ACT flashes if the actual radio frequency is not identical to the frequency in the active frequency display.

⑩ Light sensor

automatically controls the display brightness.

CAUTION: Interference may occur between VHF 2 and SGU at the frequency 135.0 MHz

	COMMUNICATIONS GENERAL	1.05.10		
		P 7	130	
				DEC 96

ATC CONTROL BOX

RDFFA-01-05-10-007-A130AA

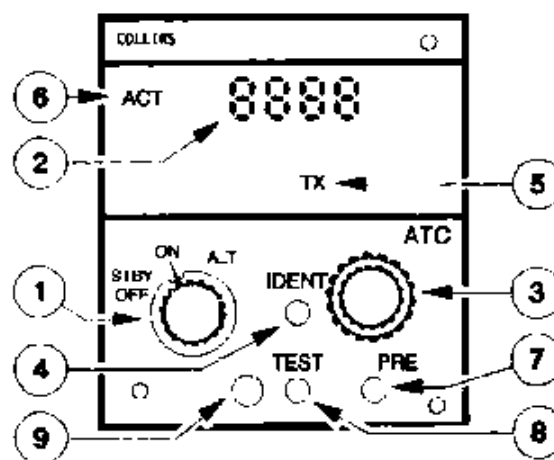

- ① Power and mode switch
 OFF ATC control box and transceiver are deenergized.
 SBY ATC system is powered, but does not transmit replies.
 ON ATC Transponder Mode S replies to both Mode A and Mode C interrogations from ground or air.
 ALT Normal operating position. Transponder replies with flight level information.
- ② Code display
 Displays selected code.
- ③ Code select knobs
 – Outer knob controls the two left-hand digits.
 – Inner knob controls the two right-hand digits.
- ④ IDENT button
 When depressed, causes the transponder to transmit "IDENT" signal.
- ⑤ Annunciators
 TX is displayed when the ATC replies to an interrogation.
 RMT is displayed when the ATC is remotely tuned (by an FMS e.g.).
- ⑥ ACT Compare annunciator
 ACT is displayed during code changes.
 ACT flashes when the actual reply code is not identical to the code shown in the active code display.
- ⑦ PRE button (Preset)
 Push and hold the PRE button while turning the code select knobs to select a preset code for storage.
 The stored code can be recalled by momentarily pressing the PRE button again.
- ⑧ TEST button
 Press the TEST button to initiate the radio self test routine.
- ⑨ Photo cell
 Automatically controls the display brightness.

	COMMUNICATIONS		1.05.10	
	GENERAL		P 8	001
			DEC 96	

AA

PTT SELECTOR

ROFA-01-05-10-006-A001AA

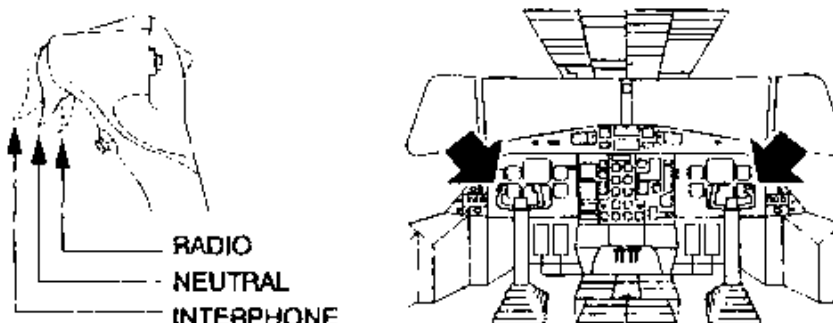

The outboard horn of both control wheels is provided with a PTT selector controlling the transmission mode and effective only when BOOM SET or OXY MASK mike is used for transmission.

Interphone Forward position springloaded to neutral. transmission on flight interphone selected. INT transmission key has not to be used to communicate between cockpit crew stations.

Neutral Center position. Transmission is not possible. Reception is normal. Hand microphones are connected for transmission when keyed.

Radio Backward position springloaded to neutral. BOOM SET or OXY MASK is connected for transmission over the selected communication facility.

NOSE WHEEL STEERING CONTROL SW

ROFA-01-05-10-008-B001AA

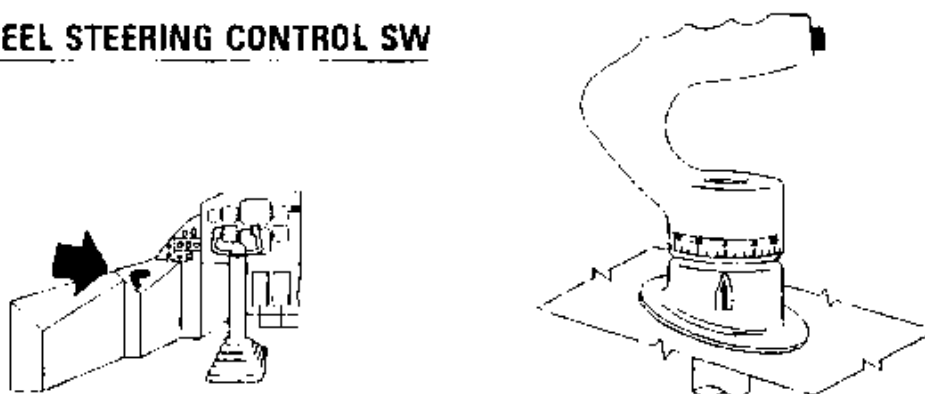

When depressed, BOOM SET or OXY mike is connected for transmission over the selected communication facility.

HEAD SET/BOOM SET PANEL/HAND MIC PANELS

ROFA-01-05-10-008-C001AA

Allow connection of a boom set, a head set and a hand mike.

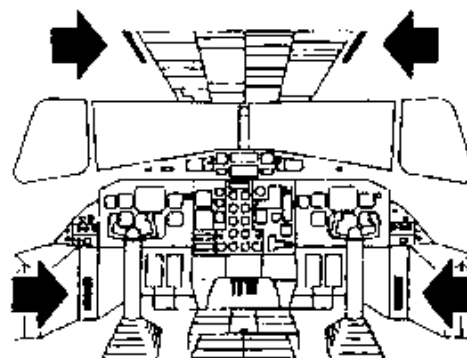
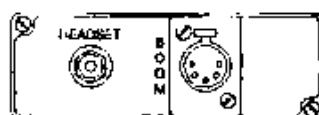

AA

LOUDSPEAKERS VOLUME KNOBS

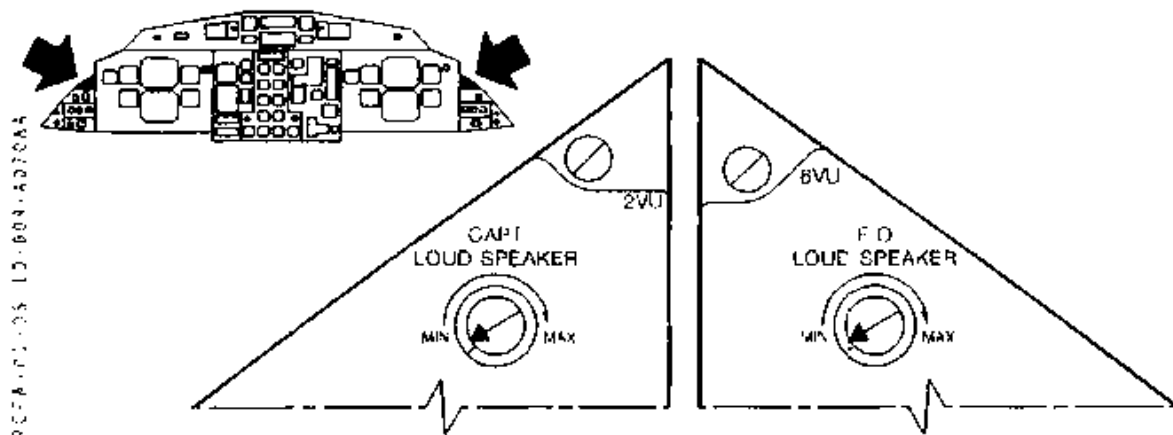

Communication reception over cockpit loudspeakers is controlled by an individual knob for each of the two cockpit loudspeakers.

Note : In case of aural alert :

- normal volume is always available regardless of knobs position.
- during any transmission, the volume of both loudspeakers is muted.

AUDIO SEL PB(s)

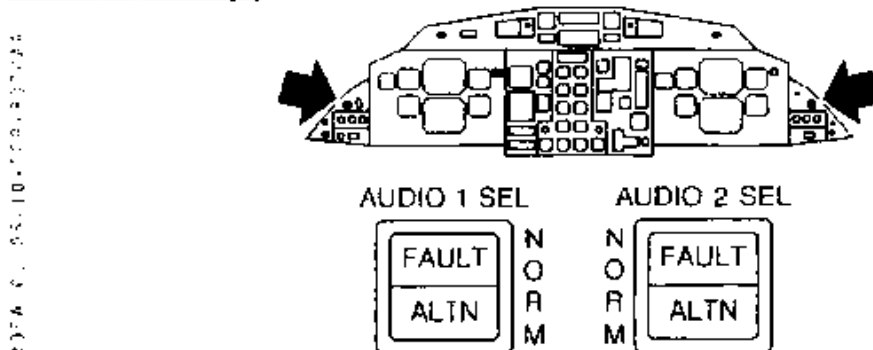

Controls functioning of associated RCAU processing board.

NORM (pb depressed) RCAU functions normally.

FAULT illuminates amber and the CCAS is activated when when an associated RCAU processing board failure or power loss is detected.

ALTN (pb released) affected crew station is connected directly to :
VHF 1 if CAPT station is affected or VHF 2 if F/O station is affected.

Volume is adjusted by affected loudspeaker volume control.

Note : On the affected side PA, interphone and other VHF can not be used any longer.

CALLS PB(s)

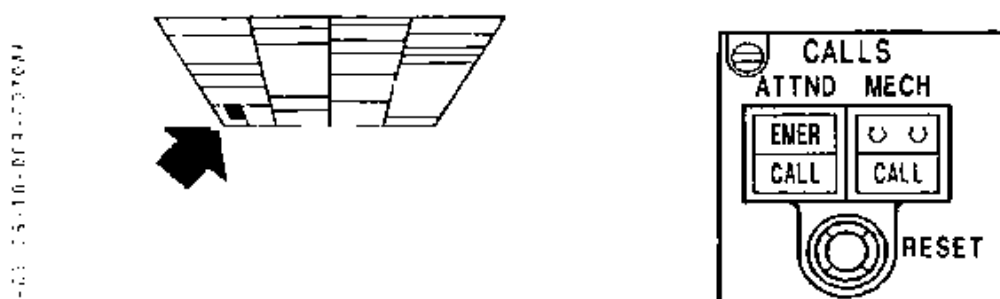

	COMMUNICATIONS		1.05.10	
	GENERAL		P 10	050
			JUL 98	

AA

EMERGENCY BEACON



ROFA-01-05-10-010-AD50AA

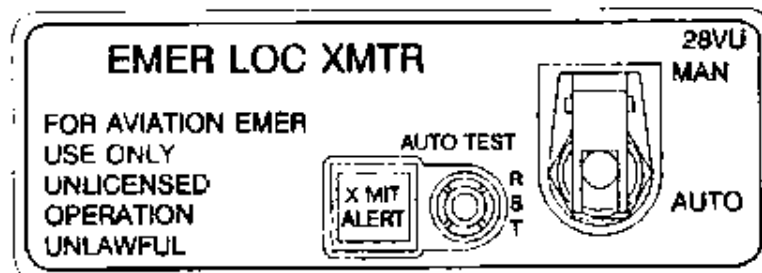

The transmitter is located in the ceiling of the cabin between the passengers entry door and the toilet door. The antenna is located in the fairing ahead of the stabilizer fin. This system includes its own battery.

- AUTO** transmission is made automatically on 121.5 MHz, 243 MHz and 406 MHz when deceleration exceeds 5 g (X MIT ALERT It illuminates amber).
- MAN** allows commanded operation (X MIT ALERT It illuminates amber).
- AUTO TEST RST** is used in case of undue alert (reset), or to test the emergency beacon. Two cases are possible for the test :
- Net work X MIT ALERT illuminates amber during 2 seconds.
 - Failure X MIT ALERT It flashes during 15 seconds.

CAUTION : The test must not be performed in MAN mode.

- R Aircraft on ground (and electrically supplied), when the emergency beacon is triggered R after 30 seconds, the mechanical horn is triggered too.

	COMMUNICATIONS	1.05.10	
	GENERAL	P 11	010
		DEC 96	

HF CONTROL BOX

RGFA-01-05-10-011-A010AA

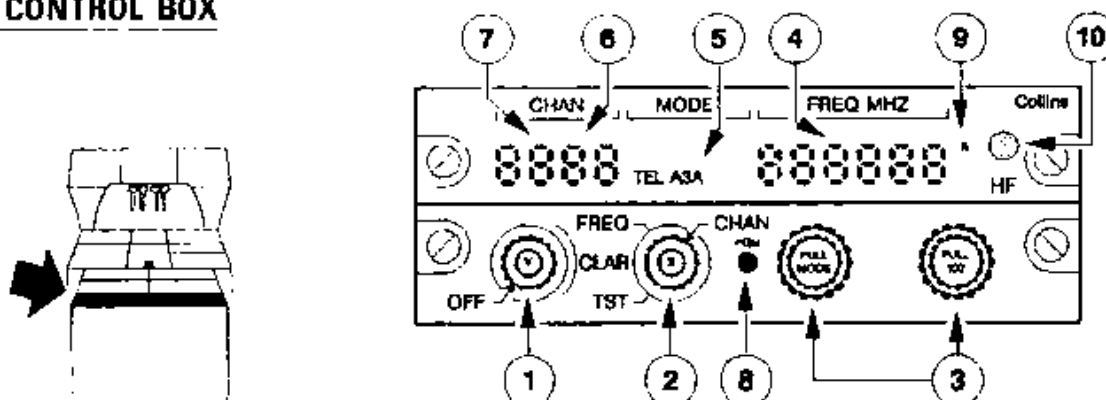

① – ON/OFF and CLARIFIER knobs

- Inner knob turns ON and OFF the system, and controls the volume.
- Outer knob (clarifier) adjusts received frequency in case of single sideband operating mode.

② – SQUELCH/FREQ-CHAN selector

- Inner knob allows to reduce background noise when not receiving a signal.
 - Outer knob selects channel mode or discrete frequency mode of operation.
 - FREQ : selection knobs ③ allow to directly select used frequency (displayed on ④).
 - CHAN : selection knobs ③ allow to select :
 - Either a 2-digit channel number (displayed on ⑥) received to store a frequency on this channel.
 - Either a 4-digit ITU (Maritime) channel number (displayed on ⑥) corresponding to a duplex function : on each ITU channel, a received frequency and a transmit frequency are automatically stored.
- When an ITU channel is selected, received frequency is displayed on ④. When transmitting, transmit frequency is displayed on ④.

③ – CHANNEL/FREQUENCY selection knobs

- When FREQ/CHAN selector is in "FREQ" position.
 - Left outer knob : Selects and displays the MHz digits (1 through 29).
 - Left inner knob : * Pusher in : selects the 100 Hz digits (0 through 9).
* Pulled out : selects HF modes (USB, AM or LSB).
 - Right outer knob : Selects and displays the 10 KHz digit (0 through 9).
 - Right inner knob : * Pushed in : selects the 1 KHz digit (0 through 9).
* Pulled out : selects the 100 Hz digit (0 through 9).
- When FREQ/CHAN selector is in "CHAN" position.
 - Left outer knob : Selects the ITU band (first two digits) in case of ITU channel selection. When turned down, the two first digits disappear, and right outer knob displays a storing channel.
 - Left inner knob : * Pushed in : has no effect.
 - Left inner knob : * Pulled out : selects modes (TEL SUP CAR or TEL PLT CAR) in case of ITU channel selection.

	COMMUNICATIONS	1.05.10		
	GENERAL	P 12	010	
				DEC 96

- Right outer knob : Selects the individual channel number (last two digits) in case of ITU channel selection.
Selects the two digits storage channel in case of programming use.
When selecting beyond 1 or 40 channel number, ITU channels will appear.
- Right inner knob : Has no effect.

④ Frequency display

Displays the frequency (directly selected or channel-stored).

⑤ Mode display

Displays the associated mode (for normal frequencies or ITU channels).

⑥ CHANNEL display - Right digits

Displays the individual channel number, or the storage channel number.

⑦ CHANNEL display - Left digits

Displays the ITU band in case of ITU channel selection.

⑧ PGM (Program) switch

Allows to store frequencies in the 40 available channels by the following mode :

Selector on "CHAN" position.

Select the desired user channel by using selecting knobs ③.

- Press PGM button. The whole display blinks.

- Select the desired frequency and mode by using selecting knobs ③.

- Press PGM button again to store the frequency.

At this point, three ways are possible.

- Store a received only frequency : only wait 20 s that the display blinking stops.

- Store a simplex channel : press PGM button a third time to store the blinking frequency as a transmit frequency. Received and transmit frequencies are now the same.

Store a half duplex channel : during the display blinking time (20 s) a second frequency can be selected as a transmit frequency. The considered channel stores the first frequency as a receive one, and the second frequency as a transmit one.

⑨ Indicator

- "R" indicates that the system is in received mode.

- "T" indicates that the system is in transmit mode.

⑩ Photo cell

Automatically adjusts display brightness.

Note : Depending on version one or two identical HF control boxes may be installed. Only one antenna is associated with these two control boxes permitting two reception but only one emission at the same time.

	COMMUNICATIONS	1.05.10		
		P 17	001	
	GENERAL			DEC 96

10.3 ELECTRICAL SUPPLY/MFC LOGIC/SYSTEM MONITORING

ELECTRICAL SUPPLY

EQUIPMENT	DC BUS SUPPLY (C/B)	AC BUS SUPPLY (C/B)
VHF 1	DC EMER BUS (on overhead panel VHF 1)	NIL -
VHF 2	DC BUS 2 (on overhead panel VHF 2)	- Nil -
CAPT audio system	DC ESS BUS (on overhead panel CAPT)	- Nil -
F/O audio system	DC ESS BUS (on overhead panel F/O)	- Nil -
ATC	DC EMER BUS (on overhead panel ATC)	- Nil -
TCAS (if installed)	DC BUS 2 (on overhead panel TCAS)	- Nil -
Attendant call	DC ESS BUS (on overhead panel ATTND)	- Nil -
Ground crew call	DC ESS BUS (on overhead panel MECH)	- Nil -
Passenger call system	DC FSS BUS (on overhead panel PUBLIC ADDRESS)	Nil -
HF2 (when installed)	HOT MAIN BAT BUS (on overhead panel HF2)	- Nil -
HF1 (when a second HF is installed)	DC BUS 1 (on overhead panel HF1)	- Nil -
SELCAL (when installed)	DC BUS 1 (on overhead panel SEL CAL)	- Nil -



ATR 72
F.C.O.M.

COMMUNICATIONS

GENERAL

1.05.10

P 18

001

DEC 96

MFC LOGIC

See chapter 1.01.

SYSTEM MONITORING

The following conditions are monitored by visual and aural alerts :

- RCAU processing board failure or power loss.
 - See AUDIO SEL FAULT procedure in chapter 2.05.12.

10.4 SCHEMATIC

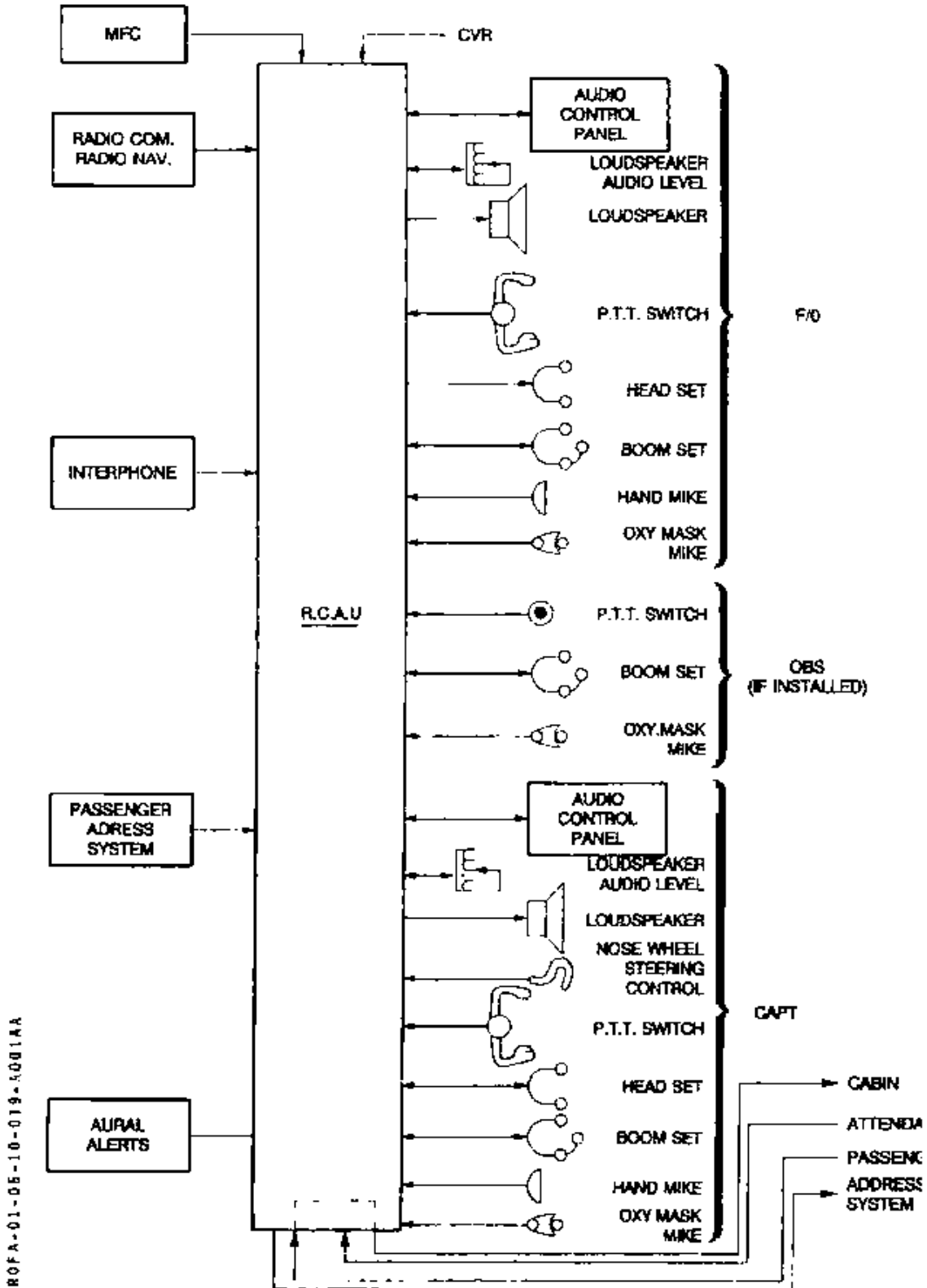

	COMMUNICATIONS TCAS	1.05.20		
		P 1	050	
				JUL 01

AA

20.1 DESCRIPTION

The TCAS is an on-board collision avoidance and traffic situation display system with computer processing to identify and display potential and predicted collision targets, and issue vertical resolution advisories on the pilot's TCAS vertical speed indicator (TCAS VSI) to avoid conflict. From the transponder replies, TCAS determines relative altitude, range, and bearing of any aircraft equipped with a mode C or S transponder. From this, TCAS will determine the threat using standardized algorithms. Outputs from the TCAS System are voice messages and visual displays on the TCAS VSI's for Resolution Advisories (TCAS RA's) and Traffic Advisories (TCAS TA's).

The TA is informative and indicates potential threats. The RA displays a threat resolution in the form of a vertical maneuver if the potential conflict is projected to occur.

Threat aircraft with mode A transponders will not provide altitude information ; therefore TCAS will not issue resolution advisories for these threats. The TCAS will not detect aircraft without transponders.

The TCAS is a single system installation consisting of :

- One TCAS processor,
- two high resolution bearing antennae (one top mounted and one bottom mounted)
- two mode S transponders,
- two modified TCAS VSIs each integrating traffic advisory display and vertical speed information,
- one pylon mounted TCAS control box,
- two overhead speakers for voice messages and associated wiring.

 A320 F.C.O.M.	COMMUNICATIONS	1.05.20		
		TCAS	P 2	200
				JUL 01

20.2 CONTROLS

TCAS CONTROL BOX

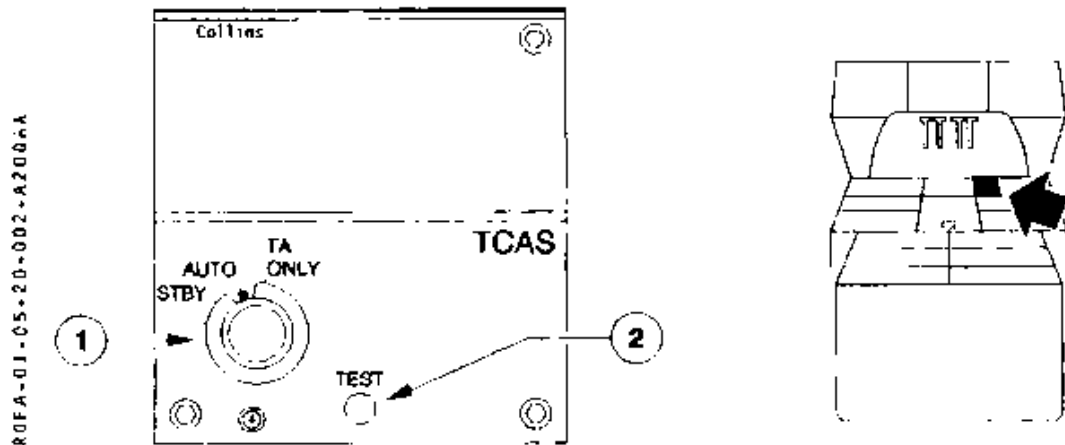

① TCAS rotary selector

Enables TCAS to be set to standby (STBY), automatic (AUTO), or traffic advisories only (TA ONLY) mode of operation.

STBY : TCAS system is under power, but TCAS functions (intruder visualisation, Traffic Advisory mode or Resolution Advisory) are not operative.

AUTO : Normal operating mode of the TCAS.

TA only

- Disables the RA mode of operation.
- May be selected but should be used only to prevent unnecessary resolution advisory when operating near closely spaced parallel runways or in the cases TCAS could command Climb maneuvers resulting in an unsafe situation for the aircraft (see limitations on 2.01.05).

Note : - If altitude reporting is off or no valid ModeS transponder is selected, TCAS will be in standby (RA OFF on TCAS VSI).

- If appropriate, TCAS will automatically go into the TA only mode when the TCAS equipped aircraft is below the RA descent altitude and in a climb inhibit configuration.

② TCAS test function

- The TCAS should be tested by pressing the "TEST" button during cockpit preparation.
- Use of the self-test function in flight will inhibit TCAS operation for up to 20 seconds depending upon the number of targets being tracked.
- The mode S ATC transponder will no function during some portion of the self-test sequence.

	COMMUNICATIONS TCAS	1.05.20		
		P 3	170	
				JUL 01

AA

DEFINITIONS

- (A) Advisory**
A message given to the pilot containing information relevant to collision avoidance.
- (B) Corrective resolution advisory :**
A resolution advisory that advises the pilot to deviate from current vertical speed, e.g., CLIMB when the aircraft is levelled.
- (C) Intruder**
A target that has satisfied the TCAS threat detection logic and thus requires a traffic advisory.
- (D) Mode S :**
Type of secondary surveillance radar (SSR) equipment which provides replies to mode A and Mode C interrogations and discrete address interrogations from the ground or air.
- (E) Preventive resolution advisory :**
A resolution advisory that advises the pilot to avoid certain deviations from the current vertical speed because certain vertical speed restrictions exist.
- (F) Proximate traffic :**
Nearby aircraft within ± 850 ft and 6NM which are neither an RA nor a TA.
- (G) Resolution advisory (RA) :**
Aural and visual information provided to the flight crew to avoid a potential collision.
- (H) Threat :**
A target that has satisfied the threat detection logic and thus requires a resolution advisory.
- (I) Traffic advisory (TA) :**
Information given to the pilot pertaining to the position of another aircraft in the immediate vicinity. The information contains no resolution information.

	COMMUNICATIONS		1.05.20	
			P 4	160
	TCAS			JUL 01

AA

20.3 OPERATION

The TCAS provides two levels of threat advisories :

If the traffic gets between 20 and 48 seconds (depending on aircraft altitude) of projected Closest Point of Approach (CPA), it is then considered an intruder, and an aural and visual traffic advisory is issued. This level calls attention to a developing collision threat using the traffic advisory display and the voice message, "TRAFFIC TRAFFIC". It permits mental and physical preparation for a possible maneuver to follow, and assists the pilot in achieving visual acquisition of the threat aircraft.

If the intruder gets between 15 and 35 seconds (depending on aircraft altitude), of CPA, it is considered a threat and an aural and visual resolution advisory is issued. This level provides a recommended vertical maneuver using modified TCAS VSI's and voice messages to provide adequate vertical separation from the threat aircraft, or prevents initiation of a maneuver that would place the TCAS aircraft in jeopardy.

The TCAS resolution advisories are annunciated by the following voice messages, as appropriate :

- (A) "CLIMB, CLIMB" :
(Climb at the rate depicted by the green (fly to) arc on the TCAS VSI).
- (B) "DESCEND, DESCEND" :
(Descend at the rate depicted by the green (fly to) arc.)
- (C) "(MONITOR VERTICAL SPEED)" :
Initial preventive RAs (adjust vertical speed to a value within the illuminated green arc).
- (D) "MAINTAIN VERTICAL SPEED MAINTAIN" :
(No crossing maintain rate RAs (corrective)).
- (E) "MAINTAIN VERTICAL SPEED, CROSSING MAINTAIN" :
(Altitude crossing, maintain rate RAs (corrective)).
- (F) "CLEAR OF CONFLICT" :
(Range is increasing, and separation is adequate, return to assigned clearance).
- (G) "CLIMB CROSSING CLIMB, CROSSING CLIMB" :
(Climb at the rate depicted by the green (fly to) arc on the TCAS VSI). Safe separation will best be achieved by climbing through the threat's flight path.
- (H) "ADJUST VERTICAL SPEED, ADJUST" :
(Adjust vertical speed to a value within the illuminated green arc).
- (I) "DESCEND, CROSSING DESCEND, DESCEND, CROSSING DESCEND" :
(Descend at the rate depicted by the green (fly to) arc on the TCAS VSI) safe separation will best be achieved by descending through the intruder's flight path).

	COMMUNICATIONS TCAS	1.05.20		
		P 5	150	
				JUL 01

AA

The following voice messages announce enhanced TCAS maneuvers when the initial TCAS RA does not provide sufficient vertical separation. The tone and inflexion must constate increased urgency.

- (A) "INCREASE DESCENT, INCREASE DESCENT" :
(descend at the rate depicted by the green (fly to) arc on the TCAS VSI). Received after "DESCEND" advisory, and indicates additional descent rate required to achieve safe vertical separation from a maneuvering threat aircraft.
- (B) "INCREASE CLIMB, INCREASE CLIMB" :
(climb at the rate depicted by the green (fly to) arc on the VSI). Received after "CLIMB" advisory, and indicates additional climb rate required to achieve safe vertical separation from a maneuvering threat aircraft.
- (C) "CLIMB-CLIMB NOW, CLIMB-CLIMB NOW" :
(climb at the rate depicted by the green (fly to) arc on the TCAS VSI). Received after a "DESCENT" resolution advisory and indicates a reversal in sense is required to achieve safe vertical separation from a maneuvering threat aircraft.
- (D) "DESCEND-DESCEND NOW, DESCEND-DESCEND NOW" :
(descend at the rate depicted by the green (fly to) arc on the TCAS VSI). Received after a "CLIMB" resolution advisory and indicates a reversal in sense is required to achieve safe vertical from a maneuvering threat aircraft.

All TCAS aural alerts are inhibited :

- below 1100 ft AGL when aircraft is climbing
- below 900 ft AGL when aircraft is descending

	COMMUNICATIONS TCAS	1.05.20		
		P 6	150	
				JUL 01

AA

TCAS OPERATING CHARACTERISTICS

- NON ICING CONDITIONS of inhibition

CONFIGURATION	RA CLIMB	RA INCREASE CLIMB
FLAPS 0°	AUTHORIZED	AUTHORIZED
FLAPS 15° TO	AUTHORIZED	INHIBITED
FLAPS 15° Approach	AUTHORIZED	AUTHORIZED
FLAPS 30°	AUTHORIZED	INHIBITED

- ICING CONDITIONS of inhibition

CONFIGURATION	RA CLIMB	RA INCREASE CLIMB
FLAPS 0° Z < 20 000 ft	AUTHORIZED	INHIBITED
Z > 20 000 ft	INHIBITED	INHIBITED
FLAPS 15° TO	AUTHORIZED	INHIBITED
FLAPS 15° Approach	AUTHORIZED	INHIBITED
FLAPS 30°	INHIBITED	INHIBITED

- The "increase climb" RA is inhibited for certain above conditions.

In non altitude crossing encounters for which a "CLIMB" RA is posted, the threat may maneuver or accelerate toward own aircraft and cause a reduction in vertical separation despite the RA. Since the "increase climb" RA is inhibited, the climb RA remains posted. As soon as the threat passes through own aircraft's altitude, the RA sense will be reversed and a "DESCEND" RA will be posted. If the threat never crosses through, the "CLIMB" RA will remain posted for the duration of the encounter.

- "DESCEND" RA's are inhibited :
 - until the aircraft is above 1200 ft AGL on take-off
 - below 1000 ft AGL for approach
- "INCREASE DESCEND" RA's are inhibited below 1450 ft AGL:
- All RA's are inhibited :
 - below 1100 ft AGL when aircraft is climbing
 - below 900 ft AGL when aircraft is descending
- The TCAS surveillance may not function at distances less than 900 ft.
- There can be a case where the threat aircraft track on altitude information is lost during an RA. In this case, the RA will terminate without a "CLEAR OF CONFLICT" annunciation.

	ELECTRICAL SYSTEM		1.06.00	
	CONTENTS		P 1	001
				DEC 96

1.06.00 CONTENTS

1.06.10 GENERAL

1.06.20 DC POWER

20.1 DESCRIPTION

20.2 CONTROLS

20.3 ELECTRICAL SUPPLY/MFC LOGIC/SYSTEM MONITORING

20.4 LATERAL MAINTENANCE PANEL

20.5 SCHEMATICS

1.06.30 AC CONSTANT FREQUENCY

30.1 DESCRIPTION

30.2 CONTROLS

30.3 ELECTRICAL SUPPLY/MFC LOGIC/SYSTEM MONITORING

30.4 LATERAL MAINTENANCE PANEL

1.06.40 AC WILD FREQUENCY

40.1 DESCRIPTION

40.2 CONTROLS

40.3 ELECTRICAL SUPPLY/SYSTEM MONITORING

40.4 LATERAL MAINTENANCE PANEL

1.06.50 EXTERNAL POWER

50.1 DESCRIPTION

50.2 CONTROLS

50.3 LATERAL MAINTENANCE PANEL

1.06.60 DISTRIBUTION EQUIPMENT LIST

	ELECTRICAL SYSTEM		1.06.10	
	GENERAL		P 1/2	020
				DEC 96

AA

The electrical power generation is provided by the following sources :

- Main and emergency batteries
- Two engine-driven DC starter/generators
- Two AC wild frequency generators
- Two external power units (AC and DC)

In addition, two static inverters (supplied by the DC system) provide constant frequency AC power.

The ACW electrical system can also supply DC electrical system through a transformer rectifier unit (TRU).

The electrical distribution is ensured by busses which feed equipments.

Two separate networks (left and right) run individually and can be connected in case of generation failure thanks to bus tie contactors (BTC).

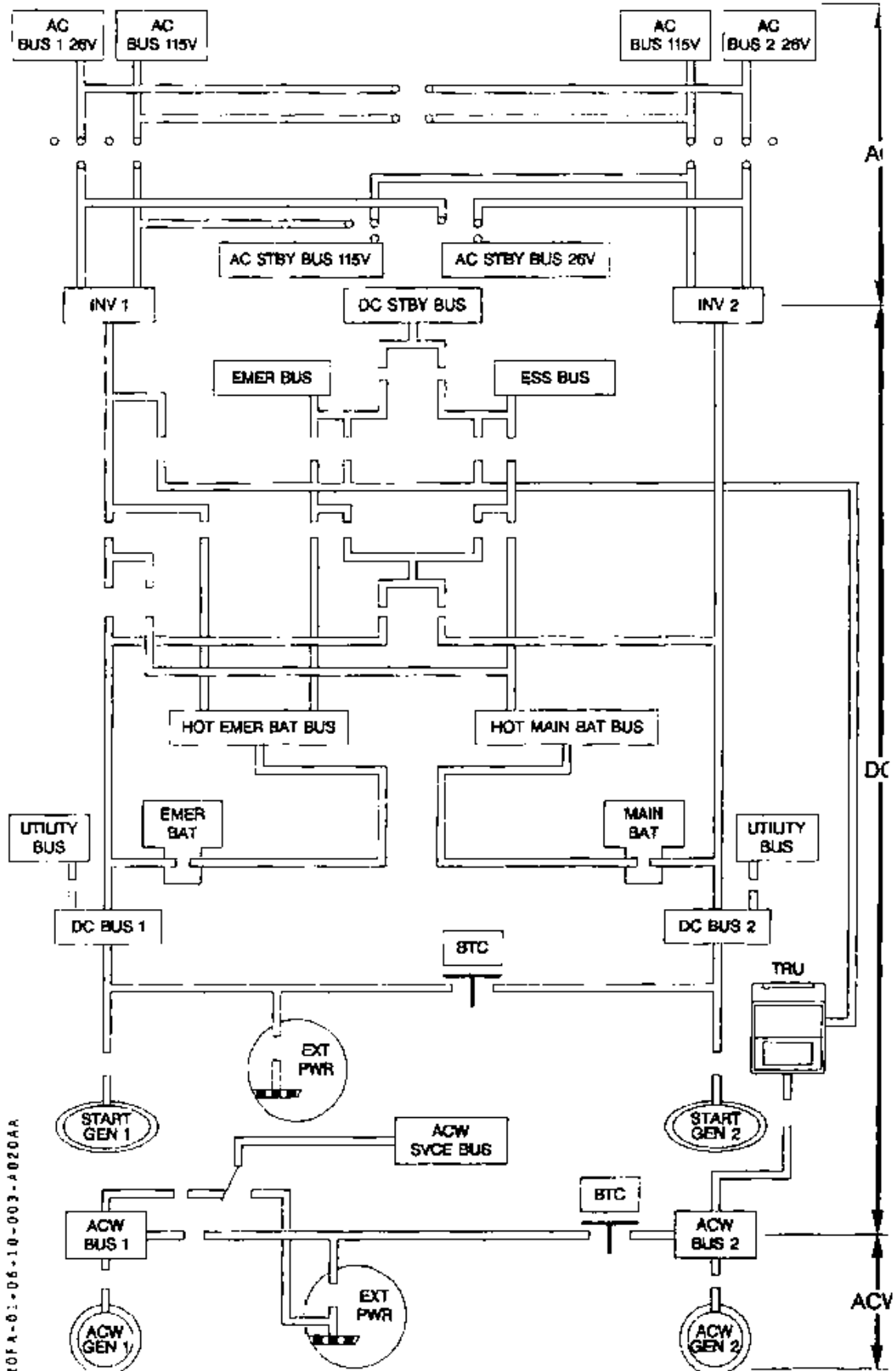

ROFA-01-06-10-003-A020AA

	ELECTRICAL SYSTEM		1.06.20	
	DC POWER		P 1	220
			JUN 97	

20.1 DESCRIPTION

GENERATION

The 28 VDC may be normally provided by :

- Two engines driven starter/generators,
- A ground external power unit.

Three sources may be used for the 28 VDC emergency supply :

- One main battery,
- One emergency battery, excluding START function,
- One TRU.

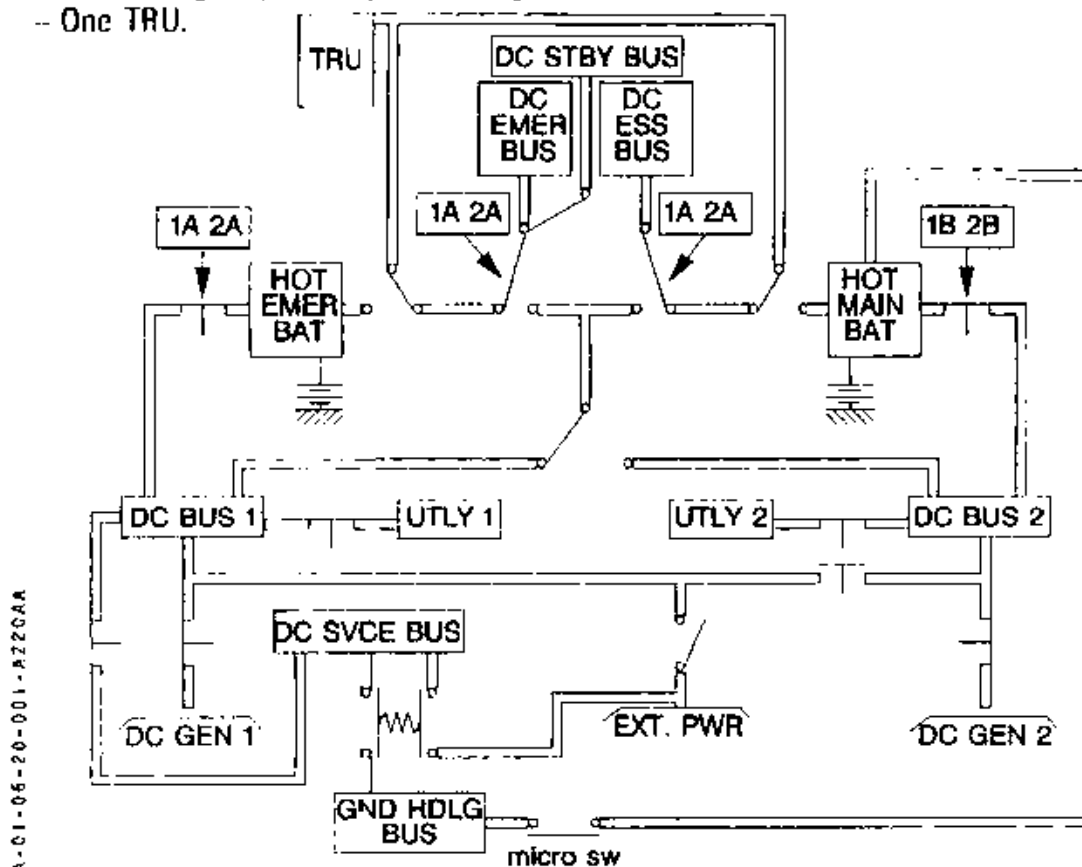

BOFA-01-06-20-001-AZZCAA

NOTE : means that the associated relay is monitored by MFC .

BATTERIES

A 24 V Ni-Cd battery of 43 Ah (main BAT) is provided for engine starting and for emergency power supply including propeller feathering.

A 24 V Ni-Cd battery of 15 Ah (emer BAT) which, in addition to its secondary role of avoiding power transients on critical equipment during engine starts, ensures power to the emergency network even if the main battery has been completely discharged by repeated start attempts.

Batteries monitoring is performed by MFC which :

- * connects the battery to the associated DC BUS for charging,
- * analyses the charge current and/or associated DC BUS voltage so as to prevent an abnormal battery operating condition or thermal runaway.

	ELECTRICAL SYSTEM		1.06.20		
			P 2	020	
	DC POWER				DEC 96

AA

TRU

A TRU is provided in order to conserve the batteries when DC power is under emergency supply conditions (both generators failed). In this configuration, DC electrical emergency system can be supplied by ACW electrical system, through the TRU.

STARTER/GENERATORS

The two DC starter/generators are driven by the engine accessory gear boxes. Each generator is a long life brushes air cooled type and is rated to deliver :

- Nominal output power : 12 KW (400 A)
- Nominal operating voltage : 27 to 31 V (nominal setting 30 V)

Starter mode :

In starting mode, the starter/generator is connected by the START contactor to :

- The aircraft main battery through a BATTERY START CONTACTOR, or
- The external power through an EXTERNAL POWER CONTACTOR, or
- The aircraft main battery and the other operating generator, on ground only (cross start).

In starter mode, the starter/generator cranks the engine to the point of self sustaining (associated engine START ON It illuminated on the ENG START panel). At the end of the start sequence (45 % NH), the start contactor opens (associated engine START ON It extinguished).

Generator mode :

When the engine reaches 61.5% NH, the starter/generator is acting as a generator. Provided associated DC GEN pb is selected and EXT PWR is not used, each generator feeds associated DC BUS through a GENERATOR CONTACTOR (GC).

A GENERATOR CONTROL UNIT (GCU) associated with each generator provides the control for the generator contactor and the start contactor.

The GCU monitors the point of regulation, where the voltage is maintained constant as the load varies, and provides fault detection and protection for :

- over/under voltage
- over/under speed
- differential fault current
- generator overload
- power and fault current limiting
- bus tie lock out
- reverse current
- equalizing load (in case of BTC failed closed).

The BUS TIE CONTACTOR (BTC) allows DC BUS 1 and 2 on line when only one generator is operating (for example during Hotel mode operation) or when the aircraft is powered from EXT PWR.

A single BUS POWER CONTROL UNIT (BPCU) provides the control for BUS TIE CONTACTOR, BATTERY START CONTACTOR, load shedding, EXTERNAL POWER functions, and DC SVCE BUS contactors.

	ELECTRICAL SYSTEM DC POWER	1.06.20		
		P 3	020	
				DEC 96

AA

DISTRIBUTION

The aircraft DC distribution network consists of eleven busses :

- Two main busses : DC BUS 1 and 2
- HOT MAIN BAT BUS and HOT EMER BAT BUS
- DC EMER BUS, DC ESS BUS and DC STBY BUS
- UTLY BUS 1 and 2
- DC SVCE BUS
- GND HDLG BUS

DC BUS 1 and 2

The DC BUS 1 is normally supplied by the LH engine driven generator and the DC BUS 2 by the RH engine driven generator.

In case of generator failure, the associated DC BUS will be automatically supplied by the other generator through the BUS TIE CONTACTOR.

DC BUS 1 normally supplies :

HOT EMER BAT BUS, DC EMER BUS, DC STBY BUS, UTLY BUS 1, INV 1 and DC SVCE BUS.

DC BUS 2 normally supplies :

HOT MAIN BAT BUS, DC ESS BUS, UTLY BUS 2, INV 2.

HOT BAT BUSES

- HOT MAIN BAT BUS and HOT EMER BAT BUS are normally supplied by main DC busses.
- In case of main DC busses failure or thermal runaway of one of the batteries, the associated HOT BAT bus is supplied by its respective battery.

DC ESS BUS/DC EMER BUS/DC STBY BUS

In normal operation, DC EMER BUS and DC STBY BUS are supplied from HOT EMER BAT BUS. DC ESS BUS is supplied from HOT MAIN BAT BUS.

In case of thermal runaway of one of the two batteries, the associated busses are transferred to DC BUS 1 supply.

If DC BUS 1 is not powered, these busses are transferred to DC BUS 2 supply, by the Main Bus Transfer Contactor.

If Both DC generators are lost :

- When TRU is operative, DC EMER BUS, DC ESS BUS can be supplied by the ACW electrical system, through the Transformer Rectifier Unit.
- When TRU is not operative, the DC EMER BUS, DC ESS BUS and DC STBY BUS are supplied by their respective HOT BAT BUS.

Note : During engine starts, or when cranking, DC STBY BUS is supplied by HOT EMER BAT BUS. INV 1 remains supplied by HOT MAIN BAT BUS.

UTLY BUS 1 and 2

The UTLY BUS 1 and 2 supply non essential loads. They are supplied by the associated main DC BUS through UTLY BUS CONTACTORS (UBC(s)). The contactors are controlled by the BPCU so that the UTLY BUS(ES) can be automatically deenergized if the supply source becomes overloaded.

	ELECTRICAL SYSTEM		1.06.20	
	DC POWER		P 4	220
				JUL 99

AA

DC SVCE BUS

The DC SVCE BUS supplies power in flight, and on ground during airplane servicing operations.

The DC SVCE BUS can be supplied by :

- DC BUS 1. The master sw is the DC SVCE/UTLY BUS pb. When selected on, the cabin attendant controls the DC SVCE BUS supply from a sw located on the cabin attendant control panel.
- EXT PWR. Only the cabin attendant pb has control. The supply of the BUS may be performed with batteries switched OFF.

GND HDLG BUS

The GND HDLG BUS supplies the DC loads required for airplane servicing on the ground even with BAT sw selected OFF. Since these loads are not required during flight, the GND HDLG BUS is deenergized in flight. The GND HDLG BUS can be supplied :

- When EXT PWR is available, from DC SVCE BUS.
- When EXT PWR is not available, from HOT MAIN BAT BUS provided :
 - Cargo door operating panel door is open (micro switch), or
 - Refueling panel is open (micro switch), or
 - Entry door is open (micro switch).

TRANSFER (see schematics p. 15 to p. 26)

With all switches in normal position, the DC power transfer is achieved by automatic opening and/or closure of electrical contactors according to the particular electrical conditions.

- On ground
 - When EXT PWR is connected (p. 15/16)

Note : *The electrical power transfer is achieved in the same way as in flight as long as EXT POWER is not connected.*

- In flight
 - Both engine driven generator operating (p. 19/20)
 - * The engine driven generator 1 supplies the DC BUS 1,
 - * The engine driven generator 2 supplies the DC BUS 2,
 - * The BTC is open.
 - If one engine driven generator fails (p. 21/22)
 - * The BTC closes (BTC green flow bar illuminates),
 - * The entire electrical network is supplied by the remaining engine driven generator.
 - If both engine driven generators fail (p. 23/24)
 - * DC ESS BUS, DC STBY BUS are supplied from the main battery, or from the TRU, if selected ON.
 - * DC EMER BUS is supplied from the emergency battery or from the TRU, if selected ON.
 - If both engine driven generators fail and TRU is inoperative (p. 25/26)
 - * When DC STBY BUS reaches undervoltage (amber UNDV light comes ON), this bus may be recovered by selecting OVERRIDE pb.

R

	ELECTRICAL SYSTEM		1.06.20	
	DC POWER		P 5	001
				DEC 96

AA

20.2 CONTROLS

GENERATION



ROFA-01-06-20-005-4301PA

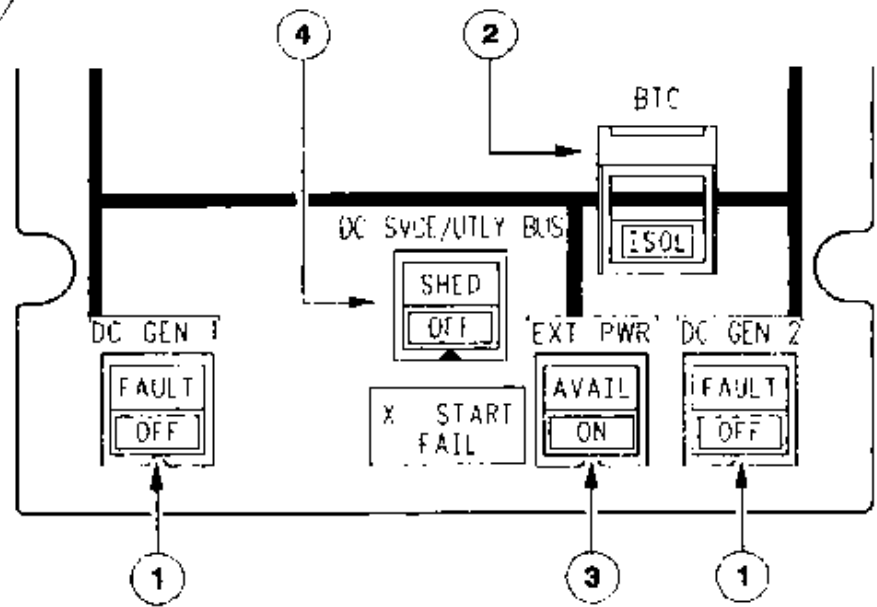

① DC GEN pb

Controls the energization of associated generator and the resetting of the protection system after failure.

ON (pb pressed in) Associated generator is energized and associated generator contactor closes if the network electrical parameters are normal.

OFF (pb released) associated generator is deenergized and associated generator contactor is opened. The OFF light illuminates white.

FAULT illuminates amber and the CCAS is activated in event of :

- A protection trip initiated by the associated GCU. If it is caused by a generator underspeed, reset will be automatic. For the other cases, a manual reset has to be performed.
- An opening of a generator contactor except if pb is selected OFF. In both cases, the BUS TIE CONTACTOR closes and affected DC BUS is automatically supplied from the remaining generator.

	ELECTRICAL SYSTEM DC POWER	1.06.20		
		P 6	001	
				DEC 96

AA

② BTC pb

This guarded pb controls the DC BUS TIE CONTACTOR (BTC) which, when closed, connects both main DC BUSSES.

NORM (released) The BPCU automatically controls the BTC

- In normal conditions with both generators operating, the BTC is opened allowing isolated operation of both generator circuits.
- In case of external power operation, Hotel mode or single generation, the BTC is automatically closed, the flow bar is illuminated.

ISOL (pressed in) The BTC is opened. ISOL light illuminates white.

③ EXT PWR pb

AVAIL Illuminates green when conditions of DC external power connection are met.

ON Allows to connect DC external power.
Refer to EXTERNAL PWR section for more informations.

④ DC SVCE/UTLY BUS pb

Controls connection/disconnection of DC SVCE BUS and both UTLY BUSSES to associated main DC BUSSES.

NORM (pb pressed in) DC SVCE BUS and both UTLY BUS are available unless a load shed signal is provided by the BPCU.

OFF (pb released) DC SVCE BUS and both UTLY BUSSES are disconnected from associated main DC BUS. The OFF It illuminates white.

SHED Illuminates amber and the CCAS is activated when a load shed condition controlled by the BPCU is present and at least one UTLY BUS is disconnected from associated main DC BUS.

	ELECTRICAL SYSTEM		1.06.20	
	DC POWER		P 7	020
			DEC 96	

DISTRIBUTION



ROFA-01-06-20-007-A020AA

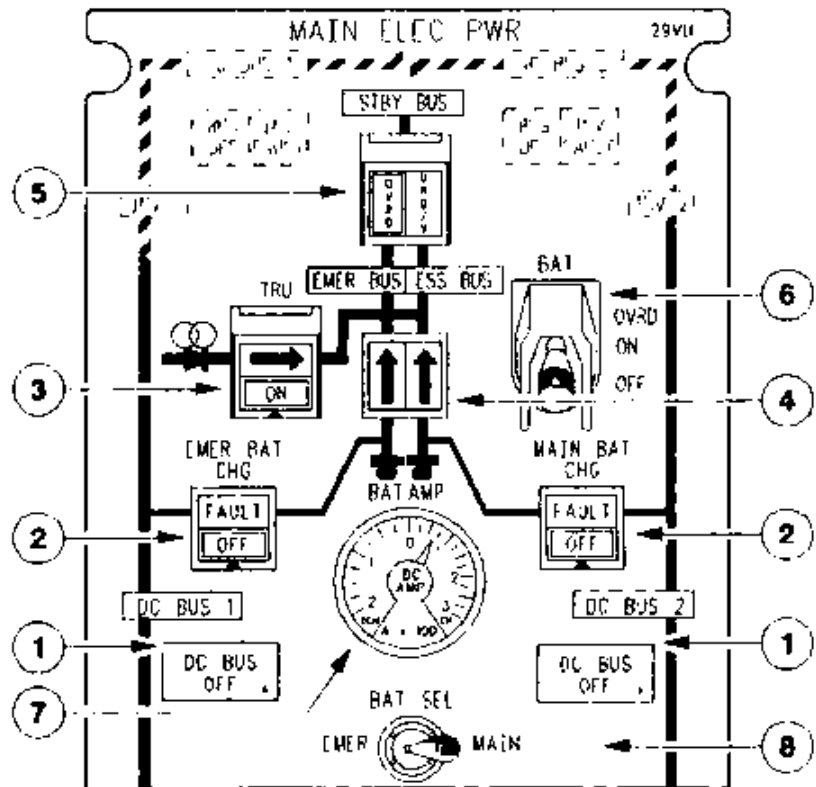

① DC BUS OFF lights

Illuminates amber when associated main DC BUS is not supplied.

If one DC BUS is OFF, the CCAS will be activated (MC + SC + ELEC on CAP)

② BAT CHG pbs

Controls the operation of the associated BATTERY CHARGE CONTACTOR.

ON (pb pressed in) The contactor is controlled by the MFC.

Contactor is closed in normal operation, it opens in case of :

- Thermal runaway of battery
- Undervoltage of DC MAIN BUS (< 25 V)
- Start sequence initiated (in this case, both BCC are opened, and closed when start rotary selector leaves START or CRANK position).
- An OVRD signal on BAT switch

OFF (pb released). The charge contactor is opened. The OFF light illuminates white.

FAULT Illuminates amber and the CCAS is activated in event of :

- An overheat detected by the MFC. In this case, the charge contactor automatically opens.
- A failure of the charge contactor.

	ELECTRICAL SYSTEM		1.06.20	
	DC POWER		P 8	020
				DEC 96

AA

- ③ TRU pb
NORM (pb released)
 - One engine driven generator operating :
 • DC EMER and DC STBY BUS are supplied from HOT EMER BAT BUS.
 • INV 1 is supplied from DC BUS 1
 • DC ESS is supplied from HOT MAIN BAT BUS.
 - Both engine driven generators failed :
 • DC EMER is supplied from HOT EMER BAT BUS
 • INV 1, DC STBY BUS and DC ESS BUS are supplied from HOT MAIN BAT BUS
- ON (pb pressed in) The TRU is connected to ACW BUS 2. ON It illuminates white. Arrow → illuminates amber when supply of DC EMER BUS, DC STBY BUS, INV 1 and DC ESS BUS from TRU is effective.
- ④ Emergency supply ind
 Right arrow illuminates amber when the DC ESS BUS is supplied from the MAIN BAT.
 Left arrow illuminates amber when the DC EMER BUS is supplied from the EMER BAT.
- ⑤ OVRD pb
 When on batteries supply, this guarded pb allows to transfer the DC STBY BUS and the INV 1 from HOT MAIN BAT BUS to HOT EMER BAT BUS.
 NORM (pb released) The DC STBY BUS and INV 1 are supplied from the same source as DC ESS BUS.
 OVRD (pb pressed in) The DC STBY BUS and INV 1 are supplied from the same source as DC EMER BUS. OVRD It illuminates white (see p 21).
 UNDV The It illuminates amber, to indicate that DC STBY BUS voltage is lower than 19.5 v. OVRD may be used as necessary
- ⑥ BAT toggle sw
 The BAT three positions toggle sw is used to provide DC electrical power :
 - from the emer battery to the EMER BUS,
 - from the main battery to the ESS BUS, and DC STBY BUS, and through the INV 1, to the AC STBY BUS.
 OFF ESS BUS, DC STBY BUS and INV 1 are isolated from the HOT MAIN BAT BUS.
 DC EMER BUS is isolated from the HOT EMER BAT BUS.
 ON - With engine driven generators OFF and EXT PWR off, ESS BUS, STBY BUS and INV 1 are supplied from the HOT MAIN BAT BUS. EMER BUS is supplied from the HOT EMER BAT BUS.
 - With generation other than battery available, ESS BUS is supplied by the HOT MAIN BAT BUS ; EMER BUS and STBY BUS are supplied by the HOT EMER BAT BUS.
 OVRD Allow to be sure busses are supplied by their respective battery by overriding all protections. This position is protected by a toggle guard.
- ⑦ DC AMP ind.
 Indicates the charge (CH)/discharge (DCH) current of the selected battery.
- ⑧ BAT AMP reading selector
 Enables to select the battery checked by the ammeter (7).

	ELECTRICAL SYSTEM DC POWER	1.06.20		
		P 9	001	
				DEC 96

AA

CABIN ATTENDANT PANEL

R0FA-01-06-20-009-A001AA

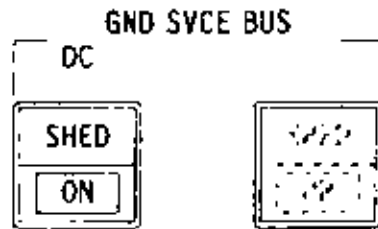

DC SVCE BUS pb

Controls the supply of the DC SVCE BUS.

Note : – Without GPU (DC BUS 1 supplying)

DC SVCE BUS will be supplied if both the cockpit DC SVCE and UTLY BUS and the cabin attendant panel DC SVCE BUS are selected. As soon as one of the two pb is selected OFF, the bus is isolated.

– With GPU (direct supplying).

DC SVCE BUS is directly supplied provided Cabin attendant panel pb is ON. If the DC SVCE BUS cabin attendant panel pb is on SHED position, cargo door opening, internal lighting and refuelling panel are not supplied.

ON (pb pressed in) The light illuminates blue whenever a power source is available on the aircraft.

OFF (pb released) The DC SVCE BUS is disconnected from the available power source. The ON light extinguishes.

SHED Illuminates amber when :

– DC source is available and the pb is released, or the pb is pressed in and an overload shed occurs.

	ELECTRICAL SYSTEM	1.06.20		
		DC POWER	P 10	001
				DEC 96

20.3 ELECTRICAL SUPPLY/MFC LOGIC/SYSTEM MONITORING

ELECTRICAL SUPPLY

EQUIPMENT	DC BUS SUPPLY (C / B)	AC BUS SUPPLY (C / B)
Generator Control Unit 1	DC EMER BUS (on lateral panel GCU DC GEN 1)	- Nil -
Generator Control Unit 2	DC ESS BUS (on lateral panel GCU DC GEN 2)	- Nil -
Bus Power Control Unit	DC EMER BUS (on lateral panel BPCU DC)	- Nil -
Main Battery CHG CTL	DC ESS BUS (on lateral panel CHG CTL and CAUTION)	- Nil -
Emer Battery CHG CTL	DC EMER BUS (on lateral panel CHG CTL and CAUTION)	- Nil -
Ess BUS and INV1 on main Bat ind (arrow)	DC ESS BUS (on lateral panel IND)	- Nil -
Emer Bus on Bat ind (arrow)	HOT EMER BAT BUS (on lateral panel or EMER BAT BUS IND)	- Nil -
Emer Bat Voltage ind	HOT EMER BAT BUS (on lateral panel VIND)	- Nil -
DC BUS 1 OFF caution light	DC EMER BUS (on lateral panel DC BUS 1 OFF CAUT. LT)	- Nil -
DC BUS 2 OFF caution light	DC EMER BUS (on lateral panel DC BUS 2OFF CAUT LT)	- Nil -
Main Bat Voltage ind	HOT MAIN BAT BUS (on lateral panel VIND)	- Nil -
DC STBY BUS undervoltage and OVRD ind	DC EMER BUS (on lateral panel UNDV and OVRD IND)	
DC STBY BUS control	DC EMER BUS (on lateral panel OVRD CTL)	- Nil -
Ground Handling bus on Bat XF relay	HOT MAIN BAT BUS (on lateral panel RLY)	- Nil -

	ELECTRICAL SYSTEM DC POWER	1.06.20		
		P 11	050	
				DEC 96

AA

MFC LOGIC

See chapter 1.01.

SYSTEM MONITORING

The following conditions are monitored by visual and aural alerts :

- One DC generation channel inoperative.
 - See DC GEN FAULT procedure in chapter 2.05.04
- DC BUS 1 not supplied
 - See DC BUS 1 OFF procedure in chapter 2.05.04
- DC BUS 2 not supplied
 - See DC BUS 2 OFF procedure in chapter 2.05.04
- Incipient battery thermal runaway or charge contactor failure.
 - See CHG FAULT procedure in chapter 2.05.04
- DC EMER BUS no longer supplied.
 - See DC EMER BUS OFF procedure in chapter 2.05.04
- Battery (ies) discharge in flight (but DC main sources available).
 - SEE BATTERY (IES) DISCHARGE IN FLIGHT in chapter 2.05.04.
- One UTLY BUS automatically shed after a source overload
 - See SVCE and UTLY BUS SHED procedure in chapter 2.05.04

	ELECTRICAL SYSTEM DC POWER	1.06.20		
		P 12	001	
				DEC 96

20.4 LATERAL MAINTENANCE PANEL

On LH maintenance panel, a rotary selector is provided, with several indicators. These devices are to be used for maintenance purpose only. Maintenance panel is covered with a transparent cover, to avoid in flight operation.

CURRENT CHECK

ROFA-01-06-20-012-A001AA

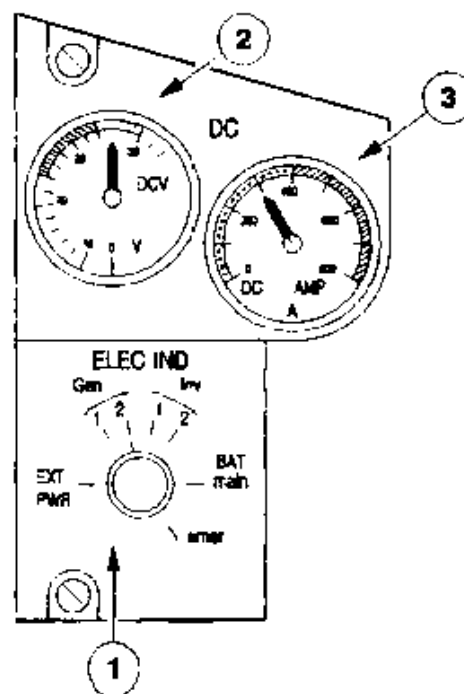
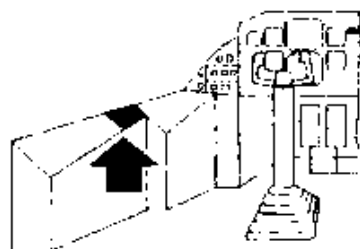

① Rotary Selector

Allows to connect selected pick-up points of the electrical network to the indicators.

"GEN" position selects DC generator on DC indicators.

② DC voltage indicator

Indicates the voltage at pick up point selected by the rotary selector.

Normal reading is :

- For battery without load : 25 to 28 volts.

- For battery under load : 23 to 28 volts.

③ DC Current indicator

Indicates the current generated by selected sources.

Normal reading is for each generator : less than 300 A.

	ELECTRICAL SYSTEM DC POWER	1.06.20	
		P 13/14	001
		DEC 96	

AA

DC UTLY/SVCE/STBY CONTACTORS MALFUNCTION INDICATION AND DC FEEDERS OVHT DETECTORS

80FA-01-06-20-0:3-A001AA

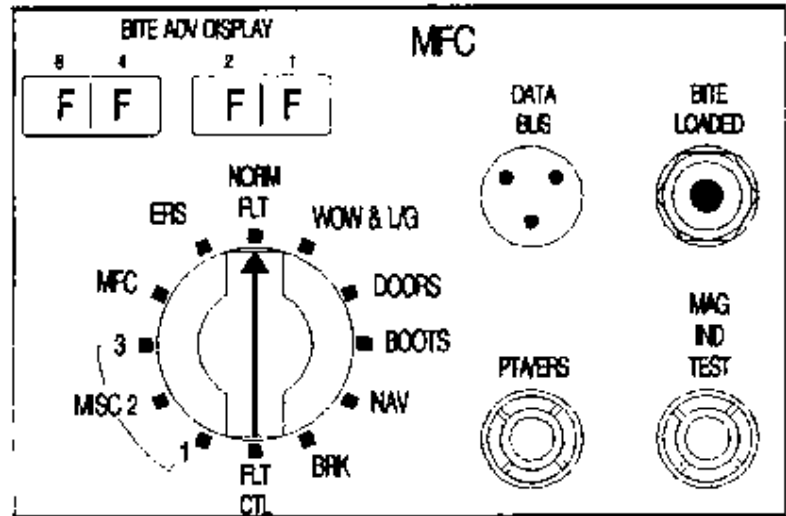
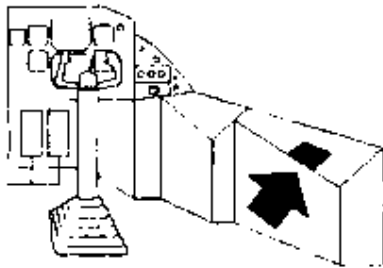

ELECTRICAL MALFUNCTIONS ARE INDICATED BY MFC AS FOLLOWS :

- ROTARY SELECTOR ON MISC 1 POSITION :
 - 3rd press on PTA/ERS pb and DOFF displayed :
DC FEEDER 1 affected by discontinuity or overheat.
 - 4th press on PTA/ERS pb and OFOO displayed :
DC FEEDER 2 affected by discontinuity or overheat.
 - 5th press on PTA/ERS pb and OFOF displayed :
DC SVCE/UTLY contactor failure
- ROTARY SELECTOR ON MISC 2 POSITION :
 - 1st press on PTA/ERS pb and OOOF displayed :
DC STBY contactor failure.

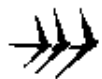

NR72
F.M.

ELECTRICAL SYSTEM

DC POWER

1.06.20

P 15/16

220

JUN 97

EXTERNAL POWER MODE

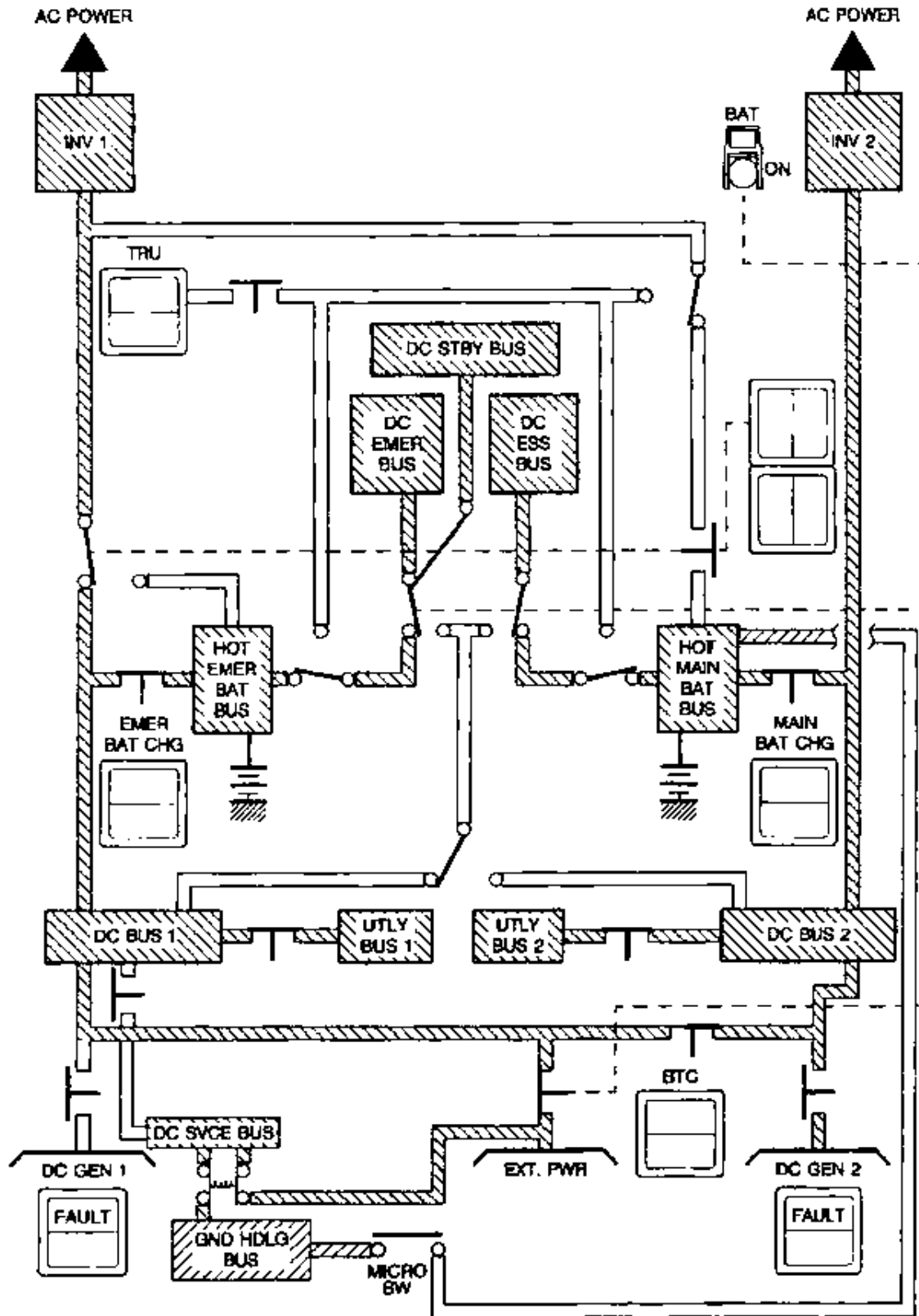

ROFA-01-06-20-03E-4220AA

HOTEL MODE

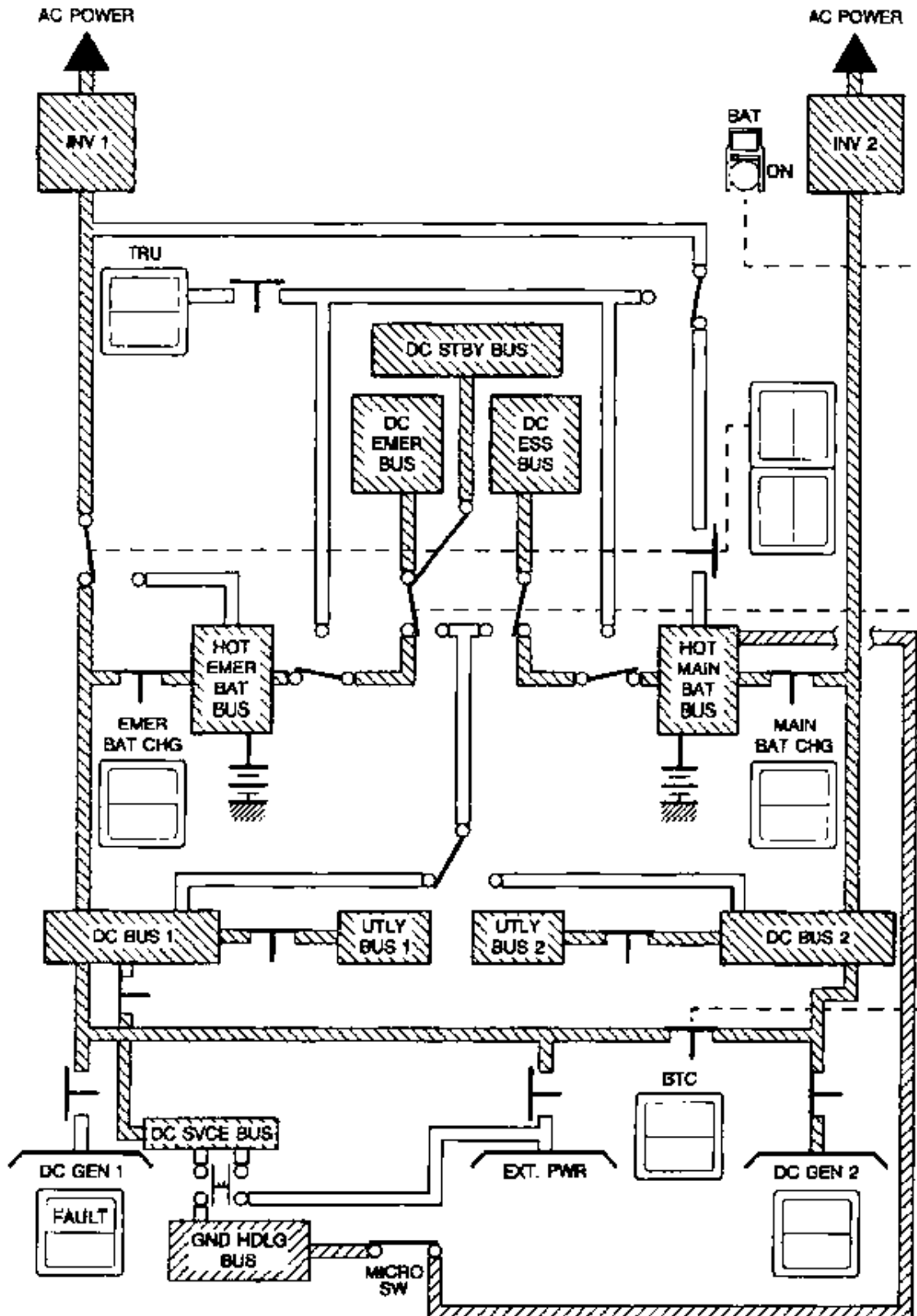

ROFA-01-06-20-017-A220AA

NORMAL SUPPLY

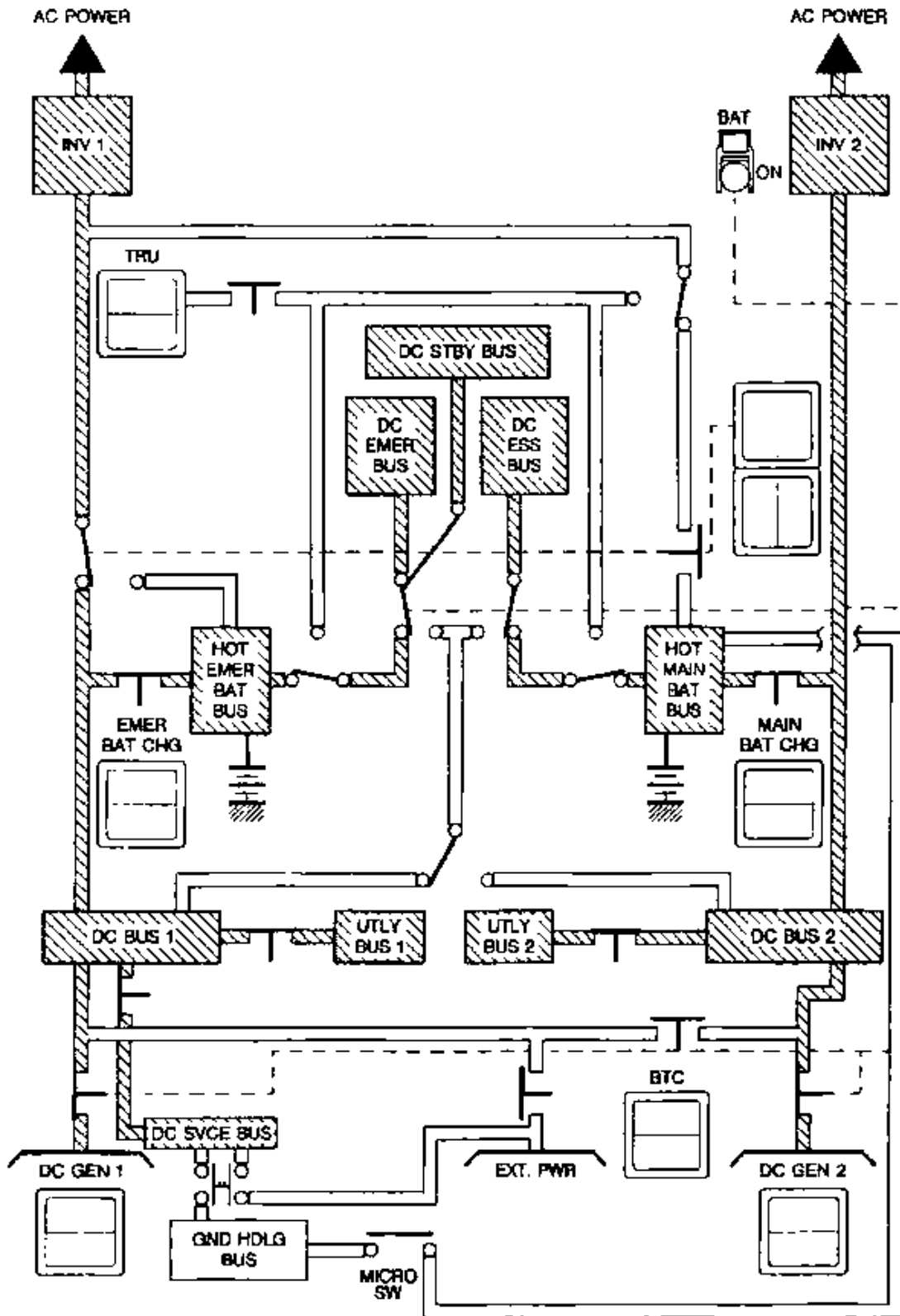

GEN 1 FAILED

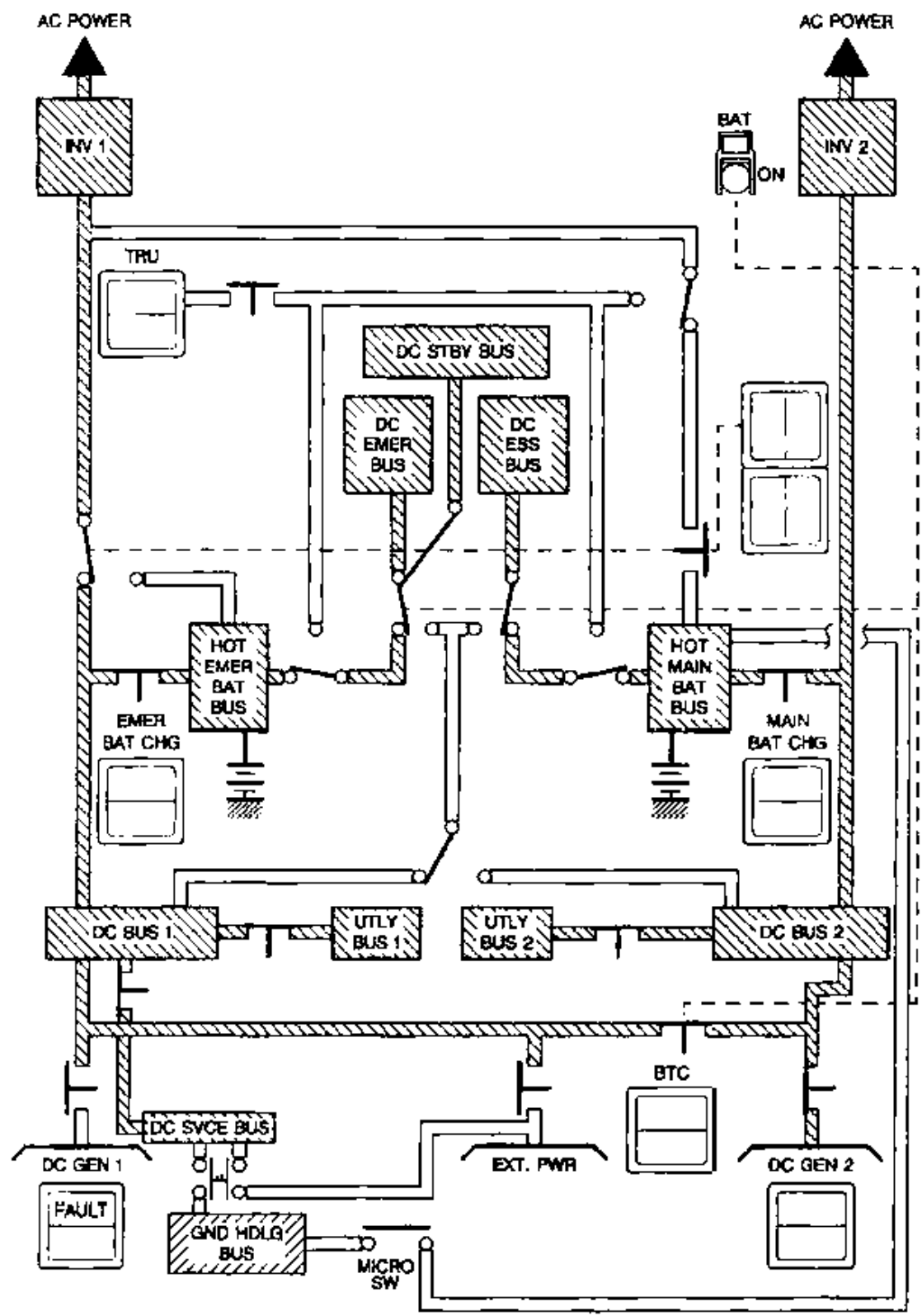

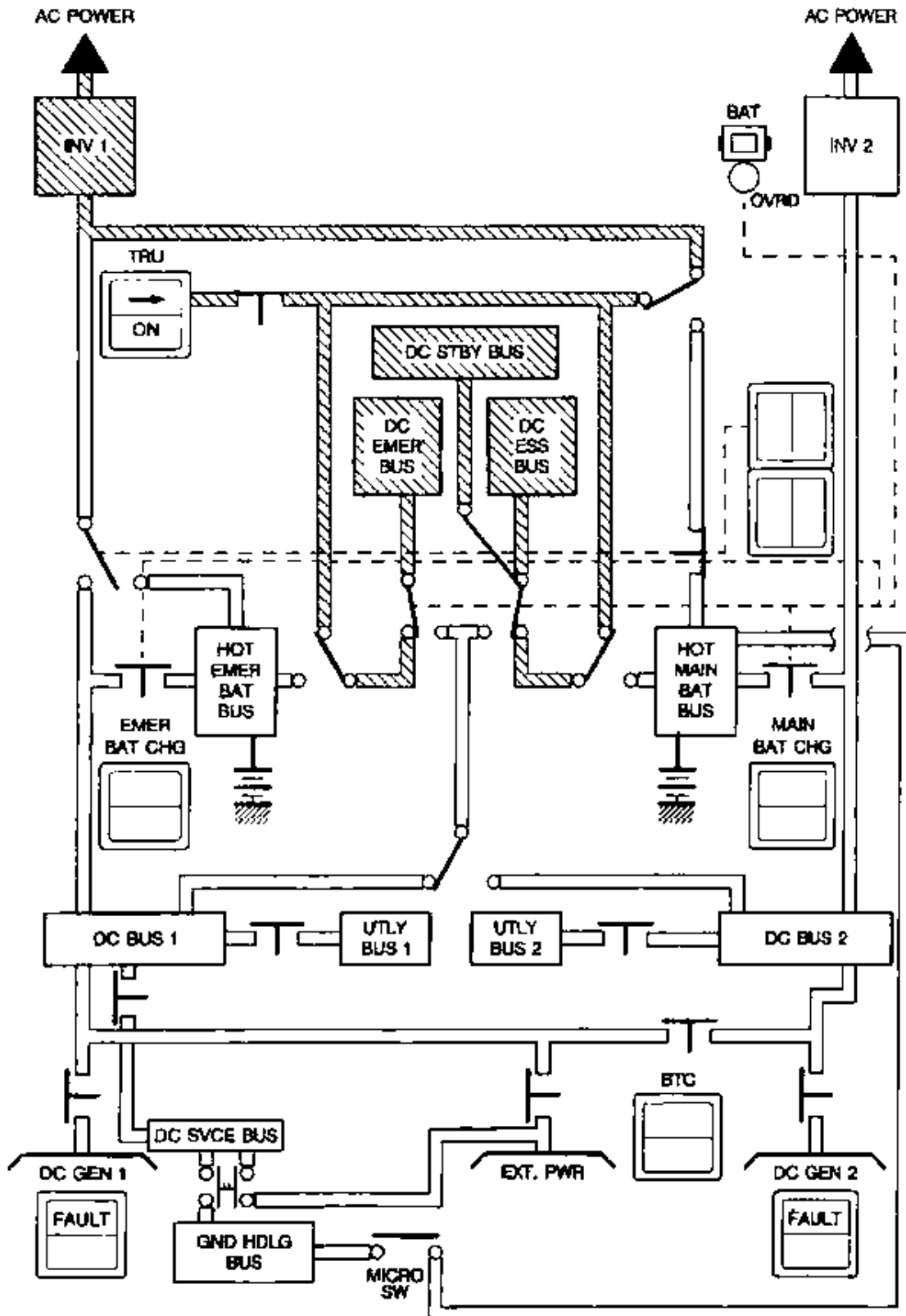

ROFA-01-06-20-021-A220AA

EMERGENCY SUPPLY

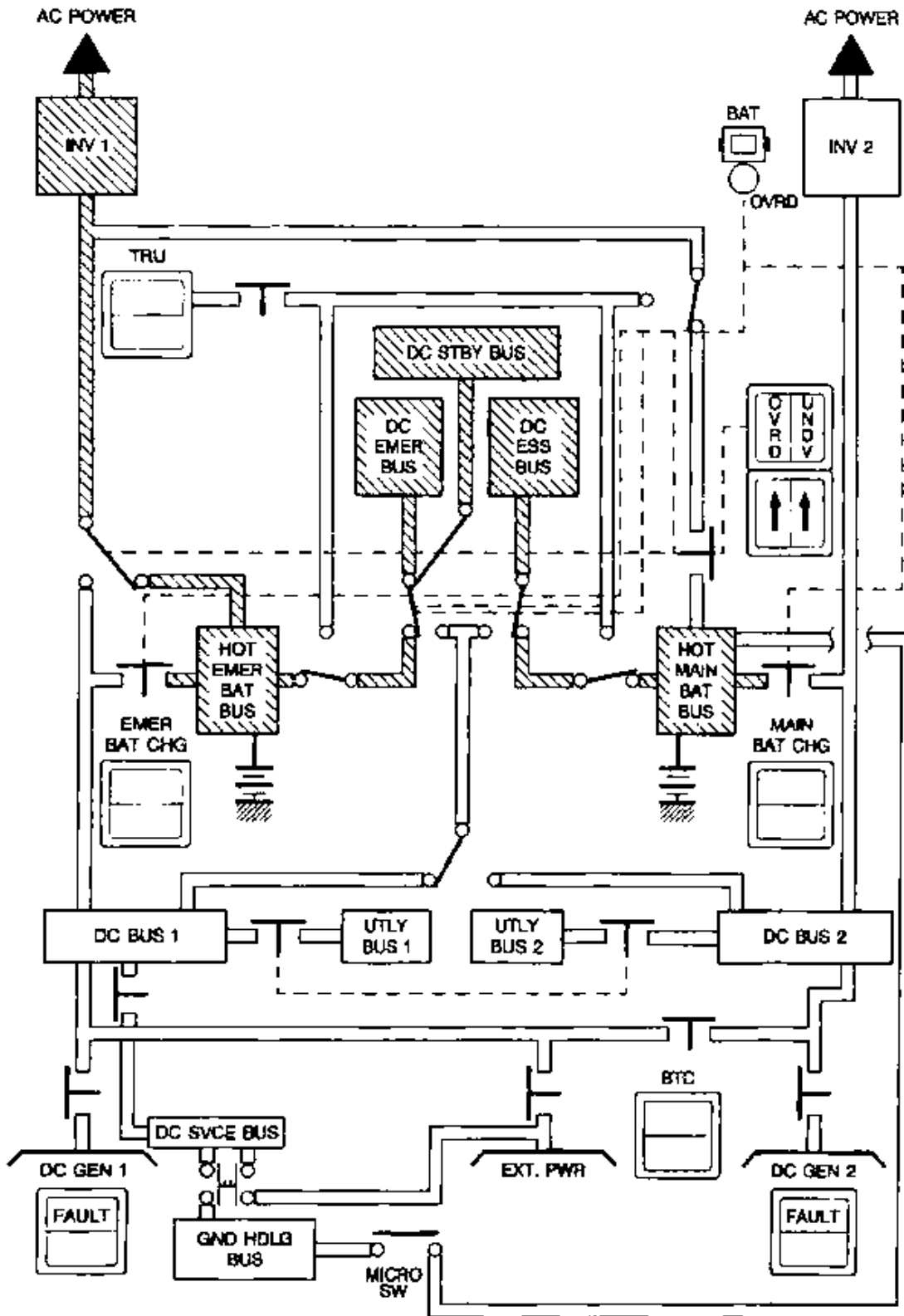

EMERGENCY SUPPLY + PB OVERRIDE (WITHOUT TRU)



	ELECTRICAL SYSTEM	1.06.30	
		P 1	020
	AC CONSTANT FREQUENCY		JUL 99

AA

30.1 DESCRIPTION

GENERATION

The source of constant frequency (400 Hz) AC power consists of two static inverters (INV).

The inverters are rack mounted and cooled by forced air with provisions for natural convection cooling.

The static inverter design characteristics are as follows :

- Power 500 VA
- Output voltage 115 V ± 4V and 26 V ± 1V
- Frequency 400 Hz ± 5 Hz
- Type single phase

The two inverters are powered respectively from DC BUS 1 and DC BUS 2. The input voltage range is between 18 VDC and 31 VDC for satisfactory operation.

In event of both DC BUS loss, corresponding inverter is not supplied, but corresponding AC BUS is supplied by AC BTR (BTC pb).

In event of both DC BUS power loss, INV 1 is automatically supplied by HOT MAIN BAT BUS, or by HOT EMER BAT BUS in OVRD configuration or by TRU when selected ON.

The maximum power available on each 26 VAC BUS is 250VA.

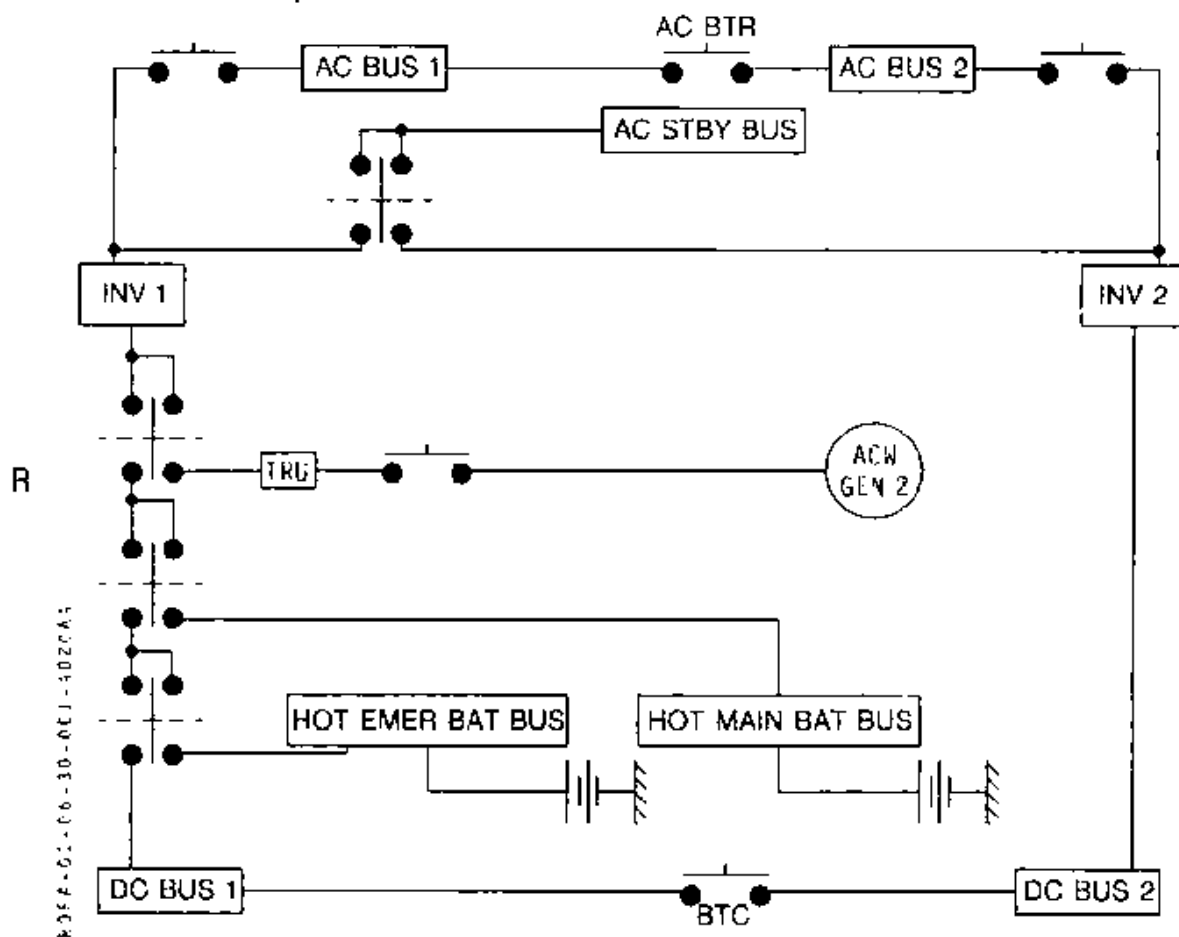

Note : Two AC electrical networks are supplied by the inverters :
115 VAC and 26 VAC. Only one is shown on the schematic.

	ELECTRICAL SYSTEM AC CONSTANT FREQUENCY	1.06.30		
		P 2	001	
				DEC 96

AA

DISTRIBUTION (115 and 26 V)

INV 1 normally supplies :

- AC BUS 1
- AC STBY BUS 1

INV 2 normally supplies :

- AC BUS 2

In event of inverter failure or input power loss the associated AC BUS is isolated from affected inverter and, provided the BTC pb is not in ISOL position. The AC BUS 1 and 2 are automatically tied together.

In event of INV 1 failure or input power loss, AC STBY BUS is automatically supplied from INV 2.

	ELECTRICAL SYSTEM		1.06.30	
	AC CONSTANT FREQUENCY		P 3	001
			DEC 96	

30.2 CONTROLS

PROFA-D1-06-30-003-A001AA

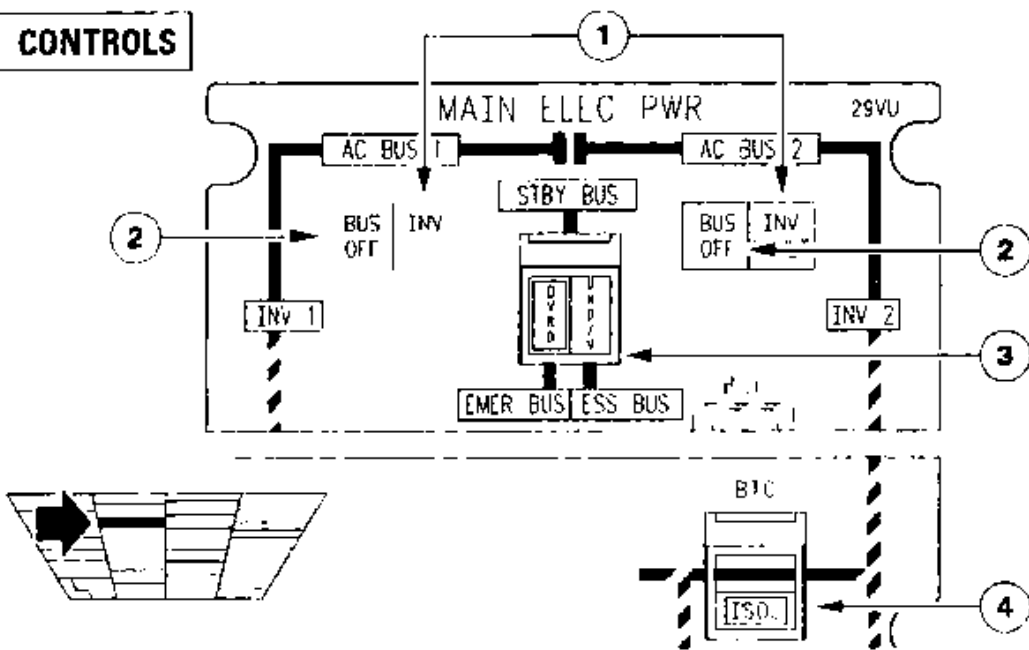

- ① **INV FAULT light**
 Illuminates amber and the CCAS is activated when an under/over voltage is detected at the output of the associated inverter.
 This may be caused by an inverter failure or a power supply loss.
- ② **BUS OFF light**
 Illuminates amber and the CCAS is activated when associated AC BUS is deenergized.
- ③ **OVRD pb**
 When on batteries supply, this guarded pb allows the INV 1 and hence the AC STBY BUS to be transfered from HOT MAIN BAT BUS supply to HOT EMER BAT BUS supply.
 NORM (pb released) The INV 1 and AC STBY BUS are supplied from the same source as DC ESS BUS.
 OVRD (pb pressed in) The INV 1 and AC STBY BUS are supplied from the same source as DC EMER BUS. OVRD light illuminates white.
 UNDV The It illuminates amber to indicate that the DC STBY BUS voltage is lower than 19.5 V. INV 1 requires 18 V for normal operation. OVRD may be used as necessary.
- ④ **BTC pb**
 This guarded pb controls the AC BUS TIE relay (AC BTR) which, when closed, connects both main AC BUSSES.
 NORM (pb released). The BPCU automatically controls the BTC and a separate logic controls the AC BTR.
 * In normal conditions, with both inverters running, the AC BTR is open allowing isolated operation of both inverter circuits.
 * In case of inverter failure, the AC BTR is automatically closed. The INV FAULT light illuminates but associated BUS OFF It remains extinguished.
 ISOL (pb pressed in) The AC BTR is open. ISOL light illuminates white.

	ELECTRICAL SYSTEM	1.06.30	
		P 4	001
	AC CONSTANT FREQUENCY	DEC 96	

30.3 ELECTRICAL SUPPLY/MFC LOGIC/SYSTEM MONITORING

ELECTRICAL SUPPLY

EQUIPMENT	DC BUS SUPPLY (C/B)	AC BUS SUPPLY (C/B)
INV 1 + AC BUS 1 AC voltage and frequency ind.	- Nil -	115 VAC EMER BUS (on lateral panel FREQ IND.)
AC BUS 1 power supply 115 VAC	- Nil -	115 VAC OUTPUT INV 1 (on lateral panel 115 VAC)
AC BUS 1 power supply 26 VAC	- Nil -	26 VAC OUTPUT INV 1 (on lateral panel 26 VAC)
AC BUS 1 control and INV 1 caution	DC EMER BUS (on lateral panel INV CAUTION and BUS SPLY RLY)	
AC BUS 1 caution relay	- Nil -	115 VAC BUS 1 (on lateral panel RLY)
AC BUS 1 caution light	DC EMER BUS (on lateral panel LT)	- Nil -
INV 2 + AC BUS 2 ACV and frequency ind.	- Nil -	115 VAC BUS 2 (on lateral panel FREQ IND)
AC BUS 2 power supply 115 VAC	- Nil -	115 VAC OUTPUT INV 2 (on lateral panel 115 VAC)
AC BUS 2 power supply 26 VAC	- Nil -	26 VAC OUTPUT INV 2 (on lateral panel 26 VAC)
AC BUS 2 control and INV 2 caution	DC ESS BUS (on lateral panel BUS CTL and INV CAUTION)	- Nil -
AC BUS 2 caution relay	- Nil -	115 VAC BUS 2 (on lateral panel RLY)
AC BUS 2 caution light	DC EMER BUS (on lateral panel LT)	- Nil -
AC BUS 1 and 2 tie line 115 VAC	- Nil -	115 VAC BUS 1 (on lateral panel 115 VAC)
AC BUS 1 and 2 tie line 26 VAC	- Nil -	26 VAC BUS 1 (on lateral panel 26 VAC)
AC STBY BUS power supply 115 VAC	- Nil -	OUTPUT INV 1 or 2 (on lateral panel 115 VAC)
AC STBY BUS power supply 26 VAC	- Nil -	OUTPUT INV 1 or 2 (on lateral panel 26 VAC)
AC STBY BUS transfer relay	DC EMER BUS (on lateral panel AC EMER and STBY BUS XFR RLY)	- Nil -

	ELECTRICAL SYSTEM AC CONSTANT FREQUENCY	1.06.30		
		P 5	001	
				DEC 96

AA

MFC LOGIC

See chapter 1.01.

SYSTEM MONITORING

The following conditions are monitored by visual and aural alerts :

- Under/over voltage at INV output
 - See INV FAULT procedure in chapter 2.05.04.
- AC BUS 1 not supplied (short circuit protection)
 - See AC BUS 1 OFF procedure in chapter 2.05.04.
- AC BUS 2 not supplied (short circuit protection)
 - See AC BUS 2 OFF procedure in chapter 2.05.04.

	ELECTRICAL SYSTEM AC CONSTANT FREQUENCY	1.06.30		
		P 6	001	
				DEC 96

30.4 LATERAL MAINTENANCE PANEL

On LH maintenance panel, a rotary selector is provided, with several indicators. These devices are to be used for maintenance purpose only. Maintenance panel is covered with a transparent cover, to avoid in flight operation.

CURRENT CHECK

ROYA-01-06-30-006-A001AA

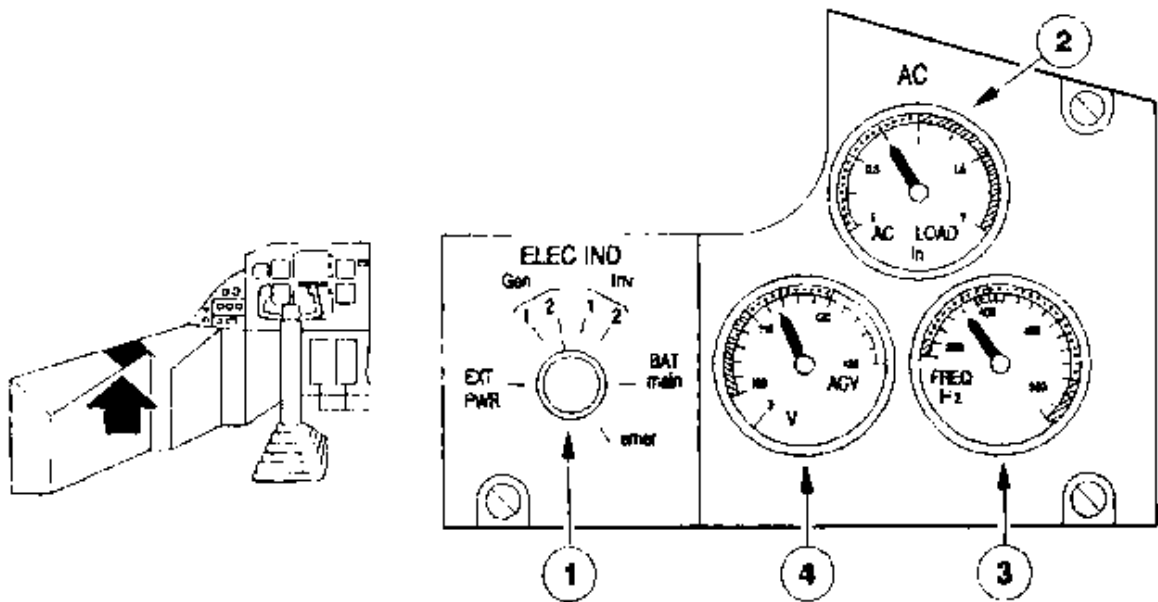

① Rotary Selector

Allows to connect selected pick-up points of the electrical network to the indicators.

"INV" position selects AC current on AC indicators.

② AC load indicator

Indicates in hundred percent the load of selected AC source.

Normal reading : below 0.5.

③ Frequency indicator

Indicates in Hz frequency of selected AC source.

Normal reading : 400 Hz \pm 5 Hz.

④ AC voltage indicator

Indicates voltage on selected AC source.

Normal reading : 115 V \pm 4 V.

	ELECTRICAL SYSTEM	1.06.40		
		P 1	050	
	AC WILD FREQUENCY			DEC 96

40.1 DESCRIPTION

GENERATION

The ACW generation system consists of two "propeller" driven 3 phases generators. Each generator is a brushless, air cooled type and is rated to deliver 20 KVA for continuous operation.

Nominal set voltage 115 V/200 V.

Normal operating frequency range : 341 to 488 Hz (70 to 100% NP)

Each generator is controlled by a Generator Control Unit (GCU) which provides the following control and protection functions :

- overvoltage
- power and fault current limiting
- bus tie lock out
- undervoltage
- differential protection
- under frequency
- open phase
- overfrequency
- voltage regulation.

The BPCU performs the functions required for control and protection of the EXT PWR, the BUS TIES (or BTC(S)) and SVCE BUS.

The TRU allows the ACW generation system to partially energize the DC electrical system from ACW BUS 2.

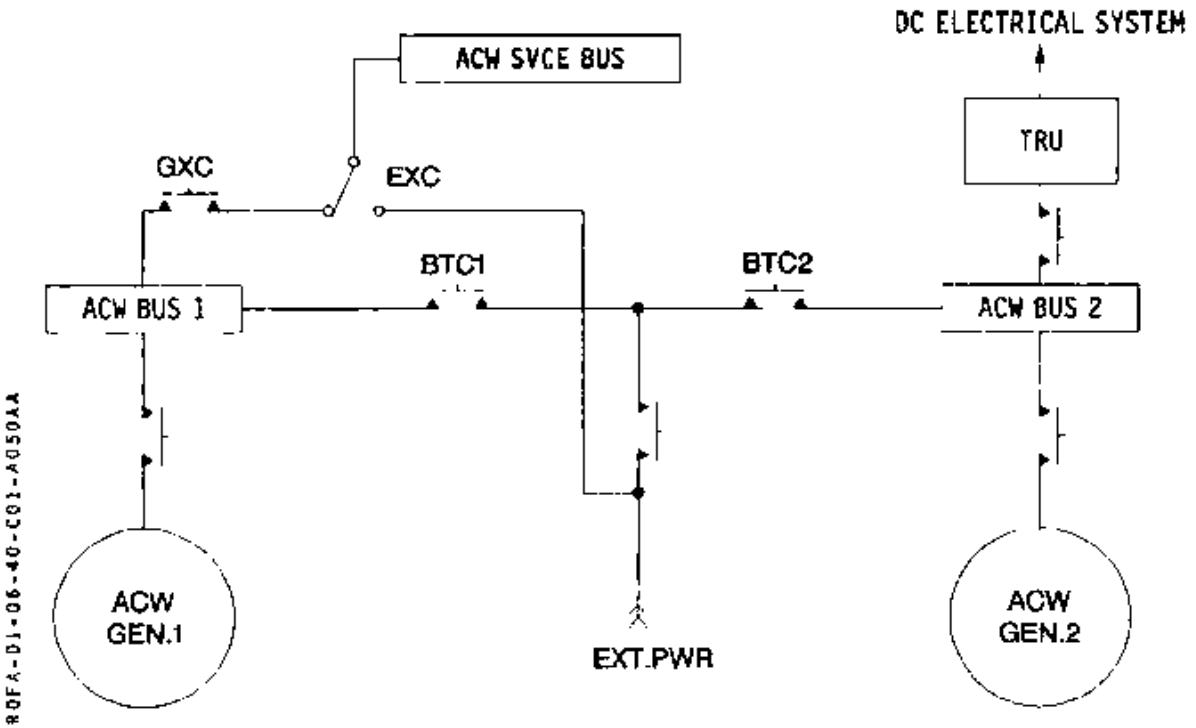

R0FA-D1-06-40-C01-A050AA

	ELECTRICAL SYSTEM AC WILD FREQUENCY	1.06.40		
		P 2	001	
				DEC 96

DISTRIBUTION

The aircraft ACW distribution network consists of three busses :

- Two main busses ACW BUS 1 and 2.
- ACW SVCE BUS.

ACW BUS 1 and 2

The ACW BUS 1 is normally supplied by the generator driven by the LH generator and the ACW BUS 2 by the RH generator.

Note : * In case of generator failure, the associated ACW BUS will be automatically supplied by the other generator through the BUS TIE CONTACTORS (1 and 2).

- * As soon as EXT PWR is connected, selected ON and checked "acceptable" in voltage, frequency, phase, and current by the BPCU, it has priority over the engine driven generators.

ACW SVCE BUS

The ACW SVCE BUS supplies power inflight, and on ground during airplane servicing operations. The ACW SVCE BUS can be supplied from EXT PWR or ACW BUS 1. A sw located on the cabin attendant panel controls the power to ACW SVCE BUS.

- * When the ACW BUS 1 is ON, power being supplied by the generator or EXT PWR through BTC 1, the ACW SVCE BUS is automatically fed from ACW BUS 1 through contactor GXC.
- * When the aircraft is operating from EXT PWR with ACW BUS 1 OFF, the ACW SVCE BUS is fed from EXT PWR through contactor EXC.

Note : The ACW SVCE BUS is automatically shed when one generator is off line.

	ELECTRICAL SYSTEM	1.06.40		
		P 3	080	
	AC WILD FREQUENCY			DEC 96

40.2 CONTROLS

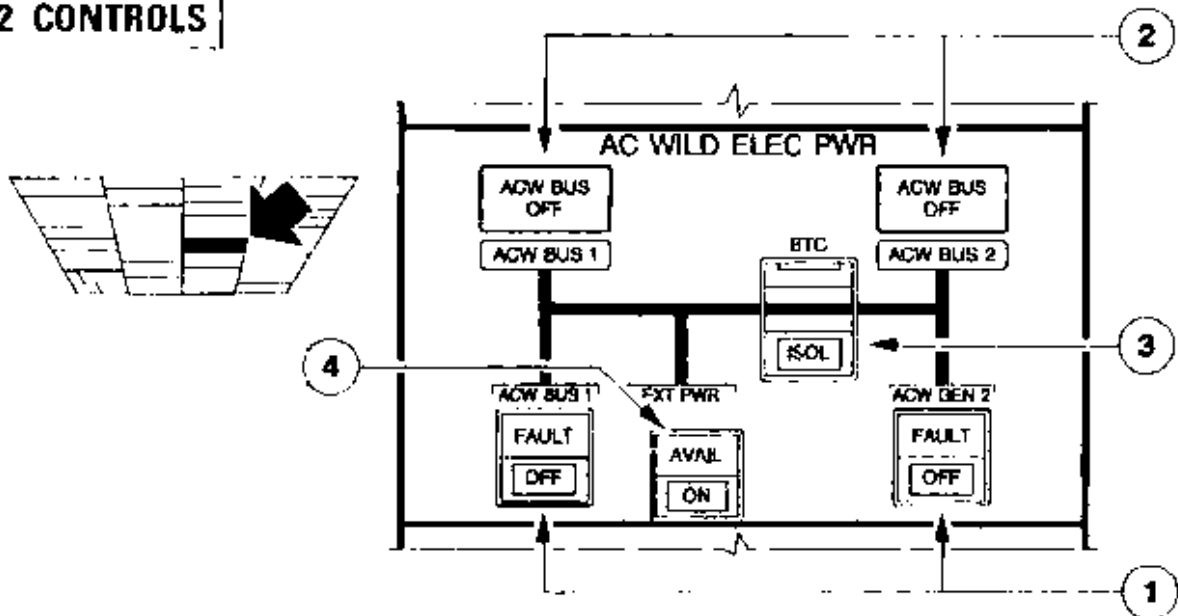

R0FA-01-06-40-003-AC80AB

① ACW GEN pb

Controls the energization of associated generator and the resetting of the protection system after failure.

ON (pb pressed in) Associated generator is energized and associated generator contactor closes if the network electrical parameters are normal.

OFF (pb released) Associated generator is deenergized and associated generator contactor is open. OFF light illuminates white.

FAULT Illuminates amber and the CCAS is activated in event of :

- A protection trip initiated by the associated GCU. If it is caused by a NP overspeed for less than 3 seconds or a generator underspeed, reset will be automatic. For the other cases, a manual reset has to be performed.
- An opening of a generator contactor except if pb is selected OFF.

In both cases, the BTC is closed and affected ACW BUS is automatically supplied from the remaining generator. The light extinguishes and the fault circuit is reset when the pb is cycled to the out position.

② ACW BUS OFF light

Illuminates amber and the CCAS is activated when associated ACW BUS is not supplied.

	ELECTRICAL SYSTEM AC WILD FREQUENCY	1.06.40		
		P 4	001	
				DEC 96

③ BTC PB

This guarded PB controls the ACW BUS TIE CONTACTORS (BTC 1 and 2) which, when closed, connects both main ACW BUSSES in parallel.

NORM (PB released) BPCU Automatically controls BTC 1 and 2 :

- In normal conditions, with both generators running, BTC 1 and 2 are open, allowing individual operation of both generator circuits.
- In case of external power operation, or single generator failure, BTC 1 and 2 are automatically closed. The flow bar is illuminated.

ISOL (pb pressed in) BTC 1 and 2 are open, ISOL light illuminates white.

④ EXT PWR PB

Refer to EXTERNAL POWER section.

CABIN ATTENDANT PANEL

R07A-D1-06-40-004-ADD1AA

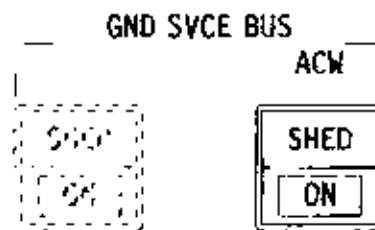

ACW SVCE BUS pb

Connects the ACW SVCE BUS to the EXT PWR source or to the ACW BUS 1 when it is energized.

ON (pb pressed in) Whenever ACW power or external AC power of acceptable quality is available, the light illuminates blue.

OFF (pb released) The SVCE BUS is disconnected from the available power source. The ON light extinguishes.

SHED illuminates amber when :

- the ACW source is available and the PB is released, or
- the PB is pressed in and an overload shed occurs.

	ELECTRICAL SYSTEM	1.06.40		
		P 5	001	
	AC WILD FREQUENCY			DEC 96

40.3 ELECTRICAL SUPPLY/SYSTEM MONITORING

ELECTRICAL SUPPLY

EQUIPMENT	DC BUS SUPPLY (C/B)	AC BUS SUPPLY (C/B)
GPU of ACW GEN 1	DC ESS BUS (on lateral panel GPU ACW GEN 1)	- Nil -
GPU of ACW GEN 2	DC ESS BUS (on lateral panel GPU ACW GEN 2)	- Nil -
ACW BPCU	DC ESS BUS (on lateral panel BPCU ACW)	- Nil -
ACW BUS 1 caution relay	Nil	ACW BUS 1 (on lateral panel RLY)
ACW BUS 1 caution light	DC EMER BUS (on lateral panel LT)	- Nil -
ACW BUS 2 caution relay	- Nil -	ACW BUS 2 (on lateral panel RLY)
ACW BUS 2 caution light	DC EMER BUS (on lateral panel LT)	- Nil -
ACW SVCE BUS shed relay	- Nil -	ACW SVCE BUS (on lateral panel ACW SVCE BUS SHED CAUTION RLY)

SYSTEM MONITORING

The following conditions are monitored by visual and aural alerts :

- One ACW generator channel inoperative
 - See ACW GEN FAULT procedure in chapter 2.05.04.
- ACW BUS 1 not supplied (short circuit protection)
 - See ACW BUS 1 OFF procedure in chapter 2.05.04.
- ACW BUS 2 not supplied (short circuit protection)
 - See ACW BUS 2 OFF procedure in chapter 2.05.04.

	ELECTRICAL SYSTEM	1.06.40		
		P 6	001	
	AC WILD FREQUENCY			DEC 96

40.4 LATERAL MAINTENANCE PANEL

On LH maintenance panel, a rotary selector is provided, with several indicators. These devices are to be used for maintenance purpose only. Maintenance panel is covered with a transparent cover, to avoid in flight operation.

CURRENT CHECK

RCPA-01-06-40-006-A001AA

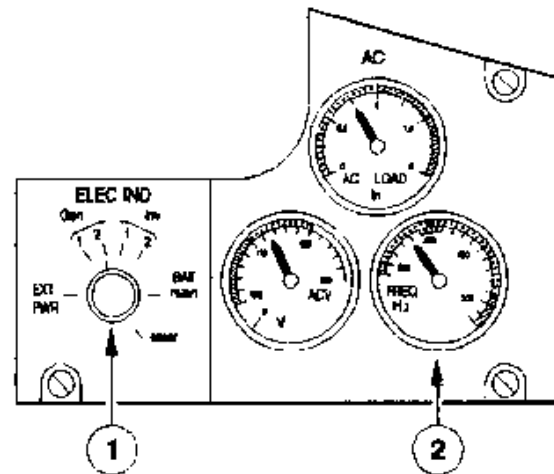
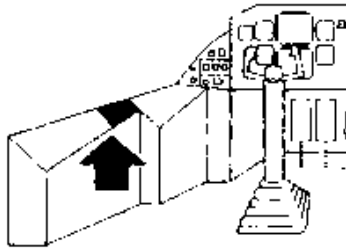

- ① Rotary Selector
Allows to connect selected pick-up points of the electrical network to the indicators.
"GEN" position selects AC WILD Generator on AC indicators.
- ② AC indicators
Refer to AC CONSTANT FREQUENCY lateral maintenance panel description.

ACW BUS TIE CONTACTORS OPERATING SELECTOR

RCPA-01-06-40-006-8001AA

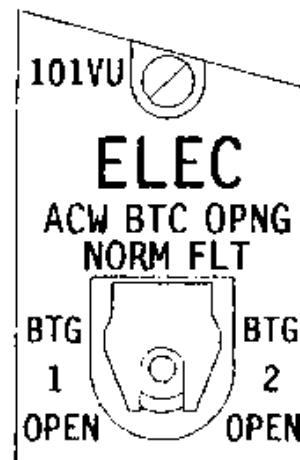
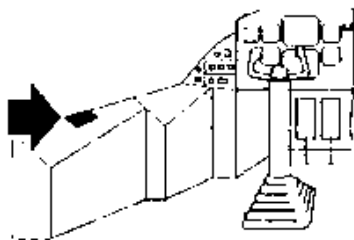

It is used to open the corresponding AC Wild bus tie contactor.

	ELECTRICAL SYSTEM		1.06.50	
	EXTERNAL POWER		P 1	001
			DEC 96	

50.1 DESCRIPTION

The DC and ACW electrical power system can be supplied from ground power sources, connected via the separate « External Power » receptacles which are located on the lower right side of the fuselage, just aft of the nose gear.

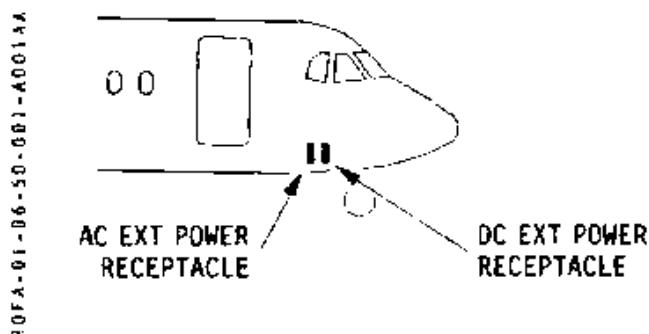

DC SUPPLY

- * The power is controlled via the BUS POWER CONTROL UNIT (BPCU) which provides protection for :
 - overvoltage
 - under voltage
 - overcurrent
 - incorrect polarity

When the above conditions are in the correct status, EXT PWR is considered to be of acceptable quality. AVAIL light illuminates green in the "DC" EXT PWR pb.

- * The AVAIL light being illuminated, the "DC" EXT PWR pb may be selected ON. The AVAIL light remains illuminated and the ON light illuminates blue.

Note : As soon as EXT PWR is connected, checked acceptable by the BPCU and selected ON, it has priority over the engine driven generators.

AC SUPPLY

- * The power is controlled via the BUS POWER CONTROL UNIT (BPCU) which provides protection for :
 - voltage limits
 - phase sequence
 - frequency limits
 - open phase
 - overload

When the above conditions are in the correct status, the EXT PWR is considered to be of acceptable quality. The AVAIL light illuminates green in the "ACW" EXT PWR pb and this pb may be selected ON if associated contactors are closed.

- ACW SVCE BUS pb on the cabin attendant panel may be selected ON :
 - AVAIL light remains illuminated
 - ON light illuminates blue

Note : As soon as EXT PWR is connected, checked acceptable by the BPCU and selected ON, it has priority over the "propeller" driven generators.

50.2 CONTROLS

AC EXTERNAL POWER RECEPTACLE PANEL

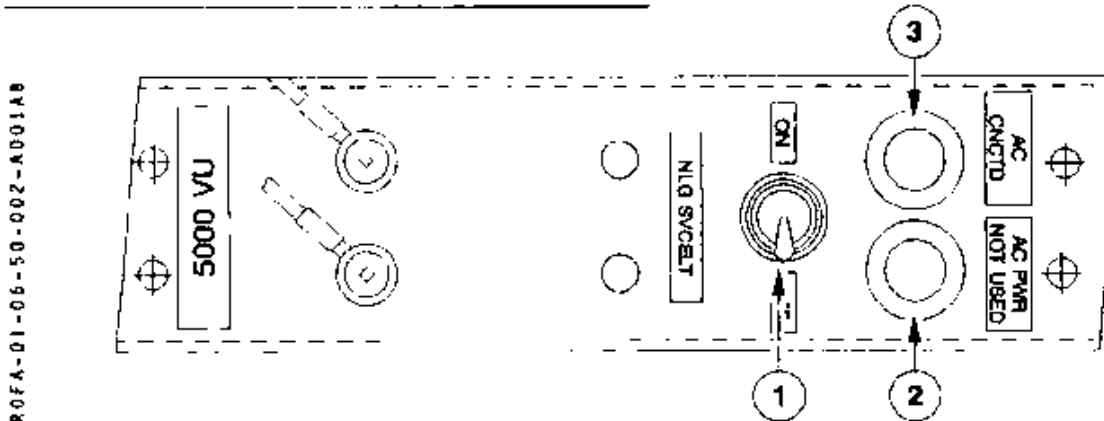

- ① Nose Landing Gear Service Light Switch
Allows operation of the service light in nose gear bay.
- ② "AC Power not used" light (white)
Is on when AC external power is connected and ACW SVCE BUS is not used.
- ③ "AC Connected" light (white)
Is on when AC external power is connected.

DC EXTERNAL POWER RECEPTACLE PANEL

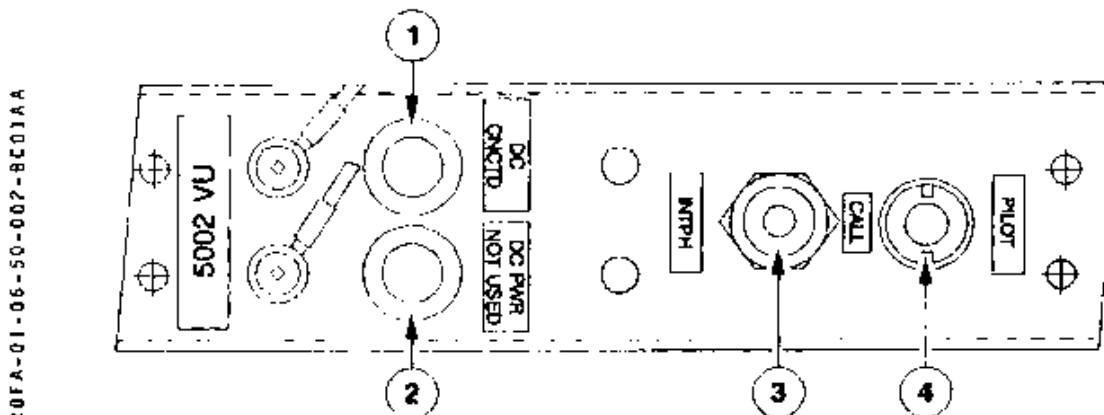

- ① "DC connected" light (white)
Is on when DC external power is connected to the aircraft.
- ② "DC Power not used" light (white)
Is on when DC external power is connected to the aircraft, and DC SVCE BUS is not used.
- ③ Interphone Jack
Used by ground mechanic to connect a headset to communicate with crew.
- ④ Pilot call button
When pressed in, sends a call (aural and visual) to the cockpit : "Mechanic call" light illuminates on the overhead panel.

	ELECTRICAL SYSTEM	1.06.50		
		P 3	001	
	EXTERNAL POWER			DEC 96

50.3 LATERAL MAINTENANCE PANEL

On LH maintenance panel, a rotary selector is provided, with several indicators. These devices are to be used for maintenance purpose only. Maintenance panel is covered with a transparent cover, to avoid in flight operation.

CURRENT CHECK

R0FA-01-06-50-003-A001NA

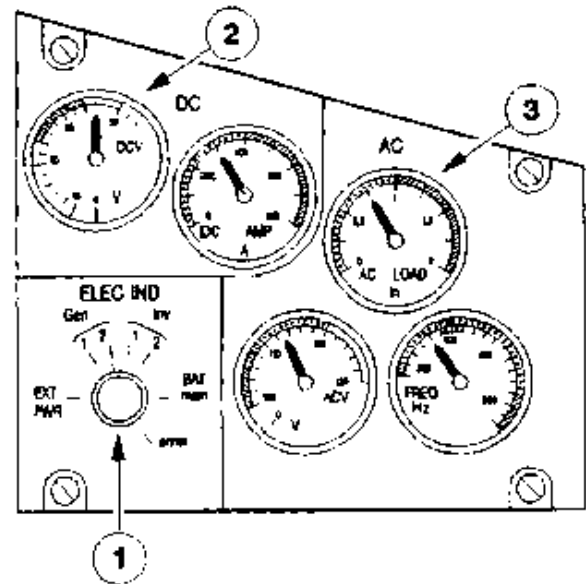
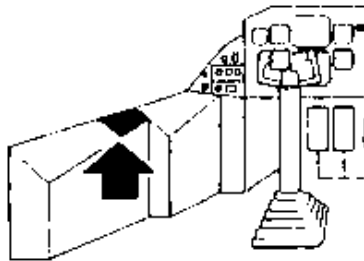

① Rotary Selector

Allows to connect selected pick-up points of the electrical network to the indicators.

"EXT PWR" position indicates on DC or/and AC indicators.

② DC indicators

Refer to DC power lateral maintenance panel description.

③ AC indicators

Refer to AC Constant frequency lateral maintenance panel description.

	ELECTRICAL SYSTEM		1.06.60	
	DISTRIBUTION EQUIPMENT LIST		P 1	070
			JUN 97	

AA *Note* : "*" = option

DC BUS 1

ATA	SYSTEM	FUNCTION
21	AIR CONDITIONING	<ul style="list-style-type: none"> - DUCT/COMPT Cockpit and cabin Temperature IND - Automatic Pressure CTL - TURBOFAN SOV 1 CTL - EXTRACT FAN PWR SPLY (Back-up of DC BUS 2)
23	COMMUNICATIONS	<ul style="list-style-type: none"> * - SEL CAL * - HF 1 when two HF are installed * - FLIGHT INTERPHONE and AUDIO CONTROL PANEL OBSV - HF FERRY
27	FLIGHT CONTROLS	<ul style="list-style-type: none"> - SPOILERS IND - STICK PUSHER PWR and CTL - LEFT STICK SHAKER
28	FUEL	<ul style="list-style-type: none"> - LP VALVE 1 (Normal) - TANK TEMP IND
30	ICE AND RAIN PROTECTION	<ul style="list-style-type: none"> - CAPT STATIC PORTS - STBY STATIC PORTS - LH SIDE WINDOW ANTI ICING - RH WINDSHIELD HTG IND
31	INDICATING/RECORDING	<ul style="list-style-type: none"> - MFC 1B (Primary)
33	LIGHTS	<ul style="list-style-type: none"> - GENERAL ILLUMINATION : LEFT LATERAL RAMP (1 FLUORESCENT LIGHT OUT OF 2) - CAPT LTS : DOME, CHARTHOLDER, CONSOLE, READING - F/O DOME (Normal) - STORM - F/O PANELS - NAVIGATION (Back-up of DC SVCE BUS) - ANNUNCIATOR LT TEST - BEACON (Back-up of DC SVCE BUS)



ATR 72
F.C.O.M.

ELECTRICAL SYSTEM

1.06.60

P 2

170

DISTRIBUTION EQUIPMENT LIST

JUN 97

AA

ATA	SYSTEM	FUNCTION
34	NAVIGATION	<ul style="list-style-type: none"> - WEATHER RADAR - RADIO ALTIMETER - GPWS - G/S IND - STBY ALTIMETER VIBRATOR - DME 1 - AHRS 2 (auxiliary) Back-up - DC BUS 2, IN FLIGHT (Primary) <li style="padding-left: 20px;">- DC EMER BUS, ON GROUND (Auxiliary)
36	PNEUMATIC	<ul style="list-style-type: none"> - BLEED LEAK IND - CROSS FEED VALVE and IND - HP VALVE 1
61	PROPELLERS	<ul style="list-style-type: none"> - OVSPD TEST ENG 1 - AFU 1 (Normal) - BALANCE TEST
73	ENGINE FUEL and CTL	<ul style="list-style-type: none"> - FUEL FLOW, FUEL USED IND 1 - FUEL TEMP IND 1 - FUEL CLOG IND 1 - EEC 1 - GROUND IDLE SOLENOID SPLY
79	OIL	<ul style="list-style-type: none"> - PRESS, TEMP IND 1

	ELECTRICAL SYSTEM		1.06.60	
	DISTRIBUTION EQUIPMENT LIST		P 3	170
				JUN 97

AA

DC BUS 2

ATA	SYSTEM	FUNCTION
21	AIR CONDITIONING	<ul style="list-style-type: none"> - Landing elevation IND - TURBOFAN SOV 2 CTL - EXTRACT FAN PWR SUPPLY (Primary)
23	COMMUNICATION	<ul style="list-style-type: none"> - VHF 2
26	FIRE PROTECTION	<ul style="list-style-type: none"> - NAC 1 (when installed) and 2 OVHT DET
27	FLIGHT CTL	<ul style="list-style-type: none"> - PITCH TRIM STBY COMMAND (Back-up of DC EMER BUS for NORMAL command) - RIGHT STICK SHAKER
28	FUEL	<ul style="list-style-type: none"> - LP VALVE 2 (Normal)
29	HYDRAULIC POWER	<ul style="list-style-type: none"> - DC AUX HYD PUMP NORM CTL, IND and PWR in flight
30	ICE and RAIN PROTECTION	<ul style="list-style-type: none"> - DE ICE VALVES - ENG 2 BOOTS A and B (Normal) - WINGS and EMPENNAGE BOOTS B (Normal) - F/O WIPER - F/O STATIC PORTS - F/O PROBES IND - LH WINDSHIELD HTG INDICATOR - RH SIDE WINDOW ANTI ICING
31	INDICATING/RECORDING	<ul style="list-style-type: none"> - F/O CLOCK - MFC 2B (Primary)
32	LANDING GEAR	<ul style="list-style-type: none"> - WOW 2 CTL - Secondary IND

	ELECTRICAL SYSTEM		1.06.60	
			P 4	070
	DISTRIBUTION EQUIPMENT LIST			JUN 97

AA

ATA	SYSTEM	FUNCTION
33	LIGHTS	<ul style="list-style-type: none"> - PASSENGER SIGNS - WING LIGHTS - F/O LTS : CHARTHOLDER, CONSOLE, READING - UTILITY SPOT and FLOOD - NORMAL INSTRUMENTS SPLY and LABELS INTEGRATED LT CTL - TAXI and TAKE OFF CTL - GENERAL ILLUMINATION : RIGHT LATERAL RAMP (1 FLUORESCENT LIGHT OUT OF 2)
34	NAVIGATION	<ul style="list-style-type: none"> * - ATC 2 * - DME 2 - VOR/ILS 2 * - ADF 2 - CAPT RMI - SGU 2 - F/O EADI - AHRS 1 (Auxiliary) (Back-up of DC EMER BUS) - AHRS 2 (Primary) - F/O EHSI
36	PNEUMATIC	<ul style="list-style-type: none"> - HP VALVE 2
52	DOORS	<ul style="list-style-type: none"> - ALERTS
61	PROPELLERS	<ul style="list-style-type: none"> - OVSPD TEST ENG 2 - AFU 2 (Normal)
73	ENGINE FUEL and CTL	<ul style="list-style-type: none"> - FUEL FLOW, FUEL USED IND 2 - FUEL TEMP IND 2 - FUEL CLOG IND 2 - EEC 2 (Normal) - IDLE GATE FAIL IND
79	OIL	<ul style="list-style-type: none"> - Press, Temp IND 2

 ATR 72 F.C.O.M.	ELECTRICAL SYSTEM	1.06.60		
	DISTRIBUTION EQUIPMENT LIST	P 5	070	
				JUN 97

AA

HOT EMER BAT BUS

ATA	SYSTEM	FUNCTION
24	ELECTRICAL POWER	<ul style="list-style-type: none"> - DC EMER BUS AND DC STBY BUS CT (BUSSES REMAIN SUPPLIED BY DC BUS 1) - EMER BAT AMMETER - EMER BAT VOLT IND - EMER BUS and INV 1 ON EMER BAT IND (ARROW) - TRU CTL and IND (when installed)
31	INDICATING/RECORDING	<ul style="list-style-type: none"> - MFC 1 MOD A (Auxiliary) (Back-up of DC ESS BUS)
34	NAVIGATION	<ul style="list-style-type: none"> - STBY HORIZON Back-up - ADC 1 (Back-up) - ADC 2 (Back-up)



ATR 72
F.C.O.M.

ELECTRICAL SYSTEM

1.06.60

P 6

250

DISTRIBUTION EQUIPMENT LIST

JUN 97

HOT MAIN BAT BUS

ATA	SYSTEM	FUNCTION
24	ELECTRICAL POWER	<ul style="list-style-type: none">- DC EXT PWR CONTACTOR CTL- MAIN BAT AMMETER- ESS BUS and INV 1 ON MAIN BAT IND (ARROW)- DC GND/HOL XFR BUS SPLY (Back-up of EXT PWR)- MAIN BAT VOLT IND- MAIN and EMER BAT CHGE INHIBIT- DC ESS BUS and INV 1 CTL (REMAIN SUPPLIED BY DC BUS 1)
26	FIRE DETECTION	<ul style="list-style-type: none">- ENG FIRE EXTINGUISHING CTL and IND (Back-up of DC EMER BUS)
29	HYDRAULIC POWER	<ul style="list-style-type: none">- DC AUX HYD PUMP GND SPLY, CTL and IND (Back-up of DC BUS 2)
31	INDICATING/RECORDING	<ul style="list-style-type: none">- MFC 2A (Auxiliary) (Back-up of DC EMER BUS)
61	PROPELLERS	<ul style="list-style-type: none">- A/F AUX PUMPS PWR

	ELECTRICAL SYSTEM		1.06.60	
	DISTRIBUTION EQUIPMENT LIST		P 7	390
			JUL 00	

DC EMER BUS

ATA	SYSTEM	FUNCTION
21	AIR CONDITIONING	<ul style="list-style-type: none"> - OVERBOARD and UNDERFLOOR VALVES CTL and IND and AIR COOLING HIGH FLOW IND - PRESSURE IND and EXCESS ALTITUDE IND - PNEUMATIC OUTFLOW VALVES
22	AUTO-FLIGHT	<ul style="list-style-type: none"> - AP/FD COMPUTER and GUIDANCE IND (when installed)
23	COMMUNICATIONS	<ul style="list-style-type: none"> - VHF - F/O COCKPIT AMPLIFIER - RCAU
24	ELECTRICAL POWER	<ul style="list-style-type: none"> - GCU 1 DC (Back-up) - AC BUS OFF 1 and 2 IND - ACW BUS OFF 1 and 2 IND - INV FAULT 1 IND - DC BUS OFF 1 and 2 IND - BPCU DC (Back-up) - DC STBY BUS IND (UNDV - OVRD) - EMER BAT : CHG IND - DC STBY BUS CTL (BUS REMAIN SUPPLIED BY DC BUS 1) - AC 1 BUSSES CTL (BUSSES REMAIN SUPPLIED BY INV 2)
26	FIRE DETECTION	<ul style="list-style-type: none"> - ENG FIRE EXTINGUISHING CTL and IND (Normal) - FIRE HANDLE IND ENG 1 and 2 - FIRE DETECTION ENG 1 and 2
27	FLIGHT CONTROLS	<ul style="list-style-type: none"> - PITCH TRIM NORMAL COMMAND - RUDDER TRIM - AILERON TRIM - AILERON LOCKING IND
28	FUEL	<ul style="list-style-type: none"> - LP VALVES 1 and 2 and IND (Back-up of DC BUS 1 - DC BUS 2)
29	HYDRAULIC POWER	<ul style="list-style-type: none"> - BLUE PUMP CTL and IND - GREEN PUMP IND
30	ICE and RAIN PROTECTION	<ul style="list-style-type: none"> - AAS IND and ALERTS - AAS CTL - WING, EMPENNAGE BOOTS A - ENG 1 BOOTS A and B - PROPELLERS 1 and 2 ANTI-ICING CTL and IND - WING, EMPENNAGE BOOTS B and ENG 2 BOOTS A and B (Back-up of DC BUS 2)

	ELECTRICAL SYSTEM		1.06.60	
	DISTRIBUTION EQUIPMENT LIST		P 8	570
				JUN 97

AA

ATA	SYSTEM	FUNCTION
31	INDICATING/RE-CORDING	<ul style="list-style-type: none"> - CAPT CLOCK - FDAU ON GROUND - MFC 1B (Auxiliary) (Back-up of DC BUS 1) - MFC 2A (Primary) - MFC 2B (Auxiliary) (Back-up of DC BUS 2)
32	LANDING GEAR	<ul style="list-style-type: none"> - ANTISKID OUTBOARD - NOSE WHEEL STEERING - WOW 1 CTL
33	LIGHTS	<ul style="list-style-type: none"> - CAPT PANELS - PYLON - STBY COMPASS - LAVATORY (EMERGENCY) - F/O DOME (Back-up of DC BUS 1)
34	NAVIGATION	<ul style="list-style-type: none"> - ATC 1 - AHRS 2 (ON GROUND, Auxiliary) (Back-up of IN FLIGHT : <ul style="list-style-type: none"> - DC BUS 2, Primary) - DC BUS 1, Auxiliary) - AHRS 1 (Primary) - ADC 1 (Primary) - ADC 2 (Primary)
61	PROPELLERS	<ul style="list-style-type: none"> - AFU 1 and 2 (Back-up of DC BUS 1 - DC BUS 2) - A/F AUX PUMPS CTL - TORQUE IND 1 and 2 - PEC 1 and PEC 2 (Normal), associated PVM and PIU.
73	ENGINE FUEL and CTL	<ul style="list-style-type: none"> - EEC 1 and 2 PWR and IND (Back-up of <ul style="list-style-type: none"> - DC BUS 1) - DC BUS 2)
76	ENGINE CTL	<ul style="list-style-type: none"> - CL FIRE IND 1 and 2

 A320 F.C.O.M.	ELECTRICAL SYSTEM		1.06.60	
	DISTRIBUTION EQUIPMENT LIST		P 9	350
				JUL 00

AA

DC ESS BUS

ATA	SYSTEM	FUNCTION
21	AIR CONDITIONING	<ul style="list-style-type: none"> - PACK 1 and RECIRC FAN 1 IND - PACK 1 VALVE - EXTRACT FAN CTL - PACK 2 and RECIRC FAN 2 IND - PACK 2 VALVE - LANDING ELEVATION IND (ALPHANUMERIC DISPLAY) - COCKPIT and CABIN AUTOMATIC and MANUAL TEMPERATURE CTL and IND
22	AUTOFLIGHT	<ul style="list-style-type: none"> - AP OFF IND - AP DISC BY QUICK DISCONNECT
23	COMMUNICATIONS	<ul style="list-style-type: none"> - FLIGHT INTERPHONE CAPT and F/O - AUDIO CONTROL PANELS CAPT and F/O - CAPT COCKPIT AMPLIFIER - PASSENGER ADDRESS - MECHANIC CALL - COCKPIT and CABIN CREW CALL - CVR
24	ELECTRICAL POWER	<ul style="list-style-type: none"> - GCU 2 DC (Back-up) - GCU 1 and 2 ACW (Back-up) - BPCU ACW (Back-up) - DC SVCE and UTLY BUSES 1 and 2 CTL - MAIN BAT CHG IND - INV 2 FAULT IND - AC 2 and STBY BUSES CTL (BUSES REMAIN SUPPLIED BY INV 1)
26	FIRE DETECTION	<ul style="list-style-type: none"> - TOILETS SMK DET - AVIONICS SMK DET - FWD and AFT COMPT SMK DET - AFT COMPT and TOILETS DET FANS CTL and IND - FWD COMPT DET FANS CTL and IND
27	FLIGHT CONTROLS	<ul style="list-style-type: none"> - CLUTCH REENGAGEMENT SYSTEM - AILERON LOCKING CTL
28	FUEL	<ul style="list-style-type: none"> - FQI and 2 - CROSS FEED VALVE - STARTING PUMP 1 and 2 and MOTIVE FLOW VALVES 1 and 2

	ELECTRICAL SYSTEM		1.06.60	
			P 10	160
	DISTRIBUTION EQUIPMENT LIST			JUN 97

ATA	SYSTEM	FUNCTION
29	HYDRAULIC POWER	- GREEN PUMP CTL
30	ICE and RAIN PROTECTION	- DE-ICING ISOLATION VALVES - LH and RH SIDE WINDOWS ANTI-ICING IND - CAPT and STBY and TAT PROBES IND - CAPT WIPER
31	INDICATING/RECORDING	- FDAU (In flight) - MFC 1A (Primary)
33	LIGHTS	- GENERAL ILLUMINATION : MIN CAB LT - RIGHT LATERAL RAMP (1 FLUORESCENT LIGHT OUT OF 2) (Back-up of DC SVCE BUS) - LEFT LANDING CTL - RIGHT LANDING CTL
34	NAVIGATION	- TAS TEMP IND (ALPHANUMERIC DISPLAY) - STBY HORIZON NORMAL (Back-up HOT EMER BAT BUS)
35	OXYGEN	- PRESSURE IND - PILOTS and PASSENGERS VALVES CTL (PILOTS VALVE REMAINS OPEN) * - PAX MASKS DROP CTL
36	PNEUMATIC	- BLEED VALVE 1 PWR and IND - BLEED VALVE 2 PWR and IND
61	PROPELLERS	- NP 1 IND - NP 2 IND - PROP BRAKE PWR, CTL and IND - PEC 1 and PEC 2 (Back-up of DC EMER BUS).
74	IGNITION	- ENG 1 - ENG 2
77	ENGINE IND	ITT IND 1 and 2 - NH/NL IND 1 and 2
80	STARTING	- ENG 1 - ENG 2

	ELECTRICAL SYSTEM	1.06.60		
	DISTRIBUTION EQUIPMENT LIST	P 11	070	
				JUN 97

AA

DC STBY BUS

ATA	SYSTEM	FUNCTION
22	AUTO FLIGHT	<ul style="list-style-type: none"> - AP/FD SERVOS - ADU
27	FLIGHT CONTROLS	<ul style="list-style-type: none"> - FLAPS CTL
29	HYDRAULIC POWER	<ul style="list-style-type: none"> - PRESS TRIPLE IND - INTERCONNECTING VALVE
32	LANDING GEAR	<ul style="list-style-type: none"> - PRIMARY IND - LANDING GEAR CTL (HYDRAULIC VALVE) - ANTISKID INOP and BRAKE OVTEMP IND - R and L INBOARD and OUTBOARD BRAKES TEMP XMITTERS
33	LIGHTS	<ul style="list-style-type: none"> - EMERGENCY
34	NAVIGATION	<ul style="list-style-type: none"> - VOR/ILS/MKR 1 - SGU 1 - CAPT EADI - RMI F/O - ADF 1 * - OMEGA - CAPT EHSI



ATR 72
F.C.O.M.

ELECTRICAL SYSTEM

1.06.60

P 12

050

DISTRIBUTION EQUIPMENT LIST

DEC 96

AA

DC SVCE BUS

ATA	SYSTEM	FUNCTION
24	ELECTRICAL POWER	* -- GALLEY
33	LIGHTS	<ul style="list-style-type: none"> - LOGO - FORWARD, AFT CARGO and MAINTENANCE COMPARTMENT - NAVIGATION (Normal) - LAVATORY (Normal) - GENERAL ILLUMINATION : <ul style="list-style-type: none"> . RIGHT LATERAL RAMP (1 FLUORESCENT LIGHT OUT OF 2) (Normal) . LEFT LATERAL RAMP (1 FLUORESCENT LIGHT OUT OF 2) * -- PASSENGERS READING CTL * -- GALLEY AREA - BEACON (Back-up of DC BUS 1) - WHEEL WELLS and AFT ELEC COMPT - DC SVCE PLUG
38	WATER/WASTE	- TOILET SYSTEM
61	PROPELLERS	- A/F AUX PUMPS MANUAL CTL (TEST ON GROUND)

	ELECTRICAL SYSTEM	1.06.60		
	DISTRIBUTION EQUIPMENT LIST	P 13	001	
				DEC 96

XX

DC UTLY BUS 1

ATA	SYSTEM	FUNCTION
21	AIR CONDITIONING	- RECIRC FAN 1 CTL
23	COMMUNICATIONS	* - TAPE PLAYER
33	LIGHTS	- CALL - GENERAL ILLUMINATION : LEFT CENTRAL RAMP

	ELECTRICAL SYSTEM DISTRIBUTION EQUIPMENT LIST	1.06.60		
		P 14	001	
				DEC 96

AA

DC UTLY BUS 2

ATA	SYSTEM	FUNCTION
21	AIR CONDITIONING	- RECIRC FAN 2 CTL
33	LIGHTS	- GENERAL ILLUMINATION : RIGHT CENTRAL RAMP

	ELECTRICAL SYSTEM	1.06.60		
	DISTRIBUTION EQUIPMENT LIST	P 15	200	
				JUN 97

DC GND HDLG BUS

ATA	SYSTEM	FUNCTION
28	FUEL	- FUELING CTL and IND
33	LIGHTS	- ENTRANCE
52	DOORS	- CARGO DOOR CTL and IND



ATR 72
F.C.O.M.

ELECTRICAL SYSTEM

1.06.60

P 16

001

DISTRIBUTION EQUIPMENT LIST

DEC 96

115V AC STBY BUS

ATA	SYSTEM	FUNCTION
26	FIRE DETECTION	- ALL SMOKE DET FANS PWR
30	ICE and RAIN PROTECTION	- PITOT STBY (Back-up of 115V ACW BUS 1)
31	INDICATING/RECORDING	- DFDR
33	LIGHTS	- EMER INSTRUMENTS SPLY INTEGRATED LT (Auxiliary) (Back-up of 115V ACW BUS 1)



ATR 72
F.C.O.M.

ELECTRICAL SYSTEM

1.06.60

P 17

001

DISTRIBUTION EQUIPMENT LIST

DEC 96

115V AC BUS 1

ATA	SYSTEM	FUNCTION
24	ELECTRICAL POWER	- INV 1 V and FREQ IND
31	INDICATING RECORDING	* - QAR
34	NAVIGATION	- WEATHER RADAR
36	PNEUMATIC	- BLEED LEAK DETECTOR

	ELECTRICAL SYSTEM	1.06.60		
	DISTRIBUTION EQUIPMENT LIST	P 18	001	
				DEC 96

AA

115V AC BUS 2

ATA	SYSTEM	FUNCTION
21	AIR CONDITIONING	- CABIN TEMPERATURE SENSOR FAN
24	ELECTRICAL POWER	- INV 2 V and FREQ IND
31	INDICATING/RECORDING	* - DAR
33	LIGHTS	- AC SVCE PLUG
34	NAVIGATION	- GPWS PWR

	ELECTRICAL SYSTEM	1.06.60		
	DISTRIBUTION EQUIPMENT LIST	P 19	001	
				DEC 96

26V AC STBY BUS

ATA	SYSTEM	FUNCTION
27	FLIGHT CONTROLS	- FLAPS POS DET and IND
31	INDICATING/RECORDING	- SURFACES POSITIONS CTL and FDAU SYNCHRO REF
34	NAVIGATION	<ul style="list-style-type: none"> - COURSE and HEADING 1 SELECT - SYNCHRO REF FOR : <ul style="list-style-type: none"> . BEARING FROM VOR 1 TO RMI and SGU 1 and 2 . BEARING FROM ADF 1 TO RMI and SGU 1 and 2 . HEADING FROM AHRS 1 TO RMI 2 - ALTI CAPT + ALTITUDE SYNCHRO REF FOR ADC 1 - ASI/VS1 CAPT + TAS TEMP IND * - SIGNALS REF <ul style="list-style-type: none"> . TAS FROM ADC1 TO OMEGA . HEADING FROM AHRS 1 TO OMEGA . STEERING COMMAND FROM OMEGA TO AFCS



ATR 72
F.C.O.M.

ELECTRICAL SYSTEM

DISTRIBUTION EQUIPMENT LIST

1.06.60

P 20

001

DEC 96

26V AC BUS 1

ATA	SYSTEM	FUNCTION
27	FLIGHT CONTROLS	- TRIMS IND
34	NAVIGATION	- INS 1 REF



AR72
F.C.O.M.

ELECTRICAL SYSTEM

1.06.60

P 21

001

DISTRIBUTION EQUIPMENT LIST

DEC 96

26V AC BUS 2

ATA	SYSTEM	FUNCTION
34	NAVIGATION	<ul style="list-style-type: none">- ASI/VS1 F/O- F/O ALTI - ALTITUDE SYNCHRO REF FOR ADC 2- SYNCHRO REF FOR :<ul style="list-style-type: none">. BEARING FROM VOR 2 TO RMI and SGU 1 and 2. BEARING FROM ADF 2 TO RMI and SGU 1 and 2. HEADING FROM AHRS 2 TO RMI 1- COURSE and HEADING 2 SELECT- INS 2 REF



ATR 72
F.C.O.M.

ELECTRICAL SYSTEM

DISTRIBUTION EQUIPMENT LIST

1.06.60

P 22

020

DEC 96

AA

115 ACW BUS 1

ATA	SYSTEM	FUNCTION
30	ICE and RAIN PROTECTION	<ul style="list-style-type: none">- CAPT PITOT- CAPT ALPHA- CAPT TAT- STBY PITOT (Normal)
33	LIGHTS	<ul style="list-style-type: none">- EMER INSTRUMENTS SPLY INTEGRATED LT (Primary)- NORMAL INSTRUMENTS SPLY and LABELS INTEGRATED LT PWR- LEFT LANDING PWR- LEFT and REAR STROBES* - PASSENGERS READING PWR (LEFT SIDE)

	ELECTRICAL SYSTEM	1.06.60		
	DISTRIBUTION EQUIPMENT LIST	P 23	001	
				DEC 96

AA

115 ACW BUS 2

ATA	SYSTEM	FUNCTION
30	ICE and RAIN PROTECTION	<ul style="list-style-type: none"> - F/O PITOT - F/O ALPHA - F/O TAT - ICE DETECTOR
33	LIGHTS	<ul style="list-style-type: none"> - TAXI and TAKE OFF PWR - RIGHT LANDING PWR - RIGHT STROBE * - PASSENGERS READING PWR (RIGHT SIDE)



ATR 72
F.C.O.M.

ELECTRICAL SYSTEM

1.06.60

P 24

001

DISTRIBUTION EQUIPMENT LIST

DEC 96

115 ACW SVCE BUS

ATA	SYSTEM	FUNCTION
24	ELECTRICAL POWER	* - GALLEY
33	LIGHTS	ACW SVCE PLUG

	EMERGENCY EQUIPMENT	1.07.10		
		P 1/2	001	
	GENERAL			DEC 96

The aircraft is equipped with fire fighting, oxygen and first aid equipment, placed throughout the cabin, readily available for use in emergency.

The emergency lighting system provides aircraft illumination when all other electrical power sources are no longer available.

COCKPIT

Each crew member station is provided with :

- life jacket
- smoke goggles
- quick donning oxygen mask supplied with gaseous oxygen from one rechargeable bottle

A portable fire extinguisher and a fire axe are located at the bottom of the electric rack. Depending on versions, a smoke hood, located behind left crew member station, is available for crew member use.

One plug type hatch located in the cockpit roof is provided as an emergency exit for the cockpit crew. One escape rope is located in a compartment on top of the electric rack near the exit. Steps are provided for hatch access in the corridor RH side.

CABIN

The emergency equipment is strategically distributed throughout the cabin and stowed adjacent to the two cabin attendant stations.

It contains :

- portable fire extinguishers
- protective breathing equipments
- first aid kit
- crash axe
- life vests (stowed under each passenger seat and at the cabin crew stations)
- oxygen supply for passengers

	EMERGENCY EQUIPMENT GENERAL	1.07.10		
		P 3/4	230	
				JUN 97

SCHEMATICS

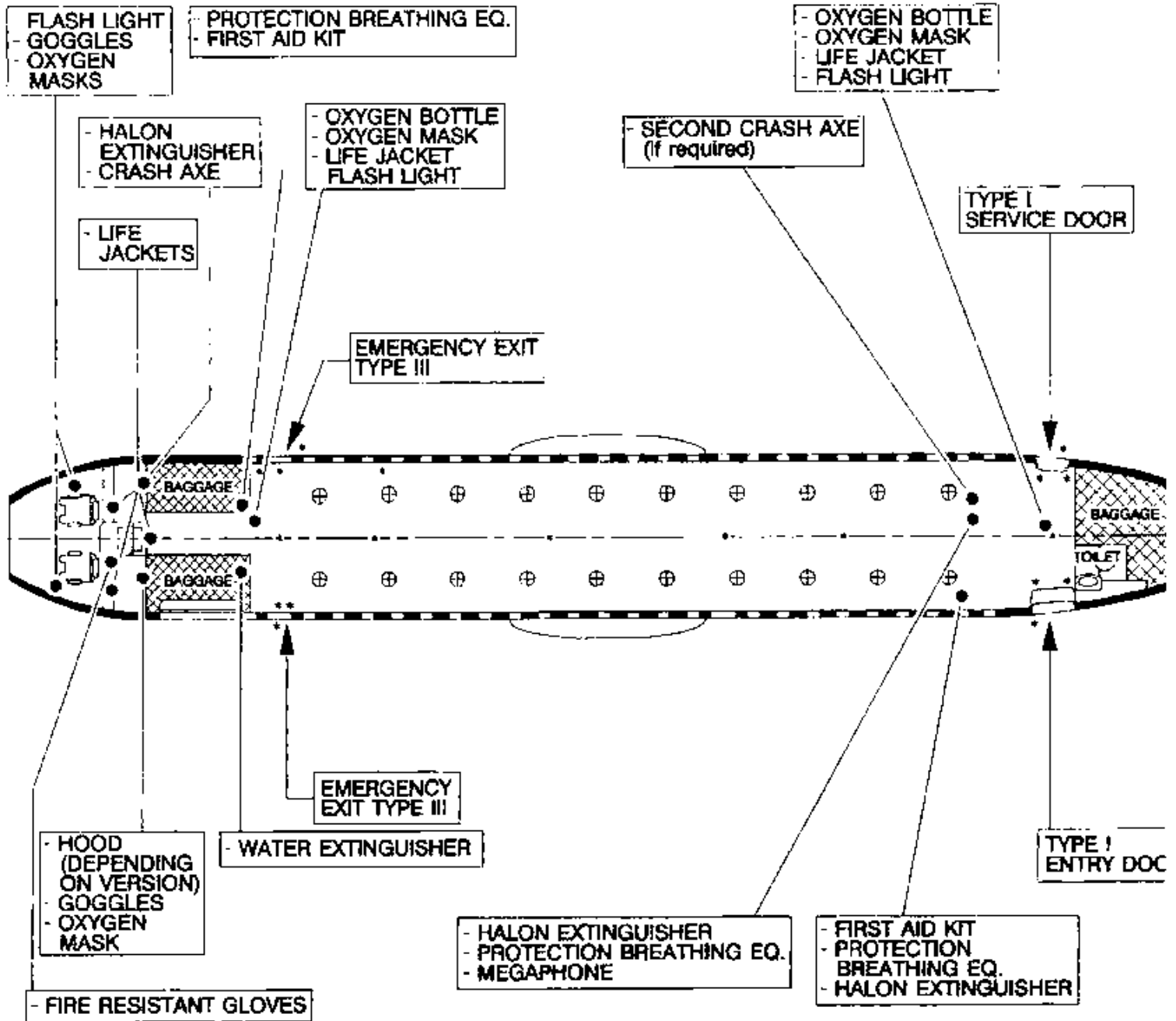

⊕ PASSENGERS O₂ SUPPLY DEVICE (LOCATION AND NUMBER ACCORDING TO ACCOMMODATION)

• EMERGENCY LIGHTING

	EMERGENCY EQUIPMENT CONTENTS	1.07.00		
		P 1	001	
				DEC 96

AA

1.07.00 CONTENTS

1.07.10 GENERAL

1.07.20 OXYGEN SYSTEM

R 20.1 DESCRIPTION

R 20.2 CONTROLS

R 20.3 ELECTRICAL SUPPLY/SYSTEM MONITORING

R 20.4 SCHEMATICS

1.07.30 EMERGENCY EVACUATION

	EMERGENCY EQUIPMENT	1.07.20	
		P 2	001
	OXYGEN SYSTEM		DEC 96

AA

20.2 CONTROLS

OXYGEN PANEL

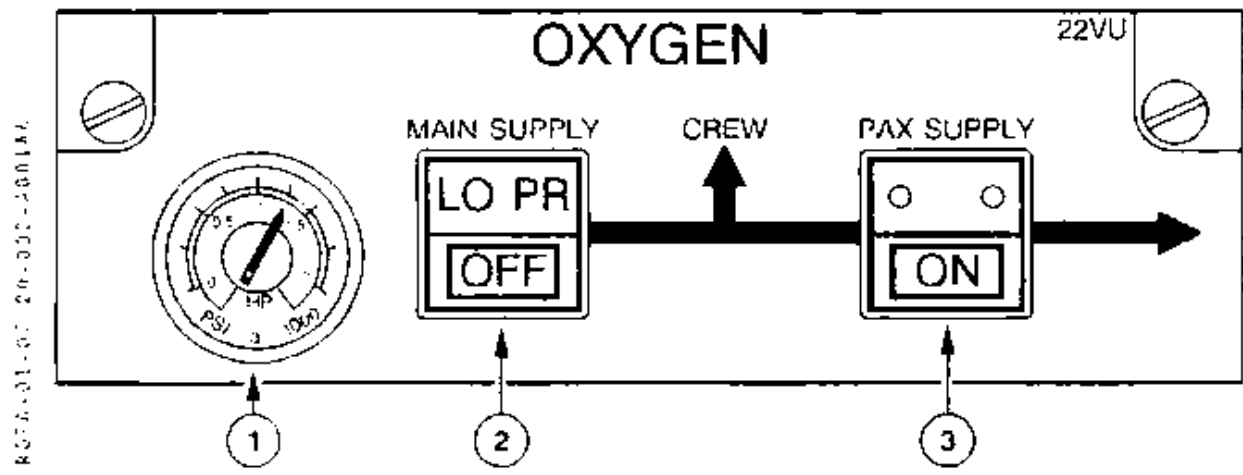

- ① **HP ind.**
 Oxygen bottle pressure is displayed in PSI X 1000.
 The scale is marked by a red arc from 0 to 85 PSI and by a green arc from 85 to 2025 PSI.
 If preflight pressure is below 1400 PSI, quantity must be checked to be adequate for intended flight (refer FCOM 2.01.05).

- ② **MAIN SUPPLY pb**
 Controls the low pressure supply solenoid valve.
 pb pressed in : The valve is open, low pressure oxygen is supplied to the cockpit crew oxygen masks.
 OFF : (pb released) the valve is closed. OFF illuminates white.
 LO PR : illuminates amber and the CCAS is activated when a low pressure (below 50 PSI) is detected in the low pressure distribution circuit.

- ③ **PAX SUPPLY pb**
 ON : (pb pressed in) Passengers supply valve is open. ON illuminates blue.
 pb released : Passengers supply valve is closed.

	EMERGENCY EQUIPMENT OXYGEN SYSTEM	1.07.20	
		P 3	001
		DEC 96	

AB

COCKPIT CREW OXYGEN MASK

ROFA-01-07-23-003-0001A2

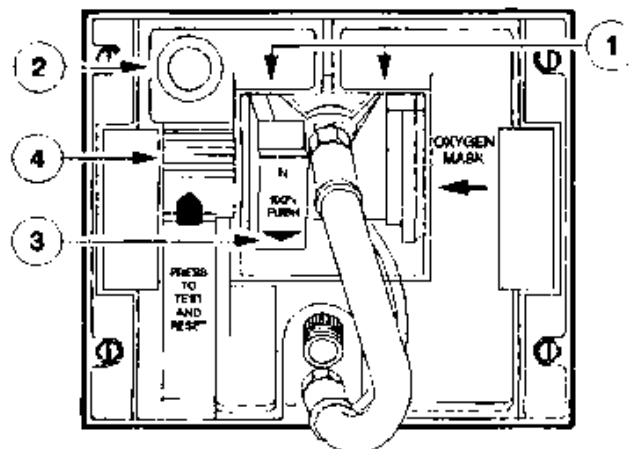
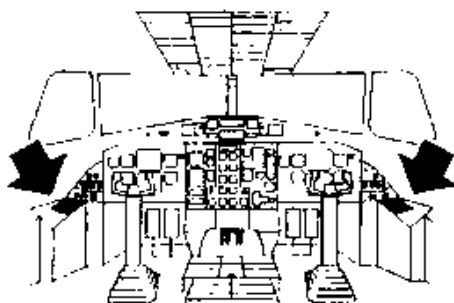

The cockpit crew oxygen masks are of the quick donning inflatable harness type, stowed in a container at each crew station. It can be donned with one hand. A regulator is incorporated in the mask.

- ① **Release clips**
Squeezing the red release clips unlocks the container doors. It also enables automatic inflation of mask harness, provided that pb 4 is held in TEST position or mask is extracted from container. The blinker momentarily displays a yellow cross.
- ② **Blinker**
Displays a yellow cross when there is oxygen flow, and black when there is no oxygen flow.
- ③ **N/100% rocker**
Controls the selection of normal or 100% oxygen for mask delivery. It is locked in the 100% position by the UNLOCK rocker.
 - 100% The mask delivers 100% undiluted oxygen.
 - N The mask delivers diluted oxygen.
- ④ **TEST/RESET pb**
Permits a test of oxygen flow without removing the mask from the container. It is springloaded to the RESET position.
 - TEST provided MAIN SUPPLY pb is selected ON, oxygen flows through the mask. The blinker momentarily displays yellow cross, and the flow is audible.

A lengthened hose is provided on the observer mask enabling access to the cargo with the mask.

RECOVERING BOOMSET/MICRO FUNCTION WHEN THE OXYGEN MASK IS OUT OF ITS CONTAINER :

Oxygen mask remaining out of its container :

- Close the oxygen mask container doors.
- Press the test push button in front of the container and release it, (yellow cross disappears).

The boomset/micro function is now recovered.

Note : If the pilot wishes to use the oxygen mask again and recover the mask micro, it just has to open the container doors.

	EMERGENCY EQUIPMENT		1.07.20		
			P 4	001	
	OXYGEN SYSTEM				DEC 96

UNDERSIDE OF REGULATOR

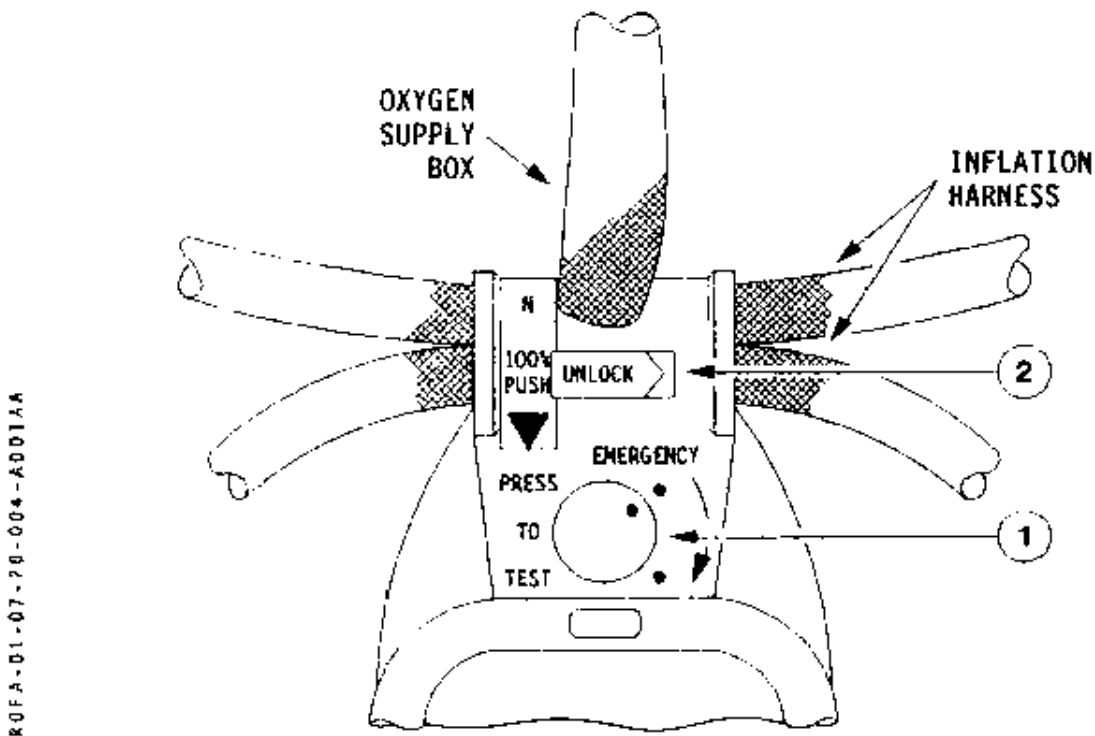

ROFA-01-07-70-004-ADD1AA

① EMERGENCY selector

Activates pressurization of mask delivery flow when the N/100% rocker is at 100%. Rotation of the selector in direction of the arrow gradually increases delivery pressure from zero to full pressure.

When pressed for test, full delivery pressure is supplied.

② UNLOCK rocker

Locks N/100% rocker at 100% position. When pressed, the rocker is released.

	EMERGENCY EQUIPMENT OXYGEN SYSTEM	1.07.20		
		P 5/6	001	
				DEC 96

AA

20.3 ELECTRICAL SUPPLY/SYSTEM MONITORING

ELECTRICAL SUPPLY

EQUIPMENT	DC BUS SUPPLY (C/B)
Oxygen control unit power supply	DC ESS BUS (on lateral panel OXY CTL UNIT PWR SUPPLY)
Pressure ind. and alert	DC ESS BUS (on lateral panel PRESS IND and CAUTION)

SYSTEM MONITORING

- The following condition is monitored by visual and aural alerts :
- Low pressure (below 50 psi) in the LP distribution circuit.
 - See OXYGEN LO PR procedure in chapter 2.05.12.



AR72
F.C.O.M.

EMERGENCY EQUIPMENT

1.07.20

P 7/8

050

OXYGEN SYSTEM

DEC 96

2. SCHEMATICS

OVERHEAD COCKPIT PANEL

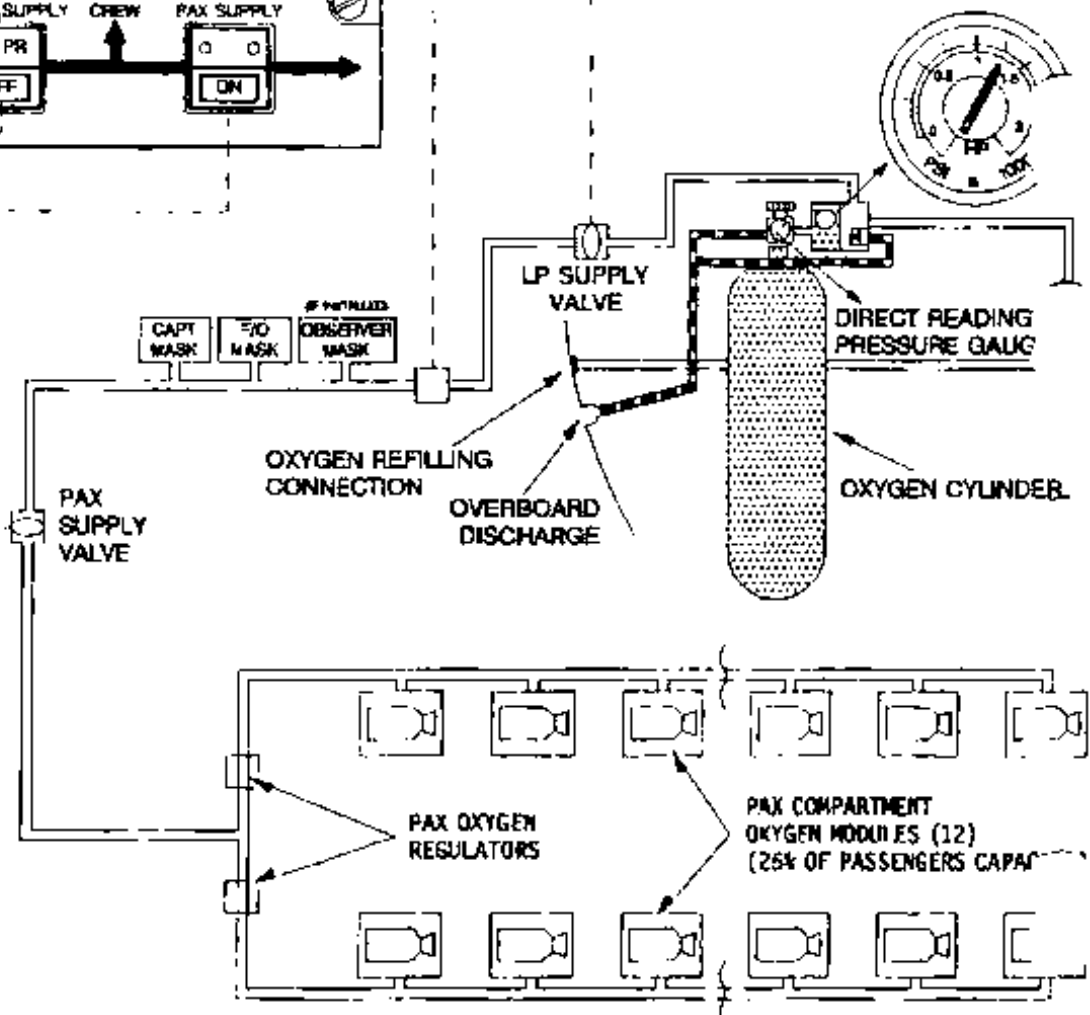
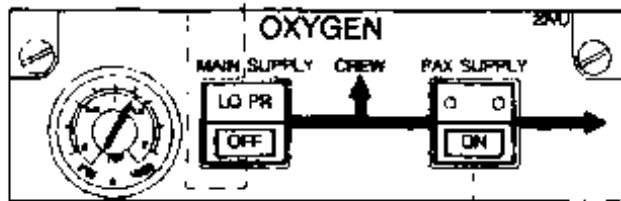

RCFA-01-07-20-007-4050AA

KEY

- HIGH PRESSURE
- OVER PRESSURE
- LOW PRESSURE

MASK SETTING

- 1 TAKE THE MASK BY SQUEEZING THE RED CLIPS

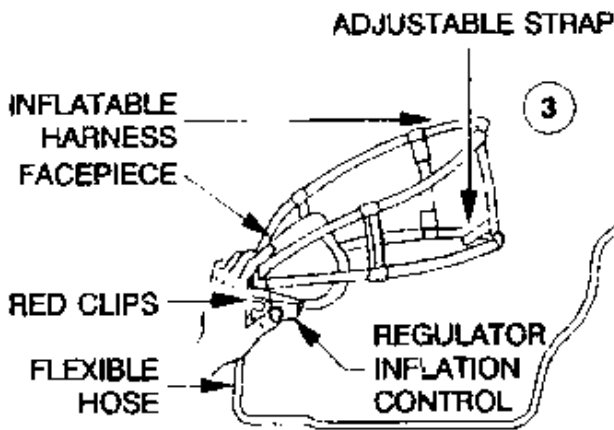
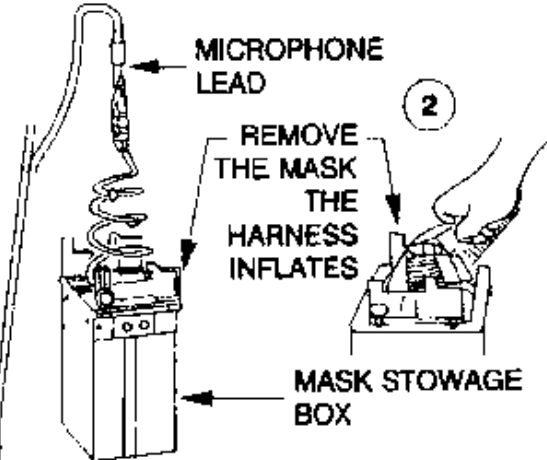
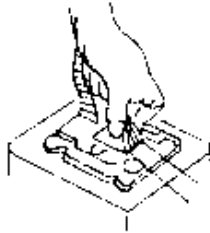

- 4 SETTING OF THE MASK (HARNESS INFLATED)

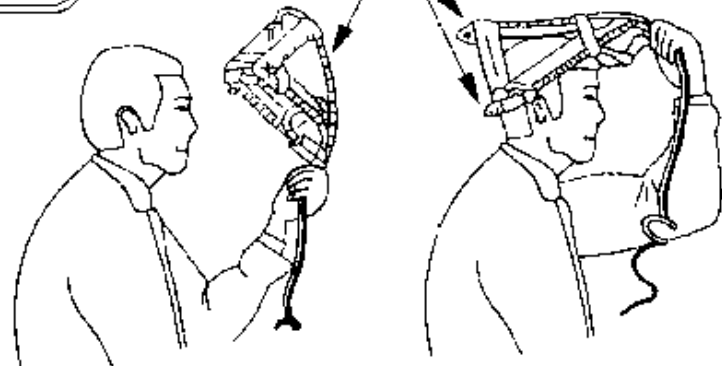

- 5 RELEASE THE RED CLIPS: HARNESS DEFLATED AND MAINTAINS THE MASK



- 6 ADJUST MASK WITH STRAPS



	EMERGENCY EQUIPMENT		1.07.30	
			P 1	370
	EMERGENCY EVACUATION		JUL 99	

AA

EMERGENCY EVACUATION IN CASE OF DITCHING

(A) EMERGENCY EXIT

REF: 01-01-10-01-017004

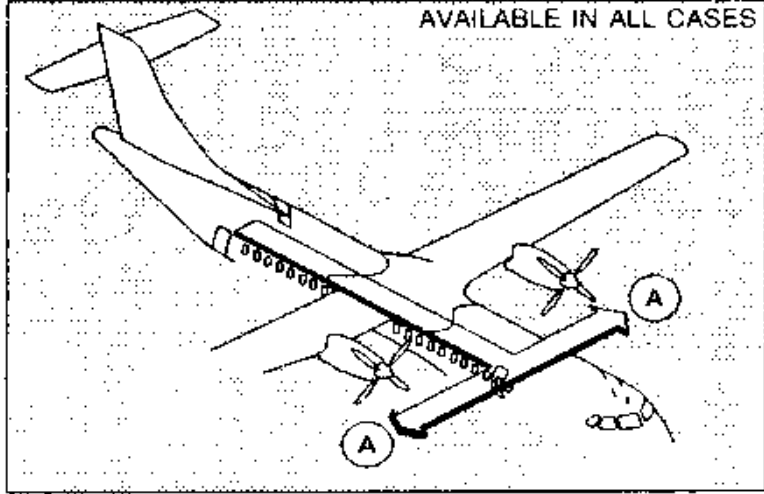
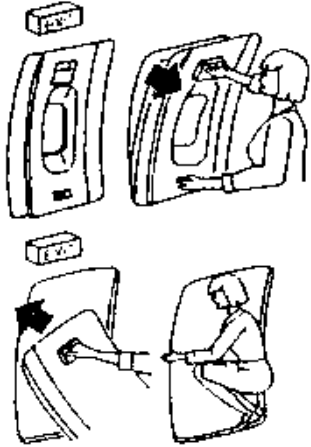

(B) SERVICE DOOR

REF: 01-01-10-01-017004

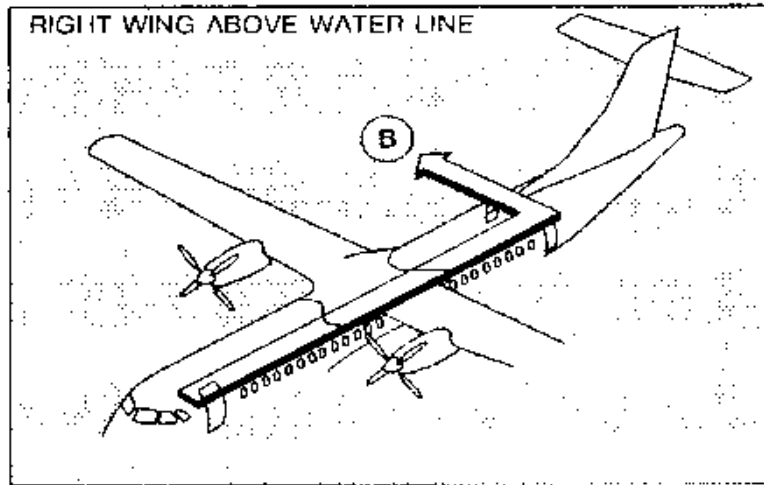
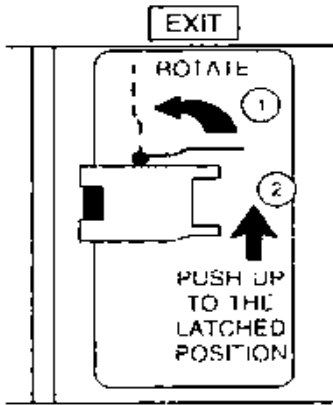

(C) PASSENGER/CREW DOOR

REF: 01-01-10-01-017004

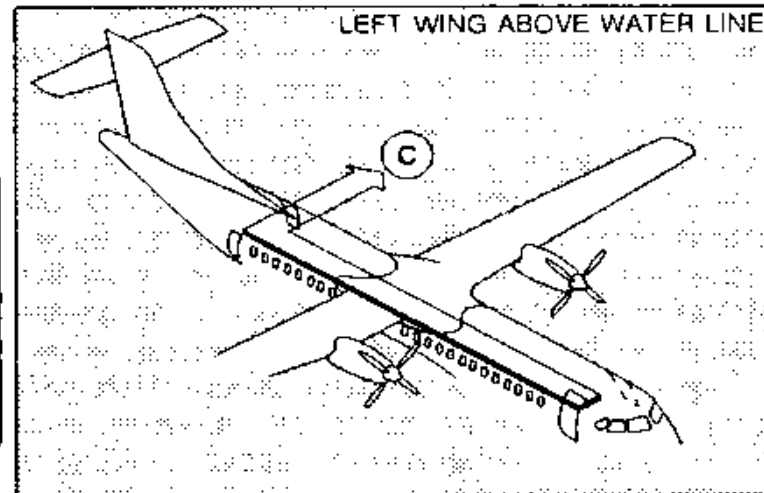
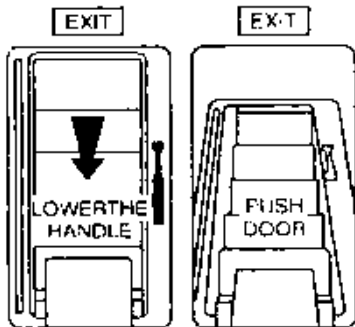

Note : Be sure that safety pin is removed.

	EMERGENCY EQUIPMENT		1.07.30	
			P 2	370
	EMERGENCY EVACUATION		JUL 99	

AA

EMERGENCY EVACUATION IN CASE OF FORCED LANDING

R07A-01-07-30-002-4370AA

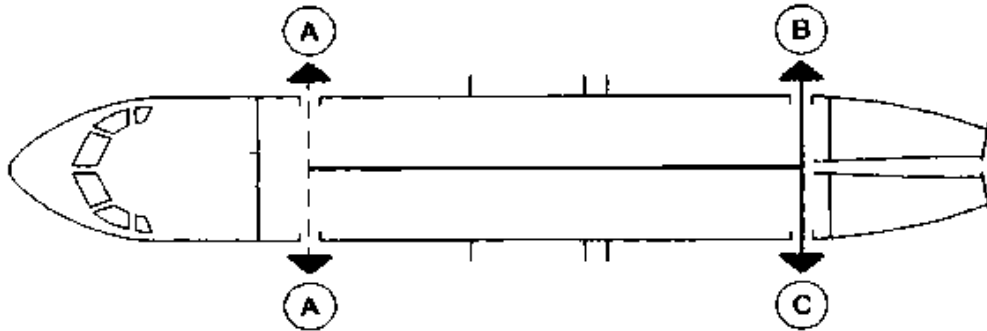

(A) EMERGENCY EXIT

R07A-01-07-30-002-3370AA

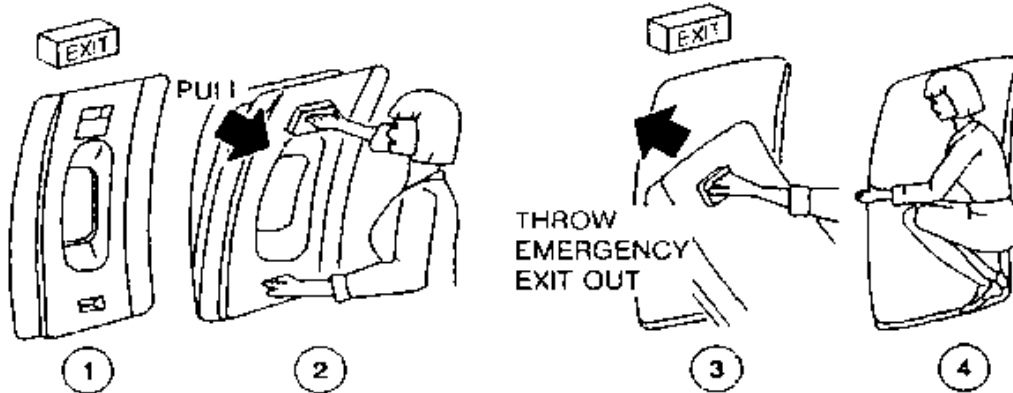

(B) SERVICE DOOR

R07A-01-07-30-002-6370AA

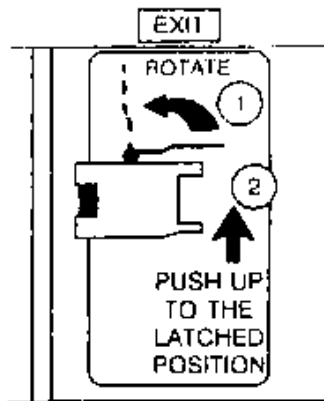

(C) PASSENGER/CREW DOOR

R07A-01-07-30-002-6370AA

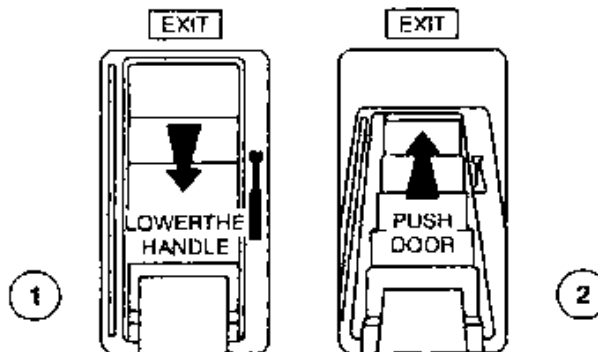

Note: Be sure that safety pin is removed.

	FIRE PROTECTION		1.08.00	
	CONTENTS		P 1	001
				DEC 96

AA

1.08.00 CONTENTS

R **1.08.10 GENERAL**

R 10.1 DESCRIPTION

R 10.2 CONTROLS

R 10.3 ELECTRICAL SUPPLY/SYSTEM MONITORING

	FIRE PROTECTION	1.08.10		
		P 1	001	
	GENERAL			JUL 99

AA

10.1 DESCRIPTION

The fire protection system is provided in order to ensure :

- Detection for :
 - each engine fire
 - right nacelle overheat (on ground only)
 - each cargo compartment and toilets smoke
 - avionics compartment smoke
- Extinguishing for :
 - each engine
 - cockpit, cabin and each cargo compartment
 - toilets waste bin

ENGINE FIRE DETECTION SYSTEM

Each engine is equipped with a fire detection system which consists of :

- Two identical detection loops (A and B) mounted in parallel.
- A fire detection control unit.

The detection principle is based on the variation of resistance and capacitance of the detection cable (fire signal). If there is only a change in resistance, associated loop will be declared failed by the fire detection control unit (fault signal).

Red ENG. FIRE illuminates on CAP in case of :

- Fire signal detected by both loops A and B or,
- Fire signal detected by one of the 2 loops if the other one is selected OFF.

R RIGHT NACELLE OVERHEAT DETECTION SYSTEM (on ground only)

Right nacelle is equipped with an overheat detector. When right nacelle temperature exceeds 170°C, NAC2 OVHT red alarm is triggered on CAP, and the CCAS is activated.

CARGO AND TOILETS SMOKE DETECTION SYSTEM

Forward cargo and after cargo are each equipped with one optical smoke detector.

R Ambient transmittance is monitored by reflection measurement.

Toilets are equipped with one photoelectric smoke detector.

In case of smoke detection, "SMOKE" signal is sent to CCAS through the MFC.

AVIONICS SMOKE DETECTION (See schematic 1.03.30 p. 3)

The avionics extract air duct is provided with a smoke detection device, linked to the CCAS. Smoke detection between the avionics compartment and the extract fan activates a "ELEC SMK" red alert on CAP.

	FIRE PROTECTION		1.08.10		
	GENERAL		P 2	200	
					JUN 97

ENGINE FIRE EXTINGUISHING SYSTEM

It includes two extinguishers bottles which may be used for engine n°1 or engine n° 2. They are located on each side of the fuselage. Dual squibs are installed in the discharge heads on each bottle. For fire extinguishing, the squibs are ignited by depressing the corresponding illuminated AGENT pb on the ENG FIRE panel. The extinguishing agent (freon or halon) is pressurized by nitrogen.

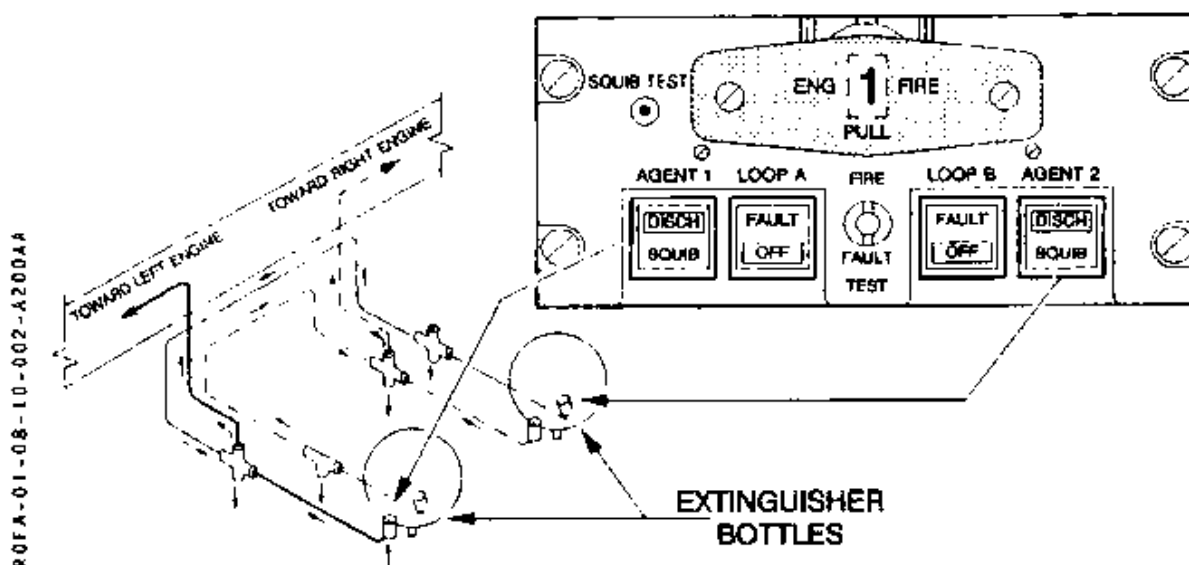

COCKPIT, CABIN AND CARGO COMPARTMENTS FIRE EXTINGUISHING SYSTEM

Portable extinguishers are provided to be operated manually (refer to schematic 1.07.10 p. 2 for location).

TOILETS WASTE BIN FIRE EXTINGUISHING SYSTEM

The system operates automatically when fire is detected (when the temperature is greater than 78°C (172°F)).

10.2 CONTROLS

ENG FIRE PANEL

ROFA-01-DB-10-003-4001AA

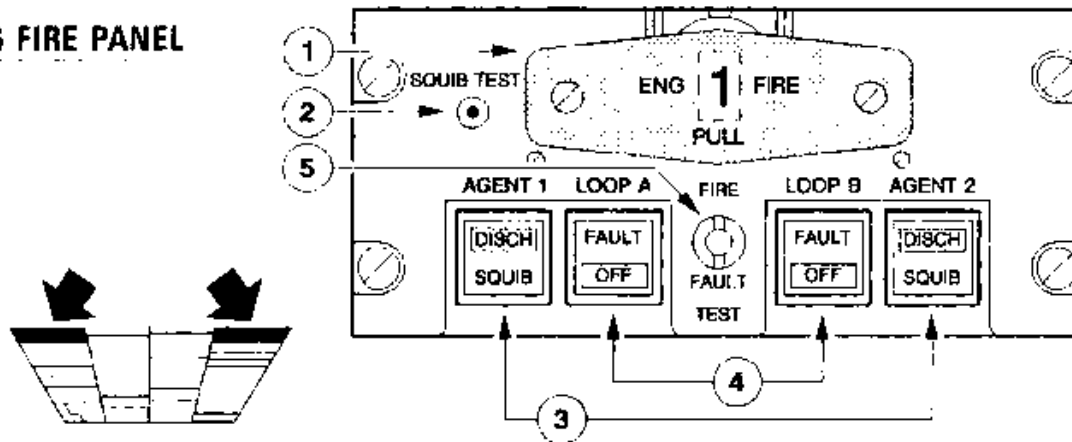

Two identical ENG FIRE panels with fire handles are provided for control of fire detection and extinguishing. One panel controls ENG 1, the other controls ENG 2.

① **ENG FIRE handle**

An ENG FIRE warning light is integrated into the handle. The light illuminates red and the CCAS is activated as long as the respective engine fire warning is activated (independently of handle position). Light goes off when the temperature detected by the loops drops below warning threshold.

The handle has two positions :

- Normal position (mechanically locked)
- PULLED

Pulling the handle electrically causes for the respective engine :

- PROPELLER Feathering
- FUEL ENG LP VALVE closure
- AIR BLEED VALVE and HP VALVE closure
- DE ICE DE ICE VALVE and ISOLATION VALVE closure
- ELEC ACW and DC GEN deactivation
- ALERT SQUIB lights illumination

② **SQUIB TEST pb**

Controls the test of the squibs in the discharge heads and their electrical circuits. When pressed in with the respective ENG FIRE handle in normal position, the two SQUIB lights illuminate if squibs and circuits are operative.

③ **AGENT pbs**

Control the ignition of squibs and resultant discharge of fire extinguisher bottles

- SQUIB : The lights illuminate white when the ENG FIRE handle is pulled to facilitate identification of the AGENT pbs which may be activated. When one is pressed in, the associated bottle is discharged.
- DISCH : The light illuminates amber when the related fire extinguisher bottle is depressurized after discharge.

Note : The discharge light will also illuminate on the non affected engine fire panel to facilitate identification of the depressurized bottle.

	FIRE PROTECTION	1.08.10		
		P 4	001	
	GENERAL			JUL 98

☺ LOOP pb

Allows activation of aural and visual alerts when a fire signal (FIRE) or a fault signal (LOOP) is generated by the fire detection control unit for the related loop.

pb pressed in : Aural and visual alerts are activated when a fire or a fault signal is generated by the fire detection control unit for the related loop.

OFF : (pb released) Aural and visual alerts are inhibited for the related loop. The OFF light illuminates white. LOOP amber light illuminates on CAP.

FAULT : The light illuminates amber and the CCAS is activated when the associated pb is selected ON and a fault signal is generated by the fire detection control unit. LOOP amber light illuminates on CAP.

TEST sw Spring Loaded in neutral position

Spring loaded in neutral position allows a test of the detection of fire and fault signals when both LOOP pbs are selected ON :

FAULT - FAULT lights of both LOOP A and LOOP B pb illuminate
 - CCAS is activated, LOOP amber light illuminates on CAP.

FIRE - ENG FIRE red light illuminates in associated fire handle
 - FUEL SO light illuminates in associated CL if CL isn't in fuel shut off position

R - CCAS is activated, ENG FIRE red light illuminates on CAP.

CL FUEL LT

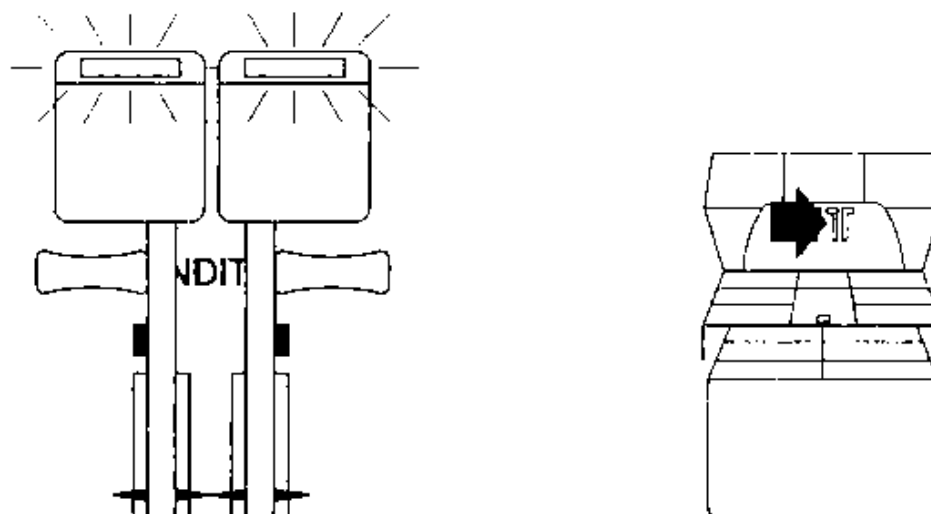

Illuminates red in case of fire signal from associated engine. Extinguishes after CL is set at fuel shut off position or if fire detection signal terminates.

	FIRE PROTECTION GENERAL	1.08.10		
		P 5	200	
				JUN 97

CARGO COMPARTMENTS AND TOILET SMOKE DETECTION

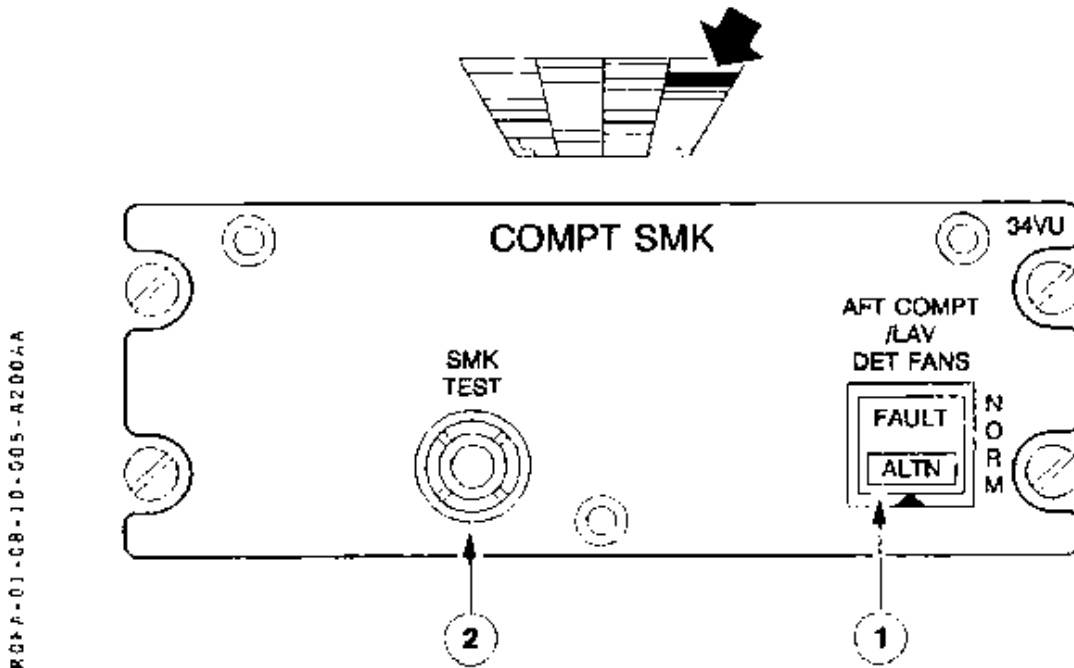

① AFT COMPT/LAV FANS Pb

NORM : (Pb pressed in) one fan runs.

FAULT : The fan is out of order

FAULT illuminates amber and CCAS is activated.

ALTN : (Pb released) the alternate fan runs, ALTN light illuminates white.

② SMK TEST Pb

Tests the smoke detectors working.

	FIRE PROTECTION GENERAL	1.08.10		
		P 6	001	
				JUN 97

LEFT INTENTIONALLY BLANK

	FIRE PROTECTION		1.08.10	
	GENERAL		P 7	001
				DEC 96

AA

10.3 ELECTRICAL SUPPLY/SYSTEM MONITORING

ELECTRICAL SUPPLY

EQUIPMENT	DC BUS SUPPLY (C/B)
ENG 1	
Loop A	DC EMER BUS (on lateral panel LOOP A)
Loop B	DC EMER BUS (on lateral panel LOOP B)
Fire handle	DC EMER BUS (on lateral panel FIRE HANDLE)
CL light	DC EMER BUS (on lateral panel CLA)
ENG 2	
Loop A	DC EMER BUS (on lateral panel LOOP A)
Loop B	DC EMER BUS (on lateral panel LOOP B)
Fire handle	DC EMER BUS (on lateral panel FIRE HANDLE)
CL light	DC EMER BUS (on lateral panel CLA)
Left extinguisher bottle squibs	DC EMER BUS (on lateral panel SQUIBS) HOT MAIN BAT BUS (on lateral panel SQUIBS)
Right extinguisher bottle squibs	DC EMER BUS (on lateral panel SQUIBS) HOT MAIN BAT BUS (on lateral panel SQUIBS)
Forward cargo smoke detector	DC ESS BUS (on lateral panel FWD SMOKE DETECTOR)
Aft cargo smoke detector	DC ESS BUS (on lateral panel AFT SMOKE DETECTOR)

	FIRE PROTECTION		1.08.10		
			P 8	200	
	GENERAL				JUN 97

ELECTRICAL SUPPLY

EQUIPMENT	DC BUS SUPPLY (C/B)	AC BUS SUPPLY (C/B)
Avionics smoke detector	DC ESS BUS (on lateral panel ELEC SMK DET)	- Nil -
Toilets smoke detector	DC ESS BUS (on lateral panel)	- Nil -
Aft cargo and toilets ventilation fans PWR	- Nil -	AC STBY BUS (on lateral panel FANS PWR)
Aft cargo and toilets ventilation fans CTL	DC ESS BUS (on lateral panel AFT FANS IND)	- Nil -
Forward cargo ventilation fans CTL	DC ESS BUS (on lateral panel)	- Nil -
Forward cargo ventilation fans PWR	- Nil -	AC STBY BUS (on lateral panel)

SYSTEM MONITORING

The following conditions are monitored by visual and aural alerts :

- ENG fire signal
 - See ENG FIRE procedure in chapter 2.04.02.
- Smoke detected in the avionics ventilation circuit
 - See ELECTRICAL SMOKE procedure in chapter 2.04.03.
- Smoke detected in the FORWARD cargo compartment
 - See FWD CARGO SMOKE procedure in chapter 2.04.03.
- Smoke detected in the aft cargo compartment or in the lavatory
 - See AFT COMPT SMOKE procedure in chapter 2.04.03.
- Nacelle temperature exceeds 170°C (338°F) when aircraft is on ground.
 - See NAC OVHT procedure in chapter 2.05.02.
- Fire Loop fault signal
 - See FIRE LOOP FAULT procedure in chapter 2.05.12.

	FLIGHT CONTROLS	1.09.00		
	CONTENTS	P 1	060	
				JUL 00

AA

1.09.00	CONTENTS
1.09.10	GENERAL
1.09.20	ROLL
20.1	DESCRIPTION
20.2	CONTROLS
20.3	ELECTRICAL SUPPLY
1.09.30	PITCH
30.1	DESCRIPTION
30.2	CONTROLS
30.3	ELECTRICAL SUPPLY/MFC LOGIC/SYSTEM MONITORING
30.4	LATERAL MAINTENANCE PANEL
30.5	SCHEMATIC
1.09.40	YAW
40.1	DESCRIPTION
40.2	CONTROLS
40.3	ELECTRICAL SUPPLY/MFC LOGIC
40.4	SCHEMATIC
1.09.50	FLAPS
50.1	DESCRIPTION
50.2	CONTROLS
50.3	ELECTRICAL SUPPLY/MFC LOGIC/SYSTEM MONITORING
50.4	LATERAL MAINTENANCE PANEL
50.5	SCHEMATIC
1.09.60	GUST LOCK
60.1	DESCRIPTION
60.2	CONTROLS
60.3	ELECTRICAL SUPPLY/MFC LOGIC/SYSTEM MONITORING

 ATR 72 F.C.O.M.	FLIGHT CONTROLS GENERAL	1.09.10		
		P 1	060	
				JUL 00

AA

The control of the aircraft is achieved on the three axes by :

- On each wing, one aileron (spring tab equipped) and one spoiler
- Two elevators (servo-tab equipped)
- A rudder (spring-tab equipped)

Ailerons, elevators and rudder are mechanically actuated.

Spoilers are hydraulically actuated (blue system).

Wind protection is achieved on ground by :

- a locking mechanism on pitch and roll axes
- a damping unit on yaw axis limiting rudder excessive travel speed.

On each wing flaps are provided in two parts (inboard and outboard) mechanically linked and hydraulically activated (blue system).

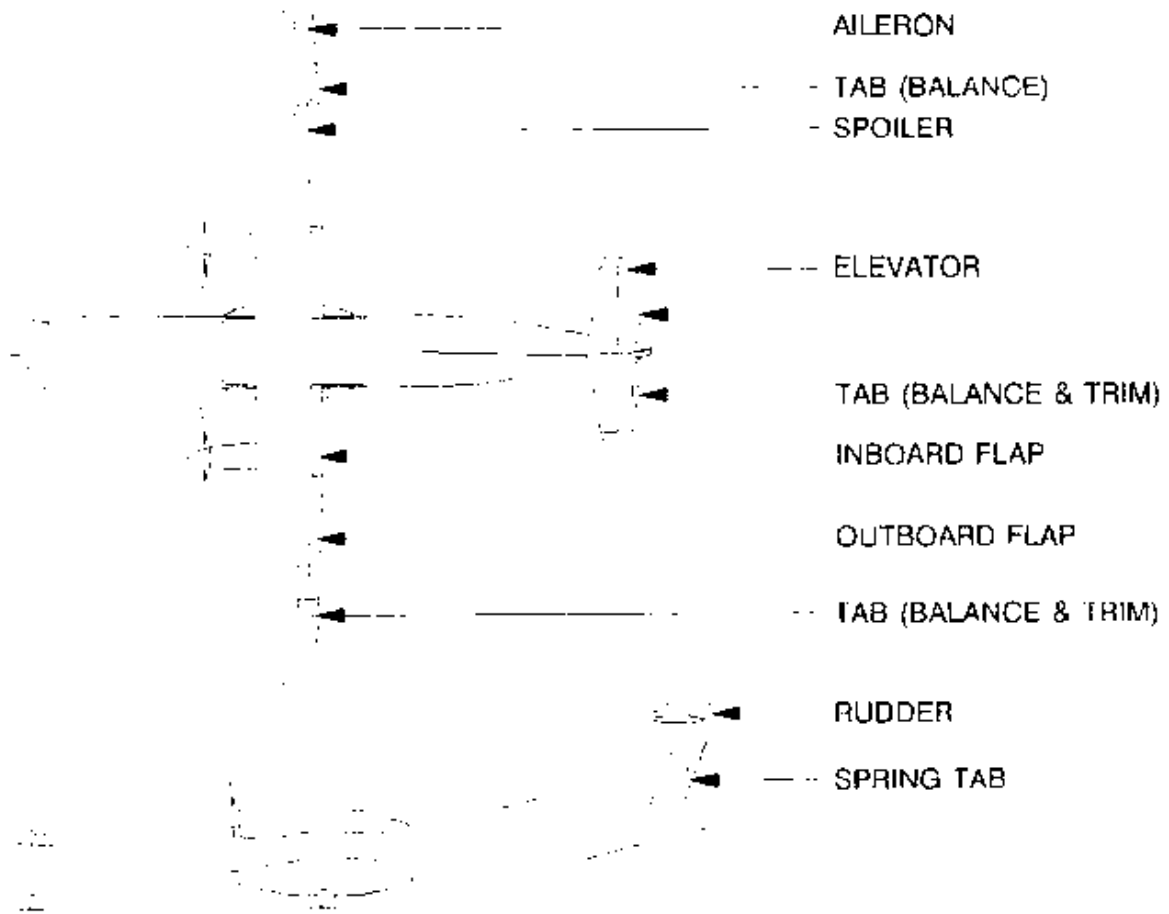

80-01-01-0910-00 - 000000

 ATR 72 F.C.D.M.	FLIGHT CONTROLS ROLL	1.09.20		
		P 1	060	
				JUL 01

AA

20.1 DESCRIPTION

Roll control is achieved through control wheels.

SPRING TAB

A spring tab provides a flexible compensation which automatically increases with the aerodynamic loads applied on the ailerons, thus ensuring a reduction of the pilot's efforts.

- R Wheel travel : $\pm 87^\circ$
- Ailerons travel : 14° up, 14° down

ROLL TRIM

Aileron trim is performed by varying the neutral position setting of the left aileron spring tab with respect to the aileron.

It is electrically controlled from a twin control sw through an electrical actuator.

- R LH aileron trim controlled tab travel : 6.7° up, 6.7° down.
- Full roll trim travel requires about 30 s.

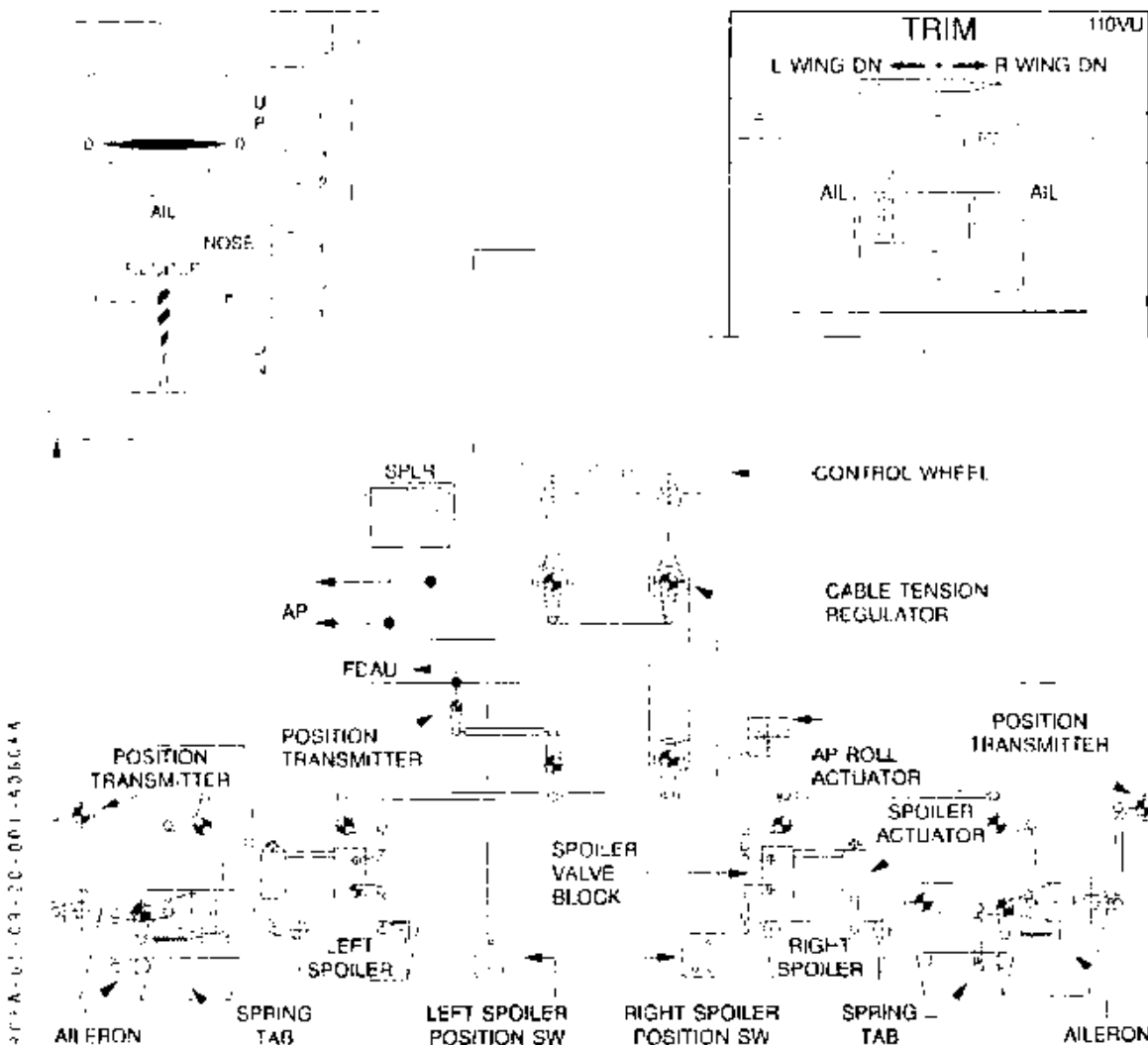

 ATR 72 F.C.O.M.	FLIGHT CONTROLS ROLL	1.09.20		
		P 2	001	
				DEC 96

48

20.2 CONTROLS

SPOILER POSITION IND

ROFA-01-09-20-002-A001AA

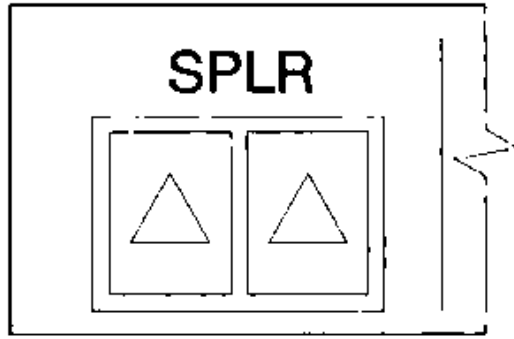

When illuminated, each blue light indicates that the associated spoiler is not in the retracted position.

ROLL TRIM POSITION IND

ROFA-01-09-20-002-B001AA

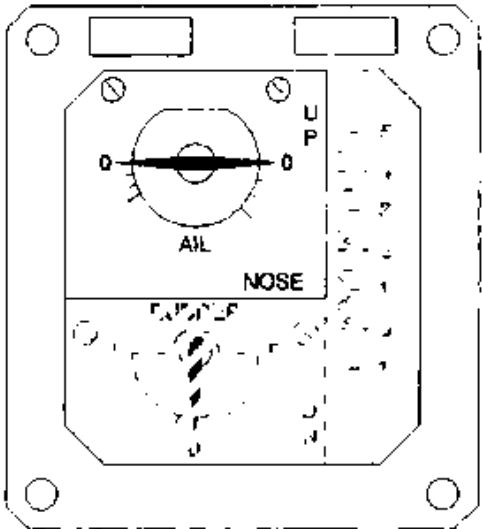

Indicates the LH aileron trim controlled tab travel.

ROLL TRIM CONTROL SW

ROFA-01-09-20-002-C001AA

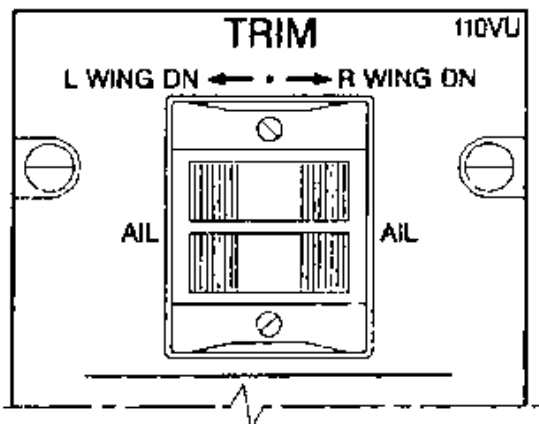
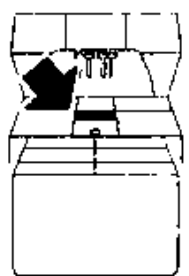

Controls the roll trim actuator.
 For operation, both sws must be moved and held in the same direction (L WING DN or R WING DN) to energize the system (safety reasons).

 ATR 72 F.C.O.M.	FLIGHT CONTROLS ROLL	1.09.20		
		P 3	001	
				DEC 96

ATA

20.3 ELECTRICAL SUPPLY

EQUIPMENT	DC BUS SUPPLY (C/B)	AC BUS SUPPLY (C/B)
Spoiler position ind.	DC BUS 1 (on lateral panel SPLR IND)	- Nil -
Roll trim	DC EMER BUS (on lateral panel ALL)	- Nil -
Roll (pitch, yaw) Trim position ind.	- Nil -	26 VAC BUS 1 (on lateral panel POS IND)

	FLIGHT CONTROLS PITCH	1.09.30		
		P 1	001	
				DEC 96

30.1 DESCRIPTION (See schematic p 7/8)

Each control column mechanically drives the associated elevator and, through a pitch coupling mechanism, the other elevator and the opposite control column.

In case of jamming pitch control will be recovered by applying on both control columns a differential force (52 daN) disengaging the pitch coupling system.

The non affected channel allows the aircraft to be operated safely. System recoupling has to be performed on ground.

Pitch uncoupling generates "PITCH DISCONNECT" red alert.

Control column travel : 11.25° up, 6.75° down.

Elevators travel : 23° up, 13° down.

Elevators automatic tab travel : 50% of the pitch control course.

Pitch trim is performed by off setting both tabs neutral position.

Normal trim (control column) and STBY trim (pedestal) supply appropriate part of each actuator.

Each trim tab is activated by a dedicated actuator. The two actuators are synchronized by a flexible shaft.

In case of pitch tabs desynchronization :

- an alert is generated by the CCAS
- normal and STBY pitch trim control are inoperative
- AP disconnects

Trim tab travel, displayed on the pitch trim position indicator is added to the automatic tab travel.

Elevators trim controlled tab travel : 5° up, 1.5° down.

Full pitch trim travel requires about 30s in normal and in STBY control.

A stick pusher and a stick shaker are provided, preventing the aircraft from reaching a critical angle of attack. When the detected incidence becomes too high, the MFC sends a signal to an electric actuator which shakes the control column at stall alert thresholds.

If angle of attack keeps increasing a further threshold is reached and the MFC activates the stick pusher ; the complete pitch control linkage assembly is pushed forward.

Note : There are two stick shakers, one for each control column but only one stick pusher actuator located on the captain pitch channel. In case of pitch uncoupling when the pusher triggering angle of attack is reached, only the captain control column is pushed forward.

 ATR 72 F.C.O.M.	FLIGHT CONTROLS		1.09.30		
			P 2	001	
					DEC 96
		PITCH			

30.2 CONTROLS

PITCH TRIM ROCKER SWITCHES

ROFA-01-0930-002-A001AA

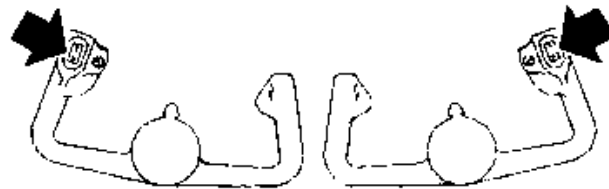
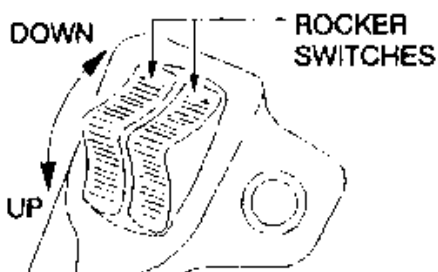

On each control wheel, two pitch trim rocker switches are installed. It's necessary to operate both rocker switches to activate the normal electrical motor of each trim actuator and to control nose up or down.

The switches are spring loaded to neutral position.

If both switches are operated simultaneously but in opposite direction, trimming action stops.

If normal trim actuator is actuated during more than 1s, an aural whooper is generated by the CCAS.

Note : NORMAL TRIM will disengage the AP.

PITCH TRIM POSITION IND

ROFA-01-0930-032-B0C1AA

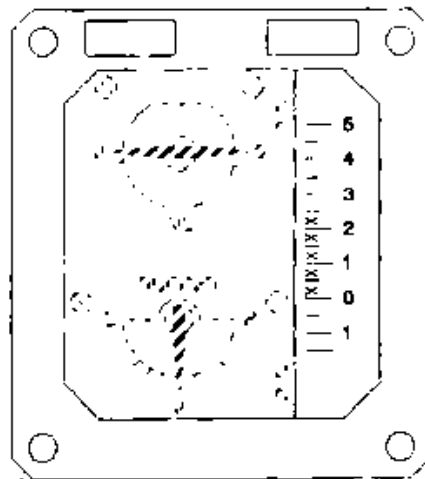

Indicates the right trim actuator controlled tab travel.

A green sector (from 0° to 2.5° UP) identifies the take off range. If take off (or take off config test) is performed with pitch trim out of this range, CONFIG warning will be generated by the CCAS.

PITCH TRIM ASYM LIGHT



PITCH TRIM
ASYM

Illuminates amber to indicate a pitch tabs desynchronization.

ROFA-01-0930-042-C061

	FLIGHT CONTROLS		1.09.30	
	PITCH		P 3	001
			DEC 96	

STBY PITCH CONTROL SW

ROFA-01-0930-003-A001AA

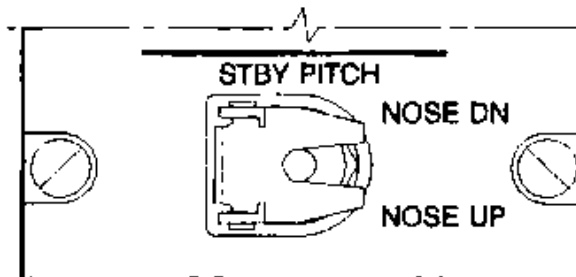

This guarded sw controls the electrical motor of each trim actuator. Action on this switch will disengage the AP.

CAUTION : SIMULTANEOUS ACTION ON A NORMAL ROCKER SWITCH AND THE STBY SWITCH IS NOT RECOMMENDED.

STICK PUSHER PB

ROFA-01-0930-003-B00:AA

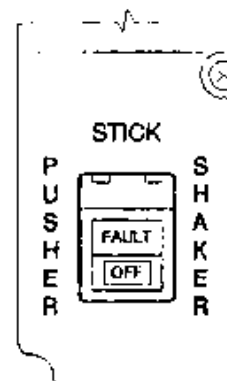

- FAULT light (amber) :
Indicates a stick pusher or stick shaker failure.
 - OFF Position :
Enables to switch OFF the stick pusher and the stick shaker system.
- Note* : STALL WARNING aural alert is also lost.

STICK PUSHER LIGHT

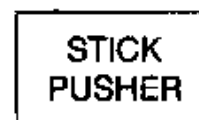
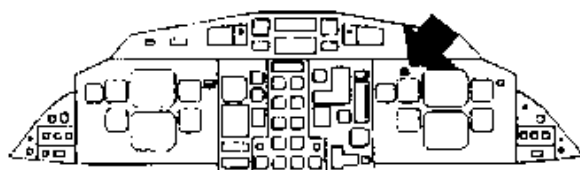

Illuminates green to indicate that the stick pusher is operating.

ROFA-01-0930-003-C001AA

	FLIGHT CONTROLS PITCH	1.09.30		
		P 4	001	
				DEC 96

30.3 ELECTRICAL SUPPLY/MFC LOGIC/SYSTEM MONITORING

ELECTRICAL SUPPLY

EQUIPMENT	DC BUS SUPPLY (C/B)	AC BUS SUPPLY (C/B)
Normal pitch control	DC EMER BUS (on lateral panel NORM)	- Nil -
Standby pitch control	DC BUS 2 (on lateral panel STBY)	Nil -
Pitch (roll yaw) trim position ind.	Nil	26 VAC BUS 1 (on lateral panel POS IND)
Stick pusher PWR	DC BUS 1 (on lateral panel PWR)	- Nil -
Stick pusher CTL	DC BUS 1 (on lateral panel CTL)	- Nil -
Pitch tabs desynchronization	DC BUS 1 (on overhead panel CCAS WARN)	- Nil -
Left Stick Shaker	DC BUS 1 (On lateral panel PWR)	- Nil -
Right Stick Shaker	DC BUS 2 (On lateral panel CTL)	- Nil -

MFC LOGIC

See chapter 1.01.

SYSTEM MONITORING

The following conditions are monitored by visual and aural alerts :

- Pitch trim out of the take off range (0° DN to 2.5° UP) when PL at TO position or simulated so by the TO CONFIG TEST.
 - MW Light flashing red
 - CONFIG red light on CAP
 - FLT CTL amber light on CAP
 - Aural alert is Continuous Repetitive Chime (CRC)
- Pitch coupling mechanism disconnected.
 - See PITCH DISCONNECT procedure in chapter 2.05.06.
- Pitch tabs desynchronization
 - See PITCH TRIM ASYM procedure in chapter 2.05.06.
- Stick pusher/Stick shaker fault
 - See STICK PUSHER/SHAKER FAULT procedure in chapter 2.05.06.

The condition "Normal trim or stby trim actuator actuated during more than 1s" is monitored by aural alert only (whooler).

 ATR 72 F.C.O.M.	FLIGHT CONTROLS PITCH	1.09.30		
		P 5/6	050	
				DEC 96

AA

30.4 LATERAL MAINTENANCE PANEL

PITCH TRIM TEST

A PTT pb is provided on RH lateral maintenance panel to test the pitch tabs shift detection unit.

R0FA-01-0930-005-A050AA

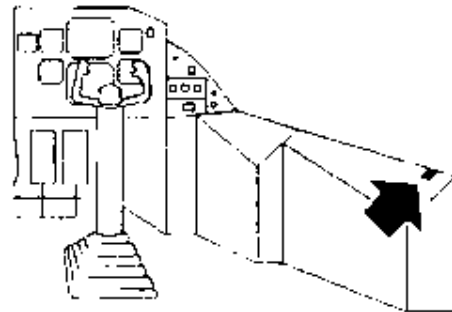
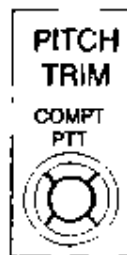

Test procedure

- DC electrical power available
- Depress and hold test button :
 - MC illuminates amber.
 - "FLT CTL" illuminates amber on CAP.
 - "PITCH TRIM ASYM" illuminates amber on center panel
 - SC is heard.
 - Disconnection of AP if engaged.

ELEVATOR CLUTCH

R0FA-01-0930-005-B050AA

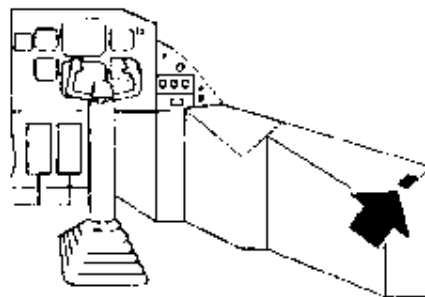
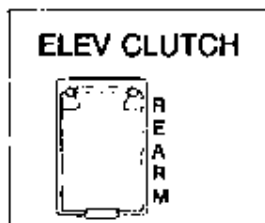

Allows to reconnect (only on ground) both elevators in case of declutch (see FCOM 2.02.06).

30.5 SCHEMATIC

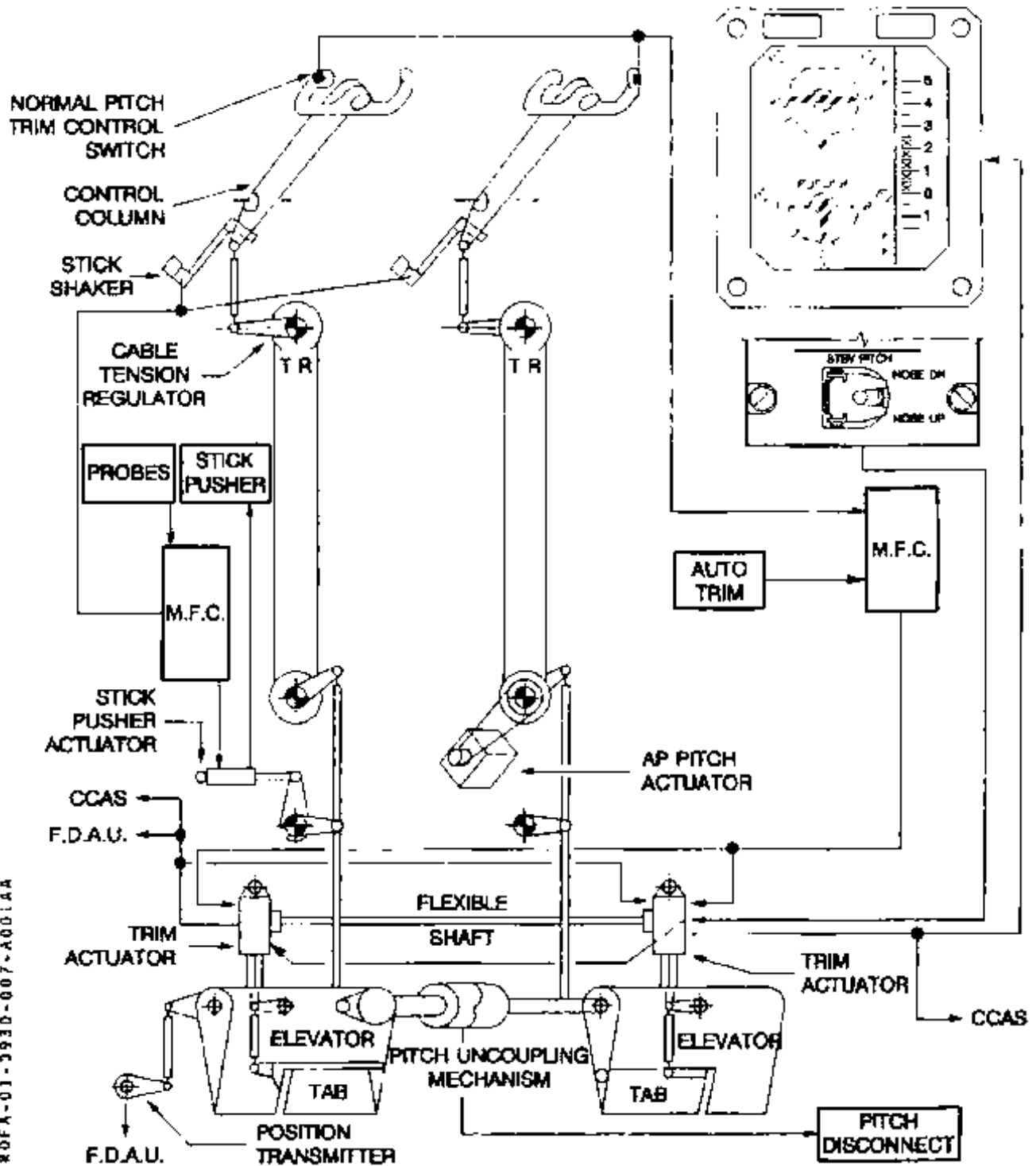

RDXA-01-3930-007-A001A4

 AJR 72 F.C.O.M.	FLIGHT CONTROLS YAW	1.09.40		
		P 1	001	
				DEC 96

40.1 DESCRIPTION (See schematic p7/8)

Yaw control system consists of rudder pedals, TLU, RCU, rudder damper and trim.
 Rudder pedals mechanically act on a spring tab and through it on the rudder itself.

SPRING TAB

A spring tab provides a flexible compensation which automatically increases with the aerodynamic loads applied on the rudder, thus ensuring a reduction of the pilot's efforts when really needed (engine failure).

■ Neutral position

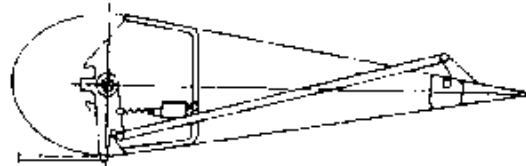

80FA-01-0940-001-A001AA

Note : The « spring » consists of two Diapasons.

■ Without airload on the surface ($V = 0$), when rudder pedals are moved to full deflection, the spring tab stays in line with the rudder until the rudder reaches its stops, above that point it moves the tab.



80FA-01-0940-001-B001AA

■ With airload on the surface ($V \neq 0$), the spring tab has a travel in the opposite direction of the rudder which generates a compensating moment. Spring travel increases with airspeed.

* Low aerodynamic forces

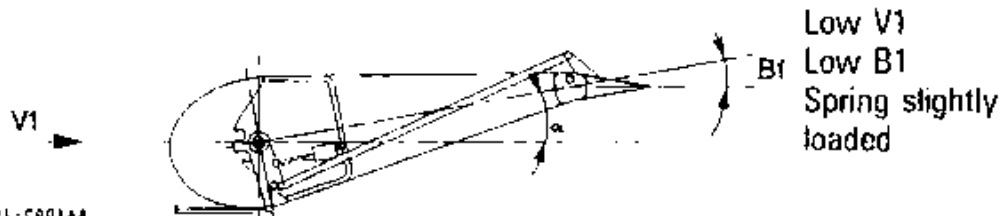

80FA-01-0940-001-C001AA

* High aerodynamic forces

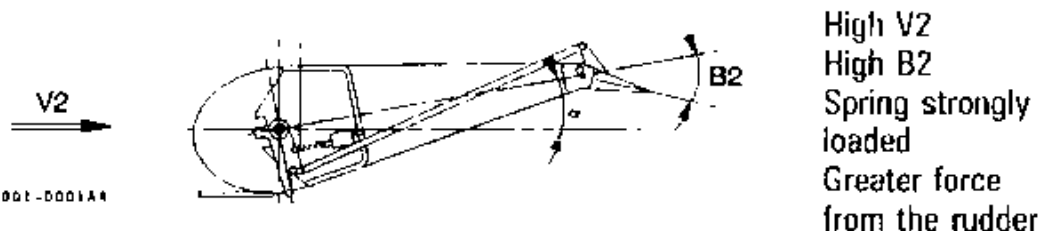

80FA-01-0940-001-D001AA

	FLIGHT CONTROLS YAW	1.09.40		
		P 2	001	
				DEC 96

TRAVEL LIMITATION UNIT (TLU)

The travel limitation unit is fitted on the aircraft to limit pedals travel in order to prevent any damaging rudder travel when flying high speed.

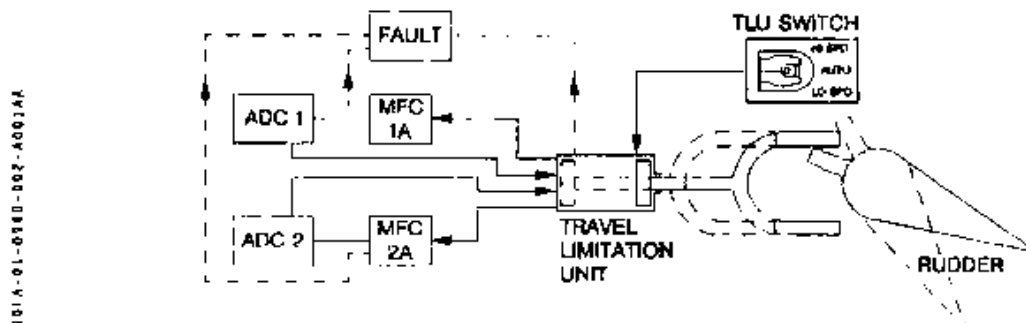

The TLU automatic control is done through ADC 1/2 when reaching 185 kt during an acceleration and when reaching 180 kt during a deceleration. The TLU setting (high speed or low speed) may also be performed manually in case of ADC failure.

RELEASABLE CENTERING UNIT (RCU)

A releasable centering unit is provided between the rudder and the linkage to the pilots pedals to enable rudder position stabilization when no action is applied on the pedals.

This RCU position changes with trim setting. As soon as the yaw trim control upper lever is moved to the left or lower lever to the right, the releasable centering unit is disengaged to allow trim setting. It will be re-engaged at the new position when the yaw trim control switches are released.

DAMPER

The rudder is linked to the aircraft structure by a damper :

- In flight this damper regulates rudder travel speed
- On ground it limits excessive movement generated by gusts and avoids damaging the structural stops.

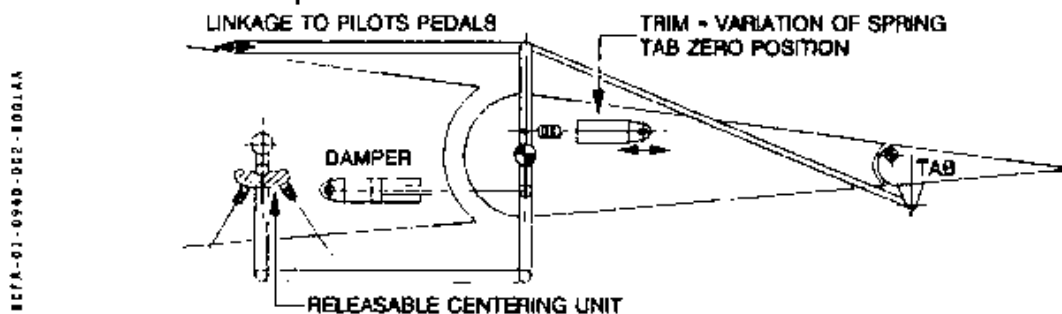

YAW TRIM

It is performed by offsetting the spring tab zero position.

Yaw trim is electrically controlled from a twin rudder rotary selector through a trim actuator.

Units of trim motor displacement are displayed on the yaw trim position ind.

Maximum values are ± 3 dots.

Full yaw trim travel requires about 15 s.

 ATR 72 F.C.O.M.	FLIGHT CONTROLS YAW	1.09.40		
		P 3	001	
				DEC 96

AA

40.2 CONTROLS

TLU (control and indication)

B0FA-03-0940-003-AG03AA

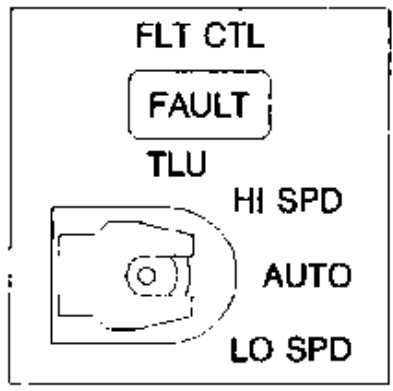

- This is a guarded selector.
- AUTO : Normal position in flight
 - HI SPD } : Used according to IAS after FAULT illumination.
 - LO SPD }
 - FAULT : illuminates amber when a system failure is detected.
 - system disagree
 - two ADC failure
 - ADC datas incoherence
 - TLU position synchro failure.

LO SPD Light (Associated to TLU)

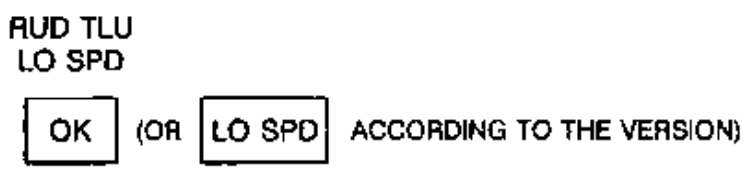

B0FA-03-0940-003-AG03AA

OK (or LOSPD) light illuminates green when rudder travel is not limited.

AA

YAW TRIM POSITION IND

ROFA-01-0940-004-A001AA

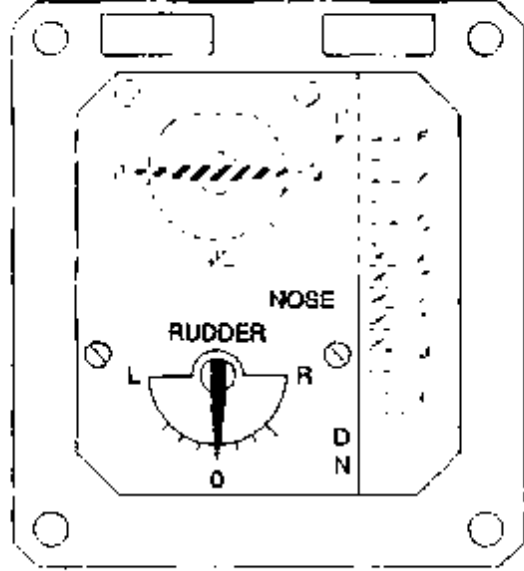

Indicates units of trim motor displacement.

YAW TRIM CONTROL SWITCHES

ROFA-01-0940-004-B001AA

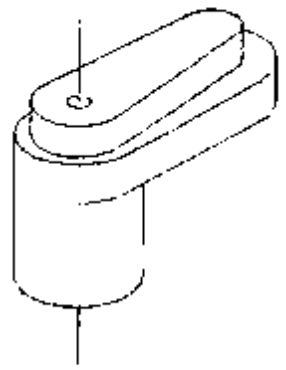
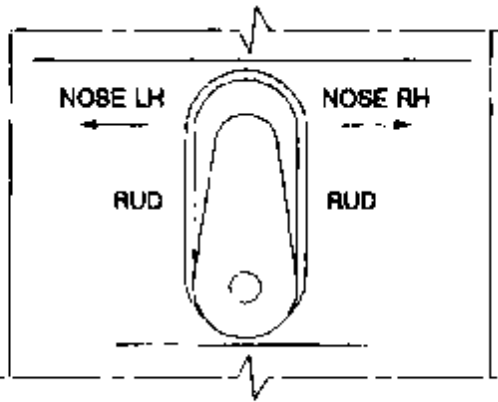

Controls the yaw trim actuator.
 As a safety device both levers must be moved and held in the same direction (Nose LH or Nose RH) to energize the system and trim the aircraft.

 AR72 F.C.O.M.	FLIGHT CONTROLS YAW	1.09.40		
		P 5/6	001	
				DEC 96

AA

40.3 ELECTRICAL SUPPLY/MFC LOGIC

ELECTRICAL SUPPLY

EQUIPMENT	DC BUS SUPPLY (C/B)	AC BUS SUPPLY (C/B)
Yaw trim	DC EMER BUS (on lateral panel RUD)	- Nil -
Yaw (pitch, roll) Trim position ind.	- Nil -	26 VAC BUS 1 (on lateral panel POS IND.)
. Travel limitation unit control	DC BUS 1 (lateral panel)	- Nil -
. Travel limitation unit indication	DC STBY BUS	- Nil -

MFC LOGIC

See chapter 1.01.

40. CHEMATICS

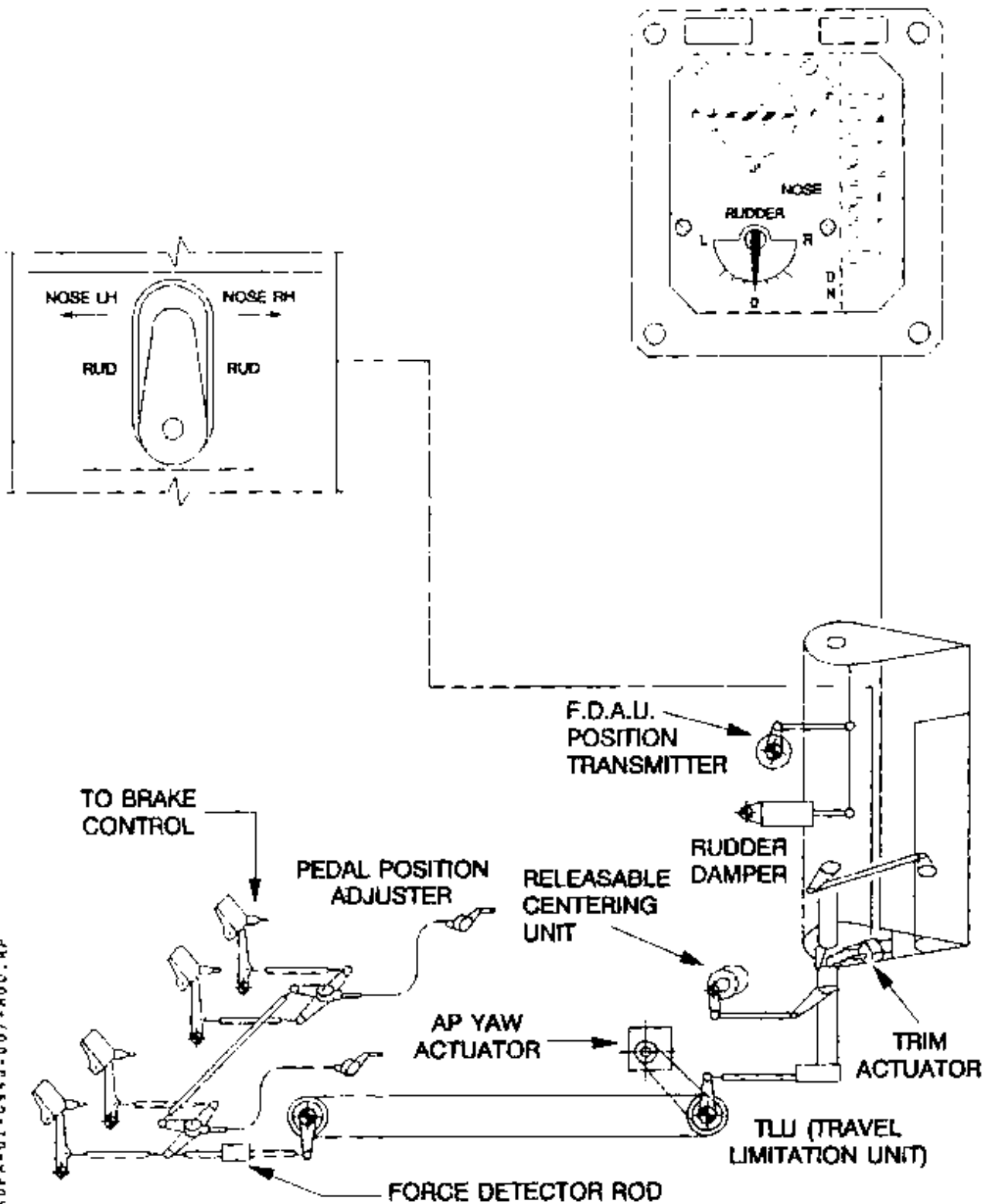

ROFA-01-C943-007-A00:AP

 AR72 F.C.O.M.	FLIGHT CONTROLS		1.09.50		
			P 1	001	
	FLAPS				DEC 96

AA

50.1 DESCRIPTION (See schematic p 5/6)

Lift augmentation is achieved on each wing by two flaps mechanically linked with a fail safe design.

The flaps control lever has three distinct positions : 0°, 15° and 30°.

It is not possible to select an intermediate position.

The lever and the flaps positions electrically control the flap valve which hydraulically actuates the four flap actuators.

Possible asymmetry is sensed by two flap position transmitters and detected by the MFC when an angle of 6.7° is reached. Then the electrical supply to the flap control system is isolated :

- The flaps stay in their present position,
- The control lever has no effect on the system up to a maintenance action.

A FLAP UNLK alert is provided to inform the crew of flaps spurious retraction. The alert is triggered if spurious retraction of more than 4° occurs.

FLAPS HYDRAULIC POWER SUPPLY

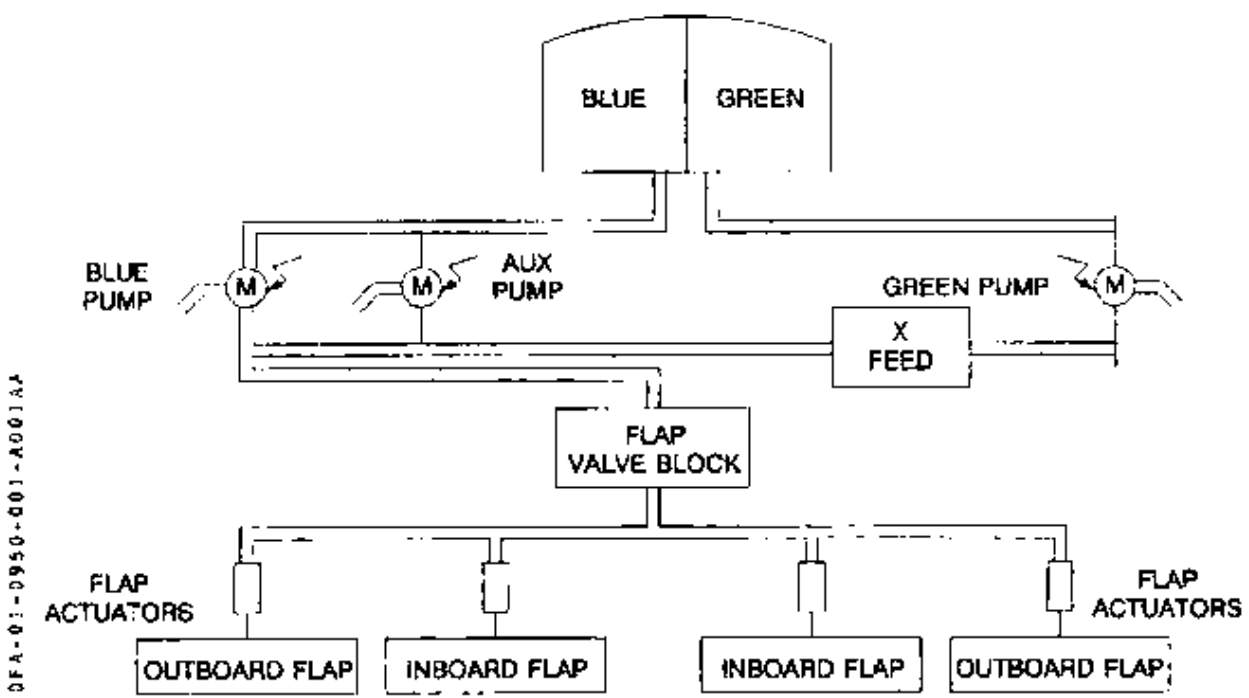

 ATR 72 F.C.O.M.	FLIGHT CONTROLS FLAPS	1.09.50		
		P 2	001	
				DEC 96

50.2 CONTROLS

FLAPS CONTROL LEVER

ROFA-01-0950-002-A001AA

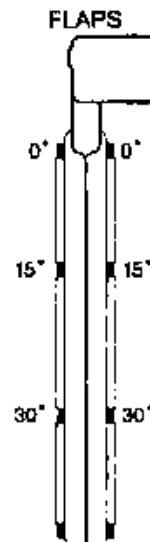
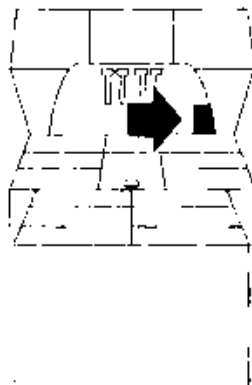

Controls the flaps operation. Distinct positions correspond to flaps 0°, 15°, 30°.

To change flaps position, pull up the lever, move it to the selected position (an amber strip at the bottom of the lever is visible as long as the lever is not in one of the three distinct positions) and release the lever.

FLAPS POSITION IND

ROFA-01-0950-002-B001AA

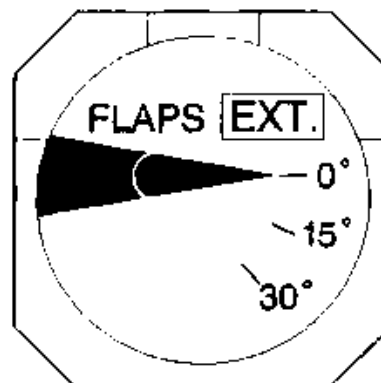

Indicates flaps position.

A blue EXT flag appears to indicate that the flap valve is hydraulically commanding flap extension.

Note : If EXT flag appears when flaps are extended, it means that there is a leak in the flaps hydraulic circuit.

FLAPS ASYM It

ROFA-01-0950-002-C001AA



FLAPS
ASYM

Illuminates amber when flaps asymmetry exceeds 6.7°.

 AR72 F.C.O.M.	FLIGHT CONTROLS		1.09.50		
	FLAPS		P 3	001	
					DEC 96

50.3 ELECTRICAL SUPPLY/MFC LOGIC/SYSTEM MONITORING

ELECTRICAL SUPPLY

EQUIPMENT	DC BUS SUPPLY (C/B)	AC BUS SUPPLY (C/B)
Flaps control and asymmetry detection	DC STBY BUS (on lateral panel CTL)	- Nil -
Flaps position ind.	- Nil -	26 VAC STBY BUS (on lateral panel POS IND)

MFC LOGIC

See chapter 1.01.

SYSTEM MONITORING

The following conditions are monitored by visual and aural alerts :

- Flaps untimely retraction of more than 4° when flaps extended.
 - See FLAPS UNLK procedure in chapter 2.05.06.
- Flaps not in appropriate TO position when PL at TO position or simulated so by the TO CONFIG TEST.
 - MW light flashing red
 - CONFIG red light and FLT CTL amber light on CAP
 - Continuous Repetitive Chime (CRC)
- Flaps asymmetry of more than 6.7° during flaps actuation.
 - See FLAP ASYM procedure in chapter 2.05.06.

Note : When wing flaps are extended, the VMO alert (clacker) operates at VFE.

VFE flaps 15° = 185 kt

VFE flaps 30° = 150 kt

 ATR72 F.C.O.M.	FLIGHT CONTROLS		1.09.50	
	FLAPS		P 4	001
			DEC 96	

7A

50.4 LATERAL MAINTENANCE PANEL

FLAPS UNLOCK TEST

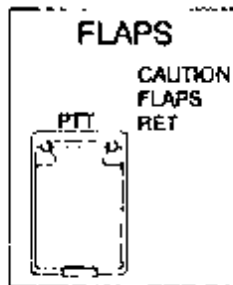

ROFA-01-0950-001-A001AA

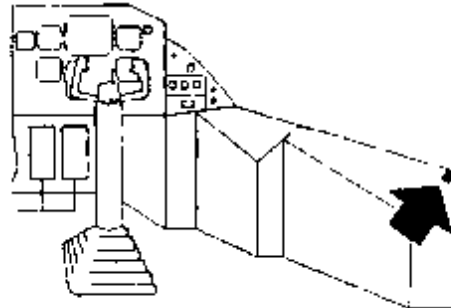

On RH lateral maintenance panel, a pushbutton is provided, for maintenance purpose only, to test "Flaps unlock" alarm relays.

Test procedure

- DC electrical power available
- Hydraulic power available
- Flaps extended to other than 0 position
- Press and hold test button

The flaps retract as long as the button is held and "Flaps unlock" warning lights up each time the flap position passes over a selectable position

- Button released : flaps come back to selected position.



AR 72
F.C.O.M.

FLIGHT CONTROLS

FLAPS

1.09.50

P 5.6

001

DFC 96

50.5 SCHEMATIC

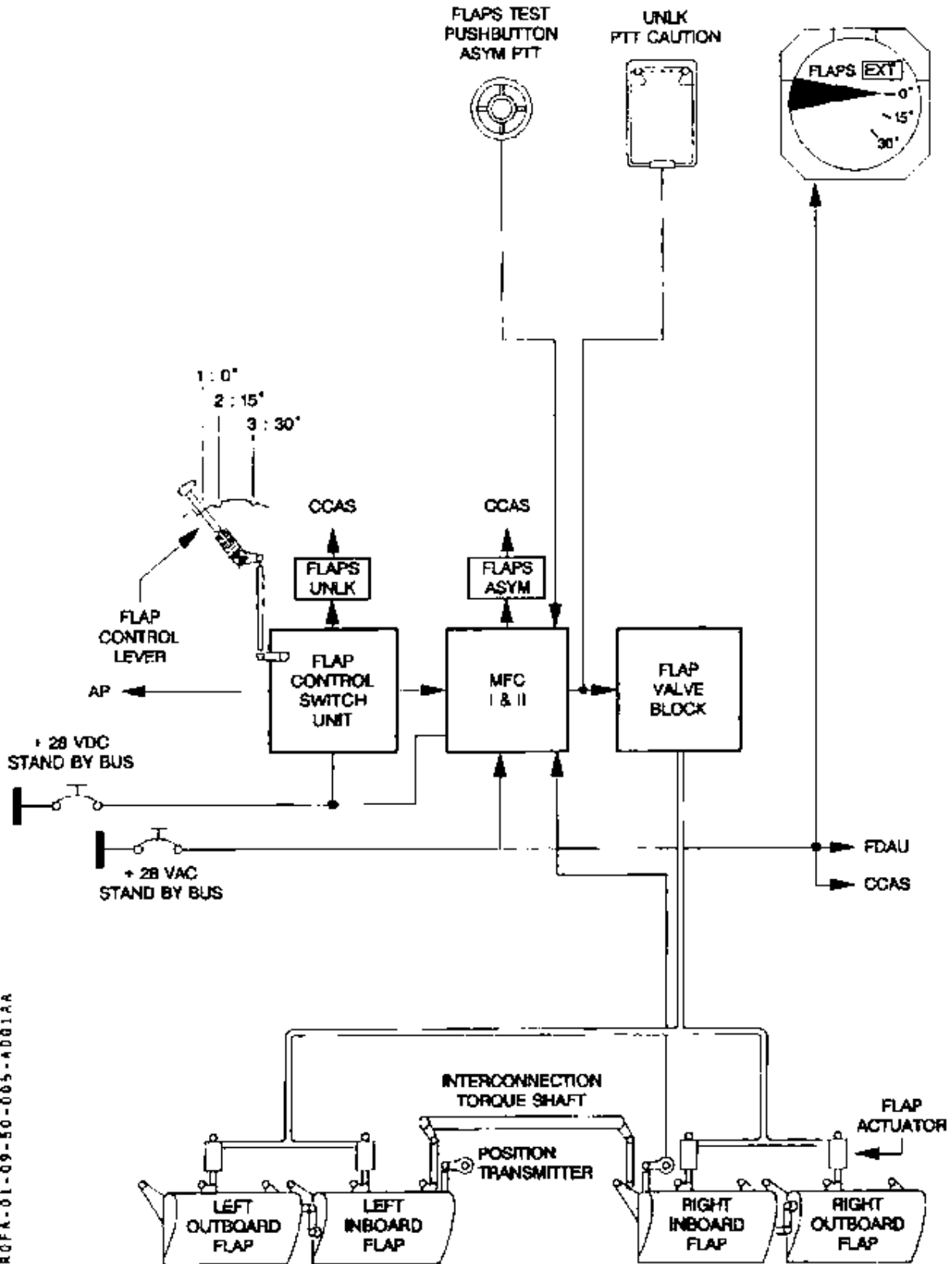

ROFA-01-09-50-005-AD01A

	FLIGHT CONTROLS		1.09.60	
	GUST LOCK		P 1	060
			JUL 00	

AA

60.1 DESCRIPTION

A gust lock system is provided to protect the pitch and roll flight controls on ground and to limit the PL travel slightly below Fl. This system includes an elevator mechanical locking device and an aileron electrico-mechanical locking device.

This system provides protection against take off with gust lock engaged, or too high power setting when in hotel mode.

ELEVATOR MECHANICAL LOCKING DEVICE

The system immobilizes the control column in pitch and therefore control surfaces. This device is controlled by a control lever located on the pedestal and mechanically operated through cables and gears.

AILERON ELECTRO MECHANICAL LOCKING DEVICE

The system is composed of two electro-mechanical locking devices immobilizing one aileron each. Each locking device is electrically actuated through switches installed on the gust lock lever.

GUST LOCK LEVER

AIL LOCK



----- MFC

ELEVATOR
LOCKING
DEVICE

AILERON
LOCKING
DEVICE

R0133-01-09-60-60: A271AY

Note : Ailerons may be locked slightly beyond the neutral position. Therefore the control wheel may be tilted ($\pm 5^\circ$), according to the actual position of ailerons.

	FLIGHT CONTROLS		1.09.60	
	GUST LOCK		P 2	060
			JUL 00	

AA

60.2 CONTROLS

GUST LOCK LEVER

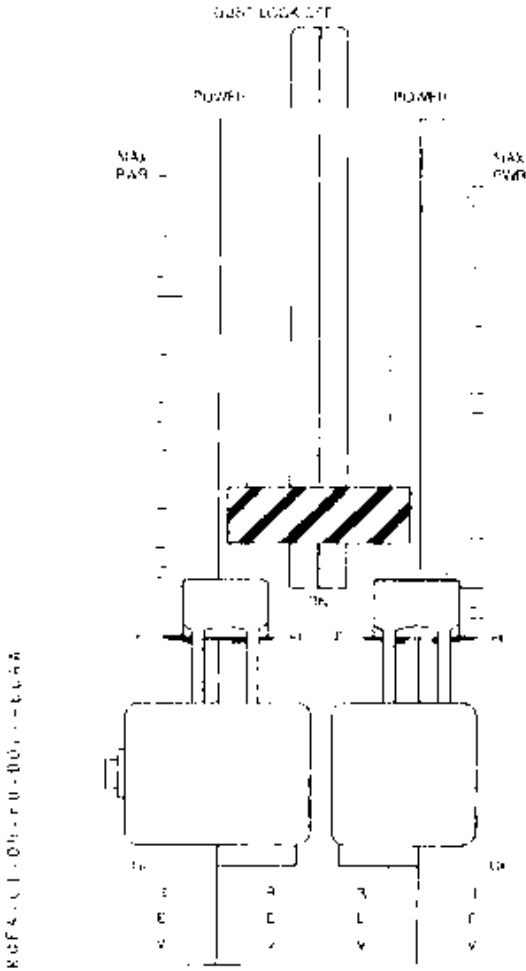

When the gust lock is engaged, the PL travel is limited slightly below FI to provide protection against take off and two high power setting when in hotel mode. The gust lock handle can be put into the locking notch whatever the position of the flight controls but these controls must be brought to neutral to positively engage the locking devices.

AIL LOCK II

REV 001 - 01/01/00 - 001 - 001 - 001

AIL LOCK



Illuminates amber and the CCAS is activated through the MFC whenever one of the locking actuators is in disagreement with the gust lock lever position (Lock or unlock position).

	FLIGHT CONTROLS GUST LOCK	1.09.60		
		P 3	060	
				JUL 00

AA

60.3 ELECTRICAL SUPPLY/MFC LOGIC/SYSTEM MONITORING

ELECTRICAL SUPPLY

EQUIPMENT	DC BUS SUPPLY (C/B)
Aileron lock ind.	DC EMER BUS (on lateral panel AIL TRIM & AIL LOCK WARN)
Aileron lock CTL	DC ESS BUS (on lateral panel GUST LOCK AIL)

MFC LOGIC

See chapter 1.01.

SYSTEM MONITORING

The following conditions are monitored by visual and aural alerts.

- Disagree between Aileron locking actuators and gust lock control (Temporized alert 8 sec).
 - . "MC" flashing amber
 - . "FLT CTL" amber light illuminates on CAP
 - . "AIL LOCK" amber light illuminates on the pedestal
 - . Aural alert is single chime (SC)

- Aileron locking actuators not fully retracted and PL on TO position
 - . "MW" flashing red
 - . "CONFIG" red light illuminates on CAP
 - . "FLT CTL" amber light illuminates on CAP
 - . Aural alert is Continuous Repetitive Chime (CRC)

- R - Disagree between Aileron locking actuators and gust lock control during the T.O.
- R CONFIG TEST.
- R . "MW" flashing red
- R . "CONFIG" red light illuminates on CAP
- R . "FLT CTL" amber light illuminates on CAP
- R . Aural alert is Continuous Repetitive Chime (CRC)

	FLIGHT INSTRUMENTS	1.10.00		
	CONTENTS	P 1	001	
				DEC 96

AA

1.10.00 CONTENTS

1.10.10 AIR DATA SYSTEM

- 10.1 DESCRIPTION
- 10.2 CONTROLS
- 10.3 ELECTRICAL SUPPLY/SYSTEM MONITORING
- 10.4 SCHEMATIC

1.10.20 ATTITUDE AND HEADING REFERENCE SYSTEM (AHRS)

- 20.1 DESCRIPTION
- 20.2 CONTROLS
- 20.3 ELECTRICAL SUPPLY/SYSTEM MONITORING

1.10.30 ELECTRONIC FLIGHT INSTRUMENT SYSTEM (EFIS)

- 30.1 DESCRIPTION
- 30.2 CONTROLS
- 30.3 ELECTRICAL SUPPLY
- 30.4 SCHEMATIC

1.10.40 CLOCKS

- 40.1 DESCRIPTION
- 40.2 CONTROLS
- 40.3 ELECTRICAL SUPPLY

1.10.50 FLIGHT RECORDERS

- 50.1 DESCRIPTION
- 50.2 CONTROLS
- 50.3 ELECTRICAL SUPPLY

	FLIGHT INSTRUMENTS	1.10.10		
		P 1	030	
	AIR DATA SYSTEM			JUL 01

AA

10.1 DESCRIPTION

(See schematic p 13/14)

The flight environment data are provided by three independent air data systems :

- two main systems,
- one standby system.

MAIN SYSTEMS

Aircraft is equipped with two independent AIR DATA COMPUTERS (ADC). Each computer is supplied with :

- static air pressure provided by its specific static ports,
- total air pressure provided by its specific pitot probe,
- total air temperature provided by its specific TAT probe.

Probes and ports are located on the LH and RH side of the fuselage and are electrically heated.

From this data, each ADC computes :

- pressure altitude,
- vertical speed,
- indicated air speed (IAS),
- true air speed (TAS),
- total air temperature (TAT),
- static air temperature (SAT).

ADC 1 supplies :

- CAPT flight instruments (altimeter, airspeed ind., vertical speed ind.).
- other systems : AHRS 1, FDAU, ATC 1, MFC, GPWS, pressurization, AFCS ATC 1 and ATC 2 through TCAS controller box and TCAS through ATC 1 and ATC 2 (if installed and mode S only).

ADC 2 supplies :

- F/O flight instruments (altimeter, airspeed ind., vertical speed ind.).
- other systems : AHRS 2, FDAU, MFC, pressurization, AFCS, ATC 1 and ATC 2.

Note : If ATC 2 mode S is installed, ADC 2 supplies TCAS through ATC 1 and ATC 2.

EEC's, TAT/SAT/TAS indicator and GPS (if installed) are supplied either by ADC 1 or ADC 2 according to ADC selector on capt panel.

STANDBY SYSTEM

The standby system consist of :

- two static ports,
- a pitot probe.

Standby airspeed ind. and standby altimeter are directly supplied by raw data.

	FLIGHT INSTRUMENTS	1.10.10	
	AIR DATA SYSTEM	P 2	001
		DEC 96	

10.2 CONTROLS

AIRSPEED IND

RDEA-D: -10-10-002-A001AA

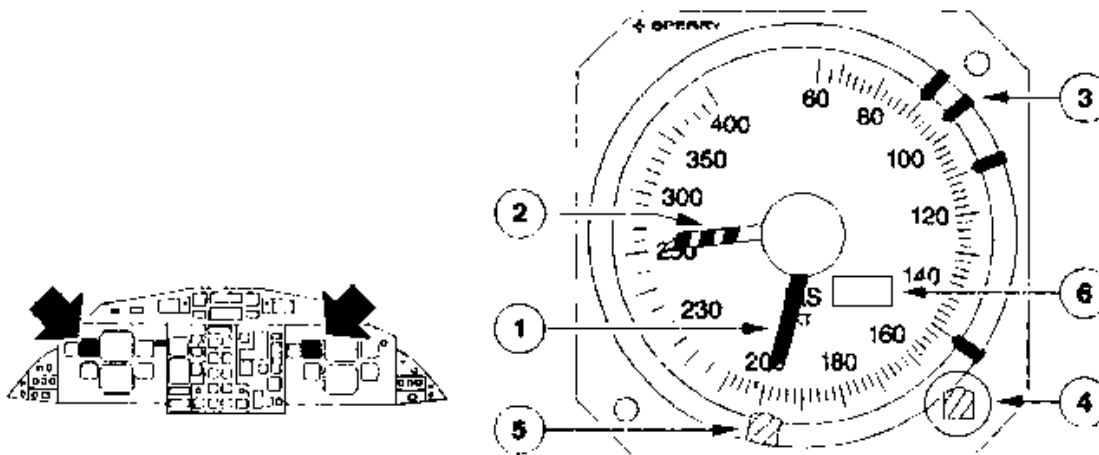

① Airspeed pointer

IAS is displayed by a pointer on a scale graduated from 60 to 400 kts :
 in 2 kts increments from 70 to 210 kts,
 in 5 kts increments from 210 to 250 kts,
 in 10 kts increments from 250 to 400 kts.

② VMO pointer

The red and white striped pointer indicates the max airspeed computed by the associated ADC which represents VMO/MMO limit. An aural warning (clacker) will be generated by the CCAS if this value is exceeded.

③ Movable indices (BUGS)

The four coloured bugs enable predetermined speeds to be manually set.

④ Speed selector

This knob is used to select a desired speed during a given phase of flight (ie final approach speed). The selected speed is indicated by the speed bug (5) and controls the reference on the EADI FAST/SLOW scale.

⑤ Speed bug

Indicates the selected speed.

⑥ OFF/Red flags

A failure affecting the VMO channel causes the red VMO flag to come into view. A failure affecting the airspeed indicator and the VMO channel causes the red OFF warning flag to come into view.

	FLIGHT INSTRUMENTS	1.10.10		
	AIR DATA SYSTEM	P 3	001	
				DEC 96

AA

STANDBY AIRSPEED IND

ROFA-01-10-10-003-ADD1A4

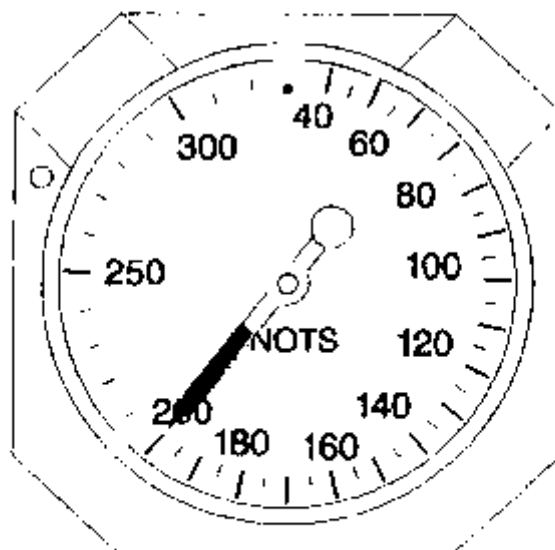
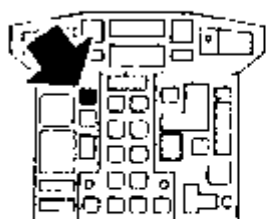

Displays the airspeed as calculated from standby static and standby pitot pressures.
 The scale is graduated from 40 to 320 kt :
 in 5 kt increments from 40 to 200 kt
 in 10 kt increments from 200 to 320 kt

	FLIGHT INSTRUMENTS	1.10.10		
		P 4	001	
	AIR DATA SYSTEM			DEC 96

AA

ALTIMETERS

R0F4-01-10-10-004-A001A

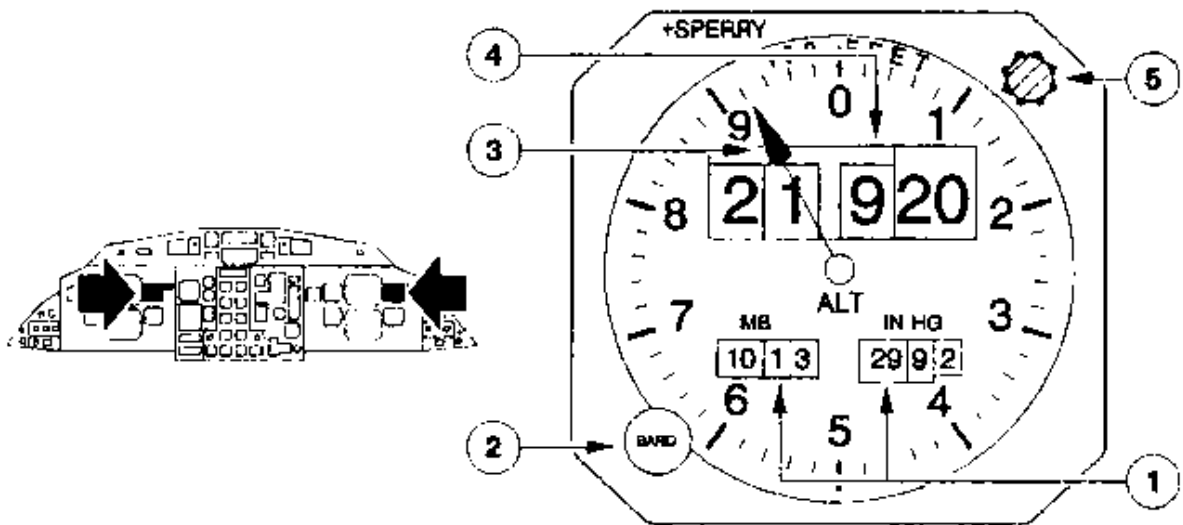

① MB and INHG counters

Display baroset value in millibars (948 to 1049 mb) and inches Hg (28 to 30.99 in Hg).

② BARO knob

Sets the barometric reference in the MB and in the IN HG counters.

③ Altitude pointer

One revolution of the pointer represents a 1000 ft altitude change.

④ Altitude counter

The digital counter is equipped with four drums indicating in ten thousands, thousands, hundreds and twenties feet increments :

- Black and white flag covers the LH drum (ten thousands) when altitude is between 0 and 9999 ft.
- NEG black flag covers the two LH drums (ten thousands and thousands) when altitude is below 0 feet.
- OFF red flag covers counter in case of ADC failure, indicator failure or power failure.

⑤ Altitude alert It

Illuminates amber when altitude alert is triggered.

AA

STANDBY ALTIMETER

ROFA-01-10-10-305-A001A

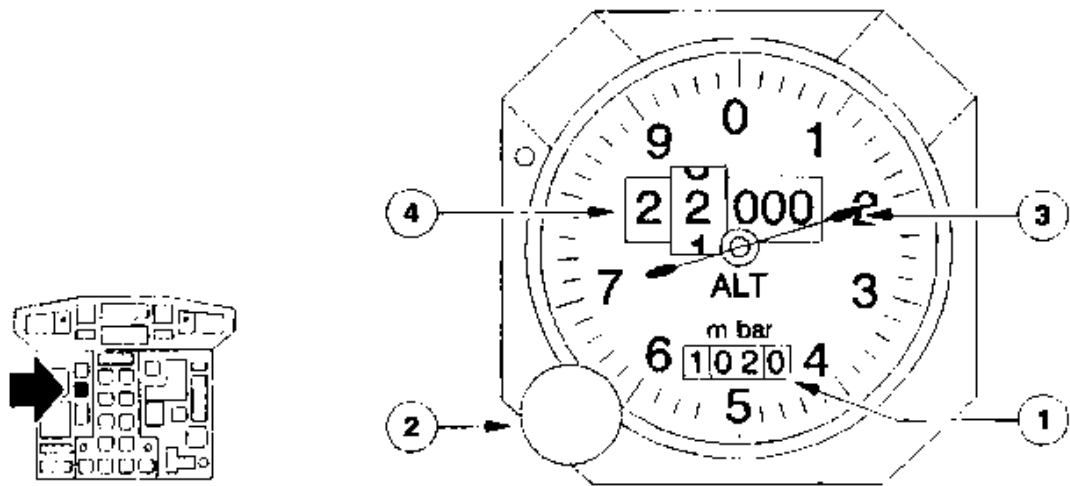

- ① *Baroset value is displayed in millibars (875 to 1 050 mb).*
 - ② *Baroset knob*
Sets barometric reference on mb counter.
 - ③ *Altitude pointer*
One revolution of pointer represents 1000 ft altitude change.
 - ④ *Altitude counter*
The digital counter is equipped with three drums indicating ten thousands, thousands and hundreds of feet. A black and white flag marks the LH drum (ten thousands) when altitude is between 0 and 9999 ft. An orange and white flag marks the two LH drums (ten thousands and thousands) when altitude is below 0 ft.
- Note : Allowable deviation between normal altimeter indications and between normal and standby altimeter indications :*

	FL (ft)	NORM/NORM (ft)	NORM/STBY (ft)
R	0	55	70
R	5.000	60	150
R	10.000	70	200
R			
R	20.000	100	260
R	25.000	120	300

	FLIGHT INSTRUMENTS	1.10.10	
	AIR DATA SYSTEM	P 6	030
			JUL 01

4A

TCAS VERTICAL SPEED INDICATOR (TCAS V_{SI}) (cf. 1.05.20)

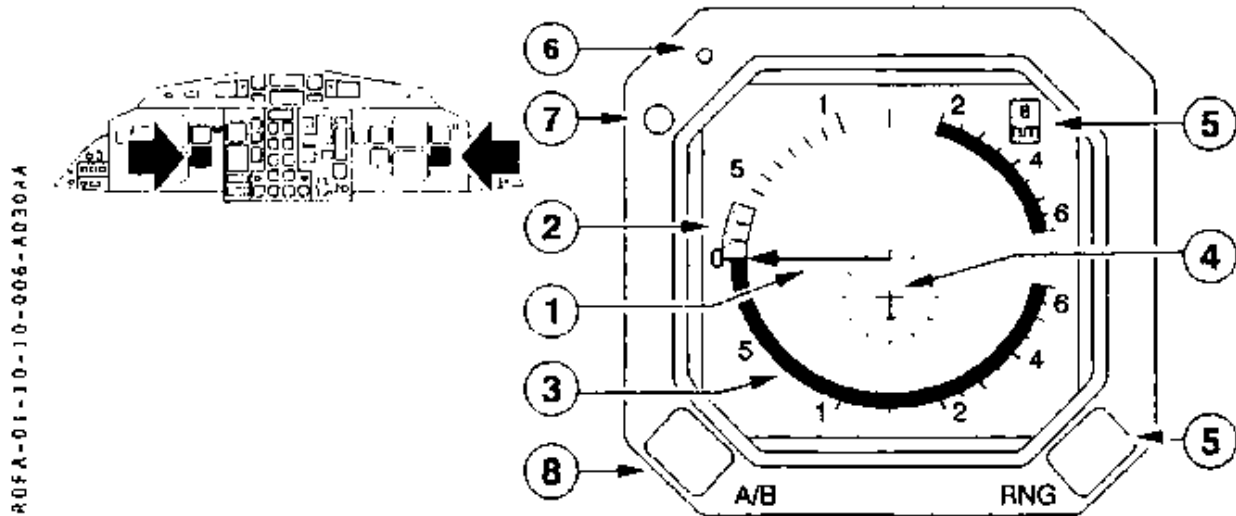

- (1) - Vertical speed pointer
Indicates rate of climb/descent from 0 to $\pm 6\ 000$ ft/mn.
- (2) - Vertical speed recommended arc (green)
Green arc indicates vertical speed range to fly in.
- (3) - Vertical speed prohibited arc (red)
Red arc indicates that pilot is advised to fly out of, or not enter, indicated vertical speed range.
- (4) - Fixed aircraft mock-up
The fixed aircraft mock-up is surrounded with a 2 mn loop.
- (5) - Display range selection
The following ranges for the sextant TCAS indicator are recommended :
 - Select the 6 nautical mile range for take-off, low altitude climb, approaches and landings
 - Select the 12 nautical mile range for high altitude cruise. The range selected has no effect on the TCAS system logic used to determine TA's and RA's.
- (6) - Test
When depressed, indicator will display a test pattern.
- (7) - Light sensor
- (8) - Extended altitude surveillance status
When selected ABV or BLW
 - ABV viewing of traffic from 2 700 ft below to 9 900 ft above
 - BLW viewing of traffic from 2 700 ft above to 9 900 ft below.
 In normal position, viewing of traffic from 2700 ft below to 2700 ft above.

R0FA-01-10-10-006-AD30AA

 AJR 72 F.C.O.M.	FLIGHT INSTRUMENTS	1.10.10	
	AIR DATA SYSTEM	P 6	040
			DEC 97

AA

TCAS VERTICAL SPEED INDICATOR (TCAS FUNCTION NOT AVAILABLE)

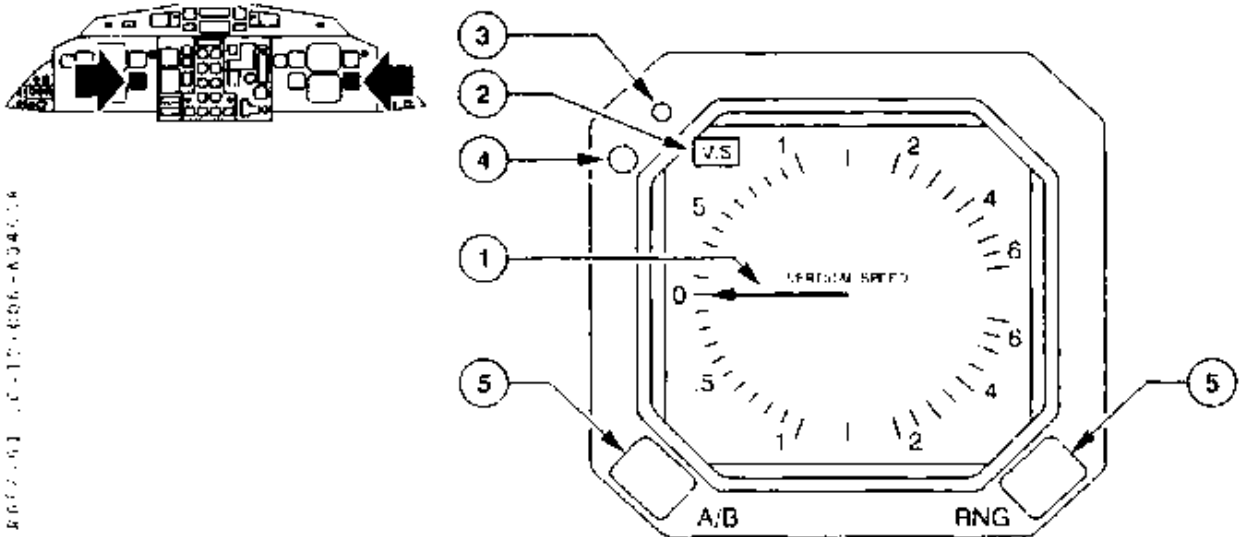

R662-01 10-10-10-040

① Vertical speed pointer

Indicates rate of climb/descent from 0 to ± 6000 ft/mn.

From 0 to 1000 ft/mn the scale is graduated in 100 ft/mn increments, and from 1000 to 6000 ft/mn in 500 ft/mn increments. Display accuracy is ± 40 ft/mn.

② Vertical speed flag

Appears if the indicator is not able to display vertical speed information
In that case, the vertical speed pointer disappears when V/S flag appears.

③ Test

When depressed, indicator will display a test pattern.

④ Light sensor

⑤ Not available

 A320neo F.C.O.M.	FLIGHT INSTRUMENTS	1.10.10	
		P 7	030
	AIR DATA SYSTEM		JUL 01

AA

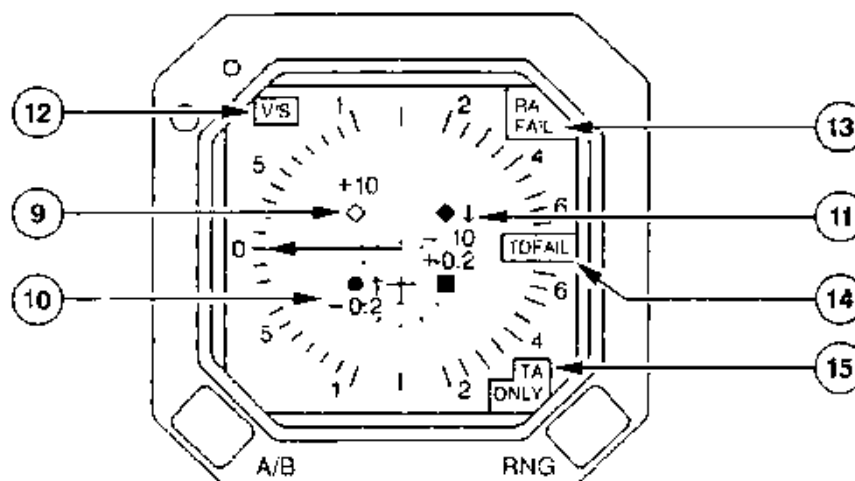

R052-03-10-10-007-401014

- ⑨ Intruder symbol
- TCAS RA : filled square (red)
 - TCAS TA : filled circle (amber)
 - Proximity : filled diamond (Cyan)
 - Others : blank diamond (Cyan)
- Center of the symbol shows the intruder relative position.
- ⑩ Intruder relative altitude
- Value : two digits (color of the associated symbol)
 - Unit : ft x 100
 - Sign : - positive = the intruder is above
- negative = the intruder is below
- ⑪ Relative vertical speed indicator
- Arrow to the top : intruder climbing
 - Arrow to the bottom : intruder descending
- ⑫ Vertical speed flag
- Appears if the indicator is not able to display vertical speed information
 - In that case, the vertical speed pointer disappears when V/S flag appears.
- ⑬ Resolution advisory flag
- Appears only if the indicator is not able to display RA's or vertical speed.
- ⑭ Traffic function flag
- If the indicator is not able to display intruder's, "TD FAIL" appears
or
 - when the TCAS is in STBY mode, "TCAS OFF" appears
or
 - in case of TCAS fails, "TCAS FAIL" appears
or
 - in case of self test activation, "TEST" appears.
- ⑮ "TA ONLY" indication
- This flag appears if the TCAS is in "TA ONLY" mode.

 ATR 72 F.C.O.M.	FLIGHT INSTRUMENTS AIR DATA SYSTEM	1.10.10		
		P 9	001	
				DEC 96

AA

LEFT INTENTIONALLY BLANK

	FLIGHT INSTRUMENTS		1.10.10	
	AIR DATA SYSTEM		P 10	050
			JUN 97	

TAT-SAT/TAS IND

R0FA-01-10-10-010-A050AA

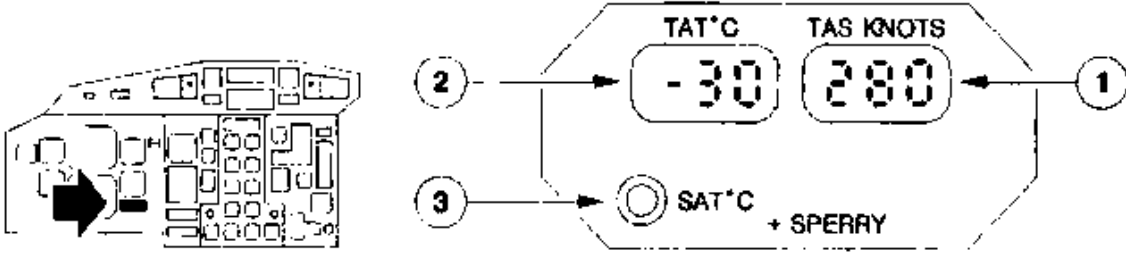

TAS, TAT and SAT indications are those computed by the selected ADC.

① TAS ind.

Indicates True Air Speed as three digits from 068 kt to 600 kt. When selected ADC signal is not valid, the ind. displays ---.

② TAT ind.

Indicates total Air Temperature in °C as three digits, the first being + or -. When selected ADC signal is not valid, the ind. displays ---.

③ SAT pb

When depressed and held, the Static Air Temperature in °C is displayed in the TAT window.

ADC SW

R0FA-01-10-10-010-B050AA

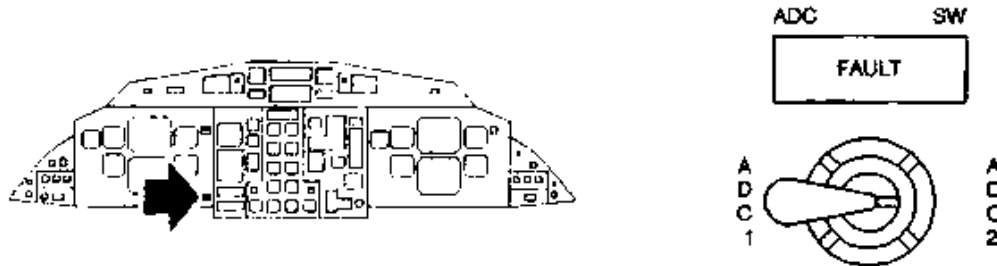

- ADC sw allows to feed both EEC, TAT/SAT/TAS indicator and GPS (if installed) either from ADC 1 or from ADC 2.
- "FAULT" illuminates if ADC selection does not match switch position.

	FLIGHT INSTRUMENTS	1.10.10		
		P 11/12	070	
	AIR DATA SYSTEM			JUN 97

AA

10.3 ELECTRICAL SUPPLY/SYSTEM MONITORING

ELECTRICAL SUPPLY

EQUIPMENT	DC BUS SUPPLY (C/B)	AC BUS SUPPLY (C/B)
ADC 1/ADC 2	HOT EMER BAT BUS (Back-up on overhead panel ADC 1/2 HOT) DC EMER BUS (primary on overhead panel ADC 1/2 EMER)	- Nil -
CAPT airspeed ind. and vertical speed ind. TAS/Temperature ind.	- Nil -	26 VAC STBY BUS (on overhead panel ASI VSI ALTM)
CAPT altimeter + recording FDAU	- Nil -	26 VAC STBY BUS (on overhead panel ALTM)
F/O airspeed ind. and vertical speed ind.	- Nil -	26 VAC BUS 2 (on overhead panel ASI VSI)
F/O altimeter	- Nil -	26 VAC BUS 2 (on overhead panel ALTM)
Standby altimeter vibrator	DC BUS 1 (on overhead panel STBY ALTM)	- Nil -

SYSTEM MONITORING

The following conditions are monitored by visual alerts :

- Loss of ADC
 - See ADC FAULT procedure in chapter 2.05.12
- Incorrect ADC switching
 - See ADC SW FAULT procedure in chapter 2.05.12

10.4 SCHEMATIC

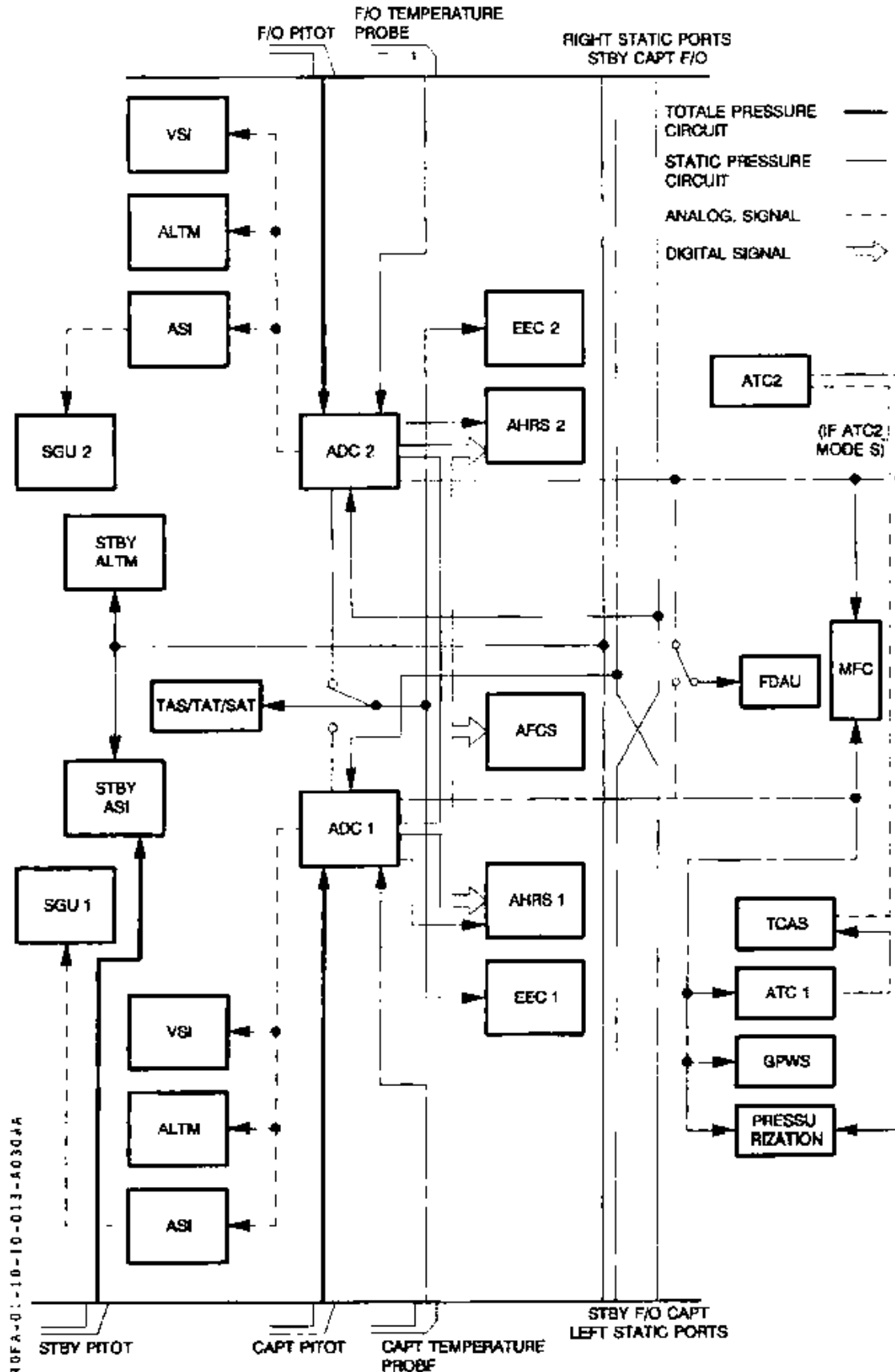

	FLIGHT INSTRUMENTS ATTITUDE HEADING REFERENCE SYSTEM	1.10.20		
		P 1	001	
				DEC 96

AA

20.1 DESCRIPTION

The attitude and heading data are provided by :

- Two main systems (AHRS)
- Standby instruments

AHRS

AHRS consists of :

- Two attitude - heading reference units, (AHRU)
- Two flux valves
- One dual remote compensator

Each AHRU includes an inertial measurement unit (IMU), a microprocessor and electronic controls. The IMU components, three gyrometers and three accelerometers are aligned with the aircraft axes as a strapdown system. Earth rotation and gyro drift are computed without requiring heading, latitude or variation insertion.

Each AHRU receives inputs from its associated flux valve.

TAS, fed by both ADC, is used to compute gyro erection.

AHRU sends attitude and heading signals to indicators, AFCS, weather radar and FDAU.

Vertical accuracy remains within $\pm 1.4^\circ$, heading accuracy within $\pm 2^\circ$.

AHRS 1 supplies :

- SGU 1 (attitude and heading)
- F/O RMI (heading)
- FDAU (attitude - heading)
- Radar (attitude)
- ASCB bus

AHRS 2 supplies :

- SGU 2 (attitude and heading)
- CAPT RMI (heading)
- ASCB bus

 ATR 72 F.C.O.M.	FLIGHT INSTRUMENTS		1.10.20		
			P 2	001	
	ATTITUDE HEADING REFERENCE SYSTEM				DEC 96

STANDBY INSTRUMENTS

STANDBY HORIZON

A stand-by electrical horizon is provided on the central panel.

STANDBY COMPASS

A retractable standby magnetic compass with internal lighting is provided under glareshield.

RADIO MAGNETIC IND (RMI)

An RMI is installed on each pilot's panel coupled to the opposite AHRS. Each includes a compass rose, showing magnetic heading, two pointers with "rabbit ears" switching to present either VOR or ADF bearings.

- In case of RMI internal failure or AHRS supply loss :

- RED "OFF" flag appears
- ADF needle displays only relative bearing to station (without indication of magnetic bearing).
- VOR needle displays magnetic bearing to station on rose card (no metter when the card is frozen). Relative bearing info is lost.

Note : However, validity of these information should be confirmed.

- In case of navigation system indication failure or data supply failure, the associated pointers move to 3 o'clock position except the double pointer when ADF is selected (9 o'clock position).

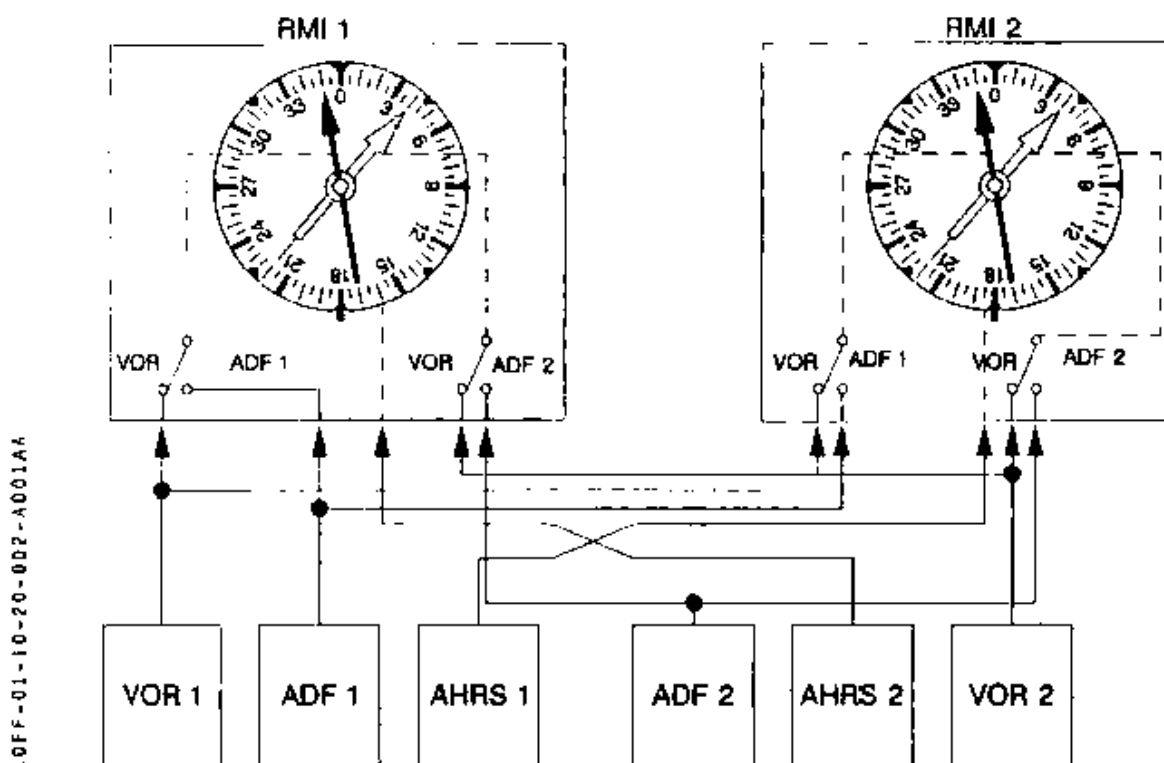

	FLIGHT INSTRUMENTS ATTITUDE HEADING REFERENCE SYSTEM	1.10.20	
		P 3	001
			DEC 96

20.2 CONTROLS

AHRS ERECT PB

2011-01-10-20-003-8001AA

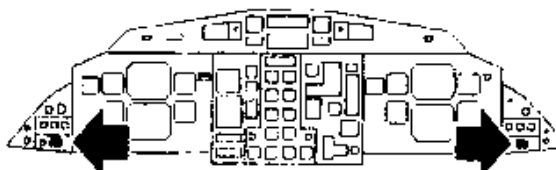
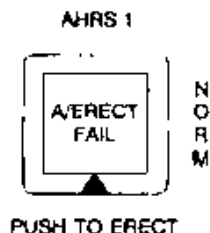

Illuminates amber when the associated AHRS loses the TAS signal from the ADC. The AHRS will continue to operate without auto-erect capability. If the aircraft is stabilized (unaccelerated level flight) a gyro fast erection may be performed by depressing the associated pb for 15 s. When released, the pb remains illuminated as long as the TAS signal is lost

RMI

R0FF-01-10-20-003-8001AA

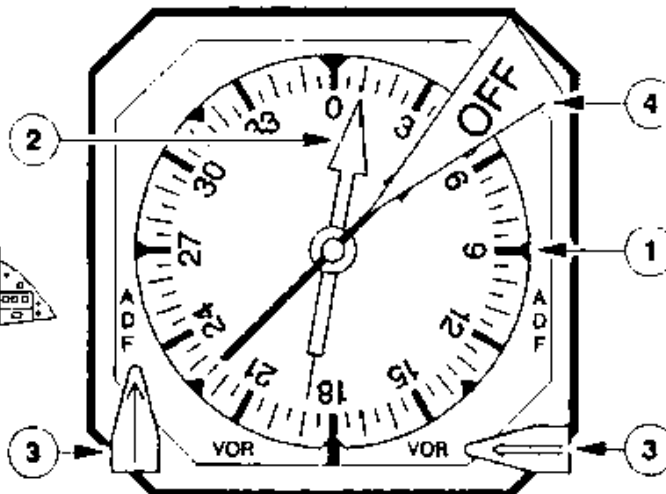

- ① Compass card
Displays heading information on a rotating heading dial graduated in 5 degree increments.
- ② Bearing pointers
Indicate the magnetic bearing to the station selected by the associated VOR/ADF selector.
- ③ VOR/ADF selectors
Select the stations (VOR or ADF) associated to the bearing pointers.
- ④ Red "OFF" flag
Appears in case of RMI internal failure or AHRS supply loss



AR72
F.C.O.M.

FLIGHT INSTRUMENTS

ATTITUDE HEADING REFERENCE SYSTEM

1.10.20

P 4

001

DEC 96

LEFT INTENTIONALLY BLANK

	FLIGHT INSTRUMENTS		1.10.20	
			P 5	001
	ATTITUDE HEADING REFERENCE SYSTEM			DEC 96

STANDBY HORIZON

ROFF-01-10-20-005-A001AA

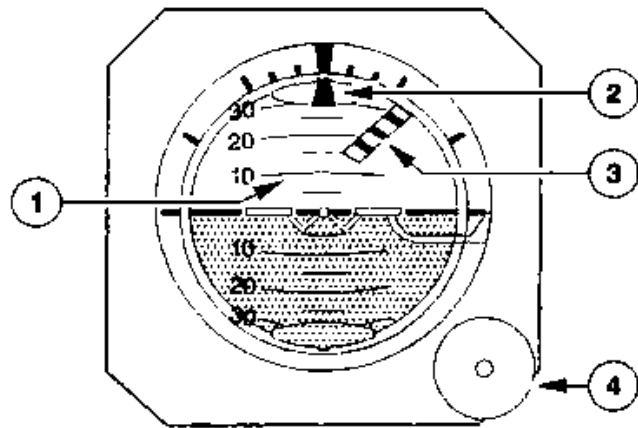
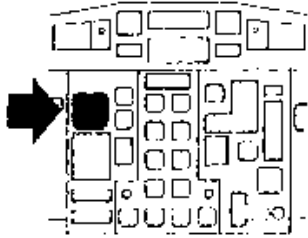

- ① Attitude Sphere
Marked every 5 degrees of pitch axis, to ± 80 degrees.
Roll angle is given by a scale marked at 10, 20, 30, 60 and 90 degrees.
- ② Aircraft Symbol
Orange, represents the aircraft position on the attitude sphere.
- ③ Red/black flag
Appears when electrical supply is lost, or when gyroscope speed becomes insufficient.
- ④ Setting knob
When pulled, causes a rapid erection if the instrument is powered.

STANDBY COMPASS

ROFF-01-10-20-005-B001AA

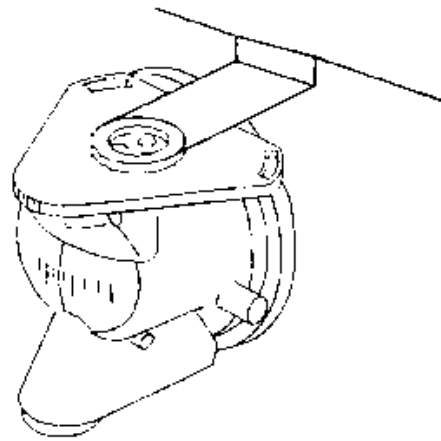
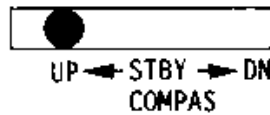
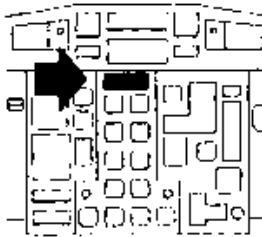

Hidden in up position. Compass control should be placed on DN for use. The compass rose is graduated in 10 degree increments.

	FLIGHT INSTRUMENTS ATTITUDE HEADING REFERENCE SYSTEM	1.10.20		
		P 6	001	
				DEC 96

20.3 ELECTRICAL SUPPLY/SYSTEM MONITORING

ELECTRICAL SUPPLY

EQUIPMENT	DC BUS SUPPLY (C/B)	AC BUS SUPPLY (C/B)
AHRS 1 power supply	DC EMER BUS (on overhead panel NORM)	- Nil -
AHRS 1 aux power supply	DC BUS 2 (on overhead panel AUX)	- Nil -
AHRS 2 power supply	DC BUS 2 (on overhead panel NORM)	- Nil -
AHRS 2 aux power supply in flight	DC BUS 1 (on overhead panel FLT)	- Nil -
AHRS 2 aux power supply on ground	DC EMER BUS (on overhead panel GND)	- Nil -
CAPT RMI	DC BUS 2 (on overhead panel 28 VDC)	26 VAC BUS 2 (on overhead panel 26 VAC)
F/O RMI	DC STBY BUS (on overhead panel 28 VDC)	26 VAC BUS (on overhead panel 26 VAC)
Standby horizon power supply	DC ESS BUS (on overhead panel NORM STBY HORIZON)	- Nil -
Standby horizon aux power supply	HOT EMER BAT BUS (on overhead panel AUX STBY HORIZON)	- Nil -

SYSTEM MONITORING

The following conditions are monitored by visual and aura alerts :

- One AHRS loses TAS input from both ADC.
 - See AHRS A/EFFECT FAIL procedure in chapter 2.05.12.
- AHRS disagree.
 - See EFIS COMP procedure in chapter 2.05.12.
- Loss of AHRS
 - See AHRS FAIL procedure in chapter 2.05.12.

	FLIGHT INSTRUMENTS EFIS	1.10.30		
		P 1	001	
				DEC 96

30.1 DESCRIPTION (See schematic p 17/18)

The EFIS (Electronic Flight Instruments System) is an electronic system which processes data supplied by different sources (AHRS, ASI, Navigation equipment) and displays them on two Cathodic Ray Tubes (CRT) in front of each pilot.

For each pilot, the system consists of :

- Two CRTs located on the front panel
 - Top one is EADI (Electronic Attitude Director Indicator)
 - Bottom one is EHSI (Electronic Horizontal Situation Indicator)
- One ECP (EFIS Control Panel) located on pedestal which enables flight crew to select EFIS modes and screen brightness.
- One SGU (Symbol Generator Unit)
 - Which processes attitude, air and navigation data, and changes them into video signals, sent to EADI and EHSI according to the modes selected by ECP.
- One FD bar command switch on the glareshield panel

The system also comprises, for both pilots :

- One CRS/HDG panel for captain side used to select heading on both EHSI and course on left hand side EHSI.
- One ALT/CRS panel for F/O side used to select altitude on AP/FD system and course on right hand side EHSI.
- One weather Radar Control Panel used to select the range scale on EHSI. In arc mode, weather radar information is displayed on EHSI (see 1.15.50).

SGU

Each SGU comprises three main parts.

A Data input

Part acquiring data from attitude, heading and navigation systems.

B - ASCB Input/Output

Part sending and receiving data from the ASCB bus, enabling exchange of data with the other pilot's system.

C - Symbol Generation

Part generating the picture sent to CRTs.

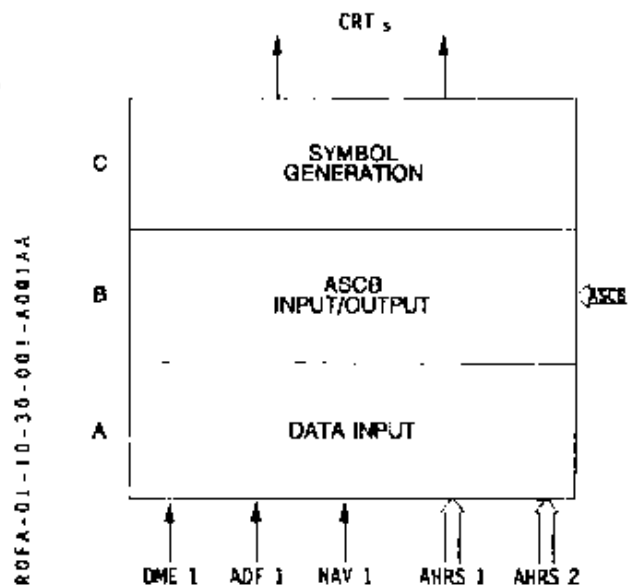

	FLIGHT INSTRUMENTS EFIS	1.10.30		
		P 2	001	
				DEC 96

30.2 CONTROLS

EADI

EADI displays short term information.

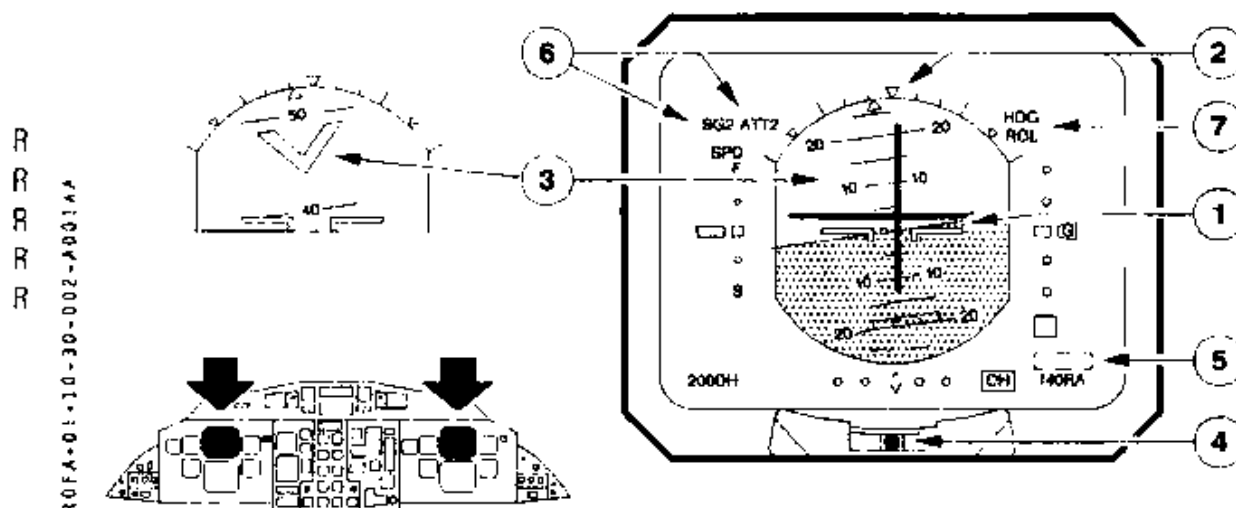

- ① Aircraft Symbol
Fixed symbol of the aircraft. Aircraft pitch and roll attitudes are displayed by the relationship between this symbol and the movable horizon.
FD command bars also move in relation to the aircraft symbol, according to the FD selected mode.
- ② Roll attitude (white)
Displays actual roll attitude through a movable index and fixed scale reference marks at 0, 10, 20, 30, 45 and 60 degrees.
- ③ Horizon and pitch scale
Both move with respect to the aircraft symbol to display actual pitch and roll attitude. Sky zone is colored blue, earth zone brown. In case horizon line goes out of view a blue or brown "eyebrow" is displayed in the upper or lower section of the sphere. Pitch scale is white and has reference marks at 5, 10, 15, 20, 30, 40 and 60 degrees nose up, and at 5, 10, 15, 20, 30, 45, and 60 degrees nose down. Above 40° nose up and below 30° nose down, red arrows come into view.
- ④ Slip indicator
Provides the pilot with an indication of non coordinated flight.
- ⑤ AP MSG annunciator
See chapter 1.04.10.
- ⑥ Cross Switching annunciators
See sources switching panel.
- ⑦ Cross comparison
See chapter 1.10.30 p 12.

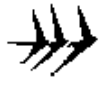
 A320 F.C.O.M.	FLIGHT INSTRUMENTS EFIS	1.10.30		
		P 3	001	
				DEC 96

AA

R
R
R
R
R

R0FA-01-10-30-003-ADD14A

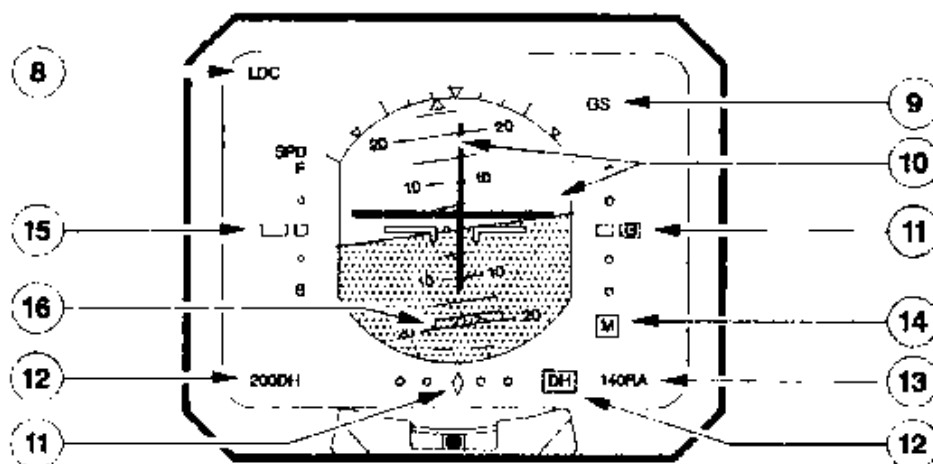

⑧ Lateral ARM & CAPTURE

See chapter 1.04.10.

⑨ Vertical ARM 1 CAPTURE

See chapter 1.04.10

⑩ Flight Director Command bars (magenta)

Display computed commands to capture and maintain a desired flight path. The commands are satisfied by flying the aircraft symbol to the command bars.

⑪ Glideslope and Localizer indication

- Deviation from ILS glideslope is indicated by an index on a scale which is marked by dots.
- Deviation from localizer is indicated by an index on a scale which is marked by dots.

Note : Indexes and scales are visible only when an ILS frequency is selected on the related NAV control box.

⑫ DH indication and annunciator

- Displays the selected decision height in feet (blue), and the "DH" letters in white. When selected DH is set to zero, DH information disappears from EADI. Maximum selectable Decision Height is 990 ft. When aircraft radio-altitude reaches selected decision height + 100 ft, a white box appears near the radio altitude information on EADI. When aircraft radio-altitude becomes lower than selected decision height, the amber "DH" symbol illuminates inside the white box.

⑬ Radio altitude indication

Displays in blue the radio-altitude and in white the RA letters. When radio-altitude indication is not valid, this information is replaced by amber dashes.

Range of readable radio-altitude is from — 20 ft to 2500 ft.

Above 2500 ft, radio altitude information is not displayed. See chapter 1.15.30.

 ATR 72 F.C.O.M.	FLIGHT INSTRUMENTS EFIS	1.10.30		
		P 4	001	
				DEC 96

AA

⑭ Marker beacon information

A white box appears below the glide slope deviation scale as soon as a LOC frequency is selected on the related NAV control box.

- OUTER MARKER : Detection of the Outer Marker causes a blue "O" to be displayed inside the white box.
- MIDDLE MARKER : Detection of the Middle Marker causes an amber "M" to be displayed inside the white box.
- INNER MARKER : Detection of the Inner Marker causes a white "I" to be displayed inside the white box.

Note : When a VOR frequency is selected, no marker box is visible. However, when a marker beacon is overflown, the marker box and indication appear simultaneously.

⑮ FAST/SLOW indicator

A green scale on left hand side of the EADI indicates the difference between speed selected thanks to the speed bug on the related airspeed ind, and actual aircraft speed. A white index moves up (FAST) or down (SLOW) according to the deviation.

	DEVIATION > + 25 kts : index not visible
	+ 25 kts > DEVIATION > + 15 kts : index half visible
F	DEVIATION = + 11 kts
◇	DEVIATION = + 5,5 kts
	DEVIATION = 0
◇	DEVIATION = - 5,5 kts
S	DEVIATION = - 11 kts
	DEVIATION < - 11 kts : index remains visible

⑯ Runway Symbol

Appears when radio altitude becomes lower than 200 ft, and rises during the final descent to reach the aircraft symbol at zero radio altitude.

	FLIGHT INSTRUMENTS EFIS	7.10.30		
		P 5	001	
				DEC 96

AA

EHSI

EHSI displays long term information. They can be selected :

- in FULL mode
- in ARC mode

At power up, selected mode is FULL mode.

FULL MODE

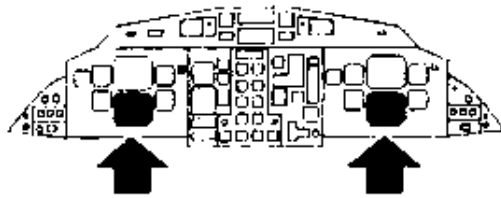

R0FA-01-10-30-005-A001AB

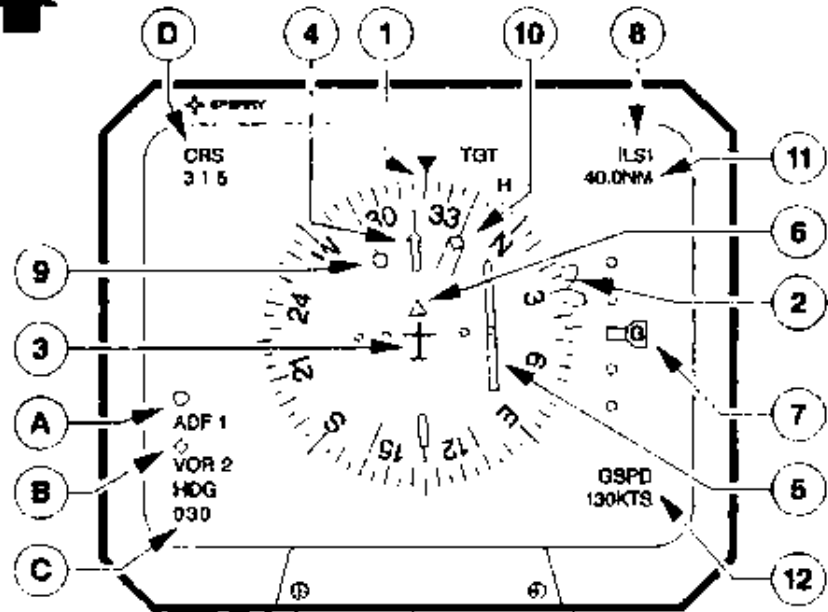

① Lubber line (white)

Used to read aircraft magnetic heading on the white heading dial.

② Selected heading bug (blue)

Is positioned around the rotating heading dial by the remote HDG knob. Selected heading is also displayed digitally in blue (C).

	FLIGHT INSTRUMENTS EFIS	1.10.30		
		P 6	001	
				DEC 96

③ Aircraft symbol (white)

Is a stationary symbol of the aircraft.

④ Course pointer (yellow)

Indicates the course which is selected for the respective VOR/ ILS. Selected course is also displayed digitally (D) in yellow numbers associated with white CRS letters.

⑤ Course deviation (yellow)

The bar indicates deviation relative to the course pointer. The scale is marked by dots. The aircraft symbol provides the position relative to the intended route.

⑥ TO/FROM annunciator (Magenta)

An arrow head in the EHSI center indicates whether the selected course will take the aircraft to or from the station. The TO-FROM annunciator is not visible during localizer operation.

⑦ Glide slope indication

Deviation from ILS glide slope is indicated by a white index on a green scale which is marked by dots. Index and scale are visible only when an ILS frequency is selected on the related NAV control box.

⑧ NAV source annunciation (white)

Identifies the source which supplies the course deviation. When both pilots are using the same source, the indication becomes amber.

⑨ Blue pointer (0)

Indicates the bearing to a station selected by N° 1 system (VOR 1 or ADF 1). Selection is indicated in (A).

⑩ Green pointer (◇)

Indicates the bearing to a station selected by N° 2 system (VOR 2 or ADF 2). Selection is indicated in (B).

⑪ Distance counter

The distance to the selected VOR/DME station is displayed in blue, with white NM letters. DME "HOLD" function is indicated by an amber "H".

⑫ Ground speed/Time to go annunciator

Ground speed or Time to go to the station are displayed in blue numbers and white letters, according to the mode selected on EFIS control box. These values are computed as a function of DME distance.

	FLIGHT INSTRUMENTS EFIS	1.10.30		
		P 7	001	
				DEC 96

ARC MODE

In ARC mode, EHSI displays normal information, plus the following :

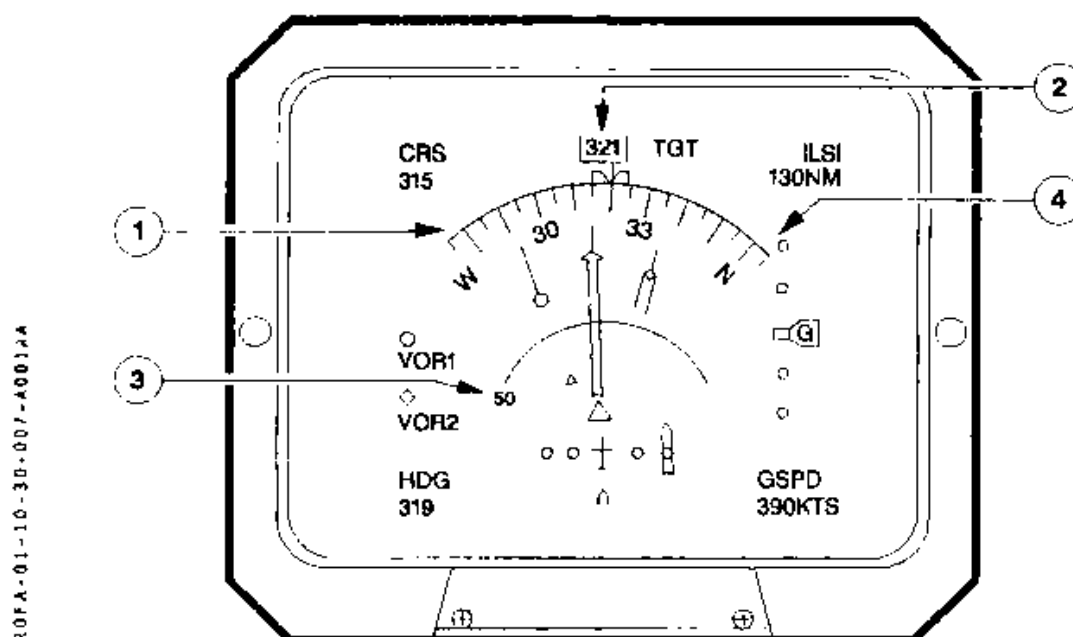

① Quadrantal Heading Scale

Heading is displayed on an arc showing 45° either side of the actual heading.

② Digital Heading display

Heading is digitally indicated in white on top of the quadrantal heading scale.

③ Weather radar annunciator

When the weather radar is in a mode other than OFF, the selected range scale is displayed in white.

④ Heading arrow

When heading bug is selected out of the heading scale, a small blue arrow shows the shortest direction to turn to achieve the selected heading. This arrow also appears in composite mode.

Note : Blue and green pointers are not displayed when bearing to station selected by corresponding VOR or ADF are outside quadrantal heading scale.

 A320 F.C.O.M.	FLIGHT INSTRUMENTS	1.10.30	
	EFIS	P 8	001
			DEC 96

COMPOSITE MODE

After switching OFF one of the CRTs, following information are retained on the remaining one.

- | | |
|--|---|
| <ul style="list-style-type: none"> - From EADI - Altitude data - VOR/LOC and glide slope deviation - Marker beacon information - Radio altitude and decision height - FD bars - Attitude and heading source annunciator | <ul style="list-style-type: none"> - From EHSI - Selected heading - Heading information (with digital display) - Selected course - VOR/LOC and glide deviation - NAV source annunciation - VOR/DME distance (only) - TO/FROM indication |
|--|---|

Information is displayed in the same way as in the normal configuration, except :

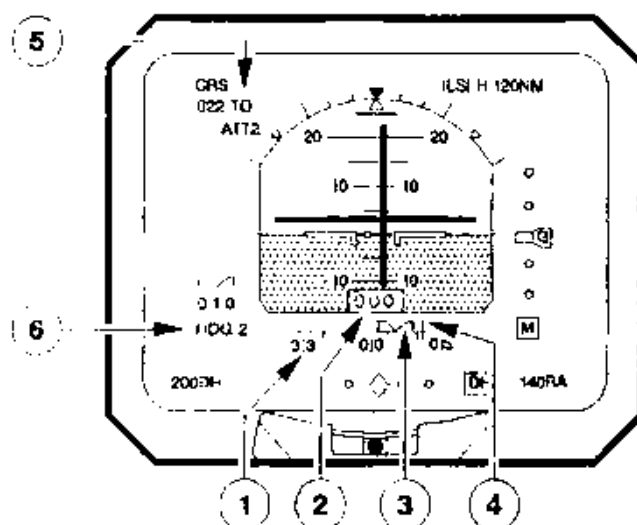

RDF A-51-10-30-008-4501AA

- ① Heading Scale
Is linearly displayed at the bottom of attitude indicator.
- ② Heading digital display
Is located between attitude indicator and heading scale.
- ③ Selected heading bug
Is located on linear heading scale. This bug is replaced by a small arrow when selected out of the scale.
- ④ Selected course pointer
Is represented by a small arrow above the linear heading scale.
- ⑤ TO/FROM indicator
Is written in letters beside the selected course.
- ⑥ Heading source cross-switching annunciator
Is located under selected heading indicator.

Note : When heading bug is selected out of the heading scale a small blue arrow shows the shortest direction to turn to achieve the selected heading.

	FLIGHT INSTRUMENTS EFIS	1.10.30		
		P 9	001	
				DEC 96

AA

CRS1/HDG PANEL

80F2-CL-10-30-089-A001AA

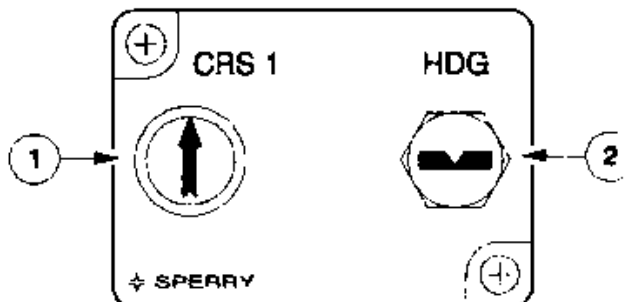
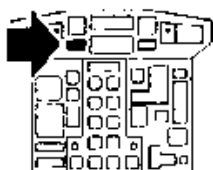

① CRS 1 knob

Selects course on CAPT EHSI.

② HDG knob

Selects heading on both EHSI.

ALT/CRS 2 PANEL

80F4-01-10-30-003-8007AA

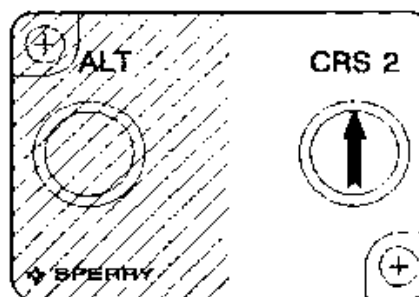
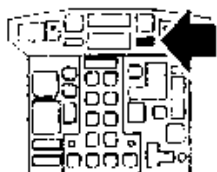

CRS 2 knob

Selects course on F/O EHSI.

FD BARS SW

80F4-01-10-30-003-8001AA

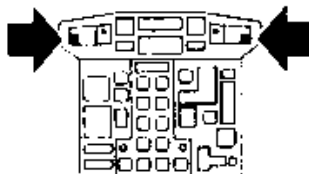

FD BARS



OFF

FD BARS
OFF

The FD bars are operative and in view in accordance with FD logic.
The FD bars are deactivated and out of view.

	FLIGHT INSTRUMENTS		1.10.30		
			P 10	001	
			DEC 97		
		EFIS			

AA

EFIS CONTROL PANEL (ECP)

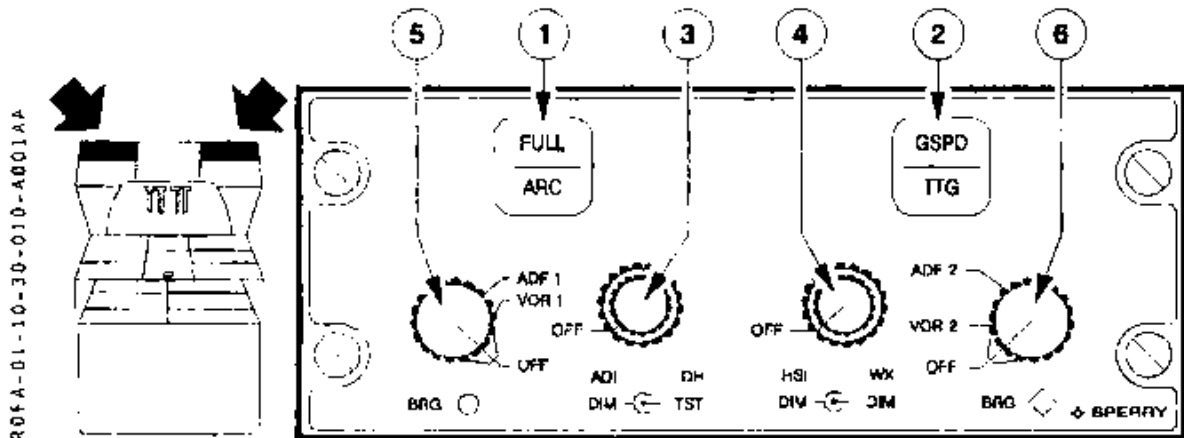

① FULL/ARC pb

Repetitive action on this pb alternately selects FULL mode and ARC mode on EHSI. At power up, FULL mode is automatically displayed.

② GSPD/TTG pb

Repetitive actions on this pb alternately selects Groundspeed (GSPD) and Time to go (TTG) on EHSI display. At power up, Groundspeed is displayed. This pb is inoperative in composite mode.

③ ADI/DIM/DH/TST knobs

- Outer knob (ADI DIM) is used to select EADI ON/OFF and to set brightness. Automatic setting is also performed when ambient brightness changes.
- Inner knob (DH TST) is used to set decision height from - 10 to 990 ft. Depressing it enables a test of the EFIS system and radio altimeter :

- R . EFIS test is performed only on ground, all failure messages appear on EFIS.
- R . Radio altimeter test is performed in flight as well as on ground. RA indication displays 100 ft on EADI.
- R

CAUTION : In flight, the RA test provides the radar with altitude information which trigger undue GPWS alerts.

④ HSI/DIM/WX/DIM knobs

- Outer knob (HSI DIM) is used to select EHSI ON/OFF and to set brightness. Automatic setting is also performed when ambient brightness changes.
- Inner knob (WX DIM) is used to select ON/OFF weather radar traces, and to set average brightness in relation to other traces.

⑤ N° 1 BRG (0) selector

To select blue bearing pointer to VOR 1 or to ADF 1. On OFF position, blue pointer disappears from EHSI.

⑥ N° 2 BRG (0) selector

To select green bearing pointer to VOR 2 or to ADF 2. On OFF position, green pointer disappears from EHSI.

 A320 F.C.O.M.	FLIGHT INSTRUMENTS EFIS	1.10.30		
		P 11	001	
				DEC 96

SOURCES SWITCHING PANEL

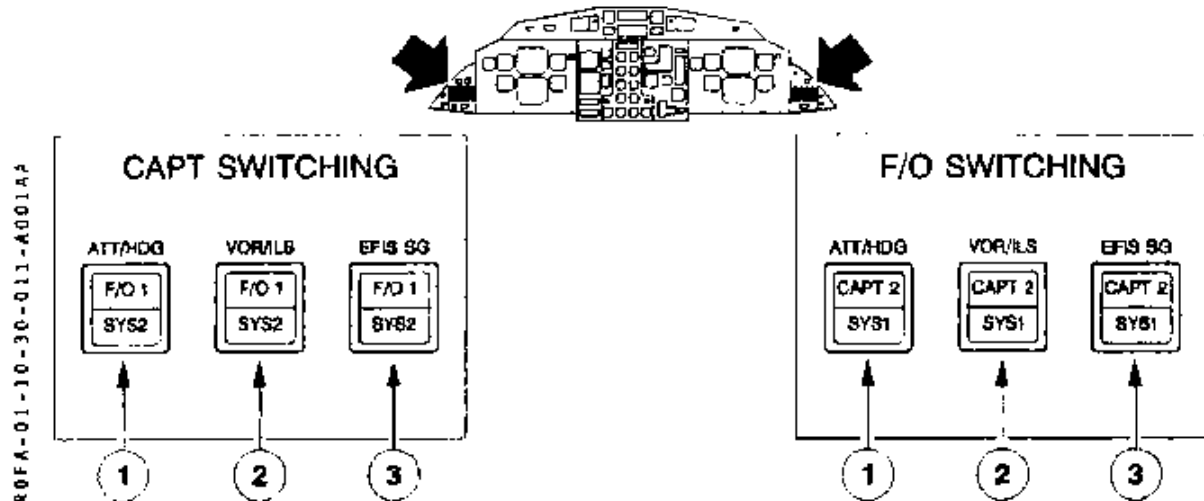

Each pilot may use a source switching panel to face a system failure (ATTITUDE/HEADING, VOR/ILS, SGU) by connecting his screens to the other side source. Connection is indicated. Priority is always given to the captain.

① ATT/HDG Pb

Enables to use AHRS 2 (or AHRS 1) information.

When captain pb is depressed "SYS 2" illuminates white on CAPT pb, "CAPT 2" illuminates green on F/O pb.

On both EADI, amber annunciators remind both pilots that they are using the same AHRS source (ATT2 and HDG2).

② VOR/ILS pb

Enables to use VOR/ILS 2 (or VOR/ILS 1) information.

Respective annunciator (VOR 2, ILS 2 or VOR 1, ILS 1) illuminates amber on EHSI. When captain pb is depressed, "SYS 2" illuminates white on CAPT pb, "CAPT 2" illuminates green on F/O pb.

③ SGU pb

Enable to use SGU 2 (or SGU 1) information.

When captain pb is depressed, "SYS 2" illuminates white on CAPT pb, "CAPT 2" illuminates green on F/O pb.

On both EADIs, amber SG2 (or SG1) illuminates top of the FAST/SLOW scale.

	FLIGHT INSTRUMENTS EFIS	1.10.30		
		P 12	001	
				DEC 96

EADI/EHSI ALERTS

COMPARISON MESSAGES

Both AHRS and both ILS information are monitored by SGUs. Caution messages are displayed in case of disagreement and "EFIS COMP" amber alert and single chime are generated at the same time by the CCAS.

ROFA-001-10-30-012-6001AA

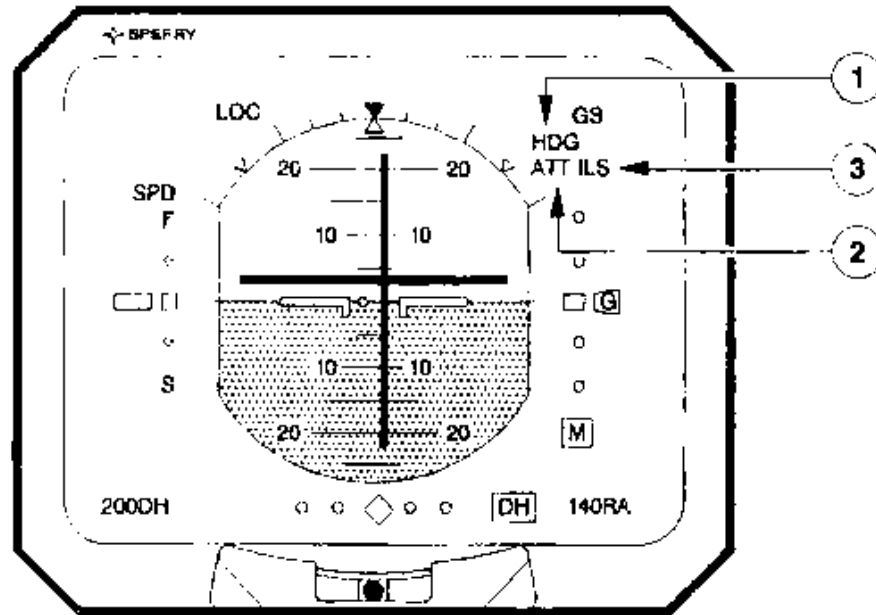

① Heading Comparison Caution Message

When the two AHRS are in disagreement of 6° or more and bank angle below 6° , amber HDG message is displayed. If bank greater than 6° alarm threshold becomes 12° .

② Attitude Comparison Caution Message

When the two AHRS disagree (6 degrees or more) on pitch information, amber PIT message is displayed.

When the two AHRS disagree (6 degrees or more) on roll information, amber ROL message is displayed.

When the two AHRS disagree on both pitch and roll information, amber ATT message is displayed.

③ ILS comparison Caution Messages

When the two ILS disagree (0.6 degree or more) on LOC information, amber LOC message is displayed.

When the two ILS disagree (0.2 degree or more) on Glide slope information, amber GS message is displayed.

When the two ILS disagree on both localizer and glide slope information, amber ILS message is displayed.

 A320 F.C.O.M.	FLIGHT INSTRUMENTS EFIS	1.10.30		
		P 13	001	
				DEC 96

SOURCE FAILURE ALERTS

In case of a source failure, the associated information immediately disappears from both CRTs. Failure message is displayed instead.

ROFA-01-10-30-013-4001AA

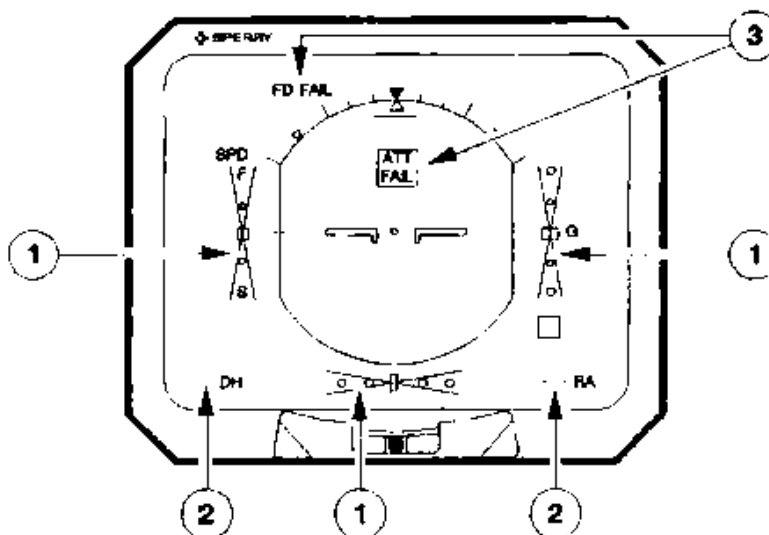



- ① *Information displayed on scales*
A red cross appears on the scale, indexes disappear.
- ② *Information digitally displayed*
Amber dashes replace the lost information.
- ③ *Other information*
Red message is displayed to advise the crew of the information loss.

EHSI SOURCE FAILURE ALERT

In case of a source failure, the associated information immediately disappears from both CRTs. Failure message is displayed instead.

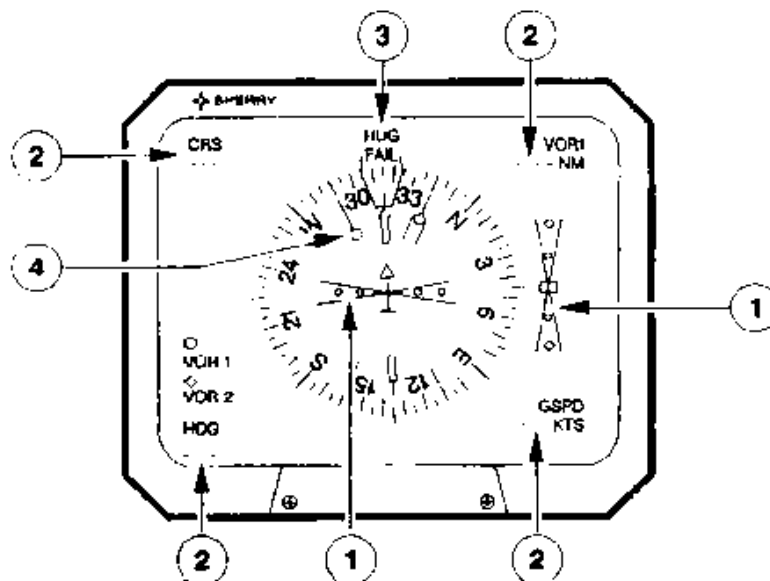
ROFA-01-10-30-013-8001AA



	FLIGHT INSTRUMENTS		1.10.30		
	EFIS		P 14	001	
					DEC 96

① Information displayed on scales

A red cross appears on the scale, indexes disappear.

② Information digitally displayed

Amber dashes replace the lost information.

③ Other information

Red message is displayed to advise the crew of the information loss.

④ Pointers

In case of associated NAV source failure, pointer disappears, no flag is visible.

SGU FAILURE ALERT

Depending on to the failed part of the SGU (see page 1), a failure message is possibly displayed.

① "A" or "B" part failure, part C still operative

All information disappears from both EADI and EHSL. On both CRTs, a red cross appears, with a red "SG FAIL" message.

R3FA-01-10-30-014-A001A4

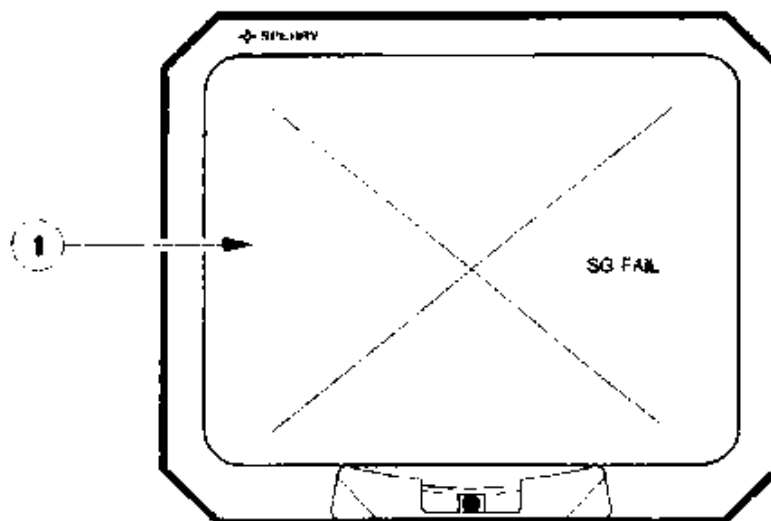

Note : In case of "A" or "B" part loss, data only acquired by one SGU (DME, ADF, NAV) will be lost and remain unrecoverable on the other pilot's system.

② "C" part inoperative

Both CRTs are dark without any failure message.

	FLIGHT INSTRUMENTS EFIS	1.10.30		
		P 15/16	070	
				JUN 97

AA

30.3 ELECTRICAL SUPPLY

EQUIPMENT	DC BUS SUPPLY (C/B)	AC BUS SUPPLY (C/B)
SGU 1 Power supply	} DC STBY BUS (on overhead panel EFIS SG 1)	- Nil -
ALT switching indication		
CAPT EADI		- Nil -
CAPT EHSI	} DC STBY BUS (on overhead panel EHSI)	- Nil -
SGU 1 NAV Reference CRS1/HDG panel RMI 2	} - Nil -	26 VAC STBY BUS (on overhead panel RMI)
SGU 2 power supply	} DC BUS 2 (on overhead panel EFIS SG 2)	- Nil -
ALT switching indication		
F/O EADI		- Nil -
F/O EHSI		- Nil -
SGU 2 NAV Reference ALT/CRS 2 panel CRS1/HDG panel (HDG 2 reference) RMI 1	} - Nil -	26 VAC BUS 2 (on overhead panel RMI)



ATR 72
F.C. M.

FLIGHT INSTRUMENTS

EFIS

1.10.30

P 17/18

001

DEC 96

30.4 SCHEMATIC

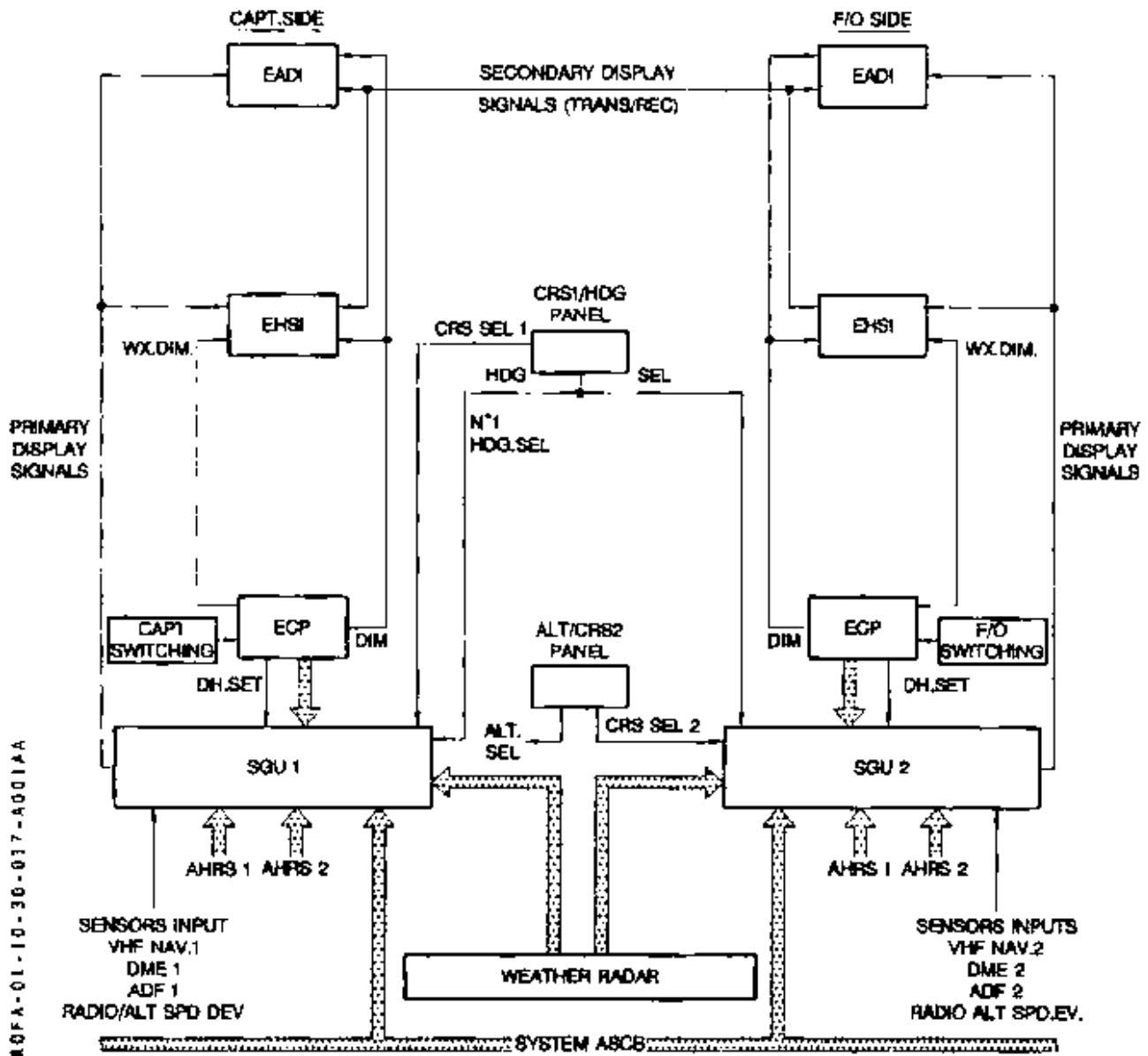

MOFA-01-10-30-017-A001AA

	FLIGHT INSTRUMENTS CLOCKS	1.10.40		
		P 1	001	
				DEC 96

AA

40.1 DESCRIPTION

Each pilot is provided with an electronic clock. The clocks display :

- time
- elapsed time
- chronometer information

For each clock, an internal battery maintains the time counter function when the aircraft is deenergized.

40.2 CONTROLS

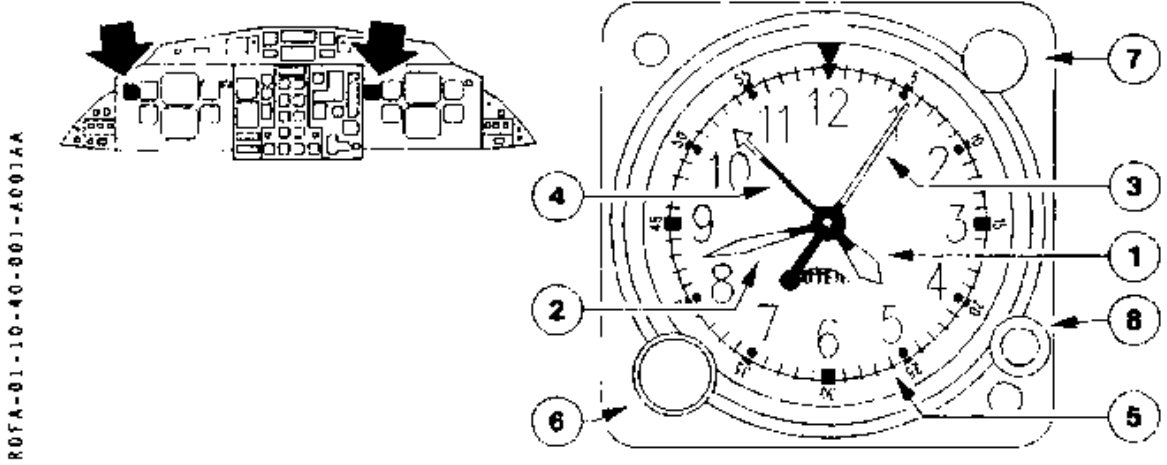

ROFA-01-10-40-001-ADD1AA

- ① Hours pointer (time)
- ② Minutes pointer (time)
- ③ Second pointer (chrono)
Pointer makes one revolution per minute when chronometer is activated.
- ④ Minutes pointer (chrono)
Pointer makes one revolution per hour when chronometer is activated.
- ⑤ Revolving bezel
Indicates elapsed time from start mark.
- ⑥ Time knob
Pull then rotate knob to set time.
- ⑦ Chronometer pb
Depress once to start
once to stop
once to reset
- ⑧ Revolving bezel knob
Rotate knob to set start mark with revolving bezel.

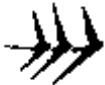
 ATR 72 F.C.O.M.	FLIGHT INSTRUMENTS CLOCKS	1.10.40		
		P 2	001	
				DEC 96

AA

40.3 ELECTRICAL SUPPLY

EQUIPMENT	DC BUS SUPPLY (C/B)	AC BUS SUPPLY (C/B)
CAPT clock	DC EMER BUS (on overhead panel CAPT)	- Nil -
F/O clock	DC BUS 2 (on overhead panel F/O)	- Nil -

	FLIGHT INSTRUMENTS	1.10.50		
	FLIGHT RECORDERS	P 1	001	
				DEC 96

50.1 DESCRIPTION

The aircraft is equipped with :

- a cockpit voice recorder (CVR), and
- a digital flight data recorder (DFDR)

The recorders are automatically energized as soon as the aircraft is on its own electrical supply and are switched off automatically ten minutes after engines cut. When the aircraft is on external power, recorders are off until one engine is started. They can be energized by selecting ON the RCDR pb, and deenergized by pushing the RESET pb.

Each recorder is equipped with an underwater acoustic beacon which is used to locate the recorder in the event of an aircraft accident over the sea. The beacons actuate immediately upon immersion. They should transmit a signal on 37.5 KHZ for 30 days. The detection range is 3.5 km (4000 yards).

CVR

All crew communications transmitted through the RCAU are recorded.

In addition, a CVR microphone located below the overhead panel, acquires cockpit conversation and aural alerts for recording. Cabin crew announcements are also recorded.

Only the last 30 minutes of recording are retained. All recording may be erased by pressing ERASE pb provided the aircraft is on the ground and the parking brake is set.

DFDR

Various aircraft parameters are sent to a Flight Data Acquisition Unit (FDAU) which converts them into digital data.

The FDAU also receives data from a Flight Data Entry Panel (FDEP) located on the pedestal.

The data are recorded by the DFDR which stores them on a magnetic tape. The 25 last hours of flight are retained.

	FLIGHT INSTRUMENTS	1.10.50	
		P 2	001
	FLIGHT RECORDERS		JUL 00

AA

50.2 CONTROLS

FLIGHT DATA ENTRY PANEL (FDEP)

ROFA-01-10-50-C02-A001AB

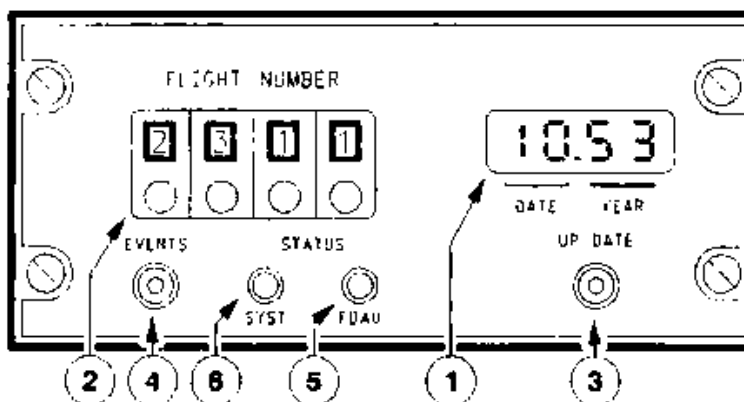
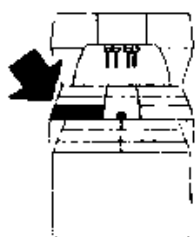

- ① **Data display**
Date and time may be displayed and selected through the UPDATE pb ③ (successive pressures) and the Data entry panel ② (except when 8 and 9 position of its first left thumbwheel is selected).
- ② **Data entry panel**
Enables (through 4 thumbwheels) to insert different data : hour, minutes, month, day, year, flight number and maintenance data.
- ③ **UPDATE pb**
Data displayed are updated as following :
 - first left thumbwheel of Data entry panel must be on 9 position.
 - **First sequence** : hours and minutes
 - UPDATE pb depressed, the display flashes
 - insert hour and minutes on data entry panel
 - UPDATE pb depressed, correction is taken into account and is displayed for 5 seconds. The following sequence must be initiated during these 5 seconds.
 - **Second sequence** : month and day
Repeat first sequence and insert month and day.
 - **Third sequence** : year.
Repeat first sequence and insert year.

Note : Once data are inserted, reset the flight number on data entry panel.
- ④ **Events pb**
When momentarily depressed, the tape records are marked to identify a special event.
- ⑤ **STATUS FDAU light**
Illuminates amber when the FDAU is failed.
- ⑥ **STATUS SYST light**
Illuminates amber when :
 - R - the DFDR is failed, or
 - R - the DFDR or QAR (if installed) electrical power is lost, or
 - R - QAR (if installed) 80% full.

	FLIGHT INSTRUMENTS		1.10.50	
			P 3	001
	FLIGHT RECORDERS		DEC 96	

COCKPIT VOICE RECORDER PANEL

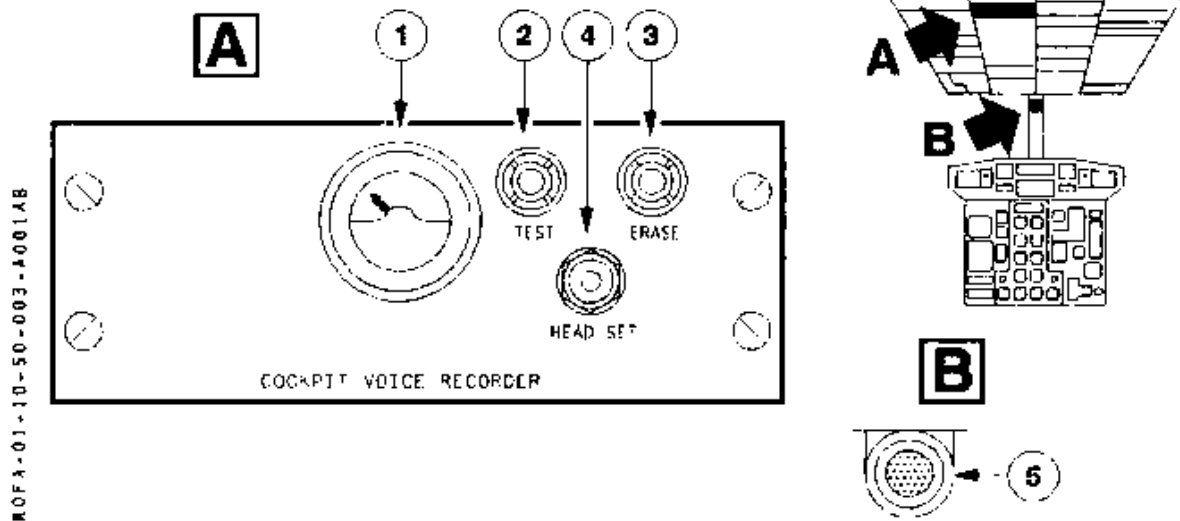

① Monitor ind.

For test only. Movement of pointer in the white band indicates all channels are operative.

② TEST pb

When depressed and held, the test circuit is activated :

- the pointer moves to a location between graduations 8 and 10
- if a headset is plugged into the jack, the 600Hz signal will be heard.

③ ERASE pb

Provides fast erasure of tape recordings when the landing gear shock absorbers are compressed and parking brake is set (depress for 2 seconds to completely erase). During erasure, a 400 Hz audio signal can be heard in the headset.

④ HEADSET jack

When headset is plugged into the jack :

- cockpit sounds picked up by the microphone are audible
- test tone is audible when TEST pb is depressed
- erase tone is audible when ERASE pb is depressed

⑤ Microphone

Picks up cockpit conversations and alert sounds.

	FLIGHT INSTRUMENTS		1.10.50	
	FLIGHT RECORDERS		P 4	050
			JUL 00	

AA

RECORD PANEL

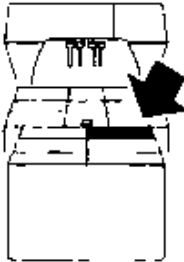

MOFA-01-10-50-000-AD50AA

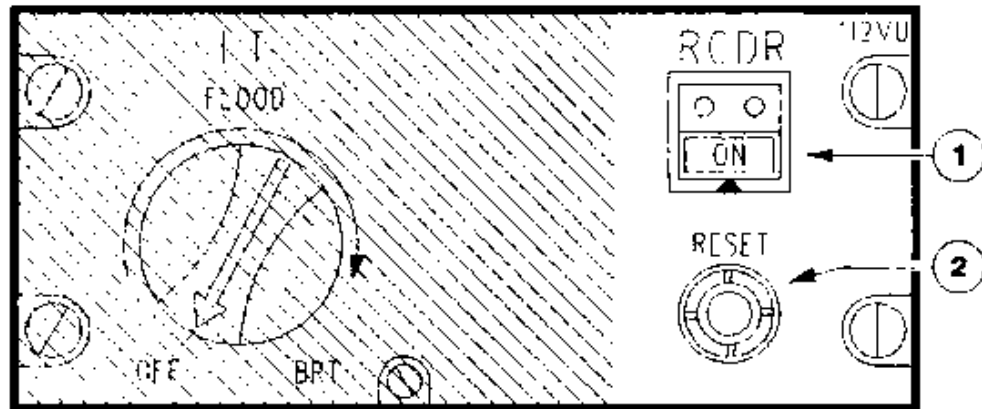

① RCDR pb

When depressed, both cockpit voice recorder and digital flight data recorder are energized (manual mode). ON ll illuminates blue.

② RESET pb

When depressed, inhibits recording in the manual mode.

50.3 ELECTRICAL SUPPLY

EQUIPMENT	DC BUS SUPPLY (C/B)	AC BUS SUPPLY (C/B)
FDAU power supply DFDR power supply	DC EMER BUS (on overhead panel FDAU DFDR)	115 VAC STBY BUS (on overhead panel DFDR)
Recorder synchronizer	- Nil -	26 VAC STBY BUS (on overhead panel SYNC)

	FUEL SYSTEM CONTENTS	1.11.00		
		P 1	001	
				DEC 96

AA

1.11.00 CONTENTS

1.11.10 GENERAL

10.1 DESCRIPTION

10.2 CONTROLS

10.3 ELECTRICAL SUPPLY/SYSTEM MONITORING

10.4 LATERAL MAINTENANCE PANEL

10.5 SCHEMATIC

	FUEL SYSTEM		1.11.10	
	GENERAL		P 1	001
			DEC 96	

AA

10.1 DESCRIPTION

The fuel system includes :

- two tanks with one electrical pump and one jet pump in each tank
- the vent system
- the fuel quantity indicating system
- the refuel/defuel system with associated controls and ind.

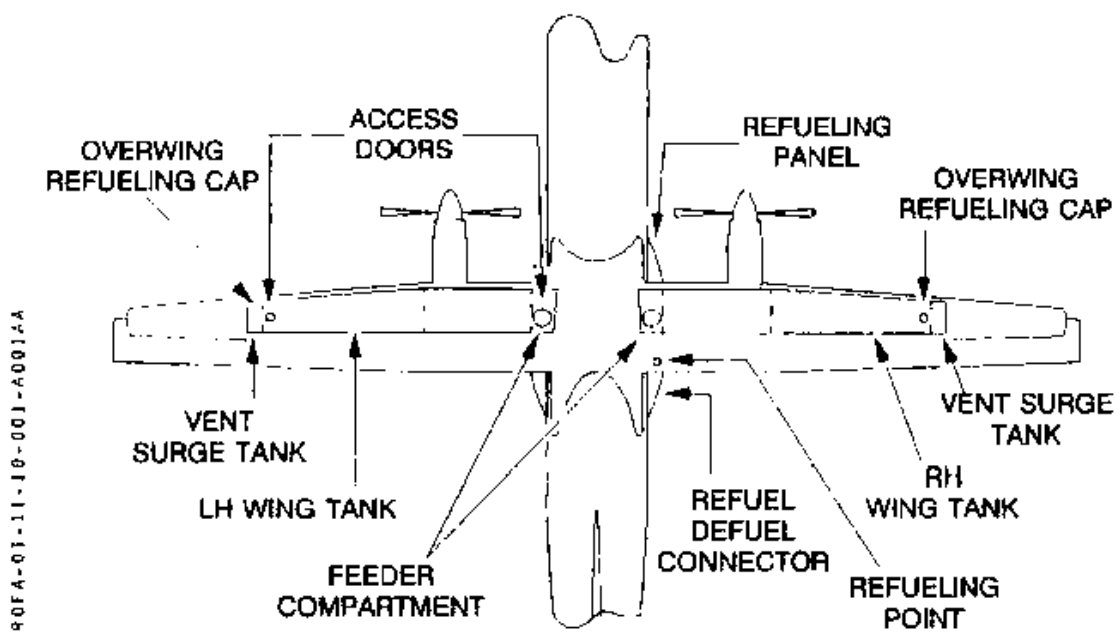

TANKS

The fuel is stored in two tanks, one in each wing, formed as an integral part of the wing structure. The maximum fuel capacity is :

	per tank	total
Volume	3185 l (840 US gal)	6370 l (1680 US gal)
Weight (density 0,785)	2500 kg (5512 lbs)	5000 kg (11025 lbs)

An additional volume in each tank allows a 2 % thermal expansion of fuel without spillage.

Each tank is equipped with two access doors located on the upper wing skin at each tank extremity to provide access to the interior and to essential equipment.

Water drainage is provided at the low points of each tank and can be performed up to 3° ground slope.

A temperature measuring device is installed in the left feeder compartment. Temperature is displayed on the pilot panel

	FUEL SYSTEM	1.11.10	
		P 2	001
	GENERAL		DEC 96

VENT SYSTEM

TANKS

The vent system ensures positive pressure in the whole flight envelope. Each fuel tank is air vented via an individual vent duct and a vent float valve to a 100l surge tank located in the outer section of the wing. The surge tank is connected to the atmosphere via a flush NACA inlet and is designed to avoid icing obstructions. Fuel collected in the surge tank is directed back to the wing tank via the vent duct.

The vent system also provides protection for the tanks in the event of accidental spillage during refueling.

WING CENTER BOX

The wing center box over the fuselage does not store any fuel and is crossed by two fuel pipes for cross engine feed and tanks refueling. To prevent fuel vapor concentration, the box is vented and drained.

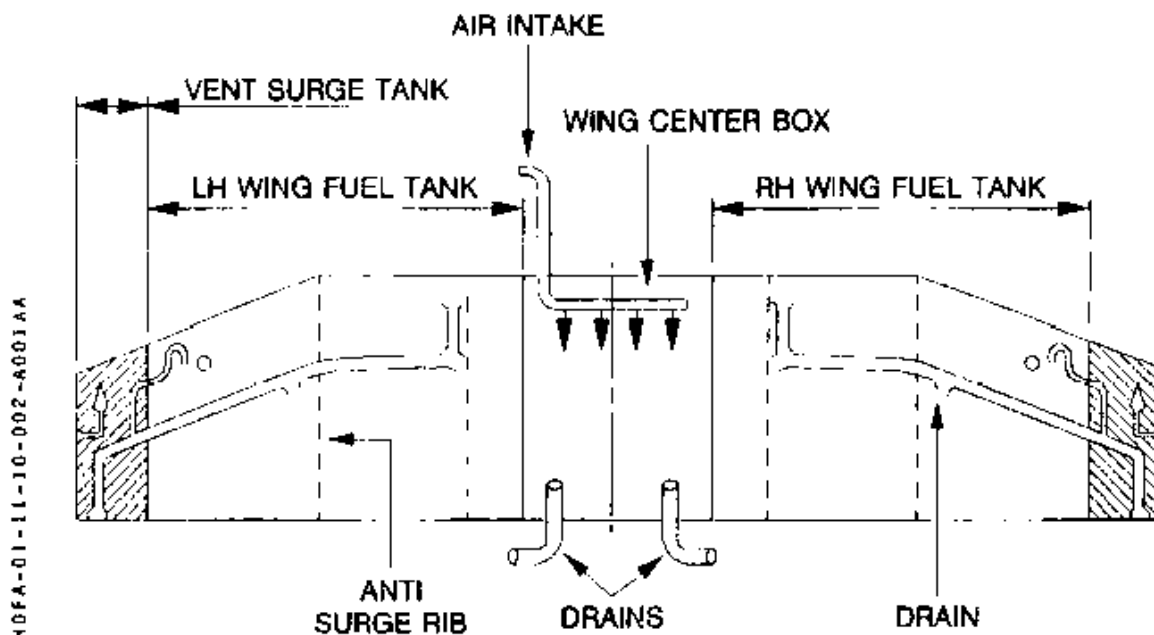

 A320 F.C.O.M.	FUEL SYSTEM	1.11.10		
	GENERAL	P 3	001	
				DEC 96

AA

ENGINE FEED (See schematic p 13/14)

In normal conditions, each engine is supplied from its associated wing tank. Fuel flow/fuel used ind. allow the crew to monitor fuel consumption for each engine. Each tank is fitted with a 200 l feeder compartment always full of fuel protecting the engine feed system against negative or lateral load factors. In the feeder compartment, an electrical pump and a jet pump are installed. The jet pump is activated by HP fuel from the engine HMU and is controlled by a motive flow valve.

Note : Each electrical pump is able to supply one engine in the whole flight envelope.

In normal operation, the electrical pump is only used to start the engine. After start, jet pump takes over automatically.

If jet pump pressure drops below 350 mbar (5 PSI), the electrical pump is automatically activated to supply the engine.

A crossfeed valve, controlled by an electrically operated actuator, allows both engines to be fed from one side or one engine to be fed by either tank, allowing control of an unbalance situation.

When the crossfeed valve is open, a blue "FUEL X FEED" light comes on memo panel. In this case, the two electrical pumps are automatically actuated. It's possible to use only one fuel tank by switching off the opposite pump pb.

At the fuel outlet of each tank a fuel LP valve, controlled by the associated fire handle, is installed.

When low level is reached in one tank, its electrical pump is automatically actuated (≤ 160 kg remaining fuel in the tank).

	FUEL SYSTEM	1.11.10	
	GENERAL	P 4	001
			DEC 96

QUANTITY INDICATING

The fuel tank capacity measurement system is such that the figures appear in terms of weight. The system is based on the fundamental relationship between the dielectric constant of the fuel and its density, to obtain a signal proportional to the mass of fuel in the tanks from a number of capacitance probes installed in the tanks.

Six probes are positioned in each tank and are electrically connected to the cockpit fuel quantity ind. Both fuel quantity indicating channels (one per tank) are independent. The fuel quantity ind. contains two digital displays showing the fuel mass in each of the two tanks. The accuracy on the total fuel indication, on ground, with attitude within -3° and $+1^\circ$ of Pitch and $\pm 2^\circ$ of Roll is :

- $\pm 1\%$ of full scale near zero level
- $\pm 3\%$ of full scale at full level

For all other ground and flight conditions, outside this envelope (pitch and roll) accuracy of fuel indications will be degraded.

To enable the tanks content to be determined on the ground in case of quantity indicating system failure, two magnetic level indicators are mounted in each tank through the lower wing skin. Tables allow these readings to be converted into units of fuel mass with corrections made for aircraft attitude and fuel density (Refer to chapter 2.06).

Actual magnetic indicators marking is in cm of fuel in the tank.

REFUEL/DEFUEL SYSTEM

All refueling operations are controlled from the refueling panel installed in the RH main landing gear fairing.

Complete refueling can be achieved in about 16 mn through the single refueling connector which is located in the rear part of the RH main landing gear fairing. Both wing tanks can be refueled with a refueling flow of about $24 \text{ m}^3/\text{h}$ (106 US gal/mn) with a maximum refueling pressure of 3.5 bars (50 PSI).

From the valve outlet, the fuel is distributed by pipes to diffusers which allow the fuel to enter the tank without surging.

High level detection comprises two different controls :

In normal operation, the high level detection is achieved by the FQI System. When the high level tank quantity is reached (2500 kg/5510 lb), the associated tank refuel valve is shut.

In case of FQI detection failure, the high level detection is achieved by a level sensor installed at the bottom of each surge tank.

When this level sensor is activated (3185 l/840 us gal), the associated high level light is illuminated on the refuel panel and the corresponding refuel valve is shut.

The wing tanks can also be refueled by gravity via one top of wing filler CAP per tank. The system may be used to defuel the aircraft by applying a 0.77 bar (11 PSI) suction to the connector and opening the tank refuel valves.

	FUEL SYSTEM		1.11.10	
	GENERAL		P 5	550
				JUN 97

AA

10.2 CONTROLS

FUEL PANEL



- ① **PUMP pb**
 Controls electrical pump and jet pump motive flow valve in each tank.
 PB pressed in :
- When jet pump delivery low pressure is detected (engine not running or jet pump pressure drop) :
 - electrical pump is automatically activated,
 - jet pump motive flow valve is controlled open but will remain closed until a sufficient pressure is available.
 - 30 seconds after HP fuel pressure is available and normal jet pump functioning is sensed by the 600 mbar (8.5 PSI) pressure switch, electrical pump is automatically switched off.
- RUN illuminates green when electrical pump is activated.
 OFF (p.b. released) electrical pump is deactivated, jet pump motive flow valve is controlled closed, OFF It illuminates white.
- ② **LP VALVE position ind.**
 The position of the fuel LP valve is displayed. Each valve is controlled by its associated fire handle.
- IN LINE Flow bar illuminates green. The valve is open.
 CROSS LINE The valve is closed, flow bar illuminates green and crosses the system flow line.
- Note : During transient phases (opening or closing), flow bars are extinguished.*
- ③ **FEED LO PR light**
 The light illuminates amber and the CCAS is activated when the fuel delivery pressure drops below 300 mbar (4 PSI). This indicates pump failure or fuel starvation.
- ④ **X FEED pb**
 Controls the operation of the fuel crossfeed valve.
- IN LINE (pb pressed in) The flow bar illuminates green in line. The valve is open.
 Both electrical pumps are automatically actuated.
- CROSS LINE (pb released) The flow bar illuminates green and crosses the system flow line. The valve is closed.
- Note : During transient phases (opening or closing), flow bar is extinguished. Permanent extinguishing of both bars indicates a valve fault.*
- ⑤ **TANK FUEL TEMP. IND.** (cf description p7)

 A320 F.C.O.M.	FUEL SYSTEM		1.11.10	
	GENERAL		P 6	050
			JUL 98	

AA

FUEL QTY PANEL

R01A-01-11-10-006-AD50AA

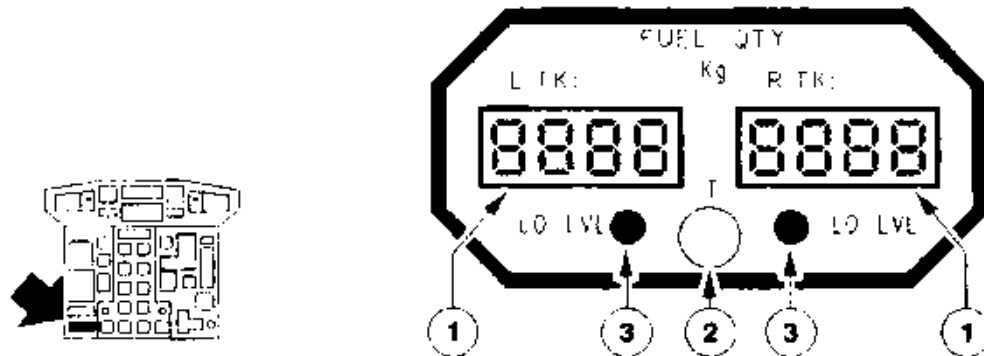

- ① FUEL QTY indications
Fuel quantity in each tank is displayed in kg.
- ② Test pb
Pressing the test button will check both measurement channels and, if the functioning is normal, display all 8's.
At the same time, CCAS is activated, MC flashes amber, SC is heard.
- ③ LO LVL amber lights
Each light illuminates amber and the CCAS is activated when quantity of the concerned display becomes lower than 160 kg ; in addition, the corresponding electrical pump is automatically actuated.

FF/FU IND.

R01A-01-11-10-006-B050AA

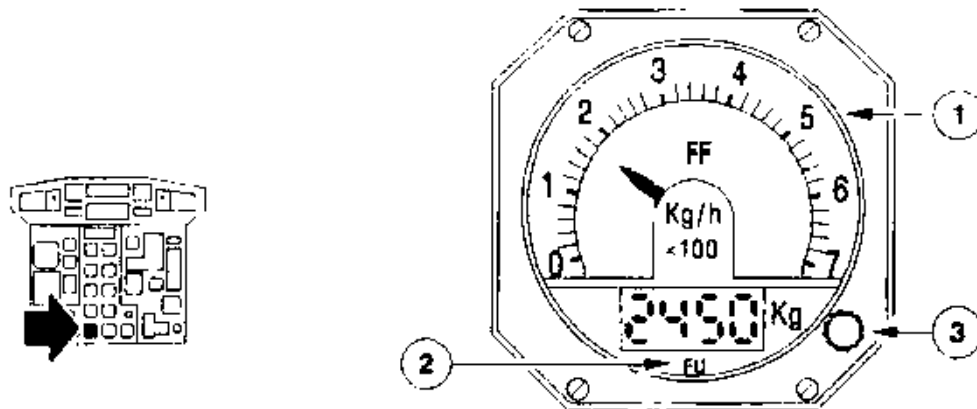

- A fuel flow/fuel used ind. is provided for each engine.
- ① FF indication
The mass fuel flow to the engine is indicated by a pointer on a scale graduated in kg/h X 100
 - R ② FU counter
On the digital read out, fuel used is indicated in kg. This value is computed by integration of the fuel flow parameter.
 - ③ FU reset knob
The fuel used counter is reset to 0 by pulling associated ind. reset knob.
Note : All the digits (on the FU counter as well as on the FUEL QTY ind.) may be tested by the overhead panel ANN LIGHT switch on TEST position.

 A320neo F.C.O.M.	FUEL SYSTEM	1.11.10	
	GENERAL	P 7	060
			JUL 01

AA **X FEED advisory light**



Illuminates blue on memo panel when the crossfeed valve is selected open.

TANK FUEL TEMPERATURE INDICATOR

FUEL TK

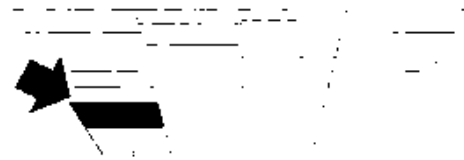
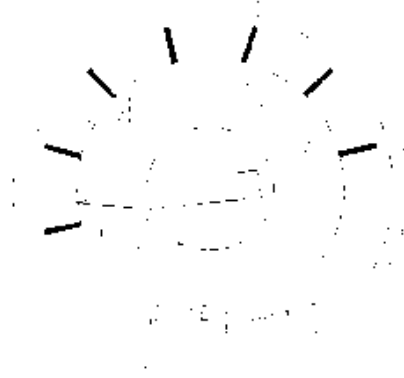

A temperature measuring device is installed in the left feeder compartment. Temperature is displayed on the center instrument panel.

FUEL TEMP IND



FUEL TEMP indication

Fuel temperature is displayed.

- R Yellow sector : -54°C to 0°C
- R Green sector : 0°C to 50°C
- R Yellow sector : 50°C to 57°C
- Red dash : -54°C and $+57^{\circ}\text{C}$

FUEL CLOG LIGHT



Light illuminates amber when fuel pressure loss in the corresponding HP pump fuel filter exceeds 45 PSI, indicating that the filter is blocked and bypassed.

	FUEL SYSTEM		1.11.10	
			P 8	001
	GENERAL		DEC 96	

REFUELING PANEL

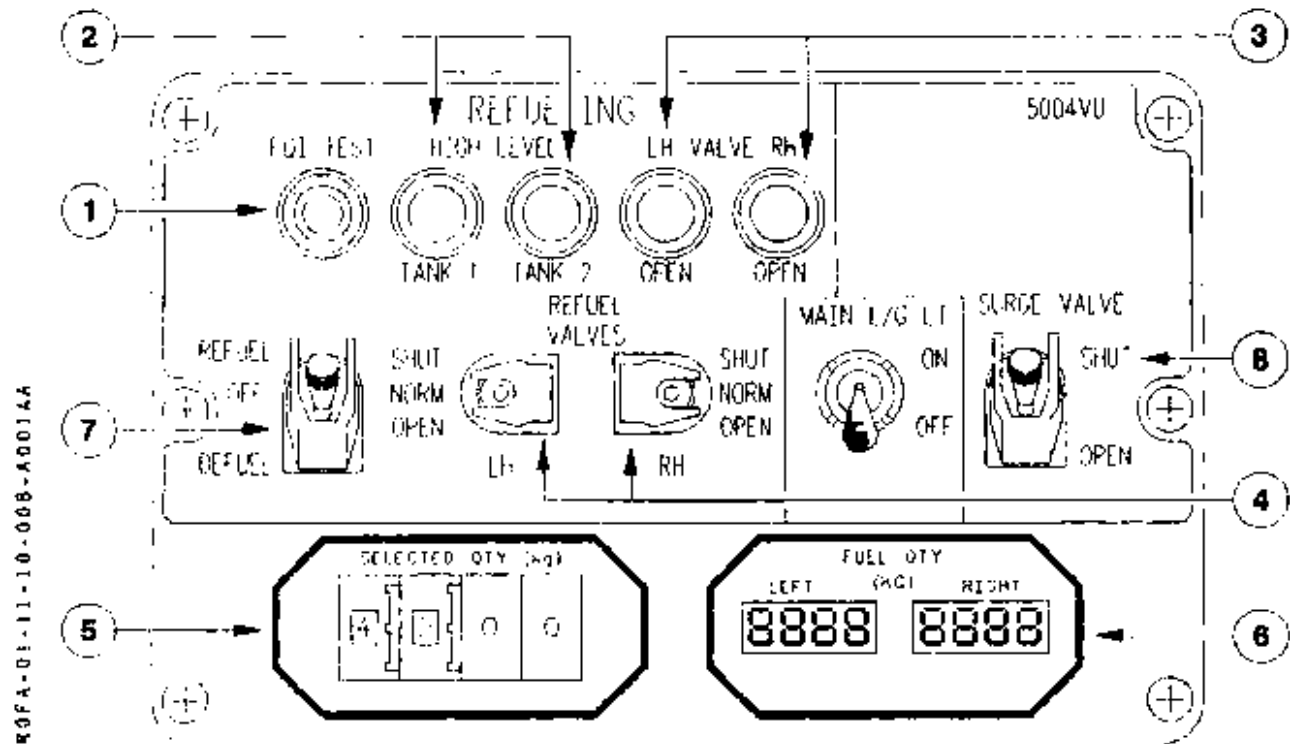

① FQI TEST pb

Pressing the test button will check both measurement channels and, if the functioning is normal, display all 8's on the FUEL QTY ind. on the refueling panel as well as in the cockpit. It will also shut the refuel valves, simulating a maxi level in both tanks. This test activates the CCAS.

② HIGH LEVEL light

The light illuminates amber when the high level sensor is submerged (maximum refueling quantity reached). The corresponding refuel valve closes automatically.

③ REFUEL VALVES position light

The light illuminates blue when the refuel valve is open. They extinguish during the fuel circuit test, indicating the valves have closed.

	FUEL SYSTEM	1.11.10		
		P 9	001	
	GENERAL			DEC 96

④ REFUEL VALVES switches

Control the operation of the valves for each tank. They are guarded at NORM.

NORM Valves are controlled by automatic fueling logic, depending on position of the mode selector switch and quantity preselection. Valves close automatically when high level is detected by the FQI.

OPEN Valves open when the mode selector switch is in the refuel or defuel position and the high level sensor is not submerged.

SHUT Valves close regardless of the mode selector switch position.

⑤ SELECTED QTY ind.

The quantity for automatic refueling is controlled by the setting of the preselector. The counter displays the preselected total fuel quantity.

⑥ FUEL QTY ind.

This ind. has the same presentation as the one used in the cockpit.

CAUTION: Wait indicators are stabilized before taking into account fuel quantity indications.

⑦ Mode selector switches

Controls the operating mode for automatic fueling and the activation of REFUEL VALVES switches for manual operation.

OFF Refuel valves are closed, switches are not activated.

REFUEL Refuel valves may be operated by auto refueling logic (REFUEL VALVES switches on NORM) or manual refueling operation.

DEFUEL Refuel valves may be operated by manual defueling operation. With the mode selector in DEFUEL position and REFUEL VALVES in the OPEN position, all level protections are inhibited.

⑧ SURGE VALVE

Provides air vent of the refuel line during suction draining of this line.

OPEN The surge valve opens. Mode Selector switch must be in OFF position

SHUT The surge valve is closed.

	FUEL SYSTEM	1.11.10		
		P 10	001	
	GENERAL			DEC 96

10.3 ELECTRICAL SUPPLY/SYSTEM MONITORING

ELECTRICAL SUPPLY

EQUIPMENT	DC BUS SUPPLY (C/B)
ENG 1 Electrical pump - Pressure sw controlling electrical pump activation/ disactivation and motive flow valve opening/closure - Fuel feed pressure sw Fuel LP valve Fuel LP valve position ind. FF/FU ind.	DC ESS BUS (on lateral panel ELEC PUMP) DC ESS BUS (on lateral panel CTL and CAUTION) • DC BUS 1 (on lateral panel MOTOR 1) • DC EMER BUS (on lateral panel MOTOR 2) DC EMER BUS (on lateral panel IND) DC BUS 1 (on lateral panel FUEL FLOW FUEL USED)
ENG 2 Electrical pump - Pressure sw controlling electrical pump activation/ disactivation and motive flow valve opening/closure - Fuel feed pressure sw + IND Fuel LP valve Fuel LP valve position ind. FF/FU ind.	DC ESS BUS (on lateral panel ELEC PUMP) DC ESS BUS (on lateral panel CTL and CAUTION) • DC BUS 2 (on lateral panel MOTOR 1) • DC EMER BUS (on lateral panel MOTOR 2) DC EMER BUS (on lateral panel IND) DC BUS 2 (on lateral panel FUEL FLOW FUEL USED)

	FUEL SYSTEM	1.11.10		
		P 11/12	500	
	GENERAL			JUN 97

AA

EQUIPMENT	DC BUS SUPPLY (C/B)
Refuel valves high level detection System	GND HDLG BUS (on lateral panel FUELING CTL and IND)
Left quantity ind. *	DC ESS BUS (on lateral panel L TANK)
Right quantity ind. *	DC ESS BUS (on lateral panel R TANK)
Crossfeed valve	DC ESS BUS (on lateral panel X FEED)
Tank fuel temperature indicator	DC BUS 1 (on lateral panel)

* Left and right cockpit quantity indicators will be supplied by GND HDLG BUS on ground for airplane servicing, when battery is off and refuel door open.

SYSTEM MONITORING

The following conditions are monitored by visual and aural alerts :

- Engine feed low pressure (below 300 mbar/4PSI)
 - See FEED LO PR procedure in chapter 2.05.03.
- Fuel tank low level (below 160 kg/352 Lbs)
 - See FUEL LO LVL procedure in chapter 2.05.03.
- Jet pump pressure drop (below 350 mbar/5PSI)
 - this condition is monitored only by visual alert. RUN green light illuminates on overhead panel.

10.4 LATERAL MAINTENANCE PANEL

The right side maintenance panel includes a readout display for failures of systems linked to the MFC (refer to 1.01.10/10.5). It can be used to test feeder jet pumps functioning.



FUEL SYSTEM

1.11.10

P 13/14

500

GENERAL

JUN 97

SCHEMATIC

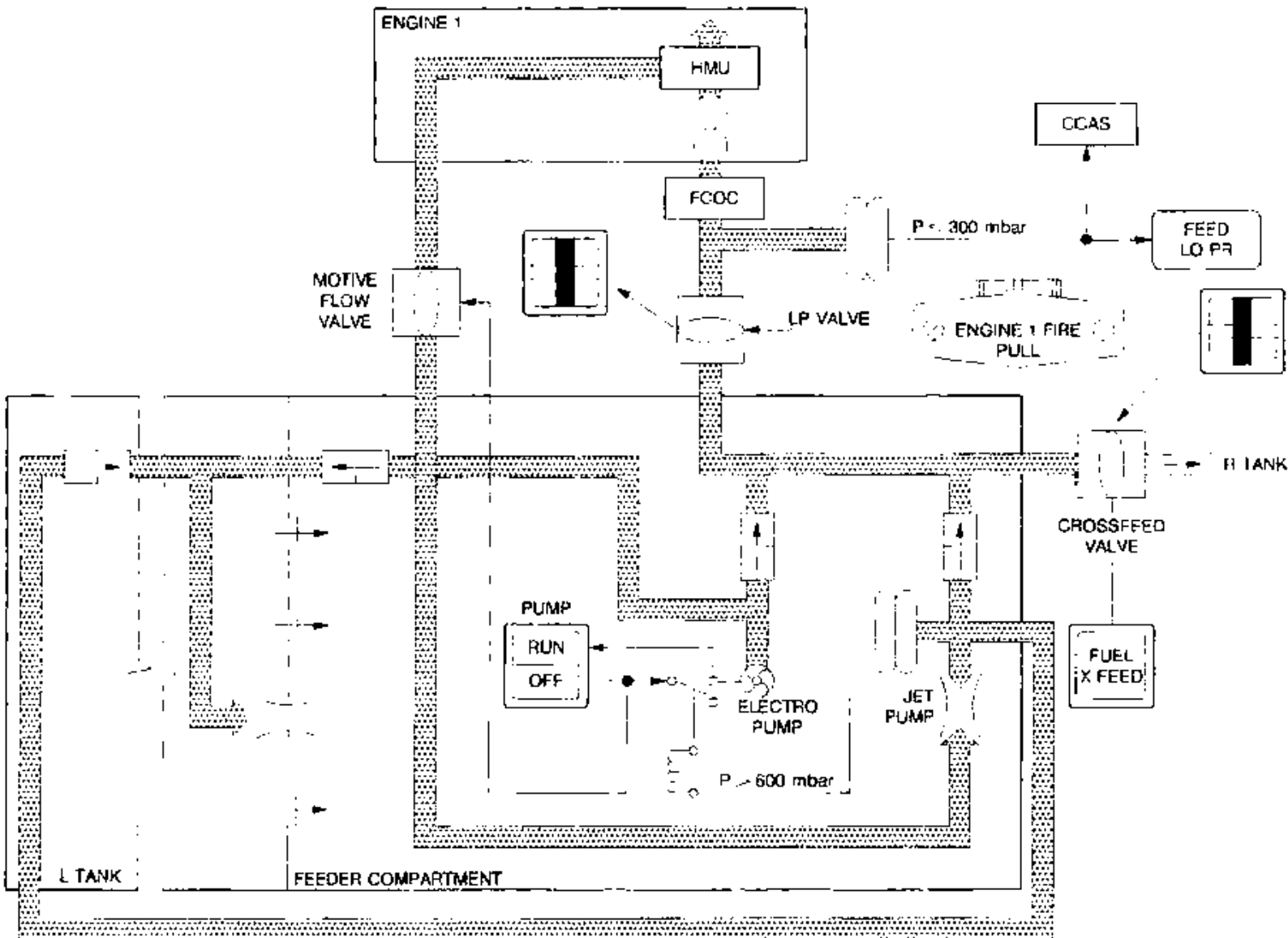

401A-01-11-10-D13-ASC00A

	HYDRAULIC SYSTEM CONTENTS	1.12.00		
		P 1	001	
				DEC 96

1.12.00 CONTENTS

1.12.10 GENERAL

10.1 DESCRIPTION

10.2 CONTROLS

10.3 ELECTRICAL SUPPLY/MFC LOGIC/SYSTEM MONITORING

10.4 SCHEMATIC

	HYDRAULIC SYSTEM	1.12.10		
		P 1	001	
	GENERAL			DEC 96

10.1 DESCRIPTION (See schematic p 7/8)

The aircraft has two hydraulic systems, designated blue and green.
 The common hydraulic tank is located in the hydraulic bay (LH landing gear fairing).

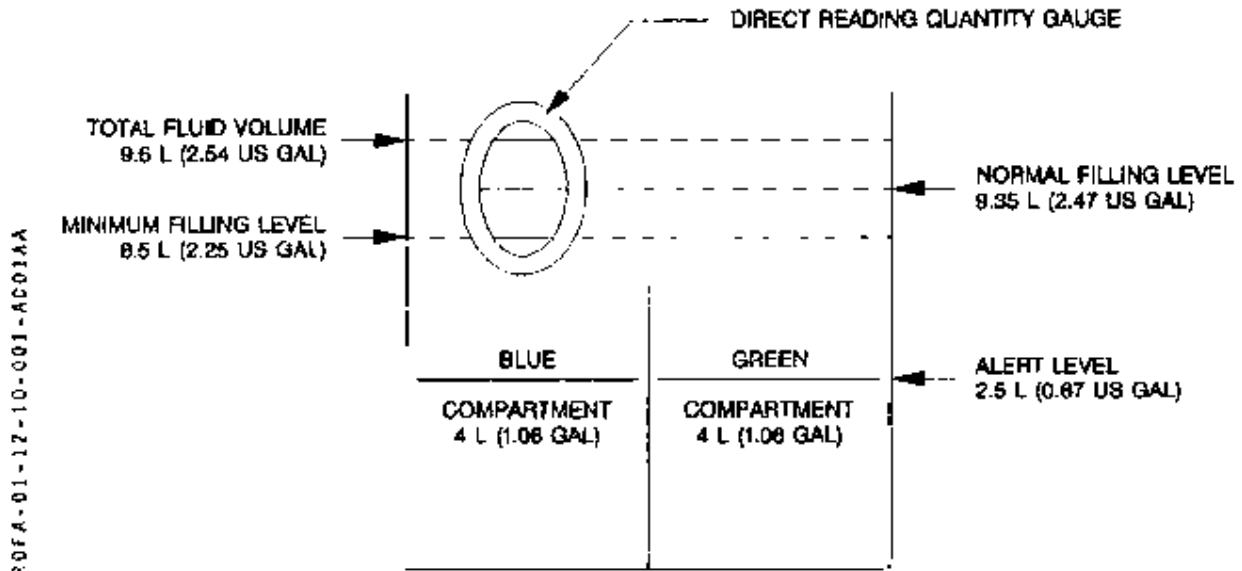

The tank is a direct air-fluid contact type and is not pressurized. A compartment baffle ensures fluid antisplashing and limits fluid foaming.
 A direct reading quantity gauge is located on the tank. A low level alert is provided for each compartment when quantity drops below 2.5 l (0.67 USgal).

POWER GENERATION

Each system is pressurized by an ACW electric motor driven pump. Delivery pressure of each pump is displayed. Normal operating pressure is 3000 PSI (206.9 bars). The blue circuit is also fitted with an auxiliary DC motor driven pump.

Each system is provided with a 0.2 l (0.05 USgal) power accumulator installed in the hydraulic bay. They damp pump delivery pulsations and any pressure surges and compensate for pump response time in the event of high output demand.

On the ground, when no electrical power is available, hydraulic power may be generated by a hydraulic ground power unit, through a ground connector located in the hydraulic bay. A ground switch on the pedestal enables to energize the auxiliary pump even when no electrical power is available.

 ATR 72 F.C.O.M.	HYDRAULIC SYSTEM	1.12.10		
	GENERAL	P 2	001	
				DEC 96

AA

USERS

- The blue system supplies :
 - wing flaps extension/retraction :
 - four wing flap actuating hydraulic jacks.
 - spoilers :
 - two spoilers actuating hydraulic jacks.
 - nose wheel steering :
 - one steering hydraulic jack.
 - propeller brake for the RH engine.
 - emergency and parking braking for the four main landing gear wheels through a specific accumulator with separate pressure ind.
- The green system supplies :
 - landing gear extension/retraction :
 - three landing gear actuating hydraulic jacks
 - three landing gear uplock release actuators
 - three landing gear downlock release actuators.
 - normal braking for the four main landing gear wheels.

In case of hydraulic pump failure, the associated system users may be supplied by the other pump by opening the crossfeed valve.

Note : In case of LO LEVEL alert, cross feed valve :

- is inhibited to open
- closes automatically if it was in open position

	HYDRAULIC SYSTEM	1.12.10	
	GENERAL	P 3	001
			DEC 97

AA

10.2 CONTROLS

HYD PWR PANEL

R012-01-10-10-001-001-001

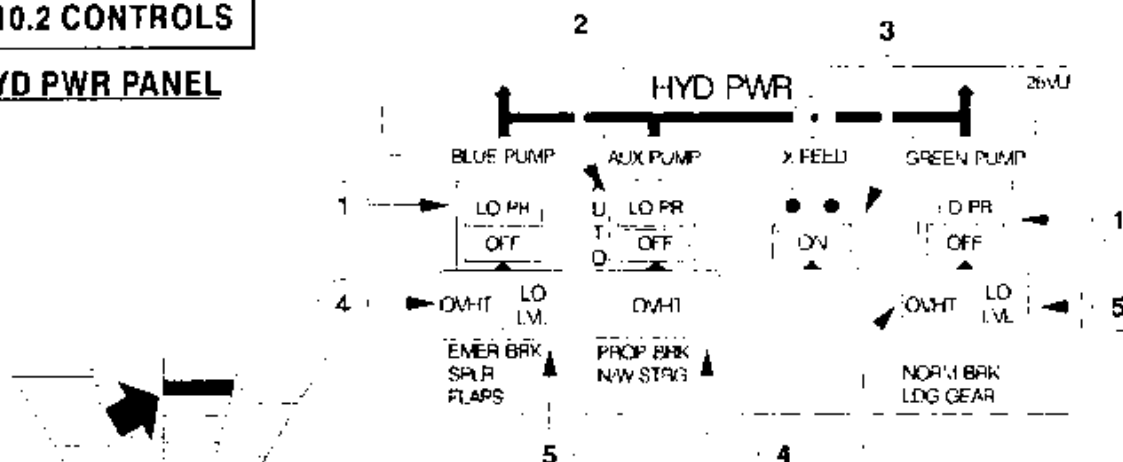

- ① **Main pumps pbs**
 Control activation/deactivation of ACW electric motor driven pumps.
 pb pressed in : pump is energized
 OFF : (pb released) pump is deactivated, OFF It illuminates white.
 LO PR : The light illuminates amber and the CCAS is activated through the MFC when the associated pump delivered fluid pressure drops below 1500 PSI (103,5 bars).
- ② **Auxiliary pump pb**
 Controls operating mode of DC auxiliary pump.
 AUTO (pb pressed in) pump runs as soon as the following conditions are met :
 - ACW blue pump pressure below 1500 PSI and,
 - propeller brake released and,
 - gear handle selected DOWN and,
 - at least one engine running
 OFF (pb released) ; auxiliary pump is deactivated, OFF illuminates white.
 LO PR the light illuminates amber and CCAS is activated when auxiliary pump outlet pressure is detected lower than 1500 PSI and functioning conditions are met.
- ③ **XFEED pb**
 Controls opening and closure of the crossfeed valve.
 pb released : crossfeed valve is closed. Both hydraulic circuits are separated.
 ON : (pb pressed in) crossfeed valve is selected open. Both hydraulic circuits are connected. ON It illuminates white.
- ④ **OVHT II**
 The It illuminates amber and the CCAS is activated when pump case drain line overheat is detected ($T > 121^{\circ} C / 250^{\circ} F$)
- ⑤ **LO LEVEL II**
 The It illuminates amber and the CCAS is activated when associated tank compartment fluid quantity drops below 2.5 l (0.67 USgal). The XFEED automatically closes.

R

	HYDRAULIC SYSTEM GENERAL	1.12.10		
		P 4	001	
				DEC 96

PRESS IND.

ROFA-01-12-10-004-AD01AA

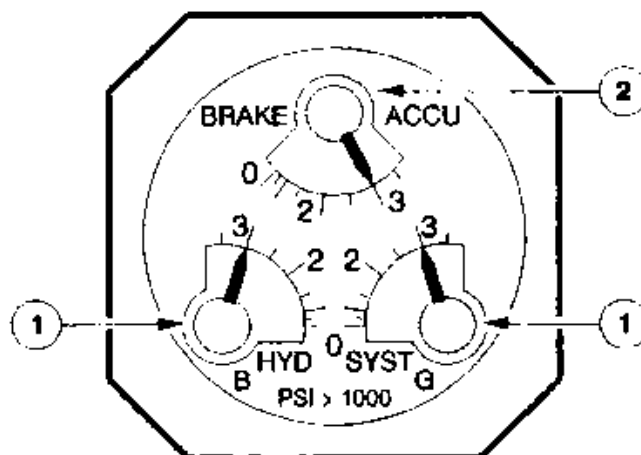
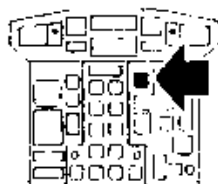

① HYD SYST ind.

Displays the blue and green system pressure in the delivery line. Pressure indication is PSI X 1000. Normal values are 3000 PSI. Red dots indicate alert thresholds.

② BRAKE ACCU ind.

Displays the brake accumulator pressure in the blue system, available for emergency and parking braking if Pressure > 1600 PSI. Pressure indication is PSI X 1000. Normal value is 3000 PSI.

Note : • In the event of electric failure, the pointers move to 0.

- Gas pressure gauges are installed in the hydraulic bay for each accumulator (one per system + emergency and parking braking). They may be used on ground, when aircraft is not powered, to check the accumulator charge.

Gas pressure of each accumulator is 1500 PSI.

AUX PUMP PEDESTAL SWITCH

ROFA-01-12-10-004-800:AA

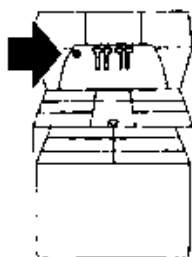

**AUX HYD
PUMP**

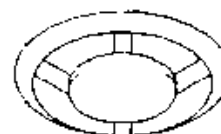

When used, this switch :

- energizes for 30 seconds the auxiliary DC hydraulic pump provided :
 - GND HDLG BUS under power (Models 101, 201, 211 only).
 - other auxiliary pump operation conditions are not met.
- supplies power to the pressure indicators, enabling to check hydraulic pressures.

CAUTION : This switch operates even when batteries master switch is selected "OFF". Intensive use could discharge the main battery.

	HYDRAULIC SYSTEM	1.12.10		
		P 5	050	
	GENERAL			JUN 97

10.3 ELECTRICAL SUPPLY/MFC LOGIC/SYSTEM MONITORING

ELECTRICAL SUPPLY

MODEL	EQUIPMENT	DC BUS SUPPLY (C/B)	AC BUS SUPPLY (C/B)
ALL	Blue pump power	- Nil -	ACW BUS 1 (on lateral panel BLUE HYD PUMP)
	Blue pump control	DC EMER BUS (on lateral panel PUMP CTL)	- Nil -
	Blue system alert	DC EMER BUS (on lateral panel ALERT)	- Nil -
	Green pump power	- Nil -	ACW BUS 2 (on lateral panel GREEN HYD PUMP)
	Green pump control	DC ESS BUS (on lateral panel PUMP CTL)	- Nil -
	Green system alert	DC EMER BUS (on lateral panel ALERT)	- Nil -
	Auxiliary pump power	DC BUS 2 (on lateral panel AUX HYD PUMP NORM PWR SPLY) HOT MAIN BAT BUS (on lateral panel AUX HYD PUMP GND PWR SUPPLY)	- Nil -
	Pressure ind.	DC STBY BUS (on lateral panel PRESS IND)	- Nil -
	XFEED valve	DC STBY BUS (on lateral panel XFEED)	- Nil -
102 202 212 212 A	Auxiliary pump control	DC BUS 2 (on lateral panel HYD PWR AUX PUMP CTL IND NORM) HOT MAIN BAT BUS (on lateral panel HYD PWR AUX PUMP CTL IND GND)	Nil -
101 201 211	Auxiliary pump control	DC BUS 2 (on lateral panel HYD PWR AUX PUMP CTL IND NORM) GND HDLG XFR BUS (on lateral panel HYD PWR AUX PUMP CTL IND GND)	- Nil -

	HYDRAULIC SYSTEM	1.12.10		
	GENERAL	P 6	001	
				DEC 96

MFC LOGIC

See chapter 1.01.

SYSTEM MONITORING

The following conditions are monitored by visual and aural alerts :

- Tank compartment fluid quantity below 2.5 l(0.67 US gal).
 - See HYD TK COMPT LO LEVEL procedure in chapter 2.05.05.
- Pump delivery pressure below 1500 PSI (103.5 bar)
 - See HYD LO PR/HYD OVHT procedure in chapter 2.05.05.
- Pump case drain line temperature above 121°C (250°F)
 - See HYD LO PR/HYD OVHT procedure in chapter 2.05.05.



ATR 72
FC M.

HYDRAULIC SYSTEM

1.12.10

P 7/8

001

GENERAL

DEC 96

10.4 SCHEMATIC

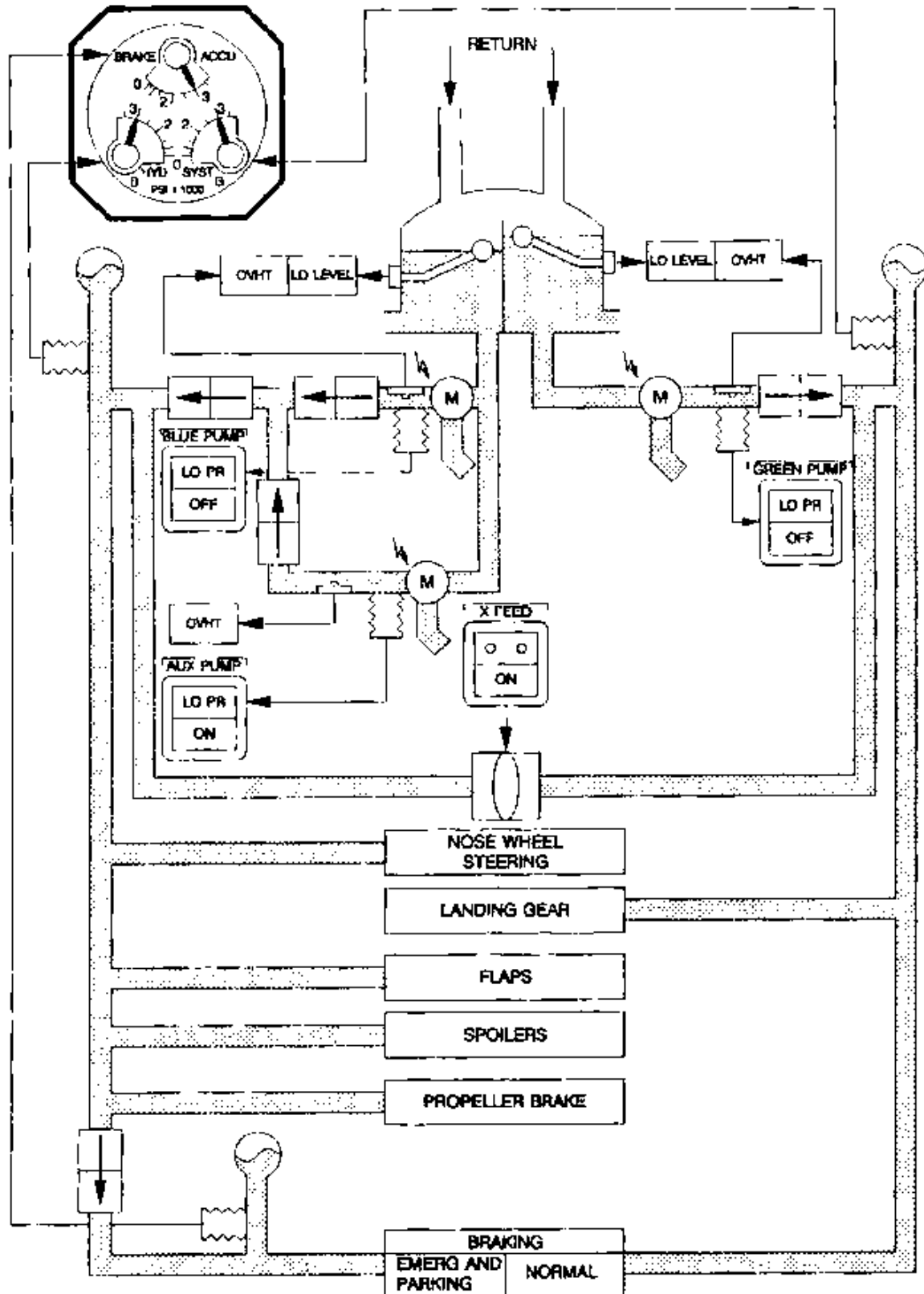

R0FA-01-12-10-007-8001AA

	ICE AND RAIN PROTECTION	1.13.00		
	CONTENTS	P 1	001	
				DEC 96

AA

- 1.13.00 CONTENTS**
- 1.13.10 GENERAL**
- 1.13.20 ANTI ICING ADVISORY SYSTEM**
 - 20.1 DESCRIPTION
 - 20.2 CONTROLS
 - 20.3 ELECTRICAL SUPPLY/SYSTEM MONITORING
- 1.13.30 ENGINE AND WING PROTECTION**
 - 30.1 DESCRIPTION
 - 30.2 CONTROLS
 - 30.3 ELECTRICAL SUPPLY/MFC LOGIC/SYSTEM MONITORING
 - 30.4 SCHEMATIC
- 1.13.40 PROPELLER ANTI ICING**
 - 40.1 DESCRIPTION
 - 40.2 CONTROLS
 - 40.3 ELECTRICAL SUPPLY/MFC LOGIC/SYSTEM MONITORING
 - 40.4 LATERAL MAINTENANCE PANEL
- 1.13.50 WINDOW HEAT**
 - 50.1 DESCRIPTION
 - 50.2 CONTROLS
 - 50.3 ELECTRICAL SUPPLY/MFC LOGIC/SYSTEM MONITORING
 - 50.4 LATFRAL MAINTENANCE PANEL

	ICE AND RAIN PROTECTION CONTENTS	1.13.00		
		P 2	001	
				DEC 96

AA

1.13.60 PROBE HEAT

60.1 DESCRIPTION

60.2 CONTROLS

60.3 ELECTRICAL SUPPLY/SYSTEM MONITORING

1.13.70 RAIN PROTECTION

70.1 DESCRIPTION

70.2 CONTROLS

70.3 ELECTRICAL SUPPLY

	ICE AND RAIN PROTECTION GENERAL	1.13.10		
		P 1/2	020	
				DEC 96

AA

The ice and rain protection system permits aircraft operation in various environmental conditions and, in particular, in icing situations.

An ice detector, located on the left wing leading edge and connected to the CCAS, monitors ice accretion.

Aircraft ice protection is provided by :

- a pneumatic system operating on areas of the airframe :
 - outer, center and inner wing leading edges
 - horizontal tailplane leading edges
 - engine air intakes and gas paths.
- electrical heating of :
 - propeller blades
 - windshields
 - probes
 - flight control horns

For the pneumatic system, the engines supply bleed air through the LH and RH de ice valves regardless of the engine bleed valves position.

For electrical heating, the power is supplied primarily by AC wild current.

Rain removal from the front windshields is achieved by windshield wipers.

 ATR 72 F.C.M.	ICE AND RAIN PROTECTION	1.13.10	
	GENERAL	P 3/4	020
			DEC 96

SCH. 11

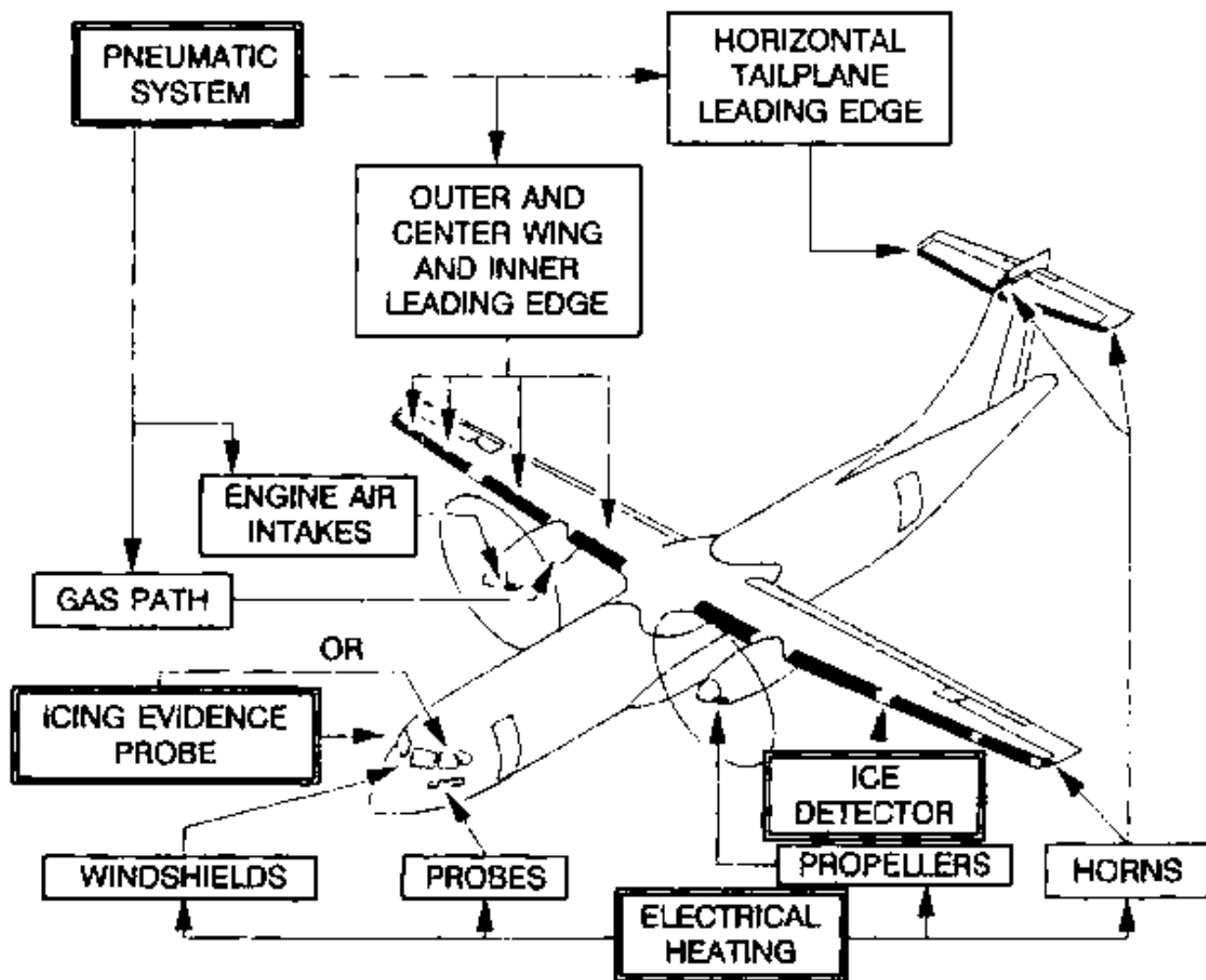

	ICE AND RAIN PROTECTION	1.13.20		
		P 1	001	
	ANTI ICING ADVISORY SYSTEM			DEC 96

AA

20.1 DESCRIPTION

An anti icing advisory system (AAS) is installed.

The AAS system includes :

- An ice detector
- An icing evidence probe
- Three lights in the cockpit
 - icing (amber) and ICING AOA (green) lights on central panel
 - DE ICING blue light on memo panel

This system has been designed to alert the crew on the correct procedures to be applied when flying in icing conditions :

- Increase of minimum maneuver/operating speeds + selection of anti-icing
- Selection of the deicing system at first indication of ice accretion
- Switching the deicing system OFF when ice does not build up any more on the airframe.

ICE DETECTOR

The ice detector, located under the left wing, alerts the crew as soon as and as long as ice accretion is sensed by the probe.

Alert is generated by the amber ICING light on the central panel.

The system is self tested constantly, and any failure generates a FAULT light illumination with single chime.

Detection of ice accretion and associated alert are performed under following cycle :

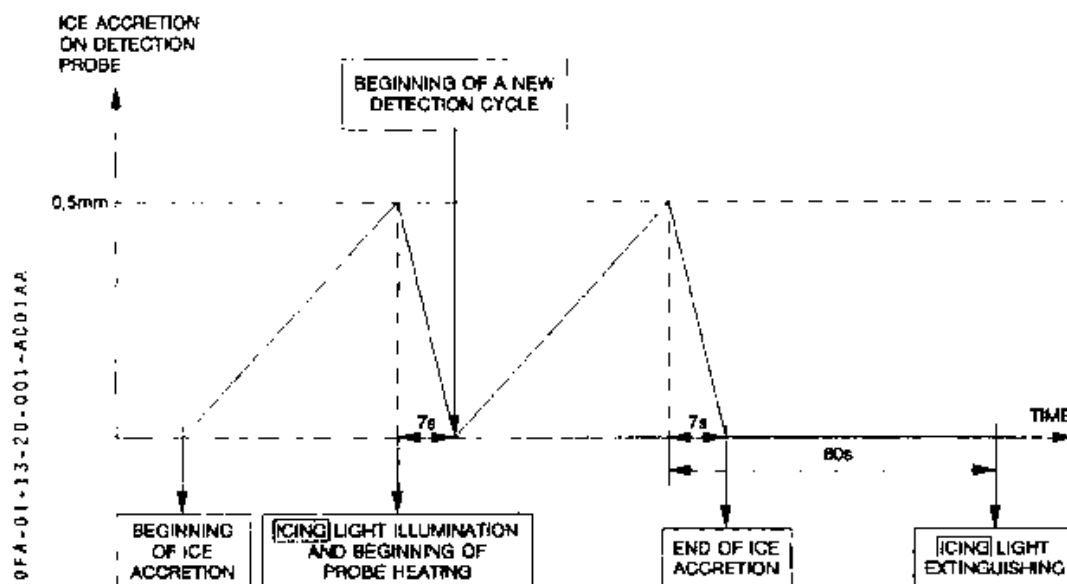

CAUTION :

The ice detector indicates ice accretion is building up on aircraft. Therefore, extinguishing of the ICING light must be regarded as an end of ice accretion and not as an absence of ice on aircraft. Consequently a visual check must be performed to assure aircraft is cleared of ice after having encountered ice accretion conditions.



ATR 72
F.C.O.M.

ICE AND RAIN PROTECTION

ANTI ICING ADVISORY SYSTEM

1.13.20

P 2

050

DEC 96

ICING EVIDENCE PROBE

Located near left side window of the cockpit, the icing evidence probe is visible by both pilots. An integrated lighting, to evidence ice accretion, is controlled by NAV lights switch.

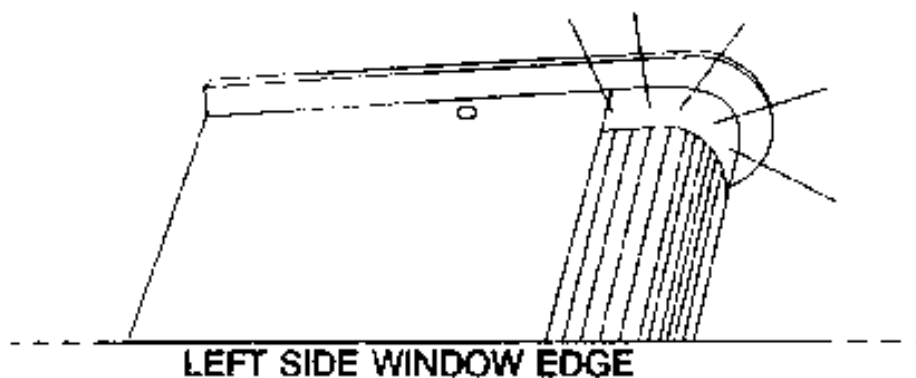

20FA-01-13-20-002-AD50PA

	ICE AND RAIN PROTECTION	1.13.20	
		P 3	180
	ANTI ICING ADVISORY SYSTEM		JUL 00

AA

20.2 CONTROLS

ICE DETECTOR PANEL

5056-01-11-70-003-0180A

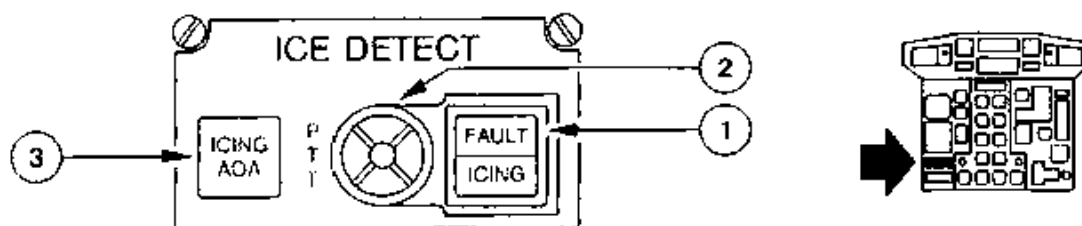

① ICE DET INDICATION LIGHT

- R ICING illuminates steady amber when ice accretion is detected, provided both horns anti icing and airframe de icing are selected ON.
- R ICING flashes amber when ice accretion is detected and horns anti icing and/or airframe de icing are not selected ON.
- R FAULT illuminates amber when a system failure is detected (detector fault, loss of power supply).

② ICE DET PTT

The push to test pb is used to check the ice detector correct operation.
Press and hold test button for 3 seconds.

- ICING amber light flashes on central panel (with associated warning) if system works correctly.
- ICE DET FAULT illuminates, (with associated central warnings) if an ice detector failure is detected.

③ ICING AOA pb

- ICING AOA ll illuminates green as soon as one horns anti icing Pb is selected ON, reminding the crew of stall alarm threshold being lower in icing conditions.
- ICING AOA ll can only be extinguished manually by depressing it, provided both horns anti icing are selected OFF. In this case, stall alarm threshold recovers the values defined for flight in normal conditions.

DE ICING INDICATOR

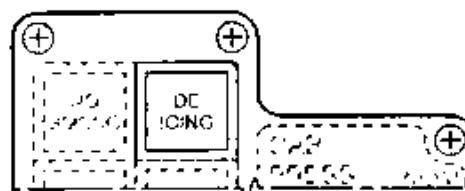

RUF A-01 13 70-003-0180A4

- Illuminates Blue on memo panel when the airframe deicing system is selected ON.
- Flashes Blue on memo panel when the airframe deicing system is still selected ON five minutes after last ice accretion detection.

	ICE AND RAIN PROTECTION	1.13.20		
		P 4	001	
	ANTI ICING ADVISORY SYSTEM			DEC 96

AA

20.3 ELECTRICAL SUPPLY/SYSTEM MONITORING

ELECTRICAL SUPPLY

EQUIPMENT	DC BUS SUPPLY (C/B)	AC BUS SUPPLY (C/B)
ICE detector	- Nil -	ACW BUS 2 (on lateral panel ICE DET PWR SPLY)
ICING/FAULT light	DC EMER BUS (on lateral panel ICING CAUTION/ Boots A and B ind)	- Nil -
ICING AOA light	DC EMER BUS (on lateral panel DE ICING-AAS/ Boots A and B ind)	- Nil -

SYSTEM MONITORING

The following conditions are monitored by visual and aural alerts :

- Ice detector failure
 - See ICE DETECTOR FAULT procedure in chapter 2.05.09.
- Ice accretion developing on aircraft
 - See adverse weather procedures in chapter 2.02.08.
- Airframe de icing system selected and no ice accretion for 5 minutes.
 - DE ICING blue light flashing on center panel. This condition is not monitored by aural alert.

	ICE AND RAIN PROTECTION	1.13.30		
		P 1	020	
	ENGINE AND WING PROTECTION			DEC 96

30.1 DESCRIPTION (See schematic P 9/10)

The operating principle is to sequentially inflate the boots in order to remove ice. The de ice valves control the delivery pressure to 1.4 bar (20.3 psi).

Seven distribution valves control air supply to the boots :

- valve ① to LH engine air intake and separation chamber,
- valve ② to RH engine air intake and separation chamber,
- valve ③ to LH outer wing leading edge,
- valve ④ to LH center wing leading edges and LH internal wing leading edge,
- valve ⑤ to RH outer wing leading edge,
- valve ⑥ to RH center wing leading edge and RH internal wing leading edge,
- valve ⑦ to horizontal tailplane leading edge

Each of these distribution valves has one input and two outputs A and B, each controlled by the MFC.

Two types of boots are used :

- Chordwise boots for the leading edges and the gas paths.

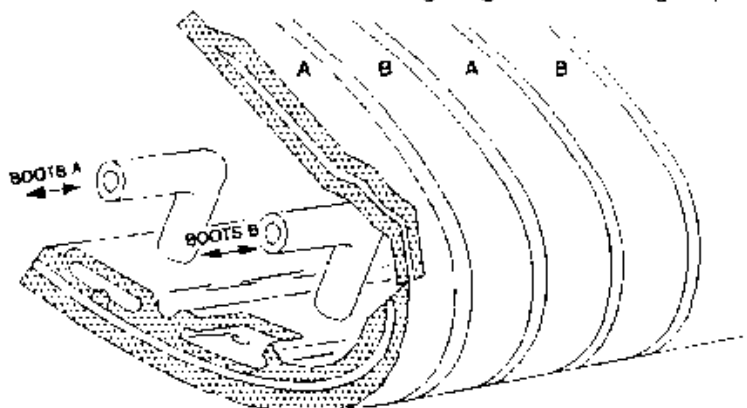

- Annular boots for the engine intakes.

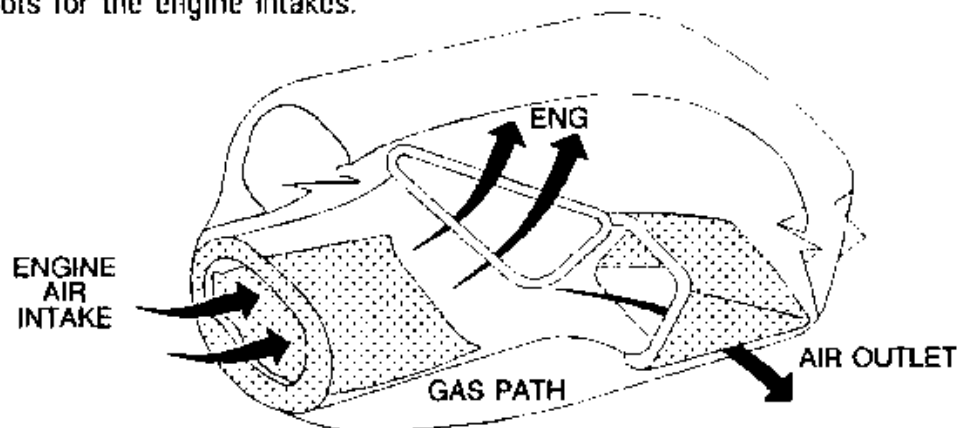

When deflated, the boots are held to the structure thanks to a venturi supplied by bleed air.

Note : - The system is designed to remain operative with one engine inoperative through a common air manifold, except icing protection of the inoperative engine which is lost.

CAUTION : With this type of boot, there is no need to wait for ice accretion on airframe before selecting it ON. This system **MUST** be selected ON as soon as and as long as ice accretion develops on airframe.

AA

TIME SEQUENCE DIAGRAM

NORMAL MODE (PILOTED BY MFC)

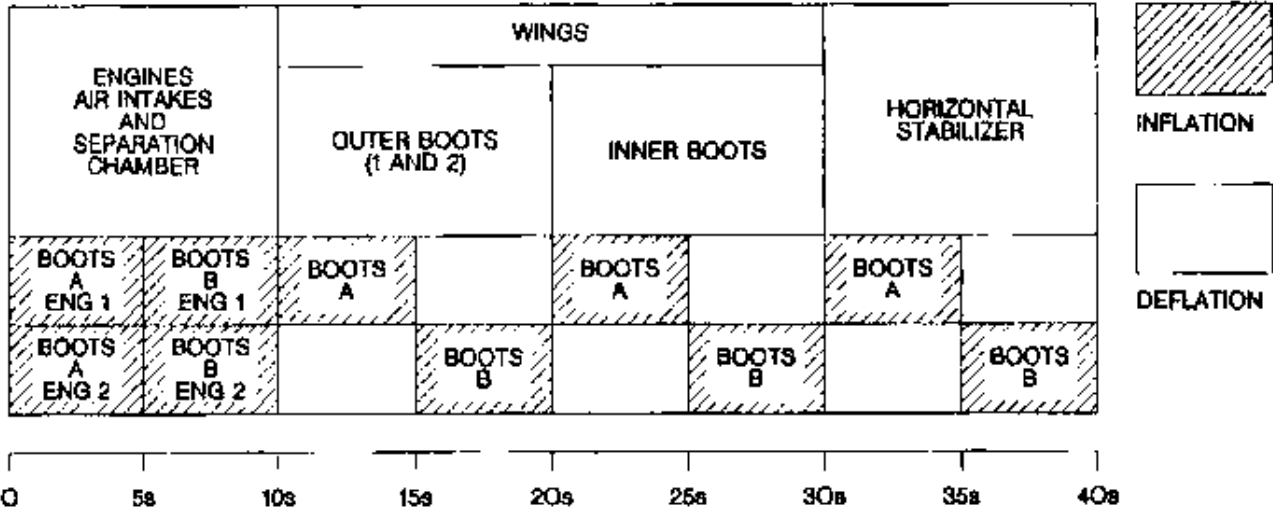

- BEGINNING OF THE FOLLOWING SEQUENCE AT :
- R - 60 sec (FAST MODE (SAT > -20° C))
 - R - 180 sec (SLOW MODE (SAT < -20° C))

OVRD MODE (SEPARATED TIMER AND FAST MODE ONLY)

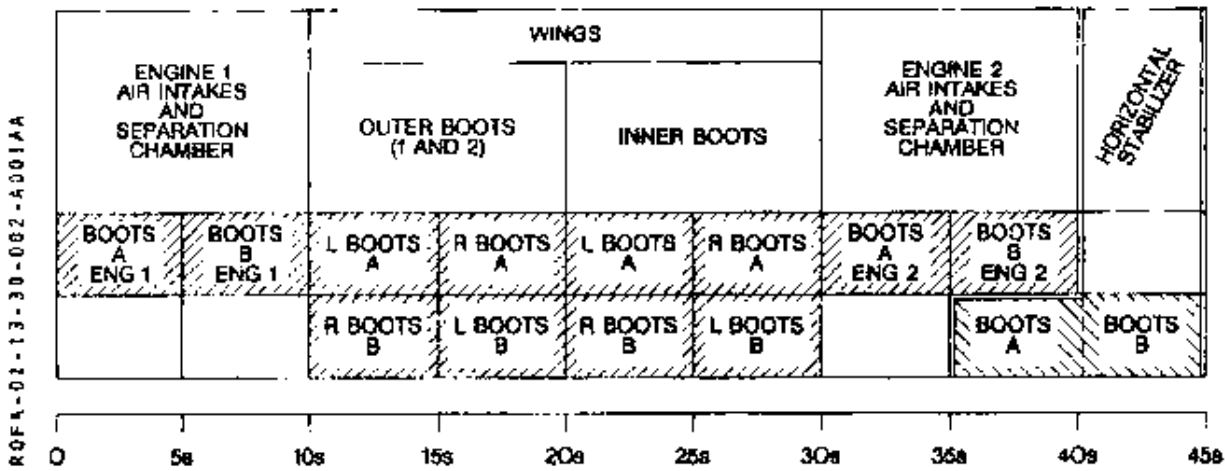

- R BEGINNING OF THE FOLLOWING SEQUENCE AT 60 SEC (FAST MODE)

Note : When de icing OVRD mode is selected, boots inflate according to a separate timer and MFC is totally by passed.

	ICE AND RAIN PROTECTION	1.13.30		
	ENGINE AND WING PROTECTION	P 3	080	
				JUL 98

AA

30.2 CONTROLS

ENGINE/WING DE ICING PANEL

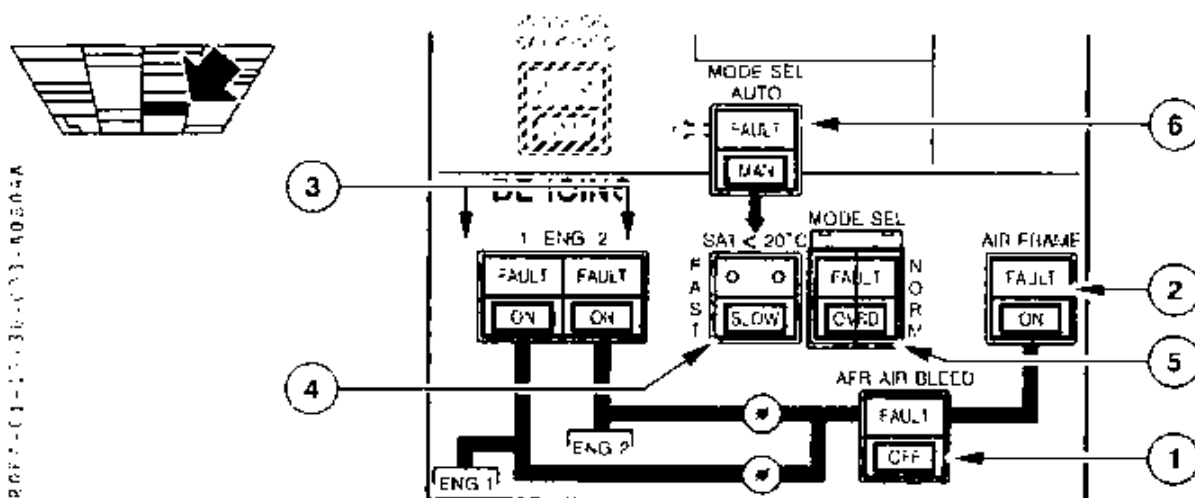

R077-C1-1-1-30-03-005044

① AIRFRAME AIR BLEED pb

Controls both de ice and isolation valves.

Pb pressed in Normal operation.

Both DE ICE and ISOLATION VALVES are open.

OFF (pb released) OFF light comes on white.

Both DE ICE and isolation valves are closed.

R However engine de-icing may be used (engine de-icing selected ON will open de-ice valve).

But airframe de-icing is never available.

FAULT The light illuminates amber and the CCAS is activated when :

- Air pressure downstream of the de-ice valves stays below 14 PSI for more than 10 seconds.
- Inflation sequencing of airframe boots A or B is not correct.
- Air temperature upstream of the de-ice valves exceeds 230°C.

The alert is inhibited when pb is released.

② AIRFRAME pb

Controls the outputs A and B of both wings and stabilizers distribution valves.

ON (pb pressed in) Signal is sent to the MFC in order to initiate a de-icing cycle depending on MODE SEL pb.

ON light illuminates blue.

Pb released In normal operation. Associated boots stay deflated.

FAULT The light illuminates amber and the CCAS is activated when :

- Associated distribution valve output has been controlled open but no downstream pressure has been detected, or
- Associated distribution valve output has been controlled closed but a downstream pressure is detected.

	ICE AND RAIN PROTECTION	1.13.30		
		P 4	080	
	ENGINE AND WING PROTECTION			JUN 97

AA

③ ENGINE_pbs

Control de-ice valves, as well as the outputs A and B of respective engine distribution valves.

ON (pb pressed in) De-ice valve is controlled open even if Airframe Airbleed is not selected ON, and a signal is sent to the MFC in order to initiate a cycle. ON light illuminates blue.

Pb released Associated boots stay deflated. Also controls associated de-ice valve in closed position, after Airframe Airbleed FAULT and ENG FAULT.

FAULT Light illuminates amber and CCAS is activated when :

- Associated distribution valve output has been controlled open but no downstream pressure has been detected, or
- Associated distribution valve output has been controlled closed but a downstream pressure is detected.
- AIRFRAME AIRBLEED pb selected OFF and air temperature upstream of the de-ice valve exceeds 230°C.
- Inflation sequencing of engine boots A or B is not correct.

④ DE ICING MODE SEL pb

Controls the selection of wings/engines boots inflation cycles when MAN is selected on MODE SEL AUTO pb ⑥

FAST (pb released) timing cycle = 60 s

SLOW (pb pressed in) timing cycle = 180 s - SLOW light illuminates blue.

⑤ DE-ICING OVERRIDE guarded pb

Controls the emergency de-icing operation.

The control panel enables control of all double valves (ENG and AIR FRAME).

NORM (pb released) Normal operation

OVRD (pb pressed in) The emergency de-icing activation is selected (timing cycle = 60 s), the light illuminates white and all de-icing lights extinguish. This position is used when the associated FAULT light illuminates.

FAULT The light illuminates amber when both MFC modules associated to air intake boots control fail resulting in an incorrect inflation sequencing.

	ICE AND RAIN PROTECTION	1.13.30		
		P 4A	080	
	ENGINE AND WING PROTECTION			JUL 01

AA

④ MODE SEL AUTO pb

Pb released Normal operation (automatic operating mode). The DE-ICING MODE SEL pb ④ is inoperative.

R
R

The cycle selection is provided ADC1, MFC1B, ADC2 and MFC2B
FAULT Illuminates amber and the CCAS is activated when MFC (1B or 2B) and/or ADC failure occurs. The DE-ICING MODE SEL pb ④ is inoperative.

In this case the FAST mode is automatically activated.

MAN (pb pressed in) The DE-ICING MODE SEL pb ④ is operative and allows the crew to select the appropriate timing cycle depending on SAT. MAN illuminates white.

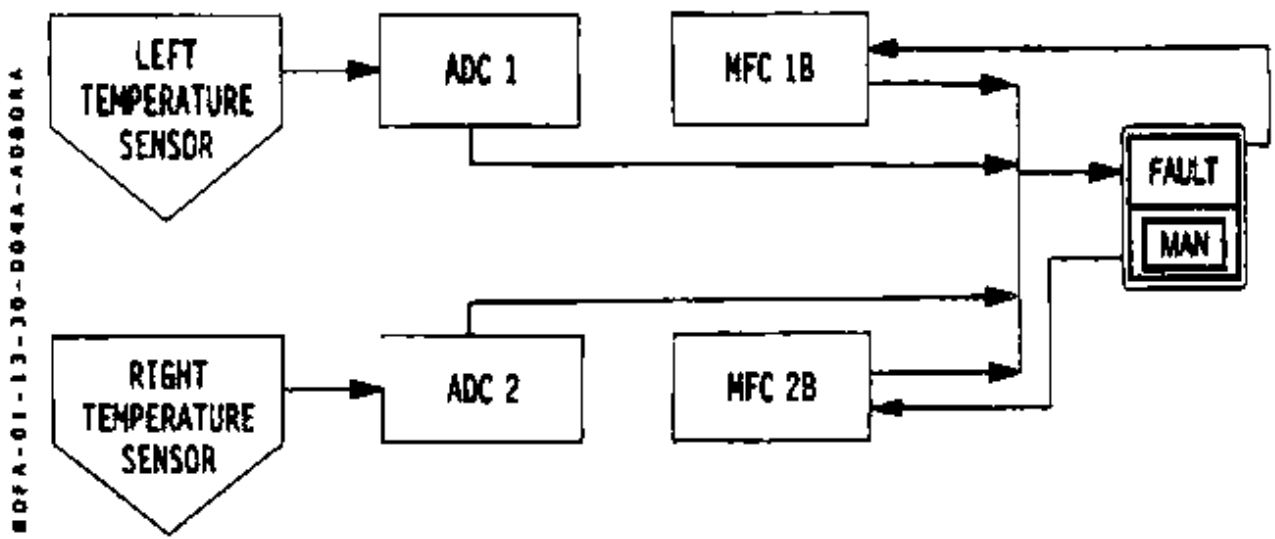

	ICE AND RAIN PROTECTION	1.13.30		
	ENGINE AND WING PROTECTION	P 5	001	
				DEC 96

AB

HORNS ANTI ICING PANEL



R0FA-01-13-30-005-A001A7

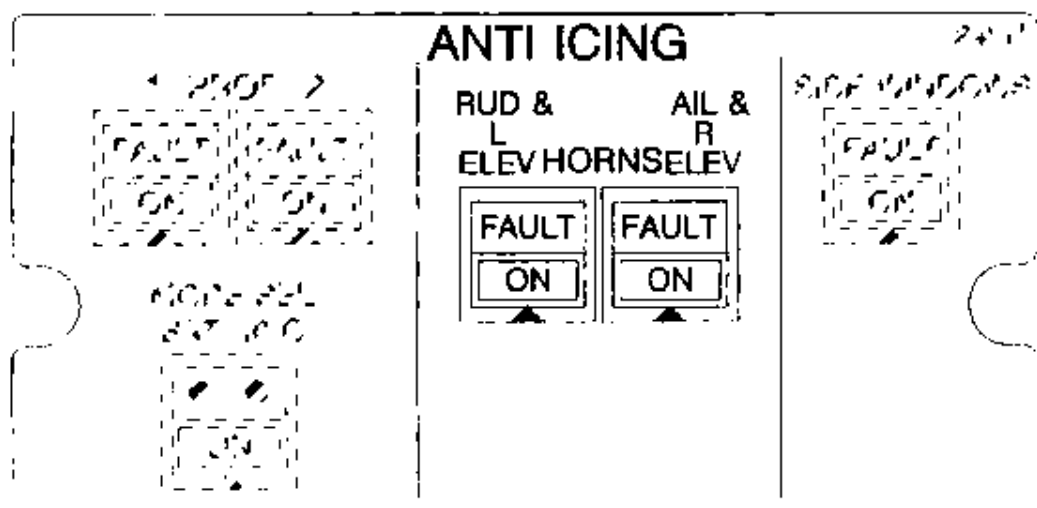

HORNS ANTI ICING pbs

Controls activation of following units :

- RUD and L ELEV : Rudder and left elevator horns anti icing
- AIL and R ELEV : Ailerons and right elevator horns anti icing

ON (pb pressed in) : associated anti icing units are activated. ON light illuminates blue.

OFF (pb released) : associated anti icing units are deactivated.

FAULT The light illuminates amber and the CCAS is activated when electrical power is lost on one of the associated units.

Note : As soon as at least one of the HORNS anti-icing p.b. is selected ON, stall alert threshold is reduced (refer FCOM 1.02).

Horns heating are inhibited on ground.

	ICE AND RAIN PROTECTION	1.13.30	
		P 6	001
	ENGINE AND WING PROTECTION		DEC 96

30.3 ELECTRICAL SUPPLY/MFC LOGIC/SYSTEM MONITORING

ELECTRICAL SUPPLY

EQUIPMENT	DC BUS SUPPLY (C/B)	AC BUS SUPPLY (C/B)
De ice valves	DC BUS 2 (on lateral panel SO and REG VALVE 1 and 2)	- Nil -
Isolation valves	DC ESS BUS (on lateral panel ISOL VALVE 1 and 2)	- Nil -
Distribution valves (Boots A + ENG 1)	DC EMER BUS (on lateral panel ENG 1 and AFR-BOOTS A SPLY)	- Nil -
Distribution valves (Boots B + ENG 2)	DC BUS 2 (on lateral panel ENG 2 and AFR-BOOTS B NORM SPLY) and DC EMER BUS (BACK UP) (on lateral panel ENG 2 and AFR-BOOTS B EMER SPLY)	Nil -
Controls and alerts	DC EMER BUS (on lateral panel CTL and CAUTION)	
Left elevator and rudder horns anti icing	- Nil -	115 VAC wild BUS 1 (on lateral panel L ELEV RUD)
Left elevator and rudder horns anti icing control	DC EMER BUS (on lateral panel L ELEV and RUD)	- Nil -
Right elevator and ailerons horns anti icing	- Nil -	115 VAC wild BUS 2 (on lateral panel R ELEV R AIL L AIL)
Right elevator and ailerons horns anti icing control	DC EMER BUS (on lateral panel R ELEV and AIL)	- Nil -

MFC LOGIC

See chapter 1.01.

	ICE AND RAIN PROTECTION	1.13.30		
		P 7/8	080	
	ENGINE AND WING PROTECTION			JUL 01

AA

SYSTEM MONITORING

The following conditions are monitored by visual and aural alerts :

- LOW pressure in the de icing common air manifold ($P < 14$ PSI and $t > 6s$) or over temperature ($T > 230^{\circ}C$) upstream the pressure regulating valve.
 - See AIRFRAME AIR BLEED FAULT procedure in chapter 2.05.09.
- Distribution valve output controlled open but no downstream pressure detected or controlled closed but downstream pressure detected.
 - See AIRFRAME DE ICING or ENG DE or ANTI-ICING FAULT procedure in chapter 2.05.09.
- Power loss on a horn anti-icing unit
 - See HORNS ANTI ICING FAULT procedure in chapter 2.05.09.
- Boots do not operate following MFC failure or both boots A and B of the same engine are supplied 200 sec after eng cycle beginning or Boots A (B) of both engines are supplied while boots B (A) are not supplied 20 sec after eng. cycle beginning.
 - See DE ICING MODE SEL FAULT procedure in chapter 2.05.09.
- R - MFC 1B or 2B and/or ADC failure. Discrepancy between outputs
 - See MODE SEL AUTO FAULT procedure in chapter 2.05.09.

30.4 SCHEMATIC

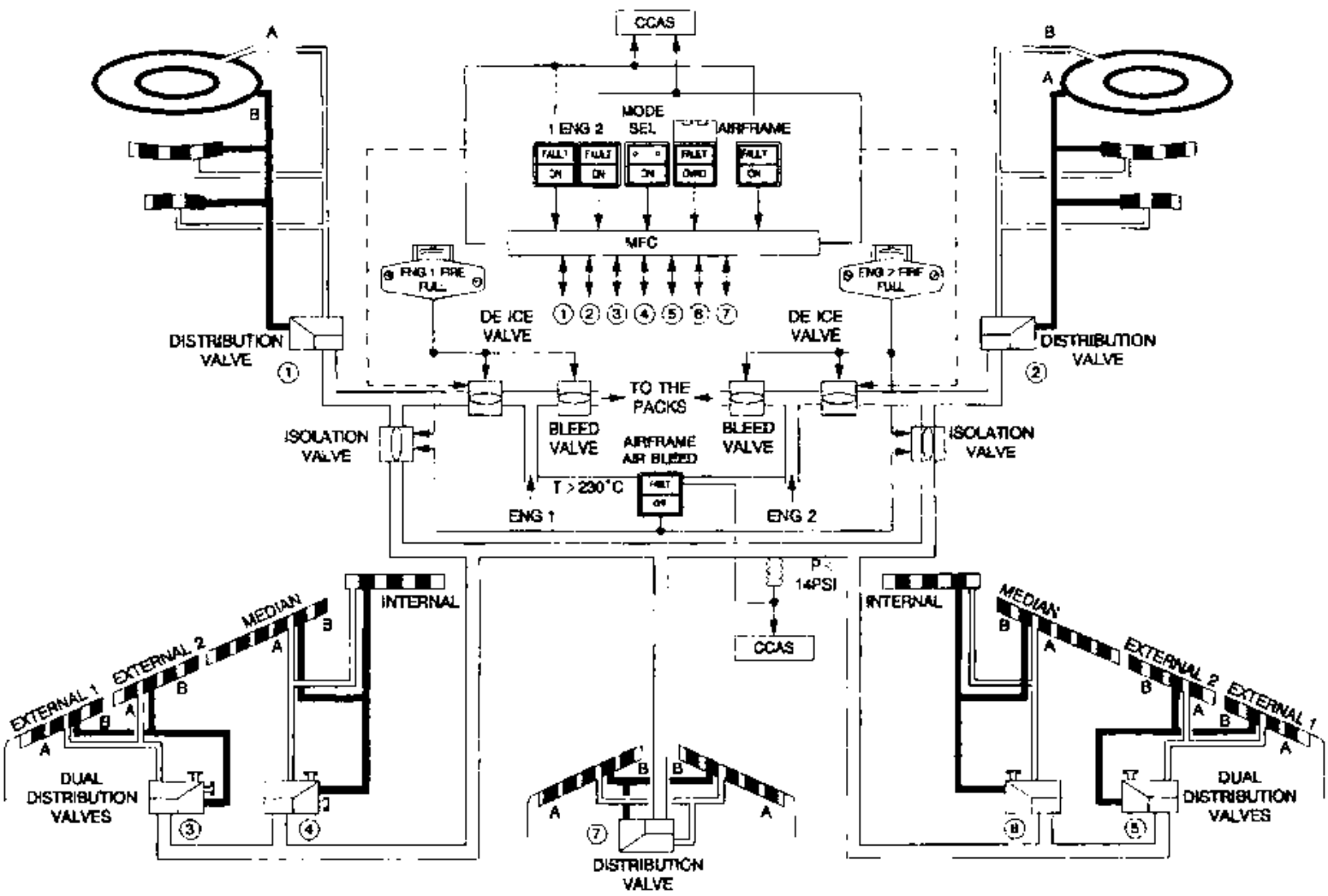

ROFA-01-13-30-009-A028AX



ATR72
F.C.O.M.

ICE AND RAIN PROTECTION

PROPELLER ANTI ICING

1.13.40

P 1

500

JUN 97

AA

40.1 DESCRIPTION

Propeller anti icing is performed by resistors installed near the surface of the inboard sections of the blade leading edges.

On each propeller, the heat elements are electrically connected in three blades (every other blade).

The system is supplied with 115 ACW. Two modes are available and automatically selected depending on the temperature.

TIME SEQUENCE DIAGRAM

MODE SEL : NORMAL OPERATION

LOW POWER CYCLE

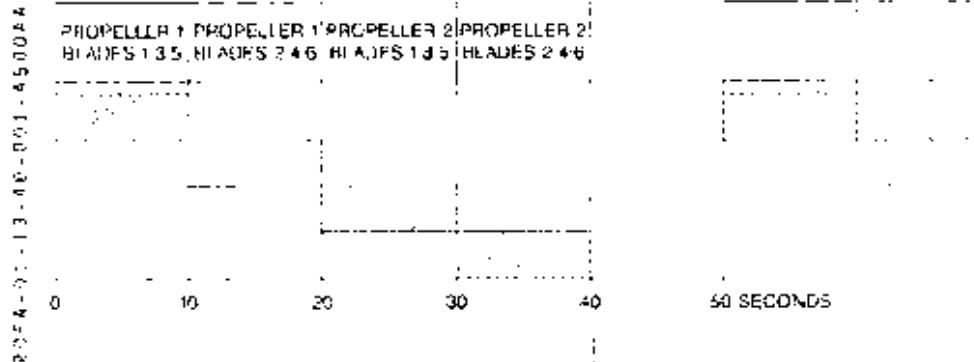

MODE SEL : ON

HIGH POWER CYCLE

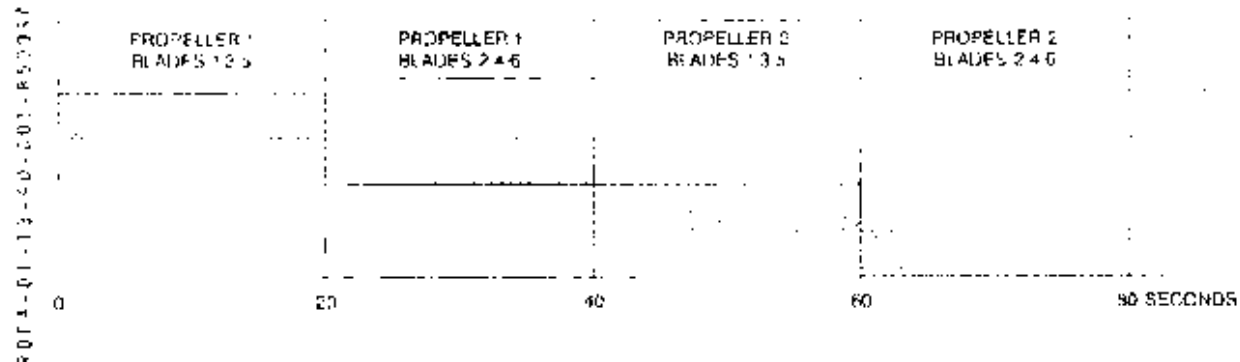

	ICE AND RAIN PROTECTION	1.13.40		
		P 2	550	
	PROPELLER ANTI ICING			JUN 97

AA

40.2 CONTROLS

PROPELLER ANTI ICING PANEL

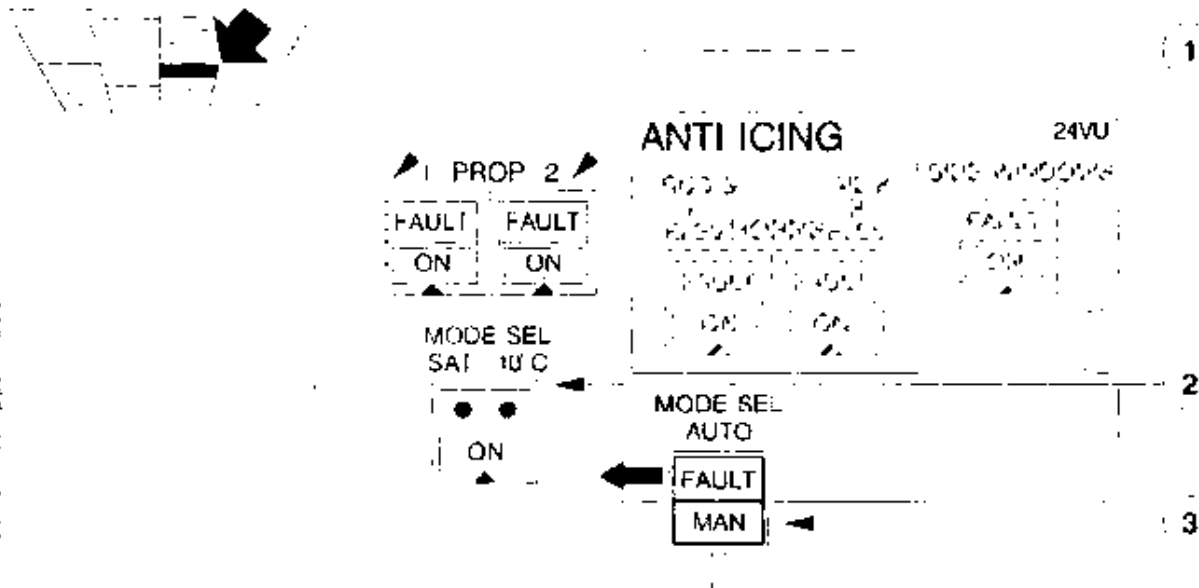

① PROP pb

Controls the respective propeller heating elements.

ON (pb pressed in), the heating units are supplied. The ON light illuminates blue.

pb released The heating elements are not supplied.

FAULT The light illuminates amber to indicate that at least one blade is not electrically supplied.

② ANTI-ICING MODE SEL pb

Controls the duration of propeller anti icing cycles when **MAN** is selected on **MODE SEL AUTO** pb ③.

pb released **LOW POWER** cycle is selected.

ON (pb pressed in) **HIGH POWER** cycle is selected. The ON It illuminates blue.

- Note :**
- **LOW POWER** has to be selected when temperature is between 0°C (32°F) and -10°C (14°F).
 - **HIGH POWER** has to be selected when temperature is between -10°C (14°F) and -30°C (-22°F).
 - Below -30°C (-22°F) icing problems should be non existant (no supercooled water).

	ICE AND RAIN PROTECTION	1.13.40		
	PROPELLER ANTI ICING	P 2A	080	
				JUL 01

AA

③ MODE SEL AUTO pb (same pb as ENGINE AND WING PROTECTION)

pb released Normal operation (automatic operating mode)

The ANTI-ICING MODE SEL pb ② is inoperative.

R The cycle selection is provided by ADC 1, MFC 1B, ADC 2 and
R MFC 2B

R **FAULT** Illuminates amber and the CCAS is activated when MFC (1B or 2B)
R and/or ADC failure occurs (see schematic 1.13.30 p 4A).

The ANTI-ICING MODE SEL pb ② is inoperative. In this case, the HIGH POWER CYCLE is automatically activated.

MAN (pb pressed in) The ANTI-ICING MODE SEL pb ② is operative and allows the crew to select the appropriate timing cycle depending on SAT. MAN illuminates white.

	ICE AND RAIN PROTECTION	1.13.40		
		P 3	080	
	PROPELLER ANTI ICING			JUL 01

AA

40.3 ELECTRICAL SUPPLY/MFC LOGIC/SYSTEM MONITORING

ELECTRICAL SUPPLY

EQUIPMENT	DC BUS SUPPLY (C/B)	AC BUS SUPPLY (C/B)
Propeller 1 anti-icing PWR	- Nil -	AC wild BUS 1 (on lateral panel PROP1 ANTI ICING PWR SPLY
Propeller 2 anti-icing PWR	- Nil -	AC wild BUS 2 (on lateral panel PROP2 ANTI ICING PWR SPLY
Prop anti-icing CTL and Ind	DC EMER BUS (on lateral panel PROP CTL and IND)	

Note : Propeller anti icing is inhibited when N_p is below 63%.

MFC LOGIC

See chapter 1.01.

SYSTEM MONITORING

The following conditions are monitored by visual and aural alerts :

- One or more blade heating unit (s) inoperative.
 - See PROP ANTI-ICING FAULT procedure in chapter 2.05.09.
- MFC 1B or 2B and/or ADC failure, discrepancy between outputs.
 - See MODE SEL AUTO FAULT procedure in chapter 2.05.09.

	ICE AND RAIN PROTECTION	1.13.40		
		P 4	001	
	PROPELLER ANTI-ICING			DEC 96

AA

40.4 LATERAL MAINTENANCE PANEL

On the RH Maintenance panel, controls are provided for maintenance purposes only, to check propeller anti-icing system.

PROPELLER ANTI-ICING TEST PUSH-BUTTON

R0FA-01-13-40-004-A001A

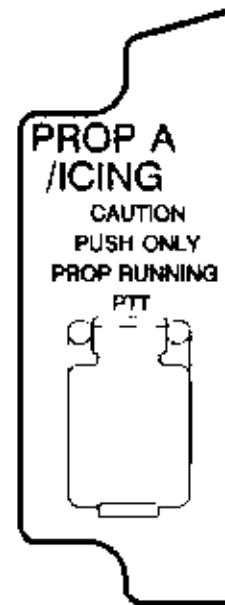
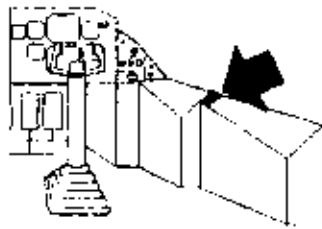

This guarded push-button is used to check the propeller anti-icing system functioning. It must only be operated on ground, with propellers above 63 % NP.

Test procedure :

- Aircraft on ground, propellers > 63 % NP.
- Mode select (overhead panel) : NORM.
- Push test Button.
- The system performs a short anti-icing cycle.

	ICE AND RAIN PROTECTION WINDOW HEAT	1.13.50		
		P 1	001	
				DEC 96

50.1 DESCRIPTION

The cockpit windows are electrically heated :

- The front windshields for ice protection and defogging.
- The side windows for defogging only.

The front windshields are protected against ice formation by an electrically heated transparent film incorporated between two plies of glass. It is supplied with 200 VACW, and temperature is controlled by an electronic controller which keeps the outer windshield temperature over 2°C (35°F). The inner surface remains above 21°C (70°F) to prevent mist formation.

The side windows are protected by an electrically heated system consisting of small wires embedded between two plies of glass. It is supplied with 28 volts DC and keeps the inner temperature over 21°C (70°F).

50.2 CONTROLS

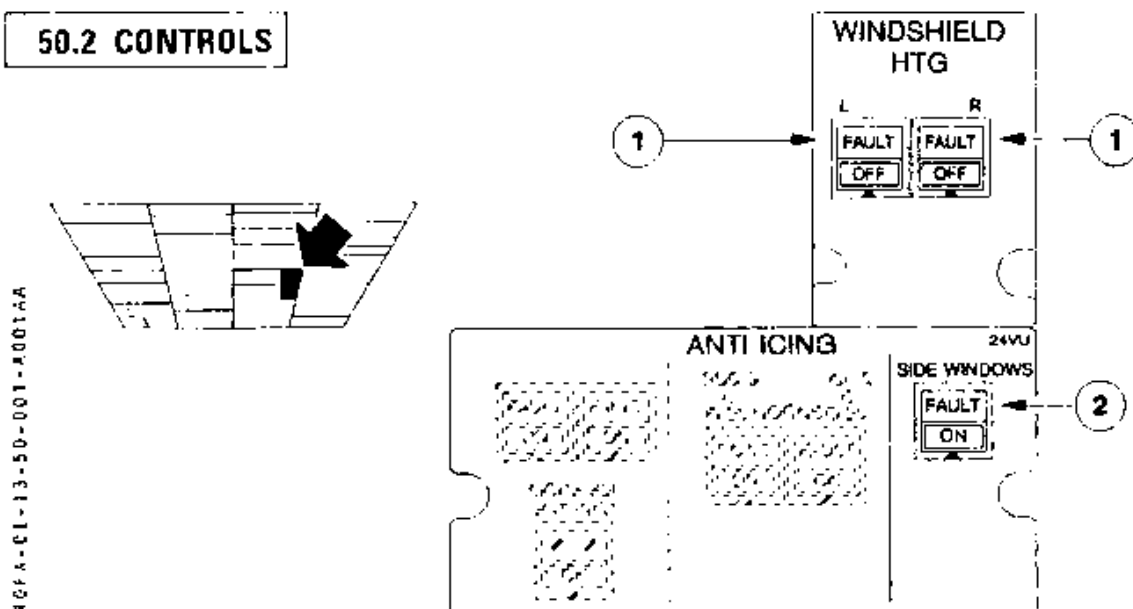

① WINDSHIELD HTG L or R pb

Controls activation of window heat systems :

- | | |
|---------------|---|
| Pb pressed in | Power is supplied to the associated window heat system. |
| OFF | (pb released) Window heat system is deactivated. The OFF light illuminates white. |
| FAULT | The light illuminates amber and the CCAS is activated when there is a power loss. The light also illuminates during MFC test. |

② SIDE WINDOWS pb

Controls activation of side windows heat systems.

- | | |
|-------------|---|
| ON | (pb pressed in) Power is supplied to both side windows heat systems. ON light illuminates blue. |
| Pb released | Side windows heat systems are deactivated. |
| FAULT | The light illuminates amber and the CCAS is activated when there is a power loss. |

	ICE AND RAIN PROTECTION	1.13.50		
		P 2	001	
	WINDOW HEAT			DEC 96

50.3 ELECTRICAL SUPPLY/MFC LOGIC/SYSTEM MONITORING

ELECTRICAL SUPPLY

EQUIPMENT	DC BUS SUPPLY (C/B)	AC BUS SUPPLY (C/B)
LH Front windshield supply	-- Nil	AC Wild BUS 1 (on lateral panel L FRONT WINDOW HTG)
Front windshield control	-- Nil --	ACW BUS 1 (on lateral panel FRONT CTL and CAUTION)
Front windshield alert	DC BUS 2 (on lateral panel WDSHLD IND L)	-- Nil --
Side window supply and control	DC BUS 1 (on lateral panel SIDE WDO L CTL)	-- Nil --
RH Front windshield supply	-- Nil --	AC wild BUS 2 (on lateral panel R FRONT WINDOW HTG)
Front windshield control	-- Nil --	ACW BUS 2 (on lateral panel FRONT CTL and CAUTION)
Front windshield alert	DC BUS 1 (on lateral panel WDSHLD IND R)	Nil --
Side window supply and control	DC BUS 2 (on lateral panel SIDE WDO R CTL)	-- Nil --
Side windows alert	DC ESS BUS (on lateral panel side window CAUTION)	-- Nil --

MFC LOGIC

See chapter 1.01.

SYSTEM MONITORING

The following condition is monitored by visual and aural alerts :

- Loss of window heating.
 - See WINDOW HTG FAULT procedure in chapter 2.05.09.

	ICE AND RAIN PROTECTION	1.13.60		
		P 1	001	
	PROBE HEAT			DEC 96

60.1 DESCRIPTION

To prevent icing on air data sensors, electrical heating is provided for :

- CAPT, F/O, STBY pitot tubes
- CAPT, F/O, STBY left and right static ports
- F/O alpha (angle of attack) probe
- CAPT alpha (angle of attack) probe
- TAT probes

The probes are heated both on the ground and in flight, except TAT sensors heating which are inhibited on the ground.

60.2 CONTROLS

PROBE HEAT PANEL

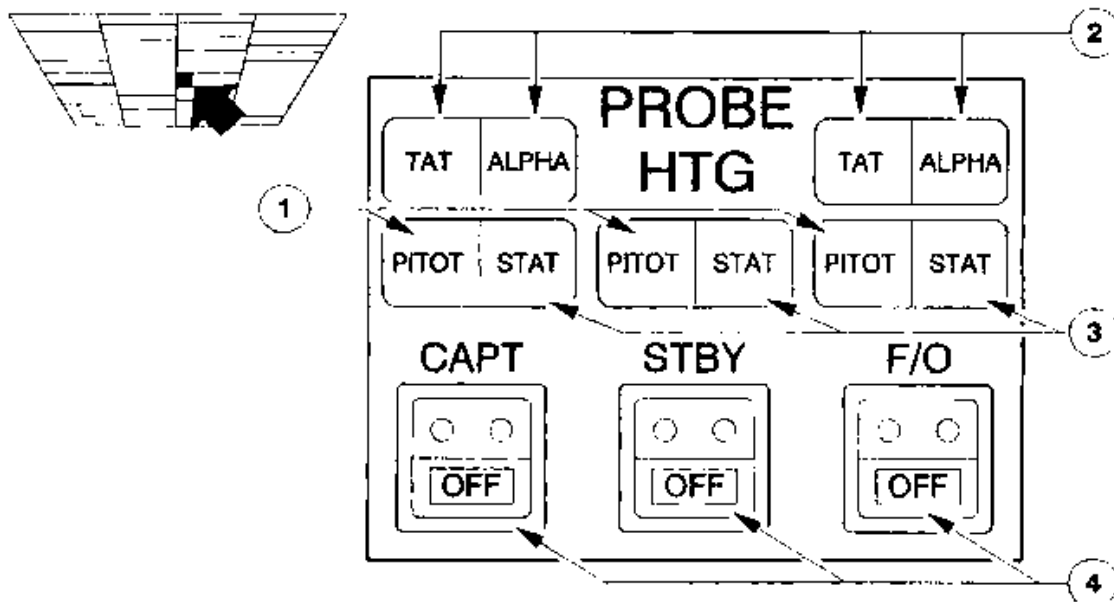

90FA-01-13-60-001-K0012A

① PITOT lights

Illuminate amber and the CCAS is activated if :

- In flight or on the ground, the associated pitot is not heated

② ALPHA, TAT lights

Illuminates amber on the CCAS is activated when the respective probe is not heated.

③ STAT lights

Illuminate amber and the CCAS is activated when the respective probe is not heated. In flight, static ports are not monitored by CCAS.

④ CAPT STBY F/O pbs

Control the activation of probe heating of their respective circuits.

ON : (pb pressed in) Probe heating is activated.

OFF : (pb released) Probe heating is deactivated. OFF light illuminates white.

Respective PROBE HEAT light illuminates amber

	ICE AND RAIN PROTECTION	1.13.60		
		P 2	001	
	PROBE HEAT			DEC 96

AA

60.3 ELECTRICAL SUPPLY/SYSTEM MONITORING

ELECTRICAL SUPPLY

EQUIPMENT	DC BUS SUPPLY (C/B)	AC BUS SUPPLY (C/B)
CAPT		ACW BUS 1 (on lateral panel PITOT)
Pitot tubes	- Nil -	ACW BUS 1 (on lateral panel ALPHA)
Alpha probe	Nil -	- Nil -
Static ports	DC BUS 1 (on lateral panel)	- Nil -
Alerts	DC ESS BUS (on lateral alert CAUTION)	- Nil -
TAT probe	- Nil -	ACW BUS 1 (on lateral panel CPT TAT)
F/O		ACW BUS 2 (on lateral panel PITOT)
Pitot tubes	- Nil -	ACW BUS 2 (on lateral panel ALPHA)
Alpha probe	- Nil -	- Nil
Static ports	DC BUS 2 (on lateral panel)	- Nil -
Alerts	DC BUS 2 (on lateral panel CAUTION)	- Nil -
TAT probe	- Nil -	ACW BUS 2 (on lateral panel F/O TAT)
STBY		ACW BUS 1 and 115 VAC STBY BUS (on lateral panel STBY PITOT NORM SPLY and EMER SPLY)
Pitot tube	- Nil -	- Nil -
Static ports	DC BUS 1 (on lateral panel LEFT, RIGHT)	- Nil -
Alerts	DC ESS BUS (on lateral panel CAUTION)	- Nil -

SYSTEM MONITORING

The following condition is monitored by visual and aural alerts :

- Probe (s) not heated

- See ALPHA PROBE HTG FAULT procedure or PROBE HTG FAULT (except ALPHA PROBES) procedure in chapter 2.05.09.

 AR72 F.C.O.M.	ICE AND RAIN PROTECTION	1.13.70		
	RAIN PROTECTION	P 1	001	
				JUL 98

AA

70.1 DESCRIPTION

Rain removal from front windshields is provided by two wipers : each wiper is driven by a two speed electric motor. They are controlled by two WIPER selectors on the overhead panel : one for the Captain, and one for the F/O. Maximum speed to operate the wipers is 160 kt.

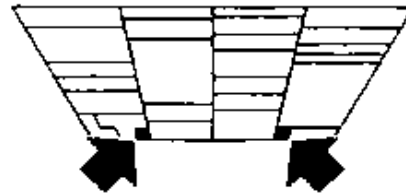
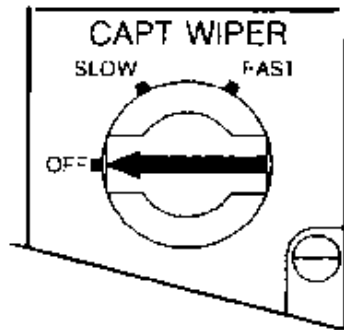
70.2 CONTROLS
R
R
R
R
R
R
R
R
R
R
WIPER rotary selector

Controls the windshield wiper on the associated side.

FAST wiper operates at 130 cycles/mn.

SLOW wiper operates at 80 cycles/mn.

OFF wiper operation stops at the end-of-travel (Park) position.

70.3 ELECTRICAL SUPPLY

EQUIPMENT	DC BUS SUPPLY (C/B)
Captain wiper	DC ESS BUS (on lateral panel CAPT)
F/O wiper	DC BUS 2 (on lateral panel F/O)

 AR72 F.C.O.M.	LANDING GEAR	1.14.00		
	CONTENTS	P 1	001	
				DEC 96

AA

1.14.00 CONTENTS

1.14.10 GENERAL

1.14.20 LANDING GEAR

- 20.1 DESCRIPTION
- 20.2 CONTROLS
- 20.3 ELECTRICAL SUPPLY/MFC LOGIC/SYSTEM MONITORING
- 20.4 LATERAL MAINTENANCE PANEL

1.14.30 NOSE WHEEL STEERING

- 30.1 DESCRIPTION
- 30.2 CONTROLS
- 30.3 ELECTRICAL SUPPLY
- 30.4 SCHEMATIC

1.14.40 BRAKES ANTI SKID

- 40.1 DESCRIPTION
- 40.2 CONTROLS
- 40.3 ELECTRICAL SUPPLY/SYSTEM MONITORING
- 40.4 LATERAL MAINTENANCE PANEL
- 40.5 SCHEMATIC

 A320 F.C.O.M.	LANDING GEAR	1.14.10		
	GENERAL	P 1	001	
				DEC 96

AA

The landing gear consists of a forward retracting nose gear and two retractable main gears mounted partially in the side pods and partially in the fuselage. They are hydraulically operated. Gear doors enclose the landing gear bays.

Each main gear assembly has an oleopneumatic shock absorber and is equipped with two wheels. Each main wheel is fitted with brakes and anti-skid.

The two wheel nose gear assembly includes an oleopneumatic shock absorber and a nose wheel steering system.

In case of hydraulic or electrical power supply failure, the landing gear may be extended by gravity.

	LANDING GEAR		1.14.20	
	P 1	001		
	LANDING GEAR		DEC 96	

AA

20.1 DESCRIPTION

MAIN LANDING GEAR

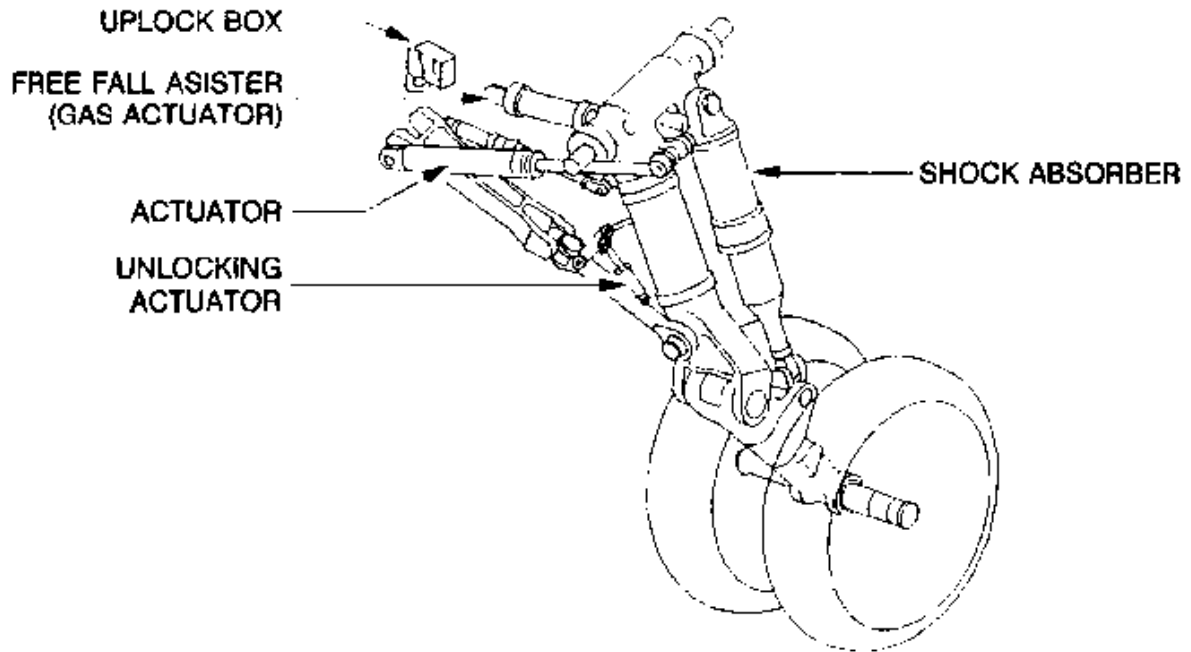

NOSE LANDING GEAR

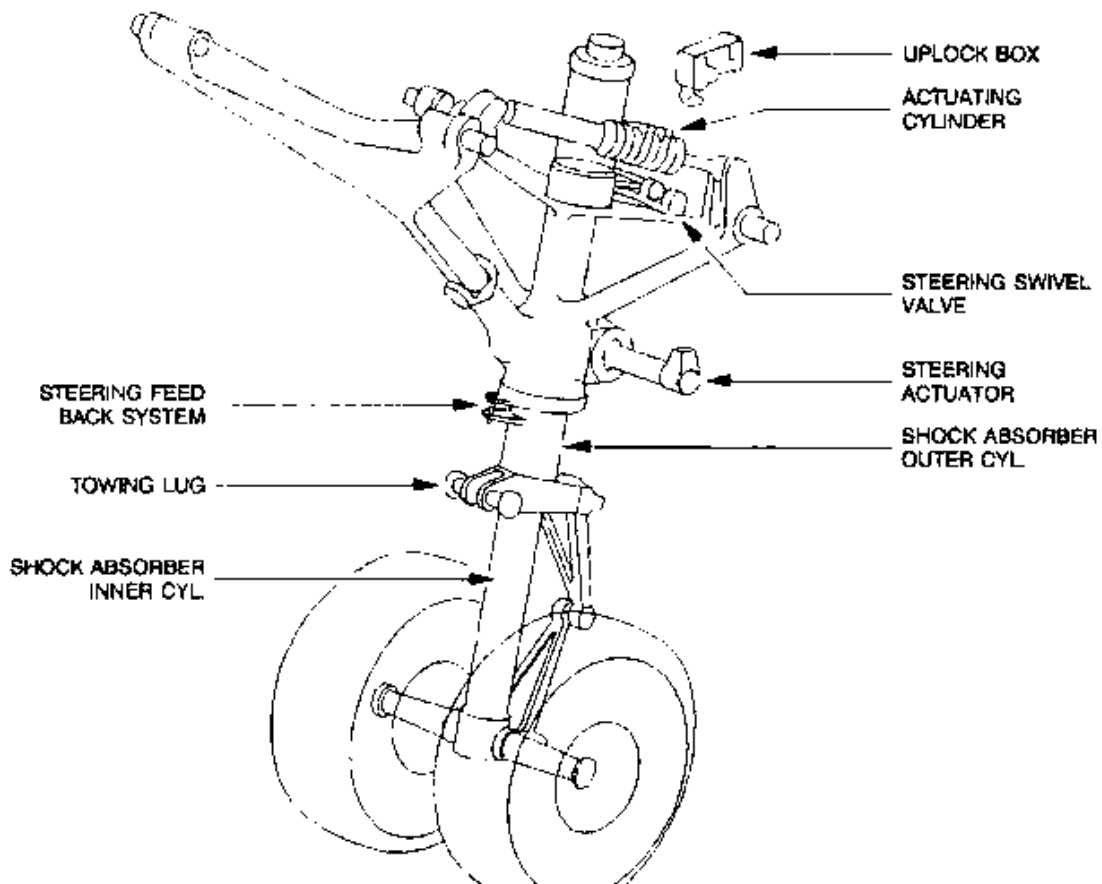

	LANDING GEAR	1.14.20		
		P 2	001	
	LANDING GEAR			DEC 96

MAIN LANDING GEAR DOORS

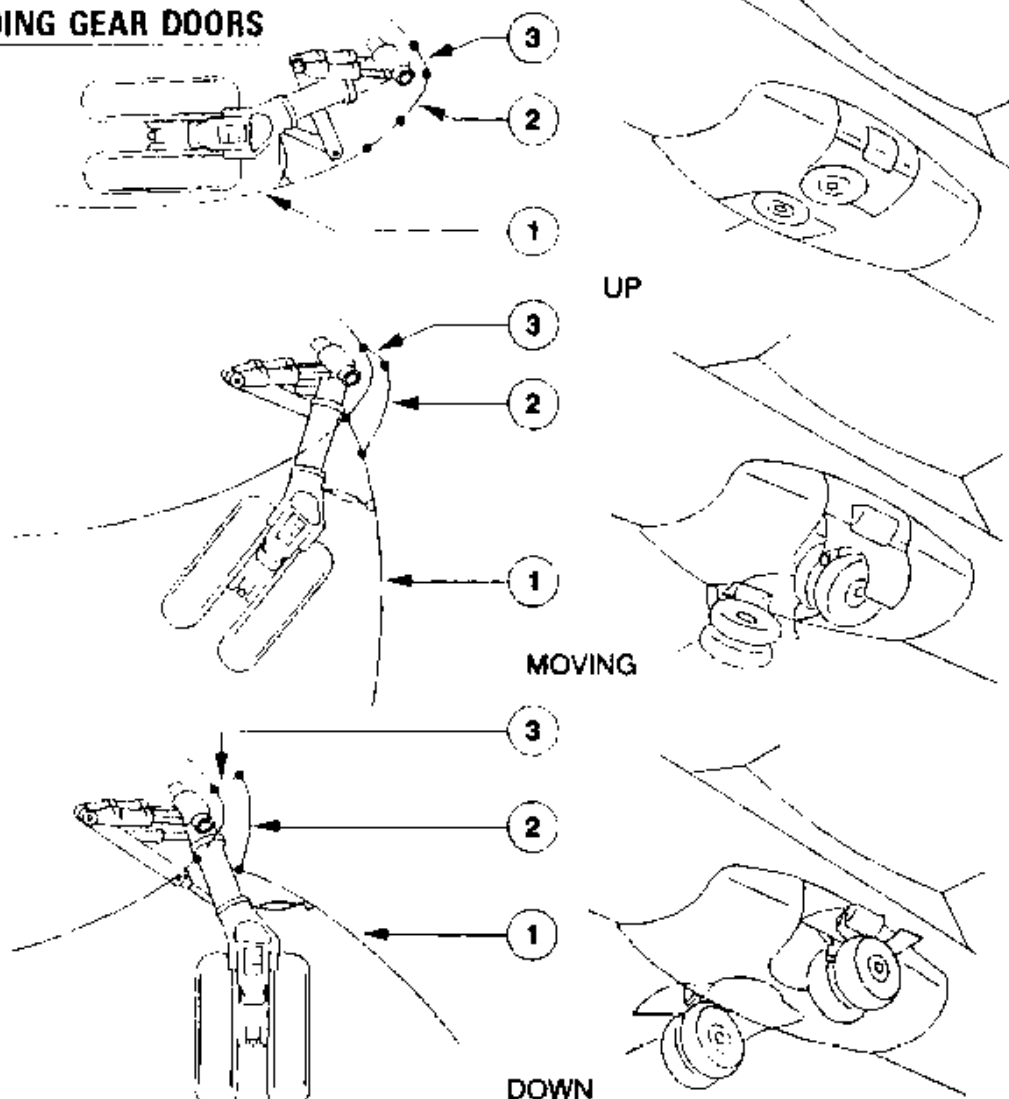

GEAR POSITION DETECTION AND INDICATION SYSTEMS

The landing gear position detection and indication systems consist of two independant systems.

Primary system is managed by MFC module 1A. The associated gear position is displayed on the main instrument panel.

Secondary system is managed by MFC module 2A. The associated gear position is displayed on the overhead panel.

Each system uses its own detectors and indications :

- down lock and air/ground signals from proximity sensors,
- up lock signal from mechanical limit switches.

Each system commands gear extension and retraction, gear anti-retraction system and the warning associated to "LDG GEAR NOT DOWN".

Note : Gear must be considered down when one system indicates three green lights (▼)

Each system has its own WOW circuit : WOW 1 into MFC module 1B and WOW 2 into MFC module 2B.

The WOW signals are used by the MFC to have the system using WOW informations switched to the appropriate air/ground configuration.

	LANDING GEAR		1.14.20	
	P 3	070		
	LANDING GEAR		DEC 96	

AA

GEAR NORMAL OPERATION

Landing gear extension and retraction is performed by a control lever located on the center instrument panel.

The MFC electrically controls the landing gear selector valve located in the LH main landing gear fairing. This valve supplies hydraulic pressure (green system) to :

- Gear extension hydraulic line. The retraction line is then connected to tank return for extension.
- Gear retraction hydraulic line. The extension line is then connected to tank return for retraction.

Note 1 : The main gear wheels are automatically braked as soon as the lever is selected up.

Note 2 : As soon as the gear is locked in the selected position, hydraulic pressure is released from the connecting line.

Uplocking is mechanically achieved. Unlocking is hydraulically achieved.

Down locking is achieved by means of a dual alignment folding side brace. Locking springs act as secondary alignment and ensure locking independently of hydraulic pressure availability. Unlocking is hydraulically achieved.

Each main gear incorporates a door mechanism linked to it. The door is therefore operated by the gear during retraction and extension.

Four doors close off the nose gear well and restore the fuselage profile. The doors are actuated mechanically by the gear itself. The two forward doors will be closed after gear extension while the two aft will remain open.

Landing gear can not be retracted as long as least one gear shock absorber senses weight on wheels.

GEAR EMERGENCY EXTENSION

In the event of normal system failure the landing gear can be extended mechanically. The system is controlled from the flight compartment by means of a push/pull handle which permits landing gear mechanical unlocking. The landing gear extends due to gravity and aerodynamic forces. Main landing gear extension is assisted by a gas actuator. Nose landing gear is assisted by a mechanical device.

 ATR 72 F.C.O.M.	LANDING GEAR		1.14.20		
			P 4	001	
	LANDING GEAR				DEC 96

20.2 CONTROLS

LDG GEAR CONTROL PANEL

ROFA-01-14-20-004-A001AA

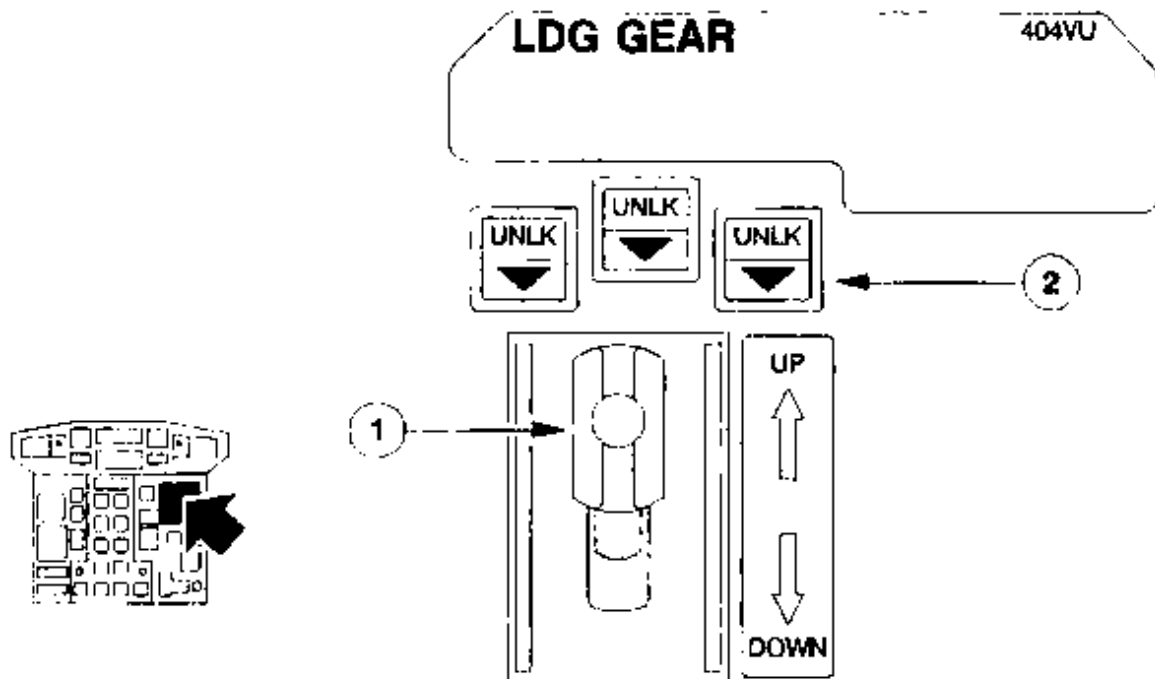

① Landing gear control lever

The lever must be pulled out prior to selecting one of the two possible positions :

Up The landing gear retraction is selected.

Down The landing gear extension is selected.

A red light is incorporated in the lever. Light will illuminate and the CCAS will be activated through the MFC, whenever any gear is not sensed down and locked by the detection system.

② Landing gear position ind.

Displays the gear position as seen by MFC 1. ▽ illuminates green when respective down lock is sensed engaged. UNLK illuminates red when respective gear is not locked in the lever selected position or, if on the ground, the uplock box is not in the open position.

 ATR72 F.C.O.M.	LANDING GEAR	1.14.20		
		P 5	001	
	LANDING GEAR			DEC 96

AA

LDG GEAR POSITION IND OVERHEAD PANEL



ROFA-01-14-20-005-A001A4

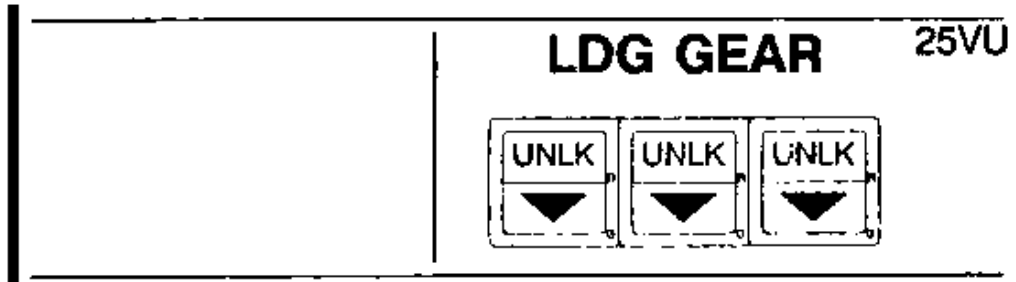

Displays the gear position as sensed by MFC 2. ▽ illuminates green when respective down lock is engaged. UNLK illuminates red when respective gear is not locked in the lever selected position, or if on ground, the UPLOCK box is not in the open position.

LDG GEAR EMERGENCY EXTENSION HANDLE

ROFA-01-14-20-005-B001A4

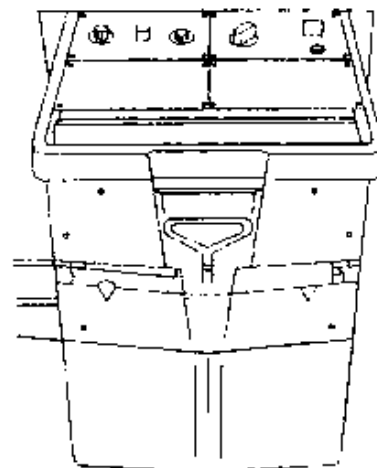

Pulling the handle above the pedestal level will unlock the landing gear.

	LANDING GEAR	1.14.20		
		P 6	001	
	LANDING GEAR			DEC 96

20.3 ELECTRICAL SUPPLY/MFC LOGIC/SYSTEM MONITORING

ELECTRICAL SUPPLY

EQUIPMENT	DC BUS SUPPLY (C/B)
Primary detection system Landing gear CTL Ind and alert	DC STBY BUS (on lateral panel LDG GEAR CTL)
Secondary detection system Ind and Alert	DC BUS 2 (on lateral panel IND and WARNING)
Weight on wheels (air/ground detection) System 1	DC EMER BUS (on lateral panel WOW SYS 1)
System 2	DC BUS 2 (on lateral panel WOW SYS 2)

MFC LOGIC See chapter 1.01

SYSTEM MONITORING

The following conditions are monitored by visual and aural alerts :

- Any gear not seen down locked, and FLAPS normal landing position, and ZRA < 500ft
 - See L/G UNSAFE INDICATION procedure in chapter 2.05.07.
- Any gear not seen down locked, and at least one PL at Fl, and ZRA < 500 ft
 - See L/G UNSAFE INDICATION procedure in chapter 2.05.07.

	LANDING GEAR	1.14.20		
	LATERAL MAINTENANCE PANEL	P 7	080	
				JUN 97

AA

20.4 LATERAL MAINTENANCE PANEL

W.O.W. SELECTOR

On the RH maintenance panel, a selector enables the weight on wheels systems to be selected to the "in Flight" position when on the ground. for maintenance purposes.

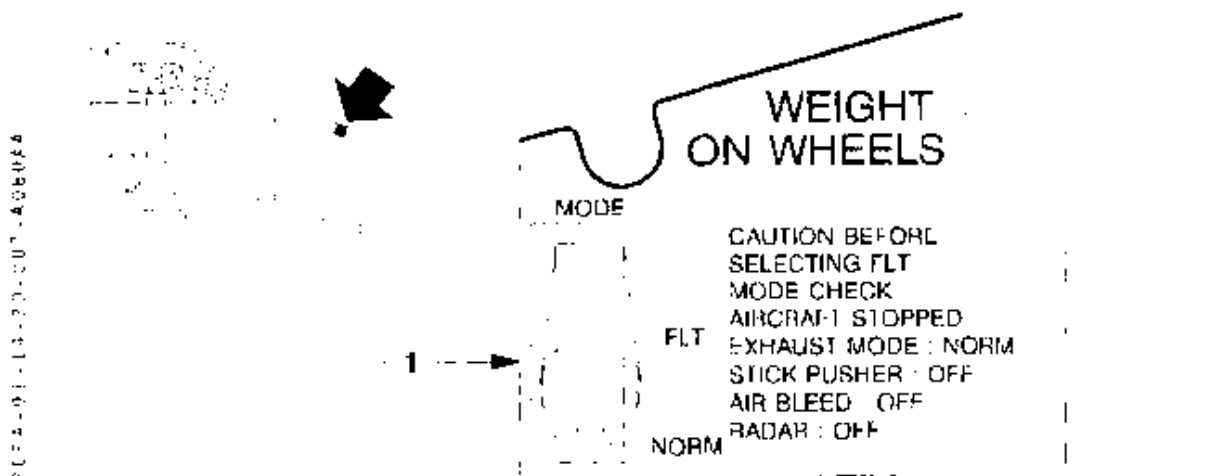

PCF4-01-14-20-007-406064

Mode Selector

Controls the overriding of weight on wheels system.

NORM The system works normally.

FLT The systems are forced to the in"FLIGHT" position. "MAINT PNL" light illuminates amber on the CAP.

FAILURES READOUT DISPLAY

The right side maintenance panel includes a readout display for failures of systems linked to the MFC. Landing gear malfunctions are indicated when the rotary selector is selected on the WOW/LDG position.

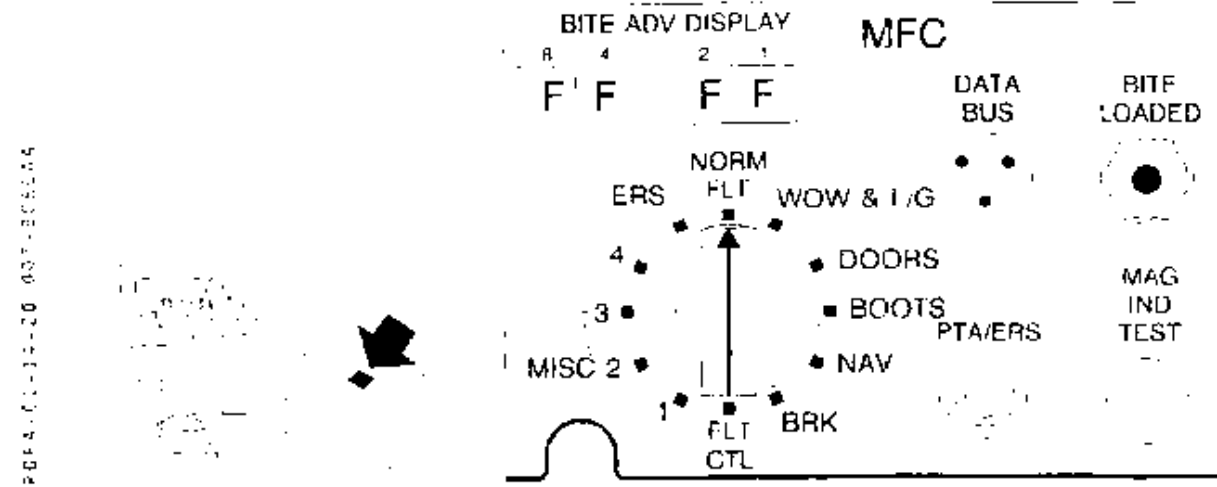

PCF4-01-14-20-007-406064

 ATR 72 F.C.O.M.	LANDING GEAR	1.14.30		
	NOSE WHEEL STEERING	P 1	001	
				DEC 96

AC

30.1 DESCRIPTION (See schematic p 3/4)

Nose wheel steering is provided by means of a servomechanism mechanically controlled from the flight compartment and powered by the blue hydraulic system. Control is achieved using the steering control hand wheel mounted on the captain's lateral console. Nose steering angle is $\pm 60^\circ$. Nose wheel deflection of $\pm 91^\circ$ is possible during towing with no pressure in the system.

An internal mechanism returns the wheel to centered position when the aircraft is off the ground.

A swivel valve shuts off hydraulic pressure to the steering system when the nose landing gear is not locked down and pressure is also shut off by a solenoid valve when the main and nose gear shock absorbers are not compressed.

Note : Should any gear rise from ground after all gears have been compressed, the steering control will be maintained as long as one gear at least, stays on ground.

A switch is provided to deactivate the steering system if required.

In case of either steering system deactivation or blue hydraulic pressure failure, the aircraft can be guided using differential braking and/or differential engine thrust.

	LANDING GEAR NOSE WHEEL STEERING	1.14.30		
		P 2	001	
				DEC 96

30.2 CONTROLS

N/W STEERING SW

R0FA-01-14-30-002-001AA

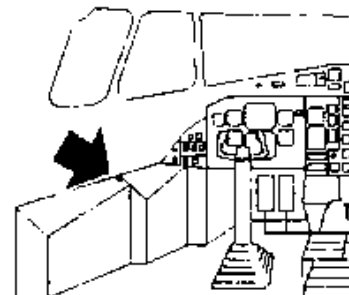
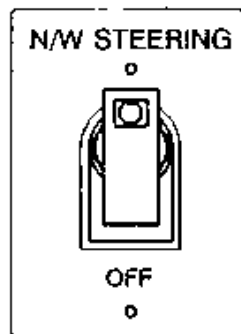

This guarded sw controls activation/deactivation of the nose wheel steering system. It is a guarded type in the ON position.

ON the steering solenoid valve is electrically armed. The solenoid is energized when the steering relay is excited. The valve opens when the steering hydraulic control is actuated.

OFF unpressurizes the steering system by de-energizing the solenoid valve.

STEERING HANDWHEEL

R0FA-01-14-30-002-001AA

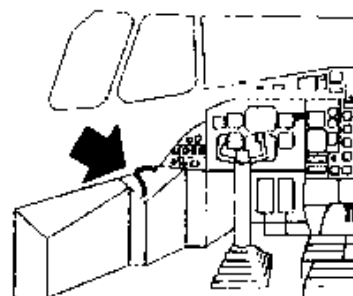
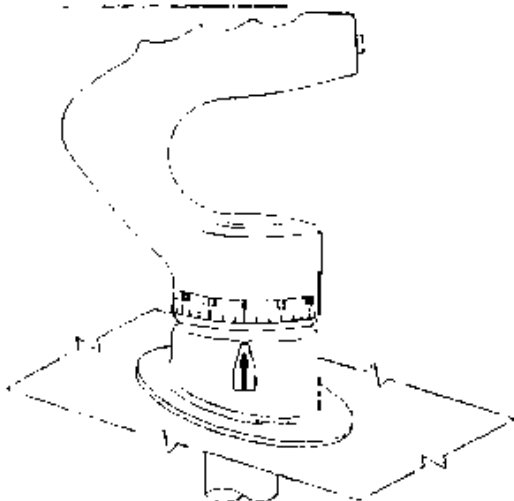

The steering handwheel controls the nose wheel steering angle

up to 60° in either direction :

- Clockwise : steering to the right
- Counter clockwise : steering to the left

Note : Nose wheel steering is self centering after lift-off.

30.3 ELECTRICAL SUPPLY

EQUIPMENT	DC BUS SUPPLY (C/B)
Nose wheel steering selection valve	DE EMER BUS (on lateral panel STEERING VALVE)



AR72
F.C.O.M.

LANDING GEAR

NOSE WHEEL STEERING

1.14.30

P 3/4

001

DEC 96

30.7 SCHEMATIC

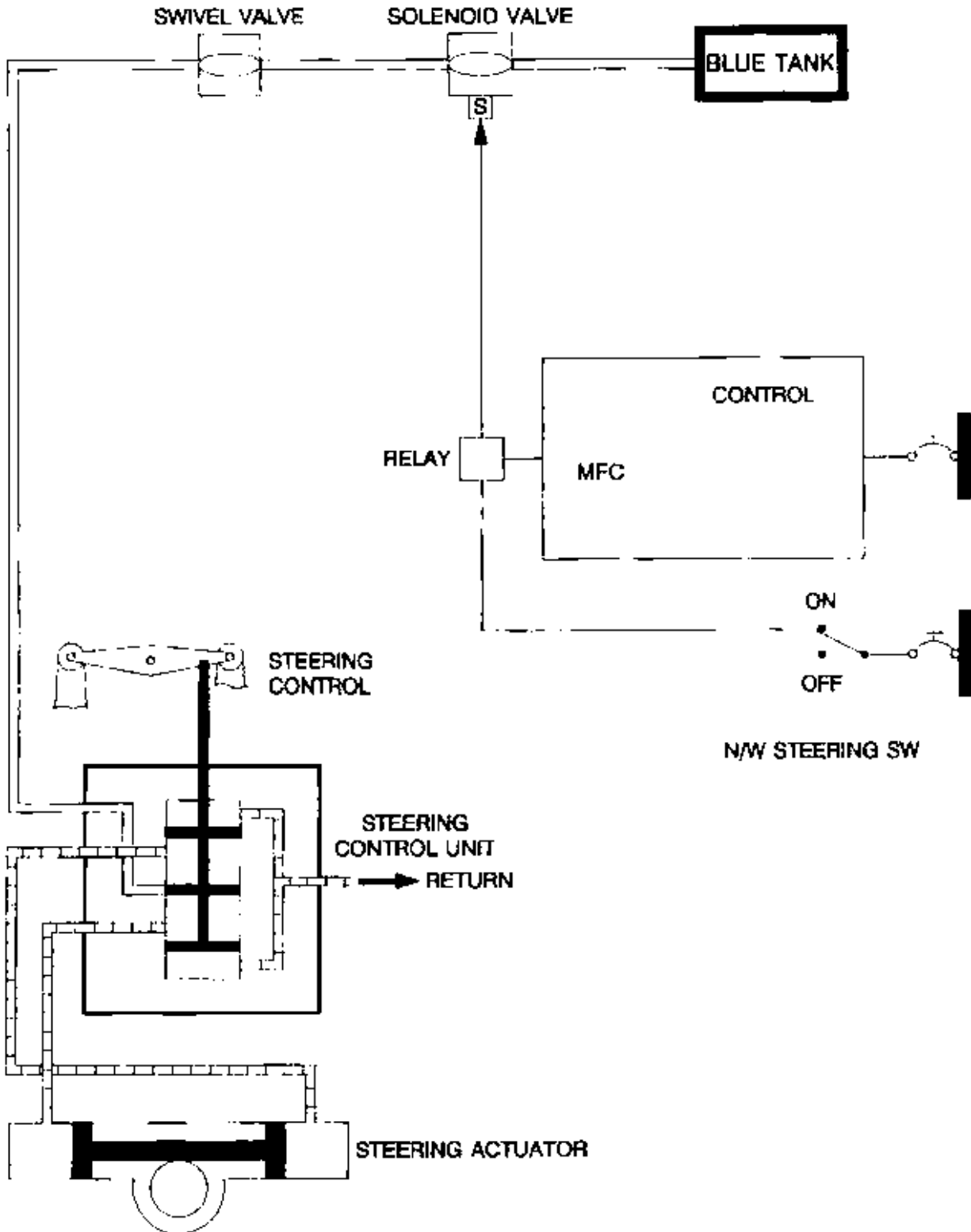

ROFA-01-14-30-003-A001AA

 ATR 72 F.C.O.M.	LANDING GEAR	1.14.40		
	BRAKES ANTI SKID	P 1	001	
				DEC 96

AB

40.1 DESCRIPTION

WHEELS AND BRAKES

The four main gear wheels are equipped with multidisc carbon brakes, each operated by one set of five hydraulically powered pistons.

Two modes are available

- normal, controlled by pilot's brake pedals and supplied by green system.
- emergency and parking controlled by the emergency and parking brake handle and supplied by blue system.

Each brake is equipped with an automatic adjuster, a wear indicator pin, and an overheat detector.

The wheels are fitted with tubeless tires

The main gear wheels are braked automatically as soon as the pilot selects up the landing gear control lever.

The main gear wheels are fitted with fusible plugs which protect against tire and wheel burst in the event of overheat. These fusible plugs are designed to release internal pressure when the wheel temperature exceeds 177°C/350°F.

ANTI SKID SYSTEM

The antiskid system is provided as soon as the gear is down and locked, and as long as the aircraft speed exceeds 10 kts.

Each wheel and each pair of external or internal wheels are monitored.

The aim of the system is to provide the maximum stopping performance by controlling brake pressure in order to minimize wheel slip, brake and tire wear, depending on runway conditions.

Touchdown protection is ensured (spin up, locked wheel).

The system consist of :

- 4 wheel speed transducers (one per main gear wheel),
- 1 control box,
- 1 antiskid module.

A reference velocity signal is elaborated. The anti skid applies a deceleration law continuously adapting the actual wheel speed to the reference speed.

AA

ANTI SKID BLOCK DIAGRAM

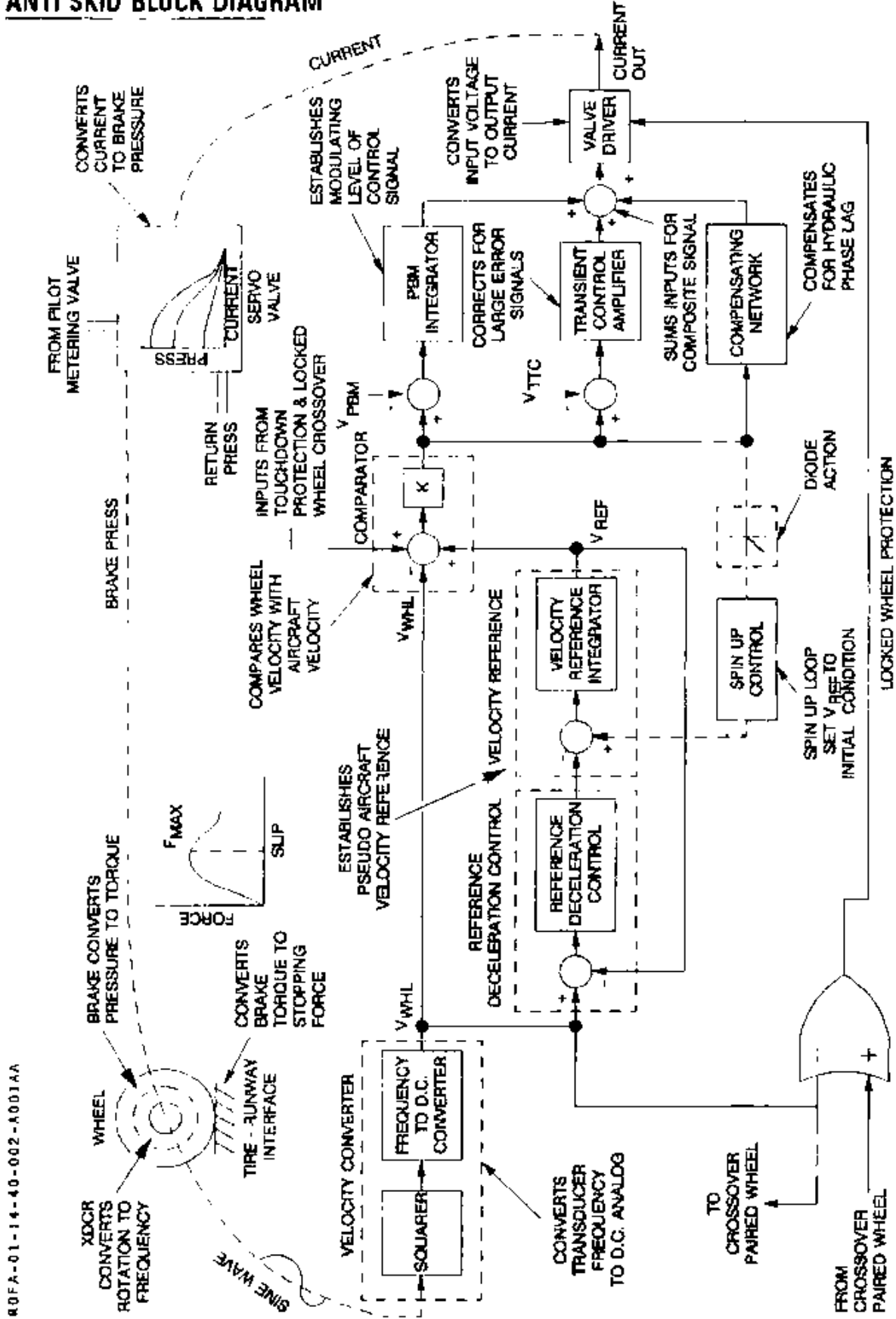

R0FA-01-14-40-002-A003AA

	LANDING GEAR	1.14.40		
	BRAKES ANTI SKID	P 3	001	
				DEC 96

LOCKED WHEEL PROTECTION

The system includes locked wheel protection to preclude tire scuffing. The crossover is applied between R.H. and L.H. inboard and between RH. and L.H. outboard. For velocities above 23 kts a speed differential of 50% or greater between the two speed signals will result in generation of a locked wheel signal and thus in release of brakes.

TOUCHDOWN PROTECTION

At main gear compression, the braking action is inhibited as long as wheel spin up is below 35 kt or for 5 s, in order to preclude inadvertent brake application prior to wheel spin up on low friction pavements or with light wheel vertical loading. In the event of electrical supply loss, the antiskid is no more operative and brakes are directly operated.

	LANDING GEAR	1.14.40		
		P 4	001	
	BRAKES ANTI SKID			DEC 96

40.2 CONTROLS

PILOT BRAKE PEDALS

R0FA-DI-14-40-004-4001AA

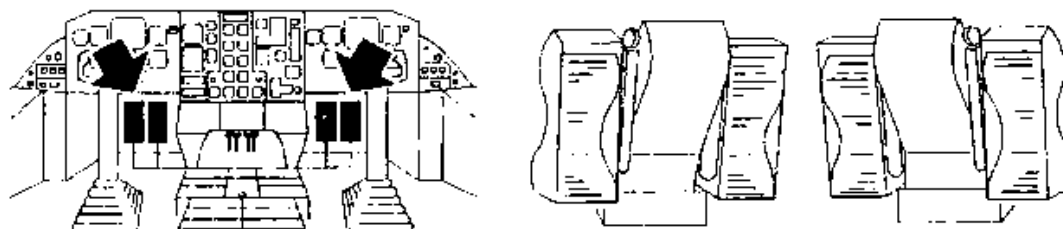

Controls normal braking mode through the normal mode metering valve.

EMERGENCY/PARKING BRAKE HANDLE

R0FA-P-01-14-40-004-8001AA

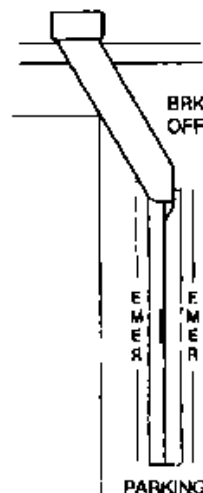
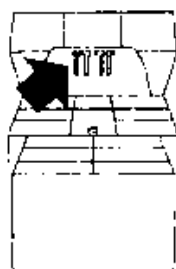

Controls emergency and parking braking mode through the emergency and parking metering valve. Springloaded to the OFF position.

EMER A metered pressure is applied to the brakes.

PARKING Full pressure is applied to the brakes.

CAUTION : Brake handle applies braking without any antiskid operation.

Note 1 : In case of hydraulic power system failure, the brake accumulator allows at least six braking applications.

Note 2 : When brake handle is not in the fully released position, amber "PRKG BRK" caution light illuminates on CAP and is taken into account by the T/O CONFIG warning system.

BRAKE TEMP INDICATOR

R0FA-DI-14-40-004-0001AA

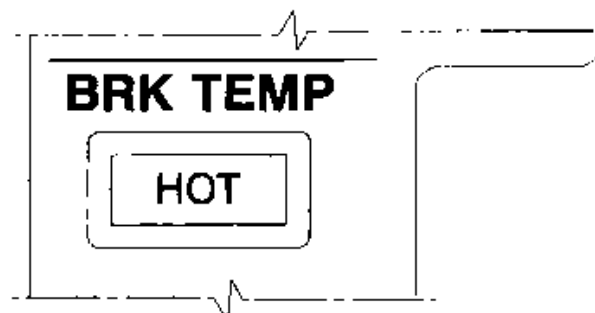
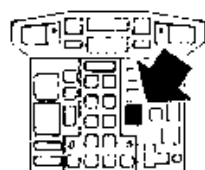

"HOT" light

The light illuminates amber and the C CAS is activated when at least one of the brakes temperature exceeds 150°C.

 ATR72 F.C.O.M.	LANDING GEAR	1.14.40		
		P 5	001	
	BRAKES ANTI SKID			DEC 96

BRAKES PRESS IND

REF A-01-14-40-003-A001AA

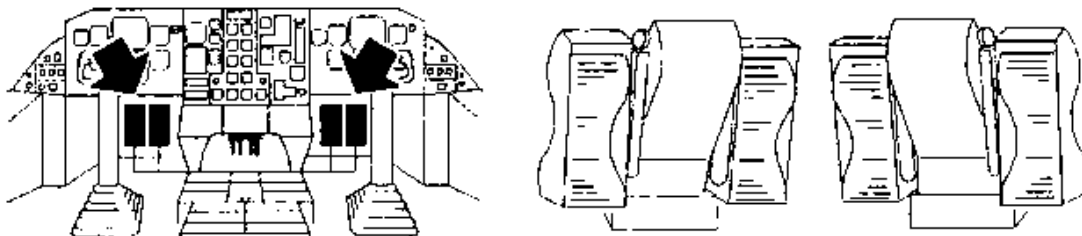

- ① HYD SYST press ind.
Blue and green hydraulic system pressures are displayed. Normal value is 3 000 PSI
- ② BRAKE ACCU press ind.
Displays the pressure of the accumulator supplied by the blue system. Normal value is 3 000 PSI

ANTI SKID PANEL

REF A-01-11-40-025-0001A

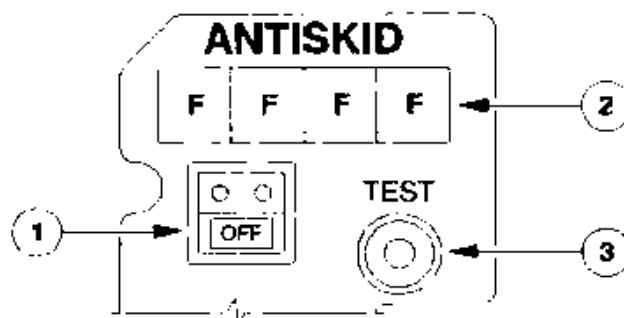

- ① ANTI SKID pb
Controls activation/deactivation of the antiskid system.
(pb pressed in) antiskid system is activated.
OFF (pb released) antiskid system is deactivated. OFF light illuminates white.
- ② Antiskid channel FAULT lights
Illuminate amber and the CCAS is activated if a failure is detected in the associated channel. Antiskid is lost on the associated wheel.
- ③ TEST pb.
Press the button initiates an automatic sequential test to verify the primary antiskid protection capabilities of the system. The test duration is approximately three seconds in flight and six seconds on ground. If initiated on ground when brake pedals are depressed, the test duration is sufficient to allow observation of the brake compression and release, thereby allowing system verification testing to be performed.
CAUTION : Do not perform the test on the ground, engines running, without parking brake set.
The antiskid channel FAULT lights illuminate during the test. If one channel is sensed as failed, the associated FAULT light remains illuminated.
Note : The test is inhibited when wheel speed exceeds 17 kt

	LANDING GEAR	1.14.40	
		P 6	001
	BRAKES ANTI SKID		DEC 96

40.3 ELECTRICAL SUPPLY/SYSTEM MONITORING

ELECTRICAL SUPPLY

EQUIPMENT	DC BUS SUPPLY (C/B)
Antiskid control for inboard wheels	DC ESS BUS (on lateral panel INBOARD WHEELS)
Antiskid control for outboard wheels	DC EMER BUS (on lateral panel OUTBOARD WHEELS)
Antiskid caution system	DC STBY BUS (on lateral panel CAUTION)
Emer Brake accu pressure ind.	DC STBY BUS (on lateral panel PRESS IND)
Brake temp system	DC STBY BUS (on lateral panel MONITORING SYS)

SYSTEM MONITORING

The following conditions are monitored by visual and aural alerts :

- Anti skid channel loss (power loss or loss of transducer or valve continuity)
 - See ANTI SKID FAULT procedure in chapter 2.05.07.
- Brake temperature over 150°C.
 - See BRK TEMP HOT procedure in chapter 2.05.07.

 ATR72 F.C.O.M.	LANDING GEAR BRAKES ANTI SKID	1.14.40		
		P 7/8	001	
				DEC 96

40.4 LATERAL MAINTENANCE PANEL

BRK TEMP TEST

On the RH maintenance panel, a test pb is used to test brake overheat detection system. When depressed, MC flashes amber, HOT amber light illuminates, WHEEL amber light illuminates on CAP, SC is sent by the CCAS.

30FA-01-14-40-007-R001AA

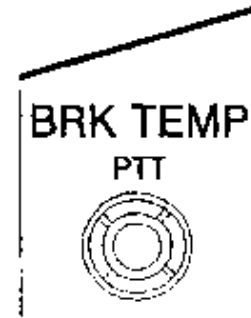
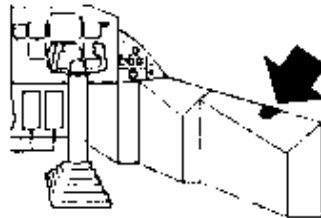

	LANDING GEAR		1.14.40	
	BRAKES ANTI SKID		9/10	001
			DEC 96	

40.5 SCHEMATIC

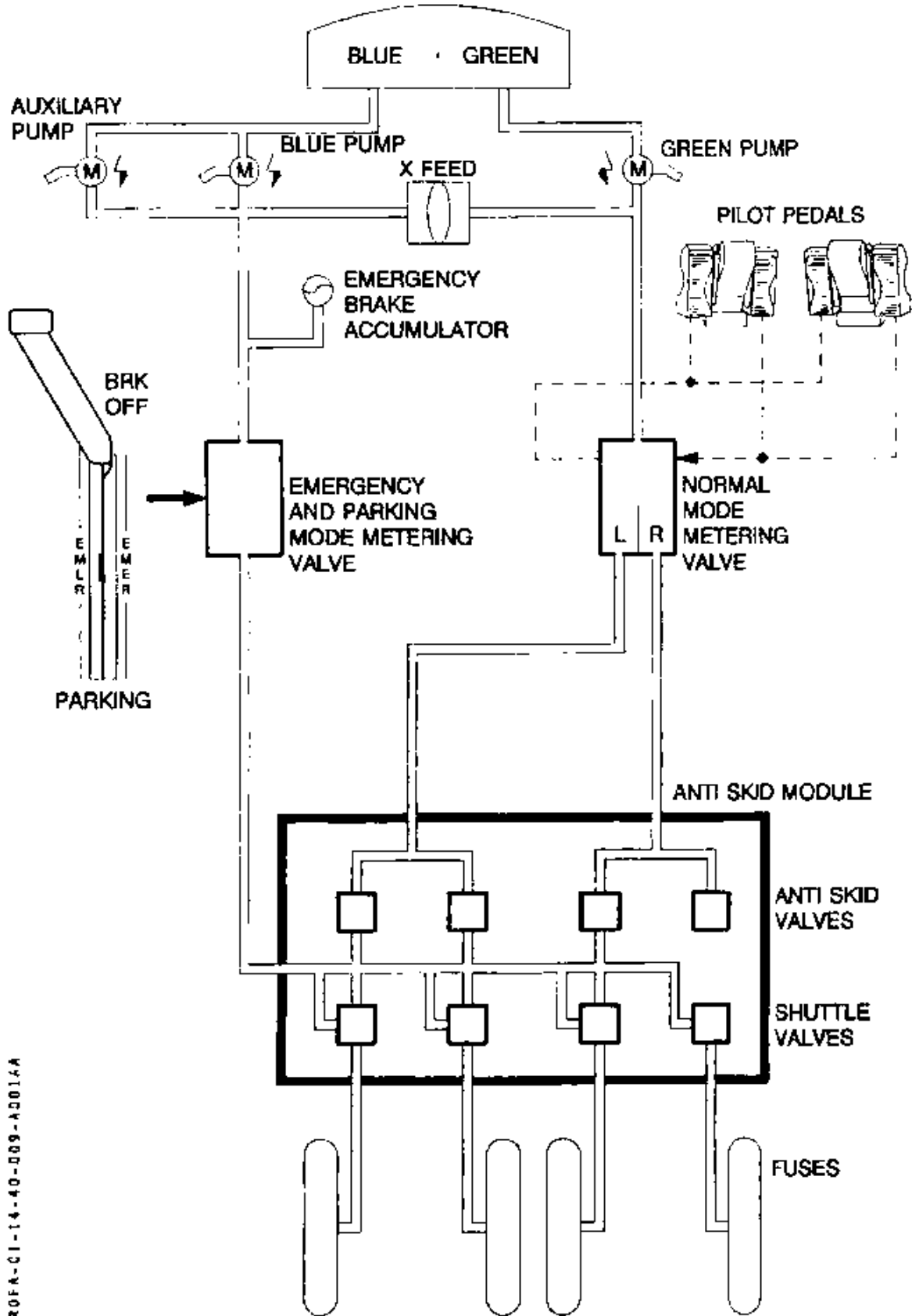

ROFA-CI-14-40-009-A001AA

	NAVIGATION SYSTEM		1.15.00	
	CONTENTS		P 1	090
				JUL 99

AA

1.15.00	CONTENTS
1.15.10	VOR/ILS/MKR/DME SYSTEM
10.1	DESCRIPTION
10.2	CONTROLS
10.3	ELECTRICAL SUPPLY
1.15.20	ADF SYSTEM
20.1	DESCRIPTION
20.2	CONTROLS
20.3	ELECTRICAL SUPPLY
1.15.30	RADIO ALTIMETER
30.1	DESCRIPTION
30.2	ELECTRICAL SUPPLY
1.15.40	GROUND PROXIMITY WARNING SYSTEM
40.1	DESCRIPTION
40.2	CONTROLS
40.3	ELECTRICAL SUPPLY/SYSTEM MONITORING
40.4	SCHEMATIC
1.15.50	WEATHER RADAR
50.1	DESCRIPTION
50.2	CONTROLS
50.3	ELECTRICAL SUPPLY
1.15.60	GLOBAL NAVIGATION SATELLITE SYSTEM (GNSS)
60.1	DESCRIPTION
60.2	CONTROLS
60.3	ELECTRICAL SUPPLY
60.4	SCHEMATIC
1.15.65	OMEGA (if installed)

	NAVIGATION SYSTEM VOR/ILS/MKR/DME SYSTEM	1.15.10		
		P 1	001	
				DEC 96

10.1 DESCRIPTION

The aircraft is equipped with :

- two VOR receivers
- two ILS receivers
- one MKR receiver
- one DME interrogator/receiver
- one additional DME interrogator/receiver optional

Note : VOR 1, ILS 1 and MKR are integrated in a common box, as are VOR 2 and ILS 2.

VOR

The two VOR receivers are independent, but use a common VOR antenna located on top of the vertical stabilizer. Each receiver is individually controlled by the associated NAV control box on the glareshield panel : VOR 1 on the LH side, VOR 2 on the RH side. The receivers are designed for reception of one of the 160 channels with 0,05 MHz spacing in the 108.00 to 117.95 MHz frequency range. The VOR audio signals are transmitted to the Remote Control Audio Unit.

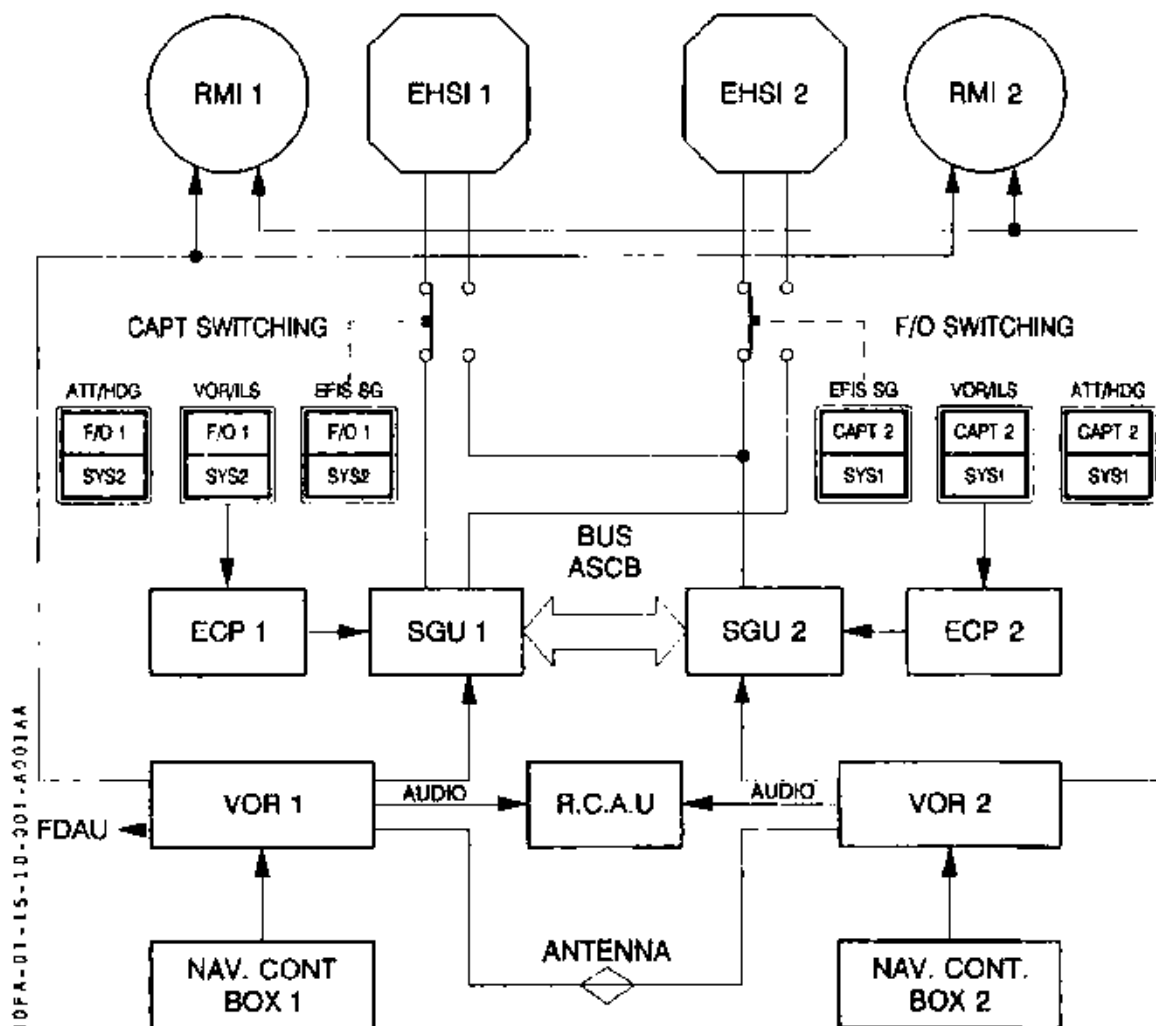

	NAVIGATION SYSTEM	1.15.10	
	VOR/ILS/MKR/DME SYSTEM	P 2	001
		DEC 96	

ILS

The two ILS receivers are independent but use a common LOC antenna used for the VOR systems and a common G/S antenna. Each receiver is individually controlled by the associated NAV control box on the glareshield panel : ILS 1 on the LH side, ILS 2 on the RH side.

The receivers operate for localizer reception in the 108 MHz to 112 MHz VHF range and for glideslope reception in the 329 to 335 MHz VHF range. Each of the 40 localizer channels is combined with a matched glideslope channel. The ILS audio signals are transmitted to the Remote Control Audio Unit.

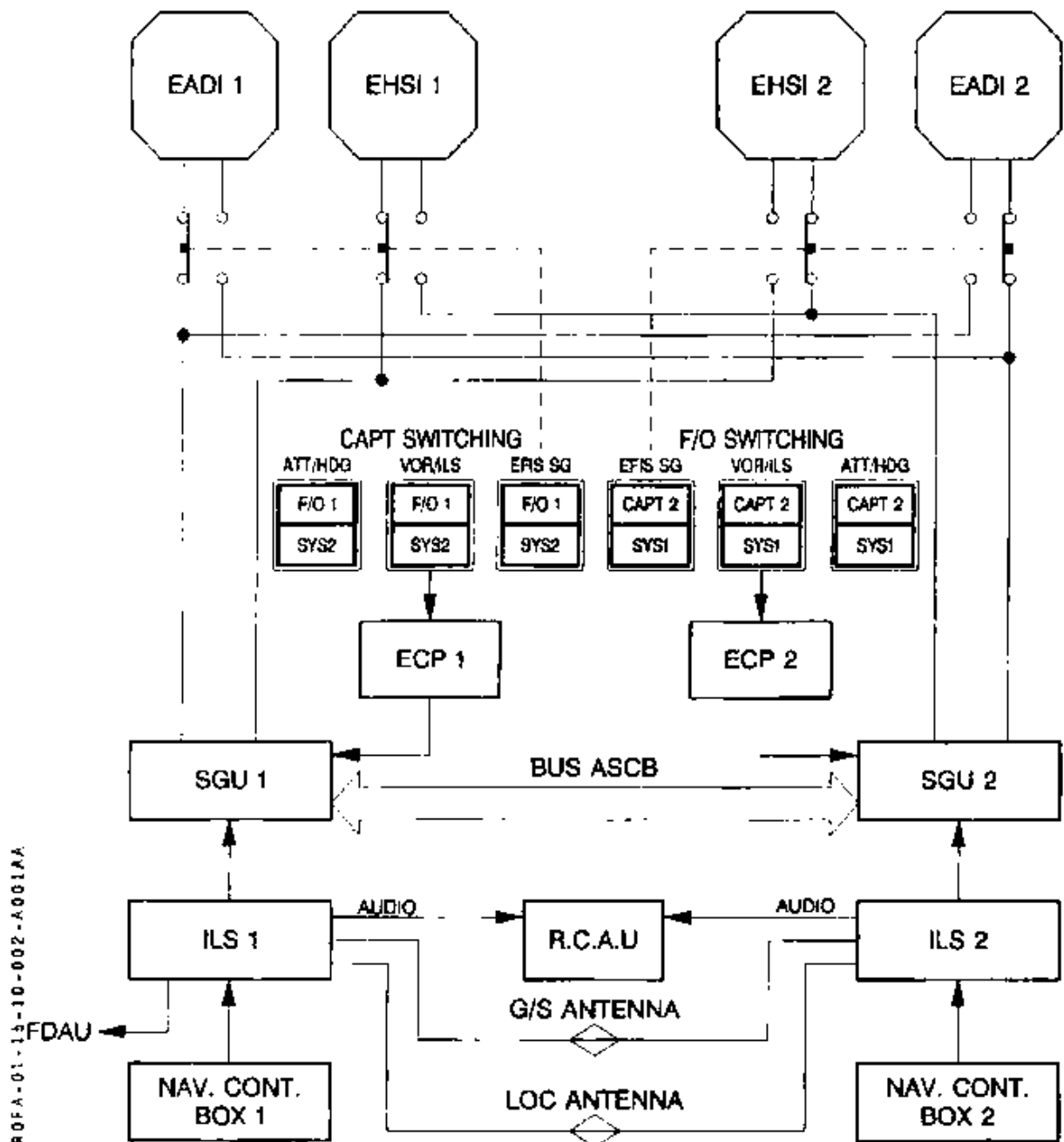

ROFA-01-13-10-002-A001AA

	NAVIGATION SYSTEM	1.15.10		
	VOR/ILS/MKR/DME SYSTEM	P 3	010	
				DEC 96

AA

MARKER

The MARKER beacon receivers are connected to the marker antenna and are controlled by the NAV 1 and the NAV 2 control boxes. Outer, middle and inner or airways markers signals are received and processed for visual display and audio annunciation.

Information coming from VOR/ILS/MKR is digital.

The visual signal is displayed at the bottom right corner of the EADI.

Only MKR 1 audio signals are transmitted.

The marker audio signals are transmitted to the Remote Control Audio Unit.

On the captain's side panel, a switch allows selection of marker sensitivity (LO or HI).

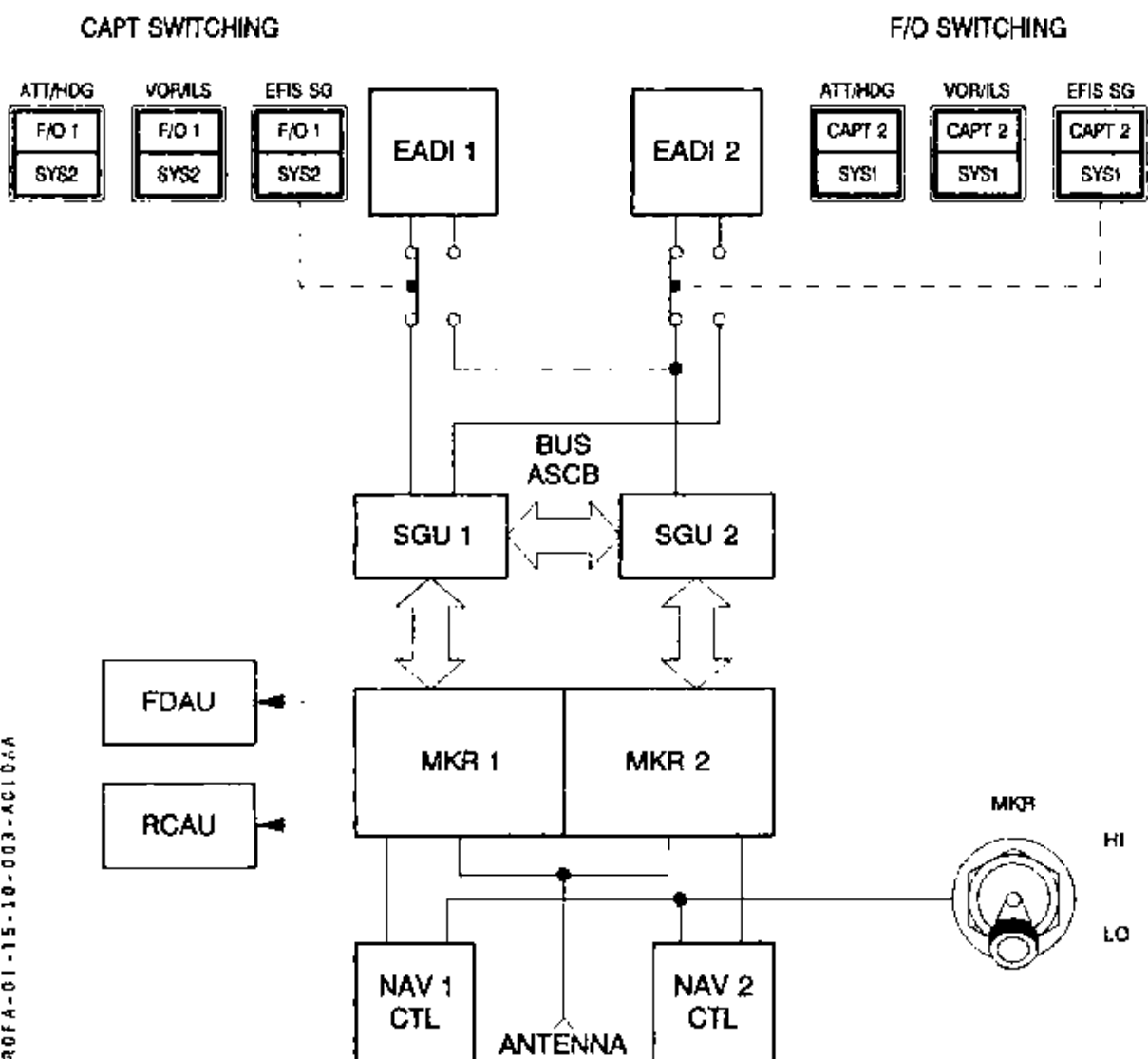

ROFA-01-15-10-003-AC10/A

	NAVIGATION SYSTEM	1.15.10		
		P 4	010	
	VOR/ILS/MKR/DME SYSTEM			DEC 96

DME

The DME system operates in the 1025 to 1150 MHz frequency range with 1 MHz spacing. DME channeling is accomplished through the NAV 1 control box and DME 2 channeling through the NAV 2 control box. The frequency selection is automatically associated with the relative NAV frequency, as selected on the glareshield panel. The DME measures the slant range to the station when the selected NAV station is equipped with a DME.

DME audio signals are transmitted to the Remote Control Audio Unit.

DME values are sent to the SGUs and displayed on the EHSIS.

When the DME is in "HOLD" mode, an amber "H" appears on top right corner of the affected EHSI. In this case, the affected DME will remain locked to the one previous frequency selected, allowing the NAV control box to be used for any other desired frequency.

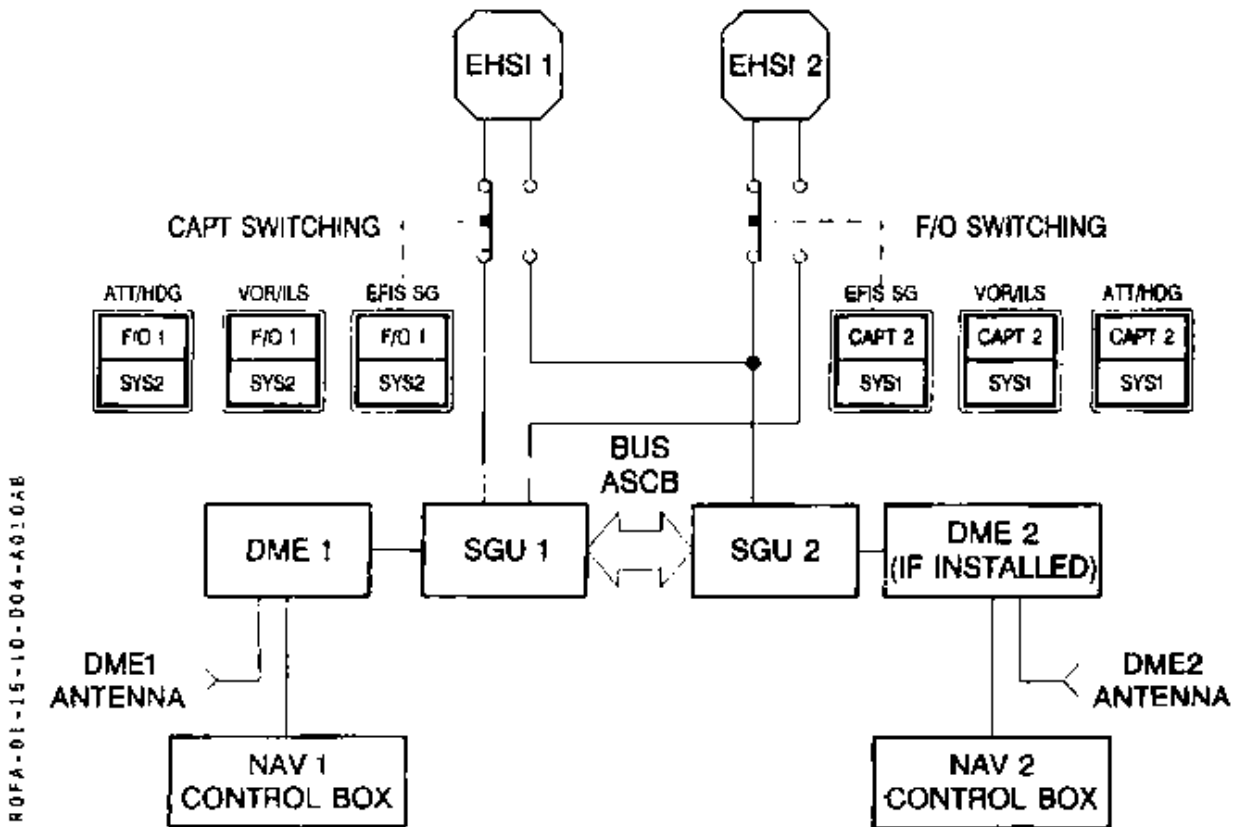

	NAVIGATION SYSTEM		1.15.10	
	VOR/ILS/MKR/DME SYSTEM		P 5	010
			DEC 96	

10.2 CONTROLS
NAV CONTROL BOX

RSPFA-01-15-10-005-AD:OPC

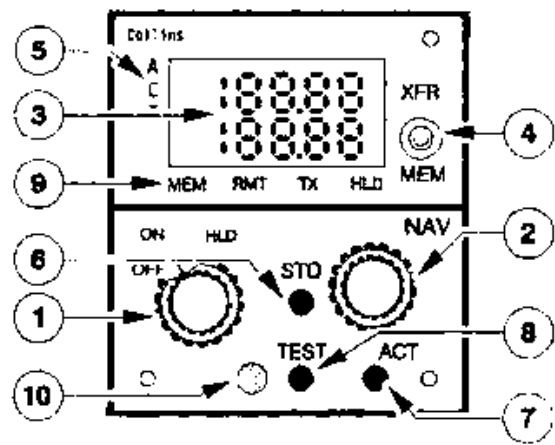
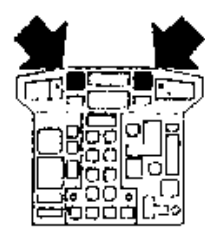

- ① Power, Mode and volume switches
 - Outer knob enables to switch the system ON. The HLD position allows the NAV frequency to be changed, while holding the DME on the current active frequency.
 - Inner knob enables to adjust the volume of reception.
- ② Frequency select knobs

Control the preset or active frequency display.

 - Outer knob changes the three digits to the left of the decimal point.
 - Inner knob changes the two digits to the right of the decimal point.
- ③ Frequencies display
 - The active frequency is displayed in the upper window.
 - The preset frequency is displayed in the lower window.
- ④ XFR/MEM switch

is spring loaded in neutral position.

XFR Exchanges active and preset frequency.

MEM One of the frequencies stored in the memory is loaded into the preset display. Successive actions cycle the four memory frequencies through the display.
- ⑤ Compare annunciator (ACT)

ACT flashes if the actual radio frequency is not identical to the frequency shown in the active frequency display.
- ⑥ STO button

Allows to enter the frequencies into the four memory positions.

 - Preset the frequency to be stored.
 - Push the STO button : upper window displays an available memory channel
 - For 5 seconds, the MEM switch may be used to change the channel number.
 - Push the STO button a second time : displayed frequency is stored in the displayed channel.
 - After 5 seconds, the control returns to normal operation.
- ⑦ ACT button

In normal operation, frequency select knobs (2) changes the preset frequency display. After a 2 second push on the ACT button, bottom window displays dashes, the knobs directly act on the active frequency. A second push on the ACT button enables a return to normal operation.

	NAVIGATION SYSTEM VOR/ILS/MKR/DME SYSTEM	1.15.10		
		P 6	010	
				DEC 96

⑧ TEST button

Is used to initiate the radio self-test diagnostic routine.

⑨ Annunciators

MEM (Memory) illuminates when a preset frequency is being displayed in the lower window.

RMT (Remote) illuminates when the NAV control box is being remotely controlled by an other system (FMS, NCS, etc...).

HLD (Hold) illuminates when the DME is held to the active frequency at time of selection. The upper window displays the NAV frequency and the lower window displays the held DME frequency.

⑩ Light sensor

Automatically adjusts the display brightness.

CRS 1/HDG AND ALT/CRS 2 PANELS

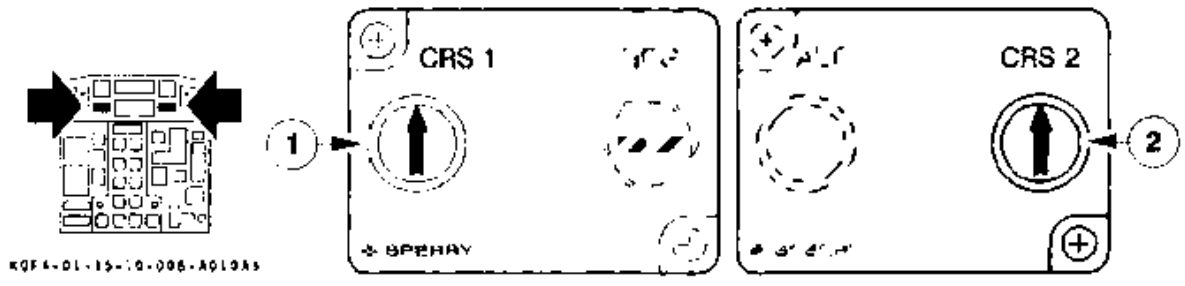

① CRS 1 knob

Selects course on CAPT EHSI.

② CRS 2 knob

Selects course on F/O EHSI.

CAPT SOURCE AND F/O SWITCHING

CAPT SWITCHING

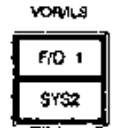

Used by the captain to transfer N°2 VOR/ILS to N°1 (CAPTAIN'S) deviation bar. see 1-10-30

F/O SWITCHING

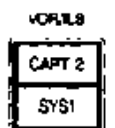

Has same effect as CAPT SWITCHING

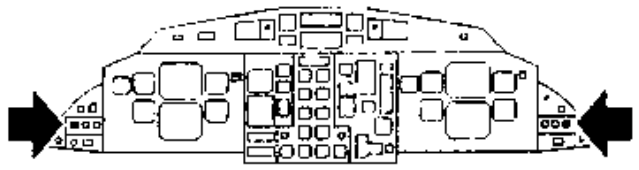

R0FA-01-15-10-006-8012AA

 ATR72 F.C.O.M.	NAVIGATION SYSTEM	1.15.10	
	VOR/ILS/MKR/DME SYSTEM	P 7	010
			DEC 96

AA

MKR SW

R0FA-01-15-10-007-AC10AA

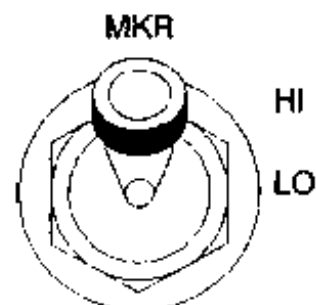
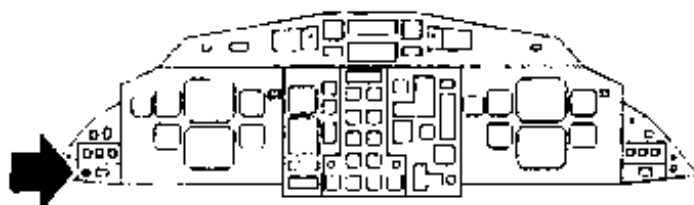

Is used to set marker sensitivity

10.3 ELECTRICAL SUPPLY

EQUIPMENT	DC BUS SUPPLY (C/B)
NAV 1	DC STBY BUS (on overhead panel VOR 1)
NAV 2	DC BUS 2 (on overhead panel VOR 2)
DME 1	DC BUS 1 (on overhead panel DME 1)
DME 2 (if installed)	DC BUS 2 (on overhead panel DME 2)

	NAVIGATION SYSTEM	1.15.20		
		P 1	001	
	ADF SYSTEM			DEC 96

20.1 DESCRIPTION

The aircraft is equipped with an ADF system. It provides relative bearing indication to NDB'S or broadcast stations.
 Bearing can be displayed on EHSI and/or on RMI.
 The receiver frequency range is from 190 to 1799 KHz.
 The ADF antenna is located on top of the fuselage.
 The ADF audio signals are transmitted to the Remote Control Audio Unit.

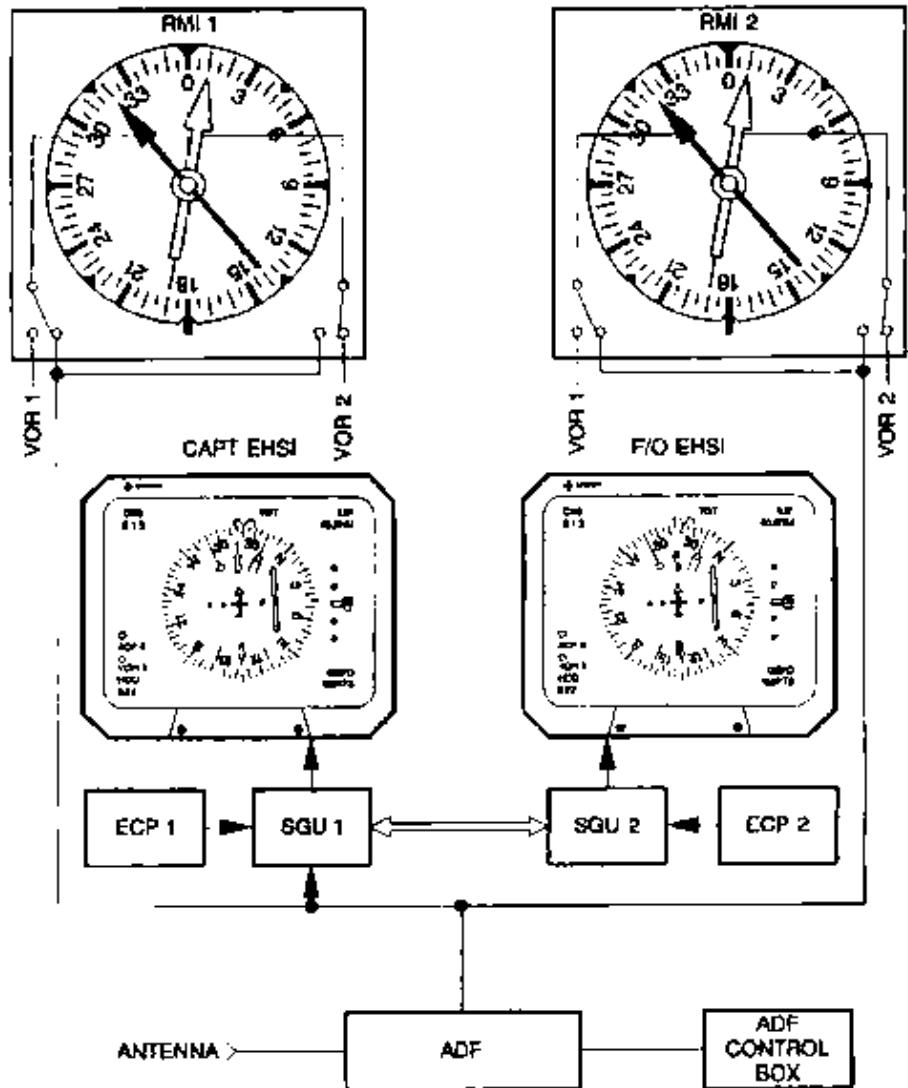

ROFA-01-15-20-001-A001A

	NAVIGATION SYSTEM		1.15.20		
	ADF SYSTEM		P 2	010	
					DEC 96

20.2 CONTROLS

ADF CONTROL BOX

RCFA-01-15-20-002-AD10A8

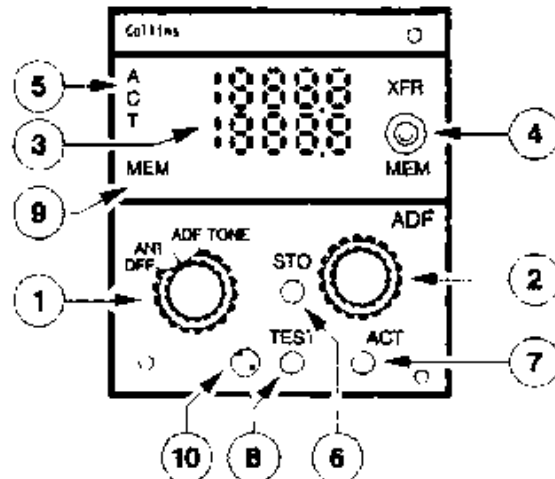
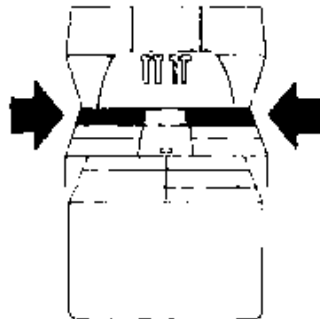

- ① Power, mode and volume controls
 - Outer knob enables to switch the system ON, and to choose ANT, ADF or TONE system mode of operation.
 - Inner knob enables to adjust the volume of reception.
- ② Frequency select knobs
 - The larger knob changes the 1000's and 100's KHz digits.
 - The smaller knob changes the 10's, units and tenth KHz digits. Normal rotation changes the display in 1 KHz steps, except for the two steps backward following a rotation, which will change the display in a 0.5 KHz step.
- ③ Frequencies display
 - Upper window displays the active frequency.
 - Lower window displays the standby frequency.
- ④ XFR/MEM switch
 - This switch is a 3 position, spring loaded toggle switch.
 - XFR : Active frequency and standby frequency are exchanged.
 - MEM : One of the four stored memory frequencies is loaded into the standby display. When the switch is pushed several times, the four memory frequencies are cycled.
- ⑤ Compare annunciator (ACT)
 - ACT flashes if the actual radio frequency is not identical to the frequency shown in the active frequency display.
- ⑥ STO button
 - Allows to enter frequencies into the four memory positions.
 - Preset the frequency to be stored.
 - Push the STO button : upper window displays an available memory channel.
 - For 5 seconds, the MEM switch may be used to change the channel number.
 - Push the STO button a second time : displayed frequency is stored in the displayed channel.
 - After 5 seconds, the control returns to normal operation.

	NAVIGATION SYSTEM	1.15.20		
		P 3	010	
	ADF SYSTEM			JUL 98

AA

⑦ ACT button

In normal operation, frequency select knobs(2) change the preset frequency display. After a 2 second push on the ACT button the bottom, window displays dashes, the knobs directly act on the active frequency. A second push on the button enables return to normal operation.

⑧ TEST button

Is used to initiate the radio self test diagnostic routine.

⑨ Annunciators

MEM (Memory) : illuminates when a preset frequency is being displayed in the lower window.

RMT (Remote) : illuminates when the ADF control box is being remotely controlled by an other system (FMS, NCS, etc...)

⑩ Light sensor

Automatically adjusts the display brightness.

20.3 ELECTRICAL SUPPLY

EQUIPMENT	DC BUS SUPPLY (C/B)
ADF 1	DC STBY BUS (on overhead panel ADF 1)
ADF 2 (if installed)	DC BUS 2 (on overhead panel ADF 2)

R

	NAVIGATION SYSTEM	1.15.30		
	RADIO ALTIMETER	P 1	001	
				DEC 96

30.1 DESCRIPTION

The radio altimeter gives accurate height information when flying below 2500 ft and is particularly useful during the approach phase. The radio altimeter system comprises one transceiver and two antennae. The range of the display is from -20 to + 2500 ft. Radio altitude information is displayed on the bottom right of the EADI. When radio altitude information is not valid, amber dashes are displayed and systems using this information may provide undue alarms.

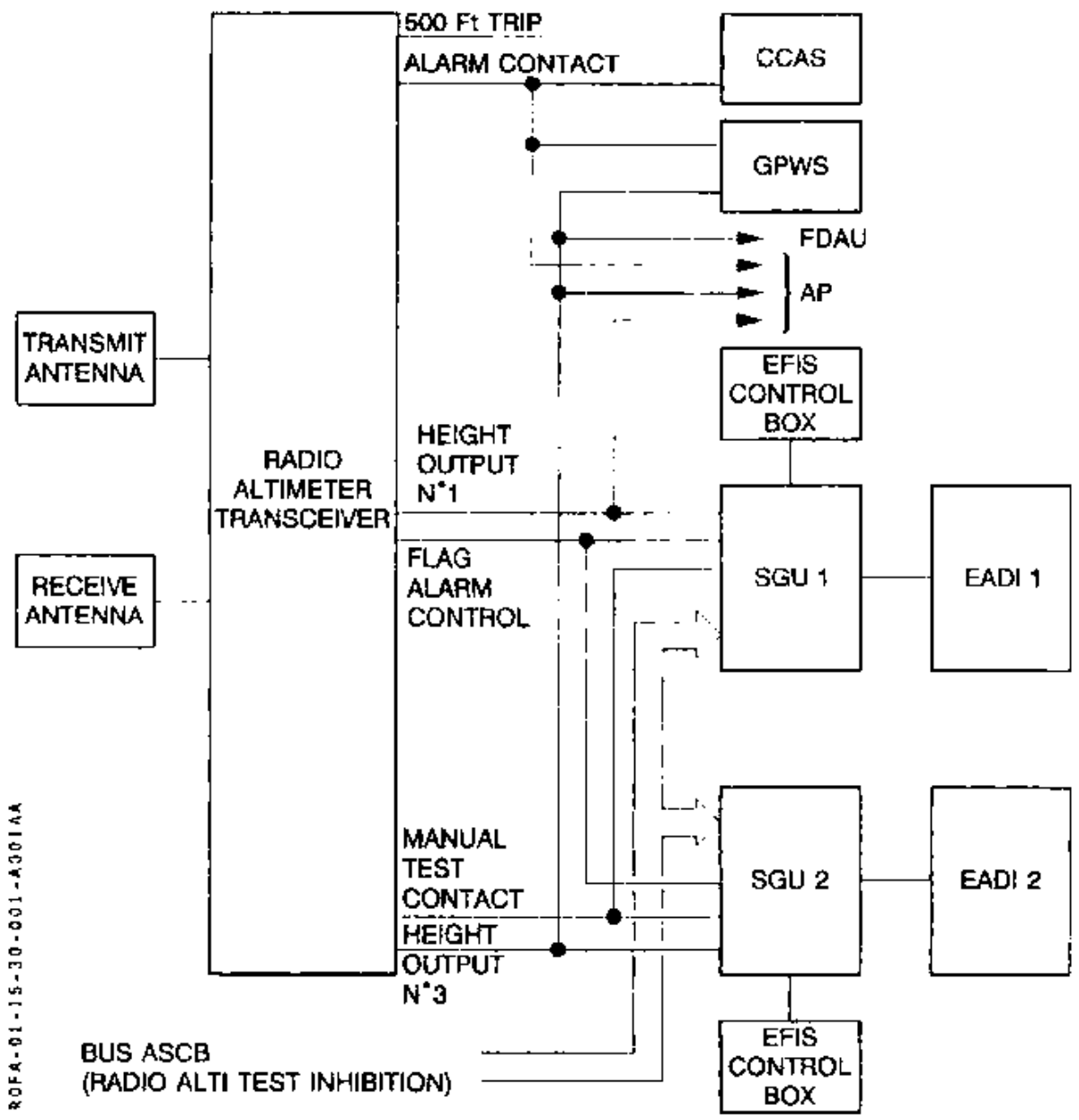

RFA-01-15-30-001-A301AA

	NAVIGATION SYSTEM RADIO ALTIMETER	1.15.30		
		P 2	001	
				DEC 96

AA

30.2 ELECTRICAL SUPPLY

EQUIPMENT	DC BUS SUPPLY (C/B)
Radio altimeter	DC BUS 1 (on overhead panel RAD ALT)

 ATR 72 F.C.O.M.	NAVIGATION SYSTEM GPWS	1.15.40		
		P 1	001	
				DEC 96

40.1 DESCRIPTION

(See schematic p 9/10)

The Ground Proximity Warning System (GPWS) provides visual and aural alerts in case of dangerous flight path conditions which would result in inadvertent ground contact if maintained. The system generates alerts only between 50 ft and 2500 ft AGL.

Six alert modes are established with defined danger envelopes :

- Mode 1 excessive sink rate.
- Mode 2 excessive terrain closure rate.
- Mode 3 descent after take off.
- Mode 4 inadvertent proximity to terrain with landing gear or flaps not in landing configuration.
- Mode 5 descent below ILS glideslope.
- Mode 6 descent below minimums.

The GPWS includes :

- A GPWS computer
- Two GPWS/GS lights
- A GPWS FAULT amber light on CAP.
- A GPWS selector
- Several aural alert channels

For operation, the system requires data supply from ADC 1, ILS 2, radio altimeter, flaps position transmitter and gear lever position transmitter.

Mode 5 is active whenever a valid ILS glideslope signal is supplied. If the ILS converter signals no computed data, mode 5 alert is inhibited. The mode 5 alert is also inhibited in back course operation.

Visual alert is provided :

- In mode 1, 2, 3, or 4 by illumination of the GPWS red lights, one on each pilots panel.
- In mode 5 by illumination of the GS amber lights, one on each pilots panel.

The aural alerts are voice alerts which segregate the various alert modes.

Mode 5 alerts may be inhibited by pressing one of the GPWS/GS pb below 1000 ft. The GPWS selector on the captain side panel is provided to avoid nuisance alerts in mode 4 caused by flap position when a landing has to be performed with reduced flap setting. In case of GPWS malfunction, all alerts can be inhibited by selection to OFF. The system can be tested on ground and in flight above 1000 ft radio height by pressing one of the GPWS/GS lt.

	NAVIGATION SYSTEM	1.15.40	
	GPWS	P 2	001

ALERT MODES

MODE 1 : EXCESSIVE SINK RATE

When the aircraft penetrates the outer envelope, the "SINK RATE" voice alert is given and the red GPWS warning lights illuminate.

If the inner envelope is penetrated, the "WHOOOP WHOOOP PULL UP" alert is given. This mode does not depend on the aircraft configuration.

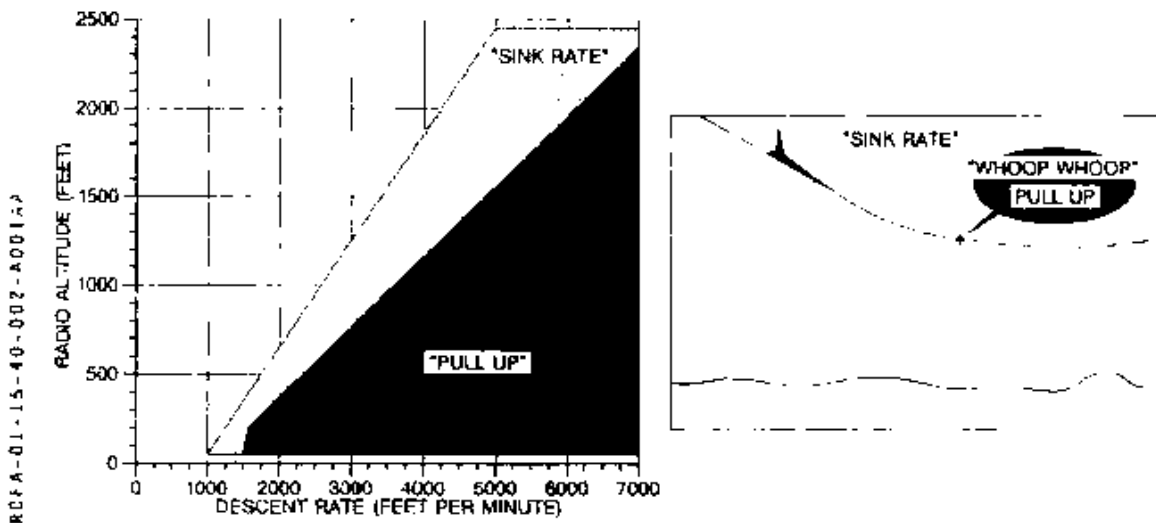



MODE 2 : EXCESSIVE TERRAIN CLOSURE RATE

- FLAPS NOT IN LANDING CONFIGURATION.

When the aircraft penetrates the envelope, the "TERRAIN" voice alert is given twice and the red GPWS warning lights illuminate.

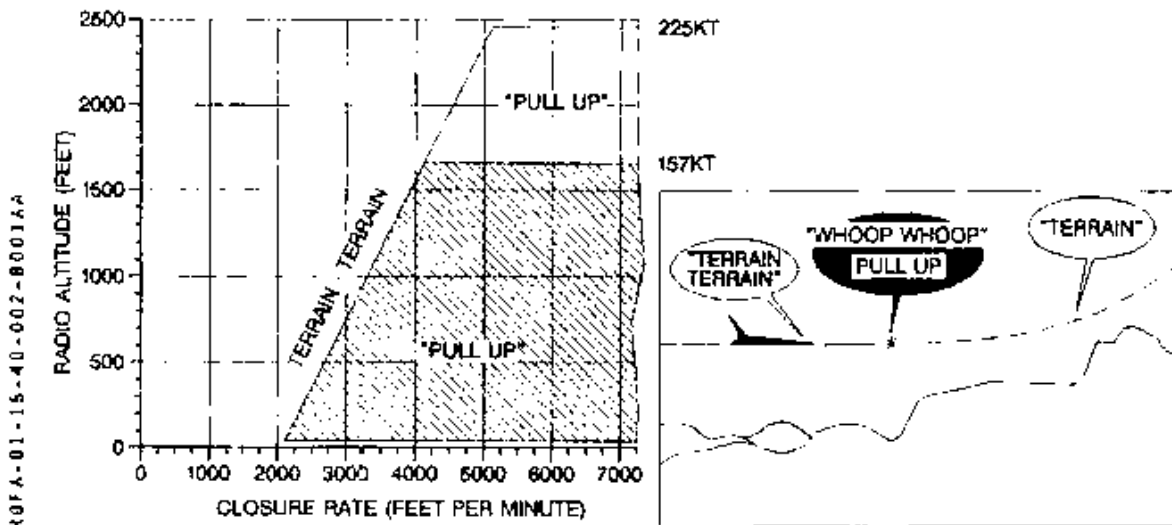
As long as the aircraft remains in the envelope, the "WHOOOP WHOOOP PULL UP" warning is given. When the warning conditions no longer exist, the "TERRAIN-TERRAIN" aural message is heard until the aircraft pressure altitude has increased by 300 ft of altitude.



	NAVIGATION SYSTEM GPWS	1.15.40		
		P 3	001	
				DEC 96

AA

▪ **FLAPS IN LANDING CONFIGURATION**

When the aircraft penetrates the envelope, the "TERRAIN" voice alert is given twice and the red GPWS warning lights illuminate.

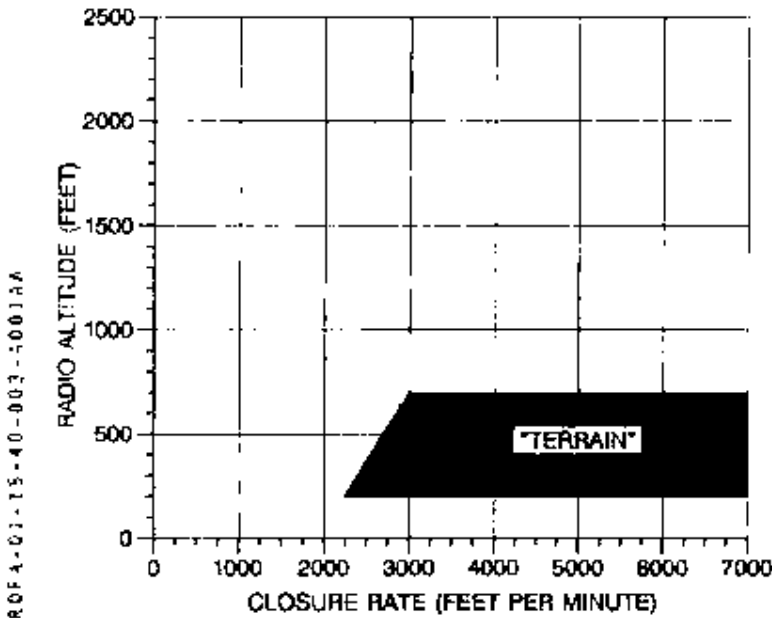

MODE 3 : DESCENT AFTER TAKE-OFF

This mode is active between 75 and 700 ft. When the aircraft penetrates the envelope, a "DON'T SINK" voice alert is given and the red GPWS warning lights illuminate.

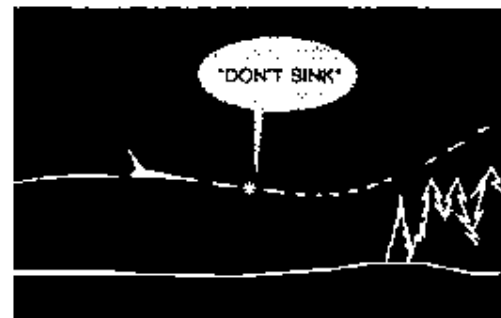
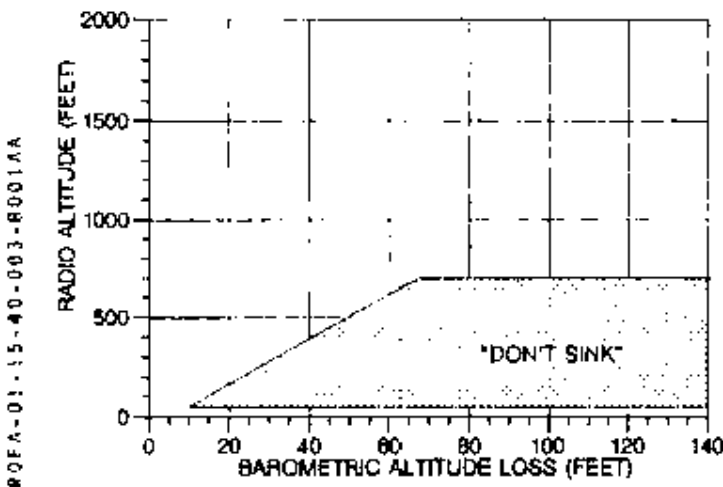

	NAVIGATION SYSTEM		1.15.40		
			P 4	001	
	GPWS				DEC 96

MODE 4 : PROXIMITY TO TERRAIN

- **GEAR UP**

This mode is active as soon as the aircraft reaches 700 ft AGL after take-off. When the aircraft penetrates the envelope at a speed higher than 157 kt with gear not down and locked a « TOO LOW TERRAIN » voice alert is given and the red GPWS warning lights illuminate. If penetration is made at a speed lower than 157 kt with gear not down and locked, a « TOO LOW GEAR » voice alert is given and the red GPWS warning lights illuminate.

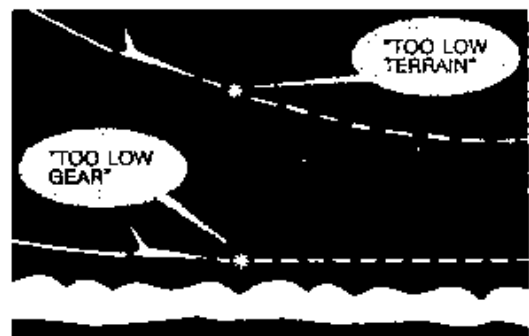
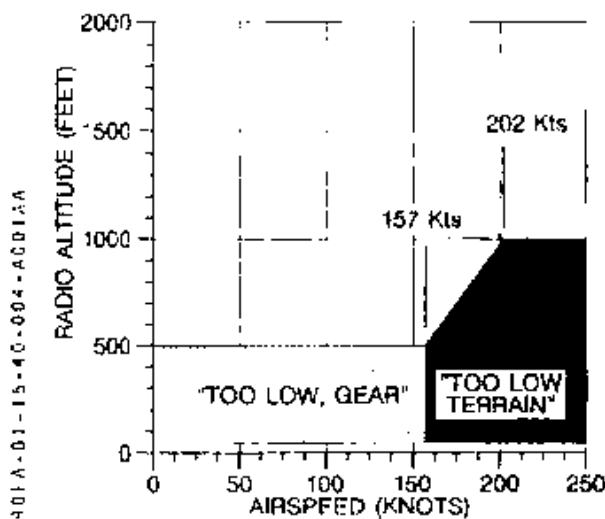



- **FLAPS UP**

This mode is active when the gear is down and locked but with the flaps not in landing configuration. When the aircraft penetrates the envelope at a speed higher than 130 kt a "TOO LOW TERRAIN" voice alert is given and the red GPWS warning lights illuminate.

If penetration is made at a speed lower than 130 kt, a "TOO LOW FLAP" voice alert is given and the red GPWS warning lights illuminate.

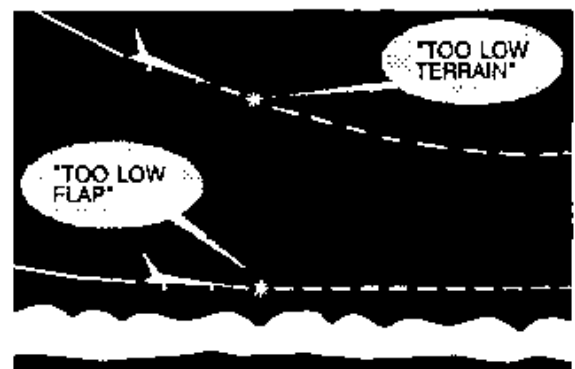
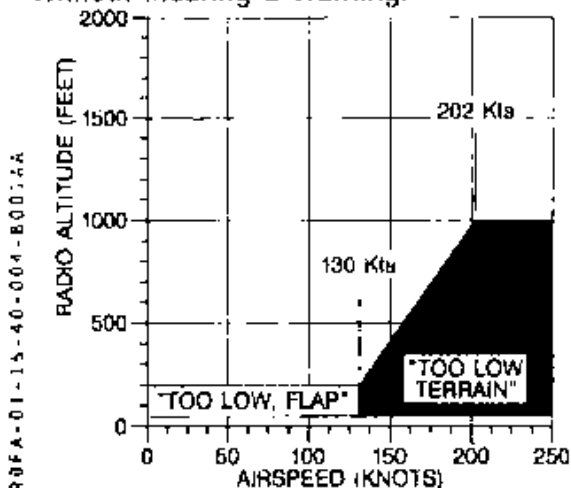
The GPWS selector enables a landing with flaps not in the landing configuration without incurring a warning.



 ATR 72 F.C.O.M.	NAVIGATION SYSTEM GPWS	1.15.40		
		P 5	001	
				DEC 96

AA

LEFT INTENTIONALLY BLANK

	NAVIGATION SYSTEM		1.15.40		
	GPWS		P 6	001	
					DEC 96

MODE 5 : DESCENT BELOW GLIDESLOPE

When the aircraft penetrates the outer envelope while on an ILS approach, a "GLIDE SLOPE" voice alert is given softly. If the inner envelope is penetrated, the same voice alert repeats faster and at a higher volume. In both cases the amber GS caution lights illuminate.

These alerts can be inhibited below 1000 ft AGL in either the hard or soft alert region by depressing one of the GPWS/GS switches. The mode automatically rearms after a missed approach, landing or climb above 1000 ft AGL.

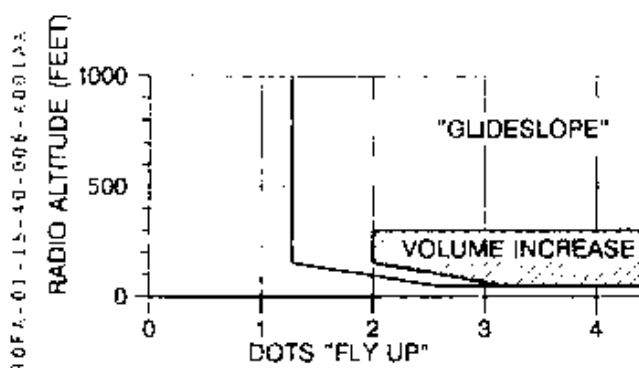

MODE 6 : DESCENT BELOW MINIMUMS

A "MINIMUMS MINIMUMS" voice alert is given when the aircraft passes with gear down through the selected decision height (between 50 and 1000 ft)

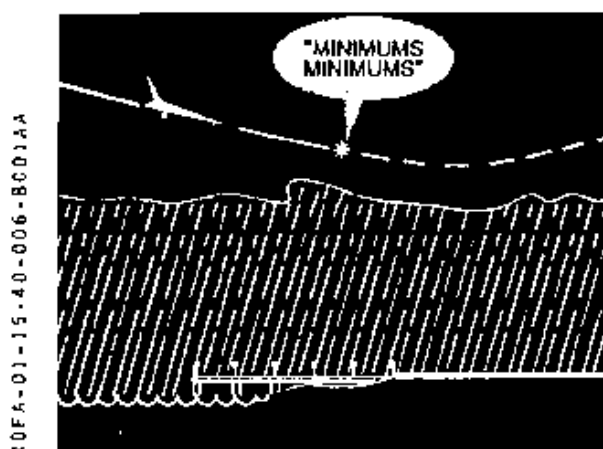

 ATR 72 F.C.O.M.	NAVIGATION SYSTEM		1.15.40	
	GPWS		P 7	001
			DEC 96	

40.2 CONTROLS

GPWS – G/S PB

REF: DL-11-40-007-ACD1A



The pbs on CAPT and F/O panel are identical and connected in parallel. GPWS and G/S indications are integrated into the pbs.

- GPWS** illuminates red as long as any mode 1-2-3-4 alert is activated. The illumination is accompanied by the voice alert for the particular mode.
- G/S** illuminates amber as long as a mode 5 alert is activated. The illumination is accompanied by the voice alert for this particular mode.

- Pressed**
- * On ground, or above 1000 ft with gear up, will perform the system test
 - GPWS FAULT amber It illuminates on CAP
 - G/S amber lights illuminate on both pilots panels
 - voice alert "GLIDE SLOPE" is given
 - one second time delay
 - GPWS red lights illuminate on both pilots panels
 - voice alert "WHOO WHOO PULL UP" is given several times
 - GPWS red lights extinguish
 - G/S lights and GPWS FAULT light will extinguish as soon as the pb is released
 - * below 1000 ft, will inhibit the mode 5 alerts (aural and visual).

GPWS SELECTOR

REF: DL-11-40-007-BB01A

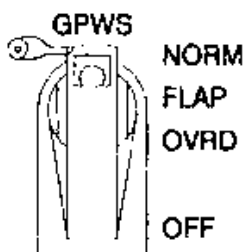

The selector is guarded in the NORM position

- NORM** all alerts are operative
- FLAP OVRD** mode 4 alert caused by flap extension, at less than landing configuration is inhibited to avoid nuisance warnings in case of landing with reduced flap setting.
- OFF** all mode alerts are inhibited.

	NAVIGATION SYSTEM GPWS	1.15.40		
		P 8	001	
				DEC 96

40.3 ELECTRICAL SUPPLY/SYSTEM MONITORING

ELECTRICAL SUPPLY

EQUIPMENT	DC BUS SUPPLY (C/B)	AC BUS SUPPLY (C/B)
GPWS computer	- Nil -	115 VAC BUS 2 (on overhead panel CMPTR)
GPWS alerts	DC BUS 1 (on overhead panel WARN)	- Nil -
GPWS FAULT IND	DC BUS 2 (on overhead panel)	- Nil -

SYSTEM MONITORING

The following conditions are monitored by visual alert :

- GPWS Computer internal failure or power supply loss or input supply loss.
 - GPWS FAULT amber light illuminates on CAP.

40.4 SCHEMATIC

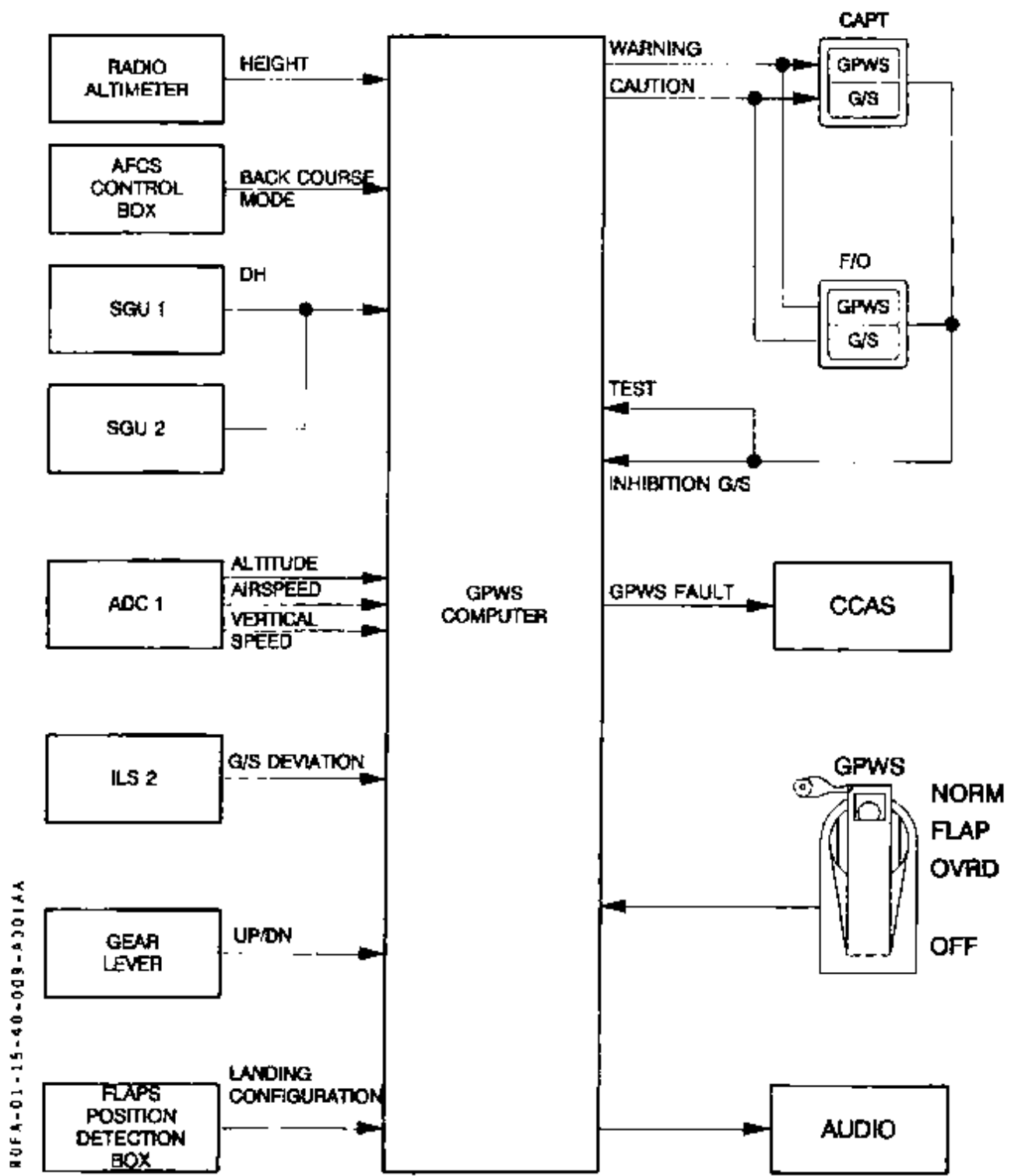

	NAVIGATION SYSTEM	1.15.50	
		P 1	010
	WEATHER RADAR		JUL 00

AA

50.1 DESCRIPTION

Weather radar system is designed for weather impediments detection, up to 300 NM in a 45 degree sector on each side of aircraft path.

Weather impediments are displayed on the EHSI(S) in ARC mode, in 4 colors according to the intensity of rain detected.

Weather radar can also be used in MAP mode to display ground obstacles.

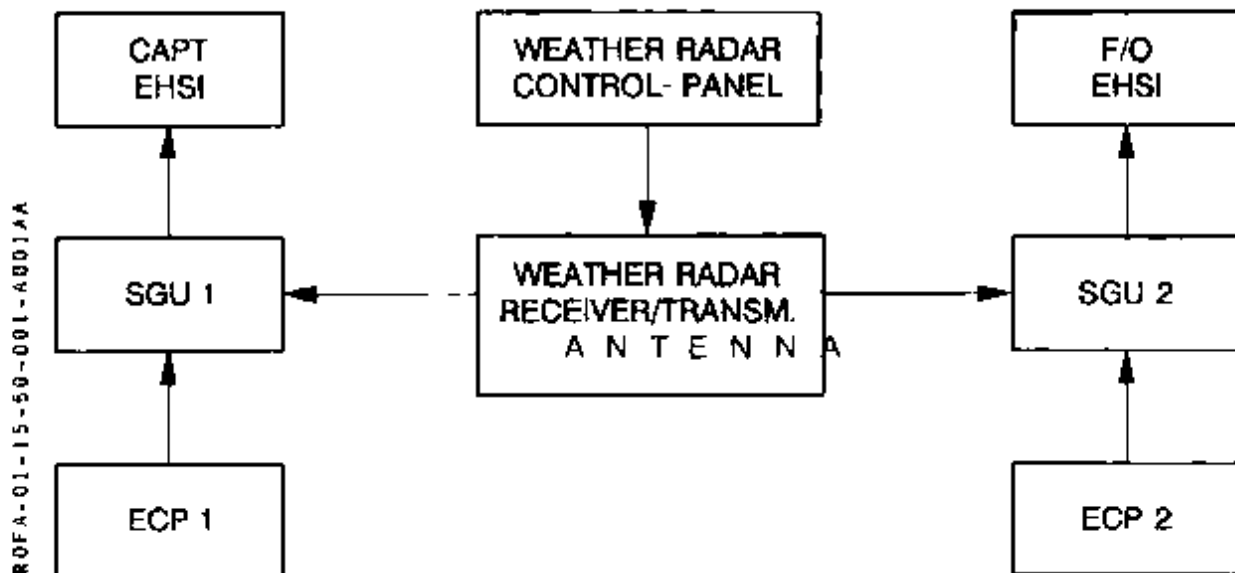

System is controlled with the weather radar control panel. Modes selected on this panel are displayed on the EHSI.

 ATR 72 F.C.O.M.	NAVIGATION SYSTEM	1.15.50	
		P 2	010
	WEATHER RADAR		JUL 00

AA

50.2 CONTROLS

WEATHER RADAR CONTROL PANEL

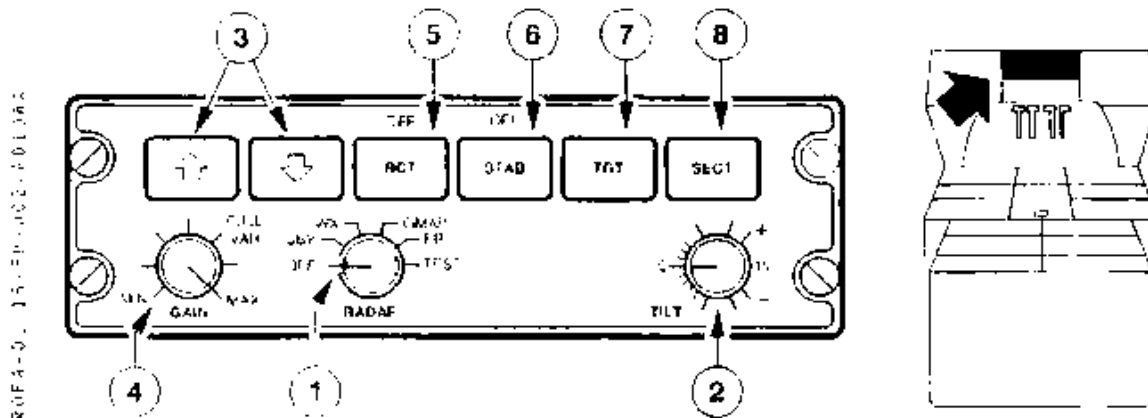

① Mode selector

Enables the selection of the operating mode.

OFF position : The radar system is turned off (WX displayed amber on the EFIS).

SBY position : (STBY displayed green on the EFIS) Places the radar in a ready state with the antenna scan stopped and the transmitter inhibited.

WX position : (WX displayed green on the EFIS) Selects the weather detection mode, displaying five different levels.

Level 0 : Black No detectable cloud

Level 1 : Green Moderate storm

Level 2 : Yellow Less severe storm

Level 3 : Red Strong storm

Level 4 : Magenta Intense storm

On the ground, the system is automatically forced in SBY position for safety. If needed, it is possible to restore the active WX mode by pushing the STAB button four times in three seconds.

GMAP position : (GMAP displayed green on the EFIS) Selects the ground mapping mode using four different levels.

Level 0 : Black No return

Level 1 : Cyan Least reflective return

Level 2 : Yellow Moderate return

Level 3 : Magenta Strong return

FP position : (FPLN displayed green on the EFIS). Clears the screen of radar data and put it in the flight plan mode. The target alert mode (TGT) can be used in FP mode.

TST position : (TEST displayed on the EFIS) displays a test pattern to verify the system.

	NAVIGATION SYSTEM	1.15.50		
		P 3	010	
	WEATHER RADAR			JUL 00

AA

- ② TILT control
Is used to adjust the antenna pitch from 15° down to 15° up.
- ③ RANGE push buttons
Select the different operating ranges from 5 to 300 NM. In the FP mode, additional ranges of 500 and 1000 miles are available.
- ④ GAIN rotary control and push/pull switch
When the switch is pushed, the system enters the preset, calibrated gain mode, in this mode, the rotary control does nothing.
When the switch is pulled, the system enters the variable gain mode, adjustable by the rotary control (VAR is displayed amber on the EFIS).
- ⑤ RCT push button
Activates or deactivates the REACT mode which compensates for attenuation of the radar signal as it passes through rain fall.
The cyan field indicates areas where further compensation is not possible. Any target detected in these areas will be displayed in magenta and should be considered dangerous.
- ⑥ STAB push button
Turns the pitch and roll stability ON and OFF.
- ⑦ TGT push button
Activates and deactivates the radar target alert mode. When activated, TGT is displayed green on the EFIS and the system monitors beyond the selected range and 7.5° on each side of the aircraft heading.
If a characteristic return is detected in the monitored area, the TGT legend on the EFIS changes from green to amber. TGT alert can only be selected in the WX and FP modes.
- ⑧ SECT push button
Is used to select either the normal 12 looks/mn 120° scan or the faster update 24 looks/mn 60° sector scan.

	NAVIGATION SYSTEM		1.15.50	
	WEATHER RADAR		P 4	010
			JUL 00	

EHSI DISPLAY

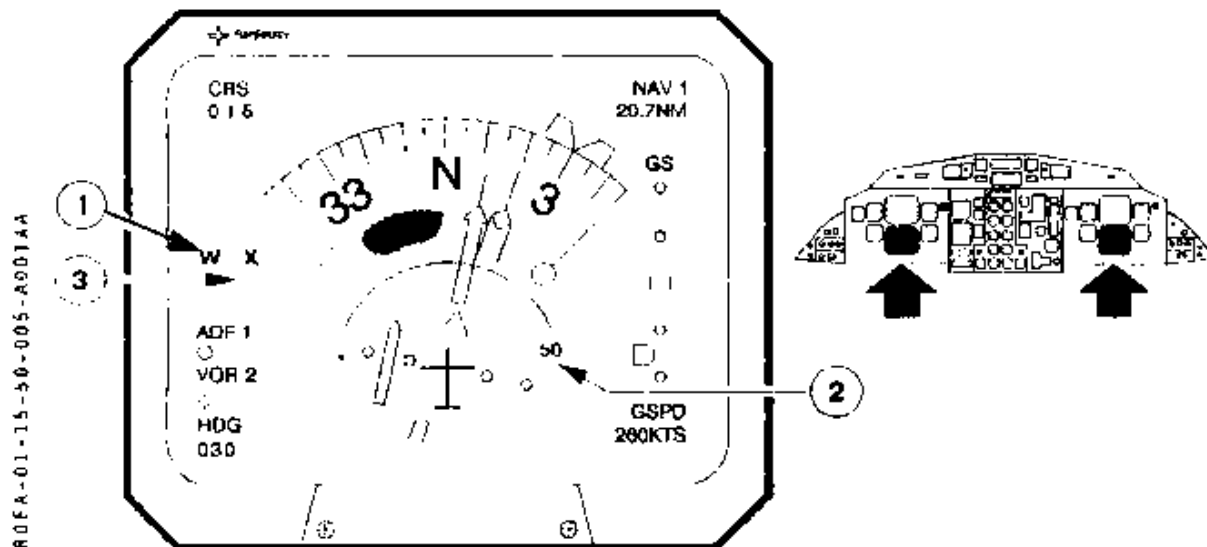

① Radar Mode Annunciator

Appears as soon as the weather radar is switched on.

- WAIT (green) : corresponds to the radar unit warning up time (is illuminated during 90 seconds)
- STBY (green) : radar is in STBY mode.
- TEST (green) : illuminates green when a test is initiated
- WX :
 - illuminates green when radar is operative
 - illuminates amber to indicate that radar is not working when it is either :
 - . selected ON on EFIS Control Panel (ECP) but OFF on Radar Control box.
 - . or selected ON on both ECP and Radar Control box but antenna is not scanning.
- G MAP (green) : enables to display the ground obstacles
- RCT (green) : Rain Echo Attenuation Compensation Technique mode is engaged.
- TX (magenta) : illuminates when radar operates with the screen dimmed.

② Distance indication (white)

Appears as soon as ARC mode is selected on EHSI.

③ Weather indication

Is displayed in four colors.

 ATR 72 F.C.O.M.	NAVIGATION SYSTEM	1.15.50		
		P 5	010	
	WEATHER RADAR			JUL 00

AA

LEFT INTENTIONALLY BLANK

	NAVIGATION SYSTEM WEATHER RADAR	1.15.50		
		P 6	001	
				DEC 96

50.3 ELECTRICAL SUPPLY

EQUIPMENT	DC BUS SUPPLY (C/B)	AC BUS SUPPLY (C/B)
Weather radar	DC BUS 1 (on overhead panel 28 VDC)	115 VAC BUS 1 (on overhead panel 115 VAC)

 ATR 72 F.C.O.M.	NAVIGATION SYSTEM	1.15.60	
	GLOBAL NAVIGATION SATELLITE SYSTEM	P 1	130
	GNSS		JUL 01

AA

60.1 DESCRIPTION

(See schematic P. 11/12)

Using information provided by a constellation of 24 satellites (the HT 1000 is able to track up to 12 satellites at a time), GNSS is an automatic tridimensional (latitude, longitude, altitude) location and navigation means. It also uses data recorded in a data base.

The data base is stored in the NPU and is updated every 28 days on the ground using a specific data loader. The effective date periods are displayed on the MCDU IDENT page.

The navigation is normally performed using the GPS sensor (GPS mode). In the case where the GPS position becomes unavailable, the dead reckoning mode (DR) is used like a back-up utilizing true airspeed, heading and the last computed wind data.

FUNCTIONS

HT 1000 is capable of performing all the functions associated with the great circle navigation.

It mainly allows to perform:

- "Direct To" navigation
- Flight plan navigation
- Navigation to nearest airport (or nearest VOR, NDB...)
- Vertical navigation (non-coupled to auto-pilot)
- Non precision approach

To know all the functions available, refer to the table of contents of the HT 1000 pilot's guide.

	NAVIGATION SYSTEM		1.15.60	
	GLOBAL NAVIGATION SATELLITE SYSTEM		P 2	090
	GNSS			JUL 00

AA

60.2 CONTROLS

HT 1000 CONTROLS

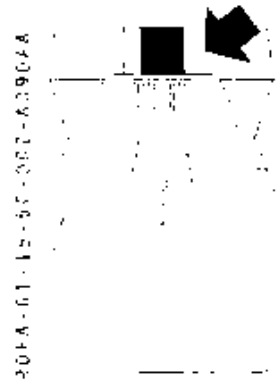

2014-01-15-01-001-A3904A

The MCDU is the pilot interface for operation and data entry of the HT 1000 and also displays routes and advisory data on a color 5.5" liquid crystal display. The display has 14 lines of data with 24 characters per line. The MCDU keyboards provides for data input and display selection and control.

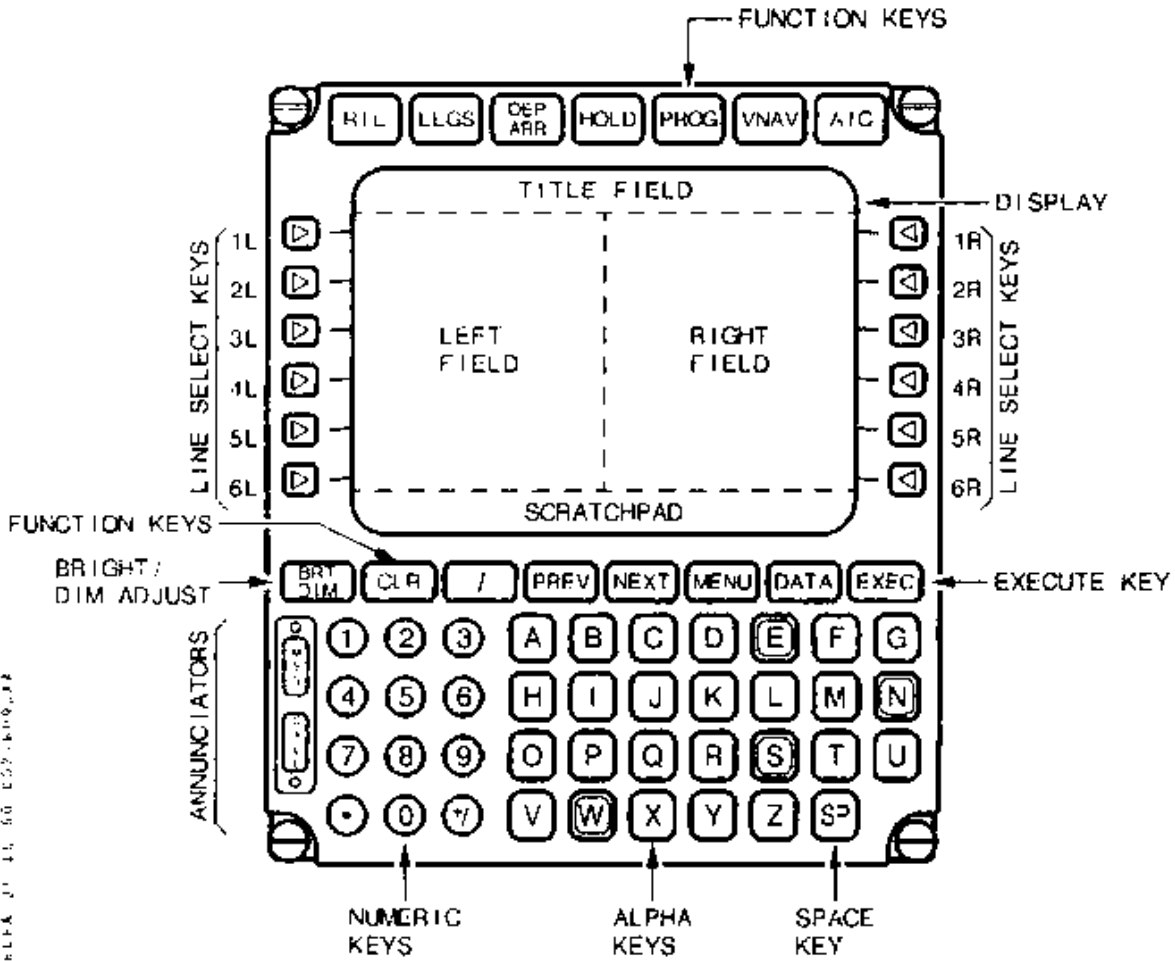

2014-01-15-01-001-A3904A

	NAVIGATION SYSTEM GLOBAL NAVIGATION SATELLITE SYSTEM		1.15.60		
	GNSS		P 3	090	
			JUL 00		

AA

EFIS CONTROL PANEL

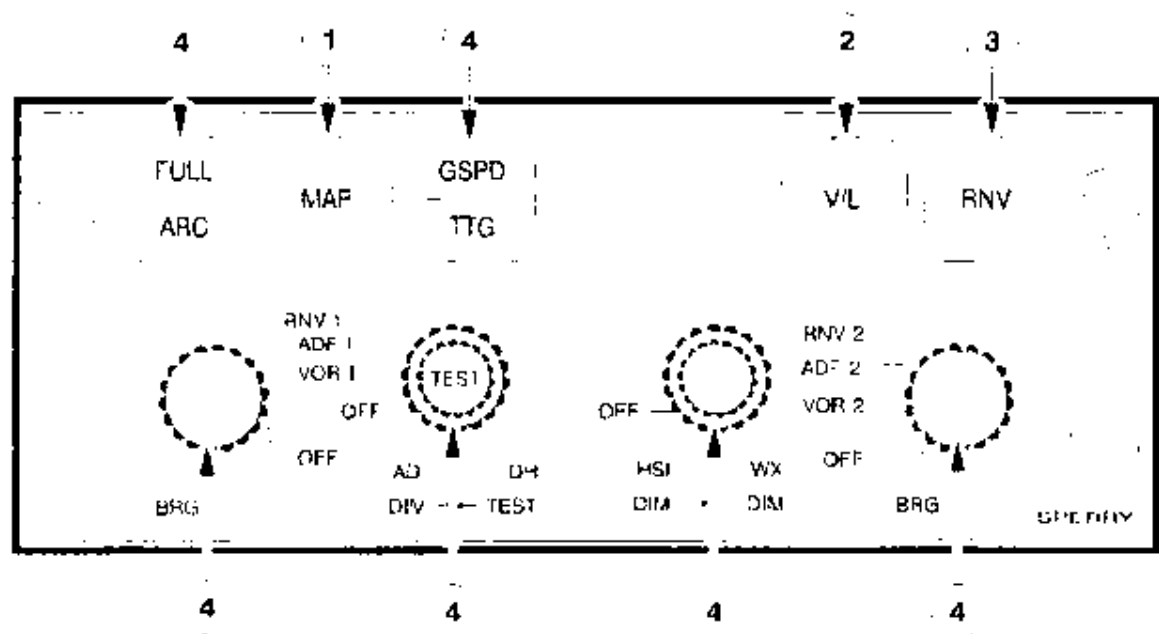

R09A 01 25-00-001-ADD001A

- ① **Map pb**
 Repetitive action on this pb selects alternately MAP display and ARC display on EHSI.
 In MAP selection, waypoints of the flight plan are displayed in white except the active waypoint which is magenta.
- ② **V/L pb**
 Action on this pushbutton causes selection of the VOR/LOC mode.
- ③ **RNV pb**
 Action on this pushbutton causes selection of the GNSS mode.
- ④ **Refer to 1.10.30.**

AA

EHSI - MAP DISPLAY

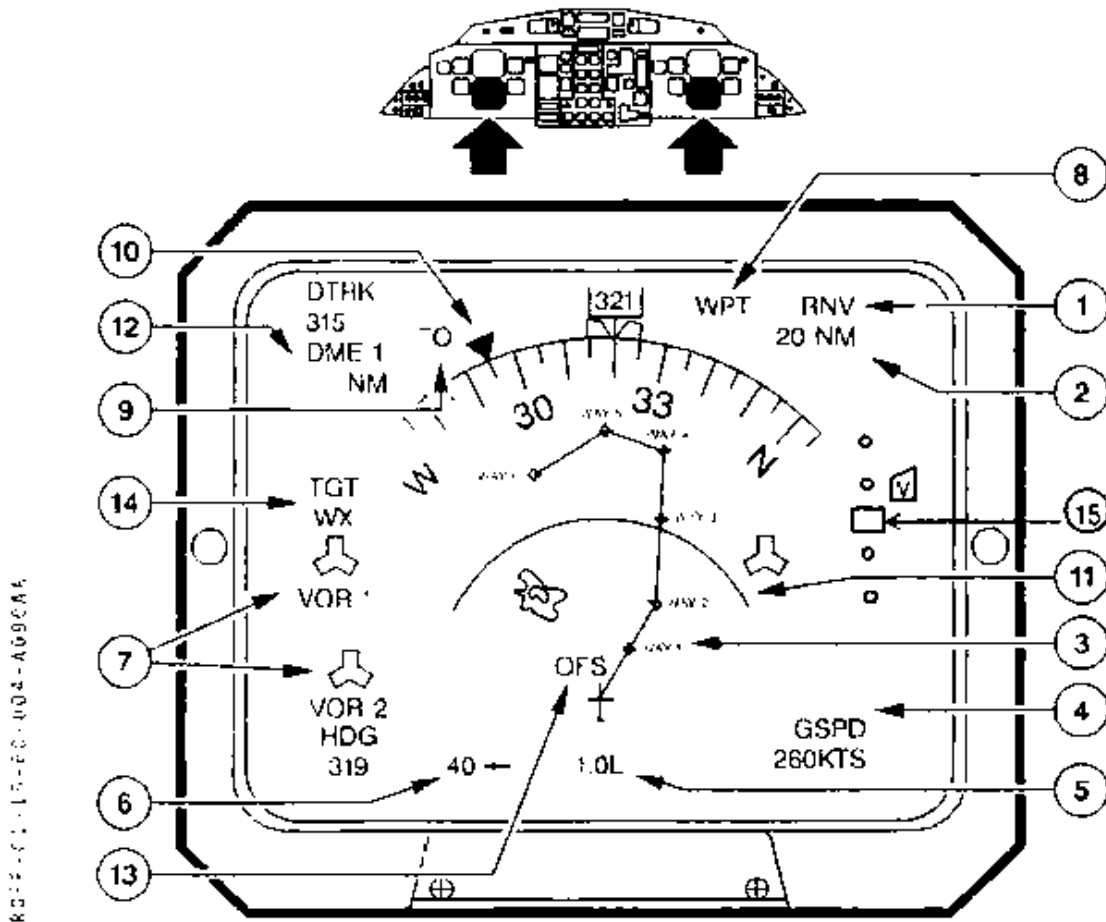

R015-C1-15-FC-004-AG9CA4

NAV source annunciation

Identifies the source which supplies the EHSI.

- ① This information is blue when only one crew member uses GNSS. It becomes amber when both Pilot and F/O use GNSS as navigation source.
- ② **Distance counter**
Indicates the distance computed by GNSS to the next waypoint.
- ③ **Waypoints**
 - next waypoint (magenta)
 - other waypoint (white)
 - indicates an airport
 - indicates a VOR

	NAVIGATION SYSTEM	1.15.60		
	GLOBAL NAVIGATION SATELLITE SYSTEM	P 5	110	
	GNSS			JUL 00

AA

- ④ Ground speed indicator
Indicates the ground speed calculated by the GNSS.
- ⑤ Track deviation
Indicates in NM and tenths of NM the track deviation to the left (L) or to the right (R) of the intended track.
- ⑥ Wind indicator
An arrow and a figure indicates the direction and the velocity (in kt) of the wind.
- ⑦ VOR/RNV symbols

·	RNV
·	VOR

Only VOR/DME or RNV waypoints will be presented on the MAP display.
VOR/RNV 1 is displayed in blue.
VOR/RNV 2 is displayed in green.
- ⑧ WPT/DGR alerting
WPT illuminates amber when approaching a waypoint
DGR illuminates amber when the "UNABLE RNP" message is displayed on the MCDU.
- ⑨ TO/FROM indicator (magenta)
- ⑩ Drift angle indicator (magenta)
- ⑪ Radar's range selector may be used to select the distance scale.
- ⑫ DME 1/2
Indicates the distance given by DME 1/2.
- ⑬ OFS (cyan)
Indicates that a parallel offset has been activated.
- ⑭ RADAR status
- ⑮ Vertical deviation
Scale and Index

	NAVIGATION SYSTEM GLOBAL NAVIGATION SATELLITE SYSTEM GNSS	1.15.60		
		P 6	110	
				JUL 00

AA

EHSI - ARC DISPLAY

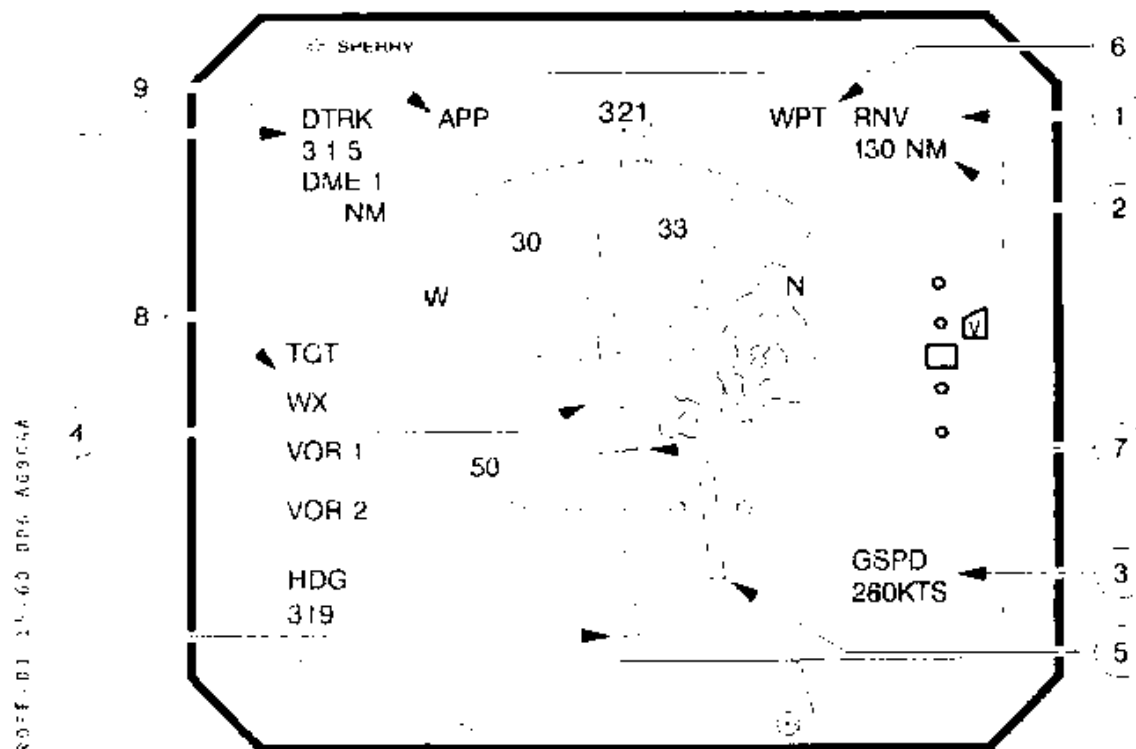

- ① NAV source annunciation
Identifies the source which supplies the EHSI. This information is blue when only one crew member uses GPS. It becomes amber when both Capt and F/O use GPS as navigation source.
- ② Distance counter
Indicates the distance computed by GPS to the next waypoint.
- ③ Ground speed indicator
Indicates the ground speed calculated by the GPS.
- ④ Desired track indication
- ⑤ Lateral deviation to the track
- ⑥ WPT/DGR alerting
WPT illuminates amber when approaching a waypoint
DGR illuminates amber when the "UNABLE RNP" message is displayed on the MCDU.
- ⑦ TO/FROM annunciator
- ⑧ RADAR status
- ⑨ APP/OFS
APP illuminates cyan when in approach phase.
OFS illuminates cyan when an offset has been activated.

	NAVIGATION SYSTEM	1.15.60	
	GLOBAL NAVIGATION SATELLITE SYSTEM	P 7	110
	GNSS		JUL 00

AA

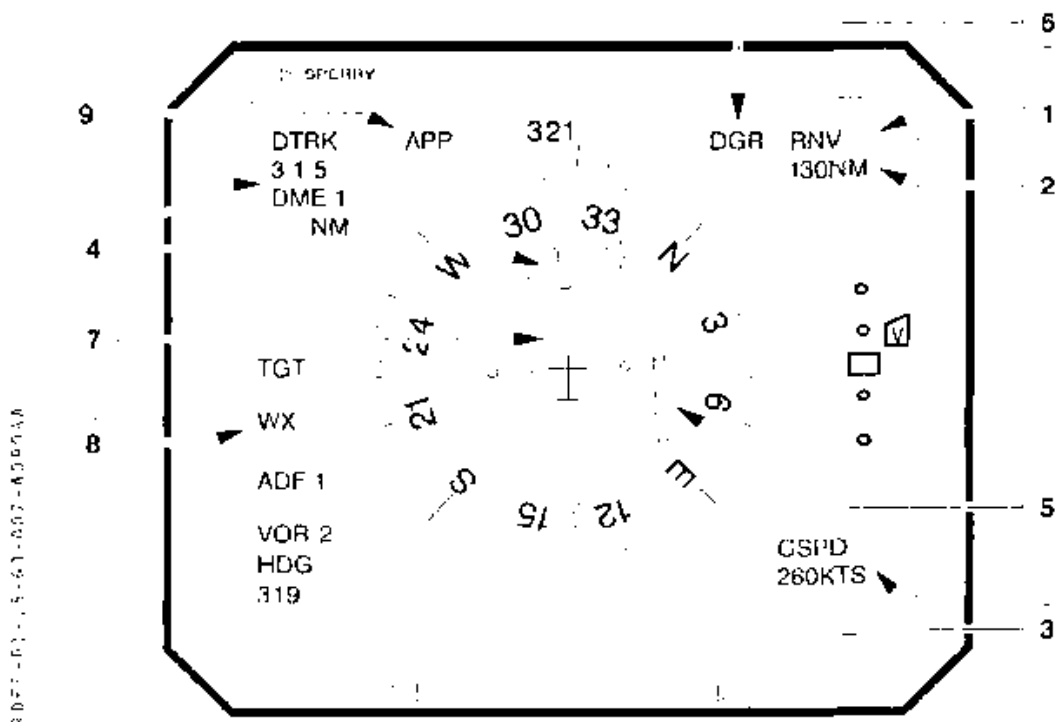
EHSI - FULL MODE

- ① NAV source annunciation
Identifies the source which supplies the EHSI.
This information is blue when only one crew member uses GPS. It becomes amber when both Capt and F/O use GPS as navigation source.
- ② Distance counter
Indicates the distance computed by GPS to the next waypoint.
- ③ Ground speed indicator
Indicates the ground speed calculated by the GPS.
- ④ Desired track indication
- ⑤ Lateral deviation to the track
- ⑥ WPT/DGR alerting
WPT illuminates amber when approaching a waypoint
DGR illuminates amber when the "UNABLE RNP" message is displayed on the MCDU.
- ⑦ TO/FROM annunciator
- ⑧ RADAR status
- ⑨ APP/OFS
APP illuminates cyan when in approach phase.
OFS illuminates cyan when an offset has been activated.

 ATR 72 F.C.O.M.	NAVIGATION SYSTEM		1.15.60		
	GLOBAL NAVIGATION SATELLITE SYSTEM		P 8	110	
	GNSS				JUL 00

AA

EADI

Alerting messages and displays related to the HT 1000 operation.

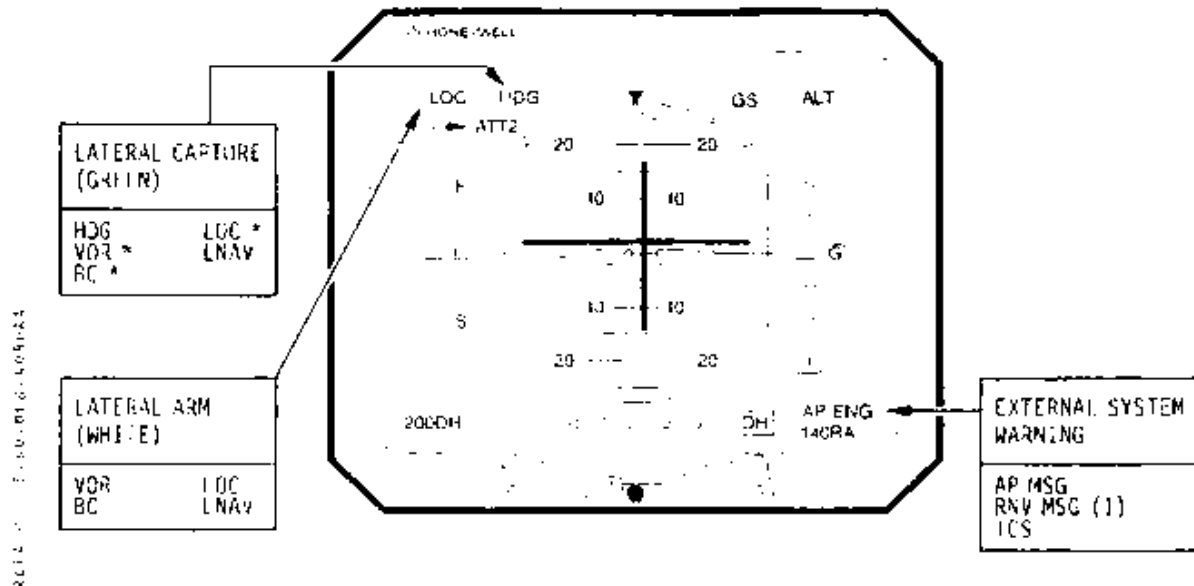

(1) RNV MSG is triggered by one of the following messages displayed on the MCDU:

- UNABLE RNP: message annunciated when ANP exceeds RNP or integrity is greater than twice the selected RNP (Once the value for approach). The conditions for displaying this message are flight phase dependent as follows:

PHASE OF FLIGHT	DEFAULT RNP (NM)	Unable RNP Time to Alarm (s)
OCEANIC	12	80
EN ROUTE	2	80
TERMINAL	1	60
APPROACH *	0.3	10

* Not applicable

- DEAD RECKONING: message annunciated when NAV source becomes dead reckoning (GPS and DME modes are lost).
- VERIFY RNP ENTRY: message annunciated when the pilot entered RNP is greater than default current RNP.
- VERIFY RNP-POS REF: message annunciated when flight phase changes and current pilot entered RNP is greater than the default RNP for new flight mode.
- UNABLE APPROACH: message annunciated when within 2 NM from the FAF, and RAIM prediction at FAF/MAP fails, or navigation source is not GPS.

VERTICAL TRACK CHANGE ALERT

This message and annunciator is displayed prior to reaching a vertical track change.

END OF DESCENT

This message appears whenever the aircraft reaches the last altitude constraint on the descent path.

	NAVIGATION SYSTEM	1.15.60		
	GLOBAL NAVIGATION SATELLITE SYSTEM	P 9	270	
	GNSS			JUL 00

AA

In addition there are some advisory messages such as:

- RAIM LIMIT EXCEEDS XX NM: message annunciated when the GPS RAIM protection Limit exceeds TSO-C129 requirement for current flight phase.
- CHECK DEST RAIM-POS REF: message annunciated within 30 NM of destination airport if active route contains approach and approach RAIM predicted to be non available for some period of time within 15 minutes of destination ETA.

RNV MSG will extinguish when the associated MCDU message is cancelled.

60.3 ELECTRICAL SUPPLY

EQUIPMENT	DC BUS SUPPLY
GNSS	DC STBY BUS (on overhead panel GPS)

	NAVIGATION SYSTEM GLOBAL NAVIGATION SATELLITE SYSTEM GNSS	1.15.60		
		P 10	090	
				JUL 00

AA

LEFT INTENTIONALLY BLANK

	NAVIGATION SYSTEM GLOBAL NAVIGATION SATELLITE SYSTEM GNSS	1.15.60	
		P 11/12	110
			JUL 01

60.4 SCHEMATIC

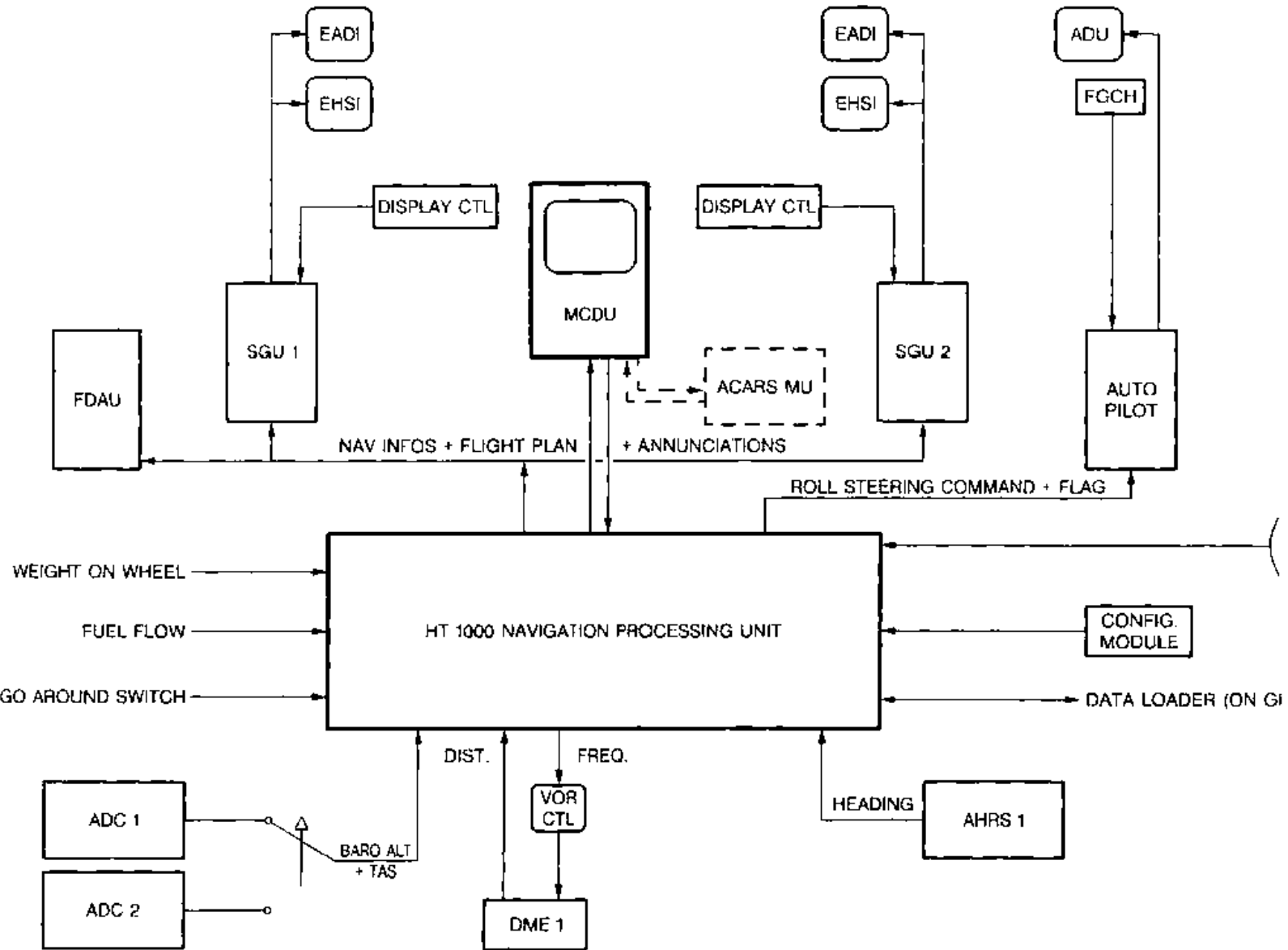

	POWER PLANT		1.16.00	
	CONTENTS		P 1	001
				DEC 96

1.16.00 CONTENTS

1.16.10 GENERAL

1.16.20 SYSTEMS DESCRIPTION

- 20.1 ENGINE
- 20.2 FUEL SYSTEM
- 20.3 LUBRICATION SYSTEM
- 20.4 IGNITION SYSTEM
- 20.5 PROPELLER
- 20.6 SCHEMATICS

1.16.30 SYSTEMS OPERATING

- 30.1 GENERAL
- 30.2 ENGINE GOVERNING
- 30.3 PROPELLER SPEED GOVERNING

1.16.40 CONTROLS

- 40.1 ATPCS
- 40.2 POWER LEVERS (PL)
- 40.3 IDLE GATE
- 40.4 CONDITION LEVERS (CL)
- 40.5 INDICATORS & CONTROL PANELS

1.16.50 LATERAL MAINTENANCE PANEL

1.16.60 ELECTRICAL SUPPLY/MFC LOGIC/SYSTEM MONITORING

	POWER PLANT	1.16.10		
		P 1	550	
	GENERAL			JUN 97

AA

The engine is a Pratt & Whitney of Canada PW 127 F certified for a 2750 SHP max take-off rating . However, in normal operation, take-off rating will be 2475 SHP with an automatic power increase to 2750 SHP (reserve take-off rating RTO) in case of other engine failure.

Power setting is characterized by constant power lever and condition lever positions. The power adapted to the flight phase is selected by the pilot through a power management selector.

The engine comprises two spool gas generators driving a six blade propeller via a free turbine/concentric shaft/reduction gear box assembly. Propeller regulation is electronically controlled.

The propeller is an Hamilton Standard 568 F

- Diameter : 3.93 m (12.9 ft)
- Rotation : clockwise (looking forward)
- 100 % Np : 1200 RPM
- Weight: : 180 kg

The engine accessories are mounted on two accessory gear boxes, one driven by the HP spool, and one by the propeller reduction gear box.

	POWER PLANT SYSTEMS DESCRIPTION	1.16.20		
		P 1	001	
				DEC 96

20.1 ENGINE (See schematics p 7/8)

MAIN COMPONENTS (See CROSS-SECTION)

① Low Press Compressor

The low press compressor is a centrifugal type.

② High Press Compressor

The high press compressor is a centrifugal type.

③ Diffuser Pipes

The diffuser pipes from the first stage lead into constant diameter cross over ducts which blend together to give a full ring with uniform flow at entry to the second stage.

④ Combustion Chamber

The combustion chamber is of the fully annular reverse flow perforated sheet metal type. Fourteen piloted air blast fuel nozzles provide quick, clean light offs. Hot inner parts are ceramic-covered.

⑤ High Press Axial Turbine

The high pressure axial turbine drives the high press compressor. It incorporates a cooled vane ring and cooled blades permitting an increase in turbine inlet temperature, higher specific work and consequently a lower flow and a lighter engine.

⑥ Low Press Axial Turbine

The low press axial turbine drives the low press compressor. It has uncooled blades and vanes.

⑦ Free Turbine

The two axial free turbine stages drive the reduction gear box.

⑧ Accessory Gear Box

Turbo machine accessories are mounted on the accessory gear box which is driven by the HP spool. The accessory gear box is located at the top of the engine and contains drives for :

- The DC starter/generator,
- The HP fuel pump,
- The oil pumps.

	POWER PLANT	1.16.20		
		P 2	550	
	SYSTEMS DESCRIPTION			JUN 97

AA

⑨ Propeller Reduction Gear Box

The power turbine shaft is connected to the propeller reduction gear box by a coupling driveshaft flexible diagram connections at each end. The gear box is mounted offset of the centerline of the turbo machine. The speed reduction is obtained in two stages. On the reduction gear box are installed.

- The ACW generator
- The propeller Valve Module (PVM) controlled by Propeller Electronic Control (PEC).
- The (HP) pump and overspeed governor
- The auxiliary feather pump
- The propeller brake (on RH engine only)
- The fuel cooled oil cooler (FCOC)

Note : Auxiliary feather pump is driven electrically. On ground, its activation by the CL is inhibited.

The other components are actuated through the reduction gear box.

AIR INLET

As presented on figure, the engine air intake ① is offset and is a shallow "S" bend designed to provide uniform inlet flow to the compressor. The curvature ② is intended to provide inertial separation and protection in the event of foreign object ingestion. It is also used to divide airflow in a primary flow directed to the engine, and a secondary flow directed to the oil cooler ③. Control of the secondary airflow is achieved by automatic oil cooler flaps positioning ④.

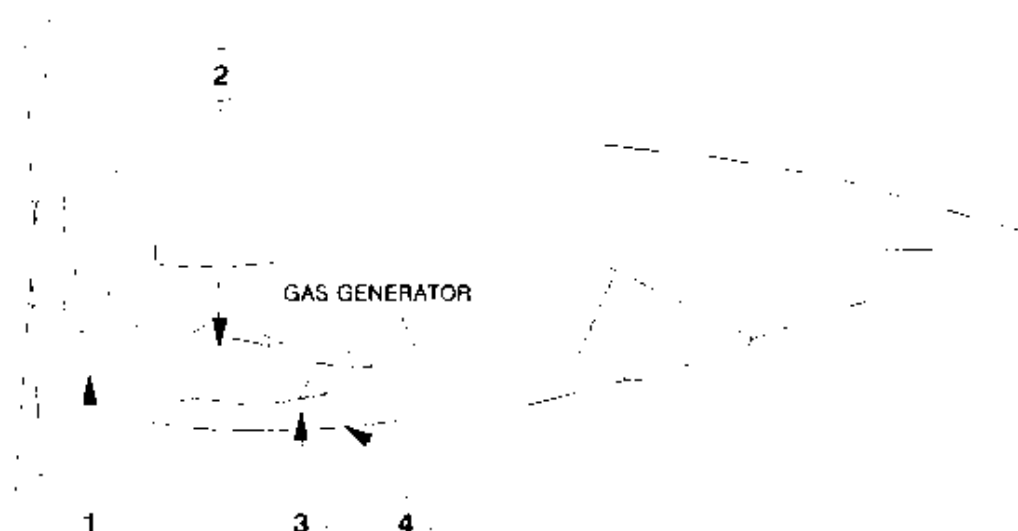

	POWER PLANT		1.16.20		
			P 3	001	
	SYSTEMS DESCRIPTION				JUL 98

AA

R 20.2 FUEL SYSTEM

The fuel supplied from the A/C fuel tank flows through :

- A fuel heater which includes :
 - a screen (1) with a by-pass capability.
 - a fuel heater element (2). The source of heat is engine oil, and the fuel temperature is thermostatically controlled. A fuel heater outlet temperature indication is provided.
- A HP pump (3) with a filter, a clogging indicator is provided on pilot's panel.
- The Hydro Mechanical Unit (HMU) which has two functions :
 - to meter the fuel flow delivery to the engine by a metering valve assembly (4), the excess being returned to HP pump inlet,
 - to provide the HP motive flow required by the fuel tank jet pump through an engine valve (5).
- A fuel flowmeter (6).
- A Fuel Cooled Oil Cooler (FCOC) (7), that provides cooling of the lubricating system by using fuel system as cooling source.
- A flow divider (8) to the fuel nozzles.

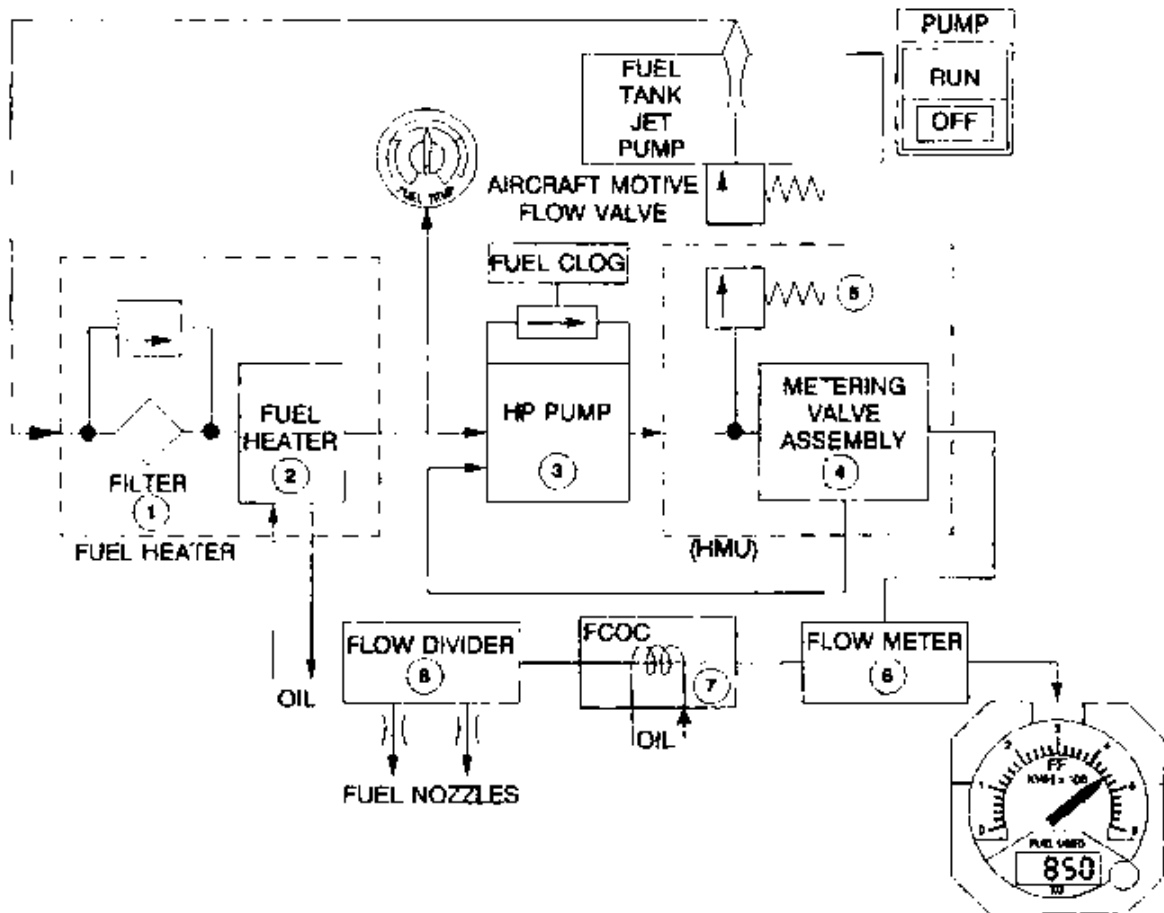

ROFA-01-16-20-003-490124

	POWER PLANT	1.16.20		
	SYSTEMS DESCRIPTION	P 4	550	
				JUL 00

AA

20.3 LUBRICATION SYSTEM (See schematic P9/10)

Synthetic oil specification MIL-L-23699.

A single oil system serves the turbo machinery, the reduction gear box and the propeller pitch change system.

- Oil Tank

Oil is contained in a 14.4 L tank (1). A filter cap is provided on the tank. Quantity indication is checked by sight glass (or by a dipstick) on the side of the tank.

- Pressure system

A gear pump (2) driven by the accessory gear box supplies oil through an air cooler (3) mounted in the nacelle and a filter (4) both fitted with by-passes in case of clogging.

RGB oil is also cooled in a fuel heater, (5) as well as the FCOC (6). An oil temperature sensor is provided.

Oil pressure is controlled by a regulating valve (7). A low temp. valve (8) is provided to eliminate damaging pressures surges on cold starts. A pressure transducer (9) and a low pressure switch (10) are installed.

- Scavenge system

Scavenging is blown down or gravity drained except for N° 6 and 7 bearing cavity and the reduction gear box, on which gear pumps are used.

20.4 IGNITION SYSTEM

R Each engine is equipped with a high energy ignition system. It consists of two engine
R mounted ignition exciters (A and B) powered by the DC ESS BUS and two spark
R igniters, one for each ignition exciter. Ignition cycle includes two phases. During 25 s, the
R intensity is 5 to 6 sparks/s and then, the intensity becomes 1 spark/s.

The engine ignition system provides ignition for :

- On ground starting using exciter A, exciter B, or exciters A+B (according to ENG START rotary selector position).

Note : Using exciter A or exciter B may allow to detect an hidden failure.

- In flight starting using exciters A+B regardless of start selection.

In addition, for each engine, in case of NH drop below 60 % exciters A+B are automatically activated. This action is inhibited if :

- NH drops below 30 %, or
- EEC is deselected, or
- CL is set on feather or fuel S/O position, or
- On the failed engine in case of ATPCS sequence.

Note : When EEC is deselected, exciters A+B can manually be activated, using the MAN IGN guarded push-button.

	POWER PLANT	1.16.20		
	SYSTEMS DESCRIPTION	P 5	550	
				JUL 98

AA

R **20.5 PROPELLER** (See schematic P11/12)

The propeller is driven by a free power turbine by means of a reduction gear box. Pitch (B) change is hydromechanically controlled by a Propeller Valve Module (PVM). The PVM is controlled by a Propeller Electronic Control (PEC) installed in each engine nacelle which provides the synchrophasing between the two propellers.

Interface between flight deck and PEC is ensured by a Propeller Interface Unit (PIU) installed in the electronic rack.

The propeller control system uses the condition lever, the PWR MGT rotary selector and the power lever to activate the pitch change mechanism through the governors and associated equipments.

The system is protected against :

- Low pitch angle in flight,
- Overspeed,
- Hydraulic pressure loss.

The RH Propeller Reduction Gear Box is provided with a brake to be used on the ground for Hotel mode operation.

PVM

The PVM is installed on the reduction gear box and allows :

- The basic speed set
- Beta scheduling
- Reversing
- Synchrophasing
- Feathering
- Low pitch protection

$$-14^{\circ} \text{ (Reverse)} < \beta_{\text{ref}} < 78.5^{\circ} \text{ (Feather)}$$

Additionally it is used, with the overspeed governor, to contain propeller overspeed.

The PVM comprises :

- An Electro Hydraulic Valve (EHV) which meters the pitch change oil to the pitch change actuator and allows a normal feathering of the propeller.
- A protection valve which is a part of overspeed, low pitch and back-up feathering functions.
- A feather solenoid (EHV back-up).
- A Rotary Variable Differential Transducer (RVDT) which adjust and confirm PLA position.

	POWER PLANT	1.16.20		
	SYSTEMS DESCRIPTION	P 6	570	
				JUN 97

AA

PEC

The PEC is a dual channel electronic box which provides closed loop control over the propeller pitch change system. The PEC detects, isolates and accomodates systems faults.

In the event of a failure of the primary channel, control of the propeller system will automatically be transfered to the back-up channel.

Propeller speed is calculated by the PEC through EEC (altitude and airspeed data) and Np sensors.

PIU

The PIU (one per PEC) is an electronic box located in the electronic rack that realizes the interface between the PEC and the cockpit for propeller speed selection, and PEC fault signalisation logics.

PROPELLER BRAKE

The propeller brake is fitted on a countershaft on the RH engine reduction gearbox in order to stop the propeller (and the power turbine).

When the engine is running in Hotel mode :

- The HP spool drives the DC generator.
- Bleed pressure is available downstream the HP compressor and supplies both packs.

ENGAGEMENT LOGIC

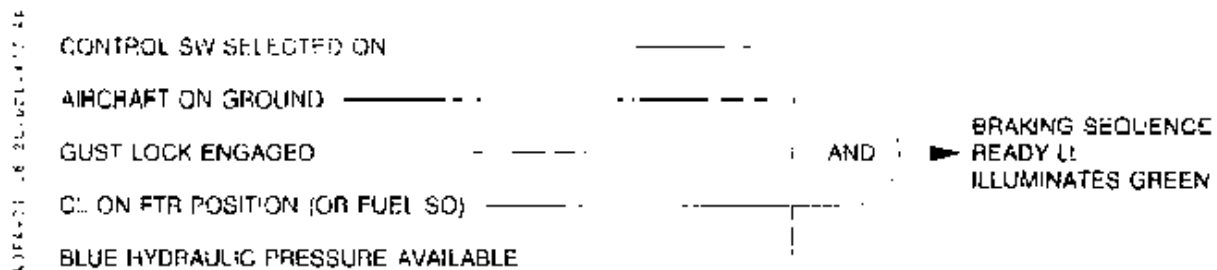

READY light must be illuminated, prior to any propeller brake activation. Loss of one of the above mentionned required conditions for engagement, will not imply propeller brake disengagement. However, when gust lock is released and propeller brake is still engaged, PROP BRK light will illuminate red on CAP, associated with CRC.

Note : After a propeller braking or releasing sequence, READY light may remain illuminated for about 15 s.

20.6 SCHEMATICS

CROSS SECTION

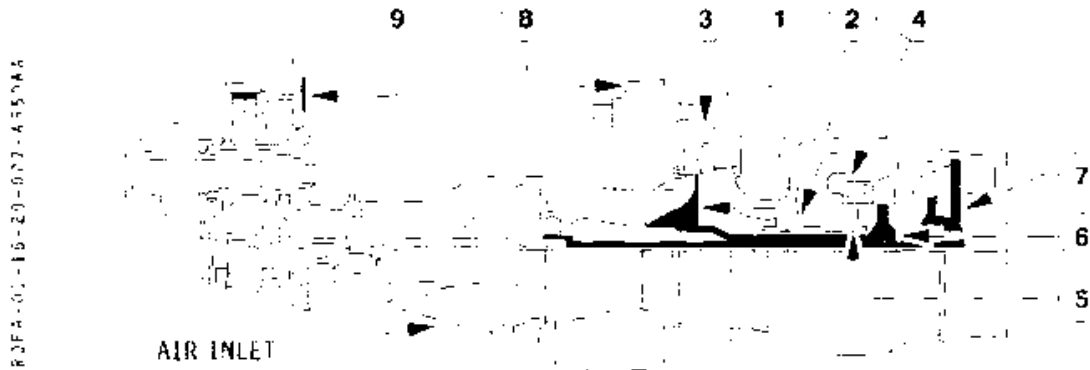

EXTERNAL VIEW (RIGHT)

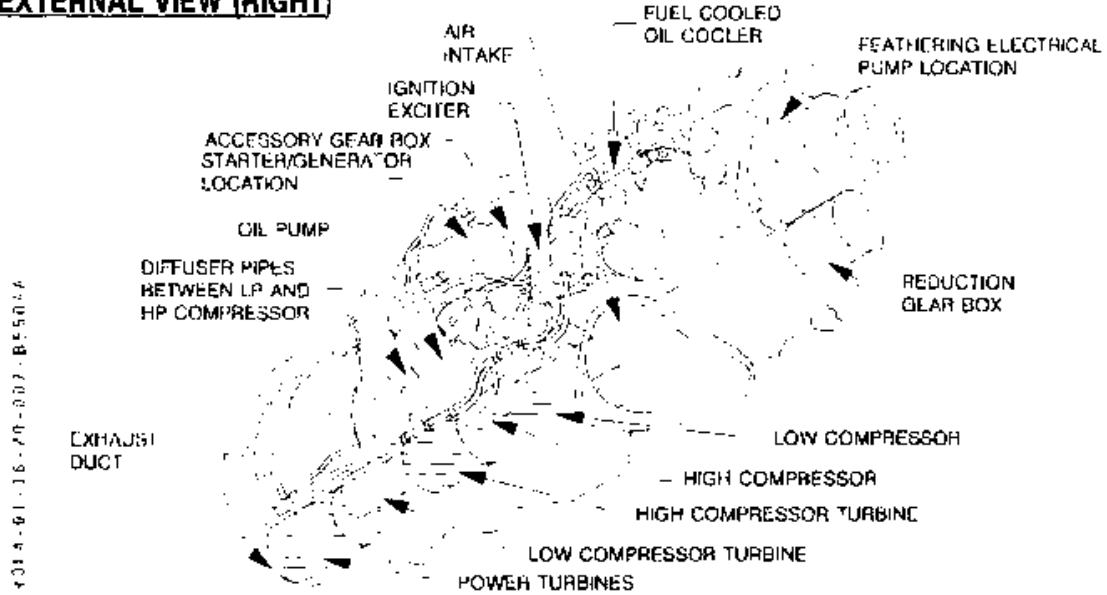

EXTERNAL VIEW (LEFT)

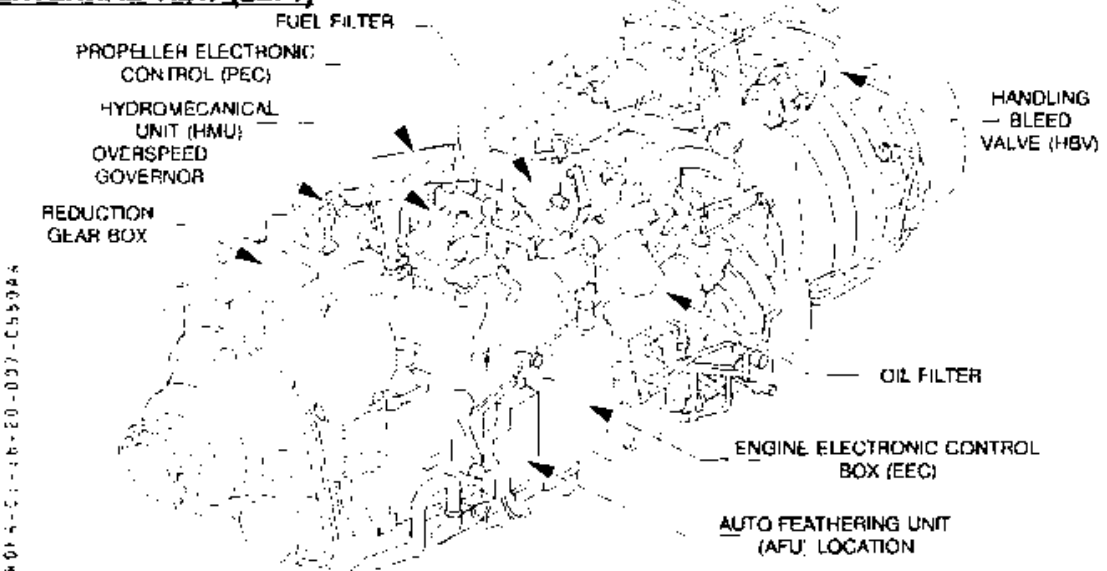



AR 72
F.C.O.M.

POWER PLANT

SYSTEMS DESCRIPTIONS

1.16.20

P 9/10

001

DEC 97

LUBRICATION SYSTEM

ROFA-01-16-20-009-60114

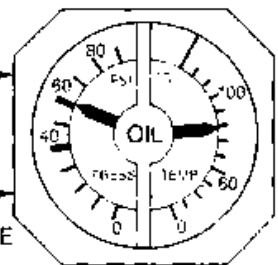
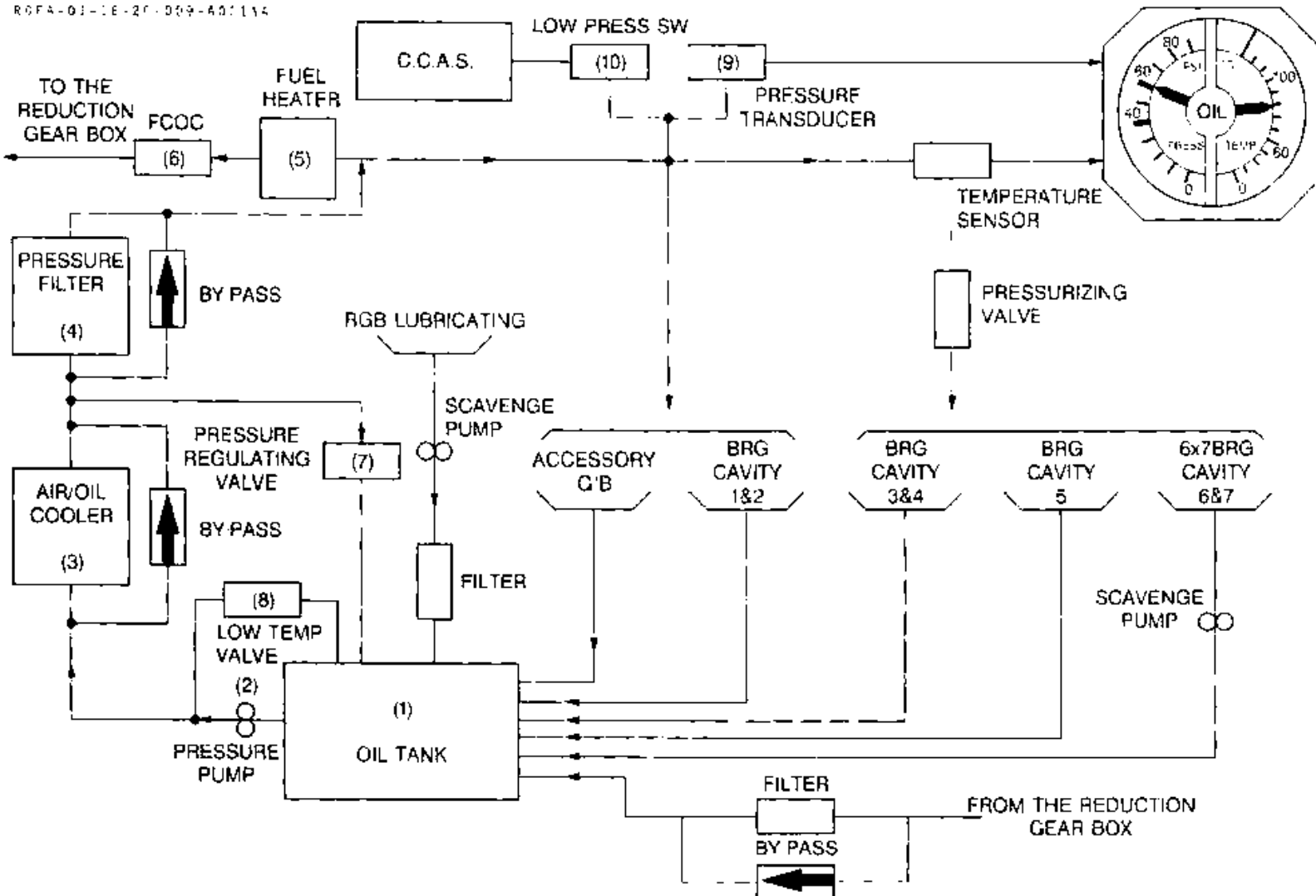

PROPELLER REGULATION SCHEMATIC

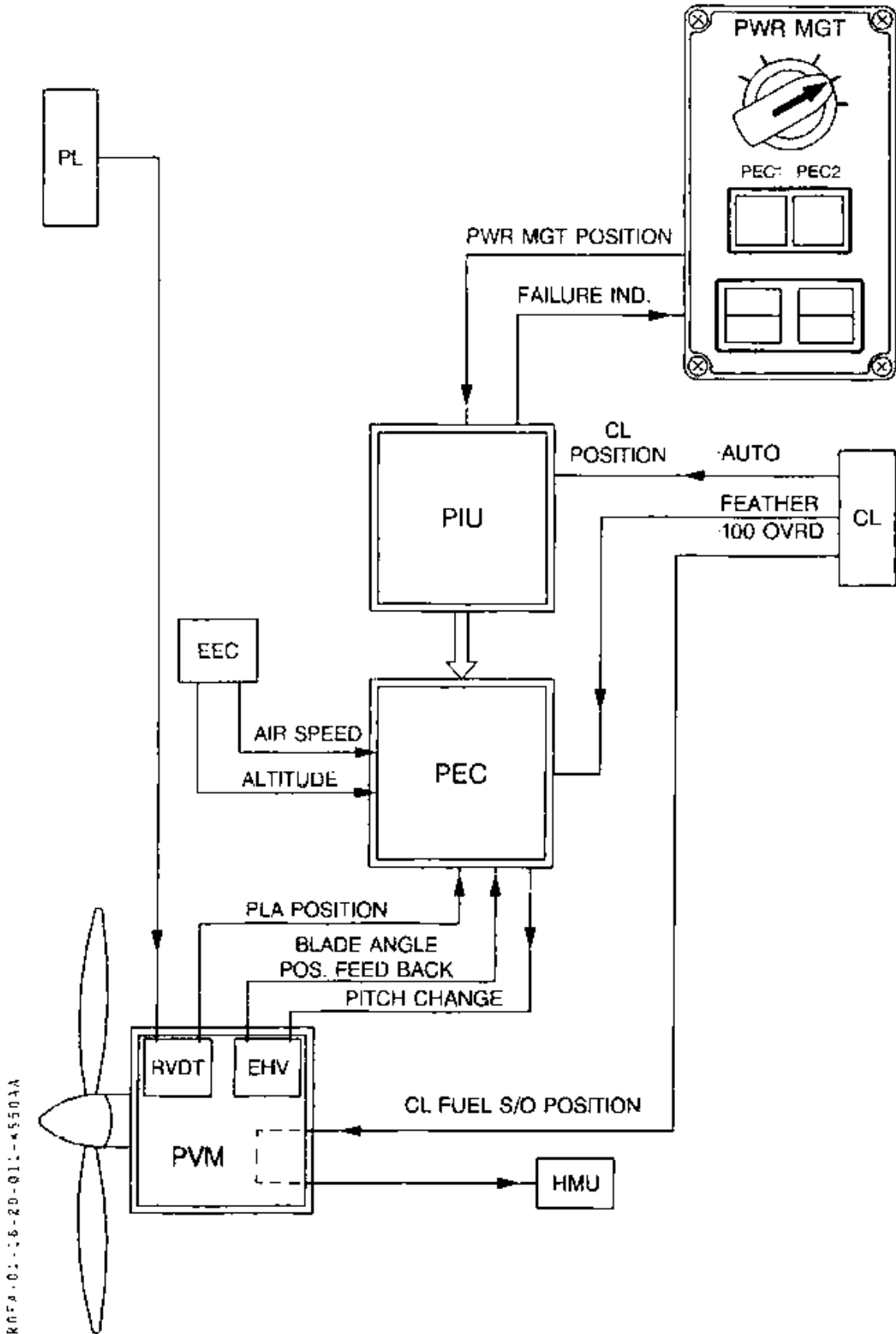

	POWER PLANT		1.16.30		
			P 1	550	
	SYSTEMS OPERATING				JUN 97

30.1 GENERAL

The power control parameter is the torque :

$$TQ = \frac{P \text{ (engine power)}}{NP}$$

The maximum torque for each flight condition, at the selected rating, is computed by the FDAU independently of the engine governing and displayed on the TQ indicator (Automatic BUG).

An engine Electronic Control (EEC) provides control of fuel flow in the HydroMechanical Unit (HMU), through a stepper motor in such a way as to control the torque in accordance with outside conditions and positions of :

- The power lever (PLA).
- The power management selector (PWR MGT).
- The bleed valves.

The HMU delivers a fuel flow which generates the NH compressor rotation speed.

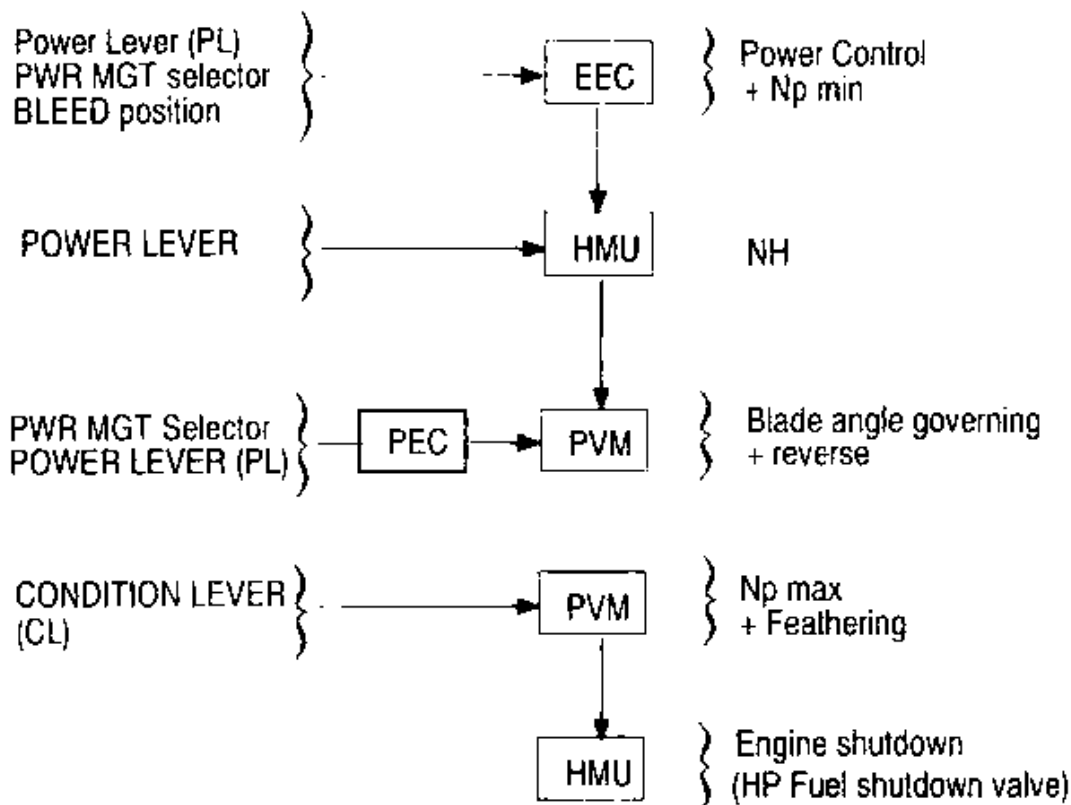

	POWER PLANT		1.16.30	
			P 2	550
	SYSTEMS OPERATING			JUL 98

AA

30.2 ENGINE GOVERNING

MAIN UNITS (HMU-EEC-PVM-PWR MGT)

HYDROMECHANICAL UNIT (HMU)

- Performs fuel metering in steady state operation and protects the system in case of transients.
- Commands a rotor speed in accordance with 2 laws ($NH = f(PLA)$) :
 - . 1 st law (called top) used when EEC is ON to protect NH overspeeds.
 - . 2 nd law (called base) used when EEC is OFF.

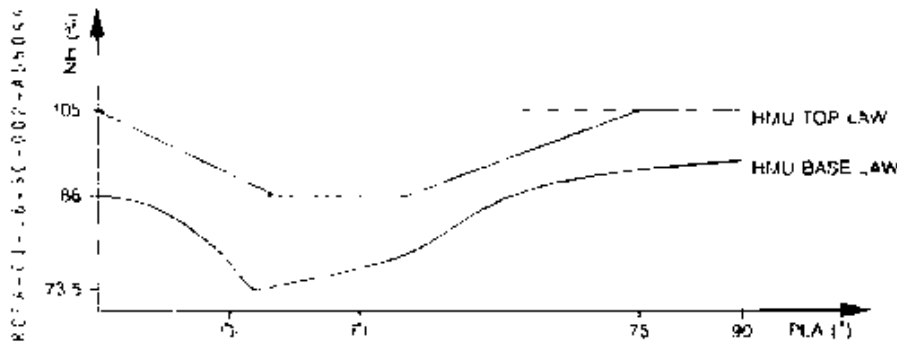

- Includes a stepper motor which adjusts the flow controlled by the hydromechanical channel, in accordance with commands transmitted by the EEC.
- Ensures engine shutdown (HP fuel S/O).
- Delivers a motive flow to the fuel tank jet pump.

ENGINE ELECTRONIC CONTROL (EEC)

- Regulates a given power, by controlling the stepper motor, to obtain a predicted torque as a function of :
 - the power lever position
 - the PWR MGT selector position
 - flight conditions
 - the position status of the bleed air valves

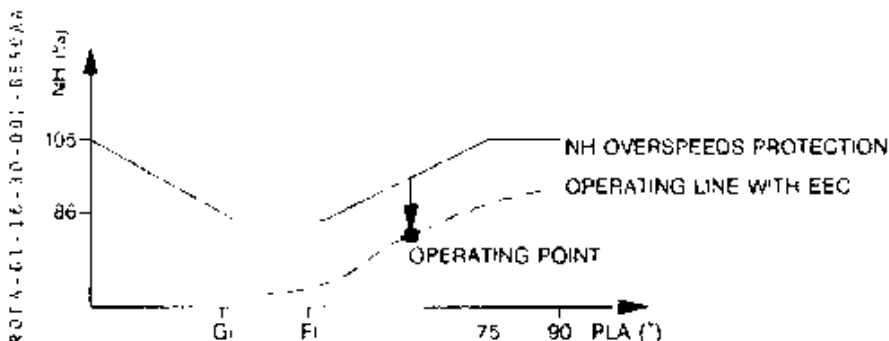

Note : Operating line with EEC ON may be placed above or below the HMU BASE LAW depending on weather conditions

R

	POWER PLANT	1.16.30	
	SYSTEMS OPERATING	P 3	550
			JUL 98

AA

R000-001-10-30-001-4500A

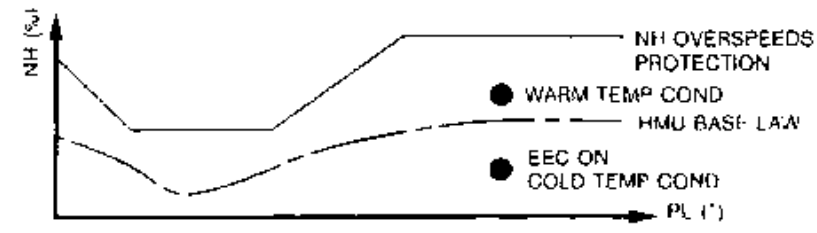

- Ensures minimum propeller speed control, on ground and at low power (see propeller governing).
- Delivers, in case of engine failure at take-off, automatic uptrimmed take-off power to the valid engine (ATPCS) by responding to the signal generated by the Auto-Feather Unit (AFU) of the failed engine.
- Controls the modulated opening of the Handling Bleed Valve (HBV), so as to ensure correct LP compressor operation.

PROPELLER VALVE MODULE (PVM)

- At high power, controls the propeller maximum speed N_p , according to the PWR MGT selection.
- Controls propeller pitch at low power and when using reverse.
- Ensures low pitch through a solenoid (when PLA are below FI position).

PWR MGT SELECTOR

- LINE A : One engine out operation
- LINE B : Normal TO or MCT
- LINE C : CLB
- LINE D : CRZ

Note : Sensible sector designed to allow fix throttle engine control.

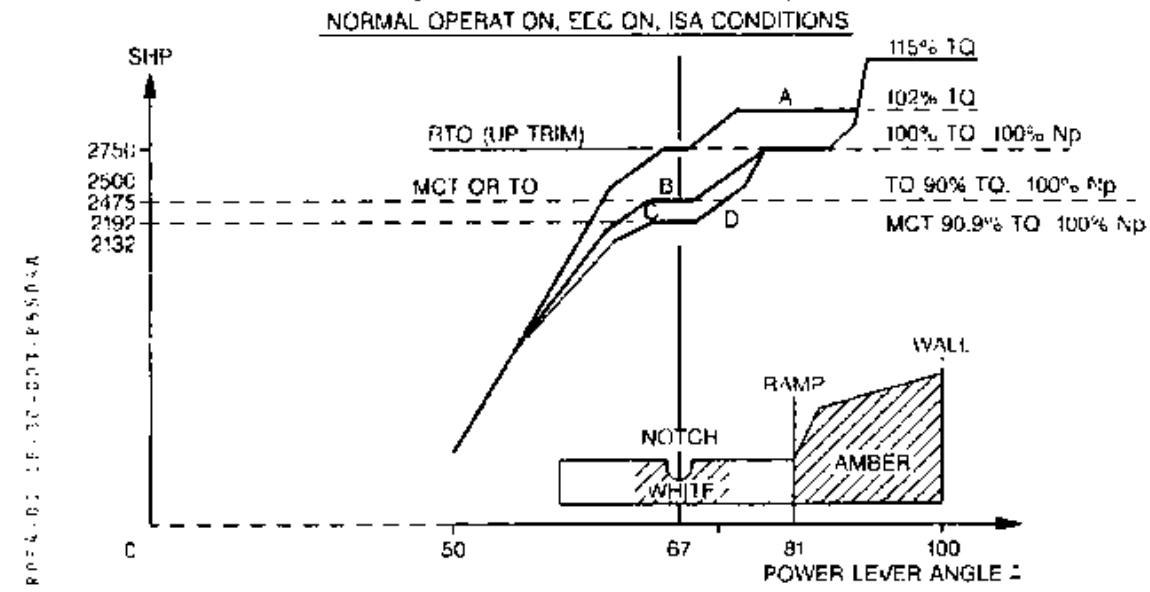

R000-001-10-30-001-4500A

 AJR72 F.C.O.M.	POWER PLANT		1.16.30	
			P 4	070
	SYSTEMS OPERATING			JUL 98

AA

ENGINE POWER CONTROL LAWS

R ① TOP LAW (EEC ON)

This is a TQ (PLA) control law, ensuring a constant power.

It is backed-up by an NH (PLA) law which becomes active :

- At low power (authority of engine torque control is gradually reduced to be cancelled out at FI),
- In case of engine torque control failure,
- In Hotel mode.

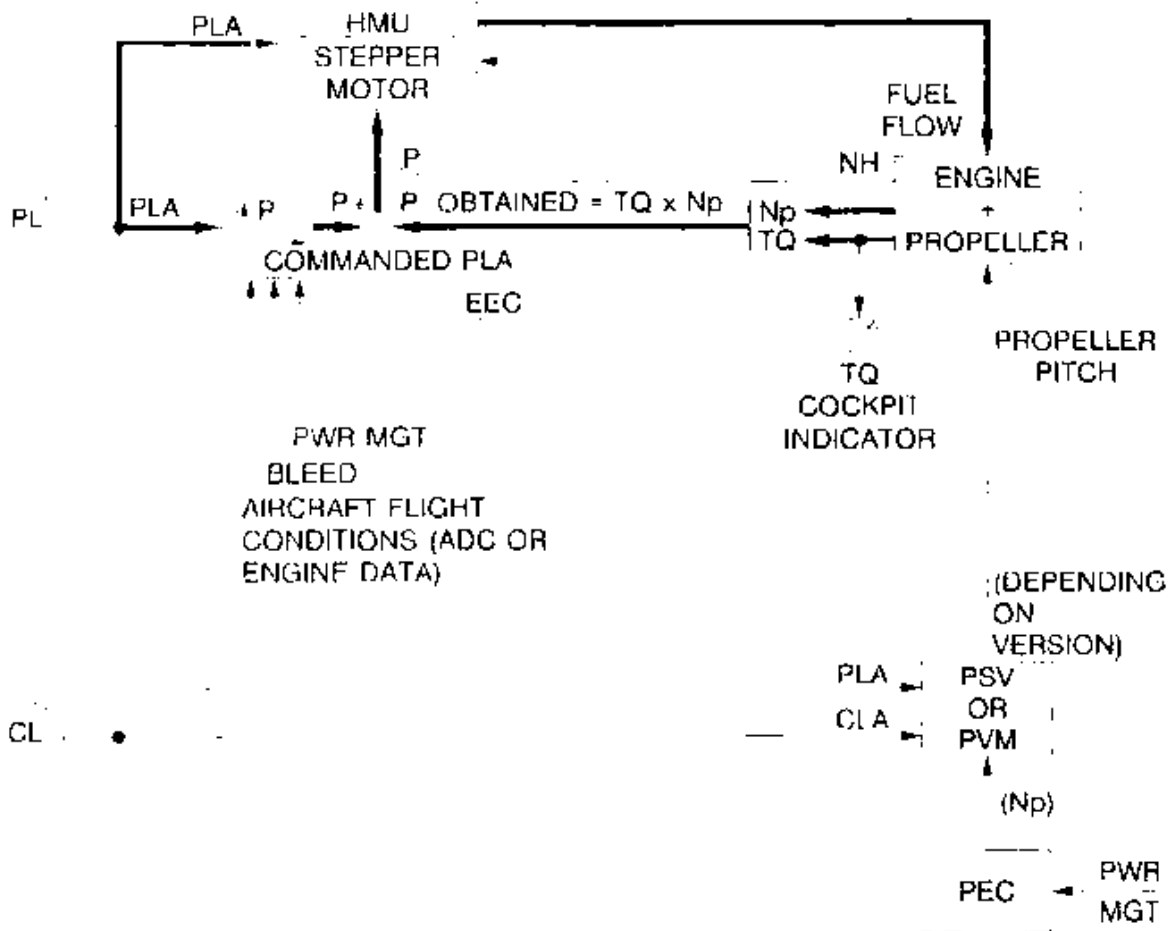

POTA 01-11-32 004 A37 3x8

According to the rating selected on the PWR MGT rotary selector, with the PL at a set point, the EEC commands a determined engine power and therefore a torque value (for a given propeller speed). Thus, the torque which is the engine control parameter, is controlled (with PLA constant) in all ambient conditions.

	POWER PLANT		1.16.30	
	SYSTEMS OPERATING		P 5	550
			JUN 97	

AA

When necessary, power is automatically reduced in such a way as to maintain the torque at the maximum value, authorized for the rating considered (thermo dynamic limit).

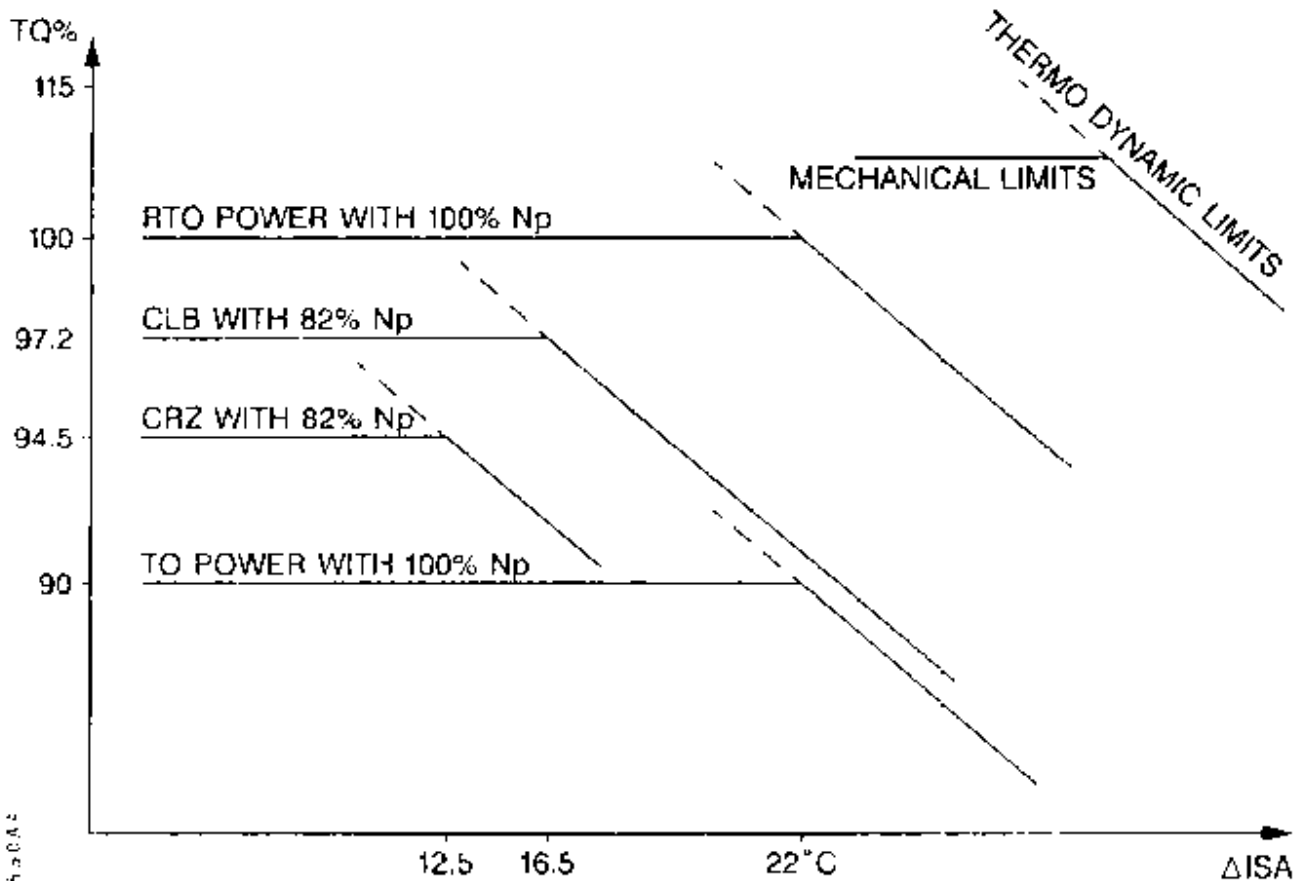

9046-01-16-30-265-450042

Example for : sea level, bleed off, static conditions.

	POWER PLANT	1.16.30		
		P 6	550	
	SYSTEMS OPERATING			JUN 97

AA

PLA quadrant has **TWO CLEARLY IDENTIFIED POSITIONS**

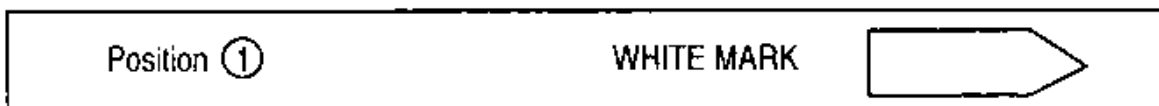

At this position marked by a notch the control system delivers max rated power corresponding to the mode selected.

- TO : P = 2475 SHP
- MCT : P = 2500 SHP
- CLB : P = 2192 SHP
- CRZ : P = 2132 SHP

ENGINE REGULATION

- Engine regulation uses pitot and static data coming from EEC. EEC data are elaborated either from the selected ADC (normal configuration) or from engine sensors and imposed data (emergency configuration).

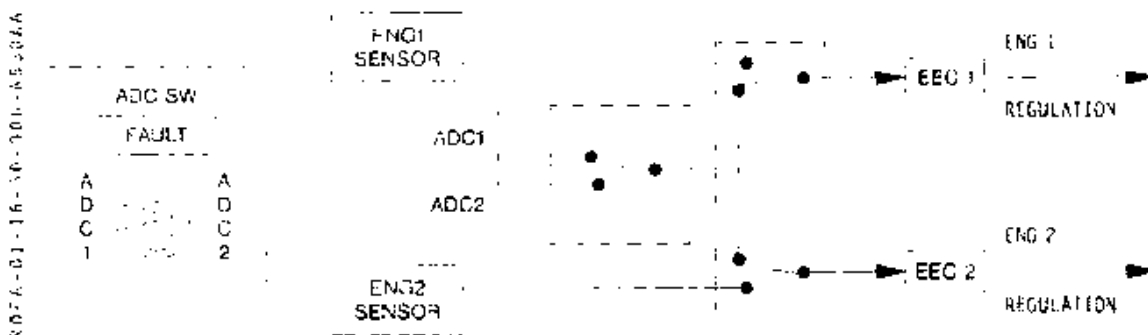

Note : If the selected ADC electrical supply fails, two events may occur :

- If ADC 2 was selected, ADC 1 immediately takes over from ADC 2 ; ADC SW FAULT light illuminates.
- If ADC 1 was selected, engine sensors immediately take over from ADC 1. ADC SW FAULT light does not illuminate.

The engine torque must match with the torque calculated by the FDAU, except when TO is selected at the PWR MGT selector.

When TO is selected at the PWR MGT selector, with the ATPCS armed :

- the torque calculated by the FDAU corresponds to RTO
- in normal T.O. configuration

PL NOTCH
PWR MGT TO
ATPCS ARMED

The FDAU BUG is positioned at RTO. This value must be crosschecked with temperature and altitude information. Manual BUG must be set at RTO - 10 % TQ position.

In the event of engine failure and automatic uptrim, the engine torque will coincide with the FDAU torque (RTO).

	POWER PLANT		1.16.30	
	SYSTEMS OPERATING		P 7	001
			DEC 96	

Example (ISA conditions)

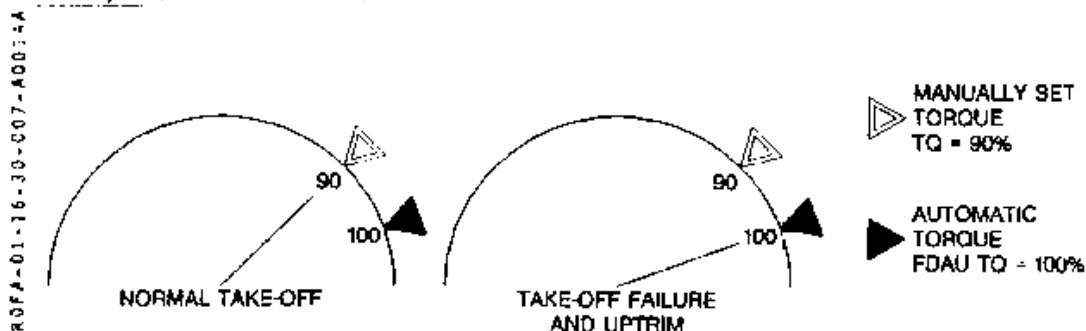

Comment

If necessary, moving the lever out of the notch will enable to set precise power setting without any discontinuity.

Position ②	beginning of AMBER SECTOR
------------	---------------------------

This position, characterized by a ramp threshold is used during GO Around or at take off in the event of ATPCS failure. The power delivered is GA (or RTO) for NP = 100%, irrespective of the mode selected on the PWR MGT rotary selector.

In this position, the engine torque agrees with the RTO torque calculated by the FDAU

Note : The ramp threshold may be overridden, thus enabling the lever to be positioned up to the stop of the PLA quadrant. This procedure must remain EXCEPTIONAL. It is AN EMERGENCY PROCEDURE WHICH WILL PROVIDE UP TO 15 % more power than RTO.

② EEC FAILURE

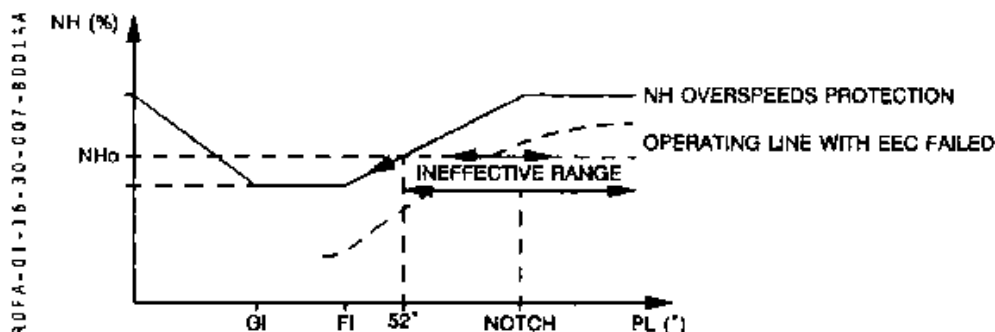

- EEC FAULT Flashes.
- NH is automatically frozen to its prior value (FAIL FIX) (PL set forward 52°)
- As long as EEC Fault is flashing deselection is strictly prohibited.
- The PL stays ineffective until PL travel reaches 52°.
- When PL reaches 52°, the reversion is automatically assured to the manual mode.
 - EEC FAULT light stays ON.
 - The pilot deselects EEC.
 - PL is active again and follows HMU base law.

	POWER PLANT	1.16.30		
		P 8	500	
	SYSTEMS OPERATING			JUN 97

AA

3 BASE LAW (EEC OFF)

The NH (function of PLA) base law is used when the EEC is deselected. (REVERSION MODE).

. Refer to the schematic p 4

EEC Deselection Sequence

- (A)** at time of EEC failure
- | | |
|-----|---------------|
| PLA | = Plo (NOTCH) |
| NH | = NHo |

NH remains fixed at NHo value until either PL travel reaches 52° or NH reaches its overspeed protection.

(B) NH changes to NH1 value (at that time a power increase or decrease can be noted, according to the operating point position prior to EEC failure with respect to HMU base law).

(C) NH follows the NH (PLA) schedule of the HMU base law.

RU A-01-16-30-003-0004A

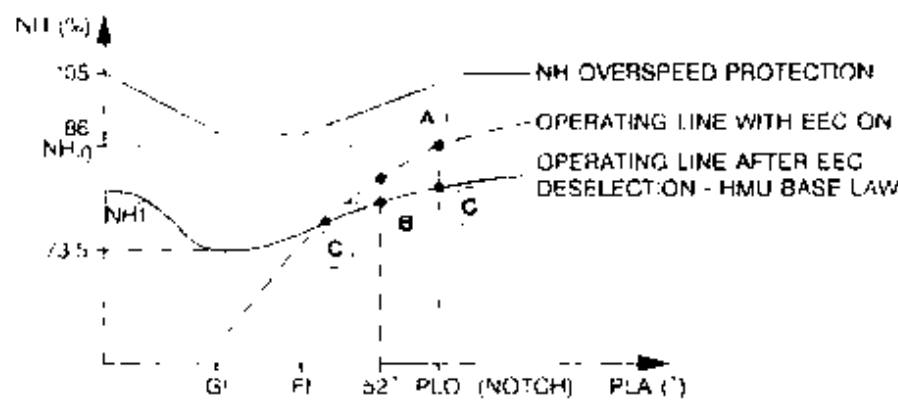

This mode of operation (REVERSION) features :

- Loss of torque regulation at constant power lever position (changes in ambient conditions will call for PLA adjustments to maintain maximum engine torque).

Note : • Loss of the EEC has no effect on the two torque indications (digital and analogic) displayed

- Handing bleed valve (HBV) is still monitored by the EEC deselected with a law function of NH instead of PLA.
- Loss of propeller underspeed control at low power (FUEL GOVERNING).

 AR72 F.C.O.M.	POWER PLANT		1.16.30		
			P 9	001	
	SYSTEMS OPERATING				DEC 96

AA

HOTEL MODE

This mode, available on the RH engine only, is exclusively used on the ground to provide aircraft autonomy in terms of air conditioning and DC power supply with the gas generator operating and the propeller locked by a hydraulic brake.

- PL is controlling the power of the generator (NH = f(PL)) since the fuel governing function of the EEC is automatically cancelled when selecting feather. A throttle stop is provided by the gust lock lever to avoid an overtorque risk. Without this protection, hotel mode cannot be selected.
- CL has to be set to feather prior to selecting hotel mode and must be left in this position. Hotel mode can be used with EEC ON or OFF. The gust lock stop precludes overpowering the engine.

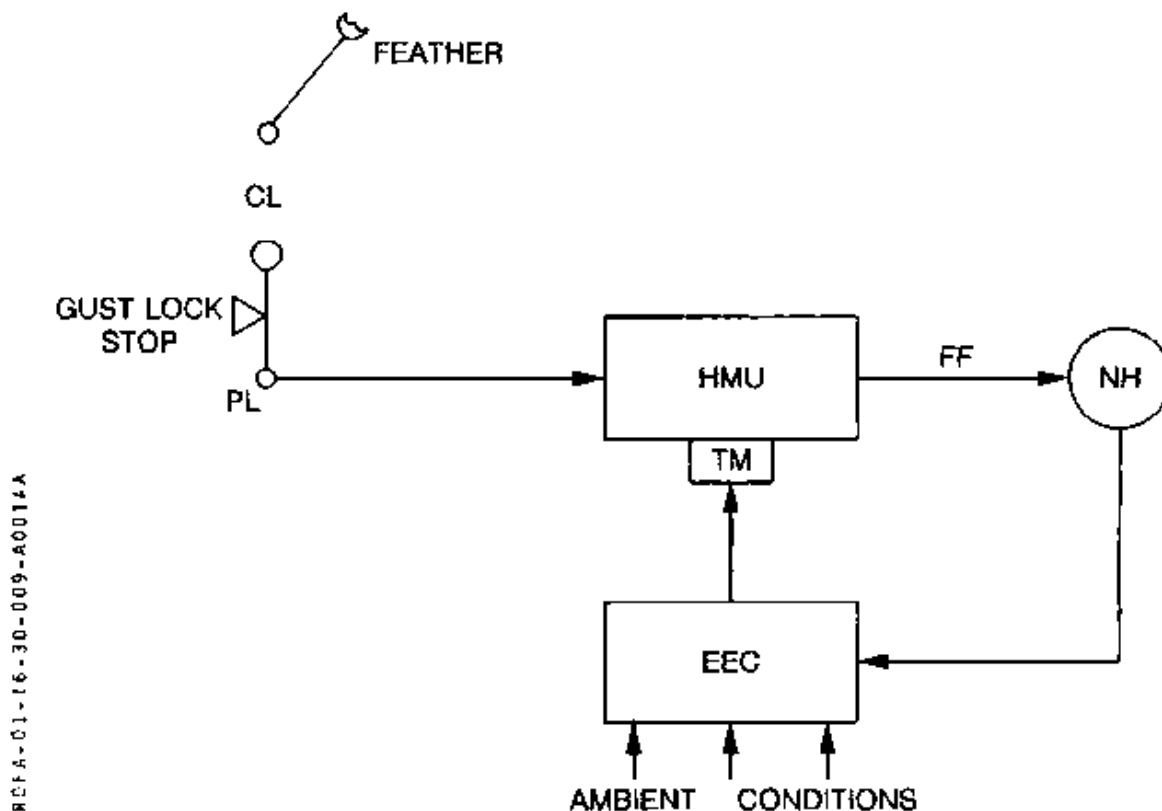

	POWER PLANT	1.16.30		
		P 10	550	
	SYSTEMS OPERATING			JUN 97

AA

30.3 PROPELLER SPEED GOVERNING

BLADE ANGLE GOVERNING

This is the normal in flight governing mode.

The PVM adjusts the propeller pitch according to the power setting in such a way as to maintain a constant propeller speed N_p .

This governing is available whether EEC is ON or OFF.

PWR MGT selector commands N_p propeller speed (through the PEC)

PL commands power (and therefore TQ, at a given N_p)

FUEL GOVERNING

This is the ground governing mode at low speed and low power.

The EEC automatically increases the fuel flow so as to maintain a minimum propeller speed ($N_p = 70.8\%$)

CL is set in AUTO position.

Note : This control mode is cancelled :

- when EEC is OFF,
- when the propeller is in FEATHER position.

TRANSITION MODE

This is the intermediate mode between the two previous ones.

It only applies on ground, or in flight at low power and low speed.

The N_p speed is comprised between 70.8% and N_p selected.

- Control operation may be summarized through the graph below, depicting evolution of the propeller speed N_p function of PLA (example given in MCT mode).

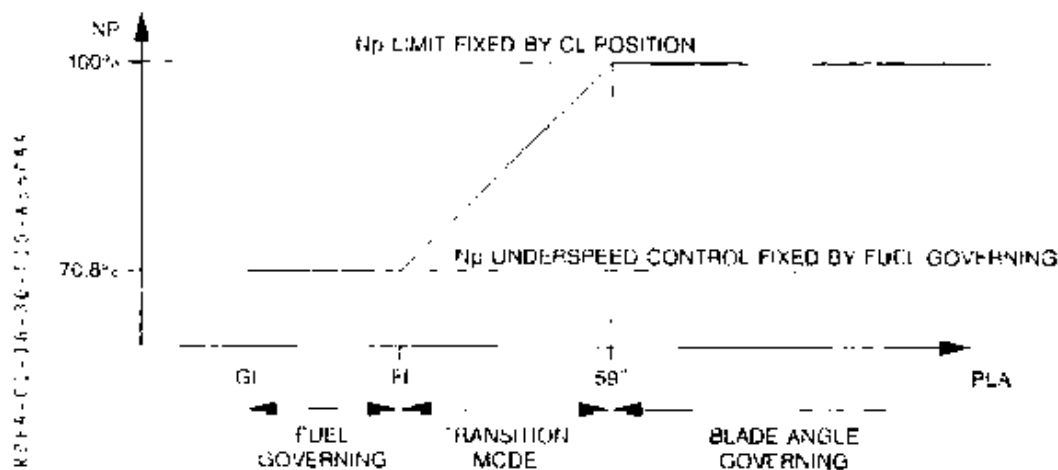

R214-C1-16-30-110-A-5746

	POWER PLANT		1.16.40	
			P 1	550
	CONTROLS			JUN 97

AA

40.1 ATPCS

GENERAL

The propulsion unit includes an ATPCS (automatic take-off power control system) which provides in case of an engine failure during take-off the uptrimmed take-off power on the remaining engine combined with an automatic feathering of the failed engine.

This system enables to reduce the power normally used for take-off by an amount of about 10% below the power certified by the engine manufacturer. This is favorable to engine/propeller life without affecting the take-off performance in case of an engine failure.

Full ATPCS (i.e. uptrim and autofeather) is only available for take-off (see arming conditions below).

COMPONENTS

The ATPCS operates with the following components on each engine :

- * The Auto Feathering Unit (AFU) which is the main system element. It conditions the torque signal coming from the engine and provides the torque indication :
 - to the cockpit indicators (needles only),
 - to the FDAU,
 - to the MFC which includes the autofeathering/uptrim logic functions, and delivers the corresponding control signals to the feather solenoid, to the feathering electrical pump and to the opposite EEC.
- * The EEC which transmits a signal enabling the power to increase from TO to RTO (or a Δ NH signal during ATPCS test at ground idle).
- * The feather solenoid mounted on the PVM,
- * The feathering electric pump installed on the reduction gear box.

In the Cockpit :

- * The ATPCS pb on the cockpit center panel,
- * The PL position (sw set to 49°),
- * A test selector located on the pedestal.

ARMING CONDITIONS

PWR MGT selector TO
 ATPCS pb ON
 Both PL above 49°
 Both torques above 46%
 Aircraft on ground

PWR MGT selector TO
 ATPCS pb ON
 Both PL above 49°
 Both torques above 46%
 Aircraft in flight

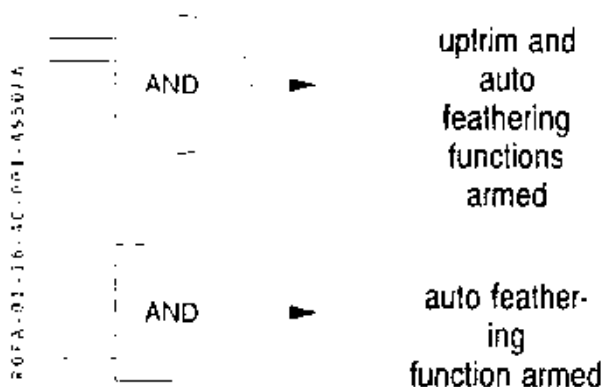

	POWER PLANT		1.16.40	
			P 2	500
	CONTROLS			DEC 97

TRIGGERING CONDITIONS

One torque below 18%

SEQUENCE AFTER TRIGGER

	Time	Trigger	2.15 s	t
R R	ATPCS	▼	▼	▶
	ARMED ON GROUND	uptrim is triggered and bleed valve is shut off on the remaining engine	autofeather is activated on the affected engine	
			<div style="border: 1px solid black; padding: 5px; width: fit-content; margin: 0 auto;"> <ul style="list-style-type: none"> - feather solenoid activated - feathering electric pump energized - inhibition of autofeather on the remaining engine - ARM light extinguishes </div>	
	ARMED IN FLIGHT		autofeather is activated on the affected engine	

Note : Nothing happens on the affected engine for 2.15 seconds, but uptrim is energized on the remaining engine. This feature enables to perform an acceleration stop without having autofeather in order to benefit from some reversing action on the failed engine.
In this case, the throttle reduction occurring within 2.15 seconds period automatically disarms the mode.

Once the mode has been triggered, its cancellation can only result from either :

- PWR MGT other than TO, or
- ATPCS Pb set to OFF, or
- both PL retarded.

CAUTION : If the engine is restarted, IT WILL BE NECESSARY TO SELECT PWR MGT to MCT position after relight in order to be able to UNFEATHER the propeller.

	POWER PLANT	1.16.40		
		P 3	500	
	CONTROLS			JUN 97

AA

ATPCS SEQUENCE

armed on ground

NORMAL TAKE OFF
WITH ATPCS ARMED

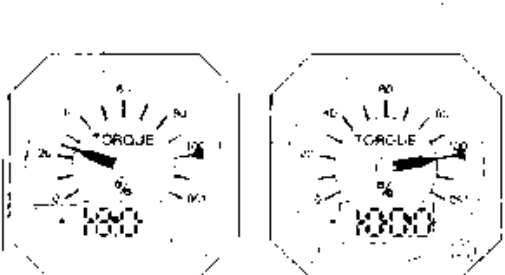
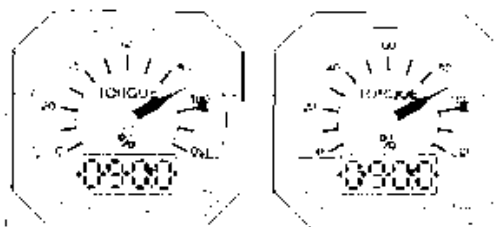
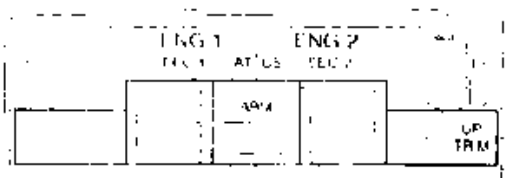
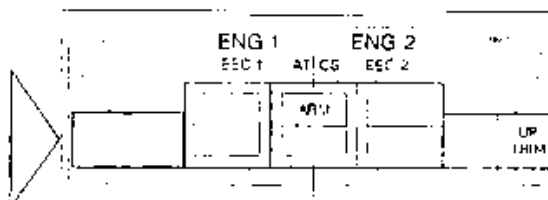

LEFT ENGINE FAILURE:
UPTRIM ON RIGHT ENGINE

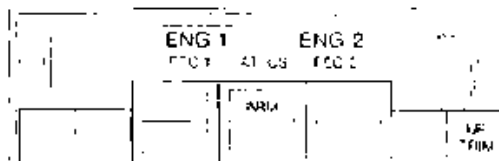

AFTER 2.15 S:
LEFT ENGINE FEATHERED
UPTRIM MAINTAINED ON RIGHT
ENGINE ATPCS ARM LIGHT
EXTINGUISHES



P3FA-01-10-97-003-00000000

A/FEATH FUNCTION

Disarming conditions

PWR MGT SELECTOR OTHER THAN TO ---
ATPCS PR OFF ---
AT LEAST ONE PL RETARDED BELOW 49° ---
BOTH TORQUES BELOW 46% ---
AUTOFEATHER SIGNAL TRIGGERED ON ONE ENGINE ---

OR

A/FEATH
ARM
EXTINGUISHED

P3FA-01-10-97-003-00000000

Note: During a normal flight (without engine failure) uptrim/autofeather will be disarmed after take-off when leaving the TO position on PWR MGT.

	POWER PLANT		1.16.40		
			P 4	550	
	CONTROLS				JUN 97

AA

40.2 POWER LEVERS (PL)

PL is mechanically connected to the HMU and to the PVM through cables and rods. This lever controls the power plant thrust from Max rated TQ to max reverse.

CAUTION : in case of engine failure, the PL remains active controlling the pitch angle, and therefore associated propeller drag as long as propeller is not feathered.

KC-1061-1-6-00-000-055000

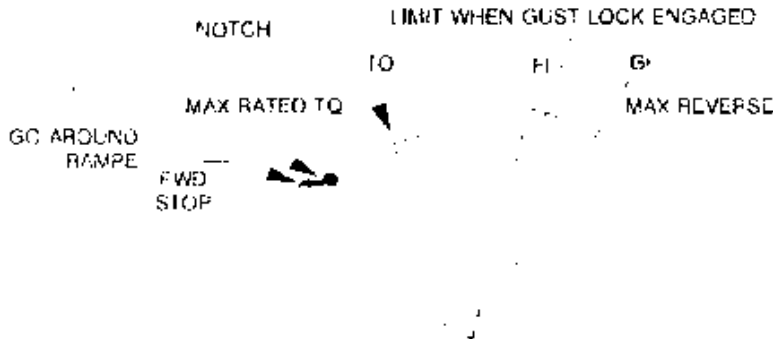

For take off acceleration the pilot will push PL's from GI to the TO position which is identified by a notch.

At landing, the pilot will reduce PL's to FL. Then after flight idle gate automatic unlocking, he will act on the triggers to reduce down to GI, and eventually to reverse. Reverse sector is "protected" by a spring rod : a force must be exercised by the pilot to position the PL into reverse sector. Releasing this pull force will bring PL back to around GI.

When the PL are on the MAX RATED TQ position, the pilot can increase the power (if necessary) by pushing the PL up the RAMP (after GO AROUND position) to the FWD stop.

Note : On the ground, the gust lock, when engaged, prevents excessive PL in the forward traction sector angle.

POWER LEVER SWITCHES

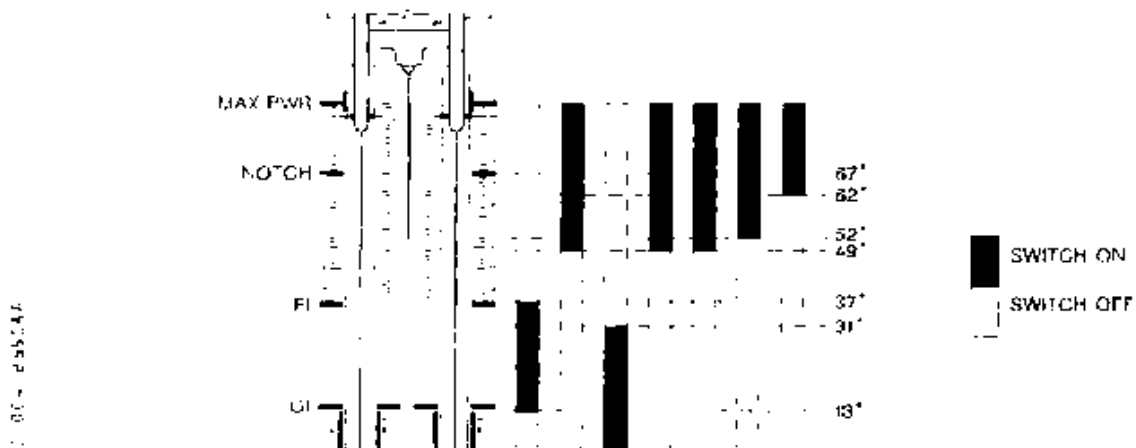

- HP BIFED VALVE OPERATING CTL
- LANDING GEAR NOT DOWN WARNING
- LOW PITCH STOP RETRACTION
- PROP 1 FEATHERING SYSTEM ARM
- PROP 2 FEATHERING SYSTEM ARM
- HMU MANUAL MODE AUTO CONTROL WITH FAIL
- IGC % NP CONTROL (PWR MGI ON TO POSITION)

KOEK 00116-00 000 055000

	POWER PLANT	1.16.40		
		P 5	001	
	CONTROLS			DEC 96

AA

40.3 IDLE GATE

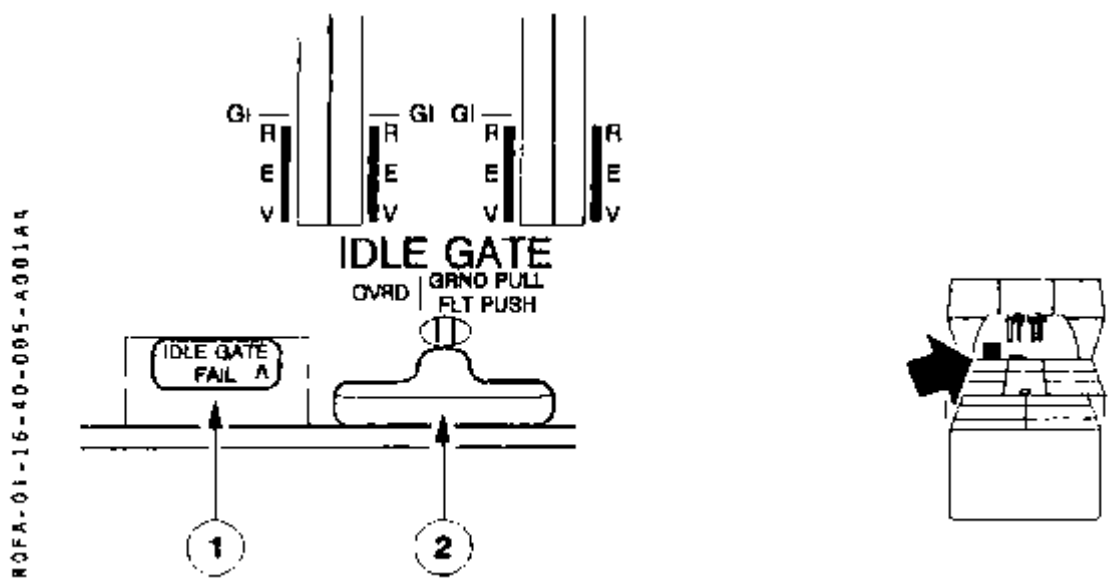

At take-off, as soon as both landing gear absorbers are released, a gate prevents PL angle reduction below Fi.

At landing, as soon as one landing gear absorber is compressed, this gate is automatically retracted and the PL may travel down to GI and reverse (below GI).

- ① IDLE GATE FAIL light
Illuminates amber and the CCAS is activated when the gate does not engage automatically in flight or does not retract automatically at landing.
- ② IDLE GATE lever
Enables manual override in case of failure of the automatic logic.
In flight : push
On ground : pull. An amber band appears.

	POWER PLANT		1.16.40	
			P 6	550
	CONTROLS			JUN 97

AA

40.4 CONDITION LEVERS (CL)

They operate feathering control, HP fuel shut off valves and propellers speed (NP), controlled by PVM when in blade angle governing propulsion mode.

RFA-91-14-47 CDB 55527A

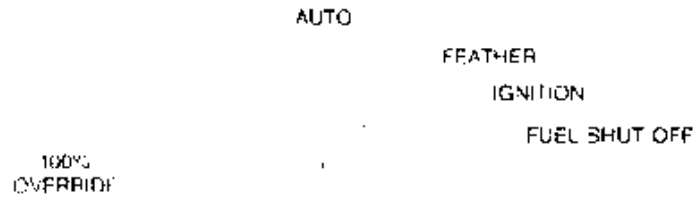

- AUTO position controls propeller speed through PWR MGT selector position.
- 100 % OVRD position sets manually Np MAX.

It is necessary to act on a trigger located on the lever side to travel

- from AUTO to FTR (and return),
- from FTR to FUEL SO (and return).

A red light incorporated in the lever will illuminate if a fire is detected on the associated engine provided CL is not in FUEL SO position.

CONDITION LEVER SWITCHES

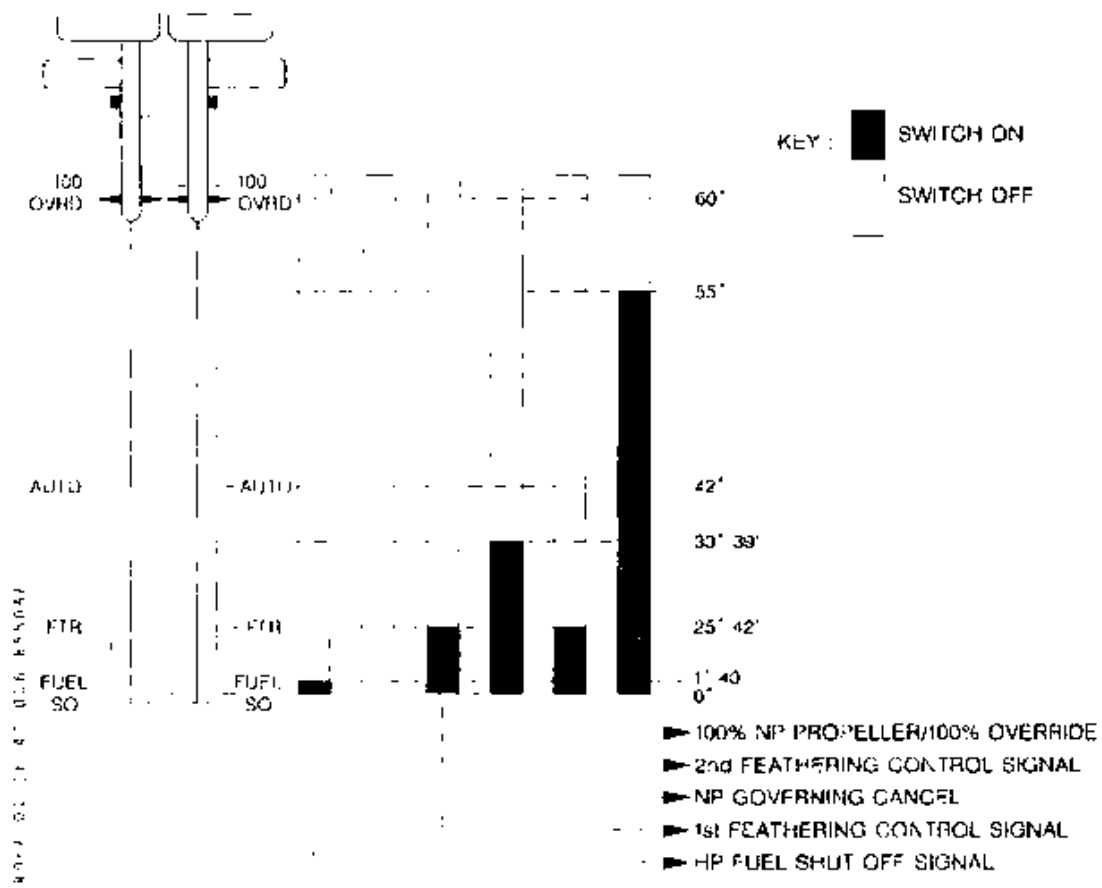

RFA-91-14-47 CDB 55527A

	POWER PLANT	1.16.40		
		P 7	500	
	CONTROLS			JUN 97

40.5 INDICATORS & CONTROL PANELS

TORQUE IND

P015-0 - (A) 10-007-439-2A4

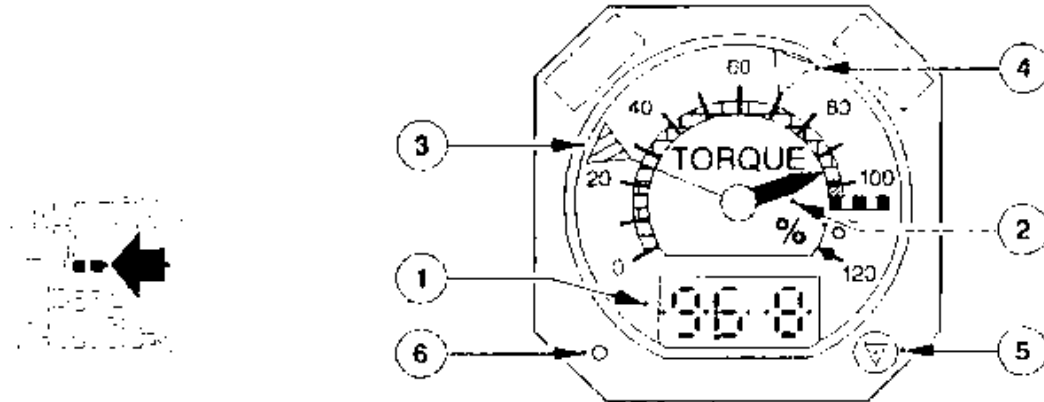

Two sensing torque probes are located on the reduction gear box. One of them sends a signal to the AFU which supplies the analogic torque ind. (pointer). The other one sends a signal to the EEC which supplies the electronic torque ind. (digital counter).

① Digital counter

Actual torque is displayed.

If "000" is displayed, torque sensor is failed.

If "---" is displayed, EEC cannot control the HBV which is then closed.

If "LAB" is displayed, a wrong EEC is installed.

② Pointer

Actual torque is displayed.

Green sector : 0-100%

Red mark : 100%

Amber sector : 100-106%

Red dashed radial : 106.3% - Red dot : 120%

③ FDAU target

Displays the maximum torque value computed by the FDAU depending on the PWR MGT selection (except on the T.O. position where reserve T.O. torque is displayed.)

Note : In case of FDAU target failure associated with a pointer malfunctioning, an AFU failure may be suspected (see page 1).

④ Manual target

Controlled by the knob 5, displays a manually selected torque target.

⑤ Knob

Enables setting of target bug 4.

⑥ Test pb

Allows to test the ind. During test, both counter and pointer will display 115%.

Note : A blue dot is provided on the ind. scale to identify 115%.

	POWER PLANT	1.16.40		
		P 8	500	
	CONTROLS			JUN 97

NP IND

MOT-03-1-00-005-250042

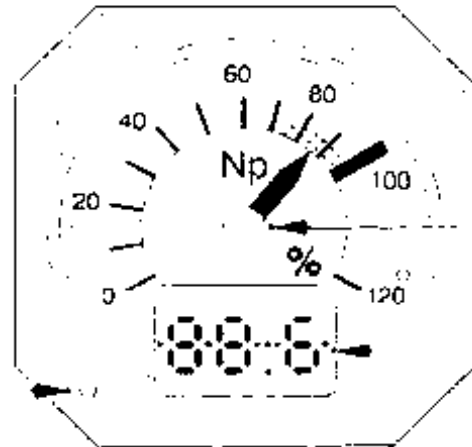

- ① Digital counter
Actual NP is displayed.
- ② Pointer
Actual NP is displayed.
Amber sector : 41.6-65%
Green sector : 70.8-100%
Red mark : 100%
Red dot : 120%
- ③ Test pb
Allows to test the ind. During test, both counter and pointer will display 115%.
Note : A blue dot is provided on the ind. scale to identify 115%.

AA

ITT IND

ROFA-01-16-40-009-AD01AA

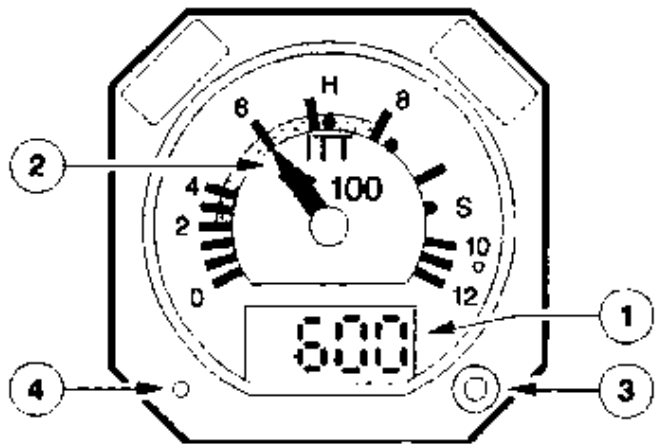
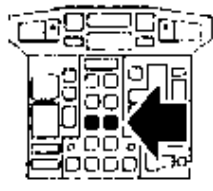

- ① Digital counter
Actual ITT (T6) is displayed.
- R ② Pointer
Actual ITT is displayed.
 - Green sector : 300-765°C
 - Red point + H : 715°C (Hotel mode)
 - Amber sector : 765-800°C
 - Red mark : 765°C (Temperature limit during normal take-off to be checked in chapter 2.01)
 - White/red mark : 800°C (Temperature limit in uptrim conditions)
 - Red point : 840°C (Temperature limit for 20 sec)
 - Red point + S : 950°C (Temperature limit for 5 sec for start)
- ③ Alert It
Illuminates amber and the CCAS is activated when ITT > 800°C or 715°C in hotel mode.
- ④ Test pb
Allows to test the ind. During test, both counter and pointer will display 1150°C.
Note : A blue dot is provided on the ind. scale to identify 1150°C.

	POWER PLANT	1.16.40		
		P 10	500	
	CONTROLS			JUN 97

NH/NL IND



RCFA 01-16-10-010-ADUAAA



- ① Digital counter
Actual NH is displayed.
- ② Pointer
Actual NH is displayed.
Green sector : 62-102.7%
Red mark : 102.7%
- ③ Pointer
Actual NL is displayed.
Green sector : 62-104.2%
Red mark : 104.2%
- ④ Test pb
Allows to test the ind. During test, both counter and pointer will display 115%.
Note : A blue dot is provided on the ind. scale to identify 115%.

OIL IND



RCFA 01-16-10-010-3500AA

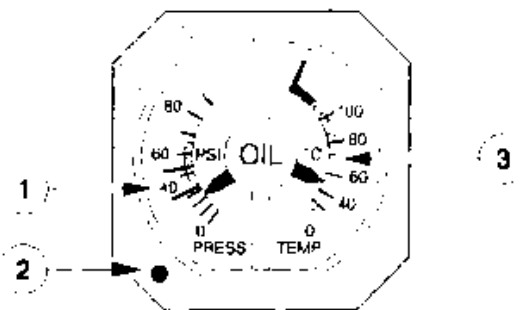

- ① OIL PRESS indication
Actual oil pressure is displayed.
Green sector : 55-65 PSI
Amber sector : 40-55 PSI
Red mark : 40 PSI
Dashed white/red radial at 55 PSI
- ② OIL LOW PRESS II
Illuminates red when OIL PRESS indication drops below 40 PSI. A separate pressure switch activates the CCAS at 40 PSI.
- ③ OIL TEMP indication
Actual oil temperature is displayed.
Green sector : 45-125°C
Amber sector : 125-140°C and below 0°C
Red mark : 140°C

	POWER PLANT	1.16.40		
		P 11	060	
	CONTROLS			DEC 96

FF/FU IND

ROFA-01-16-40-011-AC60AA

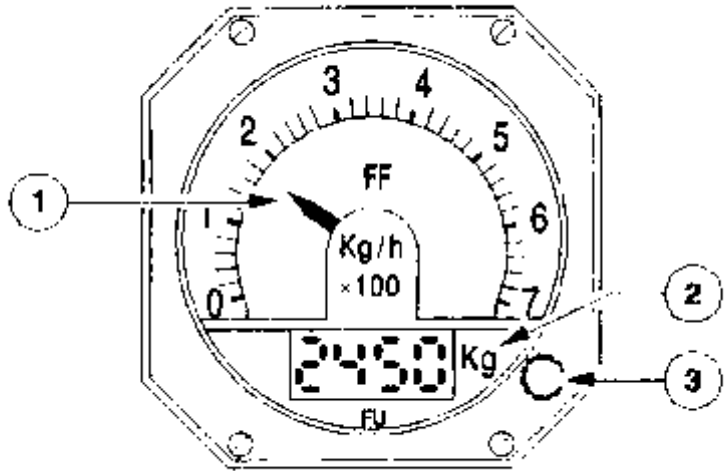

See chapter 1.11.10.

FUEL TEMP IND

ROFA-01-16-40-011-B060AA

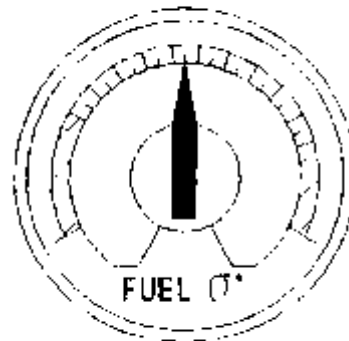
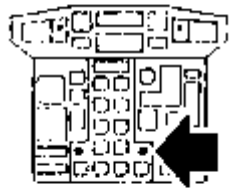

See chapter 1.11.10.

FUEL CLOG LIGHT



See chapter 1.11.10.

	POWER PLANT		1.16.40	
			P 12	001
	CONTROLS		JUL 98	

AA

ENG 1/ENG 2 CONTROL PANEL

ROFA-01-16-40-012-A001AA

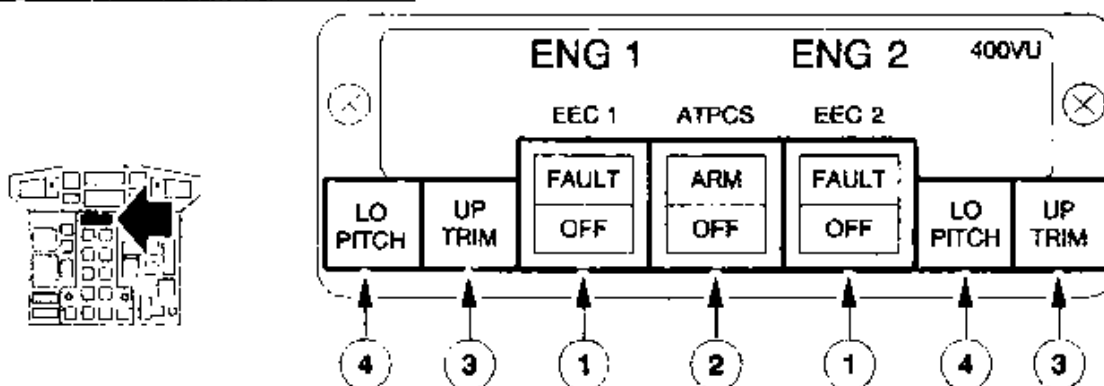

① EEC pb

Controls the EEC of the associated engine

ON : (pb pressed in) EEC adjusts HMU action, by controlling the stepper motor which lowers fuel flow ordered by HMU.

OFF : (pb released) The HMU controls only NH as a function of PL angle. OFF it illuminates white.

FAULT : Illuminates amber and the CCAS is activated when an EEC failure is detected. Power is locked at its pre-failure value.

Reversion to HMU base law is achieved by deselection of failed EEC. (See 1.16.30).

② ATPCS pb

pb pressed in : - If pressed in on ground, uptrim and autofeather function are preselected

- if pressed in in flight, only the autofeather function is preselected.

OFF : (Pb released)

Uptrim and autofeather functions are deselected.

R ARM : Illuminates green when arming conditions are met (see P1)

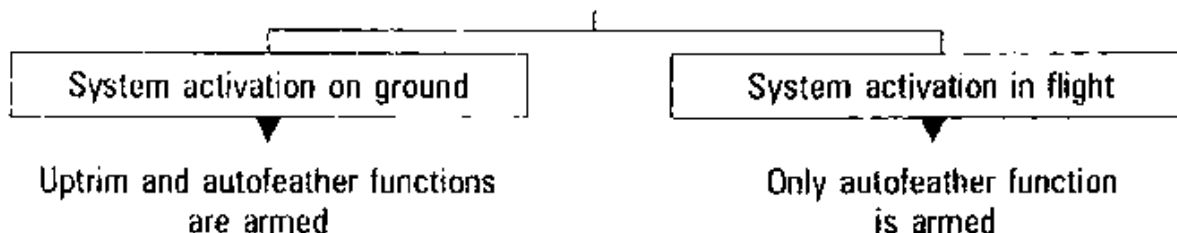

③ UP TRIM light

Illuminates green when the uptrim signal is sent to the associated engine at the beginning of ATPCS sequence.

④ LO PITCH light

Illuminates amber when the actual blade angle is lower than the normal Ft blade angle. This light is illuminated during all ground operation below Ft. The CCAS is activated in flight only.

	POWER PLANT		1.16.40		
			P 13	400	
	CONTROLS				JUL 01

AA

ENG START PANEL

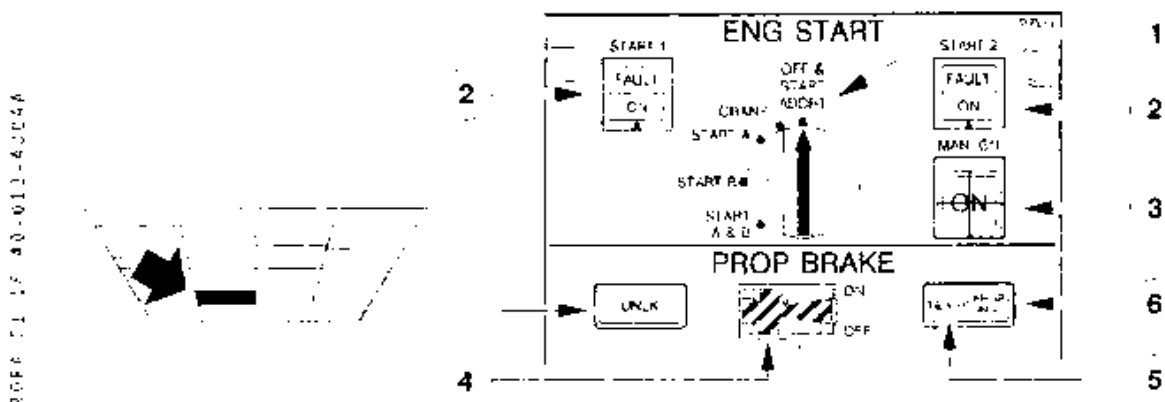

① ENG START rotary selector

Selects the ignition mode and/or start sequences.

OFF START ABORT Ignition circuit is deenergized. Starting sequence is disarmed or interrupted.

CRANK Enables engine cranking. Ignition is inhibited.

START Selects a start sequence. Ignition is selected when fuel shut-off valve is open (controlled by CL) ; starter and ignition are automatically deactivated when NH reaches 45%.

Note : There are three START positions.

START A Only ignition exciter A is supplied on ground.

START B Only ignition exciter B is supplied on ground.

START A and B Both ignition exciters are supplied.

② START pb

Initiates the starting (or cranking) sequence of the related engine provided the ENG START selector is in one of the START positions (or CRANK).

ON (pb pressed in) Initiates a sequence. The ON light illuminates white. In case of starting, it will extinguish automatically when NH reaches 45% which "identifies" sequence end.

FAULT Illuminates amber and the CCAS is activated if :

- starter remains engaged after 45%

- GCU fails during starting

R - on RH engine when the propeller brake is ON but the gust lock is not engaged.

Note : As soon as one engine is running and the associated DC GEN is connected to the main DC electrical network, the other engine start is accomplished as a "cross start" : initiated on Main Bat supply only, the start is assisted by the opposite DC GEN from 10% NH (on ground only).

If the DC GEN is connected to the network, but the cross start does not operate normally, the amber "X START FAULT" light illuminates on the main electrical panel.

	POWER PLANT	1.16.40		
		P 14	050	
	CONTROLS			DEC 96

③ MAN IGN guarded pb

Manual ignition is selected by depressing the guarded pb. Exciters are continuously energized on both engines. ON light illuminates blue.

④ PROP BRK pb

The PROP BRK two positions toggle switch controls the propeller brake engagement/disengagement on the RH engine provided blue hydraulic power is available.

ON : propeller brake engagement

OFF : propeller brake releasing

UNLK : The Lt illuminates red and after 15 s the CCAS is triggered to indicate that the propeller brake is not locked in the fully locked or the fully released position.

⑤ READY Lt

The Lt illuminates green when engagement or disengagement conditions are met.

⑥ PROP BRK Lt

- Illuminates blue when the propeller brake is fully locked
- Extinguished when the propeller brake is not fully locked.

Note : Same conditions as memo panel's PROP BRK Lt.

	POWER PLANT	1.16.40		
		P 15	550	
	CONTROLS			JUN 97

AA

PWR MGT PANEL

KPC-7-01-1-6-40-011-055-0A6

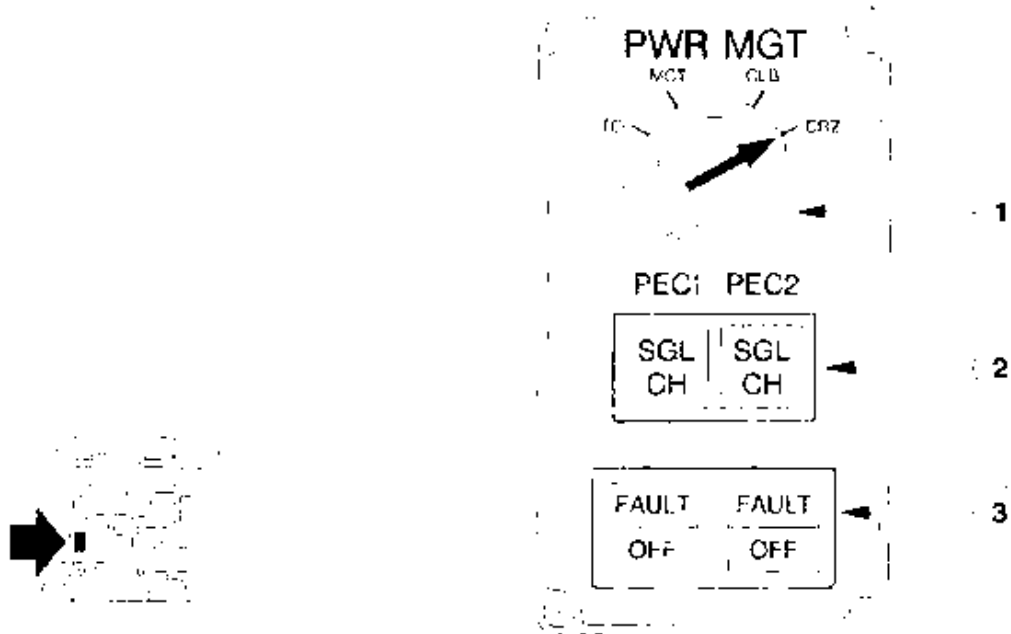

① PWR MGT rotary selector

Made up of two independent parts (front and back). Provides FDAU, PIU and EEC with basic power requirements corresponding to the selected position.

- For left engine with the back part of the selector.
- For right engine with the front part of the selector.

② PEC "SGL CH" lts

SGL CH It illuminates amber when one channel of propeller electronic control is lost. The system will automatically be transferred to the other channel.

Note : *On ground, at each propeller unfeathering, LO PITCH protection is tested by the PEC and the back-up channel is used during 2 sec. SGL CH illuminates during unfeathering then extinguishes. Therefore, the correct working of back-up channel is confirmed.*

③ PEC FAULT pbs

FAULT Illuminates amber and CCAS is activated when the two channels are lost. The failure will be indicated on the FDEP.

OFF (pb released) PEC is deactivated and Np is blocked at 102% whenever power is sufficient.

 A320 F.C.O.M.	POWER PLANT	1.16.40		
		P 16	050	
	CONTROLS			DEC 96

X START FAULT LIGHT

Illuminates to indicate that, although the opposite DC gen is connected to the network, the cross start sequence has failed.

IGN / PROP BRK LIGHT

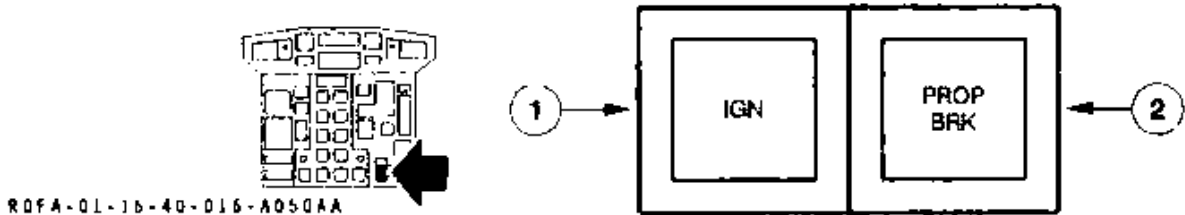

① IGN light

Illuminates blue to remind the crew that the exciters are energized.

Note : When MAN IGN is selected ON, IGN illuminates blue only when the CLs are out of FUEL SO position.

② PROP BRK light

Illuminates blue to remind the crew that the PROP BRK pb is selected ON and the mechanical lock is engaged (ON light is also illuminated on the overhead panel).

ENG TEST PANEL

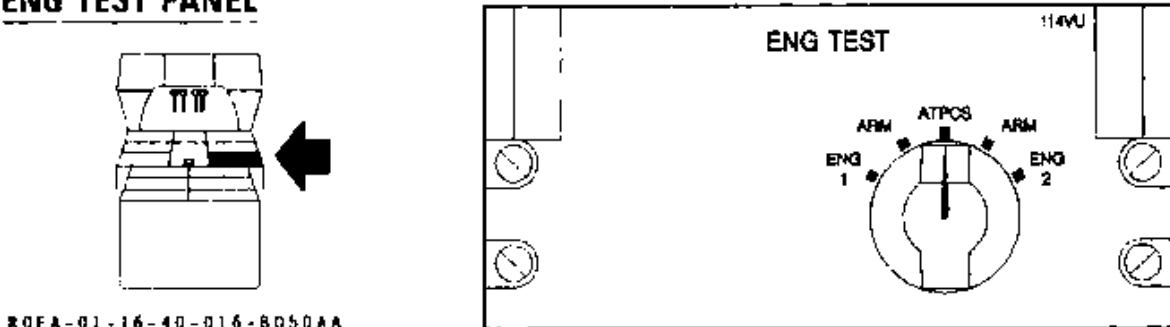

ROFA-01-16-40-016-8050AA

Allows to check the correct functioning of the ATPCS.

This rotary selector is spring loaded to the neutral position.

ADC SW

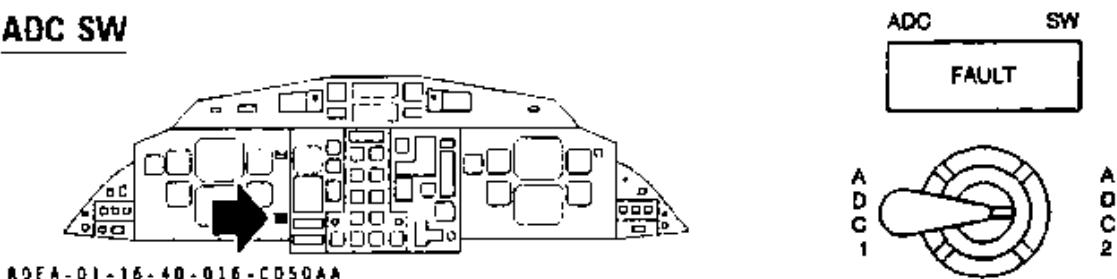

ROFA-01-16-40-016-C050AA

- ADC 1 : ADC 1 data are fed to both EEC and FDAU : To be used odd days.
- ADC 2 : ADC 2 data are fed to both EEC and FDAU : To be used even days.
- FAULT : illuminates amber, indicates a mismatch between switch position and ADC selected.

 AIR 72 F.C.O.M.	POWER PLANT		1.16.50	
	LATERAL MAINTENANCE PANEL		P 1	550
			DEC 97	

AA

On RH Maintenance panel, several tests and control device are provided, for maintenance purpose only.

All buttons on this panel are to be used on ground only.

R07A-01-16-50-00-1-4550AA

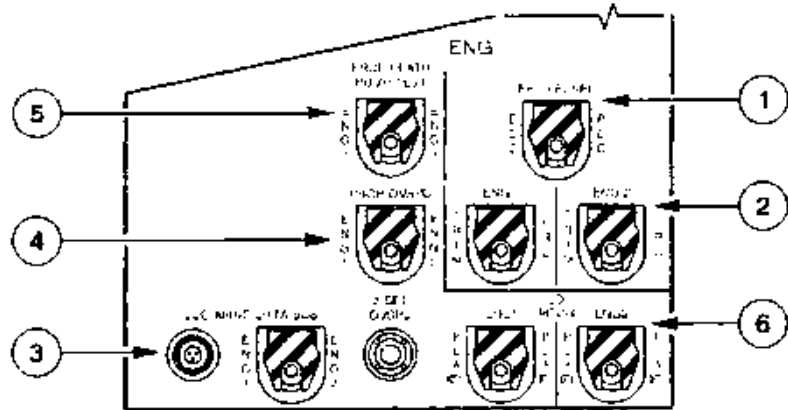
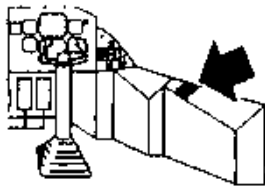

① EEC/PEC SEL switch



R07A-01-16-50-00-1-4550AA

Used to select EEC or PEC depending on appropriate maintenance test on Engine TRIM switches or LRU (line replaceable unit) code failures.

② Engine TRIM test and LRU switches

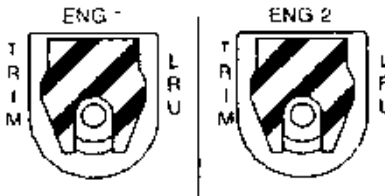

R07A-01-16-50-00-1-4550AA

Switch with two stable positions used to :

- Test EEC or PEC channel. Maintenance data appear on the FDEP. (Selected by EEC/PEC SEL switch).
- Perform EEC or PEC trim to ensure that power delivered corresponds to PL position (can be performed with engine not running and PL in the notch) or LRU code failures.

③ BUS ARINC switches

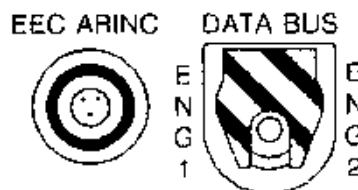

R07A-01-16-50-00-1-4550AA

Bus arinc function is tested.

	POWER PLANT LATERAL MAINTENANCE PANEL	1.16.50		
		P 2	550	
				JUN 97

AA

④ Prop Overspeed test switches

2144-0-1-16-50-0-2-1-100-0

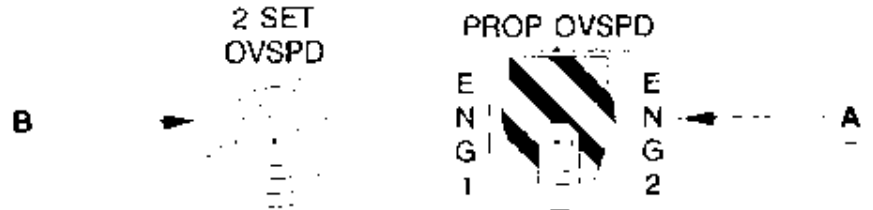

Used to test hydraulic part of overspeed governor.

Ⓐ First OVSPD threshold is tested at 102 % Np. on the affected engine.

Ⓐ + Ⓑ , 2nd OVSP threshold is tested at 106 % Np.

⑤ Propeller Feather Pump test switch

2144-0-1-16-50-0-2-1-100-0



This switch with two stable positions enables to test the feathering pump. For safety reasons, this test is impossible in flight.

⑥ Propeller LOW PITCH test switches

2144-0-1-16-50-0-2-1-100-0

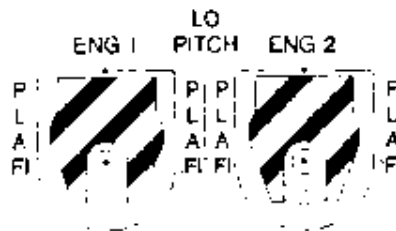

- With the test switch on PLA > FI position, the PL low pitch protection switch and feather solenoid are tested.
- With the test switch on PLA < FI position, secondary low pitch solenoid is tested.

Note : In both cases, LOW PITCH light illuminates

	POWER PLANT	1.16.60		
	ELECTRICAL SUPPLY/MFC LOGIC	P 1	001	
	SYSTEM MONITORING			DEC 96

ELECTRICAL SUPPLY

EQUIPMENT	DC BUS SUPPLY (C/B)	AC BUS SUPPLY (C/B)
ENG 1		
TQ ind.	DC EMER BUS (on lateral panel TORQUE)	- Nil -
NP ind.	DC ESS BUS (on lateral panel NP)	- Nil -
ITT ind.	DC ESS BUS (on lateral panel ITT)	Nil -
NH / NL ind.	DC ESS BUS (on lateral panel NH)	- Nil -
FF/EU ind.	DC BUS 1 (on lateral panel FUEL FLOW FUEL USED)	- Nil -
OIL PRESS/ OIL TEMP ind.	DC BUS 1 (on lateral panel OIL PRESS/TEMP)	- Nil -
FUEL TEMP ind.	DC BUS 1 (on lateral panel FUEL TEMP)	- Nil -
Feather control	DC EMER BUS (+ DC BUS 1) (on overhead panel FEATH CTL)	Nil -
Start control and indications	DC ESS BUS (on overhead panel START CTL and IND)	- Nil
Ignition system	DC ESS BUS (on overhead panel IGN)	- Nil -
EEC		- Nil -
. power supply	DC EMER BUS and DC BUS 1 (on overhead panel PWR SUPPLY)	
. control	DC EMER BUS (on overhead panel CTL and CAUTION)	
Propeller overspeed test	DC BUS 1 (on lateral panel PROP OVSPD TEST)	
Fuel clogging indication on maintenance panel	DC BUS 1 (on lateral panel FUEL CLOG)	- Nil -

	POWER PLANT	1.16.60	
	ELECTRICAL SUPPLY/ MFC LOGIC/SYSTEM MONITORING	P 2	001
			DEC 96

AA

ELECTRICAL SUPPLY

EQUIPMENT	DC BUS SUPPLY (C/B)
ENG 2 TQ ind.	DC EMER BUS (on lateral panel TORQUE)
NP ind.	DC ESS BUS (on lateral panel NP)
ITT ind.	DC ESS BUS (on lateral panel ITT)
NH / NL ind.	DC ESS BUS (on lateral panel NH)
FF/FU ind.	DC BUS 2 (on lateral panel FUEL FLOW FUEL USED)
OIL PRESS/OIL TEMP ind.	DC BUS 2 (on lateral panel OIL PRESS/TEMP)
FUEL TEMP ind.	DC BUS 2 (on lateral panel FUEL TEMP)
Feather control	DC ESS BUS (on overhead panel FEATH CTL)
Start control and indications	DC EMER BUS (on overhead panel START CTL and IND)
Ignition system	DC ESS BUS (on overhead panel IGN)
EEC · power supply · control	DC EMER BUS and DC BUS 2 (on overhead panel PWR SUPPLY) DC EMER BUS (on overhead panel CTL and CAUTION)
Propeller overspeed test	DC BUS 2 (on lateral panel PROP OVSPD TEST)
Fuel clogging indication on maintenance panel	DC BUS 2 (on lateral panel FUEL CLOG)

	POWER PLANT	1.16.60	
	ELECTRICAL SUPPLY/	P 3	550
	MFC LOGIC/SYSTEM MONITORING		JUN 97

EQUIPMENT	DC BUS SUPPLY (C/B)
Propeller brake	DC ESS BUS (on lateral panel PWR SUPPLY CTL IND)
Feather pump test	DC SVCE BUS (on lateral panel FEATH PUMP TEST)
PEC 1 & 2 (NORMAL) associated PVM and PIU	DC EMER BUS (on overhead panel)
PEC 1 & 2 (BACK-UP)	DC ESS BUS (on overhead panel)
Idle gate	. DC BUS 1 (on overhead panel SOL) . DC BUS 2 (on overhead panel CAUTION)

MFC LOGIC

See chapter 1.01.

	POWER PLANT ELECTRICAL SUPPLY/ MFC LOGIC/SYSTEM MONITORING	1.16.60		
		P 4	160	
				JUN 97

SYSTEM MONITORING

The following conditions are monitored by visual and aural alerts :

- Start sequence incident
 - See START FAULT procedure in chapter 2.05.02.
- Nacelle temperature exceeds 170° C (338° F) when aircraft is on ground.
 - See NAC OVHT procedure in chapter 2.05.02.

On ground, during second engine start, operative DC GEN does not come on line to supply the START BUS between 10 % and 45 % NH.

 - See X START FAIL procedure in chapter 2.05.02.
- ITT above limit
 - See EXCESSIVE ITT procedure in chapter 2.05.02.
- EEC failure
 - See ONE EEC FAULT procedure in chapter 2.05.02.
- Both EEC failure
 - See BOTH EEC FAULT procedure in chapter 2.05.02.
- Automatic idle gate system failure.
 - See IDLE GATE FAIL procedure in chapter 2.05.02.
- Low pitch detection in flight
 - See LOW PITCH IN FLT procedure in chapter 2.05.02.
- Oil pressure drops below 40 PSI
 - See ENG OIL LO PR procedure in chapter 2.05.02.
- Propeller brake not locked in full locked or in full released position.
 - See PROP BRK UNLK procedure in chapter 2.05.02.
- Propeller brake not locked in full locked or in full released position or propeller brake engaged and gust lock released
 - See PROP BRK (CAP alert) procedure in chapter 2.05.02.
- Clogging of the filter associated with HP pump.
 - See FUEL CLOG procedure in chapter 2.05.03.
- Loss of ADC
 - See ADC FAULT procedure in chapter 2.05.12.
- Incorrect ADC switching
 - See ADC SW FAULT procedure in chapter 2.05.12.
- Anomaly detection on either PEC channel
 - See PEC 1 (2) SGL CH procedure in chapter 2.05.02.
- Anomaly on Both PEC channels
 - See PEC 1 (2) FAULT procedure in chapter 2.05.02.

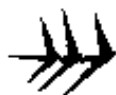
 ATR 72 F.C.O.M.	LIMITATIONS	2.01.00		
		P t	001	
	CONTENTS			JUL 99

AA

- 2.01.00 CONTENTS**
- 2.01.01 GENERAL**
- 2.01.02 WEIGHT AND LOADING**
- 2.01.03 AIRSPEED AND OPERATIONAL PARAMETERS**
- 2.01.04 POWER PLANT**
- 2.01.05 SYSTEMS**
- 2.01.06 TCAS (if installed)**
- 2.01.07 GPS (if installed)**
- R 2.01.08 CABIN LIGHTING**

 ATR72 F.C.O.M.	LIMITATIONS GENERAL	2.01.01		
		P 1	001	
				DEC 96

AA

INTRODUCTION

The airplane is certified in the Transport Category, JAR 25 and ICAO annex 16 for day and night operations, in the following conditions when the appropriate equipment and instruments required by the airworthiness and operating regulations are approved, installed and in an operable condition :

- VFR and IFR
- Flight in icing conditions
- Reverse thrust taxi (single or twin engine)

MINIMUM FLIGHT CREW

2 PILOTS

MAXIMUM OPERATING ALTITUDE

25 000 FT

 ATR 72 F.C.O.M.	LIMITATIONS	2.01.01		
		P 2	180	
	GENERAL			JUN 97

AA

MANEUVERING LIMIT LOAD FACTORS

FLAPS RETRACTED	= - 2.5 TO - 1G
FLAPS EXTENDED	= - 2 TO 0 G
GEAR DOWN	= + 2 TO 0 G

The corresponding positive accelerations limit the bank angle in turns and the severity of pull up maneuvers.

CARGO DOOR OPERATION

Do not operate cargo door with a cross wind component of more than 45 kt.

DISPATCHIBILITY

For dispatch in the event of equipment failure or missing equipment refer to MEL/CDL.

MAXIMUM NUMBER OF PASSENGER SEATS

74

as limited by emergency exits configuration. Other limitations such as that given by the emergency evacuation demonstration must be respected.

	LIMITATIONS		2.01.02		
			P 1	520	
	WEIGHT AND LOADING				JUL 00

AA

DESIGN WEIGHT LIMITATIONS

MAXIMUM WEIGHT	KG	LB
TAXI	22 180	48 898
TAKE OFF	22 000	48 501
LANDING	21 850	48 170
ZERO FUEL	20 000	44 092

CENTER OF GRAVITY ENVELOPE

The limits of center of gravity are given in percentage of the mean aerodynamic chord (MAC), landing gear extended.

The MAC is 2.303 meters long (90.67) inches.

Station 0 is located 2.362 meters (92.99 inches) forward of the fuselage nose.

The distance from station 0 to reference chord leading edge is 13.604 meters (535.59 inches).

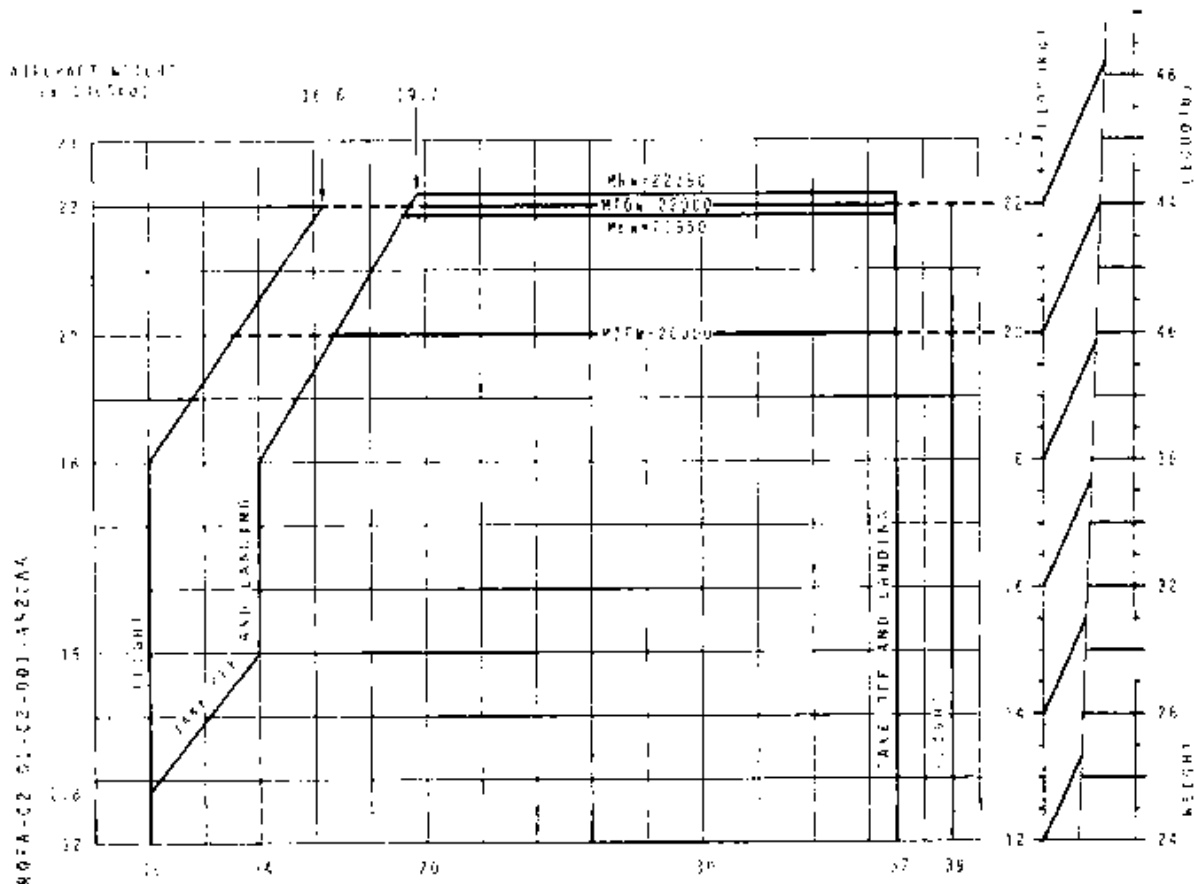

	LIMITATIONS	2.01.02		
	WEIGHT AND LOADING	P 2	001	
				NOV 93

AA

CARGO COMPARTMENT LOADING LIMITATIONS

R See WBM 1.10.04 p 1

PASSENGERS BOARDING/DISEMBARKING

- The tail prop must be installed before passengers boarding/diseMBarking.
- A possible tip up should be taken into account from seven persons moving near the rear part of an off load aircraft.

	LIMITATIONS AIRSPEED AND OPERATIONAL PARAMETERS	2.01.03		
		P 1	001	
				JUN 97

AA

AIRSPEEDS

* MAXIMUM OPERATING SPEED.

This limit must not be intentionally exceeded in any flight regime.

$$V_{MO} = 250 \text{ kt}$$

$$MMO = 0.55$$

R

* MAXIMUM DESIGN MANEUVERING SPEED V_A

Full application of roll and yaw controls as well as maneuvers involving angles of attack near the stall should be confined to speeds below V_A .

$$V_A = 175 \text{ kt}$$

R

* MAXIMUM FLAPS EXTENDED OPERATING SPEEDS V_{FE}

$$\text{FLAPS 15 } 185 \text{ kt}$$

$$\text{FLAPS 30 } 150 \text{ kt}$$

* MAXIMUM LANDING GEAR EXTENDED OPERATING SPEEDS

$$V_{LE} = 185 \text{ kt}$$

$$V_{LOR} = 160 \text{ kt}$$

$$V_{LCO} = 170 \text{ kt}$$

* MAXIMUM ROUGH AIR SPEED

$$V_{RA} = 180 \text{ kt}$$

* MAXIMUM WIPER OPERATING SPEED

$$V_{WO} = 160 \text{ kt}$$

* MAXIMUM TIRE SPEED : 165 kt (Ground speed).

 ATR 72 F.C.O.M.	LIMITATIONS AIRSPEED AND OPERATIONAL PARAMETERS	2.01.03		
		P 2	500	
				DEC 97

AA

R STALL SPEEDS - VSR

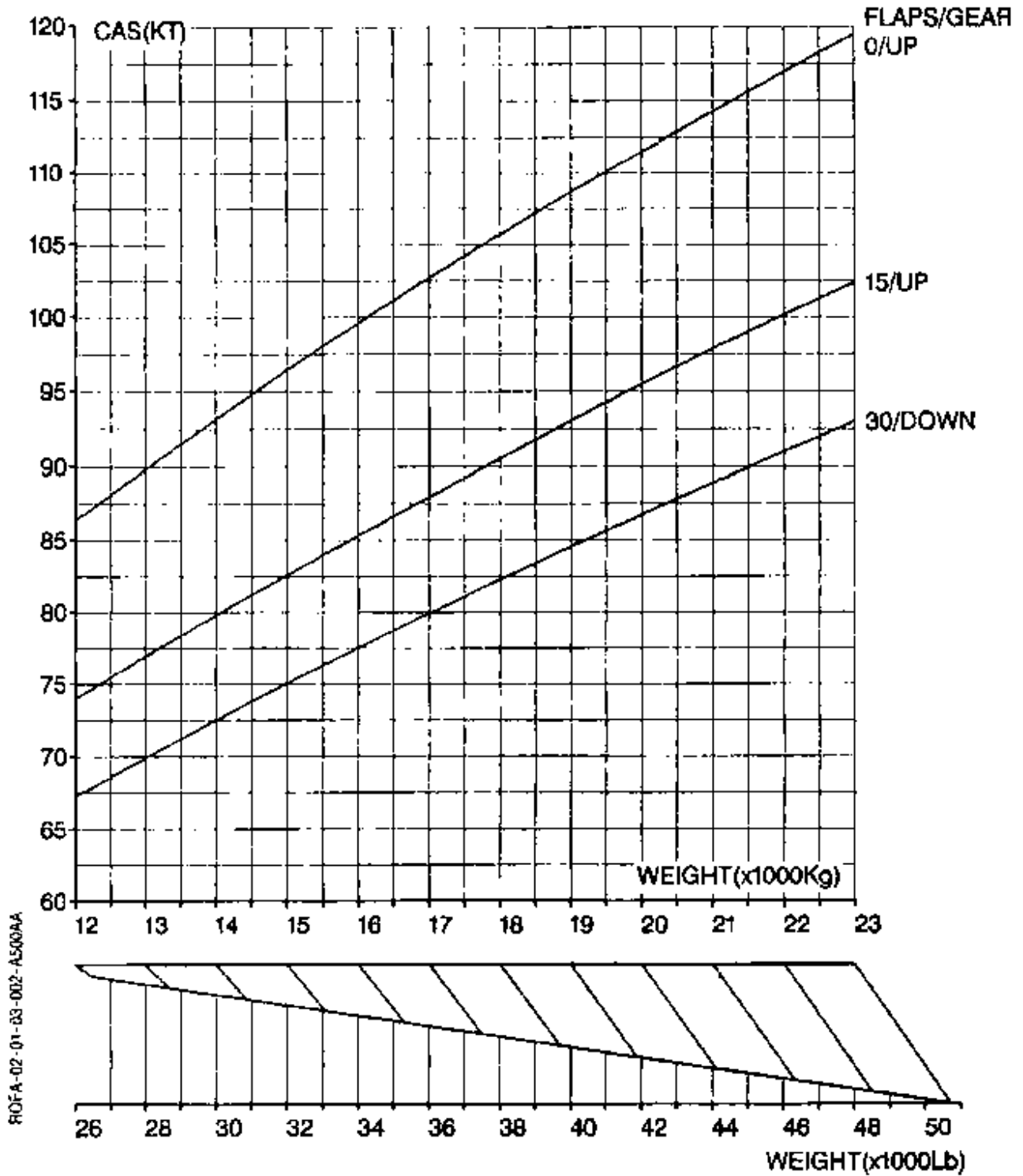

 ATR 72 F.C.O.M.	LIMITATIONS AIRSPEED AND OPERATIONAL PARAMETERS	2.01.03		
		P 3	500	
				DEC 97

AA

V1 LIMITED BY VMCG (FLAPS 15)

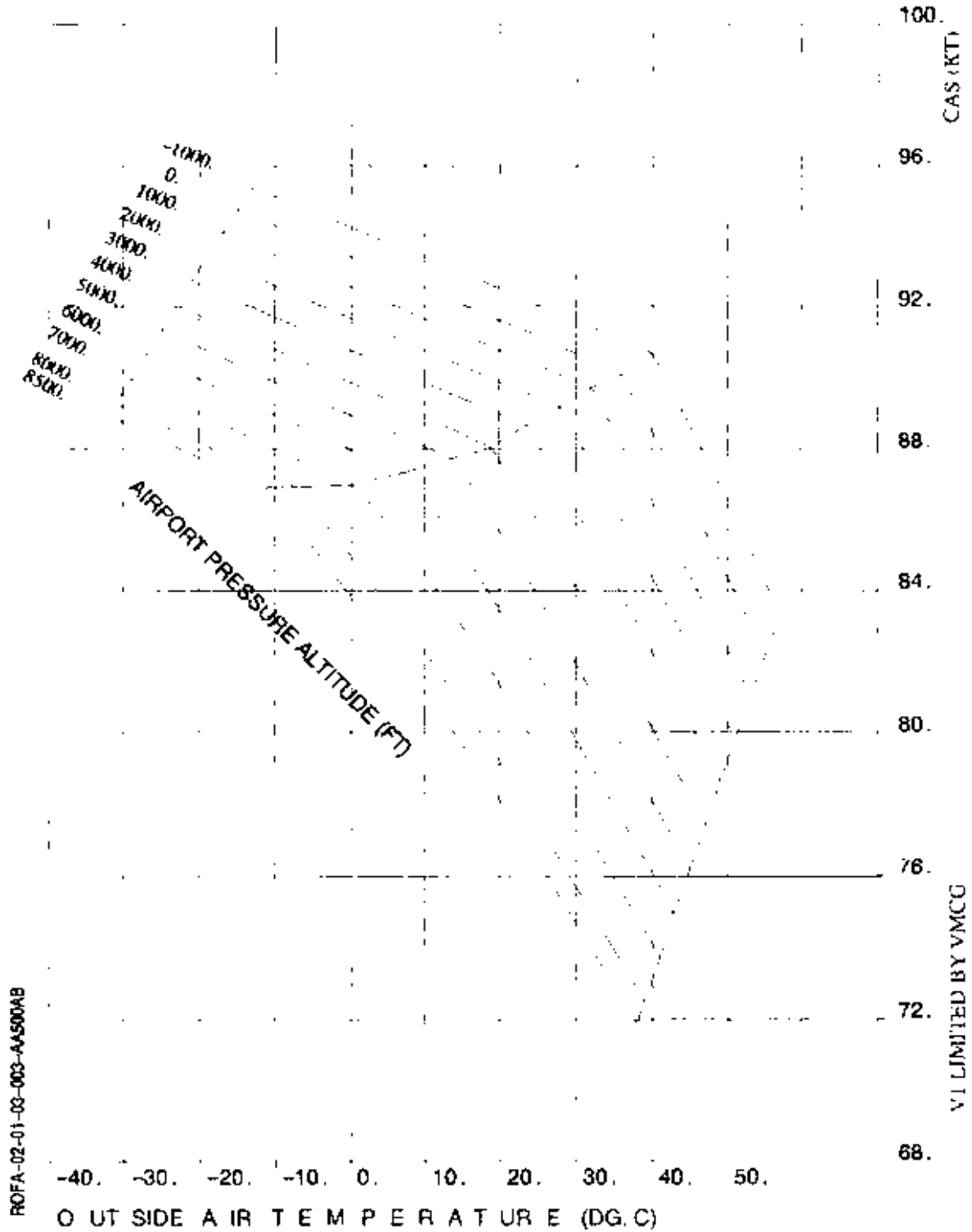

PROFA-02-01-03-003-AA500AB

 ATR 72 F.C.O.M.	LIMITATIONS		2.01.03		
			P 4	500	
	AIRSPEED AND OPERATIONAL PARAMETERS				JUN 97

AA

VMCA (FLAPS 15)

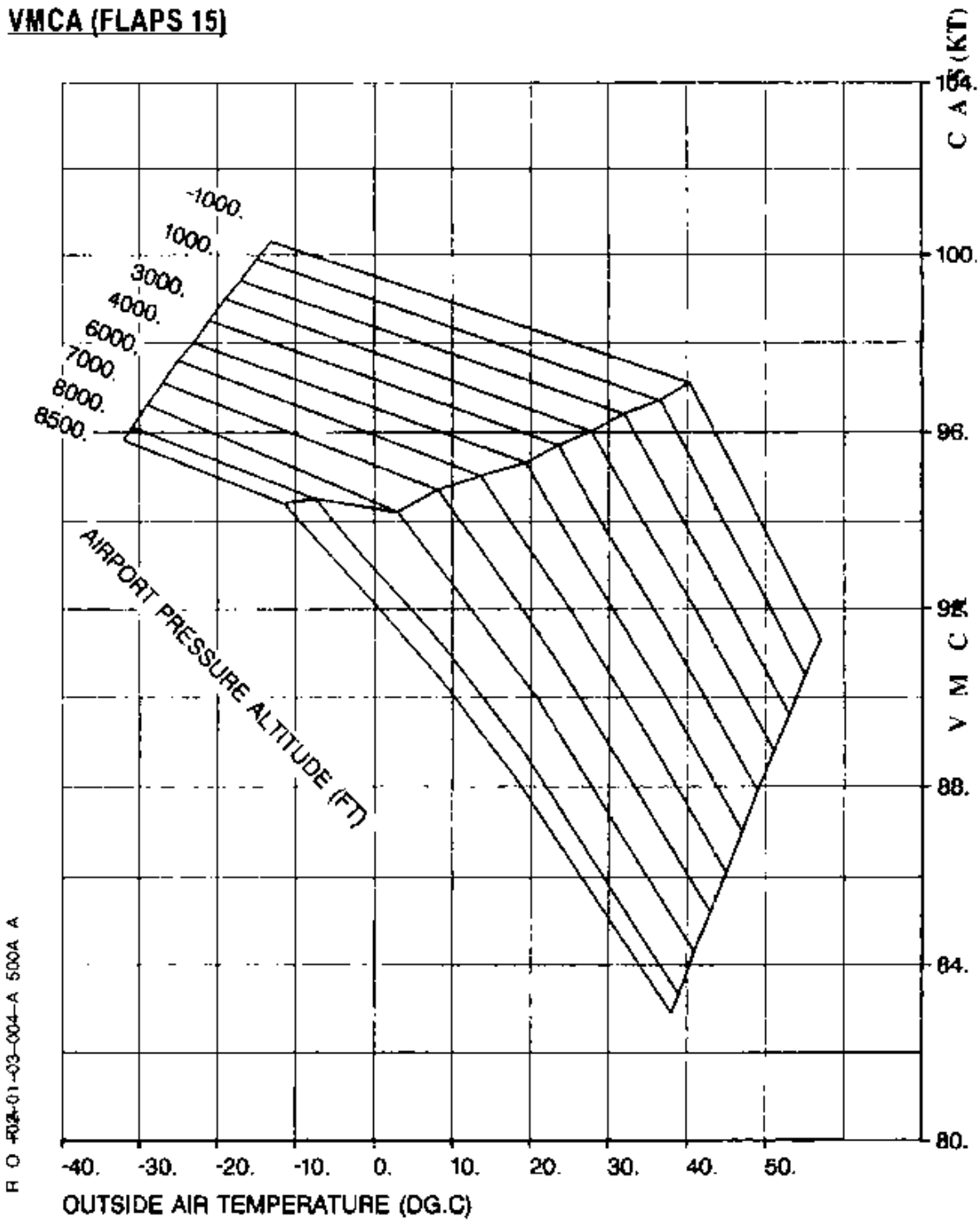

R O -03-01-03-004-A 500A A

VMCL

Flaps	VMCL (CAS)
30	98 kt
15	98 kt

 ATR 72 F.C.O.M.	LIMITATIONS		2.01.03		
			P 5	050	
	AIRSPEED AND OPERATIONAL PARAMETERS:				JUN 94

AA

OPERATIONAL PARAMETERS

ENVIRONMENTAL ENVELOPE

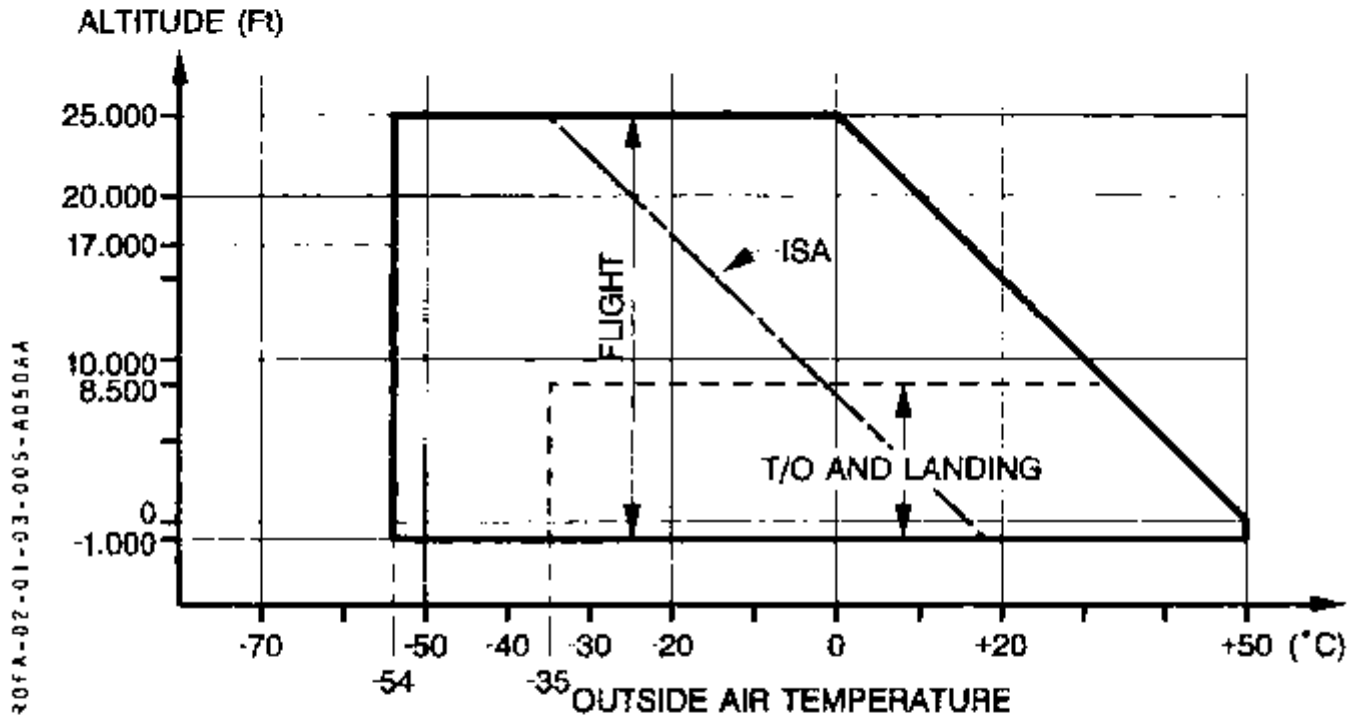

TAKE-OFF AND LANDING

TAIL WIND LIMIT : 10 KT

The maximum demonstrated cross wind on dry runway is 35 kt

MAXIMUM MEAN RUNWAY SLOPE : ± 2 %

	LIMITATIONS		2.01.04		
			P 1	500	
	POWER PLANT				JUL 01

AA

ENGINES**ENGINE PARAMETERS**

Operating limits with no unscheduled maintenance action required.

Beyond these limits, refer to maintenance manual.

POWER SETTING	TIME LIMIT	TQ (%)	ITT (°C)	NH (%)	NL (%)	NP (%)	OIL PRESS (PSI)	OIL TEMPERATURE (°C)
RESERVE TAKE OFF	10 mn (***)	100 (**)	800	103.2	104.2	101	55 to 65	0 to 125 (3)
TAKE OFF	5 mn	90 (**)	(*)	101.9	101.4	101	55 to 65	0 to 125 (3)
MAXIMUM CONTINUOUS	NONE (***)	93.9 (**)	800	103.2	104.2	101	55 to 65	0 to 125 (3)
GROUND IDLE				66 mini			40 mini (****)	- 40 to 125 (3)
HOTEL (4) MODE			715				55 to 65	125 (3)
STARTING	5 s		950 (2)					- 54 min
OTHER			800			106 (*****)		
TRANSIENT	5 s					120		
	20 s(1) (2)	120	840	106.4	106.8	108		
	20 mn							140

During RESERVE TAKE OFF, TQ indication may exceed 100 % but not 106.3 %.

(*) ITT limite depends on outside air temperature; refer to 2.01.04 P 3 for detailed information.

(**) Value linked to 100 % NP.

(***) Time beyond 5 mn is linked to actual single engine operations only.

(****) Up to 75 % NH only.

(*****) Permissible for completion of flight provided TQ does not exceed 75.2 % during climb and 73.13 % during cruise.

(1), (2), (3), (4) : see page 4.

R Note : Flight with an engine running and the propeller feathered is not permitted.

	LIMITATIONS POWER PLANT	2.01.04		
		P 2	500	
				JUN 97

AA

OVERTORQUE LIMIT

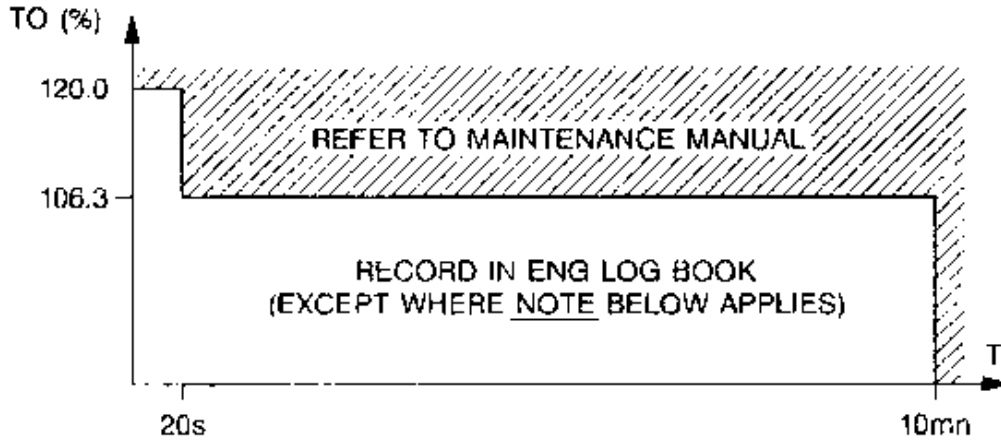

Note : Operation up to 106.3% torque is time unlimited when NP is below 94%

OVERTEMPERATURE LIMIT FOR STARTING

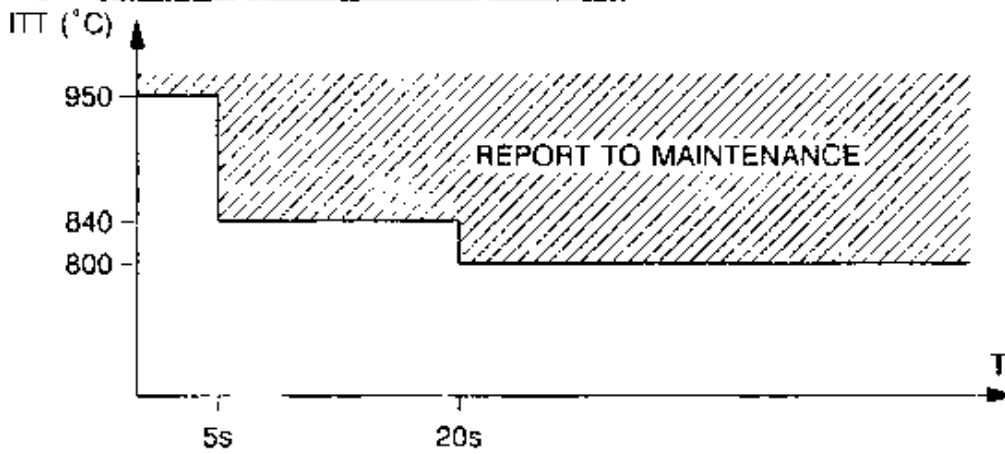

ENGINE OPERATING

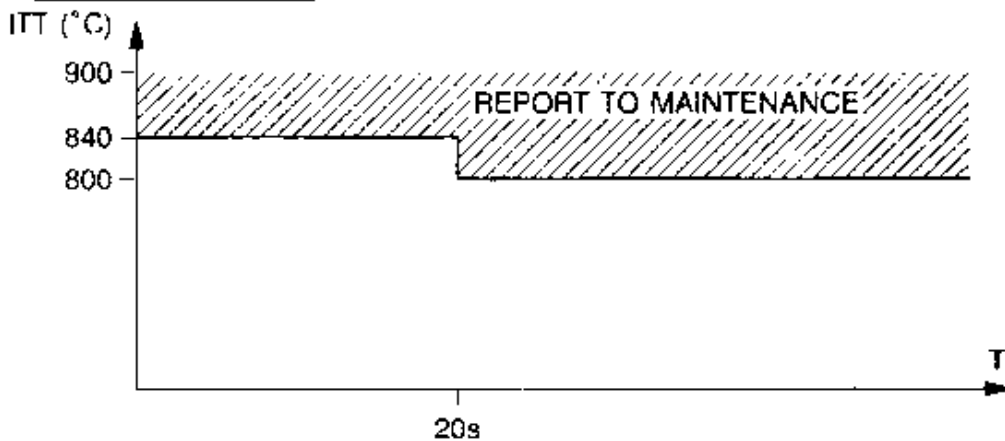

3014-07-01-04-002-A500AA

	LIMITATIONS	2.01.04		
		P 3	500	
	POWER PLANT			JUN 97

AA

ITT LIMITS

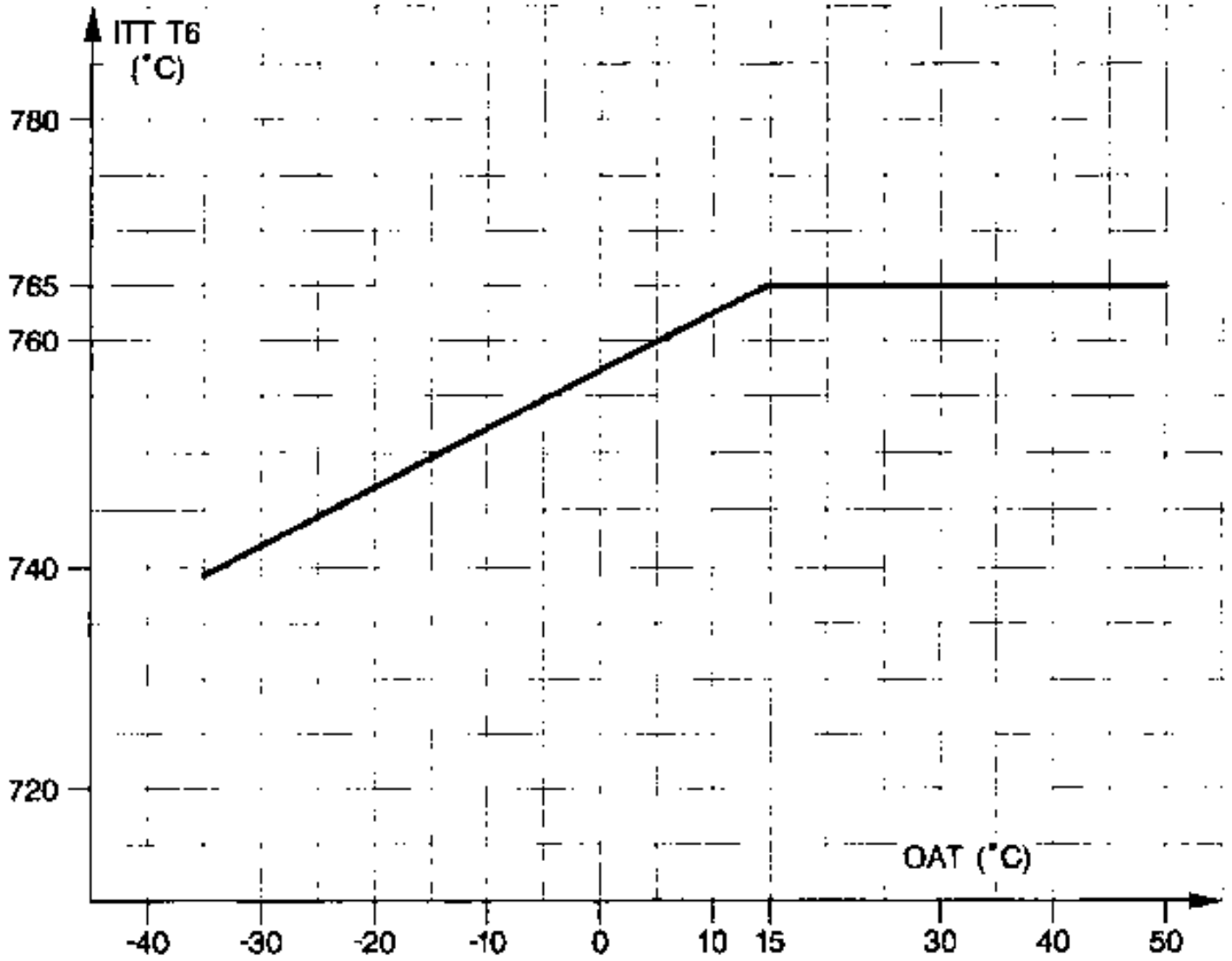

R O F02-01-04-003-A 500A A

	LIMITATIONS	2.01.04		
		P 4	500	
	POWER PLANT			JUL 98

AA

- (1) - Determine and correct cause of overtorque.
- Record in engine log book for maintenance.
- (2) - Determine and correct cause of overtemperature.
- Record in engine log book for maintenance.
- R (3) - Temperature up to 125°C is authorized without time limitation.
20 mn are authorized between 125°C and 140°C.
- Refer to ENG OIL HI TEMP procedure.

Note : Oil temperature must be maintained above 45°C to ensure inlet strut de-icing.

Oil temperature must be maintained above 71°C to ensure fuel anti-icing protection in absence of the low fuel temperature indication.

- (4) - Do not use engine 2 in HOTEL MODE without a qualified person (flight crew or maintenance) in the cockpit.

PROPELLERS

GROUND OPERATION

- Engine run up must be performed into the wind.
- Engine ground operations with crosswind between 5 and 20 kt should not exceed 58 % TQ.

IN FLIGHT OPERATION

USE OF NP SETTING BELOW 82 % IN ICING CONDITIONS IS PROHIBITED

ATR airplanes are protected against a positioning of power levers below the flight idle stops in flight by an IDLE GATE device. It is reminded that any attempt to override this protection is prohibited. Such positioning may lead to loss of airplane control or may result in an engine overspeed condition and consequent loss of engine power.

GROUND OR FLIGHT

If a propeller is involved in an overspeed or in an engine overtorque, refer to the propeller maintenance manual.

	LIMITATIONS POWER PLANT	2.01.04		
		P 5	070	
				JUN 97

AA

STARTER

3 STARTS WITH A 1 MN 30 SEC MAXIMUM COMBINED STARTER RUNNING TIME FOLLOWED BY 4 MN OFF

OIL SYSTEM

Approved lubricating oils (from PWC SB 20001):

- Aero Shell Turbine oil 500
- Aero Shell Turbine oil 560
- Royco Turbine oil 500
- Royco Turbine oil 560
- Mobil Jet oil II
- Mobil Jet oil 254
- Castrol 4000
- Castrol 5000
- Exxon Turbo oil 2380

Mixing of different brands of oil or viscosities of oil is not recommended.

FUEL SYSTEM

- Acceptable fuels (refer to PWC SB 20004 to determine equivalent approved fuels).

	FUELS	FREEZING POINT (°C)	MINIMUM FUEL TEMP (°C)		MAXIMUM FUEL TEMP (°C)
			Starting	Operation	
R	JET A	- 40	- 34	- 38	+ 57
R	JET A1	- 50	- 34	- 48	+ 57
R	JP 5	- 46	- 26	- 33	+ 57

- Approved anti icing additives (maximum concentration allowed : 0.15 % per volume) :

- Philips PFA 55 MB
- MIL-I-27 686 D
- Ethylene Glycol Monomethyl Ether as defined in MIL-I-27 686 E.

	LIMITATIONS	2.01.04		
		P 6	500	
	POWER PLANT			JUN 97

AA

REFUELING

MAXIMUM PRESSURE 3.5 BARS (50 PSI)

USABLE FUEL

THE TOTAL QUANTITY OF FUEL USABLE IN EACH TANK IS
2500 KG (5510 LBS)

NOTE : FUEL REMAINING IN THE TANKS WHEN
QUANTITY INDICATORS SHOW ZERO IS NOT USABLE
IN FLIGHT

UNBALANCE

MAXIMUM FUEL UNBALANCE : 730 kg (1609 lb)

FEEDING

- EACH ELECTRIC PUMP IS ABLE TO SUPPLY ONE ENGINE IN THE WHOLE FLIGHT ENVELOPE
- ONE ELECTRICAL PUMP AND ASSOCIATED JET PUMP ARE ABLE TO SUPPLY BOTH ENGINES IN THE WHOLE FLIGHT ENVELOPE
- ONE JET PUMP IS ABLE TO SUPPLY BOTH ENGINES IN THE WHOLE FLIGHT ENVELOPE, EXCEPT WHEN USING JP4 OR JET B.

 A320 F.C.O.M.	LIMITATIONS		2.01.05		
			P 1	030	
	SYSTEMS				JUL 98

AA

AIR - PRESSURIZATION

MAXIMUM DIFFERENTIAL PRESSURE	6.35 PSI
MAXIMUM NEGATIVE DIFFERENTIAL PRESSURE	- 0.5 PSI
MAXIMUM DIFFERENTIAL PRESSURE FOR LANDING	0.35 PSI
MAXIMUM DIFFERENTIAL PRESSURE FOR OVBD VALVE FULL OPEN SELECTION	1 PSI
MAXIMUM ALTITUDE FOR ONE BLEED OFF OPERATION	20 000 ft

ELECTRICAL SYSTEM

R	SOURCE	MAX LOAD	TIME LIMIT
	DC GEN	400 A	NONE
		600 A	2 mn
		800 A	8 s
	INV	500 VA	NONE
		575 VA	30 mn
		750 VA	5 mn
	ACW GEN	20 KVA	NONE
		30 KVA	5 mn
		40 KVA	5 s
	TRU	60 A	NONE
		90 A	5 mn

SINGLE DC GEN OPERATION

In flight : if OAT exceeds ISA + 25, flight level must be limited to FL 200

HYDRAULIC SYSTEM

SPECIFICATION : HYJET IV OR SKYDROL LD 4
--

LANDING GEAR

DO NOT PERFORM PIVOTING (SHARP TURNS) ON A LANDING GEAR WITH FULLY BRAKED WHEELS EXCEPT IN CASE OF EMERGENCY
--

MFC

TAKE OFF WITH TWO OR MORE FAILED MFC MODULES IS PROHIBITED.

	LIMITATIONS		2.01.05	
			P 2	100
	SYSTEMS		JUL 01	

AA

OXYGEN

R

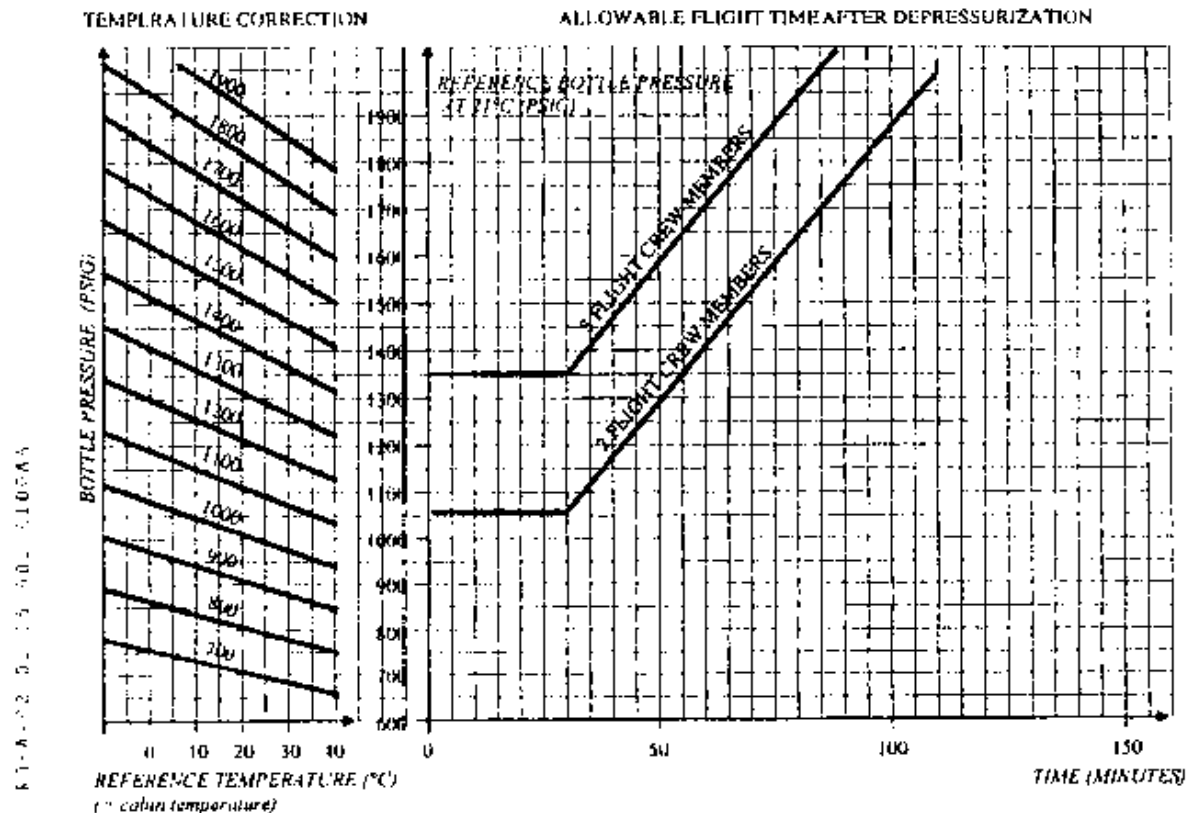

Reference temperature = Cabin Temperature or OAT whichever is higher, on ground
= Cabin Temperature in flight

Minimum bottle pressure required to cover a cabin depressurization at mid-time of the flight, an emergency descent from 25,000 ft to 13,000 ft within less than 4 minutes and a flight continuation at an altitude below 13,000 ft.

A 25 % pax oxygen consumption is assumed.

In case of smoke emission, the system protects the flight crew members during 15 min.

Note : At dispatch the computed flight time after decompression should be at least 1/2 of estimated flight time to destination or flight time to the longest en route alternate whichever is higher.

Provision is made to cover :

- unusable quantity
- normal system leakage
- Ref. Temp errors.

 ATR 72 F.C.O.M.	LIMITATIONS		2.01.05		
			P 3	001	
	SYSTEMS				DEC 96

AA

AUTOMATIC FLIGHT CONTROL SYSTEM (AFCS)

- MINIMUM HEIGHT FOR AUTO PILOT ENGAGEMENT AFTER TAKE OFF : 100 ft
- MINIMUM HEIGHT FOR USE of either AP or FD :
 - except during take off or executing an approach : 1000 ft
 - VS or IAS mode during approach : 160 ft
 - CAT I APP mode : 160 ft
- NAV MODE for VOR approach, using either autopilot or flight director is authorized only if :
 - a co-located DME is available, and
 - DME HOLD is not selected.

Refer to 2.02.04 for CAT II operations.

INSTRUMENT MARKINGS

- RED ARC OR RADIAL LINE : MINIMUM AND MAXIMUM LIMITS
- YELLOW ARC : CAUTION AREA
- GREEN ARC : NORMAL AREA

FLAPS

- R Holding with any flaps extended is prohibited in icing conditions (except for single engine operations).

ICING CONDITIONS

- R All icing detection lights must be operative prior to flight into icing conditions at night.
 - The ice detector must be operative for flight into icing conditions.

	LIMITATIONS	2.01.06		
		P1	050	
	TCAS			JUL 01

AA

TCAS

LIMITATIONS

The limitations in Part 2.01 are applicable with the addition of the following:

- 1- TCAS operation is approved for use in VFR meteorological conditions (VMC) and IFR meteorological conditions (IMC).
- 2- The pilot must not initiate evasive maneuvers using information from the traffic display only or from a traffic advisory (TCAS TA) only, without visually sighting the traffic. These displays and advisories are intended only for assistance in visually locating the traffic and lack the resolution necessary for use in evasive maneuvering.
- 3- Compliance with TCAS resolution advisory is required unless the pilot considers it unsafe to do so or unless the flight crew has better information (e.g. ATC guidance, definitive visual acquisition, etc) about the aircraft causing the R.A. and can maintain safe operation.

However, maneuvers which are in the opposite direction of the resolution advisory (TCAS RA) are extremely hazardous and are prohibited unless it is visually determined they are the only means to assure safe separation.

CAUTION : Once a non crossing RA has been issued the vertical speed should be accurately adjusted to comply with the RA, in order to avoid negating the effectiveness of a co-ordinated manoeuvre by the intruder.

WARNING : Non compliance with a crossing RA by one airplane may result in reduced vertical separation. Therefore, safe horizontal separation must also be assured by visual means.

- 4- Evasive maneuvering should be made with the autopilot disengaged, and limited to the minimum required to comply with the RA. The pilot must promptly return to the previous ATC clearance when the TCAS "CLEAR OF CONFLICT" voice message is announced.
- 5- Prior to perform RA's climb or increase climb, the crew should select the appropriate engine power setting on the power MGT rotary selector and, if necessary, manually adjust CLs.
- 6- When a climb or increase climb RA occurs with the airplane in the landing configuration or in the go-around phase, a normal procedure of go-around should be followed including the appropriate power increase and configuration changes.

 ATR 72 F.C.O.M.	LIMITATIONS TCAS	2.01.06		
		P 2	050	
				JUL 01

AA

TCAS (cont'd)

- 7- Because of the limited number of inputs to TCAS for determination of aircraft performance inhibits, there are instances where inhibiting RAs would be appropriate, however it is not possible to do so. In these cases, TCAS may command maneuvers which may significantly reduce stall margins or result in stall warning. Conditions where this may occur include operations with a bank angle (wings level is assumed), weight, altitude and temperature combinations outside those noted below, leaving aircraft in landing configuration during climb RA on approach, engine out operations, and abnormal configurations such as landing gear not retracted or stick pusher/shaker failure.

The table below entitled "Flight Envelope in which climb resolution advisory can be accomplished without stick pusher/shaker activation" outlines the parameters used in the development of the performance inhibits. This table does not consider worst turboprop flight conditions especially operations using minimum operating airspeeds as are sometimes required (e.g. obstacle clearance, ATC constraints). In all cases, stall warning must be given precedence over climb RA commands.

NOTE : *TCAS is viewed as a supplement to the pilot who, with the aid of the ATC system, has the primary responsibility for avoiding mid-air collisions.*

WARNING : Priority must be granted to increasing airspeed when reaching stall warning even when this requires deviation from an RA command issued by the TCAS.

 ATR 72 F.C.O.M.	LIMITATIONS		2.01.06		
	TCAS		P 3	050	
					JUL 01

AA

TCAS (cont'd)

FLIGHT ENVELOPE IN WHICH CLIMB RESOLUTION ADVISORY CAN BE ACHIEVED WITHOUT STICK PUSHER / SHAKER ACTIVATION						
FLIGHT REGIME	WEIGHT ALTITUDE TEMP.	POWER	FLAPS	GEAR	AIRSPEED	
					INITIAL	MIN.
Take off	FAR25/JAR25 Climb limit	Take off	15	Up	V2 + 20	1.13 Vs1g
Approach	FAR25/JAR25 Climb limit	Spin up to go around power during maneuver from power for level flight	15	UP	1.51 Vs1g	1.13 Vs1g
Landing Transitioning to go around at RA	FAR25/JAR25 Climb limit	Spin up to go around power during maneuver from power required for 3° Glide Slope	Transition from 30 to 15	DN to Up	VAPP + 10	1.13 Vs1g
Enroute	Critical Wt/Alt giving 1.3G to buffet onset	Power for level flight increase to Max Continuous	Up	Up	Long Range Cruise	Higher of 1.13 Vs1g if defined or buffet onset

Temperature range up to ISA + 27°

	- Enroute	0	25000 ft
Altitude range	- Take off	0	6000 ft
	- Approach and landing	0	7000 ft

Wings Level Assumed

	LIMITATIONS	2.01.06		
	TCAS	P 4	050	
				JUL 01

AA

TCAS (cont'd)

8- Inhibition schemes

8.1- Non icing conditions

CONFIGURATION	RA CLIMB	RA INCREASE CLIMB
FLAPS 0	AUTHORIZED	AUTHORIZED
FLAPS 15 TO	AUTHORIZED	INHIBITED
FLAPS 15 APPROACH	AUTHORIZED	AUTHORIZED
FLAPS 30	AUTHORIZED	INHIBITED

8.1- Icing conditions

CONFIGURATION	RA CLIMB	RA INCREASE CLIMB
FLAPS 0 Z < 18000 ft	AUTHORIZED	INHIBITED
FLAPS 0 Z > 18000 ft	INHIBITED	INHIBITED
FLAPS 15 TO	AUTHORIZED	INHIBITED
FLAPS 15 APPROACH	AUTHORIZED	INHIBITED
FLAPS 30	INHIBITED	INHIBITED

NOTE 1 : *Pilots are authorized to deviate from their current ATC clearance to the extent necessary to comply with a TCAS resolution advisory.*

NOTE 2 : *Maneuvers based solely on information displayed on the traffic display are not authorized.*

	LIMITATIONS TCAS	2.01.06		
		P 5	050	
				JUL 01

NA

TCAS (cont'd)

NORMAL PROCEDURES

The normal procedures in Part 2.03 are applicable.

EMERGENCY PROCEDURES

The emergency procedures in Part 2.04 are applicable.

PROCEDURES FOLLOWING FAILURES

The procedures following failures in Part 2.05 are applicable with the addition of the following:

The TCAS must be turned **TA ONLY** in the following cases:

- Engine out operations
- Slick pusher/shaker failure
- Flight with landing gear down

The TCAS must be turned **STBY** in the following cases:

- ATC request
- ADC 1 failure
- LOSS OF RADIO ALTIMETER INFORMATION
- Errors or differences between independant air data sources

PERFORMANCES

The performances in Part 3 are applicable.

	LIMITATIONS	2.01.07	
	GLOBAL POSITIONING SYSTEM	P 1	270
	GPS		JUL 00

AA

GPS

1 - GENERAL

The Honeywell/Trimble GNSS 1000 :

- complies with TSO C 129 and TSO C 115A,
- is installed in compliance with FAA AC 20-129, AC 20-130A, AC 20-138 and DGAC CRI S-9902,
- has been demonstrated to meet the requirements of JAA TGL n°2, REV1 and FAA AC 20-138 and FAA Notice N8110-60.

2 - LIMITATIONS

Compliance with the above regulations does not constitute an operational approval/authorization to conduct operations. Aircraft operators must apply to their Authority for such an approval/ authorization.

- The HT 1000 pilot's guide must be available on board.
 - The system must operate with HT 1000-060 software version or any later approved version.
 - The system must be used with an updated active data base and the waypoints position must be cross-checked with official charts.
 - This equipment is approved for use as :
 - primary navigation means for oceanic and remote operations when only one long range navigation system is required.
 - supplemental navigation means, en route, in terminal area and for non precision approach operations until the missed approach point with respect of the MDA.
- NOTE :** Stand alone GPS approach is not approved. Conventional means must be permanently cross-checked during the approach.
- advisory VNAV means.

NOTE : VDEV function must be permanently monitored.

3 - PROCEDURES

- In the event of DGR alarm illumination the flight crew must cross-check the aircraft position using conventional means or must revert to an alternative means of navigation.
- In addition, where the coupled DME option is not installed or if the coupled DME is not operative, the following procedures apply for B-RNAV operations :
 - (a) during the pre-flight planning phase, the availability of GPS integrity (RAIM) must be confirmed for the intended flight (route and time). Dispatch must not be made in the event of predicted continuous loss of RAIM of more than 5 minutes for any part of the intended flight.
 - (b) Traditional navigation equipment must be selected to available aids so as to allow immediate cross-checking or reversion in the event of loss of GPS navigation capability

 ATR 72 F.C.O.M.	LIMITATIONS CABIN LIGHTING	2.01.08		
		P 1	100	
				JUL 99

AA

The general cabin illumination system must be used during not less than 15 minutes before each flight.

 ATR 72 F.C.O.M.	PROCEDURES AND TECHNIQUES CONTENTS	2.02.00		
		P 1	001	
				JUN 96

AA

2.02.00	CONTENTS
2.02.01	OPERATING SPEEDS
2.02.02	DATA CARD
2.02.03	AIR
2.02.04	AFCS
2.02.05	ELECTRICAL SYSTEM
2.02.06	FLIGHT CONTROLS
2.02.07	FUEL SYSTEM
2.02.08	ADVERSE WEATHER
2.02.09	LANDING GEAR/BRAKES
2.02.10	FLIGHT PATTERNS
2.02.11	POWER PLANT
2.02.12	FLIGHT CHARACTERISTICS
R 2.02.13	NAVIGATION SYSTEM/OMEGA
2.02.14	FLIGHT INSTRUMENTS
2.02.15	TCAS (if installed)
2.02.16	GPWS
2.02.17	GPS (if installed)

	PROCEDURES AND TECHNIQUES OPERATING SPEEDS	2.02.01		
		P 1	500	
				JUN 97

AA

GENERAL

- Older certification rules used as a reference the minimum speed which was recorded during defined stall penetration.
This speed was established with a load factor lower than 1g. It was used as a reference for all operational speeds.
(example $V_2 = 1.2 V_{smin}$, $V_{REF} = 1.3 V_{smin}$).
- New certification now uses as a reference THE ONE G STALL SPEED VSR which is typically 6 % greater than V_{smin} .
- In order to provide the same practical maneuver margin, the factors applied to VSR have been changed to reflect the increased value of VSR relative to V_{smin} .

1.2 applied to V_{smin} becomes 1.13 when applied to VSR
1.25 applied to V_{smin} becomes 1.18 when applied to VSR
1.3 applied to V_{smin} becomes 1.23 when applied to VSR
- The ATR 72-212A having been certificated to the new rules, the reference stalling speed called VSR is determined as a one G stall speed and the new (reduced) factors apply accordingly.

	PROCEDURES AND TECHNIQUES OPERATING SPEEDS	2.02.01		
		P 2	500	
				JUL 98

AA

DEFINITIONS

VSR 1 g stalling speed for a specified configuration. It is a function of the aircraft weight.

VMCG Minimum control speed on the ground from which a sudden failure of the critical engine can be controlled by use of primary flight controls only, with the other engine operating at RTO power.

V1 Speed at which the pilot can make a decision following failure of critical engine:
. either to continue take-off
. or to stop the aircraft

VR Speed at which rotation is initiated to reach V2 at 35 ft height.

V2 Take off safety speed reached before 35 ft height with one engine failed and providing second segment climb gradient not less than the minimum (2.4 %).

VMCA Minimum control speed in flight at which the aircraft can be controlled with 5° bank, in case of failure of the critical engine with the other engine at RTO power (take off flaps setting and gear retracted.)

VMCL Minimum flight speed at which aircraft can be controlled with 5° bank in case of failure of the critical engine, the other being set at GA power (landing flaps setting, gear extended) and which provides rolling capability specified by regulations.

VFE Maximum speed for each flaps configuration

	PROCEDURES AND TECHNIQUES OPERATING SPEEDS	2.02.01		
		P 3	500	
				JUL 99

AA

MINIMUM MANEUVER/OPERATING SPEEDS

Minimum maneuver/ operating speeds are defined in order to provide sufficient margin against stall. They will vary with :

- Normal or icing conditions,
- weight,
- configuration,
- type of maneuver (HI or LO BANK).

They are defined by a minimum ratio to the appropriate stall speed given in FCOM 2.01.03 or by V_2 when applicable.

NORMAL CONDITIONS

FLAPS	V_{mHB}	V_{mLB}
0	1.23 VSR and not less than VMCL during approach	1.18 VSR
15		V_2
30		Not used

Note : Refer to 2.02.08 for icing conditions.

UTILIZATION

- V_{mLB} is the absolute minimum maneuver speed.
This speed
 - * is used for take off, and initial climb.
 - * must be used EN ROUTE FOR OBSTACLE LIMITED SITUATIONS (refer to chapter 3.09)
- R * should be used in flaps 0 configuration to obtain the best climb gradient.

In all these cases, bank angle must be restricted to 15° (low bank selected when using AFCS).

- V_{mHB} is the minimum speed used for approach. It also provides the best two engines rate of climb.
In this case, bank angle must be restricted to 30° (High bank selected when using AFCS).

In order to determine these speeds in a more pilot oriented manner, an operating data booklet included in check list is provided in which relevant minimum maneuver/operating speeds are directly given for all weights.

CONSERVATIVE MANEUVERING SPEEDS

When performance consideration does not dictate use of minimum maneuver / operating speeds, the following conservative maneuvering speeds are recommended.

They cover all weights, normal operational maneuver and flight conditions (normal and icing conditions) :

Flaps 0 : 180 kt.

Flaps 15 : 150 kt.

Flaps 30 : 135 kt.

FINAL APPROACH SPEED

R

$V_{APP} = V_{mHB} + \text{WIND FACTOR}$ or VMCL, whichever is higher
--

WIND FACTOR = The highest of

- 1/3 of the head wind velocity,
- or the gust in full,

with a maximum wind factor of 15 kt.

Wind factor is added to give extra margin against turbulence, risk of wind shear etc...

GO AROUND SPEED VGA

V_{mHB} landing configuration + 5 kt or 1.1 VMCA, whichever is higher.

MINIMUM SPEED FOR FLAPS RETRACTION



It is V_{mLB} of the next flap setting.

Example :

- Minimum speed to retract flaps from 15 to 0 : V_{mLB0} .

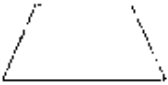
 AR72 F.C.O.M.	PROCEDURES AND TECHNIQUES DATA CARD	2.02.02		
		P 1	001	
				DEC 96

 TAKE OFF				
FLT N°	FROM	TO	DATE	
ATIS	W lim:	TOW:	CG% TRIM	ACC:
	OBJ TQ:	V1:	14 — 2.5	 N - 1
	RTO TQ:	VR:	19 — 2	
		V2:	23 — 1.5	
		VmLBO	28 — 1	
		norm:	32 — 0.5	
		icing:	37 — 0	

 LANDING				
DESTINATION	ALT	ALTERNATE	ALT	
ATIS	W lim:	LW:	ACC:	 GA
	GA TQ:	FLAPS:		
	1.1 VMCA:	VAPP: no wind		
	VGA:	VAPP:		
		VmLBO		
		norm:		
		icing:		

R
R
R
R

RCFR-02-02-02-001-1001AA

 ATR 72 F.C.O.M.	PROCEDURES AND TECHNIQUES AIR	2.02.03		
		P 1	001	
				NOV 93

AA

OVBD VALVE OPERATION ON GROUND

When the OVBD VALVE CTL sw is in AUTO mode, the extract fan runs continuously and the OVBD valve is :

- Opened as long as the engine 1 is not running (oil low press signal).
- Closed as soon as the engine 1 is running.

When door is closed after boarding (engine 1 not running = OVBD valve opened), the extract fan suction will create a very noticeable pressurization change (more important when operating with GPU than in hotel mode due to absence of inlet air flow).

In order to avoid this uncomfortable situation, when cockpit preparation is performed and in any case before closing the passengers door, the cockpit communication hatch must be opened.

R It will be closed after engine 1 start.

R *Note* : Before closing, the temperature selectors may be set to FULL COLD position in order to limit the packs air flow thus avoiding a pressure shock.

 NR72 F.C.O.M.	PROCEDURES AND TECHNIQUES AIR	2.02.03		
		P 2	080	
				JUL 98

AA

AIR CONDITIONING

When operating from airfields with high OAT, it is essential to cooldown the cabin before boarding passengers: this is best achieved by use of a ground conditioning unit, but may also be done through the use of Hotel Mode, and in that case the following considerations will apply :

- as soon as OAT exceeds 22° C and aircraft has remained exposed to direct sun, PRE-CONDITIONING becomes necessary for passengers comfort, prior to boarding;
- allow a reasonable period of time for pre-conditioning, and use up to MAXIMUM POWER AVAILABLE ON R/H ENGINE (GUST LOCK STOP) together with HI FLOW selection.

Note 1: HI FLOW is very effective when R/H PL is advanced beyond GI.

Note 2: Proper orientation of the aircraft on Parking area (wind blowing from 10 o'clock ideally) during Hotel Mode pre-conditioning is very favorable as it gives better efficiency and allows to continue pre-conditioning during AFT CARGO loading (hot air from RH engine exhaust blown away from service door).

R

- If for any reasons, it has not been possible to bring cabin temperature down to comfortable values prior to boarding, the following considerations will apply :
 - Packs operation during taxi should be performed with HI FLOW selected.
 - Switch FLOW selection to NORM prior to take-off, but keep bleeds on, unless performance limited.
 - As soon as CLB POWER is selected after take off, select HI FLOW and maintain HI FLOW until comfortable cabin temp is obtained.
 - During cruise, monitor cabin temp when operating in NORM FLOW : if cabin temp. tends to increase again above comfortable values, use HI FLOW as necessary.

TEMP CONTROL

Temperature control is normally achieved in AUTO MODE, which incorporates all necessary protections to avoid damage to packs turbine due to freezing.

In case of duct overheating, manual mode is recommended.

As manual mode does not incorporate the protections of AUTO MODE, the following considerations apply.

- Do not use temperature selector in manual mode unless auto mode is inoperative.
- When in manual mode, monitor duct temperature and adjust rotary selector to maintain positive duct temp : this is essential to avoid pack freezing.

 AJR72 F.C.O.M.	PROCEDURES AND TECHNIQUES AIR	2.02.03		
		P 3	001	
				JUN 96

AA

AIR PRESSURIZATION

AUTO MODE OPERATION

Since the pressure control is fully automatic, the crew action is reduced to setting the LANDING ELEVATION.

Note : In order to avoid pressure transients :

- *To switch from AUTO to MAN operation :*
 1. *Turn the MAN RATE knob to MAN position.*
 2. *Select MAN mode by using the CAB PRESS MODE SEL pb.*
 3. *Operate the MAN RATE knob as required to set cabin rate.*
- *To switch from MAN to AUTO operation :*
 1. *Disengage MAN mode by using the CAB PRESS MODE SEL pb.*
 2. *Turn the MAN RATE knob smoothly to NORM position.*

TAKE-OFF

Before take-off, both bleed valves are selected ON or OFF according to engine operating instructions. The regulation will start after take-off providing the bleed valves are ON.

IN-FLIGHT CONTROL

The controller computes a theoretical cabin altitude function of :

- Landing elevation selected.
- T.O. elevation memorized.
- Cabin pressure.
- Aircraft altitude.

and adjusts cabin rate of climb to match actual cabin altitude with this computed altitude or the landing elevation whichever is higher.

Note : If a failure occurs after TO and the crew decides before reaching 3500 ft above departure airfield elevation to return to that same airport, the system memorises the T.O. altitude and no crew action will be needed.

The extreme values for cabin rate of change are :

- + 550 ft/mn during cabin climb up to $Z_a = 20\ 000$ ft.
- + 620 ft/mn during cabin climb above $Z_a = 20\ 000$ ft.
- 400 ft/mn during cabin normal descent.
- 500 ft/mn during cabin rapid descent (DESCENT RATE pb selected FAST).



AR 72
F.C.O.M.

PROCEDURES AND TECHNIQUES

AIR

2.02.03

P 4

001

DEC 94

DEPRESSURIZATION

Before landing, to avoid a cabin pressure bump when touching down, the cabin altitude is automatically maintained at selected landing elevation minus 300 ft.

After touch down (landing gear absorber compressed), a depressurization signal is received by the controller. The cabin rate of depressurization is controlled at + 550 ft/mn up to the full opening of the outflow valves.

REFERENCE CABIN ALTITUDE CURVE

ZCTH (Ft) x 1000

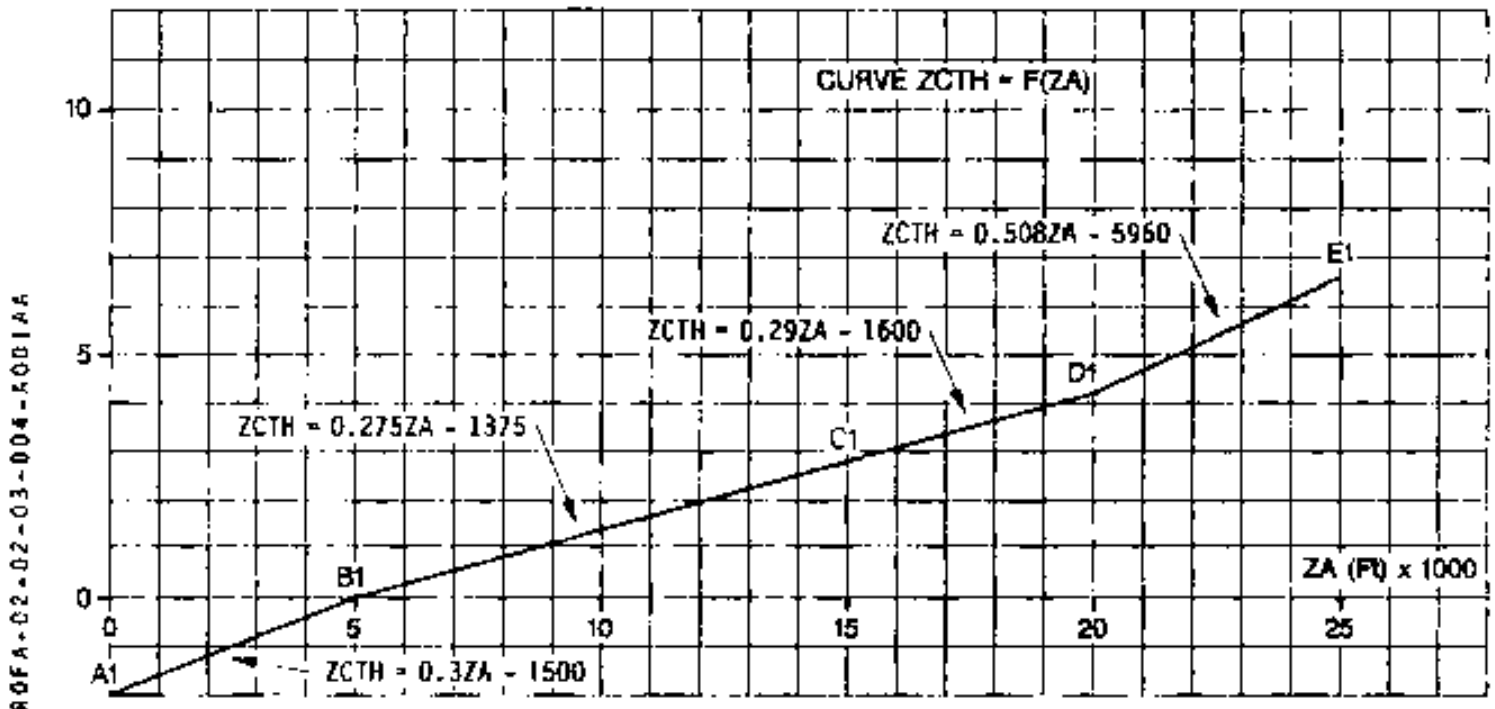

	PROCEDURES AND TECHNIQUES AFCS	2.02.04		
		P 1	001	
				JUN 96

GENERAL

The ATR 72 is equipped with a digital SPERRY AUTOPILOT/FLIGHT DIRECTOR with advanced control laws. Systematic use of AP/FD is highly recommended in order to :

- Increase the accuracy of guidance and tracking in all weather conditions, from early climb after take off down to landing minima.
- Provide increased passenger comfort through SMOOTH AND REPEATABLE altitude and heading changes in all atmospheric conditions.
- Reduce crew workload and increase safety.

MAIN RULES OF USE

- AP and YD cannot be engaged on ground : any attempt to do it will result in the message « NO ENGAGEMENT ON GROUND » being displayed on ADU.
- FD is available on ground as soon as DC normal buses are powered, but FD bars are in sight only if :
 - One upper mode is ACTIVE on each axis (GREEN indications on ADU and EADI)
 - FD ON/OFF switch (on Pilot and Co-pilot's panels) is ON.

Note : - FD ON/OFF switch acts only on FD DISPLAY and allows selection of FD bars out of view, without de-selecting the active mode which remains available on the other EADI.

- .. *STBY push button on AP control panel de-activates all active and armed upper modes, which causes both FD bars to disappear on both EADI.*

	PROCEDURES AND TECHNIQUES AFCS	2.02.04		
		P 2	001	
				DEC 94

AA

- There is only one AP/FD computer, but the references to be flown may be coupled to left or right side by the CPL push button. Changes of CPL side whilst coupled to VOR or LOC will drop the lateral mode.

- Modes are engaged (GREEN indication on ADU and EADI) or armed (WHITE indication on ADU or EADI) by action on the relevant push button on AFCS control panel. ADU or EADI must be monitored for actual state of modes of AP/FD : a second push on the push button associated to a mode already engaged (or armed) disengages (or disarms) it.

- ALT SEL mode is automatically armed as soon as the flight path is directed towards the altitude dialed on ADU by the ALT rotary selector. All altitudes clearance given by ATC should systematically be set on ADU to ensure automatic level off when AP is engaged (or FD followed in case of manual flight).

Note : If altimeter setting is changed on the coupled side after ALT mode has been engaged, the AP will automatically bring back the aircraft to the altitude selected on ADU, based on the new baro setting.

R

- When HDG changes are performed with the HDG mode active, maximum bank angle may be chosen by cycling the BANK push button for HI (27°) or LO (15°) limit as appropriate.

This allows AFCS maneuvering in all conditions, including early climb after take-off or go around where speed may be down to V_{min} LO BANK (V_{min} LB).

	PROCEDURES AND TECHNIQUES AFCS	2.02.04		
		P 3	280	
				JUN 97

AA

Note : Following engine failure, auto-pilot may be used for climb at V_2 min AFTER LATERAL TRIMMING HAS BEEN ACHIEVED.

- **LATERAL TRIM with auto-pilot engaged**
 - Trim on ROLL axis is inhibited when there is no RETRIM ROLL request set on ADU.
 - As there is no auto-trim on both ROLL and YAW axis, it is the pilot duty to maintain lateral trimming when speed or power is substantially changed.
This is primarily achieved by maintaining the slip indicator (ball) centered by use of rudder trim.
 - The autopilot will indicate only roll out of trim.
 - If "RETRIM ROLL L(R) WING DN" is displayed on ADU and if the roll trim position is at a normal setting ($< + 1$ dot) :
Check and trim first if necessary yaw axis using small input technique.
Monitor the effect on ball for at least 10 seconds before any additional input.
If ADU message is still active when the ball is centered : trim roll axis, monitoring carefully direction and duration of roll trim input.
However, trim input in the incorrect direction is inhibited.
 - If excessive lateral trim is required or AILERON MISTRIM message is displayed on ADU :
 - DISCONNECT AP. HOLDING FIRMLY THE CONTROLS.
 - FLY MANUALLY PRIOR TO ADJUSTING LATERAL TRIMS.
 - The auto pilot may be reengaged following adjustment of the lateral trims.

- **AUTO PILOT/YD DISCONNECT**

Auto pilot may be disconnected by :

- QUICK DISCONNECT on each control column,
- AP engage push button on AFCS panel,
- GA mode activation.
- NORM or STBY pitch trim sw activation,
- Stall warning,
- Pilot's force on the control column (pitch axis) over 10 daN (22 lb).

Yaw Damper and consequently AP, may be disconnected by :

- YD engage push button on AFCS panel,
- Pilot input on rudder of 30 daN/66 lbs or more,
- At touch down when landing.

CAUTION : Overriding the Autopilot on roll axis will not lead to A/P disconnect.

The QUICK DISCONNECT push button is recommended for all normal AP disengagement as it leaves the YD operating.

A second push on the QUICK DISCONNECT pb will also cancel both audio and visual AUTO PILOT OFF warnings.

 ATR 72 F.C.O.M.	PROCEDURES AND TECHNIQUES AFCS	2.02.04		
		P 4	001	
				DEC 96

AA

Note : – Function of AP/YD are monitored on three axis.

When a monitor failure is detected, the AP/YD disengages and failure message are displayed on ADU. (AFCS invalid or AP invalid). When these CAUTION messages are cleared by the pilot (within 45 seconds), the AP computer attempts a « monitor recovery » in order to reset itself to a valid configuration. When the AP computer power up test is completed, the AP/YD can once again be engaged. If the failure condition upon engagement is still present, the AFCS will again disengage. However, after the caution messages are cleared, the recovery function will not prompt another automatic AP computer power up. AP computer power up has to be performed, if needed, by cycling the associated C/B.

Automatic AP computer power up is inhibited if :

- AP, YD or AFCS control panel is lost.
- Pitch trim fail alert is lost.
- Any approach mode is engaged.
- Go around mode is engaged.
- LOC or BC track mode is engaged.

TYPICAL AP/FD operation

● TASK sharing

- With AP engaged, PF will select references and modes.
- With FD only (AP not engaged) PF will call for references and modes to be set by PNF.

● BEFORE TAKE OFF

- Both FD switches ON.
- First cleared altitude set on ADU.
- HDG bug checked on RWY HDG.
- HDG mode ENGAGED.
- BANK selector LO.
- IAS mode engaged with $V_2 + 5$ set on ADU.

● TAKE-OFF

- As power is increased, the vertical guidance FD bar will move up and lateral guidance FD bar remains centered as runway heading is maintained.
- R - Rotation is initiated to the recommended value ($\theta = 9^\circ$) as indicated by FD vertical guidance bar.
- As soon as gear is retracted and above 100 ft, AP may be engaged : it synchronizes on FD command and maintains HDG and IAS.
- Turn may be initiated as required using HDG sel knob.
- When acceleration altitude is reached, set climb speed on ADU by moving the pitch wheel on AFCS control panel, and set CLB power according to standard « climb sequence ». BANK selector may be switched back to HI as needed.



ATR 72
F.C.O.M.

PROCEDURES AND TECHNIQUES

2.02.04

P 5

001

AFCS

JUL 98

AA

- CLIMB

Use IAS with climb speed (or VS) with associated target values set by pitch wheel. IAS mode should be preferred to VS mode, unless a vertical speed constraint is given by ATC.

Note : If airspeed is not monitored during climb and VS mode is engaged with a rate exceeding the aircraft performance the airspeed will continuously decrease : AP will disengage automatically when stall alert is activated.

CAUTION : When VS mode is used, monitor airspeed carefully.

- LEVEL OFF

- Level off is automatic when reaching the selected altitude.
- Power must be adjusted to the new condition.

- RESUME CLIMB OR DESCENT

- First, the new cleared altitude must be set on ADU.
- For descent, engage IAS or VS mode.
- For climb, engage preferably IAS mode.
- In both cases, adjust power as necessary.

	PROCEDURES AND TECHNIQUES AFCS	2.02.04		
		P 6	001	
				DEC 96

AB

● NAVIGATION

R HDG and NAV mode for VOR approach are used as required (Refer to FCOM 1.04.40)

Notes : – Accuracy of VOR indication is significantly improved when there is a DME associated to the VOR.

R Accuracy decreases if NAV VOR is engaged in HOLD mode.
The new CRS selection required over a VOR station should only be made when the ADU/EADI indicates VOR*.

● ILS approach mode

Before approach

- Set approach course on CRS selector and tune ILS frequency
- Use HDG mode to set intercept heading as appropriate
- Arm both LOC and GS by punching APP pb on AFCS panel

Notes : – LOC beam capture must be started (LOC * green on both EADI and ADU) before GS capture can take place.

- LOC beam capture may lead to one initial overshoot when the capture conditions are severe (Intercept Heading = RWY HDG \pm 90°, high IAS, reduced distance to the ILS transmitter), but, provided the distance is at least 5 Nm at the standard instrument capture speed of 180 Kts, this initial overshoot will be followed by an asymptotic capture without further oscillation, even with a 90° intercept angle.
- During LOC capture, the bank angle limit is raised to 30°.
- When LOC capture is started, HDG bug should be placed on RWY HDG.

	PROCEDURES AND TECHNIQUES AFCS	2.02.04		
		P 7	001	
				JUL 98

AA

- **NON PRECISION APPROACH**

Use of auto-pilot is recommended with :

- NAV mode for VOR approach (see 2-01-05 p3),
- HDG mode for ADF approach,
- VS or IAS mode for descent.

- **GO AROUND**

When reaching decision height, or missed approach point after level off at MDA, if required references are not established, a go-around must be initiated.

The following procedure is recommended :

PF	PNF
(if no contact)	- Announce minimum
- Announce "GO AROUND"	
- Depress GA pbs on PLs	
- Advance PLs to ramp	
R - Call "FLAPS one notch" and rotate to	- Retract FLAPS one notch
R GO AROUND pitch attitude	- Check NP= 100 %, adjust if necessary
R - Follow FD bars and cancel	
R AP Disconnect Alarm	
R - Accelerate to or maintain	When positive rate of climb is achieved :
R VGA (2-02-01 p4)	- Announce "Positive climb"
- Command "GEAR UP"	- Set gear up
When climb is stabilized :	
- Command "HDG/LO BANK/IAS"	- Engage HDG, BANK and IAS on AFCS panel (IAS will synchronize on actual speed)
Engage AUTO PILOT	

Note : GO AROUND mode gives (as a FD mode only):

- on pitch axis, a target attitude compatible with single engine performance.
- on roll axis, a steering command to maintain heading followed at GA engagement.

As soon as climb is firmly established, use of HDG/IAS mode (which will then be accepted by AP) is recommended.

 AR72 F.C.O.M.	PROCEDURES AND TECHNIQUES AFCS	2.02.04		
		P 8	001	
				JUN 94

AA

LEFT INTENTIONALLY BLANK

	PROCEDURES AND TECHNIQUES	2.02.05		
		P 1	001	
	ELECTRICAL SYSTEM			JUN 96

LOSS OF DC SVCE BUS

- The DC SVCE BUS is normally powered :
 - either directly by DC GPU
 - or through DC BUS 1
- It may be shed :
 - by the pilots by selecting DC SVCE and UTLY BUS OFF on the overhead panel.
 - by the cabin attendant selecting OFF the DC SVCE pb on the cabin attendant panel. In this case, no specific SHED information is provided to the pilots.
 - automatically when a load shed condition controlled by the BPCU is present.

■ **POSSIBLE CAUSES of DC SVCE BUS loss**

Faulty relays

■ **CORRECTIVE ACTIONS**

Make sure cabin attendant DC SVCE pb is not on SHED position

DC BTC RESET
 DC SVCE and UTLY BUS RESET

USE OF A WEAK DC GPU

The specification of the DC GPU for ATR 72 requires the ground unit to be able to provide a steady current of 300 to 400 Amp under 28 volts to insure correct functioning of all electrical services prior to startup.

For engine start, the GPU must be able to provide ADDITIONNAL STARTER CURRENT of 1000 Amp while keeping more than 12 volts (ie 16 KW instantaneous power).

Experience shows that many « 28 v DC » GPUs have a much lower power capability.

GROUND OPERATION WITHOUT ENGINES RUNNING

If it becomes necessary to use an under-rated DC GPU, the following procedure is recommended :

- Select DC GPU ON and check DC EXT PWR voltage on maintenance panel : with a weak GPU, voltage will be significantly below 28 volts.
- Initiate LOAD SHEDDING of following equipments as needed, in order to recover as much voltage as possible :

		LOAD SAVING
PACKS valves (both)	select OFF	1 × 2 = 2 Amp
FUEL Pumps (both)	select OFF	10 × 2 = 20 Amp
RECIRC. FANS (both)	select OFF	28.5 × 2 = 57 Amp
UPR PASS lights switch	select OFF	39 Amp
(on cabin attendant panel)		

CAUTION : IF DC EXT PWR voltage on maintenance panel still shows less than 26 v despite the full load shedding, the GPU MUST BE CONSIDERED AS COMPLETELY UNUSABLE.

- If DC EXT PWR voltage on maintenance panel is above 26 V, the DC GPU may be used to maintain aircraft batteries charge whilst using all other ground services normally (cargo door, refueling, cabin lighting, etc...)

PRIOR TO START UP FIRST ENGINE

- DC GPU select OFF
- Start first engine on aircraft batteries after applying relevant normal check-list.

LOAD SURVEY WITH WEAK BATTERY

- The DC GEN load limitations are (refer to 2.01.05) :

Time limit	Load
none	400 A
2 mn	600 A
8 s	800 A

R

- It may occur that a battery is weak especially after a stop where external DC power supply is not available and Hotel mode is not used if :
 - refueling is performed with battery switched ON
 - cargo door is operated several times
 - minimum cabin light is used extensively

In order to preserve batteries life time, it is consequently desirable to minimize time of use on ground, as far as possible.

- Immediately after starting engine 2 with a weak battery, the 600 A/2 mn DC GEN load limitation may be exceeded due to the charge current which alone may reach 300 A. In that case, automatic protection engages which may lead to :
 - DC SVCE and UTLY BUS shedding.
 - DC BTC opening (and loss of DC BUS 1).
 - DC GEN 2 isolation (and loss of DC BUS 2).
- In order to avoid this succession of disconnections, following procedure is recommended after engine 2 start :
 - Monitor DC GEN 2 load on the CAPT maintenance panel.
 - As required to stay within limits (practically to maintain DC GEN 2 load below 450 A), switch off as appropriate :
 - DC SVCE and UTLY BUS (including both recirc fans control) : ≈ 120 A.
 - LH FUEL PUMP : 10A.
 - Both recirc fans : ≈ 50A.
 - Off loaded equipment may be turned ON again as charging current decreases and consequently DC GEN load reduces.

USE OF EXTERNAL DC ELECTRICAL SYSTEM

This unit must be able to provide a steady current of 300 A plus an additional starter current of 1000 A while keeping above 12V (16 KW instantaneous power). If not refer

R page 1 : **USE OF A WEAK DC GPU.**

 ATR 72 F.C.O.M.	PROCEDURES AND TECHNIQUES FLIGHT CONTROLS	2.02.06		
		P 1	001	
				JUN 97

ATR 72 is equipped with classical mechanical primary flight controls on all three axis.
The following peculiarities must be highlighted :

R

 AJR72 F.C.O.M.	PROCEDURES AND TECHNIQUES FLIGHT CONTROLS	2.02.06		
		P 2	020	
				DEC 97

AA

PITCH : Both elevators are connected through a pitch uncoupling device, in order to leave sufficient controllability in case of mechanical jamming of one control surface.

Activation of this device :

- requires heavy forces (52 daN/114 lbs) to be applied to the control columns, which minimizes the risk of untimely disconnection.
- indicated to the crew through the red warning « PITCH DISCONNECT ».
- allows the flight to be safely achieved : refer to procedures following failures.

Note 1 : *WHEN PITCH DISCONNECT takes place WITHOUT REAL JAMMING, speed has to be limited to 180 kt and bank angle to 30° until flaps extension to avoid overstressing the stabilizer.*

Note 2 : *The TWO sticks must be held once the aircraft is landed.*

Once disconnected both elevators can be reconnected by applying the following procedure:

BOTH ELEVATORS RECONNECTION ON GROUND

Conditions:

R - Aircraft on ground and electrically powered.

- Both elevators disconnected.
- Red PITCH DISCONNECT alarm illuminated steady on CAP.

Procedure:

- Engage GUST LOCK and check both columns are locked.
- Depress and hold ELEV CLUTCH guarded pb (see 1.09.30) until PITCH DISCONNECT flashes red on CAP.
- Release ELEV CLUTCH pb. After a few seconds, PITCH DISCONNECT extinguishes on CAP.
- Check both columns are effectively coupled.

	PROCEDURES AND TECHNIQUES FLIGHT CONTROLS	2.02.06		
		P 3	100	
				JUL 00

ROLL :

- **Aileron spring tabs :**

Flight controls are connected to the ailerons through the spring tabs, therefore, maintaining the flight controls to neutral on the ground would not prevent the ailerons from oscillating in case of strong tail wind (> 30 kt).

Therefore, in strong wind conditions it is recommended :

- to disengage the gust lock only when necessary before take off,
- after landing, to engage the gust lock before a turn that would expose the aircraft to a tail wind component.

If aileron lock is not available, it is easier to maintain the ailerons fully deflected.

- **Aileron trim :**

Ailerons forces trimming is obtained by shifting the zero position of the left aileron spring tab : this means that AILERON TRIM INDICATOR is only representative of the differential loading of the spring tab and not of the aileron position.

 ATR 72 F.C.O.M.	PROCEDURES AND TECHNIQUES FLIGHT CONTROLS	2.02.06		
		P 4	001	
				JUN 97

AA

YAW: The rudder incorporates several particular features.

- **The releasable centering unit (threshold cam) :**
 This threshold cam automatically synchronizes to actual rudder pedal position each time the rudder trim switch is activated.
 Therefore before take-off, rudder trim setting to zero must be made with rudder pedals in neutral position.
- **The rudder surface damper :**
 Structural protection of the rudder assembly against effect of wind gusts on ground is ensured by a rudder surface damper, which is designed to prevent excessive speed of deviations of the rudder surface.
 When taxiing with strong winds on ground, very large rudder forces would be required to try to control the rudder surface: this is not necessary and rudder should be left « floating » with the apparent wind as the damper will effectively prevent any structural damage.
- **The rudder trim :**
 Rudder forces trimming is obtained by shifting the zero position of the spring tab: this means that « **RUDDER TRIM INDICATIONS** » are only representative of the differential loading of the spring tab, **AND NOT OF THE RUDDER POSITION.**
Note : As speed increases, rudder trim deviation as large as 3 dots on the right may be noted while rudder surface remains substantially at neutral.
- **The yaw damper :**
 Yaw damper function is provided through the **YAW CHANNEL** of the AP and should always be engaged in flight to improve passenger comfort.

In order to let the rudder axis free for pilot inputs (engine failure, ground control after landing etc...) without the need to disconnect the **YAW DAMPER**, a force sensor has been implemented and any pilot force of more than 30 daN/66 lbs applied on rudder will cause the YD to disengage.

	PROCEDURES AND TECHNIQUES FUEL SYSTEM	2.02.07		
		P 1	001	
				JUL 98

AA

FUEL CROSSFEED

Allows feeding of 1 or 2 engines from either side tank, especially for fuel balancing.

PROCEDURE :

Intended tank to be used :

PUMP RUN and OFF LT extinguished
 X FEED IN LINE

Opposite tank :

PUMP OFF

R When asymmetrical feeding is completed:

R PUMPS both ON

R X FEED X LINE

R *Notes: 1. Each electrical pump is able to supply one engine in the whole flight envelope.*

R *2. When X FEED is selected « in line », both electrical pumps are forced to run (both RUN lights illuminate green) as long as associated PUMP pb is selected ON.*

CAUTION : When X FEED procedure is applied, some fuel transfer from the wing tank where the pump is running to the other wing tank (where the pump is OFF) may occur. This transfer is particularly noticeable at low power settings (X FEED in Hold mode is the worst case).

FUEL QUANTITY INDICATIONS

IN FLIGHT

Accurate readings require aircraft levelled without side slip and pitch attitude close to zero degree.

ON GROUND

Accurate readings should be made with aircraft static (not taxiing) and fuel pumps running for more than 4 minutes.

This procedure should be applied each time a comparative reading before and after flight is intended with correlation to fuel used.

COMMENTS

- Fuel quantity indications are affected by excessive longitudinal and lateral attitudes and accelerations.

R - Fuel quantity indications are affected by the level of fuel in the feed tank. With pumps running, the feed tanks are filled within a few minutes. This is the normal flight case.

	PROCEDURES AND TECHNIQUES ADVERSE WEATHER	2.02.08		
		P 1	001	
				JUL 98

AA

This chapter is divided in three parts :

- Icing,
- Cold weather operations,
- R - Operations in wind conditions.

ICING

I - GENERAL

Icing conditions are defined as follows :

- ▶ **Atmospheric icing conditions**
 Atmospheric icing conditions exist when OAT on ground and for take-off is at or below 5°C or when TAT in flight is at or below 7°C and visible moisture in the air in any form is present (such as clouds, fog with visibility of one mile or less, rain, snow sleet and ice crystals).
- R
- ▶ **Ground icing conditions**
 Ground icing conditions exist when the OAT is at or below 5°C when operating on ramps, taxiways and runways where surface snow, standing water or slush is present.
- ▶ **Regulatory requirements**
 Certification requirements defined in JAR/FAR 25 appendix C consider droplet sizes up to 50 microns in diameter. No aircraft is certified for flight in conditions with droplets larger than this diameter.

 However, dedicated flight tests have linked unique ice accretion patterns to conditions of droplet sizes up to 400 microns. Procedures have been defined in case of inadvertent encounter of severe icing.
- ▶ **Organization of this subchapter**
 It will address the following areas :
 - Operations within the certified envelope.
 - Information about severe icing beyond the certified envelope.
 - Good operating practices.

 ATR 72 F.C.O.M.	PROCEDURES AND TECHNIQUES ADVERSE WEATHER	2.02.08		
		P 2	001	
				JUN 96

AA

II – OPERATIONS WITHIN THE CERTIFIED ICING ENVELOPE

PREAMBLE

Icing conditions should never be assessed with complacency. Although the aircraft is adequately protected for most of the encountered cases, any severe icing exposure should be minimized by a correct evaluation and proper avoiding actions.

A) GENERAL

Operations in atmospheric icing conditions require SPECIAL ATTENTION since ice accretion on airframe and propellers SIGNIFICANTLY modifies their aerodynamic characteristics.

The primary considerations are as follows :

- a – Even small quantities of ice accretions, which may be difficult to detect visually, may be sufficient to affect the aerodynamic efficiency of an airfoil. For this reason, **ALL ANTI ICING PROCEDURES and SPEED LIMITATIONS MUST BE COMPLIED WITH** as soon as and as long as **ICING CONDITIONS** are met and even before ice accretion actually takes place.
- b – Main effects of ice accretion on airfoils are :
 - Maximum achievable LIFT is reduced.
 - For a given angle of attack, LESS LIFT and MORE DRAG are generated. In order to maintain a **SAFE MARGIN AGAINST STALL**, which will occur at a higher speed when ice accretion spoils the airfoil :
 - the stall warning threshold must be reset to a lower value of angle of attack,
 - the stick pusher activation threshold is lowered accordingly.

These lowered thresholds are effective when switching horns anti icing ON and illuminating the ICING AOA green caption.

R

THE LOWER AOA OF STALL WARNING THRESHOLD AND THE LOWER STICK PUSHER ACTIVATION THRESHOLD DEFINED FOR ICING REMAIN ACTIVE AS LONG AS THE « ICING AOA » CAPTION IS ILLUMINATED.

- Accordingly, the minimum maneuver / operating speeds defined for normal (no icing) conditions (see FCOM 2.02.01) **MUST BE INCREASED.** These new minimum speeds are called « **MINIMUM ICING SPEEDS** ». They are defined further in paragraph B.

AB

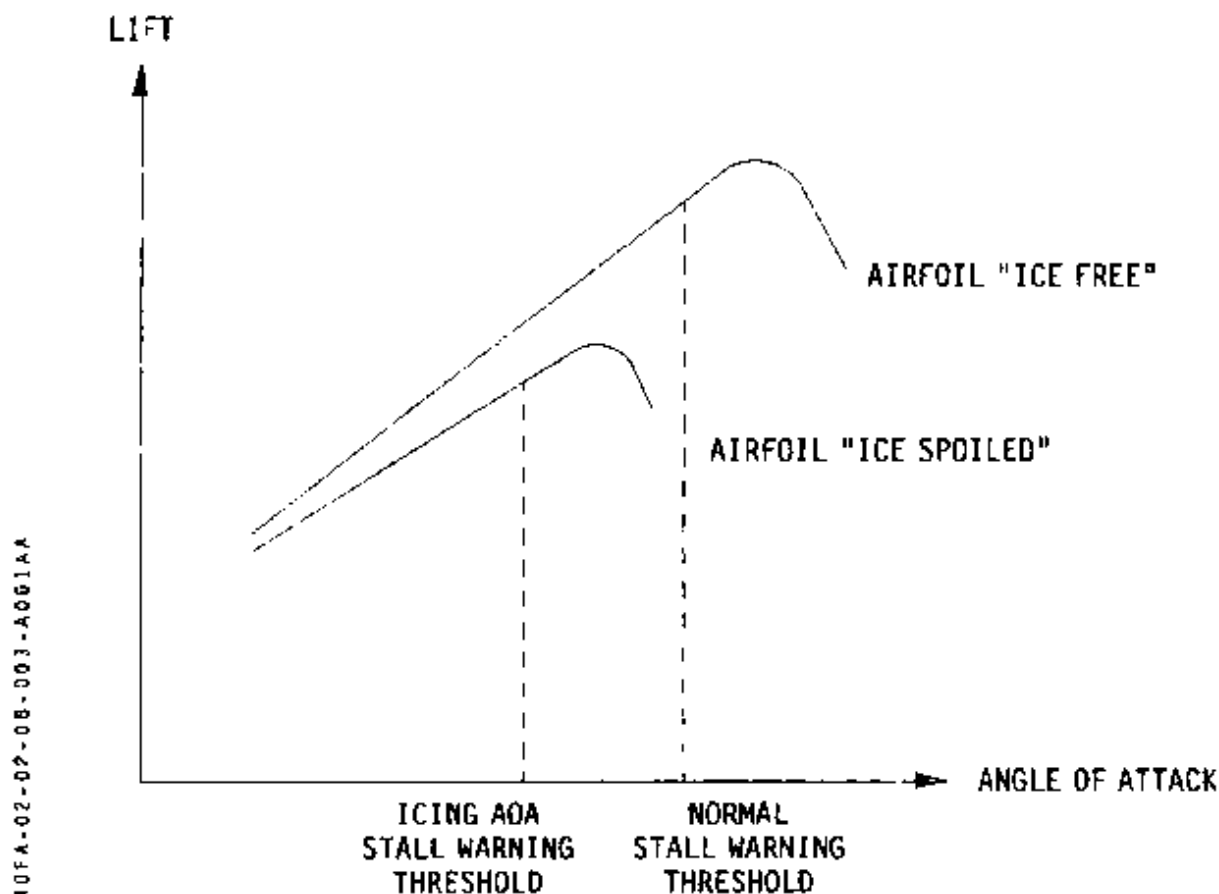

#0FA-02-07-08-003-A061AA

- c – Anti-ice and de-ice-systems are provided. The AIRFRAME de-icing will LIMIT the amount of ice adhering to the airfoil but CANNOT eliminate ALL ICE ACCRETION because of the unprotected elements on the leading edges and the continuous accretion between two consecutive boot cycles. RESIDUAL ICE must be considered, not only during periods when accretion develops, but ALSO AFTER ICING CONDITIONS HAVE BEEN LEFT (continued climb above icing clouds as an example).
- d – Ice accretion may also affect the forces required to maneuver the flight controls. On the ATR 72 :
- Rudder forces are not affected.
 - Aileron forces are some what INCREASED when ice accretion develops, but remain otherwise in the conventional sense.
 - Pitch forces are not affected in flaps 0°, 15° and 30°.

	PROCEDURES AND TECHNIQUES ADVERSE WEATHER	2.02.08		
		P 4	500	
				JUN 97

AA

B) MINIMUM ICING SPEEDS

- The minimum maneuver/operating speeds defined for normal conditions (2.02.01) **MUST BE INCREASED** and the new value enforced whenever

ICE ACCRETION : is possible (Flight in atmospheric icing conditions),
 or exists (ice accretion developing or residual ice).

They are defined by the following table where VSR is the non affected 1G stall speed as given in 2.01.03.

FLAPS	VmH8	VmLB
0	1.46 VSR	1.40 VSR
15	1.35 VSR	1.22 VSR T/O - 2d segment
		1.27 VSR Final Take-Off
		1.30 VSR EN ROUTE
		1.24 VSR GO AROUND
30	1.32 VSR	

CAUTION : For obstacle clearance, the en-route configuration with engine failure is FLAPS 15° at a minimum speed of 1.30 VSR if ice accretion is observed.

- Relevant MINIMUM ICING SPEEDS are also given directly in the operating data booklet for all weights.

	PROCEDURES AND TECHNIQUES ADVERSE WEATHER	2.02.08		
		P 5	001	
				DEC 95

R C) PERFORMANCES IMPLICATION

The drag increase associated with ice accretion will induce a decrease in performance which must be taken into consideration.

The dominant effects are :

- ▷ Twin ENGINE ceiling is reduced (see FCOM 3.04)
- ▷ SINGLE ENGINE ceiling is reduced (see FCOM 3.09)
However, on the ATR 72, the performance loss may be minimized by using FLAPS 15°.

This is the reason why, IF OBSTACLE LIMITATIONS EXISTS, whenever MINIMUM ICING SPEEDS ARE IMPOSED (ICING AOA light illuminated) SINGLE ENGINE CRITICAL PHASES (FINAL TAKE OFF CLIMB, EN ROUTE, DRIFT DOWN PROCEDURES) MUST BE PERFORMED WITH FLAPS 15 CONFIGURATION.

Note : If no obstacle limitation exist, Flaps 0 may be used for single engine cruise in order to benefit from a higher cruise speed but at a lower cruising altitude.

▷ BEST CLIMB GRADIENT SPEED

It is essential to understand that the MINIMUM ICING SPEEDS must be observed to maintain a minimum safe margin against stall BUT ALSO TO MINIMIZE PERFORMANCE LOSSES : the MINIMUM ICING SPEED is always close to BEST CLIMB GRADIENT SPEED with ice accretion. ANY ATTEMPT TO REDUCE BELOW MINIMUM ICING SPEED can only give a LOSS of steady climbing performance.

Note : All performance data given for ICING CONDITIONS were derived from flight test measurements performed with ICE SHAPES representative of the worst icing cases considered by certification and applicable losses of propeller efficiency.

Because of variability of REAL ICING, climb and cruise performances published for icing conditions MUST BE regarded as operational information only.

D) DETECTION

- Ice accretion may be primarily detected by observing the Icing Evidence Probe (IEP). At night, this IEP is automatically illuminated when NAV lights are selected ON. Ice accretion may also be detected on windshield, airframe (leading edges), wipers and side windows.

The ice detector may help the crew to recognize the beginning of ice accretion (ICING light steady - MC + sc).

- Clear ice accretion may be difficult to detect. If clear ice is suspected, temporary selection of airframe boots is recommended as the action of boots will shatter the ice and make its observation much more obvious.

	PROCEDURES AND TECHNIQUES ADVERSE WEATHER	2.02.08		
		P 6	500	
				JUL 01

AA

E) PROCEDURES IN ATMOSPHERIC ICING CONDITIONS

During operations with AP ON during climb and descent, vertical speed mode should not be used unless the airspeed is carefully monitored.

The suggested procedure is to use IAS mode with a speed selected which is equal to or greater than the appropriate minimum speed (V_{MLB} or V_{MHB} in accordance with the BANK selection on the autopilot).

CAUTION : Close attention should be paid to the appearance of an AILERON MISTRIM message flashing on the ADU: if the message appears, apply the AILERON MISTRIM procedure.

Note : Permanent heating (Probes/windshield) is Always selected ON.

▷ ENTERING ICING CONDITIONS

- ANTI ICING (PROP - HORNS - SIDE WINDOWS) ON

R *Note :* horns anti icing selection triggers the illumination of the "ICING AOA" green light, and lowers the AOA stall warning threshold.

- MODE SEL Confirm AUTO

R

• MINIMUM Maneuver/Operating ICING SPEED .. BUGGED and OBSERVED

- ICE ACCRETION MONITOR

Note : 1. These procedures are applicable TO ALL FLIGHT PHASES including take off.

	PROCEDURES AND TECHNIQUES	2.02.08		
		P 7	550	
	ADVERSE WEATHER			JUL 01

AA

▷ **AT FIRST VISUAL INDICATION OF ICE ACCRETION, AND**

R **AS LONG AS ATMOSPHERIC ICING CONDITIONS EXIST**

- R ● ANTI ICING (PROP - HORNS - SIDE WINDOWS) Confirm ON
- R ● MODE SEL Confirm AUTO
- R ● ENG DE ICING ON
- AIRFRAME DE ICING ON
- R ● **MINIMUM Maneuver/Operating ICING SPEED . . BUGGED and OBSERVED**
- BE ALERT TO SEVERE ICING DETECTION.
In case of severe icing, refer to 2.04.05.

R **Notes:** 1. *When ice accretion is visually observed, DE ICERS MUST BE SELECTED and maintained ON as long as icing conditions exist.*

2. *Ice detector may also help the crew to determine continuous periods of ice accretion as the ICING It remains illuminated as long as the ice detector senses ICE ACCUMULATING.*

The ice detector may not detect certain ice accretion form (see FCOM 1.13.20).

3. *If a noticeable performance decrease and (or) significant vibrations occur due to propeller residual icing then, in order to improve the deicing of the blades, it is recommended :*

- *To check that the MODE SEL is AUTO, or that the MAN mode is selected in accordance with SAT.*
- *To set CLs on 100 OVRD for continuous periods of not less than 5 minutes in order to benefit from an increased centrifugal effect.*

4. *If ice accretion is seen by the detector with HORNS ANTI ICING and/or AIRFRAME DE ICING still OFF, the ICING light will flash until corrective actions are taken.*

5. *Engines de-icing must be selected ON prior to airframe de-icing to take benefit of an immediate engines de-icing.
If not, engines de-icing will be effective 60 or 240 seconds later depending on MODE SEL selection.*

 ATR 72 F.C.O.M.	PROCEDURES AND TECHNIQUES ADVERSE WEATHER	2.02.08		
		P 8	050	
				JUL 01

AA

▷ **WHEN LEAVING ICING CONDITIONS**

R DE ICING and ANTI ICING may be switched OFF.

Note : Leaving DE ICING in operation UNNECESSARILY is detrimental to boots life.

The DE ICING blue light on memo panel will blink if deicers are still ON more than 5 minutes after ice detector has stopped to signal ice accretion (ICING amber light OFF).

R ▷ **WHEN THE AIRCRAFT IS VISUALLY VERIFIED CLEAR OF ICE**

R ICING AOA caption may be cancelled and normal speeds may be used.

R *Note : Experience has shown that the last part to clear is the ice evidence probe. As long as this condition is not reached, the icing speeds must be observed and the ICING AOA caption must not be cancelled.*

R

R

	PROCEDURES AND TECHNIQUES ADVERSE WEATHER	2.02.08		
		P 9	050	
				DEC 96

AA

F) TAKE OFF IN GROUND ICING CONDITIONS BUT WITHOUT ATMOSPHERIC ICING CONDITIONS

A GENERAL

- 1 – Contaminant may adhere to wheels brakes when taxiing on contaminated ramps, taxiways and runways.
- 2 – During take off, there is no contamination on wings or engines nacelles but contaminant might affect the propellers.

B PROCEDURE

For take off in ground icing conditions but without atmospheric icing conditions, the following procedure must be applied.

BEFORE TAKE OFF

PROPELLERS ANTI ICING ONLY ON

AFTER TAKE OFF

LANDING GEAR (if possible) CYCLE

PROP ANTI ICING AS RQD

- Notes :*
1. Take off may be scheduled using normal minimum $V2 = 1.13 VS$.
 2. Horns anti icing must not be selected ON to avoid lowering AOA of the stall warning threshold.
 3. Landing gear cycling after take-off with a significant layer of contaminant on the runway (slush, snow) is highly recommended to avoid brakes freezing especially if the procedure described page 18 as "special case" (brakes heating before take-off) has not been followed for any reason.

AA

G) SUMMARY

- DEFINITIONS :**
- . **ICING CONDITIONS :** See Definition page 1. There is a risk of ice accretion.
 - . **ICE ACCRETION :** Ice is building up on the airframe. ICING amber light illuminates.
 - . **RESIDUAL ICE :** Some ice is remaining on the airframe. **May be in or out of icing conditions.**

R

CONDITIONS	SYSTEMS		SPEEDS	
	1 PERMANENT 2-ANTI-ICING 3-DE ICING	NP (%)	A. NORMAL B. ICING	ICING ADA LIGHT
IN FLIGHT - NON ICING CONDITIONS - ICING CONDITIONS - ICE ACCRETION - END OF ICING CONDITIONS - NO MORE RESIDUAL ICF	ICING LIGHT			
	OFF	1	OFF	A
	OFF	1 + 2	ON	B
	ON	1 + 2 + 3	ON	B
	OFF	1	ON	B
	OFF	1	OFF	A
ON GROUND - NON ICING CONDITIONS - ICING CONDITIONS	OFF	1	OFF	A
	-	1 + 2	ON	B

	PROCEDURES AND TECHNIQUES ADVERSE WEATHER	2.02.08		
		P 11	001	
				DEC 96

R III - **SEVERE ICING**

R A) **GENERAL**

R Severe icing may result from environmental conditions outside of those for which
 R the airplane is certificated. Flight in freezing rain, freezing drizzle or mixed icing
 R conditions (supercooled liquid water and ice crystals) may result in ice build-up
 R on protected surfaces exceeding the capability of the ice protection system, or
 R may result in ice forming aft of the protected surfaces. All the ice not shed by
 R using the ice protection systems may seriously degrade the performance and
 R controllability of the airplane.

R B) **CONDITIONS OF FORMATION**

R The airplane is certificated for a range of droplet diameter, a range of icing
 R temperature and a range of water content in the icing cloud.

R If one or more of these main parameters is exceeded, the flight is performed
 R outside the certification frame.

R Three phenomena may lead to surpass the ice protection capabilities :

R 1) **Mechanical phenomenon : droplet diameter**

R The droplet diameter may be up to 3 to 30 times greater than the upper limit
 R of the certification envelope in freezing drizzle/freezing rain conditions. The
 R inertia of droplets is such that the ice may cover all the frontal surface of airfoil
 R exposed to the cloud, outside of the protected areas.

R Depending on the angle of attack of the airfoil, a ridge may form mainly on the
 R upper side of the airfoil (e.g. flaps 15) or a granular pattern may accrete on the
 R lower surface of the airfoil up to 50 % of the chord (e.g. flaps 0).

R Freezing rain and freezing drizzle conditions are found typically at low altitudes
 R with a static air temperature around -4°C (3000 ft) and associated with
 R temperature inversion.

R However, freezing drizzle conditions may be found at higher altitudes (up to
 R 15000 ft) with a static air temperature down to -18°C . They may be the
 R consequence of the turbulence effect which leads to a coalescence process of
 R small droplets into large droplets. It may be encountered on top of stratiform
 R clouds.

R 2) **Thermal phenomenon : skin temperature and/or liquid water content**

R When the flight in icing conditions is such that the total air temperature is
 R above 0°C with a static air temperature close to 0°C , droplets cannot freeze on
 R the leading edge because the skin temperature is positive, they roll along the
 R chord till they encounter a surface at a negative temperature. The leading edge
 R is free of ice but a ridge or rivelets may be formed aft of the protected areas.
 R The rivelets are oriented in the airstream direction. They accrete on the lower
 R and upper surfaces.

R This phenomenon may occur also with colder temperatures but when a large
 R amount of water is present in the cloud. The structure of the leading edge is
 R not cold enough to freeze the whole water amount and the remaining droplets

	PROCEDURES AND TECHNIQUES ADVERSE WEATHER	2.02.08		
		P 12	001	
				JUL 99

AA

3) Mixed icing condition

Mixed icing condition may be encountered in the range of temperatures -10°C/0°C. It is basically an unstable condition, it is extremely temperature dependent and it may change quite rapidly. This condition may surpass the ice protection capabilities because the aggregate of impinging ice crystal/snow and water droplet can adhere rapidly to the airframe surpassing the system capabilities to shed ice, causing significant reduction in airplane performance as in case of system failure.

C) CONSEQUENCES OF SEVERE ICE ACCRETION

The consequences of severe ice accretions are ice location dependent. If the pollution extension occurs on the lower surface of the wing, it increases the drag and the airplane speed decreases. It may lead to stall if no action is taken to recover a correct speed. If the pollution occurs first on the upper part of the wing, the drag is not affected noticeably but controllability anomalies may be encountered. Severe roll anomalies may be encountered with "flaps 15" accretions flown with flaps 0 setting. It should be emphasized that it is not the flaps 15 configuration itself that is detrimental, but the low angle of attack that may result from such a setting, especially close to VFE. This low or negative AOA increases the wing upper side exposure to large droplet impingement. This is why holding with any flaps extended is prohibited in icing conditions (except for single engine operations).

R



	PROCEDURES AND TECHNIQUES	2.02.08		
		P 13	001	
	ADVERSE WEATHER			JUL 99

AA

R **D) DETECTION**

- R - During flight, severe icing conditions that exceed those for which the airplane is certificated shall be determined by the following :

Severe icing is characterized by ice covering all or a substantial part of the unheated portion of either forward side window, possibly associated with water splashing and streaming on the windshield.

*Note : This cue is visible after a very short exposure (about 30 seconds).
At night, this pattern is put forward by the pilot's reading lights oriented towards the side window.*

R and / or

Unexpected decrease in speed or rate of climb

R and / or

R The following secondary indications :

- . Unusually extensive ice accreted on the airframe in areas not normally observed to collect ice.
- . Accumulation of ice on the lower surface of the wing aft of the protected areas.
- . Accumulation of ice on the propeller spinner farther aft than normally observed.

- R - The following weather conditions may be conducive to severe in-flight icing :
- . Visible rain at temperatures close to 0°C ambient air temperature (SAT).
 - . Droplets that splash or splatter on impact at temperature close to 0°C ambient air temperature (SAT).

- The occurrence of rain when SAT is below freezing temperature should always trigger the alertness of the crew.

EXIT THE SEVERE ICING ENVIRONMENT

There are no regulatory requirements to certify an aircraft beyond JAR/FAR 25 Appendix C. However, in case of inadvertent encounter with such conditions "severe icing" procedure must be applied (refer to 2.04.05).

	PROCEDURES AND TECHNIQUES ADVERSE WEATHER	2.02.08		
		P 14	001	
				DEC 96

4A

LEFT INTENTIONALLY BLANK

	PROCEDURES AND TECHNIQUES	2.02.08		
		P 15	001	
	ADVERSE WEATHER			JUL 99

AA

IV - GOOD OPERATING PRACTICES

Aircraft certification requirements describe the icing conditions likely to be encountered in commercial aviation. However, as demonstrated by experience, icing remains one of the major causes of incidents and accidents, and good airmanship prohibit any complacency in this area.

The following basic rules should therefore be applied :

- ▶ Know as much about your operating environment as you can.
Carefully review weather packages for Pilot reports of icing conditions, tops reports, temperatures aloft forecasts and forecasts of icing, freezing drizzle and freezing rain. Monitor both Total Air Temperature and Static Air Temperature during climb and while en route. Use the weather radar. Areas of precipitation which will paint on the radar will be of sufficient droplet size to produce freezing rain when encountered in freezing temperatures or on a cold soaked aircraft.
- ▶ Marginal freezing temperatures and icing conditions should create a heightened state of awareness. Remember, severe ice can still be incurred at temperatures down to approximately - 18° C, at high altitude.
- R ▶ Be alert to severe icing cues defined pages 12/13.
- R ▶ When severe icing is encountered, take appropriate steps to leave the conditions. Since these unique conditions are usually small in area and associated with very specific temperatures conditions, a change in altitude of just a couple thousand feet may place you in a totally different environment.
- ▶ Make reports to ATC and Company.
There is no better operational tool available today than first hand reports of these conditions. Remember that because these are localized areas and extremely temperature dependent, another aircraft passing through the same area at a different airspeed may experience different conditions. For example, a laboratory test showed for a specific, yet normal condition, rime ice up to about 150 kt, mixed ice as speed was increased to about 200 kt, glaze ice between 200 and 360 kt, and no accretion above 360 kt.

Note : Reporting of icing conditions as defined in the FAA's Airman's information Manual (AIM) :

Trace : Ice becomes perceptible. Rate of accumulation is slightly greater than the rate of sublimation. It is not hazardous even though de-icing/anti-icing equipment is not utilized unless encountered for an extended period of time (over 1 hour).

Light : The rate of accumulation may create a problem if flight is prolonged in this environment (over 1 hour). Occasional use of de-icing/anti-icing equipment removes/prevents accumulation. It does not present a problem if the de-icing/anti-icing equipment is used.

Moderate : The rate of accumulation is such that even short encounters become potentially hazardous and use of de-icing/anti-icing equipment or flight diversion is necessary.

Severe : The rate of accumulation is such that de-icing/anti-icing equipment fails to reduce or control the hazard. Immediate flight diversion is necessary.

	PROCEDURES AND TECHNIQUES ADVERSE WEATHER	2.02.08		
		P 16	001	
				DEC 95

COLD WEATHER OPERATIONS

Preparation and operation of the ATR 72 following cold soak in very low temperatures requires particular precautions.

Following recommendations which complement normal operating instructions should be observed when applicable.

► PROPELLER BRAKE

Avoid immobilisation of the aircraft with propeller brake engaged if severe cold soak is expected (temperature $\leq -20^{\circ}\text{C}$ for a prolonged time).

► PRECAUTIONS AGAINST FREEZING OF COMMERCIAL WATER SUPPLIES

Water draining requirements are summarized in the following table :

CONFIGURATION			EXPOSURE TIME	WATER TANK DRAIN
AIR COND	CABIN TEMP	OAT		
ON	ABOVE 10° C	Between 0 and - 15°C	ANY	NOT REQUIRED
		Below - 15°C	1 h 15 mn	REQUIRED
OFF		Between 0° and - 7°C	1 h 30 mn	
		Between - 7° and - 15°C	0 h 45 mn	
		Below - 15°C	ANY	

after required draining, refilling should be performed 30 min before ENG START with warm water (30°C)

► EXTERIOR SAFETY INSPECTION

- . Perform normal exterior inspection.
- . Check that the following items are free of frost, ice or snow. De ice as necessary :
 - engine inlets, cowling and drains, propellers, pack inlets,
 - landing gear assemblies, landing gear doors,
 - drains, pitot and static vents, angle of attack sensors, fuel tank vents,
 - all external surfaces (fuselage, wings, tailplane, vertical and horizontal stabilizers, control surfaces).

	PROCEDURES AND TECHNIQUES ADVERSE WEATHER	2.02.08		
		P 17	001	
				JUL 01

AA

CAUTION : Wing, tailplane, vertical and horizontal stabilizers, all control surfaces and flaps should be clear of snow, frost and ice before take off.

PARTICULAR CASE : limited frost accretion on lower wing surfaces due to cold fuel remaining and high ambient humidity.

As stated in the operational requirements, no person may take off an aircraft when frost snow or ice is adhering to the wing, control surfaces or propeller of the aircraft.

FROST : frost is a light, powdery, crystalline ice which forms on the exposed surfaces of a parked aircraft when the temperature of the exposed surfaces is below freezing (while the free air temperature may be above freezing).

Frost degrades the airfoil aerodynamic characteristics. However, should the take off be conducted with frost adhering to the lower surface of the wing, check the following :

- The frost is located on the lower surface of the wing only.
- Frost thickness is limited to 2 mm.
- A visual check of the leading edge, upper surface of the wing, control surfaces and propellers is performed to make certain that those surfaces are totally cleared of ice.
- Performance decrement and procedures defined for take off in atmospheric icing conditions are applied.

► DE ICING / ANTI ICING PROCEDURE

- External de icing/anti icing will be performed as close as possible from take-off time in order not to exceed the hold over time.

Type 1 (low viscosity) or type 2/4 (high viscosity) fluids are used for these operations. The type 2/4 fluids are used for their anti icing qualities. As airflow increases the fluid is spread through the elevator gap and over the lower surface of the elevator.

Depending on the brand of the fluid and the OAT, this phenomenon may temporarily change the trim characteristics of the elevator by partially obstructing the elevator gap. This may lead to a considerable increase in control forces necessary to rotate. This effect is most pronounced when center of gravity is forward.

R

- To ensure the best possible tailplane de icing/anti icing, all along the fluid spraying, the pitchwheel must be firmly maintained on the forward stop together with the aileron gust lock engaged.
- De icing/anti icing may be performed in Hotel mode provided BLEEDS are selected OFF.

If a de icing gantry is used, both engines must be shut down. For manual propeller de icing, the engines must be shut down and air intake blanked or precaution taken not to have de icing fluid in the air intake. No propeller blade should be located at 6 o'clock position during this procedure.

 ATR 72 F.C.O.M.	PROCEDURES AND TECHNIQUES ADVERSE WEATHER	2.02.08		
		P 18	001	
				DEC 96

► **COCKPIT PREPARATION**

Perform normal cockpit preparation with the following procedures modifications :

OVBD VALVE control sw FULL CLOSE

Provided ENG 2 AIR INTAKE, both PACK INLETS are free of SNOW / FROST / ICE :

ENG 2 in Hotel mode START

Notes : (1) *Starting on aircraft batteries is possible without special precautions down to - 15°C/5° F.*

For cold soak at significantly lower temperatures, it is recommended to remove the batteries and keep them in heated storage.

(2) *When starting the engine in extremely cold conditions :*

- *start up time is slightly increased.*
- *oil pressure raising time is considerably increased : OIL LO PRESS red warning may be activated for 60 seconds.*
- *after the initial increased raising time, OIL PRESS will be higher than usual (up to 70 PSI) FOR SEVERAL MINUTES.*
- *propeller unfeathering may not occur normally. If NP does not increase correctly, revert to FEATHER position until oil temperature is above 0°C.*

(3) *PL motion above FI is only allowed when OIL TEMP is at or above 0°C : this warm up time may take up to 4 minutes when OAT is - 35° C / - 31°F.*

(4) *During cockpit preparation, both packs should be used to warm up cabin and cockpit whilst running engine 2 in Hotel mode.*
Using gust lock stop power with HI FLOW selected (together with all doors, particularly cargo, closed) is recommended for warm up with OAT below - 15°C/5°F.

(5) *Below - 15°C/5°F, several equipments (e.g. fuel flow, pressurization ind., ADU, AFCS control box) may be not working INITIALLY but should automatically recover as cabin and cockpit warm up takes place and compartment temperature rises.*

R

	PROCEDURES AND TECHNIQUES ADVERSE WEATHER	2.02.08		
		P 19	001	
				JUL 01

AA

► **TAXIING**

- The standard single engine TAXI procedure may still be used provided the friction coefficient remains at or above 0.3 (braking action medium, snowtam code 3) and nose wheel steering is not used with too large deflections.

Note : If the OAT is very low, it may be necessary any way to start up engine 1 early enough to get the necessary oil warm up time (refer to Note (3) above).

- For taxiing with the very low friction coefficients (icy taxiways, slush), it is recommended to use both engines, limit nose wheel travel and use with differential power as necessary.

SPECIAL CASE

If contaminant layer is significant enough to possibly accumulate in the brake area during ground operation, brakes disks may join due to icing during the flight, leading to possible tyres damages at subsequent landing. The following special procedure should be applied during taxi before and as close as possible to take off.

Set 18% Torque on each engine and keep taxi speed down to a "man pace" during 30 seconds using normal brakes with minimum use of nose wheel steering to ensure a symmetrical warming up of the brakes.

R

	PROCEDURES AND TECHNIQUES ADVERSE WEATHER	2.02.08		
		P 20	001	
				JUL 01

AA

► TAKE OFF

Standard take off procedures will be used with the following additions :

- . If runway is contaminated (ice, snow, slush), use the relevant performance penalties defined in the performance section 3.03.
- . Use of reverse on contaminated runways has to be limited at very low speeds to avoid contaminant projections at the level of cockpit windshield which may reduce visibility to zero (snow, slush). In atmospheric icing conditions, refer to appropriate speeds and performance penalties and add the following :
 - with very cold OAT, delay start of take off roll until oil temperature is at least 45°C (this is necessary to guarantee inlet splitter de-icing capability).

- R After the ground de icing/anti icing procedure, using type II/IV fluids, higher than normal stick forces may be encountered. These control input forces may be more than twice the normal take off force. This should not be interpreted as a 'pitch jam' leading to an unnecessary abort decision above V1. Although not systematic, this phenomenon should be anticipated and discussed during pre-take off briefing each time de icing/anti icing procedures are performed. These increased pitch forces are strictly limited to the rotation phase and disappear after take off.
- R In very exceptional circumstances, because of increased rotation forces, the pilot can consider that take off is impossible and consequently initiate an aborted take off .
- R The consequences of this decision are catered for by a specific performance penalty (Refer to AFM SUPPLEMENT chapter).

AFTER V1, BE TAKE OFF MINDED

R ► BEFORE LANDING

- R If take-off has been performed on a slush contaminated runway, this slush may seize the brakes during cruise.
- R To prevent tire damage at touch down : in final approach, after the selection of GEAR DOWN, select the ANTISKID to OFF, then pump the brakes at least 5 times and then reselect the ANTISKID to ON.

► LANDING

Same restrictions on reverse than for accelerate stop.
Apply relevant performance restrictions.

► PARKING

When OAT is below - 5 C / 23°F, particularly in wet conditions, avoid leaving the aircraft with parking brake engaged and use chocks instead whenever possible.

	PROCEDURES AND TECHNIQUES ADVERSE WEATHER	2.02.08		
		P 21	001	
				JUL 98

AA

R **OPERATIONS IN WIND CONDITIONS**

R **Landing**

R The recommended landing flap configuration is the same as the standard landing flap setting, even with strong crosswind. Large flaps extension does not impair the controllability in any manner. Moreover it minimizes the flare duration and allows a quicker speed decrease down to the taxi speed.

R **General**

R Precautions or special instructions may be necessary depending on the force and direction of the wind. The following FCOM pages deal with this subject :

R	Tail wind limit and demonstrated cross wind	2 01 03 p5
R	Final approach speed and wind factor	2 02 01 p4
R	Cat II maximum demonstrated wind	2 02 04 p8
R	Parking aircraft orientation	2 02 03 p2 and 2 03 20 p1
R	Aileron spring tabs (when equipped)	2 02 06 p3
R	Taxiing with strong wind	2 02 06 p4
R	Take off run	2 02 12 p1
R	Rejected take off	2 02 12 p2
R	Hotel mode limitation	2 03 06 p3 and 2 05 02 p4
R	Taxiing with tail wind component	2 03 09 p1
R	Ditching	2 04 05 p3
R	NAC OVHT	2 05 02 p4
R	ELEVATOR JAM	2 05 06 p5
R	PITCH DISCONNECT	2 05 06 p6
R	AILERON JAM	2 05 06 p10
R	SPOILER JAM	2 05 06 p12

	PROCEDURES AND TECHNIQUES ADVERSE WEATHER	2.02.08		
		P 22	001	
				JUL 98

AA

Windshear

This phenomenon may be defined as a notable change in wind direction and/or speed over a short distance.

Windshear can be encountered in the vicinity of thunderstorms, into rain showers (even without thunderstorms), during a frontal passage or on airports situated near large areas of water (sea breeze fronts).

Severe windshear encountered above 1000 feet, whilst unpleasant, can generally be negotiated safely. However if it is encountered below 500 feet on take off or approach/landing it is potentially dangerous.

As far as possible this phenomenon must be avoided.

Procedure at take off :

- Delay the take off. If a low level windshear is reported calculate VR, V2 at the maximum take off weight available for the day.
- When clear of obstacles accelerate as much as possible and clean up the aircraft.
- Climb at the normal climb speed.

Procedure during an approach : If a windshear is encountered,

- Initiate a normal go around procedure with **10° pitch**.
- When positively climbing at a safe altitude, retract the gear and complete the normal go around procedure.

CAUTION : The positive rate of climb must be verified on at least two instruments.

- COMMENTS :**
1. Leaving the gear down until the climb is established will allow to absorb some energy on impact, should the microburst exceed the aircraft capability to climb.
 2. Ten degrees pitch attitude is the best compromise to ensure a climbing path together with an acceptable maximum AOA.

	PROCEDURES AND TECHNIQUES	2.02.09		
		P 1	001	
	LANDING GEAR/BRAKES			JUL 99

AA

R This chapter deals with the following points :

- RUNWAY STATUS
- NORMAL TAXI
- TAXI WITH FAILURES
- EMERGENCY BRAKING

RUNWAY STATUS

The following table gives for take-off and landing the equivalent runway status corresponding to the braking action or the friction coefficient.

This runway status may be used for the computation of the performances.

BRAKING ACTION	FRICTION COEFFICIENT	EQUIVALENT RUNWAY STATUS	
		TAKE-OFF	LANDING
GOOD	0,40 and above	1	1
GOOD/MEDIUM	0,39 to 0,36	2	2
MEDIUM	0,35 to 0,30	3/6	5/6
MEDIUM/POOR	0,29 to 0,26	4	5
POOR	0,25 and below	7	7
UNRELIABLE	UNRELIABLE	8	8

EQUIVALENT RUNWAY STATUS :

- 1 : Dry runway
- 2 : Wet up to 3 mm depth
- 3 : Slush or water for depths between 3 and 6 mm
- 4 : Slush or water for depths between 6 and 13 mm
- 5 : Slush or water for depths between 3 and 13 mm
- 6 : Compact snow
- 7 : Ice
- 8 : Runway with high risk of hydroplaning

	PROCEDURES AND TECHNIQUES	2.02.09		
		P 2	001	
	LANDING GEAR/BRAKES			JUL 99

AA

R NORMAL TAXI

CAUTION : If blue hydraulic circuit is pressurized, nose wheel steering has to be switched off for towing by a ground vehicle.

- The ATR 72 is particularly easy to taxi, and even on one engine, there are no limitations to go either forward or rearward : this flexibility should be systematically used and is reflected in the standard operating procedure which assumes HOTEL MODE operation of engine 2 prior to and during passenger boarding followed by initial taxi on engine 2 only (including back track if taxi backwards required).

This procedure is highly recommended as GI power is quite sufficient on one engine only to perform all taxiing (OUT and IN) and very obviously reduces block fuel by an amount which may become VERY SIGNIFICANT on large airports.

CAUTION : Start up of engine 1 should be performed in a portion of taxi where captain workload is low enough to allow an efficient monitoring of the start up.

- Use of brakes during taxiing may be very much reduced by systematic use of a small amount of reverse when deceleration is needed.
- Radius of turn with nose wheel steering is very good and does not require any braking ON THE INNER WHEELS.

CAUTION : PIVOTING (Sharp turns) UPON A LANDING GEAR WITH FULLY BRAKED WHEELS IS NOT ALLOWED, except in emergency.

TAXI WITH FAILURES

TAXI WITH NOSE WHEEL STEERING OFF (or without blue HYD pressure)

- Obviously SINGLE ENGINE TAXI is no more possible
- Taxiing remains very easy with both engines operating EEC ON : directional control is achieved primarily with differential power on engines, possibly augmented by use of differential braking.
- Avoid sharp turns : turn radius without nose wheel steering should be limited to about half turn radius with nose wheel steering.

TAXI WITH EEC OFF

On ground EEC off, engine response is somewhat degraded. Nevertheless, as long as at least one engine is maintained at or below GI, the corresponding NP should remain high enough to keep associated ACW GEN available and thus maintain both HYD pumps.

CAUTION : When taxiing with both EEC OFF, AVOID pushing both PL above GI to avoid transient loss of ACW and MAIN HYD PUMPS.

Note : NOSE WHEEL steering remains available in all cases together with STBY braking, through DC AUX pump.

	PROCEDURES AND TECHNIQUES LANDING GEAR/BRAKES	2.02.09		
		P 3	001	
				JUL 99

AA

EMERGENCY BRAKING

- Emergency braking has been made operationally easier by design of the parking brake lever which incorporates an "EMER BRAKE" notch : when the parking brake lever is set in this notch, the regulator delivers a limited pressure which :
 - allows the use of EMER BRAKING for abort take-off at max V1 or at touch down for landings after GREEN pressure has been completely lost.
 - provides repeatable, smooth deceleration whilst minimizing the risk of blown up tires.

CAUTION : Use of EMER BRAKE beyond the EMER BRAKE NOTCH ABOVE 60 Kts MUST BE AVOIDED TO PREVENT WHEELS LOCK UP AND DAMAGES TO WHEELS AND TIRES.
 BELOW 60 Kts, a SMALL further travel (~ 1 cm) IS AVAILABLE WITHOUT RISKS OF DAMAGE WHEN MAXIMUM STOPPING PERFORMANCE IS REQUIRED.

- A deflated tire is not easily noticeable from the cockpit : NO TAKE OFF should be started after EMER BRAKE has been used at speeds in excess of a maximum taxiing speed of 20 Kt without prior visual inspection of the main landing gear tires.

NORMAL TAKE-OFF

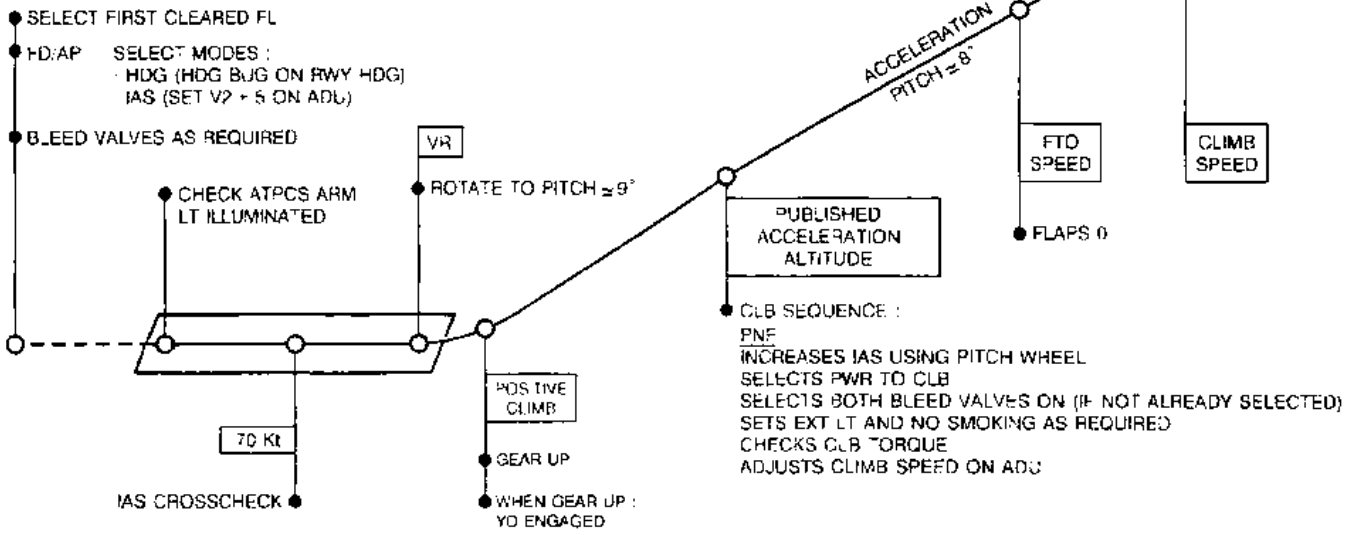
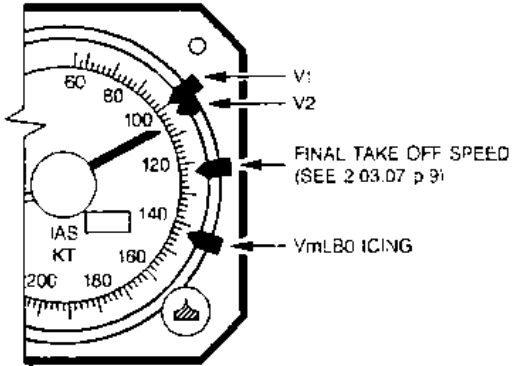

A	 ATR 72 F.C.O.M.	
	PROCEDURES AND TECHNIQUES	
FLIGHT PATTERNS		
	P 1	2.02.10
	080	
	JUL 98	

R D F A - 0 2 - 0 2 - 1 0 - 0 0 0 4 0 0 1 4 6 R R R R R R R R R R R R R R R R

ENGINE FLAME OUT AFTER V1

ENGINE OPERATION AT RTO THRUST IS LIMITED TO 10 MINUTES

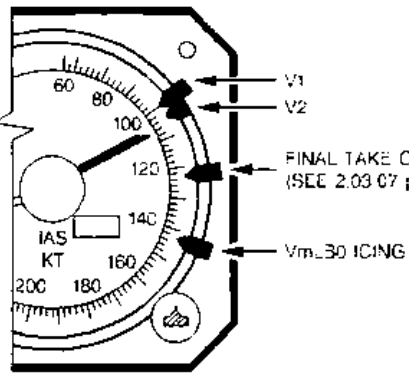

SAME PROCEDURE WITH $\phi = 15^\circ$ MAX (BANK LO IF FO/AP ENGAGED)

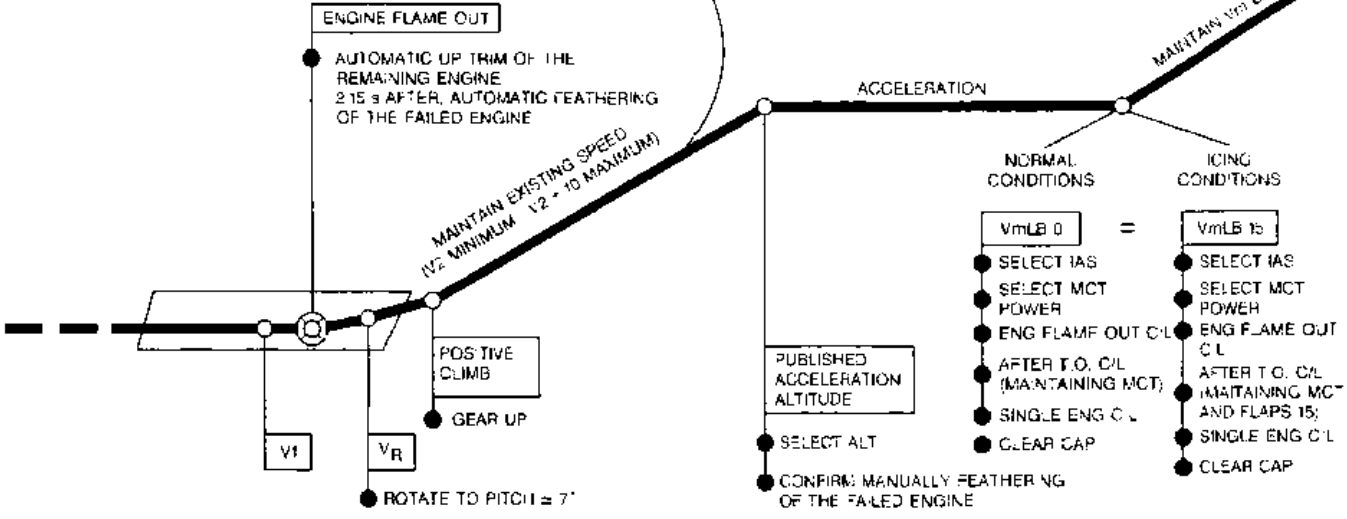

		PROCEDURES AND TECHNIQUES	
P 2	001	2.02.10	
JUL 98			

ENGINE FIRE AFTER V1

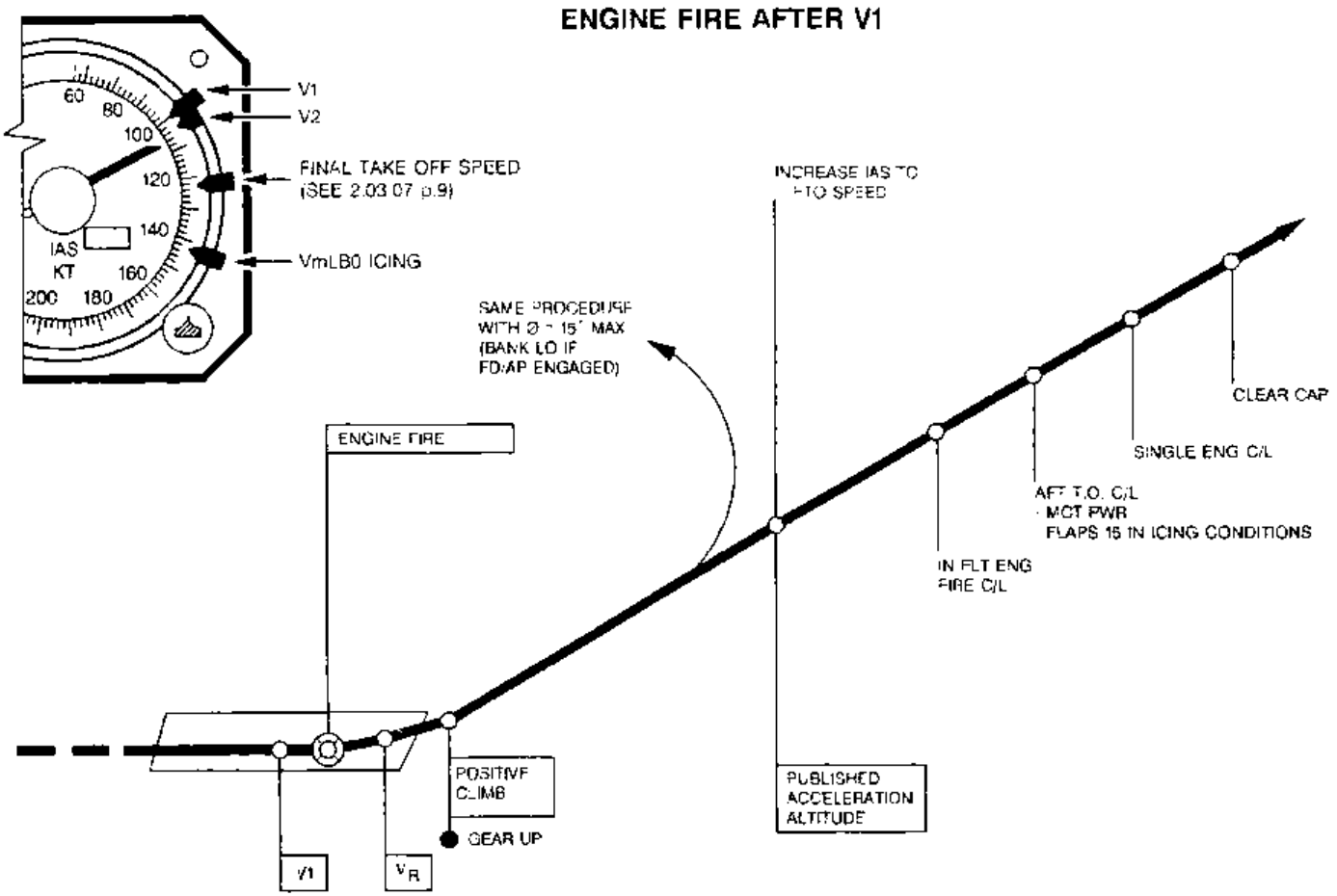

A	 ATR 72 F.C.O.M.	
	PROCEDURES AND TECHNIQUES	
FLIGHT PATTERNS		
	P 3	2.02.10
	001	
	JUL 98	



STANDARD APPROACH PERFORMED MANUALLY OR WITH AP ENGAGED ON A STABILIZED FINAL SLOPE OF ABOUT 3°

NP	DECLERATION HEIGHT
B2%	(IAS x 10) Ft

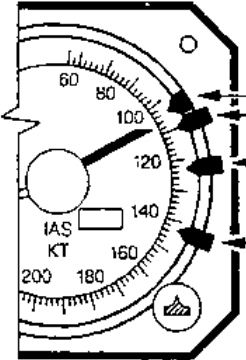
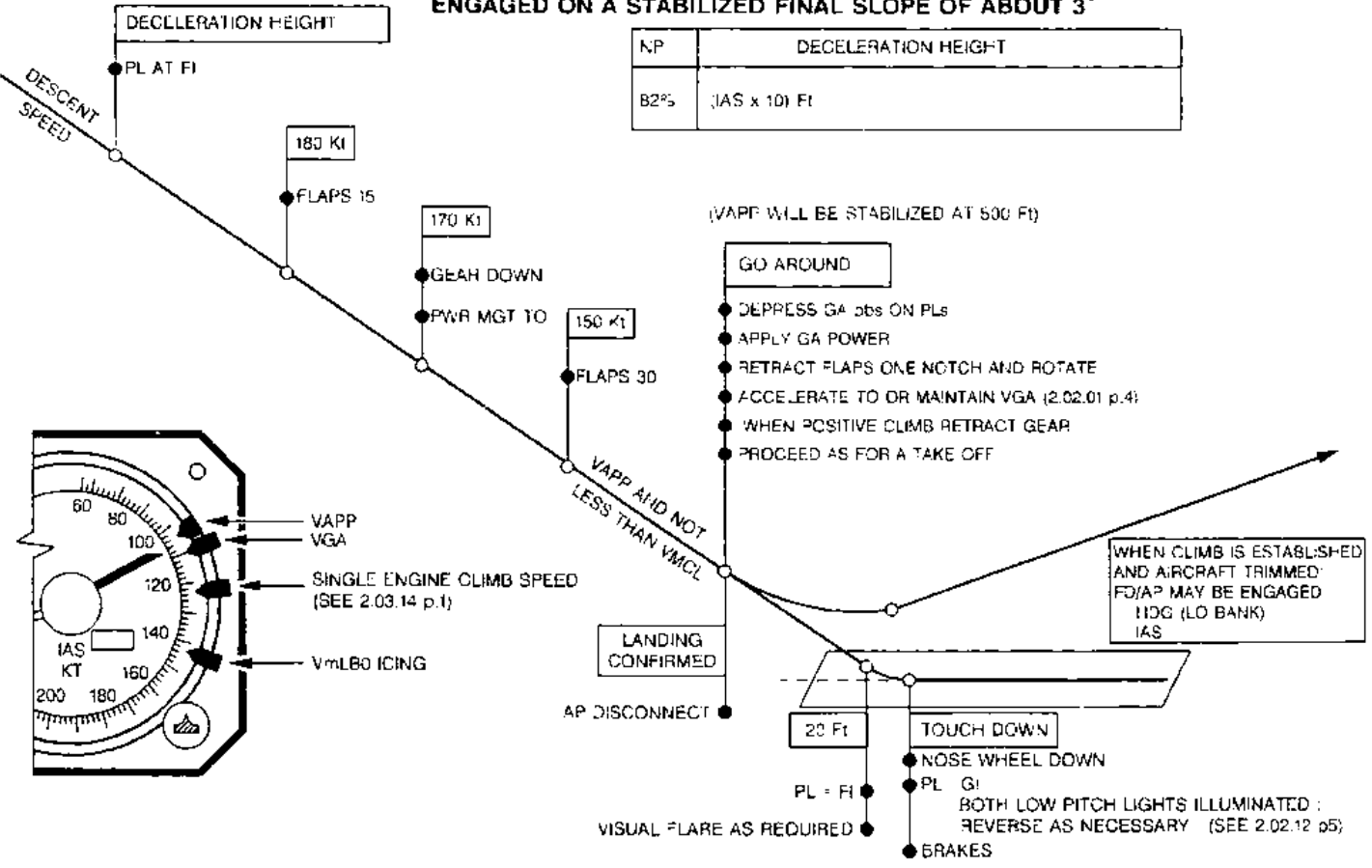

(VAPP WILL BE STABILIZED AT 500 Ft)

GO AROUND

- DEPRESS GA obs ON PLs
- APPLY GA POWER
- RETRACT FLAPS ONE NOTCH AND ROTATE
- ACCELERATE TO OR MAINTAIN VGA (2.02.01 p.4)
- WHEN POSITIVE CLIMB RETRACT GEAR
- PROCEED AS FOR A TAKE OFF

WHEN CLIMB IS ESTABLISHED AND AIRCRAFT TRIMMED FD/AP MAY BE ENGAGED HDG (LO BANK) IAS

LANDING CONFIRMED

AP DISCONNECT

TOUCH DOWN

- NOSE WHEEL DOWN
- PL GI
- BOTH LOW PITCH LIGHTS ILLUMINATED : REVERSE AS NECESSARY (SEE 2.02.12 p5)
- BRAKES

2072
FC.O.M.

PROCEDURES AND TECHNIQUES

FLIGHT PATTERNS

	P 4	220	2.02.10
		JUL 98	

XXXXXXXXXXXX

XXXXXXXXXXXX

3

10FL-17-02-10-005-A260-A

SINGLE ENGINE APPROACH AND GO AROUND

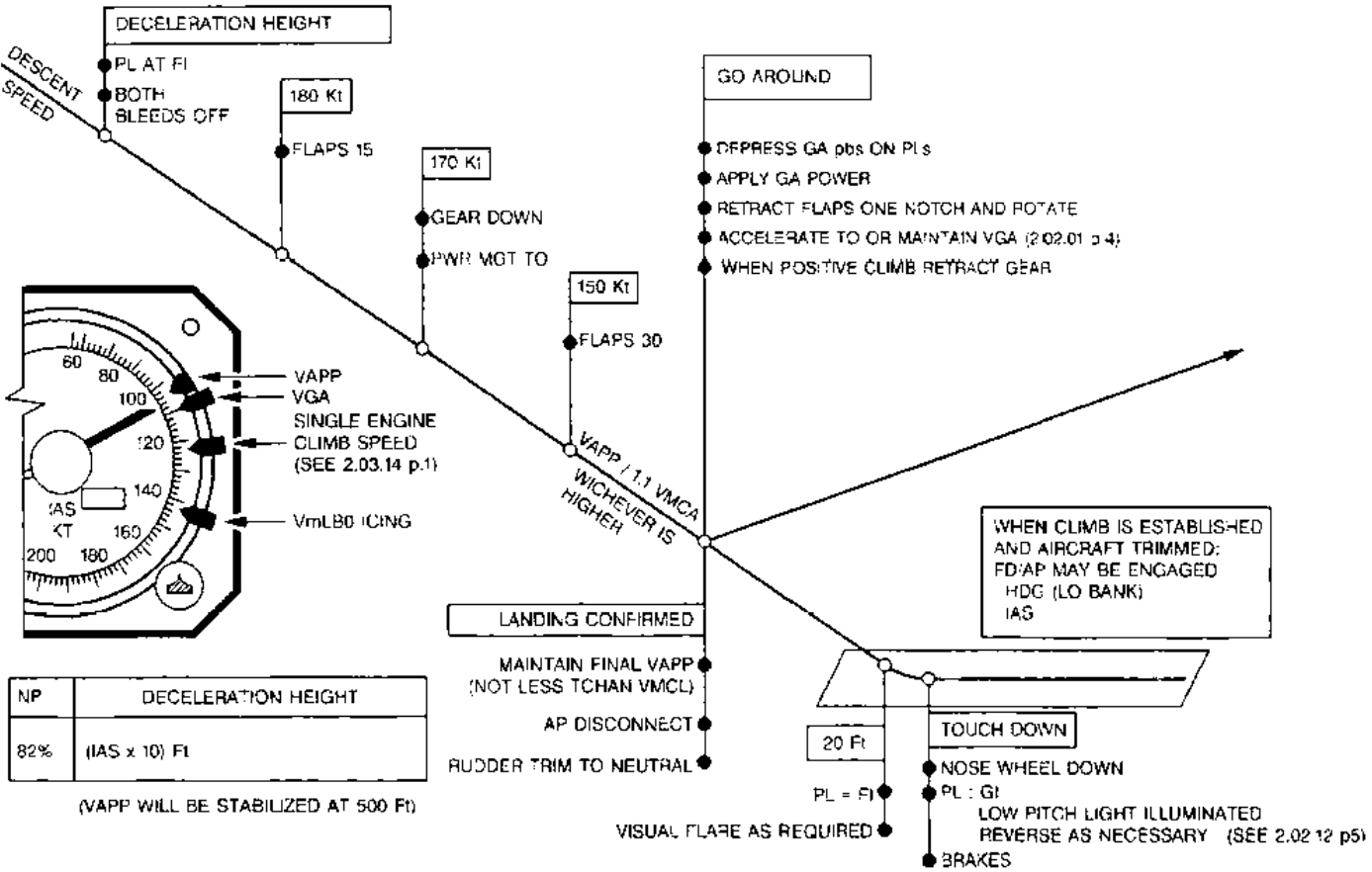

 ATR 72 F.C.O.M.	PROCEDURES AND TECHNIQUES	
	P 5	2.02.10
	280	
	JUL 98	

STABILIZED VISUAL APPROACH

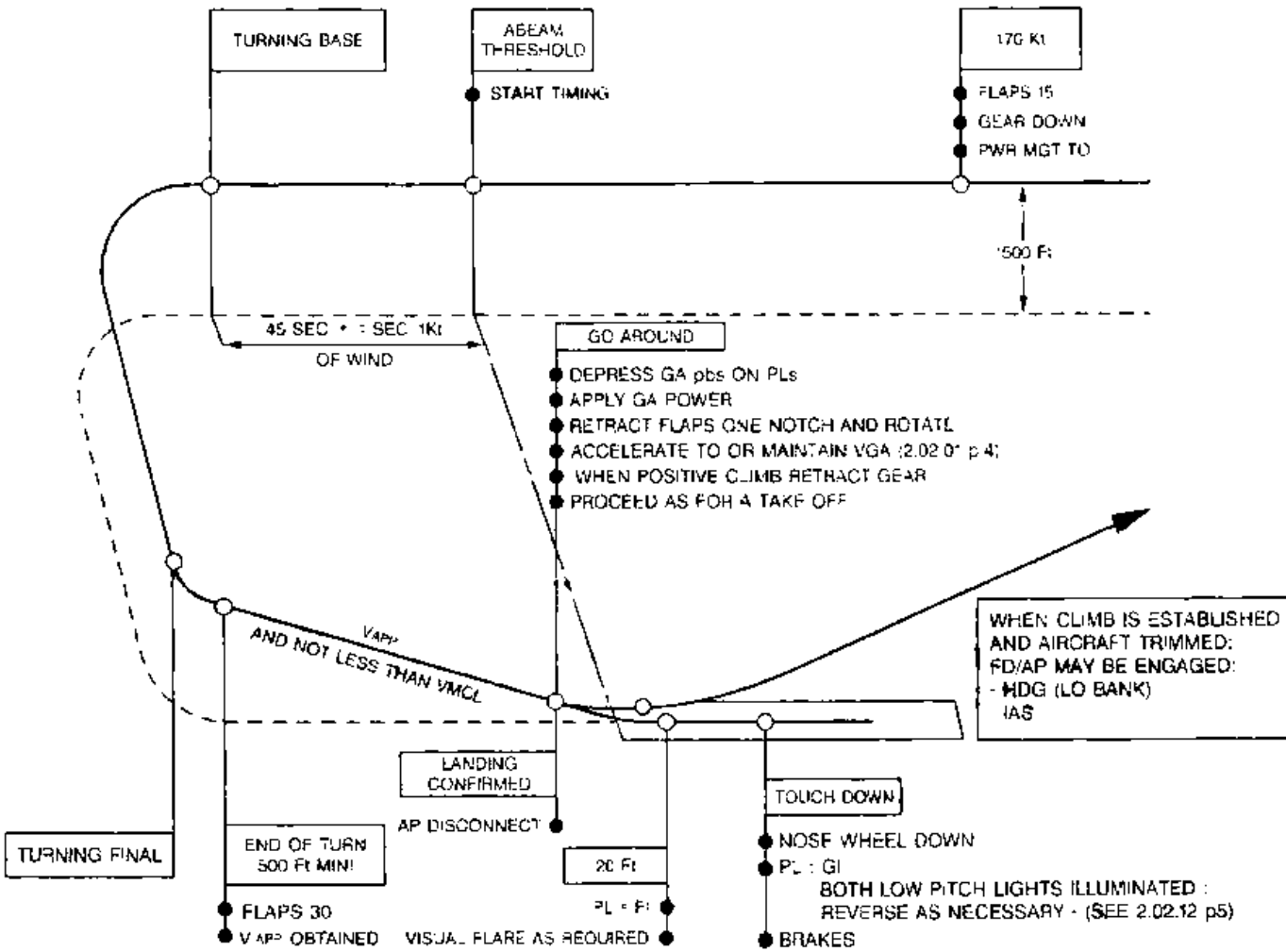

A	 ATR 72 F.C.O.M.		PROCEDURES AND TECHNIQUES FLIGHT PATTERNS	
	P 6 001			
			2.02.10 JUL 98	



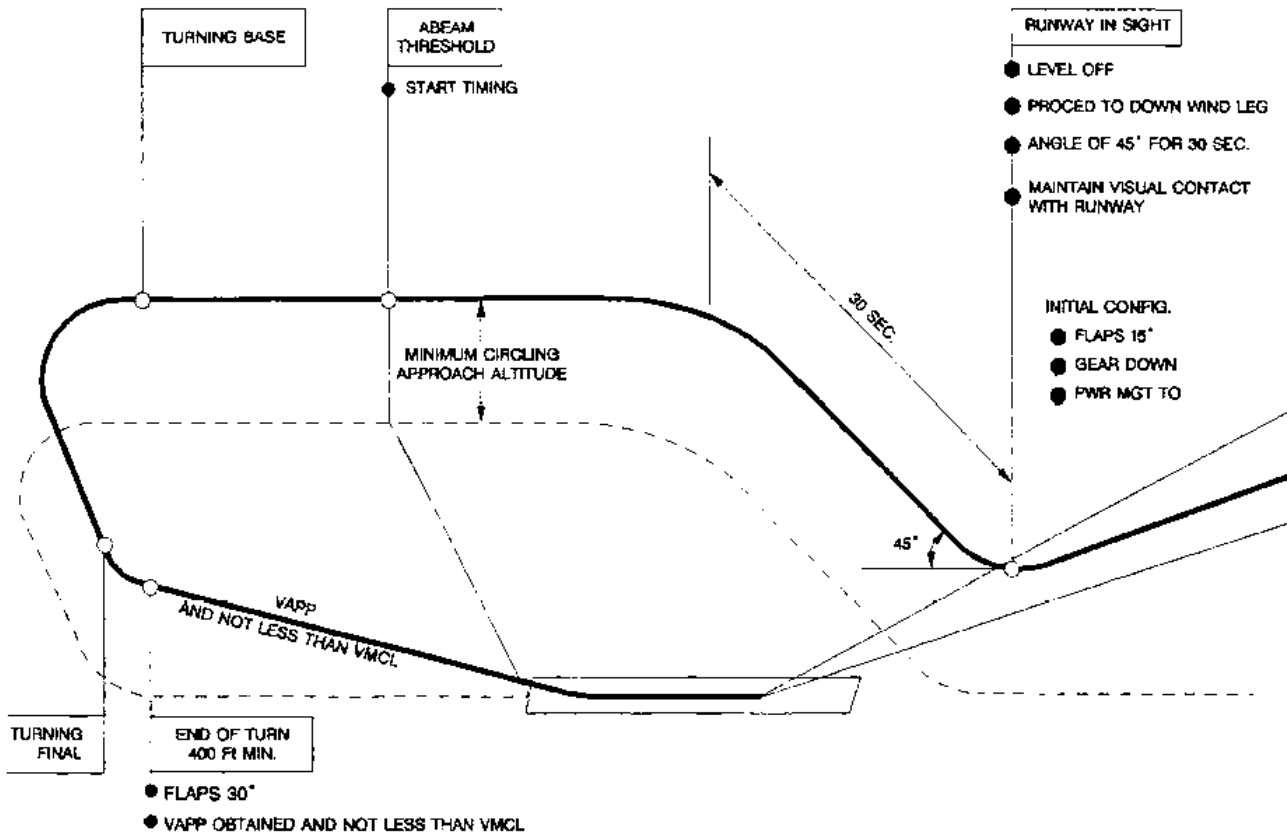

NORMAL LOW VISIBILITY CIRCLING APPROACH

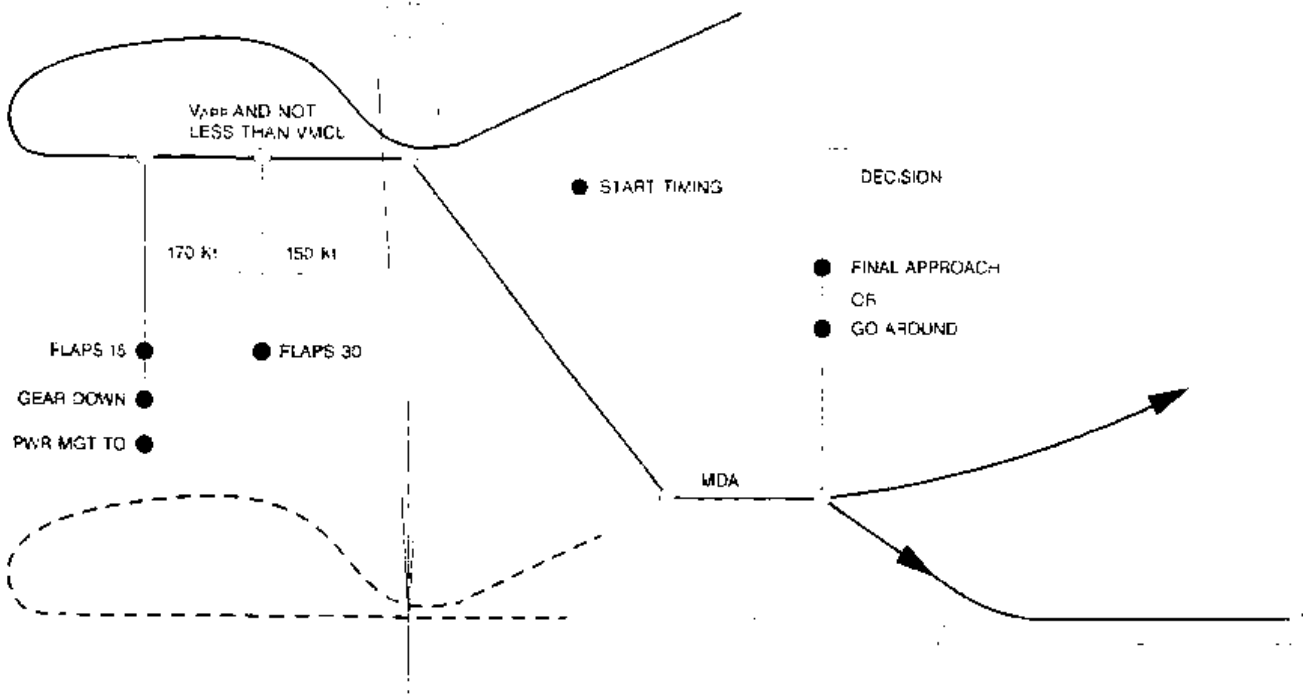

 ATR 72 F.C.O.M.	PROCEDURES AND TECHNIQUES	
	FLIGHT PATTERNS	
	P 7	2.02.10
	001	
DEC 94		

VOR - ADF NON PRECISION APPROACH



 VR72 F.C.O.M.	PROCEDURES AND TECHNIQUES		
	FLIGHT PATTERNS		
	P 8	001	2.02.10
		JUN 97	

NO FLAPS LANDING

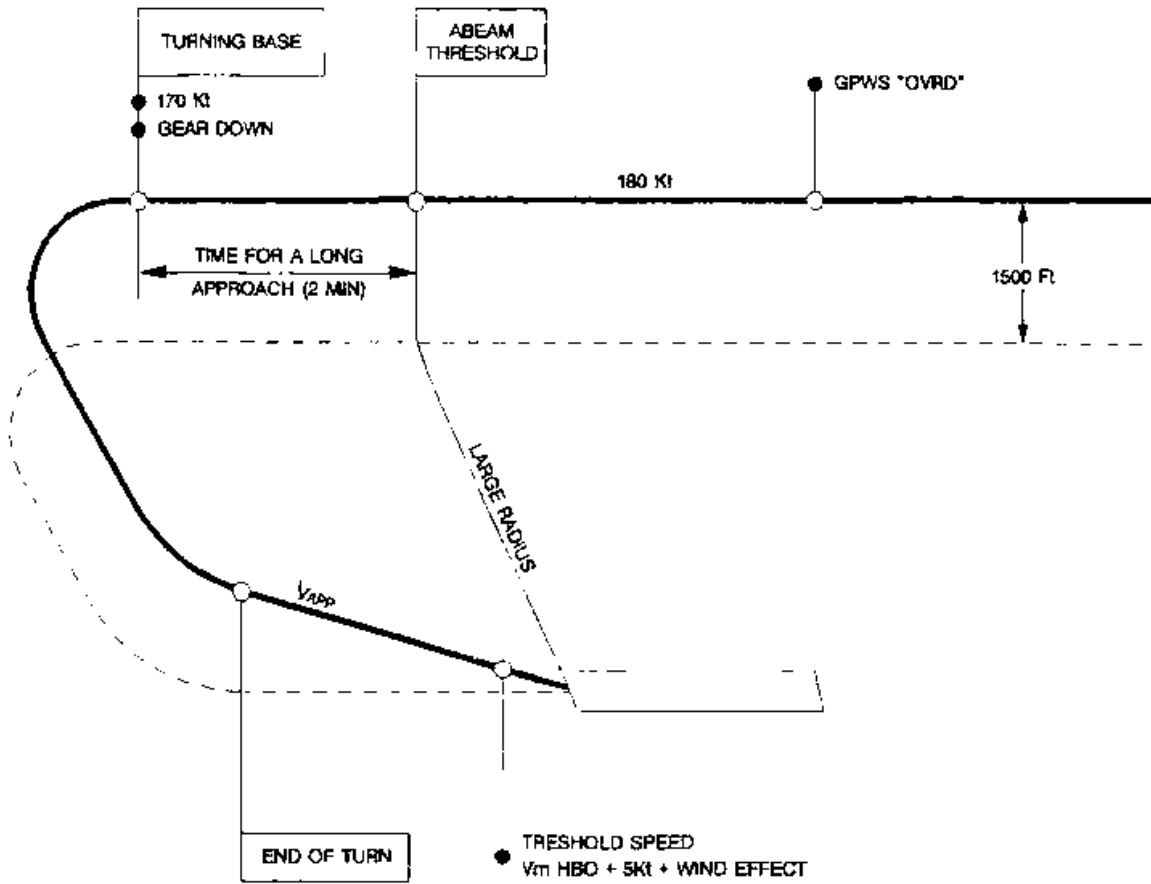

 ATR 72 F.C.O.M.	PROCEDURES AND TECHNIQUES	
	FLIGHT PATTERNS	
	P 9	001
	JUN 95	
	2.02.10	

	PROCEDURES AND TECHNIQUES		2.02.11		
			P 1	001	
	POWER PLANT				JUL 98

AA

START UP PROCEDURE

ADC switching should be alternated every other day (ADC 1 odd days, ADC 2 even days). Prior to initiating start sequence EEC FAULT light must be extinguished, if EEC FAULT is lit try to reset ; if unsuccessful, deselect EEC.

During engine start or relighting, the following items must be monitored.

- Correct NH increase when starting the sequence.
- Starter disconnection at 45 % NH.
- Maximum ITT : during a battery start one or two ITT peaks not exceeding 800°C may usually be observed. ITT peaks are of lower value if a suitable GPU is used.

This example shows the start sequence of engine N° 1 on ground (engine 2 running)

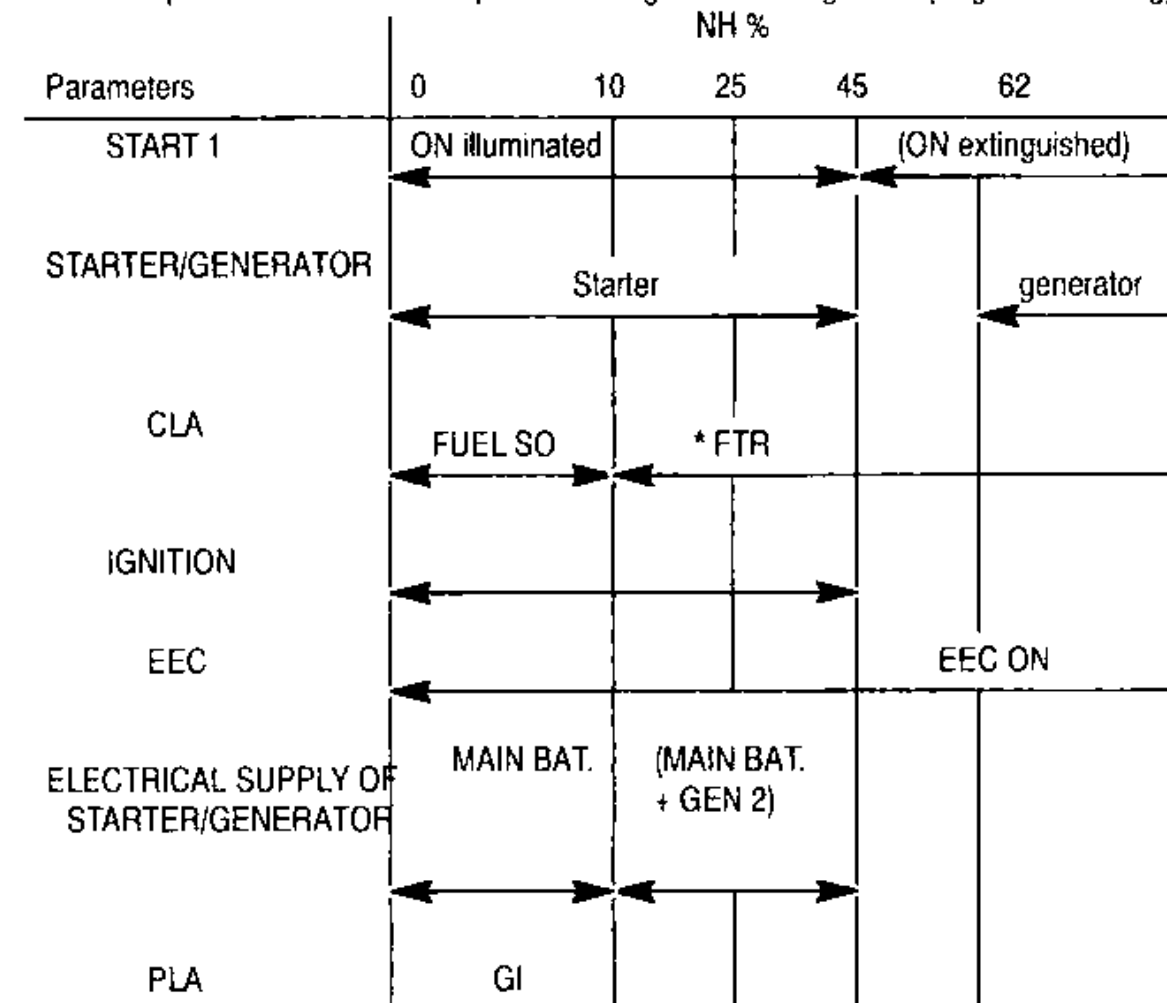

* Passing from FUEL SO to FTR is possible between 10 and 19 % NH if ITT > 200° C.

R ENG OIL LO PR CCAS alarm is 30 seconds time delayed to avoid untimely ENG OIL LO PR R during engine start on ground in cold conditions. However, on some engines, the oil R pressure build-up can last more than 30 seconds causing ENG OIL LO PR warning R activation during 2 or 3 seconds. This phenomenon is considered as acceptable by PWC.

R Note : This alert is inhibited when affected CL is in FUEL SO position.

	PROCEDURES AND TECHNIQUES		2.02.11		
			P 2	500	
	POWER PLANT				DEC 97

AA

TAKE OFF: USE OF BLEED VALVES

The aircraft is fitted with an automatic bleed valve closing in case of engine failure at Take off.

The closing signal is given by MFC's when uptrim is triggered. BLEED FAULT light also illuminates on the operative engine. Engine bleed valves may be routinely selected ON (NORM FLOW) for Take off. However, performance decrement has to be considered for the ground phase. This decrement is given in chapter 3.03 and may be computed by the FOS.

POWER SETTING AT TAKE OFF

Engine control normally uses temperature, altitude and speed data from the selected ADC but reverts to its own sensors in case of detected failure or significant offset. TAT/SAT information are valid only when the engine (propeller unfeathered) corresponding to the selected ADC is running.

RTO torques must be computed using altitude and temperature information independent from aircraft sources and compared to values displayed by torque bugs.

Take off power is routinely obtained by setting the power levers and the condition levers into the notches. If need be, in order to match target torque bugs set according to dependable data, it may be necessary to adjust the throttles out of the notches.

R UNFEATHERING AFTER AN ENGINE RESTART IN FLIGHT

Unfeathering the propeller induces a limited lateral disturbance.

ENGINE PARAMETERS FLUCTUATION

In case of slight engine parameters fluctuation without any limit exceedance, it can be helpful to select the corresponding EEC OFF, before shutting the engine OFF.

If this action cures the problem, the flight can be continued accordingly.

MAN IGNITION

When one or both EEC (s) has (have) been deselected, the use of MAN ignition is required when the aircraft penetrates heavy precipitation or severe turbulence areas, when ice accretion develops or when using contaminated runway for take off or landing.

GO AROUND - POWER SET UP PROCEDURE

The throttle movement (PF) is to be applied across the notch up to the ramp (beginning of amber sector).

WARNING : Overriding the ramp threshold up to the absolute full travel will allow to reach 1.15 x RTO TQ (EEC ON).

This should be used only in case of emergency.

CLs should be routinely stay into the notches. Np is automatically set at 100 % provided PWR MGT is on TO position and PLA is sufficient (see 1.16.40).

 AJR 72 F.C.O.M.	PROCEDURES AND TECHNIQUES		2.02.11		
			P 3	500	
	POWER PLANT				JUN 97

AA

ADAPTED FLIGHT IDLE

A low flight idle rating is associated with a significant increase of aerodynamic drag profitable to the descent performance (approach and landing).

On the other hand, this increased drag penalises the lift at a high angle of attack.

The fulfillment of these two requirements has led to an adapted flight idle providing two power settings.

The FI position being selected by the pilot, the power level (high or low) is set by the EEC's, as a function of an information provided by the MFC's.

This information is associated with a limit angle of attack equal to α stall warning -4° .

In case of high flight idle loss the aircraft behaviour during stall unchanged and the decrease of lift is negligible and covered by the regulatory margins.

PROPELLER BRAKE USE

Propeller brake must be used only when READY light on propeller brake control panel is illuminated.

1 - BRAKING SEQUENCE (ENG 2 Running)

CREW ACTION

RH CL. FIR OR FUEL SO

GUST LOCK ON

BLUE HYD PRESS...CHECK ABOVE 2900 PSI

PROP BRAKE SYSTEM STATUS



PROP BRAKE SW ON

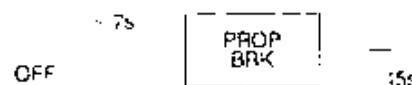
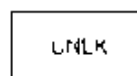

RCPA-02-02-11-503-4500AM

Notes : The DC AUX pump runs automatically as soon as blue hydraulic pressure is below 1500 PSI and,

- gear is down and,
- one engine is running

and stops 15 seconds after the end of prop braking sequence (PROP BRK lights illuminated).

	PROCEDURES AND TECHNIQUES POWER PLANT	2.02.11		
		P 4	001	
				JUN 97

2 - RELEASING SEQUENCE (ENG2 in hotel mode)

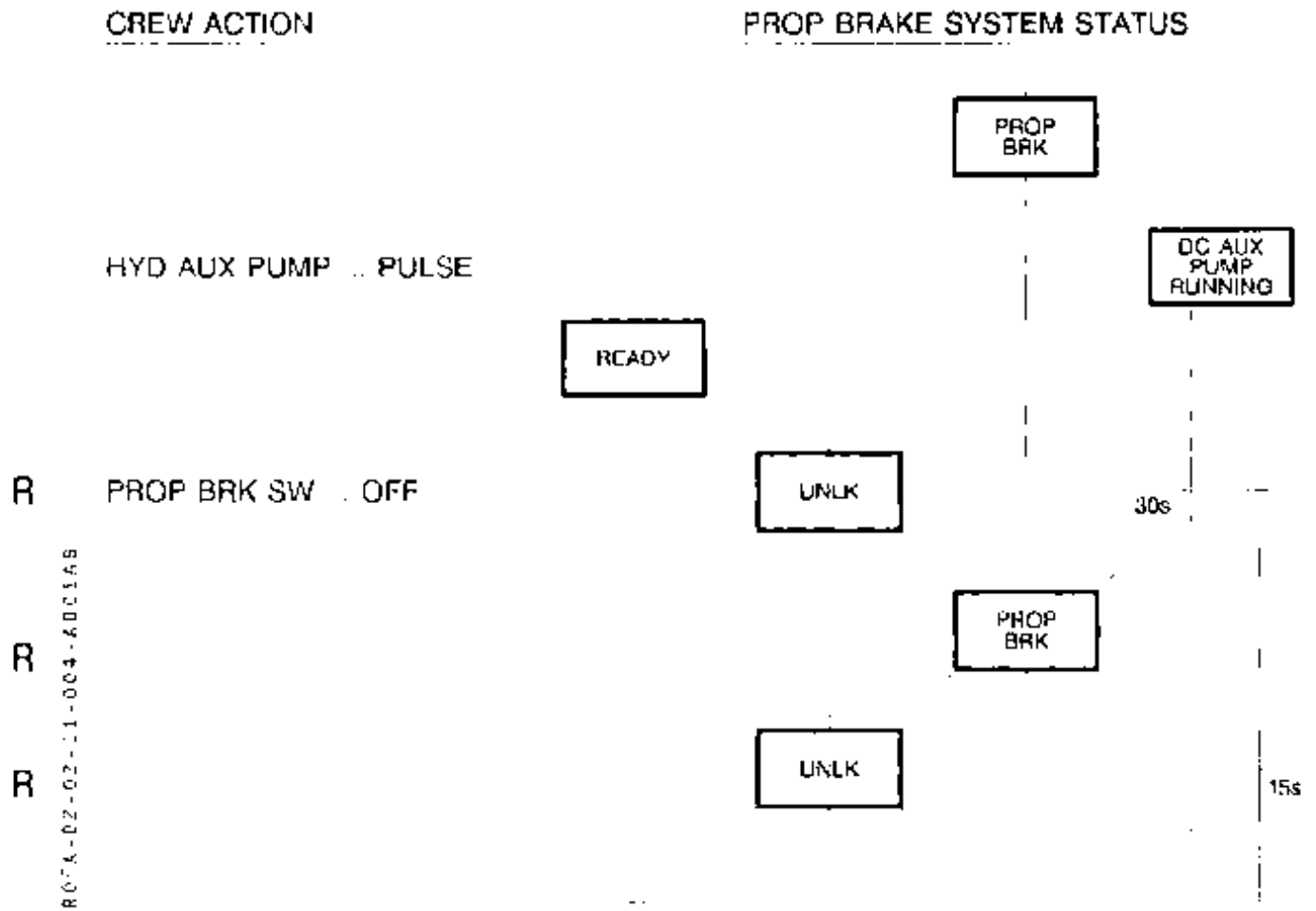

Note: A pulse on AUX HYD PUMP pb starts the auxiliary hydraulic pump for 30 seconds. Selecting propeller brake sw to OFF position within this 30 s temporization allows to keep the DC AUX PUMP running overriding the 30 seconds temporization.

	PROCEDURES AND TECHNIQUES POWER PLANT	2.02.11		
		P 5	500	
				JUN 97

DIFFERENCE BETWEEN AN EEC FAULT CONDITION AND AN ENGINE FLAME OUT IN FLIGHT

	ENGINE FLAME OUT(*)	EEC FAULT
POWER EVOLUTION	Immediate power loss	Moderate variation (either way)
EEC FAULT LIGHT	Not lit	Immediate illumination
NH	Rapidly below 74 %	Always above 74 %
ITT	rapidly below 350° C	Always above 350° C
POWER LEVER	Totally inefficient	Generally inefficient refer to FCOM 1.16.30
ASSOCIATED DC GEN LT	DC GEN Fault illuminates rapidly	Normal
BLEED/PACK	FAULT illuminates rapidly	Normal

(*) If automatic relight has not operated

ENGINE OPERATION WITH EEC OFF

- EEC deactivation may lead to an important power variation at constant throttle position. Power recovery will necessitate throttle readjustment.
- Maintaining target torque may necessitate positions out of the notch since constant throttle position feature is lost. Some throttle readjustments will be necessary during climb.
Engine response may be more sluggish when increasing power and a temporary throttle overtravel may be necessary to obtain a fast power response.
- If EEC is selected from OFF to ON, an important power variation may result. That is why the throttle has to be reduced below 52° prior to such an action.
- Landing with both EEC OFF will lead to a big propeller speed decay as the speed decreases, so that ACW power may be lost at the end of the landing run. Be ready to use nose wheel steering and emergency braking as required.
Engine response during taxi will be slower.
- Reverse power is reduced. Moreover, in case of acceleration stop, a one second stop must be observed at FI before setting PLs below.

ENGINE FAILURE SIMULATION FOR TRAINING PURPOSES

Flight training requires to simulate engine failure in a representative manner for both controllability and performance aspects but without feathering engine (safety and cooling of nacelle).

For a given PL position, the propeller THRUST (+) / DRAG (-) VARIES VERY SIGNIFICANTLY WITH IAS, particularly at low speeds, as shown by the following table.

(Zp = 0 (ISA/NP max = 100%))

PL Position	0 kt	50 kt	100 kt	125 kt	150 kt
40	1300 daN	710 daN	200 daN	0 daN	-0 daN
36	1270 daN	670 daN	- 240 daN	- 600 daN	- 530 daN
Fl	1240 daN	640 daN	- 460 daN	- 850 daN	- 750 daN
Gl	140 daN	- 610 daN	-2070 daN		
Max Rev	- 610 daN	-1370 daN	- 2900 daN		

- The drag of a feathered engine is negligible between 0 and 150 kt.
- The maximum drag of a failed, unfeathered, engine varies with IAS and PL position as follow :

PL Position	0 kt	50 kt	100 kt	125 kt	150 kt
TO	0 daN	80 daN	310 daN	470 daN	700 daN
Fl (B = 14°)	0 daN	80 daN	400 daN	620 daN	750 daN

The procedure for simulating engine failure is based on retarding PL to fixed positions, optimised to cover correctly the T/O and approach phases i.e. for IAS around 110/125 kts.

IN FLIGHT - To simulate an UNFEATHERED failed engine retard PL at Fl.

- To simulate a FEATHERED engine set PL to 39 for IAS 110/125 kt.

Note : ISA and altitude effects are negligible.

- For continued take-off with simulated engine failure, retard PL to 39 for IAS 110/125 kt in order to simulate auto feather action.

ON GROUND - Aborted T/O: Retard INITIALLY to Fl.

- CAUTION :**
- On ground, in all cases, (single engine landing or aborted T/O), the trainee must retard BOTH PL at Gl, then use reverse on «LIVE» engine only, as necessary.
 - Leaving the simulated « engine failed » PL at 39 or more (for single engine landings) or Fl (for aborted T/O) would lead to non representative controllability problems as the «failed » engine thrust would change its initial drag into a big increase of forward thrust as IAS decreases.
 - To be exact, these values request a perfect rigging of engine controls. A slight mismatch may induce a significant drag change. Pilot should monitor performances and increase PLA as necessary.

	PROCEDURES AND TECHNIQUES	2.02.12		
		P 1	001	
	FLIGHT CHARACTERISTICS			JUL 99

AA

TAKE OFF AND LANDING RUNS

- Proper crew coordination is required in order to hold the control column at all times and prevent excessive elevator or aileron deflections due to wind and/or reversed air flow from propellers.

The control column is initially held.

- in pitch : fully nose down, then slowly relaxed as speed increases.
- in roll : neutral or deflected TOWARD the wind in case of crosswind component, as appropriate to maintain wings essentially level.

Note : Excessive aileron deflections should be avoided as they affect directional control.

- For take-off, use of nose wheel steering guidance is only recommended for the very first portion of the take off run as rudder becomes very rapidly efficient when airspeed increases (~ 40 kts) and ATR 72 exhibits a natural tendency to go straight.
- Action on nose wheel tiller should be smooth and progressive, particularly as ground speed increases.
- Rudder must not be cycled during take-off, particularly the first portion where nose wheel is used: combination of unnecessary rudder cycling (with an increasingly efficient rudder) and nose wheel control would then lead to uncomfortable oscillations.
- R - Rolling take-off technique
- R - In order not to increase the take-off distances, power must be set quickly during the last phase of the line up turn.
- R - last phase of the line up turn.
- for landing or aborted take off, control column holding must be transferred to the co-pilot when the captain takes the nose wheel steering.
If reverse is used, at low speeds and with high power, the reversed air flow may shake violently the flight controls, particularly with no crosswind: the control column must be held very firmly and/or, below 30 kts, the GUST LOCK may be engaged.

	PROCEDURES AND TECHNIQUES	2.02.12		
		P 2	001	
	FLIGHT CHARACTERISTICS			JUL 98

AA

ENGINE FAILURE

AT TAKE OFF BELOW V1

Abort is mandatory: both PLs are retarded to GI and full brakes applied as needed. Reverse is available even on single engine down to full stop: again, control column is transferred to the co-pilot when captain takes nose wheel steering and, in case of single reverse operation roll control must be applied (possibly to full travel) in order to minimize the tendency to bank on the side of the operating engine.

AT TAKE OFF ABOVE V1

Take off must be continued. Directional control must be maintained with rudder and, as soon as aircraft becomes airborne, aileron input to stabilize heading with about 2° of bank toward the operating engine is highly recommended in order to decrease rudder deflection thence improve climb performance.

Both rudder and aileron forces may be completely trimmed out, even at minimum scheduled V2. Once both yaw and roll axis are trimmed out, autopilot may be engaged.

IN APPROACH

Directional control must be maintained with rudder, (which disengages automatically YD and AP if previously engaged) and aileron, in a manner similar to what was described for the continued take off case.

The ATPCS functioning is different between approach and take-off.

Even if TO position is selected:

- Uptrim function is never available
- Auto feather function may be available depending on PL position at the time of the failure.

If autofeather has not operated (windmilling), the drag depends on the engine failed PL position. For this reason :

- In approach, do not reduce the affected PL below 38° PLA before manually feathering the engine.
- R - If a go around is performed, advance both PLs to the ramp. When appropriate, manually feather the failed engine.

LANDING (PROPELLER FEATHERED)

- Flare technique remains unchanged and rudder input required to compensate the asymmetric reduction at 20 ft is more smoothly achieved if YAW DAMPER has been disconnected in short final.

- After main gear touch down, it is recommended to first lower nose wheel to ground contact before reducing PL from FI to GI: this allows to better control the large asymmetric associated drag increase on the live engine side. PL may be then retarded to full reverse as required but roll attitude must be controlled which requires large control wheel deflection by PNF.
- R

	PROCEDURES AND TECHNIQUES FLIGHT CHARACTERISTICS	2.02.12		
		P 3	001	
				JUL 99

AA

STALLS

STALL WITHOUT ICE ACCRETION

In all configurations, when approaching the stall, the aircraft does not exhibit any noticeable change in characteristics of flight : control effectiveness and stability remains good and there is no significant buffet down to CL max ; this is the reason why both the stall alert (audio "cricket" and shaker) and stall identification (stick pusher) are "artificial" devices based on angle of attack measurement.

Recovery of stall approaches should normally be started as soon as stall alert is perceived : a gentle pilot push (together with power increase if applicable) will then allow instant recovery. If the stall penetration attempt is maintained after stall alert has been activated, the STICK PUSHER may be activated : this is clearly unmistakable as the control column is suddenly and abruptly pushed forward, which in itself initiates recovery.

Note : The "pushing action" is equivalent to 40daN/88 lbs applied in 0.1 second and it lasts as long as angle of attack exceeds the critical value.

CAUTION : Stall training exercises without stick pusher are prohibited.

STALL WITH ICE ACCRETION

Even with airframe de-icers used according to procedure (i.e. as soon as and as long as ice accretion develops on airframe), the leading edges cannot be completely cleared of ice accretion because of existence of "unprotected" elements on the leading edges and continued accretion between two consecutive boots cycles.

This residual ice on leading edges changes noticeably the characteristics of flight **BELOW** the minimum operating speeds defined for ice accretion, as follows :

- Control effectiveness remains good, but forces to manoeuvre in roll and to a lesser degree in pitch, may increase somewhat.
- Above the reduced angle of attack :
 - . An aerodynamic buffeting may be felt which will increase with the amount of ice accumulated and angle of attack increase.
 - . Stability may be slightly affected in roll, but stick pusher should prevent angle of attack increase before wing rocking tend to develop (Refer to FCOM 1.02.30 for stall alarm threshold definition).

Recovery of stall in such conditions must be started as soon as stall warning is activated or buffeting and/or beginning of lateral instability and/or sudden roll off is perceived.

Recovery will be best accomplished by :

- A pilot push on the wheel as necessary to regain control.
- R - Selection of flaps 15.
- R - Increase in power, up to MCT if needed.

 ATR 72 F.C.O.M.	PROCEDURES AND TECHNIQUES	2.02.12		
		P 4	500	
	FLIGHT CHARACTERISTICS			JUL 98

AA

APPROACH

- The deceleration capabilities of the ATR 72 provide a good operational advantage which should be used extensively: decelerated approaches reduce noise, minimize time and fuel burn and allow better integration in big airports. This is why they have been described as the « standard approaches » in section 2.02.10 (flight patterns).
- Initial approach speed will vary with ATC constraints and turbulence, but may be up to 240 Kts.
- Initial approach speed may be maintained on a typical 3° glide slope down to the following height above runway:

NP	DECLARATION HEIGHT
82 %	(IAS x 10) ft

Configuration changes should be made at VLE VFE when decelerating. This procedure allows to reach VAPP speed at 500 ft above runway.

Note : If deceleration rate on approach appears insufficient, it is always possible to increase it by setting NPs on 100 OVRD, but at the expense of an increased interior noise.

	PROCEDURES AND TECHNIQUES FLIGHT CHARACTERISTICS	2.02.12		
		P 5	500	
				JUL 01

AA

LANDING

In order to minimize landing distance variations the following procedure is recommended :

- Maintain standard final approach slope (3°) and final VAPP until 20 ft is called on radioaltimeter.
- At « 20ft » call by PNF, reduce to FI and flare visually as required.

Note : 20 ft leaves ample time for flare control from a standard 3° final slope.

- During this flare the airspeed will necessary decrease, leading to a touch down speed of 5 to 10 kt lower than the stabilized approach speed.
- As soon as main landing gear is on ground.
 - Control nose wheel impact
 - Both PL : GI
 - Both LO PITCH lights : check illuminated.

CAUTION :if a thrust dissymetry occurs or if one LO PITCH light is not illuminated, the use of any reverser is not allowed.

In this case the propeller pitch change mechanism is probably locked at a positive blade angle, leading to a positive thrust for any PL position.

- use foot brakes as required
- as speed reduces, and not later than about 40 kt (estimated) Capt takes NWS control, co-pilot hold control column fully forward.

Notes : 1. Max reverse is usable down to full stop if required, but to minimize flight control shaking due to reverse operation at high powers, it is helpful to release slowly PL back to GI when reaching low ground speeds (below 40 kt estimated).

2. Max braking is usable without restriction down to full stop, whatever the runway conditions may be, provided ANTISKID is operative.

3. The tail bumper (with damping capabilities) effectively protect the tail in case of excessive attitude (resulting from prolonged/floating flares) provided the rate of sink at touchdown does not exceed 5 ft/sec.

4. In case of a significant bound, a go around should be considered.

 NR72 F.C.O.M.	PROCEDURES AND TECHNIQUES	2.02.14		
		P 1	001	
	FLIGHT INSTRUMENTS			JUN 94

AHRS

AHRS alignment sequence takes place as soon as the battery is switched ON, and it takes nominally **3 MINUTES DURING WHICH AIRCRAFT MUST NOT BE MOVED.**

To know the remaining time for AHRS alignment, depress AHRS FAST ERECT. pb.
The heading which can be read on the associated EHSI indicate the time remaining (in seconds) for AHRS alignment (example : heading 090 = 1 minute and 30 seconds).
Then, release AHRS fast erect Pb.

AHRS normally survive to electrical transients associated with engine start : thus after ENG 2 start in Hotel mode, both AHRS should deliver normal attitude information on pilot and copilot EFIS 3 minutes after BAT toggle switch has been selected ON.

ON GROUND ONLY, if needed, AHRS reset may be performed by cycling all relevant C/B OFF - ON.

Note : The beginning of the 3 mn alignment period may be observed as it is associated with a brief display of horizon tilted 30° to the right without flag.

CAUTION : Resetting AHRS C/B in flight is not recommended as in flight realignment requires 3 mn of **very stable flight** (which may be impossible to get in turbulence) and possibility of pulling the wrong C/B could lead to complete AHRS failure unrecoverable for the rest of the flight.

Note : Some of the AHRS failures observed in flight may be « self recoverable » when they are associated to a temporary failure of the SPERRY DIGITAL BUS.

WEATHER RADAR

The weather radar radiates power when operating in any mode other than STBY. Use of weather radar on ground in a mode other than STBY requires special care :

- R * make certain that no personnel is working in front of aircraft within a sector of 3.m radius and 130° left or right of the aircraft axis.
- * Direct aircraft nose so that no large size metal object (hangar, aircraft etc.), is located within a 30.m radius
- * Avoid operating radar during refueling operation of radiating aircraft or any other aircraft within a 30.m radius.



ATR 72
F.C.O.M.

PROCEDURES AND TECHNIQUES

2.02.15

P 1

020

TCAS

JUL 01

AA

GENERAL

TCAS is an airborne Traffic alert and Collision Avoidance System that interrogates ATC transponders in nearby aircraft and generates appropriate aural and visual advisories to the flight crew to provide adequate separation.

Air to Air communications for coordinating maneuvers between TCAS equipped aircraft is provided by mode S ATC transponder.

Note 1 : TCAS system can only generate resolution advisories for intruders equipped with operative mode S or mode C transponders (providing valid intruders altitude information).

Note 2 : Traffic advisories can only be generated for intruders equipped with operative mode S, C or A transponders (TCAS system provides no indication of aircraft without operative transponders).

CAUTION

The TCAS equipment is viewed as a supplement to the pilot who, with the aid of the Air Traffic Control, has the primary responsibility for avoiding mid-air collisions.

START UP AND TEST

- TURN rotary selector of the relevant ATC Control box to the STBY position.
- TURN rotary selector of TCAS control box to the STBY position.
- PRESS <<TEST>> button on the TCAS Control box and check proper aural message and visual display.

GROUND OPERATION

TCAS test should be carried out during cockpit preparation.

Unless otherwise instructed by ATC:

- KEEP selecting STBY mode on the TCAS Control box while taxiing for take off.
- Just prior to take off, select <<ALT>> mode and check ATC1 selected on ATC transponder control box; then select << AUTO >> Mode on TCAS Control box.
- Select STBY mode on TCAS Control box immediately after clearing the runway following landing.

	PROCEDURES AND TECHNIQUES TCAS	2.02.15		
		P 2	220	
				JUL 01

AA

FLIGHT PROCEDURES

Procedure is initiated by a TCAS Traffic Advisory (TA).

«TRAFFIC - TRAFFIC»

- CPT «Prepare for climb»
- PNF - Select proper rating on Power management rotary selector (MCT when climbing cruising or descending in clean configuration, TO in other cases e.g. take off approach and landing phases).
 - Put hands on CL ready to push them to 100 OVRD.
 - Recall minimum safety altitude.
- BOTH - Try to visually acquire the intruding aircraft.

Then may occur a Resolution Advisory (RA). Some RA will only advise to monitor vertical speed (preventive RA). Others will advise to maneuver the aircraft.

The following procedures should then apply :
Sense of Resolution Advisory asking to maneuver.

<u>DESCEND</u>		<u>CLIMB</u>	
CPT	Confirms «we descend»	CPT	Confirms «we climb»
PF	- Disconnect Auto Pilot - Descent at a rate in the green (fly to) arc on TCAS VSI. - Ask for eventual configuration changes.	PNF	CL to 100 OVRD
PNF	Advise ATC <u>Monitor</u> - IAS compared to VLE, VFE VMO pointer - Aircraft altitude compared to minimum safety altitude.	PF	- Disconnect auto Pilot - Apply roughly the bugged power. - Climb at a rate in the green (fly to) arc on TCAS VSI. - Ask for eventual configuration changes.
		PNF	- Adjust power to TQ objectives - Advise ATC - Monitor IAS compared to VS.

Note : When a climb or increase climb RA occurs with the airplane in the landing configuration or in the go-around phase, a normal procedure of go-around should be followed including the appropriate power increase and configuration changes.

After separation has become adequate (range increasing), TCAS will issue following RA.

«CLEAR OF CONFLICT»

Return promptly to last assigned ATC clearance.

 ATR 72 F.C.O.M.	PROCEDURES AND TECHNIQUES GPWS	2.02.16		
		P 1	001	
				JUN 97

AA

GPWS WARNING

Note : When flying under daylight VMC conditions, should a warning threshold be deliberately exceeded or encountered due to known specific terrain at certain locations, the warning may be regarded as cautionary and the approach may be continued

A go around shall be initiated in any case if cause of warning cannot be identified immediately.

■ **"WHOO WHOO PULL UP" - "TERRAIN TERRAIN" -**

"TOO LOW TERRAIN"

- POWER GO AROUND
- A/P OFF

● **When flight path is safe and GPWS warning ceases :**

Decrease pitch attitude and accelerate.

● **When speed above minimum required and V/S positive :**

Clean up aircraft as necessary.

■ **"SINK RATE"**

Adjust pitch attitude and power to silence the warning.

■ **"DON'T SINK"**

Adjust pitch attitude and power to maintain level or climbing flight.

■ **"TOO LOW GEAR" - "TOO LOW FLAPS" :**

Correct the configuration or perform a go around.

■ **"GLIDE SLOPE"**

- Establish the airplane on the glide slope,

or

- Depress one GPWS/GS pb if flight below glide slope is intentional (non precision approach).

	PROCEDURES AND TECHNIQUES GLOBAL POSITIONING SYSTEM GPS	2.02.17		
		P 1	110	
				JUL 00

AA

1. POWER UP

The HT 1000 is directly powered by the DC BUS 1 or STBY BUS if TRU is installed.

2. FLIGHT PLANNING

Two different routes can be prepared before each flight:

RTE 1 may be used for the route from origin to destination and will be activated before take-off,

RTE 2 may be used for the route from destination to alternate and will then be activated only in case of diversion.

Before creating a route, make sure that the RTE 1 or RTE 2 pages have been completely erased. Selecting or re-selecting the origin airport will automatically erase the associated route.

Details of the procedure to create a route are given in the Pilot's Guide.

After activation of the route, the pilot initializes entries via multifunction control system (MCDU).

3. NAVIGATION

3.1 General

The HT 1000 basic navigation is provided by the GPS. When the GPS receiver is failed, deselected, or if the satellite coverage is insufficient, the navigation automatically reverts to the DME/DME mode or DR mode (based on the navigation solution hierarchy).

Note : this DME/DME mode is available only if aircraft is equipped with two DME receivers.

3.2 Displays

GNSS mode is selected by pressing the RNV pushbutton on the EFIS control panel. GNSS may be presented either in OBS mode or MAP mode. The selection is done by repetitive action on the MAP pushbutton of the EFIS control panel.

OBS mode presents conventional lateral guidance on the active leg. In this mode the desired track selection is made by the HT 1000 (course selectors on glareshield panel are not operative).

In MAP mode multiple Wpt and/or additional symbols as holding pattern, DME arcs and procedure turns will be presented.

Note : Symbols do not reflect the exact path but indicate the type of path to fly.

The "to wpt" is displayed in magenta, all other wpt are white, a white track line connects the wpts.. The symbol for a holding pattern is an oval associated with a H letter. The symbol for a DME arc is a 90° arc with an arrowhead associated with a A letter.

The procedure turns is displayed with 2 lines indicating inbound and outbound leg.

	PROCEDURES AND TECHNIQUES GLOBAL POSITIONING SYSTEM GPS	2.02.17		
		P 2	110	
				JUL 00

AA

3.3 Guidance

Coupling of GNSS navigation to AP/FD in lateral mode

- select RNAV source on the EFIS control panel
- select MAP mode on the EFIS control panel
- adjust range using the WX radar range selector
- check aircraft position related to flight plan
- if necessary, come back on track or perform a Direct to the active waypoint
- select NAV mode on AFCS (LNAV will illuminate green)

Note : GNSS is not coupled to the AP/FD in vertical mode. The vertical deviation is advisory only on the EFIS.

Navigation monitoring

- maintain HDG bug on actual aircraft heading
- monitor the sequencing of the waypoints on the MCDU (ACT RTE 1/2 LEGS page) and make sure that there is no discontinuity.

CAUTION : when flying over a WPT followed by a discontinuity, the AP will revert to the basic lateral mode, maintaining the wings levelled. The message "CPL DATA INVALID" will then illuminate on the AFCS.

CAUTION : when in LNAV mode, switching of AP/FD between Pilot and Copilot will disengage the LNAV mode even if both sides are in GNSS mode. LNAV mode can be reengaged.

Navigation with OFFSET

When a parallel offset has been activated OFS will be permanently displayed in cyan above the aircraft symbol when in MAP mode or in the left upper part of the EHSI when in ROSE/ARC mode. The leg presented on the MAP display is not the offset leg but the XTK value presented below the aircraft symbol is related to the offset. Therefore it is normal, in such a situation, to see the aircraft symbol aside the active leg with a XTK value showing 00.0 L/R.

ETOPS operation

Before ETOPS operation, a Fault Detection and Exclusion (FDE) check must be performed on the ground.

Refer to Pilot's Guide for this procedure.

Return to standard display:

- check HDG bug on aircraft present heading
- select HDG mode on AFCS
- select V/L source on EFIS control panel
- select bearings \odot and \odot as required

	NORMAL PROCEDURES	2.03.00		
		P 1	001	
	CONTENTS			JUL 98

AA

R 2.03.00	CONTENTS
R 2.03.01	FOREWORD
2.03.02	PRELIMINARY
2.03.03	PANEL SCAN SEQUENCE
2.03.04	FLIGHT PREPARATION
2.03.05	EXTERIOR INSPECTION
2.03.06	PRELIMINARY COCKPIT PREPARATION
2.03.07	COCKPIT PREPARATION
2.03.08	BEFORE TAXI
2.03.09	TAXI
2.03.10	BEFORE TAKE OFF
2.03.11	TAKE OFF
2.03.12	AFTER TAKE OFF
2.03.13	CRUISE
2.03.14	DESCENT
2.03.15	APPROACH
2.03.16	BEFORE LANDING
2.03.17	GO AROUND
2.03.18	LANDING
2.03.19	AFTER LANDING
2.03.20	PARKING
2.03.21	LEAVING THE AIRCRAFT

	NORMAL PROCEDURES FOREWORD	2.03.01		
		P 1	001	
				OCT 89

Procedures contained in this chapter are recommended by the manufacturer. They are consistent with the other chapters of this manual in particular 2.02 « Procedures and Techniques ».

Normal procedures are not certified by the Authorities, and in the judgment of the Manufacturers, are presented here in, as the best way to proceed from a technical and operational stand point. They are continuously updated, taking into account inputs from all operators and lessons of the Manufacturer's own experience.

In the same manner, they may be amended as needed by the Operator.

However, if the FCOM is used as the on board Operational Manual, the Manufacturer recommends channelling any suggested amendment through him for early publication so as to maintain the consistency of the Manual.

The Operator should be aware that a complete rewriting of this chapter may be done under his own responsibility but could lead to difficulties in updating and maintaining the necessary homogeneity with the other chapters of this manual.

 AR72 F.C.O.M.	NORMAL PROCEDURES PRELIMINARY	2.03.02		
		P 1	001	
				JUN 94

Following sections provide expanded information related to normal procedures.

Normal procedures consist of inspections, preparations and normal check lists. All items are listed in a sequence following a standardized scan of the cockpit panels except when required by the logic of actions priority, to ensure that all actions are performed the most efficient way.

Normal procedures are divided into phases of flight and accomplished by recall.

In the following designations :

- CM 1 refers to the crew member in the left hand seat
- CM 2 refers to the crew member in the right hand seat
- PF refers to pilot flying
- PNF refers to the pilot non flying

After completion of a given procedure, the related normal check-list is used. The normal check-list developed by the manufacturers includes only the items that may have a direct impact on safety and efficiency if not correctly accomplished. All normal check-lists are initiated at the pilot's flying command. Some normal procedures which are non routine will be found in chapters 2.02 « PROCEDURES AND TECHNIQUES » and 3.11 « SPECIAL OPERATIONS ».

- R All steps have to be performed before the first flight of the day or following a crew change or maintenance action. Transit steps are the only ones to be completed after a transit stop. They are grouped in the COCKPIT FINAL PREPARATION. If there is any doubt as to whether the application of transit procedures covers all safety aspects, the complete preparation must be accomplished.

For all the procedures described in this part, standard operation is basically assumed, i.e. ENG 2 starting in Hotel mode.

However, the procedures also include the use of GPU.

	NORMAL PROCEDURES	2.03.03		
		P 1	001	
	PANEL SCAN SEQUENCE			JUN 97

R OVERHEAD PANEL SCAN SEQUENCE

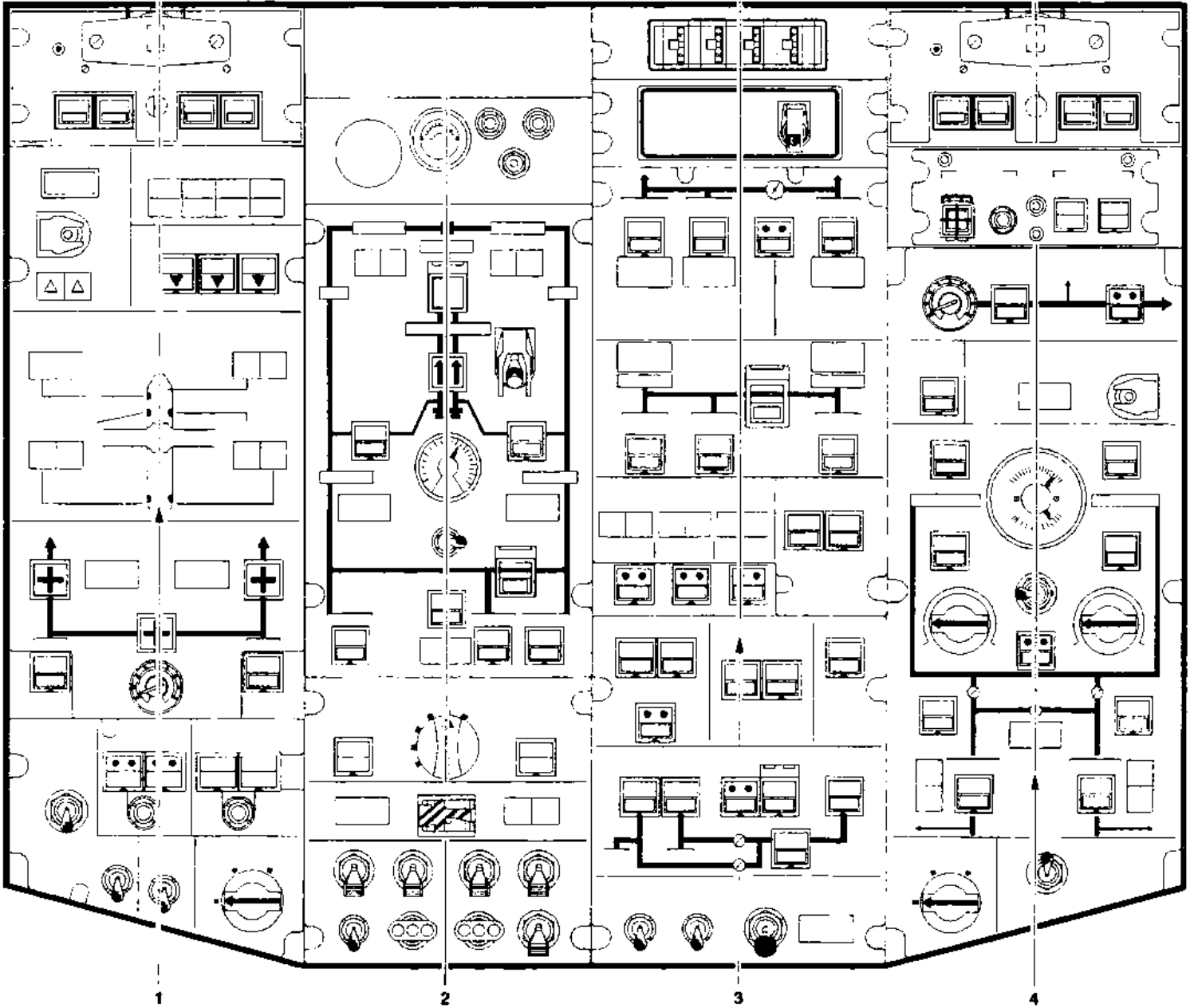

ROFA-02-03-03-001-A0014A



ATR 72
F.C.O.M.

NORMAL PROCEDURES

PANEL SCAN SEQUENCE

2.03.03

P 2 001

MAY 93

AA

INSTRUMENTS PANELS SCAN SEQUENCE

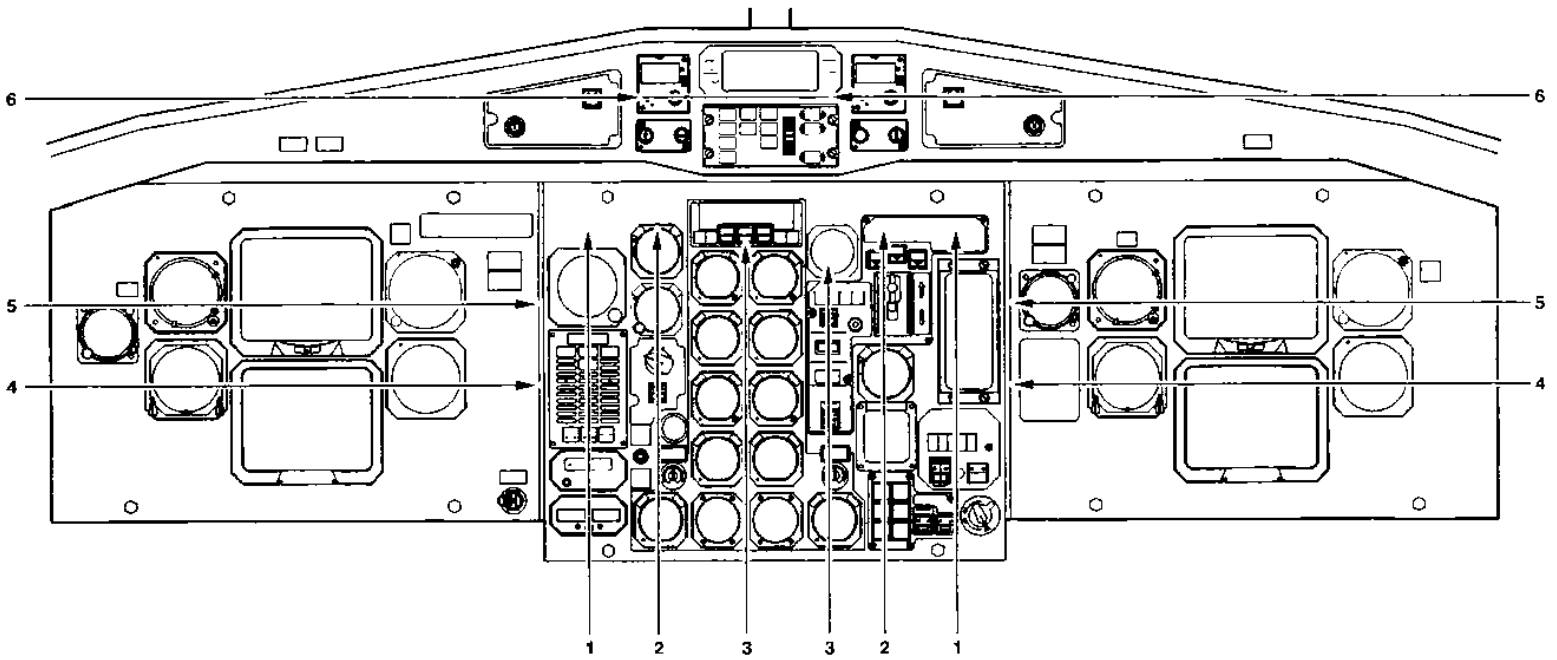

PEDESTAL SCAN SEQUENCE

RDFA-D7-03-03-003-A001AR

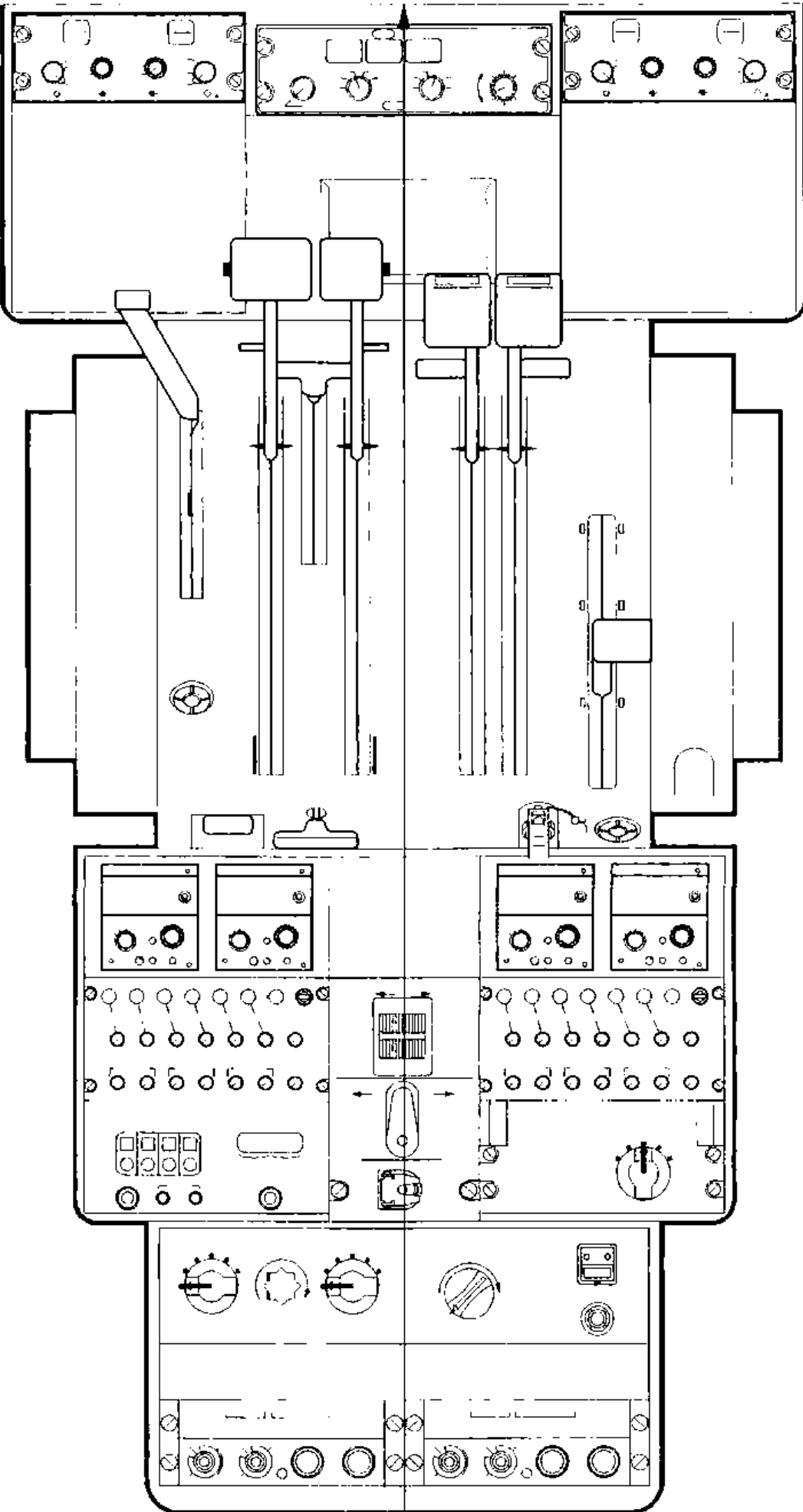

	NORMAL PROCEDURES FLIGHT PREPARATION	2.03.04		
		P 1	001	
				OCT 89

AA

TECHNICAL CONDITION OF THE A/C

- The crew will verify the technical status of the aircraft (HIL) in respect to airworthiness, acceptability of malfunctions (MEL) and influence on the flight plan.

WEATHER BRIEFING

- Crew will receive a weather briefing.
- Briefing should include :
 - . Actual and expected weather conditions for take off and climb out including runway conditions.
 - . En Route significant weather : winds and temperatures.
 - . Terminal forecasts for destination and alternate airports.
 - . Actual weather for destination and alternates for short range flights and recent past weather if available.
 - . Survey of the meteorological conditions at airports along the planned route.

NAV/COM FACILITIES EN ROUTE

- The crew will study the latest relevant NOTAMS and will check that all required facilities at departure, destination and alternate airports are operational and that they fulfill the appropriate requirements.

FLIGHT PLANS and OPERATIONAL REQUIREMENTS

- The crew will check the company flight plan, in respect to routing, altitudes and flight time.
- The crew will check the estimated load figures and will calculate max allowed take off and landing weights.
- The captain will decide the amount of fuel necessary for a safe conduct of the flight, taking into consideration possible economic fuel transportation.
- The captain will check ATC flight plan and ensure it is filed according to the prescribed procedures.



ATR 72
F.C.O.M.

NORMAL PROCEDURES

EXTERIOR INSPECTION

2.03.05

P 1

180

JUN 97

AA

EXTERIOR WALK AROUND

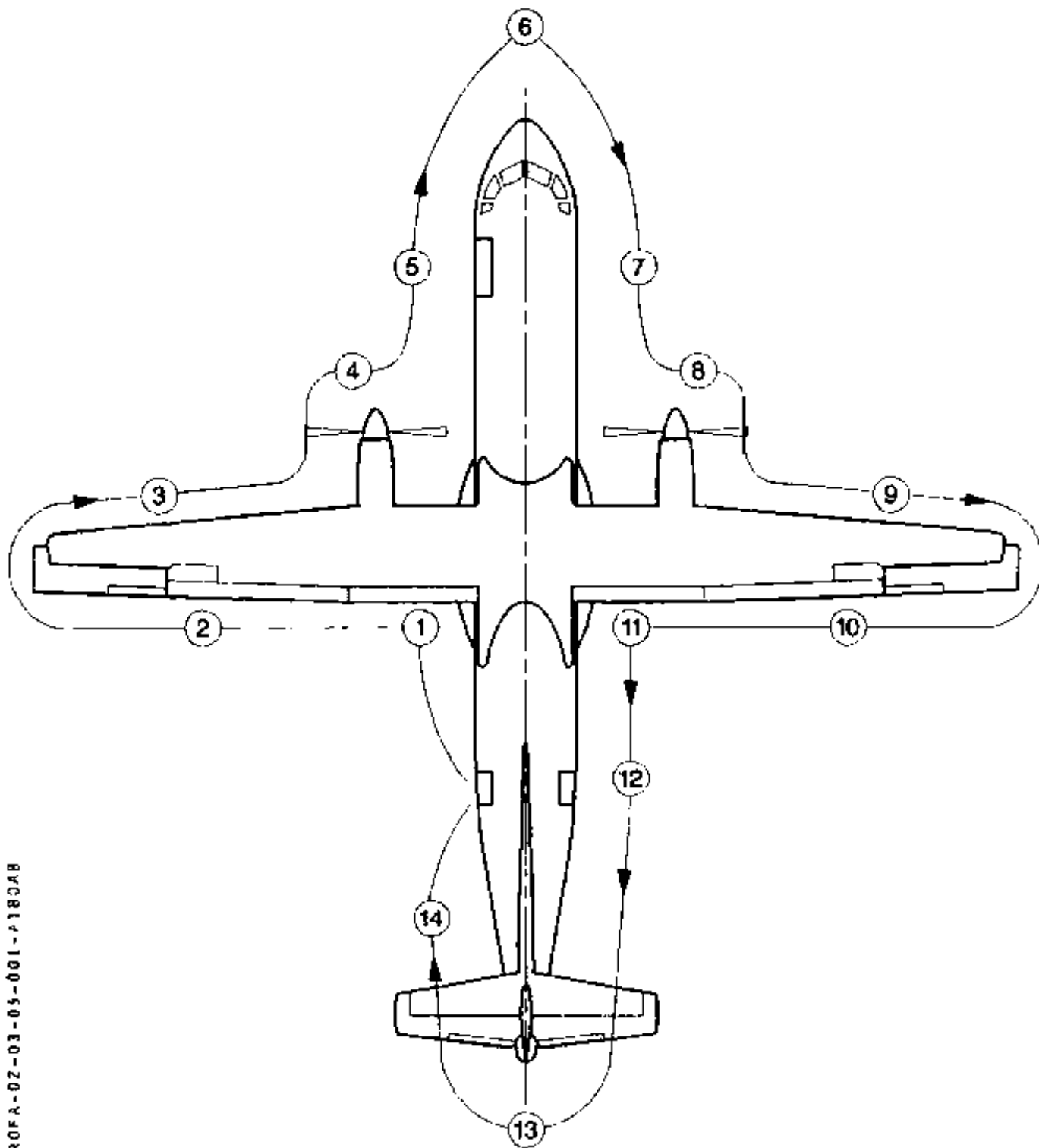

ROFA-02-03-05-001-P180AB

	NORMAL PROCEDURES	2.03.05		
		P 2	180	
	EXTERIOR INSPECTION			JUN 97

The exterior inspection is primarily a visual check to ensure that the overall condition of the A/C, the visible components and equipments are safe for the flight. It is normally performed by maintenance or in the absence of maintenance by the F/O before each originating flight.

CONTROL SURFACES and FLAPS

During exterior walk around, observe that the flight control surfaces and flaps are clear and memorize surfaces position.

① MAIN LEFT LANDING GEAR AND FAIRING

PARKING BRAKE ACCUMULATOR PRESSURE . . . CHECK 1600 PSI MINIMUM
 MAINTENANCE DOORS CLOSED
 GEAR DOORS CHECK
 WHEELS AND TIRES CONDITION
 BRAKE TEMPERATURE SENSORS CHECK
 BRAKE WEAR DETECTORS CHECK
 LANDING GEAR STRUCTURE CHECK
 HYDRAULIC LINES CHECK
 WHEEL WELL CHECK
 UPLOCK OPEN

*Note : On ground, the landing gear uplock box in closed position leads to the red local UNLK alarm in the cockpit.
 The uplock box can be open by pulling the landing gear emergency extension handle. Then, replac it in its initial position.*

FREE FALL ASSISTER CHECK
 SAFETY PIN REMOVED
 BEACON LIGHT CHECK
 AIR CONDITIONING PANEL LOCKED
 PACK RAM AIR INLET CLOSED
 LANDING LIGHT CONDITION
 TAT PROBE CHECK
 MAGNETIC FUEL LEVEL IN

	NORMAL PROCEDURES	2.03.05		
		P 3	180	
	EXTERIOR INSPECTION			JUN 97

② **LEFT WING TRAILING EDGE**

- BANANA SEAL CHECK
- FLAPS CONDITION
- EXHAUST NOZZLE CLEAR
- FLAPS POSITION CHECK
- AILERON AND TAB CHECK
- STATIC DISCHARGERS CHECK
- HORN CONDITION

③ **LEFT WING LEADING EDGE**

- NAV AND STROBE LIGHTS CONDITION
- WING DE ICING BOOTS CONDITION
- FUEL VENT NACA INLET CLEAR
- MAGNETIC FUEL LEVEL IN
- ICE DETECTOR CHECK

④ **LEFT ENGINE**

- LEFT COWLINGS CLOSED / LATCHED (4)
- OIL COOLING FLAPS CHECK
- ENGINE AIR INTAKE CLEAR
- ENGINE DE ICING BOOTS CONDITION
- SPINNER CHECK
- PROPELLER FEATHERED, CONDITION, FREE ROTATION
- RIGHT COWLINGS CLOSED / LATCHED (4)
- INNER WING LEADING EDGE AND FAIRING CONDITION

⑤ **LEFT FORWARD FUSELAGE**

- WING AND EMERGENCY LIGHTS CONDITON
- EMERGENCY EXIT CLOSED
- AVIONICS VENT OVBD VALVE OPEN
- CARGO DOOR OPERATING PANEL DOOR CLOSED
- CARGO DOOR CLOSED/LATCHED
- O2 BOTTLE OVERLOAD DISCHARGE INDICATION GREEN



ATR 72
F.C.O.M.

NORMAL PROCEDURES

2.03.05

P 4

200

EXTERIOR INSPECTION

JUN 97

ANGLE OF ATTACK PROBE CONDITION
 COCKPIT COMMUNICATION HATCH CHECK
 ICING EVIDENCE PROBE CONDITION
 STATIC PORTS CLEAR
 PITOT PROBES AND COVERS CHECK/REMOVED

⑥ NOSE

WIPERS CONDITION
 RADOME AND LATCHES CHECK
 NOSE GEAR WHEELS AND TIRES CONDITION
 NOSE GEAR STRUCTURE CONDITION
 TAXI LIGHTS CONDITION
 WHEEL WELL CHECK
 SAFETY PIN REMOVED
 NOSE WHEEL STEERING CONDITION
 HYDRAULIC LINES CONDITION
 NOSE GEAR DOORS CONDITION (2 CLOSED)

⑦ RIGHT FORWARD FUSELAGE

PITOT PROBE AND COVER CHECK/REMOVED
 STATIC PORTS CLEAR
 ANGLE OF ATTACK PROBE CONDITION
 EXTERNAL DC AND AC ELECTRICAL POWER ACCESS DOORS CHECK
 EMERGENCY EXIT CHECK
 EMERGENCY LIGHT CONDITION
 ANTENNAE CHECK
 WING LIGHT CONDITION

⑧ RIGHT ENGINE

INNER WING LEADING EDGE AND FAIRING CONDITION
 LEFT COWLINGS CLOSED/LATCHED (4)
 ENGINE AIR INTAKE CLEAR
 ENGINE DE ICING BOOTS CONDITION
 SPINNER CHECK
 PROPELLER . FEATHERED, CONDITION, FREE ROTATION if prop brake not set
 RIGHT COWLINGS CLOSED/LATCHED (4)
 OIL COOLING FLAPS CHECK

	NORMAL PROCEDURES	2.03.05		
		P 5	180	
	EXTERIOR INSPECTION			JUN 97

AA

9 RIGHT WING LEADING EDGE

WING DE ICING BOOTS CONDITION
MAGNETIC FUEL LEVEL IN
FUEL VENT NACA INLET CLEAR
NAV AND STROBE LIGHTS CONDITION
HORN CONDITION

10 RIGHT WING TRAILING EDGE

STATIC DISCHARGERS CHECK
AILERON AND TAB CHECK
FLAPS CONDITION
EXHAUST NOZZLE CLEAR
FLAPS POSITION CHECK
BANANA SEAL CHECK

11 MAIN RIGHT LANDING GEAR AND FAIRING

MAGNETIC FUEL LEVEL IN
TAT PROBE CHECK
LANDING LIGHT CONDITION
AIR CONDITIONING GROUND CONNECTION LOCKED
PACK RAM AIR INLET CLOSED
REFUELING CONTROL PANEL ACCESS DOOR CLOSED/LATCHED
GEAR DOORS CHECK
LANDING GEAR STRUCTURE CHECK
HYDRAULIC LINES CHECK
WHEEL WELL CHECK
UPLOCK OPEN
FREE FALL ASSISTER CHECK
SAFETY PIN REMOVED



ATR 72
F.C.D.M.

NORMAL PROCEDURES

2.03.05

P 6

180

EXTERIOR INSPECTION

JUN 97

WHEELS AND TIRES CONDITION
 BRAKE WEAR DETECTORS CHECK
 BRAKE TEMPERATURE SENSORS CHECK
 REFUELLING POINT ACCESS DOOR CHECK

12 RIGHT AFT FUSELAGE

VHF ANTENNA CHECK
 SERVICE DOOR CHECK
 TAIL PROP AND TAIL SKID CHECK
 OUTFLOW VALVES CHECK

13 TAIL

FLT CONTROLS ACCESS DOOR LOCKED
 VOR ANTENNAE CHECK
 STABILIZER DE ICING BOOTS CONDITION
 LOGO LIGHTS (when installed) CHECK
 HORNS CONDITION
 STABILIZER, ELEVATORS AND TABS CHECK
 STATIC DISCHARGERS CHECK
 FIN, RUDDER AND TAB CHECK
 TAIL CONE, NAV AND STROBE LIGHTS CHECK
 VORTEX GENERATORS CHECK

14 LEFT AFT FUSELAGE

WATER SERVICE PANEL ACCESS DOOR CLOSED
 TOILET SERVICE PANEL ACCESS DOOR CLOSED
 CABIN DOOR CHECK
 ENTRY EMER LIGHT CONDITION

	NORMAL PROCEDURES	2.03.06		
		P 1	250	
	PRELIMINARY COCKPIT PREPARATION			JUL 98

AA

The following procedure will be performed prior to the powering of the aircraft either by maintenance or the F/O as appropriate. Completion ensures there will be no danger to A/C and personnel when powering the systems.

CARGO DOOR CONTROL PANEL COVER

MFC 1A and 2A are directly supplied if the cargo door control panel cover is not closed and auto-check has been performed when voltage applied. Therefore full MFC check as R described here after, could not be visually observed. In this case, reset MFC 1A and 2A.

BATTERIES

- Set BAT toggle SW to ON.
 - . Check MFC 1A and MFC 2A FAULT lights flash.
 - check MFC 1A and MFC 2A FAULT lights extinguish and MFC 1B and MFC 2B FAULT lights flash.
 - check MFC 1B and MFC 2B FAULT lights extinguish.
 - . Check EMER BUS and ESS BUS supply ind.: arrows illuminated.
- R . Check UNDV light extinguished.

LATERAL AND OVERHEAD C/B PANELS

- Check that all C/Bs are set, reset as applicable.

EMERGENCY EQUIPMENT

- Check:
 - . exit hatch closed, handle locked and safetied, escape rope stowed
 - . life jackets stowed (if installed)
 - . axe stowed
 - . flashlights stowed
 - . smoke goggles stowed
 - . portable fire extinguisher safetied and pressure within the green area
 - . oxygen masks stowed
 - . L/G emergency extension handle stowed, cover closed
 - . Protective glove.

PARKING BRAKE

- Check BRAKE ACCU pressure.
- Use HYD AUX PUMP if necessary.
- Set handle to PARKING.

ENGINE

- Both PL on GI.
- Both CL on Fuel SO.
- Both EEC selected ON.
- Both PEC selected ON.

FLIGHT CONTROLS

- Check GUST LOCK engaged.
- Check/Set FLAPS control lever position to agree with actual flaps position.

	NORMAL PROCEDURES PRELIMINARY COCKPIT PREPARATION	2.03.06		
		P 2	001	
				DEC 96

AA

LANDING GEAR

- Check control lever DOWN.

PROPELLER BRAKE (Hotel mode only)

- Check ON light illuminated, UNLK light extinguished.
- Check PROP BRK light illuminated on memo panel.

WIPERS

- Check both WIPER rotary selectors at OFF position.

ENG 2 FIRE PROTECTION (only without use of GPU)

- Check ENG 2 fire handle IN and latched.
- Extinguish any white lt.
- Depress SQUIB TEST pb and check both AGENT SQUIB lt illuminate.
- Select TEST sw on FIRE and check :
 - . ENG FIRE red lt illuminates into associated fire handle.
 - . CCAS is activated (CRC + MW lt flashing red + ENG 2 FIRE red lt on CAP).
 - . FUEL SO red light illuminates in CL 2 if temporarily selected out of FUEL SO.

R

- Select TEST sw on FAULT and check :
 - . both LOOP A and LOOP B FAULT lt illuminate.

FUEL (only without use of GPU)

- Select ENG 2 PUMP ON.
 - . check RUN lt illuminates.
 - . check FEED LO PR lt extinguishes.
 - . check LP VALVE in line.

COM

- Set VHF 1 to ON

DOORS

- Cockpit communication hatch opened (as required).

BEACON (before propeller running)

- Set BEACON switch to BEACON.



NORMAL PROCEDURES

2.03.06

P 3

070

PRELIMINARY COCKPIT PREPARATION

JUL 98

ENG 2 START (ONLY WITHOUT USE OF GPU)

- Check EEC FAULT light extinguished
- Check PEC FAULT light extinguished.
- Set ENG START rotary selector to START
- Check engine and propeller area clear
- R - Depress START 2 pb, ON light illuminates (starter electrically supplied)
 - . Monitor engine rotation (NH)
 - On passing 10 % NH
 - . Advance CL to FTR
 - . Start timing
 - Note : Passing from FUEL SO to FTR is possible between 10 and 19 % NH if ITT > 200°C.*
 - Monitor light up within 10 seconds:
 - . 840°C < ITT < 950°C record in log book
 - ITT > 950°C FUEL SO
 - ITT > 840°C more than 20 s. FUEL SO
- R - On passing about 45 % NH, monitor START 2 pb ON light extinguishes
- R - On passing about 61,5 % NH, monitor DC GEN 2 FAULT light extinguishes
- Check engine stabilized parameters at idle values,
 - NH 67 % \pm 2 %, ITT 580° \pm 50°C, FF 110 kg/h (243 lb/h)
 - Note : TQ indications are unreliable when CL in FTR position.*
- Set ENG START rotary selector to OFF-START ABORT
- Adjust PL as required.
 - Note : If Z \geq 5000 ft and SAT \geq ISA + 25°C, advance PL up to GUST LOCK stop.*

CAUTION : DO NOT USE ENG 2 in HOTEL MODE:

- without a qualified person (flight crew or maintenance) in the cockpit.
- when tail wind component exceeds 10 kts (gust included). In this case, propeller must be unfeathered rapidly to take advantage of the air flow created by the propeller rotation and consequently to avoid exhaust gas return flow in the nacelle.

MAIN ELEC PWR

- If GPU not used
- R . Scan MAIN ELEC PWR panel: no amber light illuminated except DC GEN 1 FAULT light
- If GPU used
 - . Check DC EXT PWR AVAIL light illuminated
 - . Select DC EXT PWR ON
- R . Scan MAIN ELEC PWR panel: no amber light illuminated except DC GEN FAULT lights.



AR72
E.C.O.M.

NORMAL PROCEDURES

2.03.06

P 4

040

PRELIMINARY COCKPIT PREPARATION

DEC 94

48

R FUEL

- Check FUEL QTY ind. operative
- Reset Fuel used.

R ANN LT

- Set ANN LT switch to TEST and, check that all lights illuminate ; then return to BRT or DIM as required

R AIR BLEED / COMPT TEMP

Scan AIR BLEED / COMPT TEMP panel :

In Hotel mode :

- . No amber or white light illuminated except ENG 1 BLEED FAULT and X VALVE OPEN.
- If GPU used ;
 - . Extinguish any white light
- If neither GPU nor propeller brake used
 - . No amber or white light illuminated except ENG 1 BLEED FAULT and PACK 1 FAULT

R AVIONICS VENT

- Check OVBD VALVE CTL switch guarded in AUTO position
- Check no amber or white light.

	NORMAL PROCEDURES	2.03.07		
		P 1	180	
	COCKPIT PREPARATION			JUL 98

AA

INTRODUCTION

Cockpit preparation is split between:

- system preparation: performed by the F/O only
- cockpit final preparation: performed by CAPT and F/O at their stations all steps have to be performed prior to each flight

SYSTEM PREPARATION

1 INTERNAL LIGHTING

- Set as required

2 GEAR PINS

- Check three on board and stowed

OVERHEAD PANEL

1 CALLS/SELCAL (WHEN INSTALLED)

- R - Check light extinguished - Reset as required.

2 FUEL

- Select ENG 1 PUMP ON.
- R . check RUN light illuminates.
- R . check FEED LO PR light extinguishes.
- R . check LP VALVE in line.
- R . check X FEED VALVE X line.
- If GPU is used, apply the same procedure for ENG 2.

3 DOORS

- Depress Sw TEST pb.
- . Check CAB OK and SVCE OK lights illuminate, provided associated doors are open.
- R - Check DOORS light as required.

4 SPLR

- R - Check both lights extinguished.

5 LDG GEAR

- R - Check for normal indication - Crosscheck with center instrument panel.

6 MFC

- Scan MFC panel: no amber light illuminated.

	NORMAL PROCEDURES	2.03.07		
	COCKPIT PREPARATION	P 2	001	
				JUN 95

AC

7 ENG 1 FIRE PROTECTION

- Check ENG 1 fire handle IN and latched.
Extinguish any white light.
- Depress SQUIB TEST pb and check both AGENT SQUIB lights illuminate.
- Select TEST sw on FIRE and check :
 - . ENG FIRE red lt illuminates into associated fire handle.
 - R . CCAS is activated (CRC + MW light flashing red + ENG 1 FIRE red light on CAP).
 - R . FUEL SO red light illuminates in CL 1 if temporarily selected out of FUEL SO.
- Select TEST sw on FAULT and check :
 - . Both LOOP A and LOOP B lights illuminate
 - . CCAS is activated (SC + MC light flashing amber light + LOOP amber light on CAP).
- If GPU is used, apply the same procedure for ENG 2.

8 EXT LT

- Set as required.

9 COCKPIT VOICE RECORDER

- Depress TEST pb : pointer moves to a location between graduations 8 and 10.

10 SIGNS (only without use of GPU)

- Arm EMER EXIT LT.

11 ANTI-ICING/DE-ICING

- Check all lt extinguished.

12 PROBES HTG/WINDSHIELD HTG

- Extinguish any white lt.

13 AC WILD ELEC POWER

- Extinguish any white lt.

14 HYD PWR

- Extinguish any white lights.
- Check BLUE and GREEN PUMP LO PR lt illuminated and other lt extinguished.

15 EMER LOC XMTR (when installed)

- Check sw to AUTO, guarded and lockwired.

16 SELCAL CODE SELECTION PANEL (when installed)

- As required

 ATR 72 F.C.O.M.	NORMAL PROCEDURES		2.03.07	
			P 3	110
	COCKPIT PREPARATION			JUL 98

AA

17 AIR BLEED/COMPT TEMP

- If GPU not used.
 - Check COMPT and DUCT ind. show realistic values with COMPT SEL on FLT COMPT and CABIN.
- If GPU used.
 - Extinguish any white light.
 - COMP TEMP selectors as required.

18 OXYGEN

- Check oxygen high pressure indication.
- Check oxygen duration chart in the 2.01.05 to determine that quantity is sufficient for the sheduled flight.
- Select MAIN SUPPLY ON : check pb it extinguished.
- Check PAX SUPPLY OFF.

COMPT SMK (if installed)

depress SMK TEST pb to check smoke detectors.

Note : when the test is finished, reset AVIONICS VENT EXHAUST MODE pb to restart extract fan.

PEDESTAL

FDEP (If installed)

- Check FDAU time base, adjust if necessary.
- R - Enter flight number on the data entry panel (only numbers between 0000 and 7999 are available).

TRIMS

- Check ROLL and YAW TRIM operation.
- Check STBY PITCH TRIM operation, check sw guarded in OFF position.

RADIO\$

- Check transmission and reception.

ADF

- Select ADF.

XPDR

- Select STBY.

	NORMAL PROCEDURES	2.03.07		
	COCKPIT PREPARATION	P 4	070	
				JUL 00

AA

IDLE GATE

- Check it extinguished and amber band visible on the lever.

EMER AUDIO CANCEL

- Check sw guarded and lockwired.

RADAR

- Select STBY mode.

EFIS CONTROL PANELS

- Select EADI ON - check composite mode.
- Select EHSI ON - check normal display.
- Select EADI and EHSI brightness as necessary.
- Select BRG's as required.

R ATC 1 (if TCAS installed)

- Select STBY.

R TCAS (if installed)

- STBY/TEST.

CTR INSTRUMENT PANEL (CAPT)**TAT-SAT / TAS**

- Select proper ADC :
 - odd days : ADC 1
 - even days : ADC 2
- Cross check TAT value with control tower information.

STBY INSTRUMENTS

- Check no flags.
- Pull knob to erect standby horizon if necessary.

PWR MGT

- Check rotary selector on TO.

ENG 1 INSTRUMENTS

- Check
 - . OIL PRESS : 0
 - . OIL TEMP : realistic indications.
 - . FUEL TEMP : realistic indications.
 - . FF : 0 / FU : 0
 - . NH : 0
 - . ITT : realistic indications.
 - . NP : 0
 - . TQ : 0, target bug : realistic indication (crosscheck with ENG 2).

ENGINE CONTROLS

- Extinguish any white lt.

	NORMAL PROCEDURES	2.03.07		
	COCKPIT PREPARATION	P 5	030	
				JUL 00

AA

CAPT LATERAL CONSOLE

N/W STEERING

- Check N / W STEERING sw guarded on N / W STEERING position.

R OXYGEN MASK (once a day) without removing the mask.

- Set audio control panel INT / RAD selector to INT and adjust volume.

Depress and hold the PRESS TO TEST AND RESET pb (hose and mask charged with oxygen).

- observe blinker momentarily turns yellow and must turn dark if there is no leak.

Hold the PRESS TO TEST AND RESET pb and press the red grips on each side of the hose (oxygen pressure inflates the harness).

- observe blinker momentarily turns yellow and must turn dark if there is no leak.

Hold the PRESS TO TEST AND RESET pb and select the EMERGENCY knob (Emergency flow is tested).

- observe blinker turns yellow during the oxygen flow and must turn dark when the knob is released.

Note : In these three cases, check that oxygen flow sounds through loudspeakers.

- Check OXY LO PR light not lit
- Set N/100 % rocker lever to 100 %

MKR

- Provided NAV receivers are ON, depress TEST button.
Check three white boxes appear on bottom right of EADI's displaying O,M and I markers side by side.

AHRS

- Check AHRS 1 It extinguished

CAPT SWITCHING

- Check ATT / HDG, VOR / ILS and EFIS SG extinguished

AUDIO

- Check AUDIO 1 SEL It extinguished

GPWS

- Check GPWS sw guarded in NORM position and GPWS FAULT It not illuminated on CAP

	NORMAL PROCEDURES	2.03.07		
		P 6	001	
	COCKPIT PREPARATION			SEP 89

CAPT INSTRUMENT PANEL

RMI / EHSI

- Crosscheck heading information

VSI

- Check no flag and pointer indicates zero

CLOCK

- Check time, adjust if necessary

ASI

- Check
 - . no flag
 - . airspeed pointer indicates 0
 - . VMO pointer indicates 250 kt

EADI

- Check no flags

GPWS

- Test if desired (refer to 1.15.40 for test procedure)

ALTIMETER

- Check no flag

	NORMAL PROCEDURES COCKPIT PREPARATION	2.03.07		
		P 7	001	
				JUN 95

CTR INSTRUMENT PANEL (F/O)

PRESSURIZATION

- Check all It extinguished.
- Check MAN RATE knob : NORM.
- Check cabin press ind :
 - . DIFF : 0
 - . RATE : 0
 - . ALT : pressure altitude.

STICK PUSHER / SHAKER

- Check FAULT It extinguished.

ANTI SKID

- Check all It extinguished.

F / O LATERAL CONSOLE

R OXYGEN MASK (once a day)

- Same as for CAPT.

AHRS

- Check AHRS 2 It extinguished.

F / O SWITCHING

- Check ATT / HDG, VOR / ILS and EFIS SG It extinguished.

AUDIO

- Check AUDIO 2 SEL It extinguished.



ATR 72
F.C.O.M.

NORMAL PROCEDURES

2.03.07

P 8

001

COCKPIT PREPARATION

SEP 89

F / O INSTRUMENT PANEL

VSI

- Check no flag and pointer indicates zero

EHSI / RMI

- Crosscheck heading information

ALTIMETER

- Check no flag

EADI

- Check no flags

ASI

- Check
 - . no flag
 - . airspeed pointer indicates 0
 - . VMO pointer indicates 250 kt

CLOCK

- Check time, adjust if necessary

 AF 72 F.C.O.M.	NORMAL PROCEDURES	2.03.07		
	COCKPIT PREPARATION	P 9	001	
			JUL 98	

AA

COCKPIT FINAL PREPARATION

CM

1

SIGNS

- Select NO SMOKING and SEAT BELTS - Check MEMO panel.

2

LANDING ELEVATION

- If QNH is used, set landing field elevation.
- If QFE is used, set 0.

2

ATIS

- Obtain ATIS information

1-2

ALTIMETERS

- Set baro reference
- Check indications

1-2

BUGS

- ASI BUGS : - Set external bugs as follows :

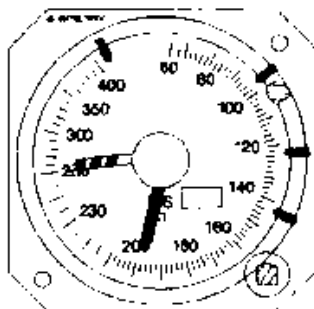
 ROP4-02-03-07-009-1001A4
 0000

- Lower value V 1
 - Intermediate value FINAL TAKE OFF SPEED
 - VmLB0 normal cond or
 - VmLB15 icing cond and not less than V2
 - Higher value Min. ICING SPEED (Flaps 0) : (VmLB 0 ICING COND)
- Set internal bug to V2

1

- TQ BUGS Set manual bugs to TO value

Note : As a crosscheck procedure, TO torques should be computed, by using power setting torque tables with a temperature not measured through aircraft systems.

1

TRIMS

- Reset ROLL and YAW trims to zero.
- Set PITCH trim for take off.

2

COM / NAV

- Set COM / NAV frequencies.

2

ENG TEST

Turn ATPCS to ARM

- CHECK ATPCS ARM green light illuminates.

Turn ATPCS to ENG position.

- CHECK associated ENG UPTRIM light illuminates.
- 2.15 s later check ATPCS ARM light extinguishes.

1

FUEL QUANTITY

- Test FUEL QTY and check LO LVL.
- Check both tanks are loaded symetrically and total corresponds to FLIGHT PLAN fuel.

1-2

SEAT, SEAT BELTS, HARNESSSES AND RUDDER PEDALS

- Crew members adjust their seats, seat belts, shoulder harnesses and rudder pedals (should be performed when rudder is in neutral position)

	NORMAL PROCEDURES BEFORE TAXI	2.03.08		
		P 1	001	
				DEC 94

AA

CM

- R 1 **LOAD SHEET**
 - Check the load sheet
- R 2 **TAKE OFF DATA**
 - Prepare take off data card
- R 1 **PARKING BRAKE**
 - Check handle to PARKING
- R 1 **START UP CLEARANCE**
 - At this stage, the before start preparation is stopped to allow :
 - . CM 1 to obtain ground crew clearance
 - . CM 2 to obtain ATC start up clearance
- R 2 **DOORS**
 - Check all doors are closed
- R 1 **BEACON**
 - Set (or confirm) BEACON sw to BEACON

	NORMAL PROCEDURES		2.03.08		
			P 2	070	
	BEFORE TAXI				JUN 97

CM

ENGINES

* In Hotel Mode

- 2 Push the AUX HYD PUMP Pb.
- 2 Check READY light illuminates.
- 2 Check engine 2 and propeller area clear.
- 1 Retard PL down to G1 and announce « PROPELLER BRAKE OFF ».
- 1 Switch prop. brake off.
- 2 Check prop brake blue light extinguishes both on prop brake control panel and on memo panel.
- 2 Check UNLK light flashes then extinguishes.
- 1 Monitor NP increase.
- 2 When NP stabilised (15 %) advance CL. to AUTO.

Notes : *Prop brake release sequence must be initiated only if READY blue light is illuminated,
when pulsing the DC AUX PUMP Pb, the DC auxiliary pump runs for 30 seconds then stops unless a prop brake release sequence has been initiated.*

* If GPU is used.

SIGNS

– Arm EMER EXIT LT

ENG 2 START

CM

- Check EEC FAULT light extinguished.
- Check PEC FAULT light extinguished.
- 2 – Set ENG START rotary selector to START.
- 2 – Check RH engine and propeller area clear.
- 1 – Announce “START ENGINE 2” and monitor starting.
- 2 – Depress START 2 pb, ON light illuminates (starter electrically supplied).

CAUTION : If the ground power unit is not able to supply 1300 A during the transient while keeping voltage above 12V (16 KW), the protections and especially BPCU may lead to an impossibility to start. In that case, disconnect GPU and start from batteries.

- 1 – Announce “NH” when NH increases.
On passing 10 % NH :
– Advance CL to FTR, start timing

Note : *Passing from FUEL SO to FTR is possible between 10 and 19 % NH if ITT > 200° C.*

- 1+2 Monitor light up within 10 seconds.
840°C < ITT < 950°C record in log book.
ITT > 950°C FUEL SO.
ITT > 840°C more than 20s, FUEL SO.

	NORMAL PROCEDURES	2.03.08		
		P 3	070	
	BEFORE TAXI			JUL 98

CM

- 1 - Announce "NP" when NP increases.
- 2 - On passing around 45% NH, monitor START 2 pb ON light extinguishes.
- R 1 - Check engine stabilized parameters at idle value (at ISA, sea level: ITT about 580°C ± 50°C, NH about 67%, FF about 110 kg/h/ 243 lb/h).
- R 2 - Advance CL AUTO. Check low pitch light illuminates. Check NP is stabilized at 70.8%.
- Set ENG START rotary selector to OFF-START ABORT.

MAIN ELEC PWR

- Select DC EXT PWR OFF.
- Monitor DC GEN 2 FAULT light extinguishes.
- Request ground crew to disconnect external power.

2 AC WILD ELEC PWR

- Check all lights extinguished except ACW GEN 1 FAULT.

2 HYD PWR

- Check all lights extinguished.

2 FLAPS

- Set for take off - Check position on flaps position ind.

2 ANTI SKID

- R Perform anti skid test check no F It remain illuminated.

1 GROUND CREW CLEARANCE

- Request . chocks removed.
- . tail prop removed.
- . interphone disconnected.
- . hand signal display on the LH side.

COM/NAV

- Radar on STBY position.

ALL BEFORE TAXI CHECK-LIST

- Completed.

	NORMAL PROCEDURES TAXI	2.03.09		
		P 1	001	
				JUN 94

AA

Note : When taxiing with tail wind component use of reverse requires special care as wind created by propeller reversion combined with tail wind will induce an exhaust gas return flow which may damage the nacelle. It is consequently recommended not to leave PL in reverse position for any period of time exceeding 10 seconds.

CM

2 TAXI CLEARANCE

- Obtained

1 EXT LTS

- Set as required

1 BRAKES

- Parking brake released
- Check braking (normal and EMER)

ALL TAKE-OFF DATA

- Recheck take off conditions
- Crosscheck V bugs settings

2 ATC CLEARANCE

- Obtained

ALL FLIGHT INSTRUMENTS

- R
- Scan instruments panels, check no unnecessary flag on instruments
 - Check in turn
 - . horizons
 - . heading and bearing
 - . ball

	NORMAL PROCEDURES		2.03.09	
	TAXI		P 2	070
			JUL 00	

AA
CM

ENG 1 START

- Check PEC FAULT It extinguished.
- 2 - Check EEC FAULT It extinguished.
- 2 - Set ENG START rotary selector to START.
- 1 - Check engine and propeller area clear.
- 1 - Announce "START ENGINE 1" and monitor starting.
- 2 - Depress START 1 pb, ON It illuminates (starter electrically supplied).
- 2 - Announce "NH" when NH increases.
- On passing 10 % NH :
 - 2 . Note positive oil pressure.
 - 2 . Advance CL to FTR, start timing.
- Note : Passing from FUEL SO to FTR is possible between 10 and 19% NH when ITT > 200°C.*
- 2 . Monitor light up within 10 seconds.
 - 840°C < ITT < 950°C, record in log book
 - ITT > 950°C, FUEL SO
 - ITT > 840°C more than 20 s, FUEL SO
- 2 - Announce "NP" when NP increases.
- 2 - On passing around 45 % NH, monitor START 1 pb ON It extinguishes.
- 2 - On passing around 61.5 % NH, monitor GEN 1 FAULT and BTC flow bar It extinguishes.
- 2 - Check engine stabilized parameters at idle values ISA, SEA LEVEL.
 - NH : 67%
 - ITT : 580°C ± 50°C
 - FF : 110 kg/h (243 lb/h)
- 2 - Advance CL to AUTO. Check low pitch light illuminates.
Check Np is stabilized at 70.8 %.
- 2 - Set ENG START rotary selector to OFF-START ABORT.

AIR BLEED

- Check all lights extinguished.
- R - COMPT TEMP SELECTOR, as required.

DOORS

- Cockpit communication hatch closed.

AC WILD ELEC PWR

- Check all lights extinguished.

ALL AFCS

- Select
 - . assigned altitude.
 - . HDG Lo BANK with runway heading.
 - . IAS with V2 + 5 kt
- Select CPL on PF side.

	NORMAL PROCEDURES TAXI	2.03.09		
		P 3	001	
				DEC 94

AB

CM

1 TAKE-OFF BRIEFING

- Standard calls
- For significant failure before V1, CAPT will call « STOP » and will take any necessary stop action
- Above V1 take-off will continue and no action will be taken except on CAPT command
- Single engine procedure is
- Acceleration altitude is
- Departure clearance is.

2 CABIN REPORT

- Obtain cabin report from cabin attendant

R

2 TO CONFIG TEST

- Depress TO CONFIG TEST and check no alert

ALL TAXI CHECK LIST

Completed

	NORMAL PROCEDURES BEFORE TAKE OFF	2.03.10		
		P 1	150	
				JUL 00

AA

CM

1-2 **FLIGHT CONTROLS**

- Release gust lock.
- Check full travel and freedom of movement in PITCH, ROLL (check SPOILER It), YAW.

2 **TAKE OFF CLEARANCE**

- Obtained.

2 **AIR BLEED**

- Select both BLEED VALVES on NORM FLOW.

2 **EXT LT**

- Set STROBE It (if installed).
- Use TAXI and TO and LAND It to minimize bird strike hazard during TO.

1 **CCAS**

- Select TO INHI.

2 **XPDR**

- Set as required.

R **TCAS (If installed)**

- AUTO mode.

COM / NAV

- Radar as required.

1 **ENGINES**

- Check both CL at AUTO position.

1-2 **FLIGHT CONTROLS**

- Check rudder releasable centering unit is centered (pedals centered, brief action on rudder trim switches).
- Runway heading lined up, center lateral FD BAR.

ALL **BEFORE TAKE OFF CHECK-LIST**

- Completed

	NORMAL PROCEDURES TAKE OFF	2.03.11		
		P 1	001	
				JUL 00

AA

CM

PF Announce "TAKE OFF".

PF Release the brakes.

ALL Start timing.

PF Advance both PL to Power lever notch.

PNF - Check that actual TQ matches Take off TQ (manual bug). If necessary PNF moves PL out of notch to adjust TQ as required.

- check 100 % NP (+ 0.8 %, - 0.6 %) upon reaching 60 kt.

- check ATPCS ARM light illuminated.

- check FDAU bug displays RTO value.

- call "power set".

PNF Scan the airspeed and engine instruments throughout take off.

SPEED

PNF Announce "SEVENTY KNOTS" read on ASI and crosscheck reading on STBY ASI.

R PF Crosscheck speed reading on his own ASI, announce "I have control".

PNF Announce "V1".

PNF Announce "ROTATE" at VR.

AIRCRAFT HANDLING

PF At VR, rotate smoothly to the average single engine climb pitch attitude. Then accelerate progressively to VmLBO.

LANDING GEAR

PNF Announce "POSITIVE CLIMB".

PF Order "GEAR UP".

PNF Set L/G lever to UP - Check It extinguish.

PNF **AFCS**

- Engage YD.

	NORMAL PROCEDURES AFTER TAKE OFF	2.03.12		
		P 1	150	
				JUL 98

AA

CM

Passing acceleration altitude.

PF

ENGINES

- Order "CLIMB SEQUENCE".

AFCS

R PF

- Increase selected speed with PTW.

Note : in case of manual flight, this action will be performed by PNF.

PNF

ENGINES

R

- Check PLs in the notch

- Set PWR MGT to CLB

PNF

AIR BLEED

- Select both BLEED VALVES ON if not already been selected.

Note : Pack 2 valve FAULT will illuminate during 10 s. (A ten seconds delay is used for Pack valve 2 to avoid pressure shocks).

PNF

EXT LTS

- Set as required.

PNF

SIGNS

R

- Set NO SMOKING SW to OFF.

PNF

ENGINES

- Check that actual TQ matches climb TQ, adjust if necessary. If the airline has chosen to reduce power in climb, set PLA according to the airline derated tables.

FLAPS

PF

- Passing VMLB0, order "FLAPS 0".

PNF

- Move flaps control lever to 0, announce "FLAPS 0" when position ind. shows 0.

AFCS

R PF

- Set ADU target IAS to the desired climb speed.

ALL

ALTIMETERS

- Passing the transition altitude, set standard pressure (1013.2 HPa/29.92 in Hg) on CM1, CM2 altimeter-Crosscheck settings.

ALL

AFTER TAKE OFF CHECK-LIST

- Completed.

	NORMAL PROCEDURES CRUISE	2.03.13		
		P 1	510	
				JUL 99

AA

CM

PF **ENGINES**

After acceleration to cruise speed has been performed :

- Select PWR MGT CRZ.
- Check actual cruise torque matches cruise torque.
Adjust if necessary. If the airline has chosen to reduce power in cruise, set PLA according to the airline derated tables.

R PNF **SIGNS**

- Set SEAT BELTS sw as required

ALL **FLIGHT CONDITIONS** **OBSERVED**

PF ■ **If entering icing conditions**

ANTI-ICING PERFORMED
 MODE SEL AUTO
 MINIMUM ICING SPEEDS BUGGED AND OBSERVED
 ICE ACCRETION MONITOR

PF **OPERATION WITH ICE ACCRETION**

PROP - HORNS - SIDE WINDOWS confirm ON
 MODE SEL confirm AUTO
 ENG DE-ICING confirm ON
 AIRFRAME DE-ICING ON
 MINIMUM ICING SPEEDS confirm bugged and observed

R **BE ALERT TO SEVERE ICING DETECTION**

In case of severe icing, refer to 2.04.05.

R
R
R

■ **If significant vibrations occur :**

- CLs 100 OVRD for not less than 5 minutes

 AJR 72 F.C.O.M.	NORMAL PROCEDURES DESCENT	2.03.14		
		P 1	001	
				JUL 98

CA

CM

ALL **FLIGHT CONDITIONS** **OBSERVED**

PF RELEVANT ANTI OR DE ICING, ...UP to landing PERFORMED IF NECESSARY

PF **CCAS**

- Depress RCL pb and check aircraft status.

PNF **WEATHER AND LANDING INFORMATION**

- Obtain all required information.

PNF **LANDING DATA**

- Determine landing weight, configuration and speeds
- Fill in data card
- Check landing field elevation on LANDING ELEVATION counter if QNH is used (or 0 if QFE is used).

BUGS

ALL - ASI BUGS

- Set external bugs as follows :

R
R
R
3024-12-01-14-001-ACC112

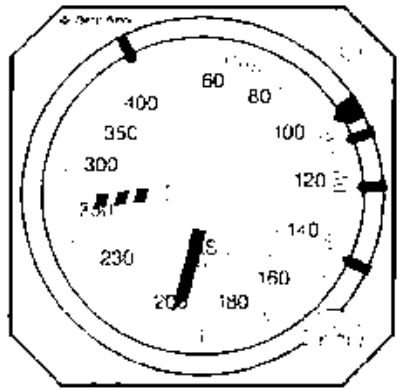

- Lower value VGA
- Intermediate value SINGLE ENGINE CLIMB SPEED: VmLB0 normal cond or VmLB15 icing cond, and not less than V2
- Higher value Min. ICING SPEED (Flaps 0) : (VmLB 0 ICING COND)

- Set internal bug to VApp

PNF - TQ BUGS

Set manual bugs to GA torque

ALL **APPROACH BRIEFING**

- Main points are :
 - . minimum safe altitude
 - . weather at destination
 - . approach procedures
 - . decision height
 - . go around procedures
 - . alternate and extra fuel time

PNF **SIGNS**

- Set SEAT BELTS sw to SEAT BELTS

PNF **DESCENT CLEARANCE**

- Obtained.

PF **AFCS**

- Select assigned altitude
- Engage IAS or VS mode as required
- Use PTW and PL as required for descent.

DESCENT CHECK LIST

- Completed

	NORMAL PROCEDURES APPROACH	2.03.15		
		P 1	050	
				DEC 96

CM

PNF **SIGNS**

- Set NO SMKG sw to NO SMOKING

ALL **ALTIMETERS**

ADJUST ALTIMETERS SETTING when passing transition level and cross check settings

PNF **PRESSURIZATION**

- Check cabin altitude
Caution : Max ΔP authorized at landing : 0.35 PSI

ALL **SPEED Versus ICING AOA**

- Check and set

PF **EXT LT**

Select TAXI and TO and LAND It to ON

PNF **CABIN REPORT**

Obtain cabin report from cabin attendant

ALL **APPROACH CHECK LIST**

- Completed

	NORMAL PROCEDURES BEFORE LANDING	2.03.16		
		P 1	150	
				JUN 97

CM

Passing deceleration altitude.

ALL Crosscheck altitude.

PF Retard both PL down to Fl and reduce airspeed.

PF Passing 180 kt order « FLAPS 15 – »

PNF Select Flaps 15

PF Passing 170 kt order « GEAR DOWN »

PNF Select gear down -- PWR MGT TO.

Note : NP remains unchanged

PNF As soon as the three green lights are illuminated
Announce « FLAPS 15 - LANDING GEAR DOWN ».

PNF Check TLU OK (or LO SPD according to the version) light is lit.

PF Passing 150 kt order « FLAPS 30 ».

PNF Select Flaps 30 – Announce « FLAPS 30 » when indicated.

PF Adjust PL to maintain VAPP and not less than VMCL

ALL **BEFORE LANDING CHECK LIST**

Completed

	NORMAL PROCEDURES GO AROUND	2.03.17		
		P 1	001	
				JUL 98

AA

CM

PF Simultaneously

- Announce "GO AROUND"
- Depress GO AROUND pbs on PLs
- Advance PLs to ramp

R - Call "FLAPS one notch", rotate to GO AROUND pitch altitude

- PNF - Retract FLAPS one notch
- Check NP = 100 %, adjust if necessary

R PF - Follow FD bars and cancel AP Disconnect Alarm

R - Accelerate to or maintain VGA (see 2-02-01 p. 4)

- PNF - When positive rate of climb is achieved,
. Announce "POSITIVE CLIMB".

PF - Command "GEAR UP".

PNF - As soon as climb is established, select L/G lever to UP and select HDG/IAS.

- PNF - Announce "FLAPS X" when indicated (FLAPS X is one notch less than final approach FLAPS setting)
Announce "GEAR UP" when indicated.

- PNF - Monitor
- . pitch attitude
 - . bank attitude
 - . speed
 - . flight path
 - . engine parameters.

	NORMAL PROCEDURES LANDING	2.03.18		
		P 1	001	
				JUL 00

AA

CM

R PNF - Announce "500 feet above minimum", "100 feet above", "Minimum, Decide".

PF - Announce LAND or GO AROUND as appropriate

PF - Press AP disconnect pb twice

PNF - Check flight parameters

PNF - Check IDLE GATE automatic retraction at touchdown

PF - When touching down, act on the PL triggers to select GI

PNF - Check and announce "Both low pitch lights illuminated".

PF - Use reverse as necessary

1 - Control nose wheel steering

2 - Hold the control wheel as required

	NORMAL PROCEDURES	2.03.19		
		P 1	500	
	AFTER LANDING			JUL 99

AA

CM

FLIGHT CONTROLS

- 1 - Order "FLAPS 0".
- 2 - Select FLAPS 0 and reset TRIMS.
- 2 - Engage GUST LOCK and check PITCH and ROLL controls are locked.

EXT LT

- Set LAND light and STROBE light (when installed) to OFF.

IGNITION

- Check ENG START selector to OFF-START ABORT.

COM/NAV

- Switch OFF non required equipment.
- Transponder on STBY.
- Radar on STBY.;

ENG TEST (Last flight of the day)

- Conditions** : - Both CLs AUTO.
- Both PLs at GI.
- ATPCS pb depressed. OFF extinguished.
- PWR MGT on TO position.

- ARM positions** : - ARM light illuminates green.
- Torque indications increase.
- NP and NH indications decrease.

- ENG position** : - Selected engine torque decreases below 18%.
- Opposite engine :
- Torque does not change.
- UPTRIM light illuminates.
- Bleed FAULT light illuminates.
- NP and NH increase slightly.
- 2.15 seconds later :
- Concerned propeller is automatically feathered.
- ARM green light extinguishes.

R

- CAUTION** : - Do not perform ENG TEST while taxiing as ACW is temporarily lost and consequently, both main hydraulic pumps are temporarily lost as well.
- Do not perform ENG TEST while taxiing if DC hydraulic pump is not operating.
 - If braking is required during test it will be performed using EMER handle as required.

Note : If test must be repeated, wait 10 minutes before setting "ATPCS" selector in ENG position in order not to damage feathering pump (winding heating).

 AFR 72 F.C.O.M.	NORMAL PROCEDURES	2.03.19		
		P 2	001	
	AFTER LANDING			JUL 00

AA

R **TCAS (If installed)**

(runway vacated)

- Select STBY

1 **ENGINES**

Note : Keep engine running at least one minute at GI power before shut down to assist in reducing residual heat build up in the engine and nacelle.

- Select engine 1 CL to FTR then FUEL SO.

Note : After last flight of the day maintain feather position for 20 seconds before selecting FUEL SO (required for oil capacity check by maintenance).

- Note and reset FU.

All **AFTER LANDING CHECK LIST**

- Completed.

	NORMAL PROCEDURES	2.03.20		
		P 1	001	
	PARKING			DEC 97

AA

Note : As often as possible, park the a/c with wind relative to the nose at 10 o'clock to minimize noise and exhaust gaz interference when in hotel mode.

1 PARKING BRAKE

- Set parking brake handle to PARKING and check brake pressure.

Note : If propeller BRK is used, be sure propeller brake area is clear and protected.

1 Flight CONTROLS (last flight of the day)

- Release gust lock.

- Push Control column in nose down position.

R - Refer to 1.02.10 for STICK PUSHER SHAKER - YES test procedure.

R - Engage gust lock and check PITCH and ROLL controls are locked.

2 MAIN ELEC PWR (Only if GPU is used)

- Check ground crew connect external power unit.

- Check DC EXT PWR AVAIL light illuminates.

- Select DC EXT PWR ON.

1 ENGINES

In Hotel Mode

- Select engine 2 CL to FTR.

Note : If propeller brake is not available and provided PROP BRK is removed, activate PROP BRK switch and check AIR BLEED X VALVE OPEN light illuminates.

- Check READY lt illuminates.

- Engage PROP BRK.

- Check UNLK light illuminates then extinguishes.

- Check PROP BRK illuminates both on prop brake control panel and on memo panel.

- Note and reset FU.

If GPU is used

- Select engine 2 CL to FTR then FUEL SO.

Note : After last flight of the day, keep feather position for 20 secondes before selecting FUEL SO (required for oil capacity check by maintenance).

1 FUEL (only if GPU is used)

- Set both FUEL pump switches to OFF.

1 SIGNS

- Set SEAT BELTS sw to OFF.

2 GROUND CONTACT

- As required.

ALL PARKING CHECK LIST

- Completed.

TAIL PROP

- As required.

	NORMAL PROCEDURES LEAVING THE AIRCRAFT	2.03.21		
		P 1	001	
				NOV 93

AA

- OXYGEN MAIN SUPPLY OFF
- PROBES HTG/WINDSHIELD HTG OFF
- ANTI ICING/DE ICING (all devices) OFF
- EXT LT OFF
- EFIS controls OFF
- RADAR OFF
- COM OFF

- If GPU not used

ENG 2 CL FUEL SO

R *Note : After last flight of the day, keep FEATHER position 20 seconds before selecting*
R *FUEL S/O (required for oil capacity check by maintenance).*

FUEL PUMPS OFF

EMER EXIT LT DISARM

BATTERIES OFF

- If GPU used

R EMER EXIT LT DISARM

R DC EXT PWR OFF

R **CAUTION :** Before disconnecting the EXT PWR unit from the aircraft, check DC EXT
R PWR ON light extinguished.

R BATTERIES OFF

 NR72 F.C.O.M.	EMERGENCY PROCEDURES CONTENTS	2.04.00		
		P 1	001	
				DEC 97

AA

- 2.04.00 CONTENTS**
- 2.04.01 INTRODUCTION**
- 2.04.02 POWER PLANT**
 IN FLT ENG FIRE
 ON GND ENG FIRE
 BOTH ENGINES FLAME OUT
 ENG FLAME OUT AT TAKE OFF

- 2.04.03 SMOKE**
 ELECTRICAL SMOKE
 AIR COND SMOKE
 FWD SMOKE
 AFT SMOKE
 AUX AFT COMPT SMOKE (if installed)

R

R

R

- 2.04.04 ELECTRICAL SYSTEM**
 DUAL DC GEN LOSS

- 2.04.05 MISCELLANEOUS**
 EMERGENCY DESCENT
 DITCHING
 FORCED LANDING
 ON GND EMER EVAC
 BOMB ON BOARD
 SEVERE ICING

	EMERGENCY PROCEDURES INTRODUCTION	2.04.01		
		P 1	001	
				JUN 94

GENERAL

The emergency procedures have been established for application in the event of a serious failure. They are applied according to the « READ AND DO » principle except for memory items.

R

PRESENTATION

The procedures are presented in the basic checklist format with an adjacent expanded part which provides :

- indication of the particular failure (alert condition)
- explanation for actions where the reason is not self evident
- additional background information.

The abbreviation used are identical to the nomenclature on the cockpit panels. All actions are printed in capital letters.

Memory items are BOXED for identification.

If actions depend on a precondition, a preceding black square ■ is used to identify the precondition.

A preceding black dot • is used to indicate the moment when actions have to be applied.

TASK SHARING

For all procedures the general task sharing stated below is applicable. The pilot flying remains pilot flying throughout the emergency procedure.

PF – Pilot flying Responsible for :

- PL
- Flight path and airspeed control
- Aircraft configuration
- Navigation

PNF – Pilot non flying Responsible for :

- Check list reading
- Execution of required actions
- Actions on OVHD panel
- CL
- Communications

The AFCS is always coupled to the PF side (CPL selection).

 ATR 72 F.C.O.M.	EMERGENCY PROCEDURES INTRODUCTION	2.04.01		
		P 2	001	
				JUN 97

AA

PROCEDURES INITIATION

- No action will be taken (apart from depressing MW pb):
 - . Until flight path is stabilized.
- R . Under 400 ft above runway (except for propeller feathering after engine failure during approach at reduced power if go around is considered).
- Before performing a procedure, the crew must assess the situation as a whole, taking
 - R into consideration the failures, when fully identified, and the constraints imposed.

ANALYSIS OF CONSEQUENCES OF A FAILURE ON THE FLIGHT

Basic airmanship calls for a management review of the remaining aircraft capabilities under the responsibility of CM1.

CCAS

When TO INH has been selected, until the first leg of landing gear unlocks, all alerts are inhibited except:

- ENG 1 FIRE
- ENG 2 FIRE
- CONFIG
- FLAPS UNLK
- LDG GEAR NOT DN
- EXCESS ALT
- PITCH DISCONNECT
- PROP BRK

	EMERGENCY PROCEDURES	2.04.02		
		P 1	001	
	POWER PLANT			MAY 93

ENGINE FIRE

ALERT

CONDITION	VISUAL	AURAL
Fire signal	<ul style="list-style-type: none"> - MW light flashing red - associated ENG FIRE red light on CAP - red light in associated FIRE handle - FUEL SO red light in associated CL 	CRC

IN FLIGHT PROCEDURE

IN FLT ENG FIRE	
PL	FI
CL	FEATHER then FUEL S/O
FIRE HANDLE	PULL
1st agent after 10 s	DISCH
■ IF FIRE AFTER 30 s	
2nd agent	DISCH
LAND ASAP	
SINGLE ENG OPERATION PROCEDURE	APPLY

COMMENTS

- Fire handle remains illuminated as long as a fire is detected
- The 10 s delay allows to reduce nacelle ventilation in order to increase the agent effect.
- CRC stops when depressing MW. May be cancelled by use of EMER AUDIO CANCEL SW.
- Do not attempt to restart engine.
- Refer to « SINGLE ENG OPERATION » procedure.

	EMERGENCY PROCEDURES	2.04.02		
		P 2	001	
	POWER PLANT			JUN 94

ON GROUND PROCEDURE

ON GND ENG FIRE	
PL	GI/REV AS RQD
● WHEN A/C STOPPED	
PARKING BRAKE	SET
CL Both	FTR then FUEL SO
FIRE HANDLE illuminated	PULL
1st agent	DISCH
MIN CAB LIGHTS	ON
ATC (VHF 1)	NOTIFY
CABIN CREW (PA)	ALERT
FUEL PUMPS	OFF
■ If fire after further 30 s	
2nd agent	DISCH
■ If avacuation required	
2nd FIRE HANDLE	PULL
ENG START rotary selector	OFF/START ABORT
EVACUATION	INITIATE
BAT (before leaving aircraft)	OFF

COMMENTS

– Same comments as in flight.

The aircraft may be stopped using full reverse.

- Notify ATC the nature of the emergency and state intentions. Only VHF 1 is available on battery.
- Battery is left ON until leaving the aircraft to ensure cabin communication. Only PA is available on battery.



ATR 72
F.C.O.M.

EMERGENCY PROCEDURES

2.04.02

P 3

240

POWER PLANT

DEC 97

AA

BOTH ENGINES FLAME OUT

ALERT

An engine flame out may be recognized by a rapid decrease in ITT and in NH.

PROCEDURE

BOTH ENGINES FLAME OUT

PL both FI

■ **If NH drops below 30 % (no immediate relight)**

CL both FTR then FUEL SO
FUEL SUPPLY CHECK

Note : See engine relight envelope (2.05.02)

OPTIMUM SPEED Vm HB

COMMUNICATIONS VHF ↑

ENG START rotary selector START A & B

ENG 2 RELIGHT

ENG 2 START pb ON

At 10 % NH

CL 2 FTR

ENG 2 RELIGHT MONITOR

CL 2 then PL 2 AS RQD

ENG 1 RELIGHT

ENG 1 START pb ON

At 10 % NH

CL 1 FTR

ENG 1 RELIGHT MONITOR

CL 1 then PL 1 AS RQD

■ **If neither engine starts**

CL both FTR then FUEL SO

ENG START rotary selector OFF/START ABORT

FUEL PUMPS OFF

FORCED LANDING or DITCHING PROCEDURE APPLY

CAUTION : Do not select AVIONICS VENT EXHAUST MODE to OVBD.

■ **If engine(s) recovered**

CL 100 OVRD

PL AS RQD

SYSTEMS affected RESTORE

CL AS RQD

	EMERGENCY PROCEDURES	2.04.02		
		P 4	220	
	POWER PLANT			DEC 97

AA

COMMENTS

- Fuel supply check consists of checking correct fuel quantity and correct pressure (no local pressure alert).
- The optimum airspeed to achieve best lift to drag ratio is V_{mHB} .

IF BOTH ENG ARE LOST

- If landing gear extension is scheduled, emergency extension has to be performed.
- In short final, reduce speed as required by landing field in order to touch down with minimum vertical speed.
- If power supply still available is provided by batteries only, flaps' extension is impossible.

	EMERGENCY PROCEDURES	2.04.02		
	POWER PLANT	P 5	500	
				JUL 00

AA

ENG FLAME OUT AT TAKE OFF

ALERT

An engine flame out may be recognized by :

- Sudden dissymmetry
- TQ decrease
- Rapid ITT decrease

PROCEDURE

R

ENG FLAME OUT AT TAKE OFF	
UPTRIM	CHECK
AUTOFEATHER	CHECK
BLEED FAULT LT	CHECKED LIT
● At Acceleration Altitude	
PL	F1
CL	FTR then FUEL SO
BLEED	OFF if necessary
■ If damage suspected	
FIRE HANDLE	PULL
SINGLE ENG OPERATION PROCEDURE	APPLY
■ If no damage suspected	
ENG RESTART IN FLT PROCEDURE	APPLY
■ If unsuccessful :	
SINGLE ENG OPERATION PROCEDURE	APPLY

	EMERGENCY PROCEDURES SMOKE	2.04.03		
		P 1	001	
				DEC 94

ELECTRICAL SMOKE

ALERT

CONDITION	VISUAL	AURAL
Smoke detected in the avionics ventilation circuit	- MW light flashing red - ELEC SMK red light on CAP	CRC

PROCEDURE

ELECTRICAL SMOKE	
■ If warning generated by air conditioning smoke	
AIR COND SMOKE PROCEDURE	APPLY
■ If warning not generated by air conditioning smoke	
CREW OXY MASK/GOGGLES/CREW COMMUNICATIONS	AS RQD
AVIONICS VENT EXHAUST MODE	OVBD
RECIRC FANS both	OFF
AIR FLOW	HIGH
DC SVCE & UTLY BUS	OFF
DC BTC	ISOL
ACW GEN 1-2	OFF
SUSPECTED EQT	SHUT OFF
■ If smoke source not identified	
LAND ASAP	
ACW TOTAL LOSS PROCEDURE	APPLY
■ If smoke source identified	
NOT AFFECTED ITEMS	RESTORE
● When $\Delta P < 1PSI$	
OVBD VALVE	FULL OPEN
AVIONICS VENT EXHAUST MODE	NORM

AB

R

R

R
R
R
R
R
R
R
R



ATR 72
F.C.O.M.

EMERGENCY PROCEDURES

2.04.03

P 2

001

SMOKE

SEP 89

COMMENTS

- Avionics compartment ventilation without cabin contamination is ensured by :
 - selecting AVIONICS VENT EXHAUST mode OVBD
 - shutting off the recirculation fans
 - selecting the PACKS AIR FLOW HIGH.
- Auto isolation is prepared on the main electrical system by opening the BTC.
- Suspected equipment may be shut off contingently by pulling out associated circuit breaker.
- When Diff press is below 1 PSI, OVBD VALVE is selected FULL OPEN and AVIONICS VENT mode NORM in order to recover air evacuation capability through the EXTRACT FAN without any pressurization problem.

	EMERGENCY PROCEDURES SMOKE	2.04.03		
		P 3	001	
				JUL 00

AA

AIR COND SMOKE

PROCEDURE

AIR COND SMOKE	
OXY MASKS	ON / 100 %
CREW COMMUNICATIONS	ESTABLISH
GOGGLES	AS RQD
RECIRC FANS both	OFF
PACK 1 VALVE	OFF
MAX FL	200 / MEA
■ If smoke persists	
PACK 1 VALVE	ON
PACK 2 VALVE	OFF
CAUTION : EVACUATION OF AIR COND SMOKE MAY TRIGGER ELECTRICAL SMOKE WARNING - DISREGARD	
BOTH ENGINES PARAMETERS	CAREFULLY MONITOR
■ If any anomaly occurs such as :	
<ul style="list-style-type: none"> - amber engine warning illumination associated to local ITT alert - total loss of NL indication - engine abnormality clearly identified (NH, NL, ITT indications, noise, surge...) 	
ASSOCIATED PL	FI
ASSOCIATED CL	FEATHER THEN FUEL SO
SINGLE ENG OPERATION PROCEDURE	APPLY
WARNING : Confirm which engine is showing signs of abnormal operation in order to avoid shutting down the safe engine.	

R

R

COMMENTS

- Ensure crew communication is established. Avoid the use of interphone position to minimize interference from oxygen mask breathing noise. Check oxygen mask at 100 %.
- Recirculation fans are switched off to limit cabin contamination.

	EMERGENCY PROCEDURES SMOKE	2.04.03		
		P 4	050	
				JUL 98

AA

FWD SMOKE

ALERT

CONDITION	VISUAL	AURAL
Smoke detected in the forward cargo compartment	- MW light flashing red - FWD SMK red light on cap	CRC

PROCEDURE

FWD SMOKE	
CREW OXY MASKS	ON 100%
CREW COMMUNICATIONS	ESTABLISH
GOGGLES	ON
CABIN CREW	ADVISE
AVIONICS VENT EXHAUST MODE	OVBD
AIR FLOW	HIGH
RECIRC FANS (both)	OFF
EXTRACT AIR FLOW LEVER	CLOSED
(RH MAINT PANEL)	
CABIN CREW WITH PORTABLE EXTINGUISHER LOCATE AND KILL SOURCE OF SMOKE	
● When $\Delta P < 1$ PSI	
OVBD VALVE	FULL OPEN
AVIONICS VENT EXHAUST MODE	NORM

R
R
R
R
R
R
R
R
R
R

	EMERGENCY PROCEDURES SMOKE	2.04.03		
		P 5	050	
				JUL 98

AA

COMMENTS

- Ensure crew communication is established. Avoid the use of interphone position to minimize interference from oxygen mask breathing noise. Check oxygen mask at 100%.
- Cargo ventilation without cabin or cockpit contamination is ensured by:
 - selecting AVIONICS VENT EXHAUST mode OVBD
 - shutting off the recirculation fans
 - selecting HIGH the PACKS AIR FLOW
 - isolating the cockpit panels ventilation by selecting EXTRACT AIR FLOW to CLOSED.
- Cabin crew is in charge to locate and kill source of smoke with the extinguisher.
- Cabin crew uses the portable oxygen bottle with the full face mask on 100 % position with full pressure. A fire extinguisher (3 kg - 7 Lbs) is available at the left front Locker).
- When $\Delta P < 1$ PSI, OVBD VALVE is selected full open and avionics VENT NORM in order to recover air evacuation capability through the extract fan without any pressurization problem.

	EMERGENCY PROCEDURES SMOKE	2.04.03		
		P 6	001	
				JUL 98

AA

R **AFT SMOKE**

R **ALERT**

CONDITION	VISUAL	AURAL
Smoke detected in the aft cargo compartment or in the lavatory	<ul style="list-style-type: none"> - MW light flashing red - AFT SMK red light on CAP 	CRC

R **PROCEDURE**

AFT SMOKE	
CABIN CREW	ADVISE FOR ACTION
RECIRC FANS both	OFF
AIR FLOW	HIGH

R **COMMENTS**

- R - The cabin crew is in charge to locate and kill the source of smoke, if possible, using the portable fire extinguisher located in the cabin. Before entering the aft cargo area, the cabin attendant must wear an oxygen mask. Leaving the aft cargo door open may induce some cabin contamination therefore it must be avoided.



AJR72
F.C.O.M.

EMERGENCY PROCEDURES

2.04.03

P 7

001

SMOKE

JUL 98

AA

LEFT INTENTIONALLY BLANK

	EMERGENCY PROCEDURES	2.04.04		
		P 1	250	
	ELECTRICAL SYSTEM			JUL 99

AA

DUAL DC GEN LOSS

PROCEDURE

DUAL DC GEN LOSS					
DC GEN 1 and 2	OFF then ON				
<input type="checkbox"/> If no generator recovered					
<table style="width: 100%; border-collapse: collapse;"> <tr> <td style="width: 80%;">HYD GREEN PUMP</td> <td style="text-align: right;">OFF</td> </tr> <tr> <td>TRU</td> <td style="text-align: right;">ON</td> </tr> </table>		HYD GREEN PUMP	OFF	TRU	ON
HYD GREEN PUMP	OFF				
TRU	ON				
<i>Make sure that TRU arrow illuminates, BAT arrows extinguish.</i>					
MAN RATE knob	9 o'clock				
CAB PRESS MODE SEL	MAN				
BAT SW	OVRD				
ATC (VHF 1 or HF or HF 2)	NOTIFY				
MIN CAB LT	OFF				
<i>Note :NAV lights switch set to ON position is necessary to provide IEP illumination.</i>					
STICK PUSHER/SHAKER	OFF				
STICK PUSHER/SHAKER FAULT PROCEDURE	APPLY				
SIDE WINDOW ANTI ICING	OFF				
AVIONICS VENT EXHAUST MODE	OVBD				
ADC SW	SET to ADC 1				
ATC SW	SET to ATC 1				
TLU	MAN MODE LO SPD				
BUS EQT LIST	CHECK				
<ul style="list-style-type: none"> ● Before descent 					
PAX INSTRUCTIONS	USE PA				
HYD X FEED	ON				
<i>Note : Selecting HYD X FEED to open position allows to recover green hydraulic circuit.</i>					
<ul style="list-style-type: none"> ● At touch down 					
IDLE GATE LEVER	PULL				

R

R

 NR72 F.C.O.M.	EMERGENCY PROCEDURES	2.04.04		
	ELECTRICAL SYSTEM	P 2	200	
				JUL 99

AA

COMMENTS

- Safety analysis leads us to consider the case when the DUAL DC GEN LOSS is due to :

- . Single engine operation,
- . DC GEN inoperative on the operating engine.

In such a case, HYD GREEN PUMP has to be set to OFF position in order not to overload the ACW GEN of the remaining engine.

- Selecting TRU ON allows to recover EMER, ESS and STBY (AC and DC) buses supply from ACW generators.
 - HYD X FEED is opened in order to pressurize the whole hydraulic system from blue pump.
 - Minimum cabin light must be switched OFF to limit the electrical load of the TRU.
 - As DC BUS 1 is lost, automatic pressurization is lost.
 - Both stick pusher and stick shaker are lost without FAULT alarm.
 - DC STBY BUS undervoltage may occur due to a failure of the STBY BUS system circuit. In this event, the OVRD function may be used to transfer the STBY BUS supply from the MAIN BAT BUS to the EMER BAT BUS.
- R - TLU AUTO mode is lost and MAN MODE must be used.
R MAN MODE acts on TLU standby actuator which remains powered even if TLU is in LO
R SPD established position.
R When TLU SW is set to AUTO position, TLU standby actuator electrical power is off.
- R - PA must be used for pax instructions because cabin signs are not supplied in
R emergency.

	EMERGENCY PROCEDURES	2.04.05		
	MISCELLANEOUS	P 1	150	
				JUL 01

EMERGENCY DESCENT

PROCEDURE

EMERGENCY DESCENT

R	PLs	FI
	OXY MASKS/CREW COMMUNICATIONS	AS RQD
	OXY PAX SUPPLY	AS RQD
	OXY PRESSURE	CHECK
	CLs	100 OVRD
	SPEED	MMO/VMO
		(or less if structural damage is suspected)
	SIGNS	ON
	ATC	NOTIFY
	MEA	CHECK

COMMENTS

- Oxygen may be used with N/100 % rocker in N position if air in the cabin is not contaminated.
- Maximum airspeed is MMO/VMO. But if structural damage is suspected, use the flight controls with care and reduce speed as appropriate. Landing gear may be extended in order to increase rate of descent.
- Notify ATC of the nature of the emergency encountered and state intentions. In the event ATC cannot be contacted, select code A77 or transmit the distress message on one of the following frequencies (VHF) 121,5 MHz or (HF) 8364 KHz. Only VHF 1 is available on battery.
- CL are selected 100 OVRD to increase drag and consequently to increase the rate of descent.

	EMERGENCY PROCEDURES	2.04.05		
		P 2	001	
	MISCELLANEOUS			JUN 94

**DITCHING
PROCEDURE**

DITCHING	
	<ul style="list-style-type: none"> ● Preparation (time permitting)
	ATC (VHF1) NOTIFY CABIN CREW NOTIFY SIGNS ON GPWS OFF CABIN and COCKPIT PREPARE . Loose equipment secured . Survival equipment prepared . Belts and shoulder harness locked.
R	AUTO PRESS-LANDING ELEVATION SET
	<ul style="list-style-type: none"> ● Approach
R	AUTO PRESS (IF $\Delta P \neq 0$) DUMP PACKS both OFF OVBD VALVE FULL CLOSE FLAPS (IF AVAILABLE) 30 <i>Note: If power supply still available is provided by batteries only, flaps' extension is impossible.</i>
	L/G LEVER UP DITCH pb (30 sec before the impact or 1250 ft above sea level) . . . ON ENG START rotary selector OFF/START ABORT CABIN REPORT OBTAINED
	<ul style="list-style-type: none"> ● Before ditching (200 ft)
	OPTIMUM PITCH ATTITUDE 9° MINIMIZE IMPACT SLOPE BRACE FOR IMPACT ORDER
R	CL both FTR then FUEL SO FIRE HANDLES PULL FUEL PUMPS OFF <i>Note: in case of night ditching, shutting down both engines may be performed, at captain discretion, immediately after the impact (to avoid loss of landing lights during flare out).</i>
	<ul style="list-style-type: none"> ● After ditching
	CABIN CREW (PA) NOTIFY EVACUATION INITIATE BAT (before leaving A/C) OFF
	<i>Note: After ditching, one aft door will be under the water line.</i>

 ATR 72 F.C.O.M.	EMERGENCY PROCEDURES MISCELLANEOUS	2.04.05		
		P 3	001	
				DEC 96

AA

COMMENTS

- Notify ATC of the nature of the emergency encountered and state intentions. In the event of no ATC contact select ATC code A77 or transmit the distress message on one of the following frequencies (VHF) 121,5 MHz or (HF) 8364 KHz. Only VHF 1 is available on battery.
- Notify the cabin crew of the nature of emergency encountered and intentions. Specify the available time.
- Note : The direction of ditching is mainly dependent on wind and state of the sea and these factors may be assessed as follows :
 - 1) Wind direction :
 - This may be assessed by observing the waves which move and break down wind, spray from wave tops is also a reliable indication.
 - 2) Wind speed
 - The following conditions can be used as a guide to wind speed
 - R A few white crests 8-17 kt
 - R Many white crests 17-26 kt
 - R Streaks of foam along water 23-35 kt
 - Spray from waves 35-43 kt
 - 3) State of sea
 - This is better assessed from a height of 500 to 1000 ft particularly the direction of the swell which may not be obvious when seen from a lower altitude.
- When there is no swell, align into the wind. In the presence of a swell and provided that drift does not exceed 10 degrees, land parallel to the swell and as nearly into the wind as possible. If drift exceeds 10 degrees, land into wind. The presence of drift on landing is not dangerous but every effort should be made to minimize roll.
- For evacuation, open only the doors which are not under the water line.
- R - After using the DUMP function, the two pack valves are selected OFF to :
 - R * limit Δp .
 - R * prevent a untimely cabin inflation
 - R If the bleed valves are selected OFF, (also it induces the Pack valves shutting off), the venturi which creates the vacuum to the Dump function is no more supplied.
 - R
- R - Ditch pb must be activated at least 30 seconds before impact.



AZR 72
F.C.O.M.

EMERGENCY PROCEDURES

MISCELLANEOUS

2.04.05

P 4

001

JUL 99

AA

R AIRCRAFT ATTITUDE IN CASE OF DITCHING

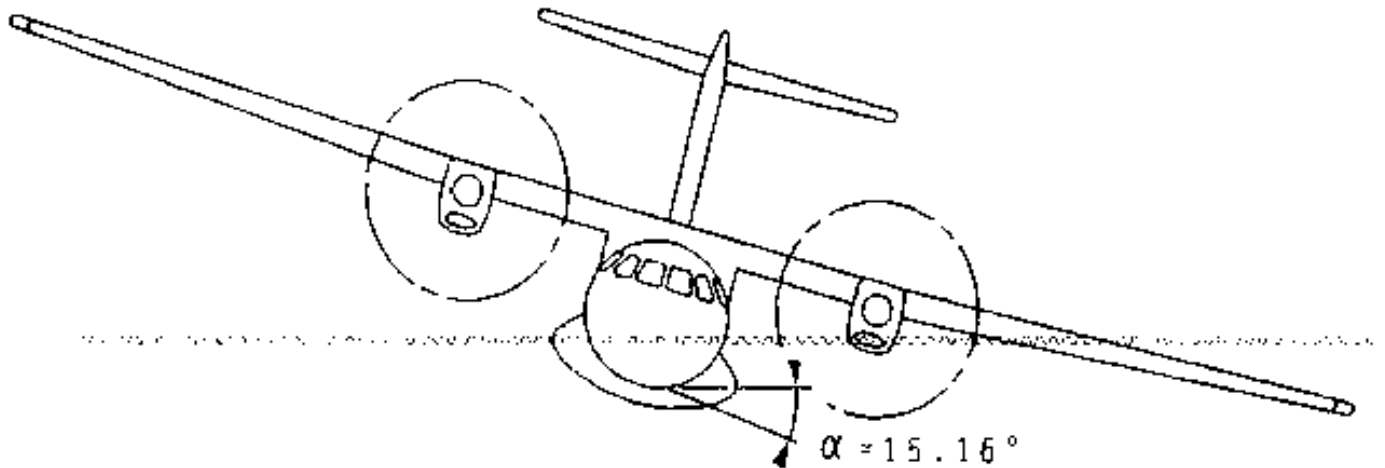

Note : This illustration is given as an example. It is not necessary the LH wing which is down.

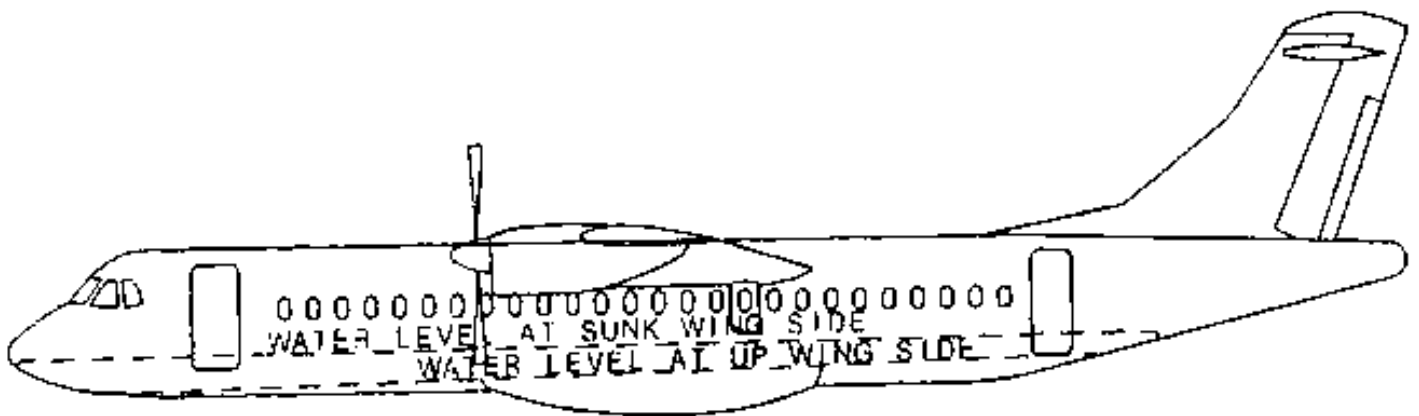

400105 400104 400105

	EMERGENCY PROCEDURES	2.04.05	
		P 5	001
	MISCELLANEOUS		JUN 94

FORCED LANDING

PROCEDURE

FORCED LANDING

● **Preparation (time permitting)**

- ATC (VHF1) NOTIFY
- CABIN CREW NOTIFY
- SIGNS ON
- GPWS OFF
- CABIN and COCKPIT PREPARE
 - Loose equipment secured
 - Survival equipment prepared
 - Belts and shoulder harness locked
- AUTO PRESS-LANDING ELEVATION SET

● **Approach**

- BLEEDS both OFF
- FLAPS (IF AVAILABLE) 30
- Note: If power supply still available is provided by batteries only, flaps' extension is impossible.*
- L/G LEVER AS RQD
- AUTO PRESS DUMP
- ENG START rotary selector OFF/START ABORT
- CABIN REPORT OBTAINED

● **Before impact (200 ft)**

- BRACE FOR IMPACT ORDER
- CL both FTR then FUEL SO
- FIRE HANDLES PULL
- FUEL PUMPS OFF

Note: In case of night forced landing, shutting down both engines may be performed, at captain discretion, immediately after impact (to avoid loss of landing lights during flare out).

● **After impact, when A/C stopped**

- CABIN CREW (PA) NOTIFY
- AGENTS DISCH
- EVACUATION INITIATE
- BAT (before leaving A/C) OFF

	EMERGENCY PROCEDURES	2.04.05		
	MISCELLANEOUS	P 6	001	
				SEP 89

COMMENTS

- Notify ATC of the nature of emergency encountered and state intentions. In the event of no ATC contact, select ATC code A77 or transmit the distress message on one of the following frequencies (VHF) 121,5 MHz or (HF) 8364 KHz. Only VHF 1 is available on battery.
- Notify the cabin crew of the nature of emergency encountered and the intentions. Specify the available time. If the nature of the emergency permits, allow cabin crew to make PA announcements that will minimize apprehension.
- On battery, only PA is available to communicate with cabin crew.

	EMERGENCY PROCEDURES	2.04.05		
		P 7	001	
	MISCELLANEOUS			JUN 94

AA

ON GND EMER EVAC

PROCEDURE

ON GND EMER EVAC	
AIRCRAFT/PARKING	STOP/SET
ATC	NOTIFY
CL both	FTR then FUEL SO
MIN CAB LT	ON
CABIN CREW (PA)	NOTIFY
FIRE HANDLES	PULL
AGENTS	AS REQ
ENG START rotary selector	OFF/START ABORT
FUEL PUMPS	OFF
EVACUATION	INITIATE
BAT (before leaving A/C)	OFF

R
R

COMMENTS

- Careful analysis is required to decide on passenger evacuation, however useful time should not be wasted.
- Notify ATC of the nature of the emergency and state intentions. Only VHF 1 is available on battery.
- On battery, only PA is available to communicate with cabin crew.

	EMERGENCY PROCEDURES	2.04.05		
		P 8	001	
	MISCELLANEOUS			JUN 94

BOMB ON BOARD

PROCEDURE

BOMB ON BOARD	
LANDING ELEVATION	CABIN ALTITUDE
FL	DESCEND TO CABIN ALTITUDE
AVOID LOAD FACTORS	
HANDLE BOMB CAREFULLY AVOID SHOCKS	
● When Z aircraft = Z cabin	
APPROACH CONFIG (F 15 GEAR DOWN)	SELECTED
AUTO PRESS	DUMP
SERVICE DOOR	UNLOCK
PLACE BOMB NEAR SERVICE DOOR PREFERABLY IN A BAG ATTACHED TO THE DOOR HANDLE.	
SURROUND IT WITH DAMPING MATERIAL	
CAB ATTN OXYGEN AND FIRE EXT	MOVE FORWARD
PAX	MOVE FORWARD/CRASH POSITION
LAND ASAP	

	EMERGENCY PROCEDURES		2.04.05	
	MISCELLANEOUS		P 9	050
				JUL 00

AA

SEVERE ICING

This procedure is applicable to all flight phases from initial climb to landing.

Monitor the ambient air temperature (SAT).

While severe icing may form at temperatures as cold as - 18°C, increased vigilance is warranted at temperatures around freezing with visible moisture present.

DETECTION

Visual cue identified with severe icing is characterized by ice covering all or a substantial part of the unheated portion of either forward side window, possibly associated with water splashing and streaming on the windshield.

and / or

Unexpected decrease in speed or rate of climb

and / or

The following secondary indications :

- . Unusually extensive ice accreted on the airframe in areas not normally observed to collect ice.
- . Accumulation of ice on the lower surface of the wing aft of the protected areas.
- . Accumulation of ice on the propeller spinner farther aft than normally observed.
- The following weather conditions may be conducive to severe in-flight icing :
 - . Visible rain at temperatures close to 0°C ambient air temperature (SAT).
 - . Droplets that splash or splatter on impact at temperature close to 0°C ambient air temperature (SAT).

PROCEDURE

SEVERE ICING

- **If severe icing as determined above is encountered accomplish the following :**
 - Immediately increase and bug the minimum maneuver/operating icing speeds by 10 kt. Increase power, up to MAX CONT if needed
 - Request priority handling from Air Traffic Control to facilitate a route or an altitude change to exit the severe icing conditions.
 - Avoid abrupt and excessive maneuvering that may exacerbate control difficulties.
 - Do not engage the autopilot.
- **If the autopilot is engaged,** hold the control wheel firmly and disengage the autopilot.
- **If the flaps are extended,** do not retract them until the airframe is clear of ice.
- **If an unusual roll response or uncommanded roll control movement is observed,** maintain the roll controls at the desired position and reduce the angle of attack by :
 - Pushing on the wheel as needed,
 - Extending flaps to 15,
 - Increasing power, up to MAX CONT if needed.
- **If the aircraft is not clear of ice :**
 - Maintain flaps 15, for approach and landing, with "reduced flaps APP/LDG icing speed" + 5 kt.
 - Multiply landing distance flaps 30 by 2.12
- Report these weather conditions to Air Traffic Control.

	EMERGENCY PROCEDURES MISCELLANEOUS	2.04.05		
		P 10	001	
				JUL 99

AA

COMMENTS

- R
- Since the autopilot may mask tactile cues that indicate adverse changes in handling characteristics, use of the autopilot is prohibited when the severe icing defined above exists, or when unusual lateral trim requirements or autopilot trim warnings are encountered while the airplane is in icing conditions.
 - Due to the limited volume of atmosphere where icing conditions usually exists, it is possible to exit those conditions either :
 - . by climbing 2000 or 3000 ft, or
 - . if terrain clearance allows, by descending into a layer of air temperature above freezing, or
 - . by changing course based on information provided by ATC.

	PROCEDURES FOLLOWING FAILURE CONTENTS	2.05.00		
		P 1	001	
				JUL 01

2.05.00 CONTENTS

2.05.01 INTRODUCTION

2.05.02 POWER PLANT

- SINGLE ENG OPERATION
- START FAULT
- NO NH DURING ENG START
- NO NL DURING ENG START
- NO ITT IND DURING ENG START
- NAC OVHT
- X START FAIL
- EXCESSIVE ITT DURING ENG START
- EXCESSIVE ITT
- ENG RESTART IN FLT
- ENG STALL
- ENGINE FLAME OUT
- ONE EEC FAULT
- BOTH EEC FAULT
- EEC SELECT IN FLT
- SYNPHR FAIL (If applicable)
- ATPCS FAIL
- IDLE GATE FAIL
- LOW PITCH IN FLT
- ENG OVER LIMIT
- PROP OVER LIMIT
- ENG OIL LO PR
- ENG OIL TEMP HI
- ENG OIL TEMP LO
- FUEL ABNORM TEMP
- FUEL CLOG
- PROP BRK UNLK (If applicable)
- PROP BRK UNLOCKING (ENG 2 stopped) (If applicable)
- PROP BRK (CAP alert) (If applicable)
- INCORRECT TQ INDICATION
- PEC 1 (2) SGL CH (If applicable)
- PEC 1 (2) FAULT (If applicable)
- R ONE PROPELLER REMAINING AT 100 % NP AFTER CLB PWR SELECTION (if applicable)

2.05.03 FUEL

- FEED LO PR
- FUEL LO LVL

	PROCEDURES FOLLOWING FAILURE CONTENTS	2.05.00		
		P 2	001	
				JUL 00

2.05.04	ELECTRICAL SYSTEM
	DC GEN FAULT
	DC BUS 1 OFF
	DC BUS 2 OFF
	DC EMER BUS OFF
	CHG FAULT
R	BATTERY(IES) DISCHARGE IN FLIGHT (if applicable)
	DUAL CHG LOSS
	DC SVCE and UTLY BUS SHED
	INV FAULT
	AC BUS 1 OFF
	AC BUS 2 OFF
	ACW GEN FAULT
	ACW BUS 1 OFF
	ACW BUS 2 OFF
	ACW TOTAL LOSS
	BUS EQPT LIST
2.05.05	HYDRAULIC
	HYD TK COMPT LO LEVEL
	HYD LO PR/HYD OVHT
	BOTH MAIN HYD PUMPS LOSS
	BOTH HYD SYS LOSS
2.05.06	FLIGHT CONTROLS
	REDUCED FLAPS LDG
	FLAPS UNLK
	FLAPS JAM/FLAPS UNCPL
	FLAP ASYM
	ELEV JAM
	PITCH DISCONNECT
	PITCH TRIM INOPERATIVE
	PITCH TRIM ASYM
R	STICK PUSHER / SHAKER FAULT or STICK PUSHER FAULT
	AILERON JAM
	SPOILER JAM
	RUDDER JAM
	RUD RELEASABLE CENT UNIT FAIL
	TLU FAULT
R	AIL LOCK LIT (if applicable)
2.05.07	LANDING GEAR
	L/G UNSAFE INDICATION
	L/G GRAVITY EXTENSION
	LDG WITH ABNORM L/G
	L/G RETRACTION IMPOSSIBLE
	ANTI SKID FAULT
	BRK TEMP HOT

	PROCEDURES FOLLOWING FAILURE CONTENTS	2.05.00		
		P 3	001	
				JUL 99

2.05.08 AIR

BLEED VALVE FAULT
 BLEED OVHT
 BLEED LEAK
 X VALVE OPEN
 BLEED NOT ON AFTER T/O
 PACK VALVE FAULT
 BOTH PACKS INOP
 DUCT OVHT
 RECIRC FAN FAULT
 EXCESS CAB ALT
 AUTO PRESS FAULT
 AVIONICS VENT EXHAUST MODE FAULT
 OVBD VALVE FAULT
 EXCESS CAB ΔP

2.05.09 ANTI ICE

R

AIRFRAME AIR BLEED FAULT
 AIRFRAME DE ICING FAULT
 ENG DE or ANTI ICING FAULT
 PROP ANTI ICING FAULT
 HORNS ANTI ICING FAULT
 WINDOW HTG FAULT
 PROBE HTG FAULT
 DE ICING MODE SEL FAULT
 ICE DETECTOR FAULT

2.05.10 MFC

MFC MODULE FAULT
 MODULE EQPT LIST

2.05.11 AUTOPILOT

AILERON MISTRIM MESSAGE, or EXCESSIVE LATERAL TRIM
 REQUIRED or ABNORMAL FLIGHT CHARACTERISTICS OF THE
 AIRPLANE
 PITCH MISTRIM (MESSAGE)
 PITCH TRIM FAIL (MESSAGE) (If installed)

	PROCEDURES FOLLOWING FAILURE CONTENTS	2.05.00		
		P 4	001	
				JUL 99

2.05.12 MISCELLANEOUS

- DOORS UNLK IN FLT
- COCKPIT WINDOW CRACKED
- AUDIO SEL FAULT
- AHRS A/ERECT FAIL
- EFIS COMP
- AHRS FAIL
- SGU FAIL
- CRT FAIL
- LOSS OF RADIO ALTIMETER INFORMATION
- ADU FAILURE
- ADC FAULT
- ADC DISAGREEMENT
- ADC SW FAULT
- FIRE LOOP FAULT
- OXYGEN LO PR
- CL PNEUMATIC ACTUATOR BLOCKADE (If applicable)

R

	PROCEDURES FOLLOWING FAILURE INTRODUCTION	2.05.01		
		P 1	001	
				JUN 94

AA

GENERAL

R The procedures following failure represent the actions applicable after a failure to ensure
 R adequate safety and to ease the further conduct of the flight. They are applied according
 R to the "Read and Do" principle except for memory items.

PRESENTATION

The procedures are presented in the basic check list format with an adjacent expanded section which provides :

- indication of the particular failure (alert condition)
- explanation for actions where the reason is not self evident
- additional background information.

The abbreviations used are identical with the nomenclature on the cockpit panels.
 All actions are printed in capital letters.

If actions depend on a precondition, a preceding black square ■ is used to identify the precondition.

A preceding black dot ● is used to indicate the moment when actions have to be applied.

TASK SHARING

For all procedures, the general task sharing stated below is applicable.
 The pilot flying remains pilot flying throughout the procedure.

PF Pilot flying responsible for :

- PL
- Flight path and airspeed control
- Aircraft configuration
- Navigation

PNF Pilot non flying responsible for :

- check list reading
- execution of required actions
- actions on overhead panel
- CL
- communications

The AFCS is always coupled to the PF side (CPL selection).

	PROCEDURES FOLLOWING FAILURE INTRODUCTION	2.05.01		
		P 2	001	
				JUN 97

AA

PROCEDURE INITIATION

- No action will be taken (apart from depressing MC/MW pb):
 - . Until flight path is stabilized.
- R . Under 400 ft above runway (except propeller feathering after engine failure during approach at reduced power if go around is considered).
- At flight crew discretion, one reset of a system failure associated to an amber caution may be performed by selecting OFF then ON related pushbutton. If the failure alert disappears, continue normal operation and record the event in the maintenance log. If not, apply the associated failure procedure.
- R - Before performing a procedure, the crew must assess the situation as a whole, taking into consideration the failures, when fully identified, and the constraints imposed.

ANALYSIS OF CONSEQUENCES OF A FAILURE ON THE FLIGHT

Basic airmanship calls for a management review of the remaining aircraft capabilities under the responsibility of CM1.

CCAS

When TO INH has been selected, until the first leg of landing gear unlocks, all alerts are inhibited except:

- ENG 1 FIRE
- ENG 2 FIRE
- CONFIG
- FLAPS UNLK
- LDG GEAR NOT DN
- EXCESS ALT
- PITCH DISCONNECT
- PROP BRK

	PROCEDURES FOLLOWING FAILURE POWER PLANT	2.05.02		
		P 1	070	
				JUN 97

SINGLE ENG OPERATION

PROCEDURE

SINGLE ENG OPERATION	
LAND ASAP	
PWR MGT (both)	TO if necessary then MCT
FUEL PUMP AFFECTED	OFF
DC GEN affected	OFF
ACW GEN affected	OFF
PACK affected	OFF
BLEED affected	OFF
OIL PRESSURE ON FAILED ENGINE	MONITOR
■ If fuel cross feed is require	
FUEL PUMP affected	ON
FUEL X FEED	ON
FUEL PUMP on operating ENG	OFF
<i>Note : In icing condition, flaps 15 will be selected to improve drift down performances and single engine ceiling.</i>	
● For approach	
BLEED not affected	OFF
SINGLE ENGINE APPROACH SPEED FLAPS 30 IS EQUAL TO $V_{mHB30} + \text{WIND EFFECT OR } 1.1V_{MCA}$ WHICHEVER IS HIGHER UNTIL COMMITTED TO LAND.	
<i>Note : - At touch down, do not reduce below Fl before nose wheel is on the ground.</i>	
<i>- If during the flight, a positive oil pressure has been noted on the failed engine for a noticeable period of time, maintenance must be informed.</i>	

COMMENTS

- Refer to section Procedures and Techniques for fuel unbalance.
- For approach and landing, comply with Procedure and Techniques, Flight Patterns subsection.

	PROCEDURES FOLLOWING FAILURE POWER PLANT	2.05.02		
		P 2	001	
				JUN 97

AA

START FAULT

R ALERT

CONDITION	VISUAL	AURAL
Start sequence incident	<ul style="list-style-type: none"> - MC light flashing amber - ENG amber light on CAP - associated START FAULT amber light on overhead panel. 	SC

START FAULT	
ENG START Rotary selector	OFF / START ABORT
<ul style="list-style-type: none"> ■ If above 45 % NH 	
START ON light	CHECK EXTINGUISHED
START	TO BE CONTINUED

	PROCEDURES FOLLOWING FAILURE POWER PLANT	2.05.02		
		P 3	001	
				JUN 97

AA

NO NH DURING ENG START

PROCEDURE

Wait for 10 s with the START pb selected ON.

- **If OIL PRESS increases**
 CL FTR
 Continue START procedure, being informed NH ind. is inoperative.
- **If OIL PRESS does not increase**
 ENG START rotary selector OFF/START ABORT
 Suspect starter motor failure. Maintenance action is due.

NO NL DURING ENG START

PROCEDURE

Continue start procedure being informed that NL ind. is inoperative.

NO ITT IND DURING ENG START

ALERT

ITT indication does not rise 10 seconds after CL is set in FTR position.

PROCEDURE

NO ITT IND DURING ENG START	
CL	FUEL SO
ENG START rotary selector	OFF/START ABORT
wait 30 seconds to allow fuel draining, then	
ENG START rotary selector	CRANK
START Pb	ON
when 15 seconds has elapsed	
ENG START rotary selector	OFF/START ABORT

	PROCEDURES FOLLOWING FAILURE	2.05.02		
		P 4	001	
	POWER PLANT			JUN 97

AA

NAC OVHT

ALERT

CONDITION	VISUAL	AURAL
Nacelle temperature exceeds 170° C (338° F) when aircraft is on ground	- MW flashing red - NAC OVHT red light on CAP	CRC

PROCEDURE

NAC OVHT	
● During hotel mode operation	
PL	GI
CL	FTR THEN FUEL SO
● During taxi	
AIRCRAFT	STOP
INCREASE SLIGHTLY POWER	
■ If unsuccessful within 30 sec	
PL	GI
CL	FTR THEN FUEL SO

COMMENTS

- In case of tailwind component greater than 10 kt and just after engine start, propeller must be unfeathered rapidly to take advantage of the wind created by propeller rotation and consequently to avoid exhaust gas return flow in the nacelle.
- When taxiing with tail wind component, use of reverse requires special care as air flow created by propeller reversing combined with tail wind will induce an exhaust gas return flow which may damage the nacelle. It is consequently recommended not leave PL in reverse position for any period of time exceeding 10 seconds.
- NAC OVHT alert is inhibited when both wow systems detect aircraft airborne.

	PROCEDURES FOLLOWING FAILURE POWER PLANT	2.05.02		
		P 5	001	
				JUN 97

AA

X START FAIL

ALERT

CONDITION	VISUAL	AURAL
On ground, during second engine start, operative DC GEN does not come on line to supply the START BUS between 10 % and 45 % NH	<ul style="list-style-type: none"> - MC light flashing amber - ELEC amber light on CAP - X START FAIL amber light on overhead panel. 	SC

PROCEDURE

X START FAIL
CONTINUE NORMAL ENGINE START INFORM MAINTENANCE

	PROCEDURES FOLLOWING FAILURE POWER PLANT	2.05.02		
		P 6	001	
				DEC 96

AA

R EXCESSIVE ITT DURING ENGINE START

ALERT

A hot start may be recognized by :

- Rapid ITT increase,
- NH slow increase,
- Exhaust flames may be reported by ground crew.

The maximum authorized temperature during engine start is 950 °C (refer to 2.01.04 page 2 for detailed limitation).

PROCEDURE

EXCESSIVE ITT DURING ENGINE START	
R	<p>■ If ITT tends to exceed 900°C</p> <p>CL FUEL SO</p> <p>ENG START rotary selector OFF/START ABORT</p> <p>● When NH below 30 %</p> <p>ENG START rotary selector CRANK</p> <p>START Pb ON</p> <p>● After 30 s</p> <p>ENG START rotary selector OFF START ABORT</p> <p>CAUTION : If ITT exceeded 950°C, maintenance action is due.</p>

	PROCEDURES FOLLOWING FAILURE POWER PLANT	2.05.02		
		P 7	001	
				DEC 96

AA

R **EXCESSIVE ITT** (In flight and during Hotel mode)

ALERT

CONDITION	VISUAL	AURAL
ITT ABOVE limit	<ul style="list-style-type: none"> - MC light flashing amber - ENG amber light on CAP - associated ITT ind. caution light on engine panel 	SC

PROCEDURE

EXCESSIVE ITT	
PL	Set for ITT below limit
<p>■ If ITT remains above limit</p>	
CL	FUEL SO
<p>● In flight :</p>	
SINGLE ENG OPERATION PROCEDURE	APPLY

COMMENTS

- The maximum authorized ITT in flight is 800°C. If ITT exceeds 800°C, engine shut down is required.
- The maximum authorized ITT in Hotel mode is 715°C.
- The excessive ITT alarm in Hotel mode is inhibited for 30 seconds after engine start. In that case, the alarm threshold remains at 950°C.



PROCEDURES FOLLOWING FAILURE

2.05.02

P 8

150

POWER PLANT

DEC 97

AA

ENG RESTART IN FLT

PROCEDURE

ENG RESTART IN FLT

FUEL SUPPLY CHECK
 CL FUEL SO
 PL FI
CAUTION : After ATPCS sequence PWR MGT rotary selector must be set to MCT position before engine restart in order to cancel propeller feathering.
 ENG START rotary selector START A & B
 EEC pb RESET if necessary or DESELECT if FAULT persists
 START pb ON
 At 10 % NH :
 CL FTR
 RELIGHT MONITOR
 CL AUTO
 PL ADJUST TO OTHER ENGINE
 ENG START rotary selector OFF/START ABORT
 SYSTEMS affected RESTORE

R

COMMENTS

- Engine relighting in flight is only guaranteed within the envelope and always necessitates starter assistance.

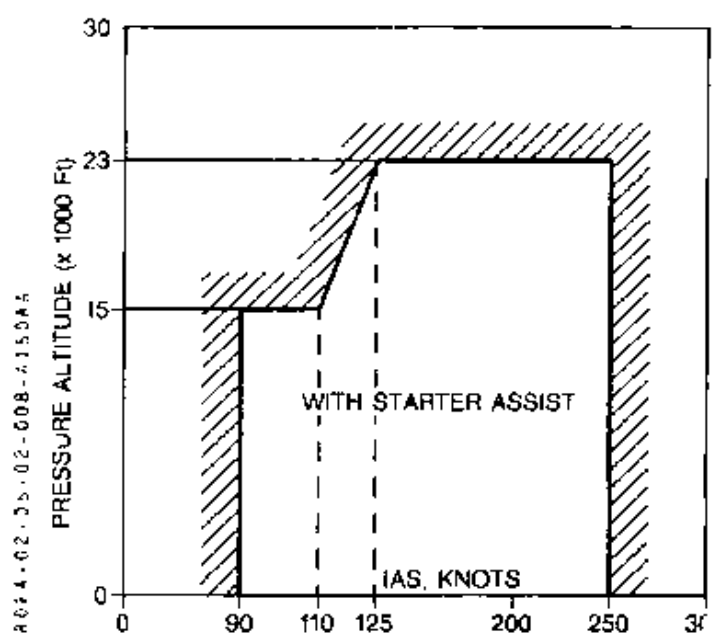

- The power may be restored immediately after relighting provided TOIL > 0 °C.
- Should the engine fail to light up within 10 s, select fuel to shut off, the ignition OFF and allow engine to be ventilated for 30 sec minimum prior to making another attempt.

	PROCEDURES FOLLOWING FAILURE POWER PLANT	2.05.02		
		P 9	050	
				DEC 96

AA

ENG STALL

ALERT

An engine stall may be recognized by :

- varying degrees of abnormal engine noise (rumbling bangs)
- fluctuating engine parameters
- abnormal PL response
- rapid ITT increase

PROCEDURE

ENG STALL	
PL	FI
ENG parameters	CHECK
■ Abnormal	
CL	FTR THEN FUEL SO
SINGLE ENG OPERATION PROCEDURE	APPLY
■ Normal	
ENG DE ICING	ON
PL	SLOWLY ADVANCE
■ If stall recurs	
Reduce thrust and operate below the stall threshold.	
■ If stall does not recur	
Continue engine operation.	

COMMENTS

- Engine icing may be a reason for engine stall. It is why engine de icing must be selected as soon as ice accretion develops.

	PROCEDURES FOLLOWING FAILURE POWER PLANT	2.05.02		
		P 10	050	
				DEC 96

ENGINE FLAME OUT

ALERT

An engine flame out may be recognized by :

- Sudden dissymmetry
- TQ decrease
- Rapid ITT decrease

PROCEDURE

ENGINE FLAME OUT	
PL	FI
<p>■ If NH drops below 30 % (no immediate relight)</p> <p>CL FTR THEN FUEL SO</p>	
<p>■ If damage suspected</p> <p>FIRE HANDLE PULL</p> <p>SINGLE ENG OPERATION PROCEDURE APPLY</p>	
<p>■ If no damages are suspected</p> <p>ENG RESTART IN FLT PROC APPLY</p>	
<p>■ If unsuccessful</p> <p>SINGLE ENG OPERATION PROCEDURE APPLY</p>	

COMMENTS

- Shut down the engine if no immediate relight.
- The causes of engine flame out can generally be divided into two categories :
 - External causes such as icing, very heavy turbulence, fuel mismanagement. These causes, which may affect both engines can generally be easily determined and an immediate relight can be attempted.
 - Internal causes which as engine stalls or failures usually affect a single engine and are not so easily determined. In these cases, the engine is shut down then the cause of the flame out investigated. If it cannot be positively determined what caused the flame out, the need for engine restart should be evaluated against the risk of further engine damage or fire that may result from a restart attempt.
- If damage is suspected, as precautionary measure, the FIRE handle is pulled.

	PROCEDURES FOLLOWING FAILURE	2.05.02		
		P 11	150	
	POWER PLANT			JUN 97

AA

ONE EEC FAULT

ALERT

CONDITION	VISUAL	AURAL
EEC failure	<ul style="list-style-type: none"> - MC light flashing amber - ENG amber light on CAP - associated EEC FAULT amber light on on central panel 	SC

PROCEDURE

ONE EEC FAULT	
ATPCS	OFF
<ul style="list-style-type: none"> ■ If affected PL is out of green sector DO NOT DESELECT AFFECTED EEC ● When adequate affected PL RETARD IN GREEN SECTOR ■ When affected PL is within green sector affected EEC RESET ■ If successful ATPCS ON ■ If unsuccessful EEC OFF ADVANCE affected PL to RESTORE POWER, HANDLING THROTTLE WITH CARE. ● In the following cases <ul style="list-style-type: none"> - Icing conditions, - Engine flame out, - EMER DESCENT, - Severe turbulence, - Heavy rain, MAN IGN ON ● In final approach CL 100 OVRD ● After landing SET affected ENGINE to GI and taxi using non affected engine. HANDLE THROTTLE WITH CARE. 	

	PROCEDURES FOLLOWING FAILURE POWER PLANT	2.05.02		
		P 12	500	
				JUN 97

COMMENTS

- Two cases must be considered :
 - ① High power (PL set forward of 52°)
When EEC fails, EEC FAULT light flashes, NH is automatically frozen to its prior value (FAIL FIX).
 - ② Low power (PL set aft of 52° in green sector)
When EEC fails, EEC FAULT comes ON steady and EEC is automatically deselected (Automatic reversion).
- Feathering the engine with the failed EEC for taxi and static operation will avoid prolonged time in NP restricted band (propeller limitation).
- With the EEC OFF, the automatic relight is not available on the affected engine.



ATR 72
E.C.O.M.

PROCEDURES FOLLOWING FAILURE

POWER PLANT

2.05.02

P 13

150

JUN 97

BOTH EEC FAULT
ALERT

CONDITION	VISUAL	AURAL
Both EEC failure	<ul style="list-style-type: none"> - MC light flashing amber ENG amber light on CAP - associated EEC FAULT amber light on central panel 	SC

PROCEDURE

BOTH EEC FAULT

ATPCS OFF
 PLs RETARD IN GREEN SECTOR
 EECs OFF THEN ON

■ **If unsuccessful**

EECs OFF
 PLs .. ADVANCE to PESTORE POWER, HANDLING THROTTLES WITH CARE.
 TQ indications (both) MONITOR
 LANDING DISTANCE MULTIPLY BY 1.5

● **In the following cases**

- Icing conditions,
- Engine(s) flame out,
- EMER DESCENT,
- Severe turbulence,
- Heavy rain,

MAN IGN ON

● **In final approach**

CLs 100 OVRD

● **After landing**

BRK handle EMER as required

CAUTION : Reverse power is reduced
 - Both main hyd pumps will be lost at low speed.

TAXI ON BOTH ENGINES, HANDLING THROTTLES WITH CARE.

 ATR 72 F.C.O.M.	PROCEDURES FOLLOWING FAILURE POWER PLANT	2.05.02		
		P 14	500	
				JUN 97

COMMENTS

- During reduction at touch down, both ACW GEN may be lost and therefore both main hyd pumps.
- Both digital torque indications are lost when TQ are below 20%.
- With the EECs OFF, the automatic relight is not available on both engines.

EEC SELECT IN FLT

PROCEDURE

EEC SELECT IN FLT	
On the side of the EEC to be selected :	
PL	RETARD IN GREEN SECTOR
EEC	ON
PL	ADJUST POWER (not to exceed the notch)
ATPCS	ON

 ATR 72 F.C.O.M.	PROCEDURES FOLLOWING FAILURE POWER PLANT	2.05.02		
		P 15	060	
				JUN 97

LEFT INTENTIONALLY BLANK

	PROCEDURES FOLLOWING FAILURE POWER PLANT	2.05.02		
		P 16	001	
				DEC 95

AA

ATPCS FAIL**ALERT**

- Uprtrim function is checked before each departure.
- Autofeather sequence is checked before each departure (ARM light extinguishes 2.15 seconds after the beginning of the test).
- Autofeathering function is checked daily (after the last flight of the day).

PROCEDURE

ATPCS FAIL	
<ul style="list-style-type: none"> ■ If UPTRIM only is failed MEL procedure (73 - Dispatch with uptrim inoperative) 	APPLY
<ul style="list-style-type: none"> ■ If AUTOFEATHER only is failed MEL procedure (61 - Dispatch with autofeather inoperative) 	APPLY
<ul style="list-style-type: none"> ■ If whole ATPCS system is failed (ARM light does not illuminate) ATPCS 	OFF
<ul style="list-style-type: none"> MEL procedure (61 - Dispatch with ATPCS OFF) 	APPLY

COMMENTS

- If automatic uptrim is failed
Uprtrim (RTO) is manually applied a priori.
- If autofeather is failed
A performance penalty is applied because in case of engine failure after V1, the pilot will not feather the affected propeller before 400 ft.
- If whole ATPCS system is failed
The ATPCS system will be switched OFF. RTO power will be applied and performance penalty will be taken into account.

	PROCEDURES FOLLOWING FAILURE POWER PLANT	2.05.02		
		P 17	001	
				DEC 95

IDLE GATE FAIL

ALERT

CONDITION	VISUAL	AURAL
Automatic idle gate system failure	<ul style="list-style-type: none"> - MC light flashing amber - IDLE GATE amber light on CAP - IDLE GATE FAIL amber light on pedestal 	SC

PROCEDURE

IDLE GATE FAIL	
<ul style="list-style-type: none"> ● In flight IDLE GATE LEVER PUSH ● At touch down IDLE GATE LEVER PULL 	

COMMENTS

- In flight, pushing idle gate lever sets the stop at FI.
 - On ground, pulling the lever removes the stop and allows reduction below FI (GI and reverse).
- One reason for idle gate fail alert may be a problem in the WOW (weight on wheel) system. Other systems may be affected. Report to maintenance.

 AJR72 F.C.O.M.	PROCEDURES FOLLOWING FAILURE POWER PLANT	2.05.02		
		P 18	070	
				JUN 97

LOW PITCH IN FLT

ALERT

CONDITION	VISUAL	AURAL
Low pitch detection in flight	<ul style="list-style-type: none"> - MC light flashing amber - ENG amber light on CAP - associated LO PITCH amber light on center panel 	SC

PROCEDURE

LOW PITCH IN FLT	
PL	FI
CL	FTR then FUEL SO
SINGLE ENG OPERATION PROCEDURE	APPLY



AR72
F.C.O.M.

PROCEDURES FOLLOWING FAILURE

2.05.02

P 19

001

POWER PLANT

DEC 95

R ENG OVER LIMIT

PROCEDURE

ENG OVER LIMIT

PL RETARDED TO RESTORE NORMAL VALUES

■ If TQ, NH, NL, still OVER RED MARK and if conditions permit

PL FI

CL FTR then FUEL SO

SINGLE ENG OPERATION PROCEDURE APPLY

COMMENTS

- Red limits must not be deliberately exceeded.
- Check pointer and counter to determine limit exceedance and proceed accordingly.
- Over limit conditions and primary engine parameters must be recorded for maintenance purposes.

If conditions do not permit engine shut down, land as soon as possible using the minimum power required to sustain safe flight.

	PROCEDURES FOLLOWING FAILURE POWER PLANT	2.05.02		
		P 20	500	
				DEC 97

AA

PROP OVER LIMIT

PROCEDURE

PROP OVER LIMIT	
PL	RETARD BELOW 75 %
PEC FAULT PROCEDURE	APPLY
■ If NP remains above 106 % <i>Note : 106 % allowed to complete a flight without overshooting 75% TQ.</i> If conditions permit	
PL	FI
CL	FTR then FUEL SO
SINGLE ENG OPERATION PROCEDURE	APPLY

COMMENTS

- Transients in amber sector are normal during engine accelerations.
- Red limits must not be deliberately exceeded.
- Check pointer and counter to determine limit exceedance and proceed accordingly.
- Over limit conditions and primary engine parameters must be recorded for maintenance purposes.
- If conditions do not permit engine shut down, land as soon as possible using the minimum power required to sustain safe flight. Nevertheless NP = 106% is allowed to complete a flight.

ENG OIL LO PR

R ALERT

CONDITION	VISUAL	AURAL
Oil pressure drops below 40 PSI	- MW light flashing red - associated ENG OIL red light on CAP and/or - associated OIL ind. warning light on engine panel	CRC

R
R
R
R
R
R

	PROCEDURES FOLLOWING FAILURE	2.05.02		
		P 21	500	
	POWER PLANT			JUL 98

AA

ENG OIL LO PR**PROCEDURE**

ENG OIL LO PR	
PL	FI
■ If both OIL LO PR alert on CAP and local alert are activated	
CL	FTR then FUEL SO
SINGLE ENG OPERATION PROCEDURE	APPLY
■ If local alert only is activated	
CL	FTR THEN FUEL SO
One engine is shut off	
CL	FTR
■ If CCAS is activated after 30 s (normal warning delay)	
CL	FUEL SO
ENG RESTART IN FLT PROCEDURE	APPLY
■ If not	
CL	FUEL SO
SINGLE ENG OPERATION PROCEDURE	APPLY
■ If OIL LO PR alert only on CAP is activated	
DISREGARD	
INFORM MAINTENANCE	
<i>Note : When single engine operation is required monitor the propeller speed of the feathered engine. If NP > 10% :</i>	
<i>- increase the approach speed by 10 knots.</i>	

R

COMMENTS :

- Engine oil low pressure is identified thanks to two low pressure detectors :
 - . the first one is connected to the CCAS (MW+CRC+ENG OIL red lt on CAP)
 - . the second one is connected to the local alert (analogic oil low pressure ind + associated red light).
- If CCAS only is activated, alert must be disregarded, oil press local alert indication must be constantly monitored during flight.
- If local alert only is activated and provided ENG OIL low pressure alert on CCAS is checked operative, twin engine operation should be resumed.

R

- NP > 10% after a shut off procedure may indicate an incomplete feathering. In this case approach speed is increased to compensate the extra drag of the incompletely feathered propeller.

	PROCEDURES FOLLOWING FAILURE POWER PLANT	2.05.02		
		P 22	500	
				JUN 97

ENG OIL TEMP HI

PROCEDURE

ENG OIL TEMP HI	
<p>■ OIL TEMP between 125 and 140° C</p> <p>OIL TEMP and PRESS MONITOR</p> <p><i>Notes : 1. If OIL TEMP rise follows PL reduction, advancing PL may reduce OIL TEMP.</i></p> <p><i>2. If OIL TEMP rise occurs in steady state conditions, a power reduction should permit a reduction in OIL TEMP.</i></p>	
<p>■ OIL TEMP between 125 to 140° C for more than 20 minutes</p> <p>PL reduced at minimum possible power.</p> <p>CAUTION : Flight plan must be rescheduled to minimize engine operating time in these abnormal conditions.</p>	
<p>■ OIL TEMP above 140° C</p> <p>PL FI</p> <p>CL FTR then FUEL SO</p> <p>SINGLE ENG OPERATION PROCEDURE APPLY</p>	

COMMENTS

- Normal steady oil temperature is in the range 71/99°C.
 - Increased power setting may reduce the OIL TEMP due to the increase of fuel flow across the fuel/oil heat exchanger.
- If an OIL TEMP rise occurs in steady state condition a failure of the oil cooler flap may be suspected, if no other engine malfunction is noted. In this case reducing power may limit temperature excursion.

ENG OIL TEMP LO

PROCEDURE

ENG OIL TEMP LO	
<p>■ OIL TEMP below 45° C</p> <p>Increase engine power if icing conditions are expected or present.</p>	



ATR 72
F.C.O.M.

PROCEDURES FOLLOWING FAILURE

2.05.02

P 23

001

POWER PLANT

NOV 93

FUEL ABNORM TEMP

PROCEDURE

FUEL ABNORM TEMP

■ TOO HIGH (> 50° C)

Avoid rapid throttle movement

Monitor oil temperature and other engine parameters

■ TOO LOW (< 0° C)

Use anti icing additive for next refueling if repair cannot be accomplished.

COMMENTS

Fuel is heated through a FUEL/OIL heat exchanger. Increasing fuel flow may reduce fuel temperature.

- Rapide throttle movement with high temperature fuel may cause surge or flame out.
- In case of too low temperature, anti icing additive is needed to prevent ice formation in the fuel supply system. Record it in the maintenance book.

	PROCEDURES FOLLOWING FAILURE POWER PLANT	2.05.02		
		P 24	001	
				NOV 93

FUEL CLOG

ALERT

CONDITION	VISUAL	AURAL
Clogging of the filter associated with HP pump	<ul style="list-style-type: none"> - MC light flashing amber - ENG amber light on CAP - associated FUEL CLOG amber light on main panel 	SC

PROCEDURE

FUEL CLOG		
<ul style="list-style-type: none"> ■ If only one light is illuminated 	Associated ENGINE PARAMETERS	MONITOR
<ul style="list-style-type: none"> ■ If both lights are illuminated 	ENGINES PARAMETERS	MONITOR
<ul style="list-style-type: none"> ● After next landing 	MAINTENANCE ACTION	REQUIRED

COMMENTS

- If only one light illuminates, the crew may continue the flight or series of flight monitoring associated engine parameters.
Maintenance will perform action on the filter at the maintenance base.
- If both lights are illuminated, the maintenance action has to be performed at the next stop.

 ATR 72 F.C.O.M.	PROCEDURES FOLLOWING FAILURE POWER PLANT	2.05.02		
		P 25	001	
				JUL 01

AA PROP BRK UNLK

ALERT

CONDITION	VISUAL	AURAL
Propoeller brake not locked in full locked or in full released position		
a) - without action on PROP BRAKE sw	- MW light flashing red - PROP BRK red light on CAP - UNLK red light on overhead panel	CRC
b) - after action on PROP BRAKE sw	- UNLK red light on overhead panel then after 30 s - MW + PROP BRK red light on CAP	CRC

PROCEDURE

PROP BRK UNLK	
<ul style="list-style-type: none"> On ground CL 2 FUEL SO PROP BRK UNLOCKING (Eng 2 stopped) PROCEDURE APPLY 	
<ul style="list-style-type: none"> In flight CONTINUE NORMAL OPERATION ENG 2 PARAMETERS MONITOR 	
<ul style="list-style-type: none"> After landing CL 2 FUEL SO MAINTENANCE ACTION REQUIRED 	

	PROCEDURES FOLLOWING FAILURE POWER PLANT	2.05.02		
		P 26	200	
				JUN 97

PROP BRAKE UNLOCKING (ENG 2 stopped)

PROCEDURE

PROP BRAKE UNLOCKING (ENG 2 stopped)	
■ If DC and AC GPU's are not available	
ENG 1	START
LH CL	AUTO
● When READY light illuminates on Prop brake control panel	
PROP BRK	OFF
UNLK LT	CHECKED EXTINGUISHED
PROP BRK PWR SPLY C/B	PULL

PROP BRK (CAP alert)

ALERT

CONDITION	VISUAL	AURAL
Propeller brake not locked in full locked or in full released position	(Refer to PROP BRK UNLK procedure)	CRC
or Propeller brake engaged and GUST LOCK released	- MW light flashing red - PROP BRK red light on CAP	CRC

PROP BRK (CAP alert)	
■ Associated with local UNLK alert	
PRO PBRK UNLK procedure	APPLY
■ On ground, without local UNLK alert	
■ If not associated with GUST LOCK release	
PROP BRK UNLK procedure	APPLY
■ If associated with GUST LOCK release	
According to operational situation	
- PROP BRAKE	OFF
All PROP BRAKE lights	check extinguished
or	
- GUST LOCK	ON

	PROCEDURES FOLLOWING FAILURE POWER PLANT	2.05.02		
		P 27	500	
				JUN 97

AA

INCORRECT TQ INDICATION

PROCEDURE

INCORRECT TQ INDICATION	
<ul style="list-style-type: none"> ■ Intermittent fluctuations or unrealistic steady indication 	
ATPCS	OFF
NH / NP on affected engine	ADJUST TO VALID ENG
<ul style="list-style-type: none"> ■ "---" indication on the digital counter 	
Avoid sudden PL movements	

COMMENTS

- AFU provides TQ indication to the cockpit instruments. (needle).
- Untimely TQ indication drop lasting more than 2.15 s will induce an ATPCS sequence if ATPCS was already armed.
- With engine at high power, a spurious ATPCS sequence would provoke an automatic feathering and a very significant overtorque deselecting ATPCS will avoid such a possibility.
- With no reliable TQ indication, engine power monitoring is assured on the affected engine through NH / NP indications.

	PROCEDURES FOLLOWING FAILURE POWER PLANT	2.05.02		
		P 28	070	
				JUN 97

PEC SGL

ALERT

CONDITION	VISUAL	AURAL
Anomaly detection on either PEC channel	- SGL amber light illuminated on central panel	- Nil -

PROCEDURE

PEC 1 (2) SGL CH

Do not reset PEC in flight.
No special crew action ; anticipate a PEC FAULT at landing.
Maintenance is required.

COMMENTS

- In case of PEC FAULT at landing :
 - . Do not set PLs below FI before nose wheel is on ground.
 - . Do not use reverse on affected engine.

	PROCEDURES FOLLOWING FAILURE POWER PLANT	2.05.02		
		P 29	070	
				JUL 00

AA

PEC 1 (2) FAULT**ALERT**

CONDITION	VISUAL	AURAL
Anomaly on both PEC channels	<ul style="list-style-type: none"> - MC light flashing amber - ENG amber light on CAP - Associated FAULT light on central panel 	SC

PROCEDURE

R

PEC 1 (2) FAULT	
<ul style="list-style-type: none"> ● Short final approach (below 400 ft RA) : 	
GO AROUND PROCEDURE APPLY	
<ul style="list-style-type: none"> ● Then, above 400 ft : 	
CL (affected)	100 OVRD
PEC (affected)	RESET
<ul style="list-style-type: none"> ■ If successful 	
CL (affected)	AUTO
<ul style="list-style-type: none"> ■ If unsuccessful 	
PEC (affected)	OFF
Avoid sudden PL movements	
Reverse is not available on affected engine - Taxi on both engines	
<ul style="list-style-type: none"> ● Other flight phases 	
CL (affected)	100 OVRD
PEC (affected)	RESET
<ul style="list-style-type: none"> ■ If successful 	
CL (affected)	AUTO
<ul style="list-style-type: none"> ■ If unsuccessful 	
PEC (affected)	OFF
Avoid sudden PL movements	
Reverse is not available on affected engine - Taxi on both engines	

COMMENTS

- Expect NP blocked at 102.5 % (overspeed stop)
- Do not set PLs below FI before nose wheel is on ground.
- Reverse is not available because the secondary low pitch stop retraction solenoid is disabled that forbids the blades to go below the low pitch protection.
- When the PEC is deenergized a NP cancel signal is sent to the EEC to cancel the EEC NP governing mode (that controls the NP speed at 850 rpm) on ground.
- ACW may be lost if NP drops below 65.5 % on the affected engine.
- CL is set to OVRD to minimize NP transient when PEC is switched OFF/RESET.

	PROCEDURES FOLLOWING FAILURE POWER PLANT	2.05.02		
		P 30	070	
				JUL 01

AA

ONE PROPELLER REMAINING AT NP 100 % AFTER CLB PWR SELECTION	
CL (BOTH)	100 OVRD
<ul style="list-style-type: none"> ■ If required, manually set CLB torque on affected engine. 	

	PROCEDURES FOLLOWING FAILURE FUEL	2.05.03		
		P 1	100	
				JUL 98

AA

FEED LO PR

ALERT

CONDITION	VISUAL	AURAL
Engine feed low pressure (below 300 mbar/4 PSI)	<ul style="list-style-type: none"> - MC light flashing amber - FUEL amber light on CAP - associated FEED LO PR amber light on overhead panel. 	SC

PROCEDURE

FEED LO PR	
PUMP associated	CONFIRM ON
ENGINE associated	Monitor for possible run down
■ If engine runs down or if fuel quantity decreases significantly.	
PL	FI
CL	FTR then FUEL SO
PUMP associated	OFF
FIRE HANDLE	PULL
SINGLE ENG OPERATION PROCEDURE	APPLY
CAUTION : Do not open X FEED valve	

R

COMMENTS

- The illumination of FEED LO PR light associated with PUMP RUN light identifies a LEAK in the fuel line which may lead to engine rundown.
- If engine runs down or if fuel quantity decreases significantly, affected line must be isolated by selecting the pump OFF and by closing the fuel shut-off valve.
- If PUMP RUN does not illuminate, pump system may be defective and a X FEED attempt may be performed in order to restore engine supply. Max fuel unbalance has to be considered.

R

	PROCEDURES FOLLOWING FAILURE FUEL	2.05.03		
		P 2	001	
				JUN 97

AA

FUEL LO LVL

ALERT

CONDITION	VISUAL	AURAL
Fuel tank low level (below 160 kg/352 lbs)	<ul style="list-style-type: none"> - MC light flashing amber - FUEL amber light on CAP - associated LO LVL amber light on FUEL QTY ind. 	SC

PROCEDURE

FUEL LO LVL
AVOID EXCESSIVE AIRCRAFT ATTITUDES

COMMENTS

- Excessive aircraft attitudes must be avoided to prevent pump unpriming.
- It is considered as basic airmanship to use X FEED as required when possible.

	PROCEDURES FOLLOWING FAILURE ELECTRICAL SYSTEM	2.05.04		
		P 1	001	
				JUN 96

DC GEN FAULT

ALERT

CONDITION	VISUAL	AURAL
One DC generation channel inoperative	<ul style="list-style-type: none"> - MC light flashing amber - ELEC amber light on CAP - associated DC GEN FAULT amber light on overhead panel 	SC

PROCEDURE

DC GEN FAULT	
DC GEN affected	OFF
■ If OAT exceeds ISA + 25	
MAX FL	200
TAXI ON BOTH ENGINES	

COMMENTS

- It is possible to try a reset by selecting the DC GEN ON again. If unsuccessful, leave DC GEN OFF.
- If OAT exceeds ISA + 25, the maximum allowed flight level is FL 200 due to ventilation problem of the remaining DC generator.

	PROCEDURES FOLLOWING FAILURE ELECTRICAL SYSTEM	2.05.04		
		P 2	001	
				DEC 94

AB

DC BUS 1 OFF

ALERT

CONDITION	VISUAL	AURAL
DC BUS 1 not supplied (short circuit protection)	<ul style="list-style-type: none"> - MC flashing amber - ELEC amber light on CAP - DC GEN 1 FAULT, associated DC BUS OFF, INV 1 FAULT, SVCE and UTLY BUS SHED amber light on overhead panel 	- SC -

PROCEDURE

DC BUS 1 OFF	
DC GEN 1	OFF
PF	CM 2
MAN RATE knob	9 o'clock
CAB PRESS MODE SEL	MAN
Affected equipment	OFF
BUS EQPT LIST	CHECK
<p>● At touch down</p>	
IDLE GATE LEVER	PULL

COMMENTS

- CM 1 completely loses his panel, except the EADI.
- DC SVCE and UTLY BUS pb may be maintained ON with SHED illuminated in order to keep DC UTLY BUS 2 on line.
- Stick pusher is lost.
- CAPT stick shaker channel is lost.

R

	PROCEDURES FOLLOWING FAILURE ELECTRICAL SYSTEM	2.05.04		
		P 3	050	
				JUN 95

DC BUS 2 OFF

ALERT

CONDITION	VISUAL	AURAL
R DC BUS 2 not supplied (short circuit protection)	- MC flashing amber - DC GEN 2 FAULT, associated DC BUS OFF, INV 2 FAULT, SVCE and UTLY BUS SHED amber light on overhead panel.	SC

PROCEDURE

DC BUS 2 OFF	
DC GEN 2	OFF
PF	CM 1
VHF 1	SELECT
Affected equipment	OFF
ADC sw	set to ADC 1
BUS EQPT LIST	CHECK
● Before descent PAX INSTRUCTIONS USE PA TAXI ON BOTH ENGINES	

	PROCEDURES FOLLOWING FAILURE ELECTRICAL SYSTEM	2.05.04		
		P 4	050	
				JUN 95

COMMENTS

- CM 1 is pilot flying due to complete loss of F/O panel.
- ATC communications must be performed with VHF 1 due to loss of VHF 2.
- DC SVCE and UTLY BUS pb may be maintained ON with SHED illuminated in order to keep DC UTLY BUS 1 and DC SVCE BUS on line.
- Before descent the cockpit crew must use public address to request « FASTEN SEAT BELTS » and « NO SMOKING » due to loss of sign indications.
- F/O Stick shaker channel is lost.

	PROCEDURES FOLLOWING FAILURE ELECTRICAL SYSTEM	2.05.04		
		P 5	001	
				JUN 97

AA

DC EMER BUS OFF
ALERT

CONDITION	VISUAL	AURAL
DC EMER BUS no longer supplied	<ul style="list-style-type: none"> - MC light flashing amber - CAP alerts - TQ indications loss - VHF1 loss - STBY horizon loss - ADC FAULT light loss 	SC

PROCEDURE

DC EMER BUS OFF	
LEAVE AND AVOID ICING CONDITIONS	
DESCEND TOWARD FL 100/MEA	
STBY PITCH TRIM	USED AS REQUIRED
ADC SW	Set to ADC2
HYD X FEED	ON
■ If ice accretion builds up on airframe	
DE ICING MODE SEL FAULT PROCEDURE	APPLY
PROPELLERS ANTI ICING FAULT PROCEDURE	APPLY
HORNS ANTI ICING FAULT PROCEDURE	APPLY
● Before landing	
N/W STEERING	OFF
ANTI SKID	OFF
ANTI SKID FAULT PROCEDURE	APPLY
● After landing	
DIFFERENTIAL BRAKING	USE

R

 A320 F.C.O.M.	PROCEDURES FOLLOWING FAILURE	2.05.04		
	ELECTRICAL SYSTEM	P 6	001	
				JUN 97

AA

COMMENTS

- ACW powered blue hydraulic pump is lost. HYD X FEED must be selected to open position to pressurize blue hydraulic circuit.

R

- TQ indications are lost : PLs must be set in the notch and engines monitoring must be performed with fuel flow indications.

- Normal pitch trim is lost use stand by pitch trim.

	PROCEDURES FOLLOWING FAILURE	2.05.04		
		P 7	200	
	ELECTRICAL SYSTEM			DEC 96

CHG FAULT

ALERT

CONDITION	VISUAL	AURAL
Incipient battery thermal runaway or charge contactor failure.	<ul style="list-style-type: none"> - MC light flashing amber - ELEC amber light on CAP - associated CHG FAULT amber light on overhead panel 	SC

PROCEDURE

CHG FAULT	
CHG associated	OFF

COMMENTS

- The associated battery is no longer charged.

BATTERY(IES) DISCHARGE IN FLIGHT

ALERT

CONDITION	VISUAL	AURAL
Battery(ies) discharge in flight (but DC main sources available)	<ul style="list-style-type: none"> - MC light flashing amber - ELEC amber light on CAP - Left and/or right arrow(s) amber light(s) on overhead panel 	SC

PROCEDURE

BATTERY(IES) DISCHARGE IN FLIGHT	
ENG START rotary selector	CHECK OFF
■ If battery(ies) still discharging LAND ASAP	

COMMENTS

Alarm (MC + SC + ELEC on CAP) is controlled by MFC 1B or 2B and is inhibited :

- on ground
- on BAT OVRD position
- in DUAL DC GEN LOSS

	PROCEDURES FOLLOWING FAILURE ELECTRICAL SYSTEM	2.05.04		
		P 8	001	
				DEC 95

AA

DUAL CHG LOSS

ALERT

	CONDITION	VISUAL	AURAL
R	MFC failure leading to dual battery charge contactors loss	<ul style="list-style-type: none"> - MC flashing amber - ELEC amber light on CAP - both green arrows illuminated on overhead panel 	NONE

PROCEDURE

DUAL CHG LOSS	
MFC modules	ONE AT A TIME OFF/RESET
<ul style="list-style-type: none"> ■ If unsuccessful LAND ASAP If conditions permit, minimize use of VHF1 	

COMMENTS

This case should only occur following a MFC software failure.

	PROCEDURES FOLLOWING FAILURE ELECTRICAL SYSTEM	2.05.04		
		P 9	001	
				JUN 95

R **DC SVCE and UTLY BUS SHED**

ALERT

CONDITION	VISUAL	AURAL
One UTLY BUS automatically shed after a source overload	- MC light flashing amber - ELEC amber light on CAP - SVCE and UTLY BUS SHED amber light on overhead panel	SC

PROCEDURE

DC SVCE and UTLY BUS SHED	
DC SVCE and UTLY BUS	As required

COMMENTS

- R - Switching OFF DC SVCE and UTLY BUS pb will :
 - confirm automatic shedding of affected UTLY BUS
 - and -
- R · shut off the non affected UTLY BUS and the DC SVCE BUS ;
it is crew decision to select related pb OFF or not.

	PROCEDURES FOLLOWING FAILURE ELECTRICAL SYSTEM	2.05.04		
		P 10	001	
				JUN 97

AA

INV FAULT**ALERT**

CONDITION	VISUAL	AURAL
Under/over voltage at INV output	<ul style="list-style-type: none"> - MC flashing amber - ELEC amber light on CAP - Associated INV FAULT amber light on overhead panel. 	SC

PROCEDURE

INV FAULT
NO SPECIFIC ACTION IN FLIGHT

COMMENTS

- In case of inverter failure after 10 sec., the AC BTC is automatically closed causing the affected AC BUS and AC STBY BUS to be supplied from the remaining inverter.

	PROCEDURES FOLLOWING FAILURE ELECTRICAL SYSTEM	2.05.04		
		P 11	001	
				JUN 97

AA

AC BUS 1 OFF

ALERT

CONDITION	VISUAL	AURAL
AC BUS 1 not supplied (short circuit protection)	<ul style="list-style-type: none"> - MC light flashing amber - ELEC amber light on CAP - associated INV FAULT and BUS OFF amber light on overhead panel 	SC

PROCEDURE

AC BUS 1 OFF	
<i>Note : Wait for 10 sec in order to confirm the failure.</i>	
DC BTC	ISOL then ON
■ If unsuccessful	
BUS EQUIPMENT LIST	CHECK

COMMENTS

- R - The DC BTC pb controls also the AC BTC. The reset of this pb may help to recover the affected AC BUS.
- In case of inverter failure, the AC BUS 1 OFF light illuminates during 10 sec. through the BTR temporizing, then extinguishes. The AC BUS 1 is now available. An AC BUS 1 failure is effective as soon as the light stays ON after 10 sec.

	PROCEDURES FOLLOWING FAILURE ELECTRICAL SYSTEM	2.05.04		
		P 12	001	
				JUN 97

AC BUS 2 OFF

ALERT

CONDITION	VISUAL	AURAL
AC BUS 2 not supplied (short circuit protection)	<ul style="list-style-type: none"> - MC light flashing amber - ELEC amber light on CAP - associated INV FAULT and BUS OFF amber light on overhead panel 	SC

PROCEDURE

AC BUS 2 OFF	
<i>Note : Wait for 10 sec. in order to confirm the failure.</i>	
DC BTC	ISOL then ON
■ If unsuccessful	
PF	CM1
BUS EQUIPMENT LIST	CHECK

COMMENTS

- The DC BTC pb also controls the AC BTC. The reset of this pb may help to recover the affected AC BUS.
- CM 1 is pilot flying due to loss of ASI, VSI, Altimeter on F/O panel.
- In case of inverter failure, the AC BUS 2 OFF light illuminates during 10 sec. through the BTR temporizing, then extinguishes. The AC BUS 2 is now available. An AC BUS 2 failure is effective as soon as the light stays ON after 10 sec.

	PROCEDURES FOLLOWING FAILURE ELECTRICAL SYSTEM	2.05.04		
		P 13	001	
				JUL 98

AA

ACW GEN FAULT

ALERT

CONDITION	VISUAL	AURAL
One ACW generator channel inoperative	<ul style="list-style-type: none"> - MC light flashing amber - ELEC amber light on CAP - associated ACW GEN FAULT amber light on overhead panel 	SC

PROCEDURE

ACW GEN FAULT	
ACW GEN affected	OFF
LEAVE AND AVOID ICING CONDITIONS	
TAXI ON BOTH ENGINES	

R

COMMENTS

- It is possible to try a reset by selecting the ACW GEN ON again. If unsuccessful leave ACW GEN OFF.

	PROCEDURES FOLLOWING FAILURE ELECTRICAL SYSTEM	2.05.04		
		P 14	001	
				JUN 97

AA

ACW BUS 1 OFF

ALERT

CONDITION	VISUAL	AURAL
ACW BUS 1 not supplied (short circuit protection)	<ul style="list-style-type: none"> - MC light flashing amber - ELEC amber light on CAP - ACW GEN 1 FAULT and associated ACW BUS OFF amber light on overhead panel 	SC

PROCEDURE

ACW BUS 1 OFF	
ACW GEN 1	OFF
LEAVE AND AVOID ICING CONDITIONS	
Affected equipment	OFF
CAPT AIRSPEED IND	MONITOR
HYD X FEED	ON
BUS EQPT LIST	CHECK
ADC DISAGREEMENT PROCEDURE	APPLY

COMMENTS

- Monitor CAPT airspeed ind. for erroneous indications due to loss of associated pitot heating.
- Blue hydraulic system users are supplied by the green hydraulic system after hydraulic crossfeed has been opened.

	PROCEDURES FOLLOWING FAILURE	2.05.04		
		P 15	001	
	ELECTRICAL SYSTEM			JUN 97

AA

ACW BUS 2 OFF

ALERT

CONDITION	VISUAL	AURAL
ACW BUS 2 not supplied (short circuit protection)	<ul style="list-style-type: none"> - MC light flashing amber - ELEC amber light on CAP - ACW GEN 2 FAULT and associated ACW BUS OFF amber light on overhead panel 	SC

PROCEDURE

ACW BUS 2 OFF	
ACW GEN 2	OFF
LEAVE AND AVOID ICING CONDITIONS	
Affected equipment	OFF
F/O AIRSPEED IND	MONITOR
HYD X FEED	ON
BUS EQPT LIST	CHECK
ADC DISAGREEMENT PROCEDURE	APPLY
TAXI ON BOTH ENGINES	

COMMENTS

- Monitor F/O airspeed ind. for erroneous indications due to loss of associated pitot heating.
- Green hydraulic system users are supplied by the blue hydraulic system after hydraulic crossfeed has been opened.

	PROCEDURES FOLLOWING FAILURE ELECTRICAL SYSTEM	2.05.04		
		P 16	001	
				JUN 96

**ACW TOTAL LOSS
ALERT**

CONDITION	VISUAL	AURAL
ACW total loss	<ul style="list-style-type: none"> - MC light flashing amber - ELEC amber light on CAP - Both ACW GEN FAULT lights and both ACW BUS OFF amber LTS on overhead panel 	SC

PROCEDURE

ACW TOTAL LOSS	
ACW GEN both	OFF
HYD X FEED	CHECK OFF
LEAVE AND AVOID ICING CONDITIONS	
Affected equipment	OFF
CAPT and F/O AIRSPEED INDS	MONITOR
MAIN HYD PUMPS	OFF
LANDING GEAR EXT/RET	} LOST
NORM BRAKE	
LANDING DISTANCE	MULTIPLY BY 1.5
BUS EQPT LIST	CHECK
● Before landing	
L/G LEVER	DOWN
BLUE PRESSURE	CHECK
FLAPS	As required
L/G GRAVITY EXTENSION PROC	APPLY
● After touchdown	
USE FULL REVERSE IF NECESSARY	
BRK HANDLE	EMER as required
TAXI ON BOTH ENGINES	

COMMENTS

- Monitor CAPT and F/O airspeed inds for erroneous indications due to loss of associated pitot heating. STBY instruments will be used as a reference.
- The HYD AUX PUMP allows flaps extension, maintains the nosewheel steering and powers the emergency brake accumulator.
- If a go around has to be performed :
 - . landing gear will not retract.
 - . flaps will retract with a lower speed than normal due to DC AUX PUMP size.
- LDG DIST is multiplied by 1.5 due to loss of normal braking.



AR72
F.C.O.M.

PROCEDURES FOLLOWING FAILURE

ELECTRICAL SYSTEM

2.05.04

P 17

050

DEC 96

BUS EQPT LIST

SYS ▼	BUS FAILURES								BAT ONLY ACW AVAILABLE		
	DC BUS		AC BUS		STBY BUS (AC + DC)	ACW BUS			BAS/C	STBY BUS UNDV	STBY BUS OVRD
	1	2	1	2		1	2	1+2			
N A V E L T	AHRS								#2 LOST	#2* LOST	#2 LOST
	ASI/VS/ ALTI				F/D LOST	CAPT LOST			F/D LOST	BOTH LOST	F/D LOST
	ADC		#2 LOST		OUTPUT #2 LOST				#2 LOST	BOTH LOST	#2 LOST
	FMS	#1 LOST	#2 LOST						BOTH LOST	BOTH LOST	BOTH LOST
	VDP/ILS/ EADI, SDI		#2 LOST			#1 LOST			#2 LOST	BOTH LOST	#2 LOST
	DME	#1 LOST	#2 LOST						LOST	LOST	LOST
	ADT		#2 LOST		#2 LOST				#2 LOST	BOTH LOST	#2 LOST
	GPWS	LOST			LOST				LOST	LOST	LOST
	RADAR	LOST		LOST					LOST	LOST	LOST
	RADIO AL	LOST							LOST	LOST	LOST
	TAS, TAT, SAT					LOST				LOST	LOST
	RMI		#1 LOST		#1 LOST	#2 LOST			#1 LOST	BOTH LOST	#1 LOST
OMEGA									LOST		
A F C S	AFC COMPT	LOST							LOST	LOST	LOST
	AFC ADJ		LOST						LOST	LOST	LOST
C O M	VHF		#2 LOST						#2 LOST	#2 LOST	#2 LOST
	HF									LOST	LOST
	AFC		#2 LOST						#2 LOST	#2 LOST	#2 LOST
C C A S	CCAS		Partially LOST **						AMBER ALERTS LOST	AMBER ALERTS LOST	AMBER ALERTS LOST
H Y D	MAIN PUMPS					BLUE LOST	GREEN LOST	BOTH LOST			
	AUX PUMP		LOST						LOST	LOST	LOST
	PRESS IND				LOST					LOST	
	FLAPS				LOST	USE X FLED				LOST	
	X FEED VALVE				LOST					LOST	

* : AUTO ERECT LOST ON AHRS 1

** : Amber lights of CAP are lost except MFC, PRKG BRK, MAINT PNL

BUS EQPT LIST

SYS ▼	BUS FAILURES								BAT ONLY (ACW AVAILABLE)		
	DC BUS		AC BUS		STBY BUS (AC-DC)	ACW BUS			BASIC	STBY BUS UNDV	STBY BUS OVRD
	1	2	1	2		1	2	1+2			
F L T C T I	STICK PUSHER	LOST							LOST	LOST	LOST
	STICK SHAKER								LOST	LOST	LOST
	TRIM IND			LOST							
L / G a n d B R K	L/G HFT				LOST		*	LOST		LOST	
	L/G EXT				EMER ONLY		*	EMER **		EMER ONLY	
	L/G POS IND		OVHD PANEL LOST		MAIN PANEL LOST				OVHD PANEL LOST	BOTH LOST	OVHD PANEL LOST
	ANTI SKID							LOST		INB LOST	INB LOST
	LANDING LIGHTS					L LOST	R LOST	BOTH LOST			
	TAXI AND T/O LIGHTS		LOST				LOST		LOST	LOST	LOST
P W R P L A N T	FF F/O OILT and P FCI	1 LOST	2 LOST						BOTH LOST	BOTH LOST	BOTH LOST
	AUTO IDLE GATE	LOST							LOST	LOST	LOST
	IDLE GATE FAIL IND. PROP BRK		LOST							LOST	LOST
R A I R	RECIRC FAN	1 LOST	2 LOST						BOTH LOST	BOTH LOST	BOTH LOST
	BLEED / PACKS								AUTO LOST	LOST	LOST
	PRESSU	AUTO LOST							LOST	LOST	LOST
R I C E a n d R A I N	ICE DETECTOR						LOST ^a	LOST ^b			
	HORNS ANTI ICE					RUD LELEV LOST		ALL RELEV LOST	BOTH LOST		
	PROP ANTI ICE					P1 LOST		P2 LOST	LOST		
	WIPERS		F/O LOST						F/O LOST	BOTH LOST	BOTH LOST
	MAIN WINDOW HTG SIDE WINDOW HTG	L LOST	R LOST			L FRONT LOST		R FRONT LOST	BOTH LOST		
	PROBE HTG					CAPT PITOT ALPHA TAT LOST		F/O PITOT ALPHA TAT LOST	CAPT F/O TAT LOST		
STATICS PORTS	CAPT STBY LOST	F/O LOST						ALL LOST	ALL LOST	ALL LOST	

* : hyd green pump lost : use cross feed.

** : Using hyd X feed when only DC hydraulic pump is available is not recommended.



PROCEDURES FOLLOWING FAILURE

HYDRAULIC

2.05.05		
P 1	001	
		JUN 97

AA

HYD TK COMPT LO LEVEL

ALERT

CONDITION	VISUAL	AURAL
Tank compartment fluid quantity below 2,5 l (0,67 US gal)	<ul style="list-style-type: none"> - MC light flashing amber. - HYD amber light on CAP. - associated LO LVL amber light on overhead panel. - associated LO PR It on MAIN PUMP pb on overhead panel. 	SC

PROCEDURE

HYD TK COMPT LO LEVEL	
PUMP(s) associated	OFF
■ BLUE SYSTEM AFFECTED	
AUXILIARY PUMP	OFF (CONFIRMED)
FLAPS	}
SPOILERS	
NOSE WHEEL STEERING	
PROP BRK	
EMER AND PARK BRK	ON ACCU ONLY
REDUCED FLAPS LDG PROC (Flaps 0)	APPLY
TAXI ON BOTH ENGINES	
■ GREEN SYSTEM AFFECTED	
LANDING GEAR EXT/RET }	LOST
NORM BRK	
LDG DIST FLAPS 30	MULTIPLY BY 1.5
L/G GRAVITY EXTENSION PROC	APPLY
● After touchdown :	
USE FULL REVERSE IF NECESSARY	
BRK HANDLE	EMERGENCY AS REQUIRED
TAXI ON BOTH ENGINES	

	PROCEDURES FOLLOWING FAILURE	2.05.05		
		P 2	001	
	HYDRAULIC			JUN 97

AA

COMMENTS

- In case of LO LEVEL, X feed remains closed and X FEED valve operation is automatically inhibited.
- If blue system is affected :
 - flaps
 - nose wheel steering
 - propeller brake
 - spoilers

are lost.

The landing distance is increased due to loss of flaps. For emergency/parking brake, the brake accumulator allows at least six applications of braking force at full braking pressure.

- If green system is affected :
 - normal braking
 - landing gear normal extension/retraction

are lost.

The landing distance is increased due to loss of normal braking. If a go around has to be performed, landing gear will not retract.

	PROCEDURES FOLLOWING FAILURE HYDRAULIC	2.05.05		
		P 3	001	
				JUN 97

AA

HYD LO PR/HYD OVHT

ALERT

CONDITION	VISUAL	AURAL
Pump delivery pressure below 1500 PSI (103,5 bar)	- MC light flashing amber. - HYD amber light on CAP. associated pump LO PR amber light on overhead panel.	SC
Pump case drain line temperature above 121 °C (250 °F)	- MC light flashing amber. - HYD amber light on CAP. associated OVHT amber light on overhead panel.	SC

PROCEDURE

HYD LO PR/HYD OVHT	
PUMP affected	OFF
X FEED	ON

COMMENTS

- Failed system users are supplied by the non affected pump when opening the cross feed.
- In case of OVHT, an attempt to restore the system may be performed after OVHT alert has extinguished.

	PROCEDURES FOLLOWING FAILURE HYDRAULIC	2.05.05		
		P 4	001	
				JUN 97

AA

BOTH MAIN HYD PUMPS LOSS

PROCEDURE

BOTH MAIN HYD PUMPS LOSS	
MAIN PUMPS	OFF
X FEED	CHECK OFF
SPOILERS - FLAPS (if L/G lever UP)	LOST
LANDING GEAR EXT/RET	LOST
NORM BRK	LOST
LDG DIST FLAPS 30	MULTIPLY BY 1.5
<ul style="list-style-type: none"> ● Before landing 	
L/G LEVER	DOWN
BLUE PRESSURE	CHECK
FLAPS 15	AS REQUIRED
L/G GRAVITY EXT PROCEDURE	APPLY
FLAPS 30	AS REQUIRED
<ul style="list-style-type: none"> ● After touchdown 	
FULL REVERSE	IF NECESSARY
BRK HANDLE	EMER AS REQUIRED
TAXI ON BOTH ENGINES	

COMMENTS

- For emergency/parking brake, the brake accumulator allows at least six applications of braking force at full braking pressure.
- If a go around has to be performed, landing gear will not retract.
- The landing distance is increased due to loss of normal braking.

	PROCEDURES FOLLOWING FAILURE HYDRAULIC	2.05.05		
		P 5	550	
				JUN 97

BOTH HYD SYS LOSS

ALERT

This situation may be generated by a combination of LO LEVEL, LO PR and/or OVHT alerts.

PROCEDURE

BOTH HYD SYS LOSS		
MAIN and AUX PUMPS	OFF	
FLAPS	}	
SPOILERS		
LANDING GEAR EXT/RET		
NORMAL BRK		
NOSE WHEEL STEERING		
PROP BRK	}	
EMER AND PARK BRK		ON ACCU ONLY
GPWS		FLAP OVRD
LDG DIST FLAPS 30		MULTIPLY LDG DIST BY 2.9
L/G GRAVITY EXTENSION PROCEDURE		APPLY
LANDING	FLAPS 0°	
APP/LDG SPEED	Vm HB 0 + wind effect + 5 kt	
CAUTION : Tail strike may occur if pitch attitude exceeds 8° during the flare depending upon vertical speed at touch down.		
● After touchdown		
USE FULL REVERSE IF NECESSARY		
BRK HANDLE	EMER as required	
TAXI ON BOTH ENGINES		

COMMENTS

- The landing distance is increased due to loss of flaps and of normal braking.
- For emergency/parking brake, the brake accumulator allows at least six applications of braking force at full braking pressure.
- If a go around has to be performed, landing gear will not retract.

	PROCEDURES FOLLOWING FAILURE FLIGHT CONTROLS	2.05.06		
		P 1	050	
				JUL 98

AA

REDUCED FLAPS LDG

PROCEDURE

REDUCED FLAPS LDG		
GPWS		FLAP OVRD
MAXIMUM APPROACH SLOPE		3°
FLAPS	LDG FLAPS 30° MULTIPLY BY	APP/LDG SPD
0	2.2	Vm HB 0+5 kt + wind effect
15	2	Vm HB 15 + wind effect
<p><i>Note : - For flaps 0 landing, reduce progressively power when reaching 10 ft. - Tail strike may occur if pitch attitude exceed 8° during the flare depending upon vertical speed at touch down.</i></p>		

COMMENTS

- GPWS must be selected FLAP OVRD to prevent nuisance alerts on final approach.

	PROCEDURES FOLLOWING FAILURE FLIGHT CONTROLS	2.05.06		
		P 2	001	
				DEC 94

AA

FLAPS UNLK

ALERT

CONDITION	VISUAL	AURAL
Flaps untimely retraction of more than 4° when flaps extended	<ul style="list-style-type: none"> - MW light flashing red - FLAPS UNLK red light on CAP 	CRC

PROCEDURE

FLAPS UNLK

■ If alarm occurs during take-off

- Before V1

TAKE OFF ABORT INITIATE

- After V1

VR, V2 INCREASE + 10 kt

- When possible

FLAPS 0°

REDUCED FLAPS LDG PROCEDURE APPLY

■ If alarm occurs during approach

GA POWER APPLY

GA speed INCREASE + 10 kt

- When possible

FLAPS 0°

REDUCED FLAPS LDG PROCEDURE APPLY

R

R

R



ATR 72
F.C.O.M.

PROCEDURES FOLLOWING FAILURE

FLIGHT CONTROLS

2.05.06

P 3

001

JUN 97

AA

FLAPS JAM/FLAPS UNCPL

ALERT

No specific alert is provided

PROCEDURE

FLAPS JAM/FLAPS UNCPL

FLAPS CONTROL LEVER	NEAR FLAPS PRESENT POSITION
REDUCED FLAPS LDG PROC	APPLY

COMMENTS

- The flaps control lever is maintained at a position near the flaps present position in order to minimize any untimely effect in case of system self recovery.
- One of the possible causes for flaps jam is a flaps asymetry detection. As soon as the maximum asymetry value authorized by the mechanism is reached, the electrical supply to the flap control system is isolated :
 - . the flaps stay in their present position
 - . the control lever has no more action on the system
 System reconfiguration has to be performed on ground.
- Flaps jamming may be one of the causes of inner/outer flaps uncoupling.

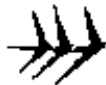
 ATR72 F.C.O.M.	PROCEDURES FOLLOWING FAILURE FLIGHT CONTROLS	2.05.06		
		P 4	001	
				JUN 97

AA

FLAP ASYM

ALERT

CONDITION	VISUAL	AURAL
Flaps asymmetry of more than 6.7° during Flaps actuation	<ul style="list-style-type: none"> - MC light flashing amber - FLT CTL amber light on CAP - FLAP ASYM amber light on flight panel 	SC

PROCEDURE

FLAP ASYM
FLAP JAM PROC APPLY

COMMENTS

As soon as the maximum asymmetry of 6.7° between the flaps is reached, the electrical supply to the flap control system is isolated :

- the flaps stay in their present position.
- the control lever has no more action on the system. System reconfiguration has to be performed on ground.

	PROCEDURES FOLLOWING FAILURE FLIGHT CONTROLS	2.05.06		
		P 5	001	
				DEC 96

ELEV JAM

ALERT

There is no indication of an elevator jam other than an inability to operate the control column.

PROCEDURE

ELEV JAM	
CONTROL COLUMNS	UNCOUPLE
AVOID ICING CONDITIONS	
MAX SPEED	180 kt
<ul style="list-style-type: none"> ■ If one elevator is stuck to full down position <ul style="list-style-type: none"> MAX SPEED 154 kt ■ If left elevator is jammed <ul style="list-style-type: none"> MINIMUM MANEUVER OPERATING SPEED INC by 10 kt ■ If elevator jamming occurs at take off <ul style="list-style-type: none"> MAX SPEED to complete the flight 161 kt 	
MAX LOAD FACTOR	2 g
BANK ANGLE MUST BE RESTRICTED TO 30° until flaps extension	
MAXIMUM APPROACH SLOPE	3°
VAPP	INCREASE BY 10 KT
LANDING DISTANCE FLAPS 30	MULTIPLY BY 1.13
R LAND AT AIRPORT WITH MINIMUM CROSSWIND	
R REDUCE SMOOTHLY TO FLARE	

COMMENTS

- Both pilots accomplish a firm action on their own column IN THE WAY REQUIRED BY THE JAMMING CONDITION.
One of the two channels must yield (force required 52 daN = 115 lbs).
- Stick pusher acts on LH elevator. If LH control column is jammed, stick pusher must be considered as inoperative.
- The maximum speed authorized if elevator jamming occurs at take off is linked to the elevator take off position.
- When RH elevator is jammed, AP is no more available.

	PROCEDURES FOLLOWING FAILURE FLIGHT CONTROLS	2.05.06		
		P 6	001	
				NOV 93

PITCH DISCONNECT

ALERT

CONDITION	VISUAL	AURAL
Pitch coupling mechanism disconnected	<ul style="list-style-type: none"> - MW light flashing red - PITCH DISCONNECT red light on CAP 	CRC

PROCEDURE

PITCH DISCONNECT	
AVOID ICING CONDITIONS	
CHECK BOTH CONTROL COLUMNS FREE	
MAX SPEED	180 Kt
MAX LOAD FACTOR	2g
BANK ANGLE MUST BE RESTRICTED TO 30° until flaps extension	
MAXIMUM APPROACH SLOPE	3°
V _{app}	INC BY 10 Kt
LANDING DISTANCE FLAPS 30	MULTIPLY BY 1.13
LAND AT AIRPORT WITH MINIMUM CROSSWIND	
REDUCE SMOOTHLY TO FLARE	

COMMENTS

- As both elevator channels are disconnected, pitch control efficiency is reduced.

	PROCEDURES FOLLOWING FAILURE	2.05.06		
		P 7	001	
	FLIGHT CONTROLS			JUN 97

PITCH TRIM INOPERATIVE

ALERT

Both normal and standby pitch trim controls are inoperative.

PROCEDURE

PITCH TRIM INOPERATIVE	
MAINTAIN EXISTING CONFIGURATION AND SPEED AS LONG AS POSSIBLE	
● For approach	
MAXIMUM APPROACH SLOPE	3°
EXTEND FLAPS AT VFE FOR EACH CONFIGURATION	
LANDING SPEED	INCREASE BY 10 kt
LANDING DISTANCE	MULTIPLY BY 1.13

COMMENTS

- Maintain existing configuration and speed as long as possible to avoid high forces on the columns.
- The landing distance is increased due to landing speed increase.



ATR72
F.C.O.M.

PROCEDURES FOLLOWING FAILURE

2.05.06

P 8

001

FLIGHT CONTROLS

JUN 97

PITCH TRIM ASYM

ALERT

CONDITION	VISUAL	AURAL
Pitch tabs desynchronization	<ul style="list-style-type: none"> - MC light flashing amber - FLT CTL illuminates amber on CAP - PITCH TRIM ASYM illuminates amber on flight deck 	SC

PROCEDURE

PITCH TRIM ASYM	
AP DISCONNECTION	CONFIRM MANUALLY
PITCH TRIM INOPERATIVE PROCEDURE	APPLY

COMMENTS

- When a PITCH TRIM ASYM alert is generated, AP automatically disconnects and cannot be reengaged. However, it is recommended to manually confirm AP disconnection.
Don't use the trims any more and apply **PITCH TRIM INOPERATIVE** procedure.

	PROCEDURES FOLLOWING FAILURE FLIGHT CONTROLS	2.05.06		
		P 9	001	
				JUN 97

AA

STICK PUSHER/SHAKER FAULT

ALERT

CONDITION	VISUAL	AURAL
Stick pusher / shaker fault	- MC light flashing amber - FLT CTL amber light on CAP - FAULT amber light in STICK PUSHER/SHAKER p.b.	SC

PROCEDURE

STICK PUSHER/SHAKER FAULT	
STICK PUSHER/SHAKER	OFF
Vm HB/Vm LB for all configurations	INC BY 10 kt
LANDING DISTANCE	MULTIPLY BY 1.13

COMMENTS

- The minimum maneuvering speeds are increased by 10 kt in order to increase stall margin.



ATR72
F.C.O.M.

PROCEDURES FOLLOWING FAILURE

2.05.06

P 10

001

FLIGHT CONTROLS

NOV 93

AILERON JAM

ALERT

There is no indication of an aileron jam other than an inability to operate the control wheel laterally.

PROCEDURE

AILERON JAM

BANK ANGLE LIMIT (USING RUDDER) 25°

BLUE HYD PUMPS OFF

LAND AT AIRPORT WITH MINIMAL CROSSWIND

● **For approach**

MAXIMUM APPROACH SLOPE 3°

FLAPS 30° LANDING PERFORM

SELECT BLUE HYD PUMP ON BEFORE FLAPS EXTENSION

THEN SELECT IT OFF AS WELL AS HYD AUX PUMP

DO NOT EXTEND FLAPS IN TURN

● **Immediately after touch down**

BLUE HYD PUMP and HYD AUX PUMP ON

COMMENTS

- Bank angle is limited to 25° due to reduced roll control efficiency.
- Blue pump and Aux pump are selected OFF in order to decrease drag from associated extended spoiler. These pumps are selected ON again when necessary then selected OFF. They must be reselected ON immediately after touch down in order to recover nose wheel steering.

	PROCEDURES FOLLOWING FAILURE FLIGHT CONTROLS	2.05.06		
		P 11	001	
				NOV 93

SPOILER JAM

ALERT

Spoiler jam may be detected when a SPLR It is illuminated on the overhead panel with control wheel at neutral position.

PROCEDURE

SPOILER JAM

BLUE HYD PUMPS OFF

LAND AT AIRPORT WITH MINIMAL CROSSWIND

● **For approach**

MAXIMUM APPROACH SLOPE 3°

FLAPS 30 LANDING PERFORM

SELECT BLUE HYD PUMP ON BEFORE FLAPS EXTENSION

THEN SELECT IT OFF AS WELL AS HYD AUX PUMP

● **Immediately after touch down**

BLUE HYD PUMP and HYD AUX PUMP ON

COMMENTS

Blue hyd pump and Aux pump are selected OFF in order to try to decrease drag from the associated extended spoiler. The pumps are selected ON again when necessary then selected OFF. They must be reselected ON immediately after touch down in order to recover nose wheel steering.

 AJR 72 F.C.O.M.	PROCEDURES FOLLOWING FAILURE FLIGHT CONTROLS	2.05.06		
		P 12	001	
				NOV 93

RUDDER JAM

ALERT

There is no indication of a rudder jam other than an inability to operate the rudder pedals.

PROCEDURE

RUDDER JAM

MAXIMUM APPROACH SLOPE 3°
 FLAPS 30° LANDING PERFORM
 USE DIFFERENTIAL POWER SO AS TO MINIMIZE SIDE SLIP.
 LAND AT AIRPORT WITH MINIMUM CROSS WIND.

● **At touch down**

NOSE DOWN BEFORE REDUCTION BELOW FI

 ATR 72 F.C.O.M.	PROCEDURES FOLLOWING FAILURE FLIGHT CONTROLS	2.05.06		
		P 13	001	
				JUN 97

AA

RUD RELEASABLE CENTERING UNIT FAIL

ALERT

There is no indication of a rudder releasable centering unit failure other than a dutch roll oscillation tendency.

PROCEDURE

RUD RELEASABLE CENTERING UNIT FAIL	
<ul style="list-style-type: none"> ■ If YD is available 	YD ENGAGE
<ul style="list-style-type: none"> ■ If YD is not available 	KEEP THE FEET ON THE PEDALS

 A320 F.C.O.M.	PROCEDURES FOLLOWING FAILURE FLIGHT CONTROLS	2.05.06		
		P 14	001	
				JUL 98

AA

TLU FAULT**ALERT**

CONDITION	VISUAL	AURAL
Both ADC are lost or disagree between actual and theoretical TLU position or TLU synchro position failure	- MC light flashing amber - FLT CTL amber light on CAP - TLU FAULT amber light on overhead panel	SC

PROCEDURE

TLU FAULT	
<ul style="list-style-type: none"> ■ If both ADC are lost <ul style="list-style-type: none"> ■ IAS above 185 kt TLU HIGH SPEED ■ IAS below 185 kt TLU LOW SPEED 	
DISREGARD TLU FAULT ALERT	
<ul style="list-style-type: none"> ■ If at least one ADC operates <ul style="list-style-type: none"> ■ IAS above 185 kt TLU HIGH SPEED <ul style="list-style-type: none"> ■ If TLU FAULT alarm persists MAX SPEED 180 kt TLU LOW SPEED ■ IAS below 185 kt MAX SPEED 180 kt TLU LOW SPEED <ul style="list-style-type: none"> ■ If TLU green light is not lit V_{app} INC by 10 kt Landing distance 30 multiply by 1.13 LAND AT AIRPORT WITH MINIMUM CROSSWIND 	
<i>Note : maximum demonstrated crosswind on dry runway with TLU in high speed position : 15 kt</i>	

COMMENTS

- R - if both ADC are lost, TLU automatic functioning is lost. TLU must be set manually according to IAS red on the STBY ASI.

	PROCEDURES FOLLOWING FAILURE FLIGHT CONTROLS	2.05.06		
		P 15	010	
				JUL 00

AA

AIL LOCK LIT**ALERT**

CONDITION	VISUAL	AURAL
Disagree between Aileron locking actuators and gust lock control (Temporized alert 8 sec.)	<ul style="list-style-type: none"> - MC flashing amber - FLT CTL amber light illuminates on CAP - AIL LOCK amber light illuminates on the pedestal. 	Single chime (SC)
Aileron locking actuators not fully retracted and PL on TO position	<ul style="list-style-type: none"> - MW flashing red - CONFIG red light illuminates on CAP - FLT CTL amber light illuminates on CAP. 	Continuous Repetitive Chime (CRC)
Disagree between Aileron locking actuators and gust lock control during the TO CONFIG TEST		

PROCEDURE

AIL LOCK LIT
<ul style="list-style-type: none"> ■ Before take-off <ul style="list-style-type: none"> - Return to parking - Refer to MMEL item 70-1, GUST LOCK system ■ After landing <ul style="list-style-type: none"> - Take special care for TAXI (wind effects) - Use standby system for Aileron lock at parking - Inform maintenance

COMMENTS

A malfunction of an aileron locking actuators is pointed out according two levels of protection :

- an amber alarm, before the take off, with a 8 s delay
- a red alarm if :
 - . either TO CONFIG TEST is performed,
 - . or PLs are set on TO position.

	PROCEDURES FOLLOWING FAILURE LANDING GEAR	2.05.07		
		P 1	001	
				JUL 01

L/G UNSAFE INDICATION

ALERT

CONDITION	VISUAL	AURAL
- Any gear not seen down locked, and - Flaps 30, and - ZRA < 500 ft	- MW light flashing red - LDG GEAR NOT DN red light on CAP	CRC (which may not be silenced by depressing the MW pb)
- Any gear not seen down locked, and - at least one PL at FI, and - ZRA < 500 ft	- red light in landing gear lever - any green ∇ light not illuminated on either panel	CRC (which may be silenced by depressing the MW pb)

Note : - The second condition is inhibited during 150 seconds after the retraction of at least one landing gear leg, to cover the case of the one engine go around.
 - In both cases, the ZRA condition is inhibited in case of radio altimeter failure.

PROCEDURE

L/G UNSAFE INDICATION	
<ul style="list-style-type: none"> ■ L/G selected DOWN <ul style="list-style-type: none"> ■ GREEN LT OFF on one panel only UNSAFE INDICATION DISREGARD ■ GREEN LT OFF on both panels L/G GRAVITY EXT PROCEDURE APPLY <ul style="list-style-type: none"> ■ If unsuccessful LDG WITH ABNORM L/G PROCEDURE APPLY ■ L/G selected UP <ul style="list-style-type: none"> ■ RED LT ON on one panel only UNSAFE INDICATION DISREGARD ■ RED or GREEN LT ON on both panel MAX SPEED 160 kt L/G DOWN 	

 ATR 72 F.C.O.M.	PROCEDURES FOLLOWING FAILURE LANDING GEAR	2.05.07		
		P 2	001	
				DEC 94

AB

COMMENTS

- Landing gear selected down

- If all green light are illuminated on one panel, the unsafe indication is false
- If overhead panel (detection system 2) gives false indication, use of emergency audio cancel will be requested to cancel aural warning (CRC) as soon as flaps will be selected 30°.
- If one gear remains unlocked, perform turns to increase load factor and perform alternating side slips in an attempt to lock the gear.

- Landing gear selected up

- If light illuminated on one indicator but indications are normal on the other panel, the unsafe indication is false.
- Flight with landing gear extended has a significant effect on fuel consumption and climb gradient (see SPECIAL OPERATIONS).
- Landing gear down selection may be delayed if performance requires.

R

 ATR 72 F.C.O.M.	PROCEDURES FOLLOWING FAILURE LANDING GEAR	2.05.07		
		P 3	001	
				JUN 97

L/G GRAVITY EXTENSION

PROCEDURE

L/G GRAVITY EXTENSION	
L/G LEVER	DOWN
EMER EXTENSION HANDLE	PULL ABOVE PEDESTAL LEVEL
CAUTION : Do not twist the handle when operating.	
<p>■ If the handle comes down PULL AGAIN AND MAINTAIN UP TO GREEN LIGHTS ILLUMINATED</p>	
<p>■ If unsuccessful LDG WITH ABNORM L/G PROCEDURE APPLY</p>	

COMMENTS

- Although gravity extension is possible up to VLO, it is recommended to perform it at a lower speed compatible with flight conditions.
- Pulling the handle mechanically releases the up locks. Pushing the handle back resets the uplocking system.

TRAINING

- After gravity extension for training purposes, reset the emergency extension handle before normal retraction. If handle is maintained pulled, hydraulic configuration will inhibit gear retraction.



AJR72
F.C.O.M.

PROCEDURES FOLLOWING FAILURE

2.05.07

P 4

001

LANDING GEAR

JUN 94

LDG WITH ABNORM L/G

PROCEDURE

LDG WITH ABNORM L/G

● **Preparation**

CABIN CREW NOTIFY
 ATC/TRANSPONDER NOTIFY/AS ROD
 SEAT BELTS/NO SMOKING ON
 GPWS OFF
 CABIN and COCKPIT PREPARE

- . Loose equipment secured
- . Survival equipment prepared
- . Belts and shoulder harness locked

FUEL WEIGHT (if possible) REDUCE

■ **If abnormal nose L/G**

CG location (if possible) AFT

■ **If abnormal main L/G**

FUEL UNBALANCE (if possible) ESTABLISH
 Reduce fuel on side with failed L/G

● **Approach**

L/G LEVER CONFIRMED DOWN
 L/G EMER EXT HANDLE CONFIRMED PULLED
 ENG START rotary selector OFF/START ABORT
 CABIN REPORT OBTAINED

● **Before landing**

BLEEDS OFF
 BRACE FOR IMPACT ORDER

● **Touch down**

BOTH PL GI
 BOTH CL FUEL SO





AR72
F.C.O.M.

PROCEDURES FOLLOWING FAILURE

LANDING GEAR

2.05.07

P 5

001

NOV 93

AB

R

● **After touch down**

BOTH FIRE HANDLES PULL

● **When A/C stopped**

PARKING BRAKE SET

CABIN CREW NOTIFY

FUEL PUMPS OFF

AGENTS DISCH

EVACUATION INITIATE

BAT(before leaving A/C) OFF

COMMENTS

- The procedure is intended for use when one or more landing gear fail to extend or/and lockdown following the application of either normal or gravity gear extension procedure.
It is considered preferable to use all available gear locked down rather than carry out a belly landing. Under these circumstances, a hard surface runway landing is to be recommended.
Full advantage should be taken from foam spread on the runway.
- Notify ATC of the nature of emergency encountered and state intentions.
- Notify the cabin crew of the nature of emergency encountered and state intentions. Specify the available time.
- GPWS is selected OFF to avoid nuisance warnings.
- Burn fuel off down to the minimum possible impact weight. This reduces VAPP and as a consequence the load factor for impact and the energy which must be dissipated.



ATR 72
F.C.O.M.

PROCEDURES FOLLOWING FAILURE

LANDING GEAR

2.05.07

P 6

001

NOV 93

AA

L/G RETRACTION IMPOSSIBLE

PROCEDURE

L/G RETRACTION IMPOSSIBLE	
L/G LEVER	DOWN
MAX SPEED	185 kt
CCAS	RCL
IDLE GATE	MONITOR

 AR72 F.C.O.M.	PROCEDURES FOLLOWING FAILURE LANDING GEAR	2.05.07		
		P 7	001	
				JUN 97

ANTI SKID FAULT

ALERT

CONDITION	VISUAL	AURAL
Anti skid channel loss (power loss or loss of transducer or valve continuity)	<ul style="list-style-type: none"> - MC light flashing amber - WHEEL amber light on CAP - associated F amber light on central panel 	SC

PROCEDURE

ANTI SKID FAULT	
LANDING DISTANCE	MULTIPLY BY 1.4
<ul style="list-style-type: none"> ● At touch down USE FULL REVERSE IF NECESSARY USE NORM BRK WITH CARE OF BRK HANDLE 	
	EMER

COMMENTS

- Landing distance is increased due to reduced braking efficiency.

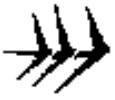
 AFR 72 F.C.O.M.	PROCEDURES FOLLOWING FAILURE LANDING GEAR	2.05.07		
		P 8	001	
				JUL 99

AA

BRK TEMP HOT

ALERT

CONDITION	VISUAL	AURAL
Brake temperature over 150° C	<ul style="list-style-type: none"> - MC light flashing amber - WHEEL amber light on CAP - HOT amber light on central panel 	SC

PROCEDURE

R

BRK TEMP HOT
DELAY TO <ul style="list-style-type: none"> ● After take off LEAVE L/G DOWN FOR 1 mn FOR COOLING EXCEPT IN CASE OF EMERGENCY

	PROCEDURES FOLLOWING FAILURE AIR	2.05.08		
		P 1	001	
				JUN 97

AA

BLEED VALVE FAULT

ALERT

CONDITION	VISUAL	AURAL
Bleed valve position in disagree with command	<ul style="list-style-type: none"> - MC light flashing amber - AIR amber light on CAP - associated BLEED and PACK FAULT lights on overhead panel 	SC

PROCEDURE

BLEED VALVE FAULT		
PACK VALVE affected		OFF
BLEED VALVE affected		OFF
MAX FL		200
AVOID LARGE QUICK POWER CHANGES AT HIGH ALTITUDE		

COMMENTS

- Following the detection of a FAULT, the affected BLEED VALVE will close automatically and the associated PACK VALVE will close due to lack of air supply. The associated actions confirm automatic operation and extinguish related alerts, allowing flight to be continued with one pack supplied.
- Pack should be confirmed closed first due to PACK FAULT inhibition (as soon as BLEED is selected OFF, PACK FAULT light extinguishes).

- R - A failure of Handling Bleed Valve combined with Bleed OFF operation may lead to engine stall. Engine stall may be prevented through slow power levers movements, especially when advancing the power levers.
- R
- R
- R - An engine stall is indicated by one or a series of mild surges. These will normally stop without crew action, however a slight power reduction, if appropriate, will restore normal operation.
- R
- R

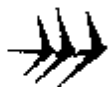

ATR 72
F.C.O.M.

PROCEDURES FOLLOWING FAILURE

AIR

2.05.08

P 2

001

JUN 97

AA

BLEED OVHT

ALERT

CONDITION	VISUAL	AURAL
Overheat in bleed duct (T duct > 274° C/525° F).	- MC light flashing amber - AIR amber light on CAP - associated OVHT, BLEED and PACK FAULT amber lights on overhead panel	SC

PROCEDURE

BLEED OVHT	
PACK VALVE affected	OFF
BLEED VALVE affected	OFF
MAX FL	200
AVOID LARGE QUICK POWER CHANGES AT HIGH ALTITUDE	

COMMENTS

- Following the detection of an overheat, the affected BLEED VALVE will close automatically and the associated PACK VALVE will close due to lack of air supply. The associated actions confirm automatic operation and extinguish related alerts, allowing flight to be continued with one pack supplied.
- Pack should be confirmed closed first due to PACK FAULT inhibition (as soon as BLEED is selected OFF, PACK FAULT light extinguishes).
- System may be restored in flight after OVHT alert has extinguished.

	PROCEDURES FOLLOWING FAILURE AIR	2.05.08		
		P 3	050	
				JUL 00

AA

BLEED LEAK

ALERT

CONDITION	VISUAL	AURAL
Bleed air leak (Loop > 153° C/307° F).	- MC light flashing amber - AIR amber light on CAP - associated LEAK, BLEED and PACK FAULT amber lights on overhead panel	SC

PROCEDURE

BLEED LEAK	
PACK VALVE affected	OFF
BLEED VALVE affected	OFF
MAX FL	200
AVOID LARGE QUICK POWER CHANGES AT HIGH ALTITUDE	
CAUTION : System must not be restored in flight.	

COMMENTS

- Following the detection of a leak, the affected BLEED VALVE will close automatically and the associated PACK VALVE will close due to lack of air supply. The associated actions confirm automatic operation and extinguish related alerts allowing flight to be continued with one pack supplied.
- Pack should be confirmed closed first due to PACK FAULT inhibition (as soon as BLEED is selected OFF, PACK FAULT light extinguishes).
- System must not be restored in flight because it may create hazards.



ATR72
F.C.O.M.

PROCEDURES FOLLOWING FAILURE

2.05.08

P 4

001

AIR

JUN 97

X VALVE OPEN

ALERT

CONDITION	VISUAL	AURAL
- X VALVE opened when it should be closed.	- MC light flashing amber - AIR amber light on CAP - X VALVE OPEN amber light on overhead panel	SC

PROCEDURE

X VALVE OPEN

CAUTION : Do not supply both packs from one single bleed.

COMMENTS

- If both bleeds are available, no special procedure has to be applied.
In case of bleed failure, associated pack must be selected OFF.

 AFR 72 F.C.O.M.	PROCEDURES FOLLOWING FAILURE AIR	2.05.08		
		P 5	001	
				JUN 96

BLEED NOT ON AFTER T/O

ALERT

CONDITION	VISUAL	AURAL
Bleed valves not selected ON 30 s after PWR MGT selected other than TO	<ul style="list-style-type: none"> - AIR amber light on CAP - associated BLEED OFF light on overhead panel 	SC

PROCEDURE

BLEED NOT ON AFTER T/O	
BLEED VALVES	ON

COMMENTS

- The alert is provided as a reminder for the crew if it does not properly apply the normal procedure after take off :
 - climb power selection
 - both bleed valves ON

	PROCEDURES FOLLOWING FAILURE AIR	2.05.08		
		P 6	001	
				JUN 97

AA

PACK VALVE FAULT

ALERT

CONDITION	VISUAL	AURAL
Pack valve position is disagree with command or overheat downstream of the compressor (T > 204° C/393° F)	- MC light flashing amber - AIR amber light on CAP - associated PACK FAULT amber light on overhead panel	SC

PROCEDURE

PACK VALVE FAULT	
PACK VALVE affected	OFF
MAX FL	200
AVOID LARGE QUICK POWER CHANGES AT HIGH ALTITUDE	

BOTH PACKS INOP

PROCEDURE

BOTH PACKS INOP	
MAX FL	100/MEA
● When $\Delta P < 1$ PSI	
OVBD VALVE	FULL OPEN
MAN RATE KNOB	9 O'CLOCK
CAB PRESS MODE SEL	MAN
MAN RATE KNOB	MAX INCREASE

COMMENTS

- No air is entering in the cabin. Leaks will increase cabin altitude.
- If both packs are inoperative, descend to FL 100 or MEA whichever is higher.

	PROCEDURES FOLLOWING FAILURE AIR	2.05.08		
		P 7	001	
				JUN 97

AA

DUCT OVHT

ALERT

CONDITION	VISUAL	AURAL
Overheat in the duct	- MC light flashing amber - AIR amber light on CAP - associated TEMP SEL OVHT amber light on overhead panel	SC

PROCEDURE

DUCT OVHT	
TEMP SEL affected	MAN
COMPT TEMP SELECTOR associated	COLD
CAUTION : MONITOR DUCT TEMP and MAKE SURE IT REMAINS POSITIVE TO AVOID POSSIBLE PACK TURBINE DAMAGE DUE TO FREEZING.	
■ If duct temperature remains above 88° C/ 190° F :	
PACK VALVE affected	OFF
MAX FL	200
AVOID LARGE QUICK POWER CHANGES AT HIGH ALTITUDE.	

COMMENTS

- The OVHT alert light will remain as long as an overtemperature is detected in the duct. It is not inhibited when in MAN mode.
- When alert disappears, control COMPT TEMP manually as required.
- If alert does not disappear, the temperature control valve is jammed opened. Pack valve has to be closed.

	PROCEDURES FOLLOWING FAILURE AIR	2.05.08		
		P 8	001	
				DEC 94

RECIRC FAN FAULT

R ALERT

CONDITION	VISUAL	AURAL
Recirculation fan low RPM (< 900 RPM) more than 20s after start or electrical motor overheat	<ul style="list-style-type: none"> - MC light flashing amber - AIR amber light on CAP - associated RECIRC FAN FAULT amber light on overhead panel 	SC

R PROCEDURE

RECIRC FAN FAULT	
RECIRC FAN affected	OFF

	PROCEDURES FOLLOWING FAILURE AIR	2.05.08		
		P 9	001	
				JUN 97

AA

EXCESS CAB ALT**ALERT**

CONDITION	VISUAL	AURAL
Cabin altitude above 10 000 ft	- MC light flashing red - EXCESS ALT red light on CAP	CRC

PROCEDURE

EXCESS CAB ALT	
CABIN PRESS IND	CHECK
■ If Z cabin > 10 000 ft confirmed	
MAN RATE KNOB	9 O'CLOCK
CAB PRESS MODE SEL	MAN
MAN RATE KNOB	DECREASE
■ If no success	
OXY MASK	ON
CREW COMMUNICATIONS	ESTABLISH
OXY PAX SPLY	AS REQUIRED
OXY PRESSURE	CHECK
DESCENT	AS RQD
■ If rapid decompression	
EMERGENCY DESCENT PROCEDURE	APPLY

COMMENTS

- Check first for pressurization system fault. If system fault, apply appropriate procedure (manual regulation).
- If no abnormal indications, start descent.
- If decompression is rapid, apply **DESCENT IN CASE OF EMER** procedure.

	PROCEDURES FOLLOWING FAILURE AIR	2.05.08		
		P 10	001	
				NOV 93

AUTO PRESS FAULT

ALERT

CONDITION	VISUAL	AURAL
Digital controller failure	<ul style="list-style-type: none"> · MC light flashing amber · AIR amber light on CAP · FAULT amber light in · MAN pb 	SC

PROCEDURE

AUTO PRESS FAULT				
MAN RATE KNOB				9 O'CLOCK
CAB PRESS MODE SEL				MAN
MAN RATE KNOB				AS REQ TO SET CABIN RATE
FL	140	170	200	250
TARGET CAB ALT (ft)	0	2000	4000	6750

COMMENTS

- The table FL Vs CAB ALT gives the relationship required to obtain $\Delta P = 6$ PSI

	PROCEDURES FOLLOWING FAILURE AIR	2.05.08		
		P 11	001	
				NOV 93

AA

AVIONICS VENT EXHAUST MODE FAULT

ALERT

CONDITION	VISUAL	AURAL
Underspeed or overheat of extract fan (T > 90° C / 194° F)	<ul style="list-style-type: none"> - MC light flashing amber - AIR amber light on CAP - EXHAUST MODE FAULT amber light on overhead panel 	SC

PROCEDURE

AVIONICS VENT EXHAUST MODE FAULT	
EXHAUST MODE	OVBD

COMMENTS

- EXHAUST MODE to OVBD position controls the OVBD valve to partially open and stops the extract fan : ventilation air is then discharged overboard instead of being directed to the underfloor valve. Ventilation is ensured by ΔP between cabin and outside air.

 ATR 72 F.C.O.M.	PROCEDURES FOLLOWING FAILURE AIR	2.05.08		
		P 12	001	
				NOV 93

AA

OVBD VALVE FAULT

ALERT

CONDITION	VISUAL	AURAL
OVBD VALVE position not corresponding with aircraft condition	<ul style="list-style-type: none"> - MC light flashing amber - AIR amber light on CAP FAULT amber light on overhead panel 	SC

PROCEDURE

OVBD VALVE FAULT	
R	<ul style="list-style-type: none"> ● In flight or on ground, engine 1 running OVBD VALVE FULL CLOSE
R	<ul style="list-style-type: none"> ● On ground, engine 1 not running OVBD VALVE FULL OPEN
CAUTION : DO NOT SELECT OVBD VALVE FULL OPEN IF $\Delta P > 1$ PSI	

COMMENTS

- The OVBD VALVE should automatically close 2 minutes after engine 1 start (oil low press signal). If it remains open after FULL CLOSE selection maintenance action is required.
- FULL CLOSE/FULL OPEN selection overrides OVBD selection.



ATR 72
F.C.O.M.

PROCEDURES FOLLOWING FAILURE

AIR

2.05.08

P 13

001

JUN 97

AA

EXCESS CAB ΔP

ALERT

CONDITION	VISUAL	AURAL
Differential pressure exceeds 6.35 PSI	<ul style="list-style-type: none"> - MW flashing red - EXCESS CAB ΔP red light on CAP - DIFF PRESS local ind. exceed in 6.35 PSI 	CRC

PROCEDURE

EXCESS CAB ΔP	
MAN RATE KNOB	9 o'clock
CAB PRESS MODE SEL	MAN
MAN RATE KNOB	INC
<p>■ If unsuccessful</p>	
DESCENT TO A COMPATIBLE FL	INITIATE

 ATR 72 F.C.O.M.	PROCEDURES FOLLOWING FAILURE ANTI ICE	2.05.09		
		P 1	250	
				JUN 97

AIRFRAME AIR BLEED FAULT

ALERT

CONDITION	VISUAL	AURAL
Low pressure in the de-icing common air manifold (P < 14 PSI and t > 6s) - or Over temperature (T > 230°C) upstream the pressure regulating valve	- MC light flashing amber ANTI ICING amber light on CAP - AIRFRAME AIR BLEED FAULT amber light on overhead panel	SC

PROCEDURE

AIRFRAME AIR BLEED FAULT

LEAVE AND AVOID ICING CONDITIONS

AIRFRAME AIRBLEED OFF

■ **If ENG DE-ICING FAULT light illuminates after 10 s**

ENG DE-ICING affected OFF

AIRFRAME AIRBLEED ON

AIRFRAME FAULT CHECK EXTINGUISHED

■ **If not**

MINIMUM ICING SPEEDS INCREASE BY 10 kt

LANDING DISTANCE (icing conditions, FLAPS 30) MULTIPLY BY 1.13

	PROCEDURES FOLLOWING FAILURE ANTI ICE	2.05.09		
		P 2	130	
				JUN 95

AIRFRAME DE ICING FAULT

ALERT

CONDITION	VISUAL	AURAL
- Distribution valve output controlled open but no downstream pressure detected, or - Distribution valve output controlled closed but downstream pressure detected.	- MC light flashing amber - ANTI ICING amber light on CAP - associated FAULT amber light on overhead panel	SC

PROCEDURE

AIRFRAME DE ICING FAULT	
AIRFRAME DE ICING	OFF
LEAVE AND AVOID ICING CONDITIONS	
MINIMUM ICING SPEEDS	INCREASE BY 10 kt
■ If ice accretion	
MAXIMUM APPROACH SLOPE	3°
IN ICING CONDITIONS, LANDING DISTANCE FLAPS 30 MULTIPLY BY 1.13	

AC

R
R
R
R
R
R
R
R
R
R
R

	PROCEDURES FOLLOWING FAILURE ANTI ICE	2.05.09		
		P 3	001	
				JUN 96

ENG DE ICING FAULT

ALERT

CONDITION	VISUAL	AURAL
Distribution valve output controlled open but no downstream pressure detected, or Distribution valve output < controlled closed but downstream pressure detected.	- MC light flashing amber - ANTI ICING amber light on CAP - associated FAULT amber light on overhead panel	SC

PROCEDURE

ENG DE ICING FAULT	
LEAVE AND AVOID ICING CONDITIONS	
Associated ENGINE PARAMETERS	MONITOR

COMMENTS

- Very large ice accretion on the engine air intake may generate an engine flame out when the ice breaks free.

Several cases of MFC failure may generate an engine deicing FAULT alert prior deicing mode sel FAULT.

Engine deicing may be recovered when selecting deicing mode sel OVRD.



AJR 72
F.C.O.M.

PROCEDURES FOLLOWING FAILURE

ANTI ICE

2.05.09

P 4

070

JUN 97

PROP ANTI ICING FAULT

ALERT

CONDITION	VISUAL	AURAL
One or more blade heating units inoperative	<ul style="list-style-type: none"> - MC light flashing amber - ANTI ICING amber light on CAP - associated FAULT amber light on overhead panel 	SC

PROCEDURE

PROP ANTI ICING FAULT	
PROP ANTI ICING affected	OFF
LEAVE AND AVOID ICING CONDITIONS	
<p>■ If propeller unbalance due to ice becomes excessive</p>	
CL both	MOVE TO 100 OVRD FOR 5 mn

COMMENTS

- If propeller unbalance due to ice becomes significant periodically moving both CL TO 100 OVRD will modify centrifugal forces allowing ice elimination.

	PROCEDURES FOLLOWING FAILURE ANTI ICE	2.05.09		
		P 5	001	
				JUN 97

AA

HORNS ANTI ICING FAULT

ALERT

CONDITION	VISUAL	AURAL
Power loss on a horn anti icing unit	<ul style="list-style-type: none"> - MC light flashing amber - ANTI ICING amber light on CAP - associated FAULT amber light on overhead panel 	SC

PROCEDURE

HORNS ANTI ICING FAULT
<p>LEAVE AND AVOID ICING CONDITIONS</p> <p>■ In icing conditions, every 5 mn FLIGHT CONTROLS associated CHECK FREEDOM OF MOVEMENT</p>

COMMENTS

- One unit controls rudder and left elevator horns when the other one controls ailerons and right elevators horns.
- Checking, every 5 mn, freedom of movement of the associated flight controls will prevent ice accretion between flight controls and related fixed parts of the aircraft structure which could generate flight control jamming.



ATR 72
F.C.O.M.

PROCEDURES FOLLOWING FAILURE

2.05.09

P 6

001

ANTI ICE

JUN 97

AA

WINDOW HTG FAULT

ALERT

CONDITION	VISUAL	AURAL
Loss of window heating	<ul style="list-style-type: none"> - MC light flashing amber - ANTI ICING amber light on CAP - associated FAULT amber light on overhead panel 	SC

PROCEDURE

WINDOW HTG FAULT	
WINDOW HTG affected	OFF

	PROCEDURES FOLLOWING FAILURE ANTI ICE	2.05.09		
		P 7	001	
				JUN 95

AA

PROBE HTG FAULT
ALERT

CONDITION	VISUAL	AURAL
PROBE(S) not heated	<ul style="list-style-type: none"> - MC light flashing amber - ANTI ICING amber light on CAP - associated probe amber light on overhead panel 	SC

PROCEDURE

ALPHA PROBE HTG FAULT	
<ul style="list-style-type: none"> ■ One ALPHA PROBE illuminated 	STICK PUSHER/SHAKER MONITOR
<ul style="list-style-type: none"> ■ Two ALPHA PROBES illuminated 	STICK PUSHER/SHAKER OFF V _{min} HB/V _{min} LB for all configurations INCREASE BY 10 kt LANDING DISTANCE MULTIPLY BY 1.13

COMMENTS

- The minimum maneuvering speeds are increased by 10 kt in order to increase stall margin.
- If alpha probes are not heated, ice accretion may modify alpha probes indication. If angle of attack information offset exceeds 4°, "STICK PUSHER/SHAKER FAULT " light illuminates. When leaving icing conditions, as soon as alpha probes are cleared of ice, STICK PUSHER/SHAKER may be recovered by selecting it ON.

R

R

PROBE HTG FAULT (Except ALPHA PROBES)	
Unaffected ADC	SELECTED
Associated indication	MONITOR

COMMENTS

- Erroneous indications may be displayed on associated equipment (CAPT, F/O or STBY airspeed ind., TAT/SAT) due to loss of probe heating.

	PROCEDURES FOLLOWING FAILURE ANTI ICE	2.05.09		
		P 8	001	
				JUN 96

AA

DE ICING MODE SEL FAULT

ALERT

CONDITION	VISUAL	AURAL
Boots do not operate following MFC failure or both boots A and B of the same engine are supplied 200 sec after eng cycle beginning or boots A (B) of both engines are supplied while boots B (A) are not supplied 20 sec after eng. cycle beginning.	- MC flashing amber - ANTI ICING amber light flashing amber on CAP - DE ICING MODE SEL FAULT light on overhead panel	SC

PROCEDURE

DE ICING MODE SEL FAULT	
DE ICING MODE SEL	OVRD
MONITOR DE ICING :	
■ In case of engine flame out	
OVRD	RELEASE

COMMENTS

- The OVRD mode allows to operate the engines and airframe dual distribution valves in case of engine boots primary control failure.
- B - DE ICING MODE SEL OVRD must be used if there is evidence of boots cycling malfunctioning even if DE ICING MODE SEL FAULT is not illuminated
- When DE ICING MODE SEL is selected to OVRD position, ENG and AIRFRAME FAULT lights are inhibited and boots cycling operates only according to FAST mode.
- In case of ENG DE (or ANTI) ICING FAULT and after a prolonged flight with considerable accretion, it is possible that when setting the DE ICING MODE SEL to OVRD position, the engine may ingest the built up ice and that a flame out could occur.
As the functioning of this device is sequential (i.e. the two engines are not concerned at the same time) it is suggested to release the DE ICING MODE SEL pb before the same phenomenon occurs on the second engine.

	PROCEDURES FOLLOWING FAILURE ANTI ICE	2.05.09		
		P 9	500	
				JUL 01

AA

MODE SEL AUTO FAULT

ALERT

CONDITION	VISUAL	AURAL
- MFC 1B or 2B and/or ADC failure - Discrepancy between outputs	- MC light flashing amber - ANTI ICING amber light on CAP - FAULT amber light on overhead panel	SC

PROCEDURE

MODE SEL AUTO FAULT
MODE SEL MAN DE ICING and ANTI ICING manual mode pbs : According to current SAT SELECT

R
R

COMMENTS

R

- In case of FAULT or discrepancy between ADC's information and until further pilot's action :
 - . High speed boots activation is selected (airframe + engines)
 - . High power cycle (20/60) is selected (propellers).
- OVRD guarded Pb has to be used in case of cycle anomaly, indicated by its own FAULT light.

	PROCEDURES FOLLOWING FAILURE ANTI ICE	2.05.09		
		P 10	001	
				JUN 97

AA

ICE DETECTOR FAILURE

ALERT

CONDITION	VISUAL	AURAL
Ice detector failure	<ul style="list-style-type: none"> - MC flashing amber - ANTI ICING amber light on CAP - ice detector FAULT light on control panel 	SC

PROCEDURE

ICE DETECTOR FAULT
MONITOR VISUALLY ICE ACCRETION

	PROCEDURES FOLLOWING FAILURES MFC	2.05.10		
		P 1	001	
				JUN 96

AA

MFC 1A FAULT

ALERT

CONDITION	VISUAL	AURAL
MFC 1A FAULT	<ul style="list-style-type: none"> - MC light flashing amber - MFC amber light on CAP - Associated MFC FAULT on overhead panel 	SC

PROCEDURE

MFC 1A FAULT	
AFFECTED MODULE	OFF/RESET
MODULE EQT LIST	CHECK

COMMENTS

As HP valve 1 is lost, air is bled only from the LP stage. Applicable pack performance is affected at low engine power.

-- Landing gear primary RED UNLK indications are lost.

	PROCEDURES FOLLOWING FAILURES MFC	2.05.10		
		P 2	001	
				JUN 96

MFC 1B FAULT

ALERT

CONDITION	VISUAL	AURAL
MFC 1B FAULT	- MC light flashing amber - MFC amber light on CAP - Associated MFC FAULT on overhead panel	SC

PROCEDURE

MFC 1B FAULT	
Affected MODULE	OFF/RESET
MODULE EQT LIST	CHECK
■ Failure during TAXI OUT	
PACK 1	OFF
OVBD VALVE	FULL OPEN
● Prior take off	
PACK 2	OFF
● After take off	
PACKS	ON
OVBD VALVE	FULL CLOSE
LEAVE L/G DOWN FOR COOLING FOR 1 min AFTER TAKE OFF EXCEPT IN CASE OF EMERGENCY.	
● After landing	
PACK 1	OFF
OVBD VALVE	FULL OPEN
■ Failure in flight or after landing	
● After landing	
PACK 1	OFF
OVBD VALVE	FULL OPEN
CAUTION : Before opening any door, packs 1 and 2 must be selected OFF and cockpit communication hatch must be opened.	



ATR 72
F.C.O.M.

PROCEDURES FOLLOWING FAILURES

MFC

2.05.10

P 3

001

NOV 93

COMMENTS

- As wow signal is lost, OVBD valve must be selected FULL OPEN manually on ground to improve racks cooling.
- Hot brakes indication is lost : L/G must remain down during 1/mn after take-off for cooling.
- Ground turbofan 1 is lost. Pack 1 must be switched off on ground to avoid any overheat problem.
- ENG 1 OIL LO PRESS light remains ON when engine 1 is shut down.
After landing, as outflow valves do not fully open, selecting OVBD valve full open relieves the ΔP between cabin and outside.
- On ground, pressurization digital controller test capability is lost.

	PROCEDURES FOLLOWING FAILURES MFC	2.05.10		
		P 4	001	
				JUN 96

AA

MFC 2A FAULT

ALERT

CONDITION	VISUAL	AURAL
MFC 2A FAULT	MC light flashing amber - MFC amber light on CAP - Associated MFC FAULT on overhead panel	SC

PROCEDURE

MFC 2A FAULT	
Affected MODULE	OFF/RESET
AVIONICS VENT EXHAUST MODE	OVBD
MODULE EQT LIST	CHECK
■ Failure during TAXI OUT	
OVBD VALVE	FULL OPEN
● After take off	
IDLE GATE	CHECK
OVBD VALVE	AUTO
● At touch down	
IDLE GATE	MONITOR
● After landing	
OVBD VALVE	FULL OPEN
■ Failure in flight or after landing	
● At touch down	
IDLE GATE	MONITOR
● After landing	
OVBD VALVE	FULL OPEN

	PROCEDURES FOLLOWING FAILURES MFC	2.05.10		
		P 5	001	
				DEC 94

COMMENTS

- Extract fan is lost.
- EXHAUST MODE to OVBD position controls the OVBD valve to partially open : ventilation air is then discharged overboard instead of being directed to the underfloor valve. Ventilation is ensured by ΔP between Cabin and outside.
- As wow signal is lost, OVBD VALVE must be selected FULL OPEN manually on the ground to improve racks cooling.
- « IDLE GATE FAIL » amber alert is lost
- As HP valve 2 is lost, air is bled only from the LP stage. Pack 2 performance is affected at low engine power.
- R/H side window anti-icing is lost
- As extract fan is lost, avoid leaving avionics selected ON on the ground for a long period of time with high OAT.
- Landing gear secondary green arrows and RED UNLK indications are lost.

	PROCEDURES FOLLOWING FAILURES MFC	2.05.10		
		P 6	001	
				DEC 94

MFC 2B FAULT

ALERT

CONDITION	VISUAL	AURAL
MFC 2B FAULT	- MC light flashing amber - MFC amber light on CAP - Associated MFC FAULT on overhead panel	SC

PROCEDURE

MFC 2B FAULT	
Affected MODULE	OFF/RESET
MODULE EQT LIST	CHECK
■ Failure during taxi out	
PACK 2	OFF
OVBD VALVE	FULL OPEN
● Prior take off	
PACK 1	OFF
● After take off	
PACKS	ON
OVBD VALVE	FULL CLOSE
LEAVE L/G DOWN FOR COOLING FOR 1 min AFTER TAKE OFF EXCEPT IN CASE OF EMERGENCY	
● After landing	
PACK 2	OFF
OVBD VALVE	FULL OPEN
■ Failure in flight or after landing	
● After landing	
PACK 2	OFF
OVBD VALVE	FULL OPEN
CAUTION : Before opening any door, packs 1 and 2 must be selected OFF and cockpit communication hatch must be opened.	

 ATR 72 F.C.O.M.	PROCEDURES FOLLOWING FAILURES MFC	2.05.10		
		P 7	001	
				NOV 93

COMMENTS

- As wow signal is lost :
OVBD VALVE must be selected FULL OPEN manually on the ground to improve racks cooling.
- Ground turbofan 2 is lost. Pack 2 must be switched OFF on the ground to avoid any overheat problem.
- Hot brakes indication is lost : L/G must remain down during 1 mn after take off if performance permits.
- ENG 2 OIL LO PRESS light remains ON when engine 2 is shut down.
- Landing gear secondary green arrows and RED UNLK indications are lost.
- After landing, selecting the overboard valve fully open relieves the ΔP between cabin and outside.
- RH side window de-icing is lost without FAULT indication.

	PROCEDURES FOLLOWING FAILURE MFC	2.05.10		
		P 8	070	
				JUN 97

AA

MFC 1A + 1B FAULT

ALERT

CONDITION	VISUAL	AURAL
MFC 1A + 1B FAULT	- MC light flashing amber - MFC amber light on CAP - Associated MFC FAULT on overhead panel	SC

PROCEDURE

MFC 1A + 1B FAULT	
Affected MODULES	OFF/RESET
PROP 1 ANTI-ICING	OFF
PROP ANTI-ICING FAULT PROCEDURE	APPLY
DE-ICING MODE SEL	OVRD (as required)
PACK 1	OFF
BLEED 1	OFF
BLEED VALVE FAULT PROCEDURE	APPLY
RADAR	OFF
GPWS	OFF
MODULE EQPT LIST	CHECK
<ul style="list-style-type: none"> ● Before landing <ul style="list-style-type: none"> ATPCS ● After landing <ul style="list-style-type: none"> OVBD VALVE 	
<ul style="list-style-type: none"> ● OVBD VALVE FULL OPEN 	
CAUTION : Before opening any door, Packs 1 and 2 must be selected OFF and cockpit communication hatch must be opened.	



AJR 72
F.C.O.M.

PROCEDURES FOLLOWING FAILURES

2.05.10

P 9

150

MFC

JUN 97

COMMENTS

- As Prop 1 anti-icing is lost, icing conditions must be avoided

If propeller unbalance due to ice becomes excessive, periodically moving both CL 100 OVRD will modify centrifugal forces allowing ice elimination.

- Pack 1 is lost without FAULT indication
- Bleed 1 is lost without FAULT indication
- Ground turbo fan 1 is lost

L/H side window anti-icing is lost without FAULT indication

- AC BUS 1 is lost leading to :

- loss of trim indicator
- loss of GPWS
- loss of weather radar

- Stick pusher is lost without FAULT indication

- ATPCS must be selected OFF before landing due to loss of A/FEATH on engine 1. Check go around performances ATPCS off.

As one wow signal is lost :

OVBD valve must be selected FULL OPEN manually on the ground to improve racks cooling.

- ENG 1 OIL LO PRESS light remains ON when engine 1 is shut down.
- Landing gear primary green arrows and RED UNLK indications are lost.
- After landing, as both outflow valves do not fully open, selecting the OVBD valve FULL OPEN relieves the ΔP between cabin and outside.

	PROCEDURES FOLLOWING FAILURES MFC	2.05.10		
		P 10	001	
				JUN 96

MFC 1A + 2A FAULT

ALERT

CONDITION	VISUAL	AURAL
MFC 1A + 2A FAULT	<ul style="list-style-type: none"> - MC light flashing amber - MFC amber light on CAP - Associated MFC FAULT on overhead panel 	SC

PROCEDURE

MFC 1A + 2A FAULT	
Affected MODULES	OFF/RESET
TLU	MAN MODE
AVIONIC VENT EXHAUST MODE	OVBO
GPWS	OFF
RADAR	OFF
MODULE EQT LIST	CHECK
AIRFRAME FAULT AMBER ALERT IS LOST	
WHEN AIRFRAME DE-ICING USED, MONITOR BOOTS INFLATION.	
<i>As AP OFF alert is lost, use of AP below 1000 ft AGL is prohibited.</i>	
● Before landing	
L/G LEVER	DOWN
EMER EXTENSION HANDLE	PULL
● At touch down	
IDLE GATE	MONITOR
● After landing	
OVBD VALVE	FULL OPEN
<i>Note : VOR 2 / ADF 2 / COURSE 2 INFORMATIONS ARE LOST.</i>	
<i>ADC2 outputs (Alt, ASI, VSI) are not available.</i>	

	PROCEDURES FOLLOWING FAILURES MFC	2.05.10		
		P 11	001	
				DEC 96

AA

COMMENTS

- Exhaust mode to OVBD position controls the OVBD valve to partially open : ventilation air is then discharge overboard instead of being directed to the underfloor valve. Ventilation is ensured by ΔP between cabin and outside air.
- AC BUS 1 + 2 are lost leading to :
 - loss of VOR 2/ADF 2/COURSE 2 INFORMATION
 - loss of GPWS
 - loss of weather radar
 - loss of trim indicator

- Automatic Idle Gate system is not operative. Pulling the lever removes the stop and allows to reduce below FI (GI and reverse)

R/H side window anti-icing is lost.

- DC BUS 1 + 2 OFF warnings on overhead panel are lost.
- As HP valve 1 + 2 are lost, air is bled only from LP stages. Pack performance is affected at low engine power.

As wow signal is lost, OVBD VALVE must be selected FULL OPEN manually on ground to improve racks cooling.

As extract fan is lost, avoid leaving avionics ON on the ground for a long period of time with high OAT.

Mechanical, crew and hostess call are lost.

- Landing gear controls, all RED UNLK indications and secondary green arrows are lost.

R Stick pusher FAULT indication is lost but stick pusher is still available.

	PROCEDURES FOLLOWING FAILURES MFC	2.05.10		
		P 12	001	
				DEC 94

AA

MFC 1A + 2B FAULT

ALERT

CONDITION	VISUAL	AURAL
MFC 1A + 2B FAULT	<ul style="list-style-type: none"> - MC light flashing amber - MFC amber light on CAP - Associated MFC FAULT on overhead panel 	SC

PROCEDURE

MFC 1A + 2B FAULT	
Affected MODULES	OFF/RESET
MAIN BLUE HYD PUMP	OFF
X FEED	ON
DE-ICING MODE SEL	OVRD (as RQD)
MODULE EQT LIST	CHECK
● Before landing	
FLAPS CONTROL IS LOST	
REDUCED FLAP LDG PROCEDURE	APPLY
L/G LEVER	DOWN
EMER EXTENSION HANDLE	PULL
● After landing	
PACK 2	OFF
OVBD VALVE	FULL OPEN
CAUTION : Before opening any door, Packs 1 and 2 must be selected OFF and cockpit communication hatch must be opened.	
<i>Note</i> : AP DOES NOT DISCONNECT AFTER STBY PITCH TRIM ACTIVATION.	

 AR72 F.C.O.M.	PROCEDURES FOLLOWING FAILURES MFC	2.05.10		
		P 13	001	
				NOV 93

AA

COMMENTS

- As HP valve 1 is lost, air is bled only from the LP stage. Concerned pack performances is affected at low engine power.
- As wow is lost :
OVBD VALVE must be selected FULL OPEN to improve racks cooling.
- Ground turbo fan 2 is lost. Pack 2 must be switched OFF on the ground to avoid any overheat problem
- ENG 2 OIL LO PRESS light remains ON as soon as engine 2 is shut down.
Landing gear controls, all RED UNLK indications and secondary green arrows are lost.
- RH side window anti icing is lost without FAULT indication.
- After landing, as both outflow valves do not fully open, selecting OVBD valve full open relieves ΔP between cabin and outside.
- Selecting de-icing mode to OVRD position allows to recover all pneumatic de-icers operations
- Main blue hyd-pump control is lost as well as Flaps control.
Selecting HYD. X FEED open allows to recover blue hyd pressure but flaps control remain lost.

	PROCEDURES FOLLOWING FAILURES MFC	2.05.10		
		P 14	001	
				JUN 96

MFC 1B + 2A FAULT

ALERT

CONDITION	VISUAL	AURAL
MFC 1B + 2A FAULT	MC light flashing amber - MFC amber light on CAP - Associated MFC FAULT on overhead panel	SC

PROCEDURE

MFC 1B + 2A FAULT	
Affected MODULES	OFF/RESET
DE-ICING MODE SEL	OVRD (as required)
AVIONICS VENT EXHAUST MODE	OVBD
MODULE EQT LIST	CHECK
● Before landing	
FLAPS CONTROL IS LOST	
REDUCE FLAP LDG PROCEDURE	APPLY
L/G LEVER	DOWN
EMER EXTENSION HANDLE	PULL
CAUTION : GEAR CANNOT BE RETRACTED	
● At touch down	
IDLE GATE	MONITOR
● After landing	
PACK 1	OFF
OVBD VALVE	FULL OPEN
CAUTION : Before opening any door, Packs 1 and 2 must be selected OFF and cockpit communication hatch must be opened.	
<i>Note</i> : VOR 2 / ADF 2 / COURSE 2 INFORMATION IS LOST. F/O anemo indications are not available.	

	PROCEDURES FOLLOWING FAILURES MFC	2.05.10		
		P 15	001	
				DEC 94

AA

COMMENTS

- EXHAUST MODE to OVBD position controls the OVBD valve to partially open. Ventilation air is then discharged overboard instead of being directed to the underfloor valve.
Ventilation is ensured by ΔP between cabin and outside air.
- DC BUS 2 OFF warning on overhead panel is lost.
- R/H side window anti-icing is lost.
- AC BUS 2 is lost leading to loss of VOR 2/ADF 2/COURSE 2 information.
- As HP valve 2 is lost, air is bled only from the LP stage. Pack 2 performance is affected at low engine power.
- « IDLE GATE FAIL » amber alert is lost.
- Ground turbofan 1 is lost. Pack 1 must be switched OFF on ground to avoid any overheat problem.
- As wow signal is lost, OVBD VALVE must be selected FULL OPEN manually : on the ground to improve racks cooling and to relieve the ΔP between cabin and outside.
- As extract fan is lost, avoid leaving avionics selected ON on the ground for a long period of time with high OAT.
- Hostess and crew indications calls are lost.
- Hot brakes indicating system test is lost.
- ENG 1 OIL LO PRESS light remains ON when engine 1 is shut down.
- Landing gear controls, secondary RED UNLK indications and green arrows are lost.
- Selecting de-icing mode to OVRD position allows to recover all pneumatic de-icers operation.



ATR 72
F.C.O.M.

PROCEDURES FOLLOWING FAILURES

MFC

2.05.10

P 16

070

JUN 97

MFC 2A + 2B FAULT

ALERT

CONDITION	VISUAL	AURAL
MFC 2A + 2B FAULT	<ul style="list-style-type: none"> - MC light flashing amber - MFC amber light on CAP - Associated MFC FAULT on overhead panel 	SC

PROCEDURE

MFC 2A + 2B FAULT

Affected MODULES	OFF/RESET
AVIONICS VENT EXHAUST MODE	OVBD
PROP 2 ANTI-ICING	OFF
PROP ANTI ICING FAULT PROCEDURE	APPLY
DE-ICING MODE SEL	OVRD (as required)
PACK 2	OFF
BLEED 2	OFF
BLEED VALVE FAULT PROCEDURE	APPLY
MODULE EOPT LIST	CHECK
● Before landing	
ATPCS	OFF
● At touch-down	
IDLE GATE	MONITOR
● After landing	
OVBD VALVE	FULL OPEN

CAUTION : Before opening any door, Packs 1 and 2 must be selected OFF and cockpit communication hatch must be opened.

Note : PROP BRAKE IS INOPERATIVE.

	PROCEDURES FOLLOWING FAILURE MFC	2.05.10		
		P 17	150	
				JUN 97

COMMENTS

- Stick pusher is lost without FAULT indication
 - « IDLE GATE FAIL » amber alert is lost
 - Hostess and crew indications calls are lost.
 - As Prop 2 anti-icing is lost, icing-conditions must be avoided.
 - If propeller unbalance due to ice becomes excessive, periodically moving CL 100 OVRD will modify centrifugal forces allowing ice elimination.
 - R/H side window anti-icing is lost without FAULT indication.
 - ATPCS must be selected OFF before landing due to loss of A/FEATH on engine 2. Check go around performances ATPCS off.
- R
- Ground Turbo Fan 2 is lost.
 - Pack 2 is lost without FAULT indication
 - Bleed 2 is lost without FAULT indication
 - As extract fan is lost, avoid leaving avionics selected ON on the ground for a long period of time with high OAT.
 - As wow signal is lost, OVBD VALVE must be selected FULL OPEN manually on the ground to improve racks cooling.
 - Landing gear secondary RED UNLK indication and green arrows are lost.
 - ENG 2 OIL LO PRESS remains lighted on indicator when engine 2 is shut down.
 - After landing, as both outflow valves do not fully open, selecting OVBD valve full open relieves the ΔP between cabin and outside.
 - Exhaust mode to OVBD position controls the OVBD valve to partially open: ventilation air is then discharge overboard instead of being directed to the underfloor valve. Ventilation is ensured by ΔP between cabin and outside air.

	PROCEDURES FOLLOWING FAILURES MFC	2.05.10		
		P 18	001	
				DEC 94

AA

MFC 1B + 2B FAULT

ALERT

CONDITION	VISUAL	AURAL
MFC 1B + 2B FAULT	<ul style="list-style-type: none"> - MC amber light (not flashing) - MFC amber light on CAP - Associated MFC FAULT on overhead panel 	Nil

PROCEDURE

MFC 1B + 2B FAULT

Affected MODULES OFF/RESET
 OVERHEAD PANEL MONITOR
 MODULE EQT LIST CHECK

● Before landing

NOSE WHEEL STEERING OFF
 ANTI SKID OFF
 ANTI SKID FAULT PROCEDURE APPLY
 L/G LEVER DOWN
 EMER EXTENSION HANDLE PULL

CAUTION : Gear cannot be retracted

● At touch down

IDLE GATE PULL
 DIFFERENTIAL BRAKING USE

● After landing

PACK 1 OFF
 PACK 2 OFF
 HORNS ANTI-ICING OFF
 PROBES HEATING OFF
 OVBD VALVE FULL OPEN

*Note : ATPCS ARM light is not available
 external power cannot be used*

CAUTION : Before opening any door, Packs 1 and 2 must be selected OFF and cockpit communication hatch must be opened.

R

	PROCEDURES FOLLOWING FAILURES MFC	2.05.10		
		P 19	001	
				NOV 93

AA

COMMENTS

- As MC, MW and most of the centralized alerts are lost, overhead panel must be monitored
- Brake operation is lost below 35 kts if antiskid is selected ON. Antiskid must be selected OFF before landing.
- As wow system is lost
 - nose wheel steering is lost
 - horns anti-icing must be switched OFF manually after landing
 - Idle Gate automatic function is not available
 - OVBD VALVE must be selected FULL OPEN manually on the ground to improve racks cooling and relieves the ΔP between cabin and outside (as outflow valves do not fully open).
- Ground turbofans 1 and 2 are lost. Packs 1 and 2 must be switched off on the ground to avoid any overheat problem
- ENG 1 and ENG 2 OIL LO PRESS remain lighted on indicator when respective engine is shut down.
- Landing gear controls, secondary RED UNLK indications and green arrows, "LANDING GEAR NOT DOWN" warning are lost.
- TAT heating FAULT light is lost.
- No whooler is heard during trim activation
- A/FEATH light is lost
- Hot brakes indication is lost
- Stall warning and stick shaker are lost without FAULT indication. Stick pusher remains available.
- RH side window anti-icing is lost without FAULT indications.
- On ground, pressurization digital controller test capability is lost.



ATR 72
F.C.O.M.

PROCEDURES FOLLOWING FAILURES

MFC

2.05.10

P 20

200

JUN 97

		MODULE FAILURE									
ATA	FUNCTION	1A	1B	2A	2B	1A/ 1B	1A/ 2A	1A/ 2B	1B/ 2A	1B/ 2B	2A/ 2B
AIR	PACK 1					LOST					
	PACK 1 FAULT IND					LOST					
	PACK 2										LOST
	PACK 2 FAULT IND										LOST
	GROUND TURBO FAN 1		LOST			LOST			LOST	LOST	
	GROUND TURBO FAN 2				LOST			LOST		LOST	LOST
	X VALVE			LOST			LOST		LOST	LOST	LOST
	CUTFLOW VALVE		LOST		LOST	LOST		LOST	LOST	LOST	LOST
	AUTO OPENING AFTER LDC			LOST	LOST	LOST	LOST	LOST	LOST	LOST	LOST
AFCS	AF OFF WARNING LIGHT						LOST				
	ALTITUDE ALERT LIGHT						LOST				
	GUIDANCE LIGHT						LOST				
COM	MECHANIC CALL IND	LOST				LOST	LOST	LOST			
	HOSTESS CALL IND			LOST		LOST	LOST		LOST		LOST
	CREW CALL IND			LOST		LOST	LOST		LOST		LOST
	CVR ERASE RECORDERS (START/STOP)		LOST			LOST	LOST		LOST	LOST	
ELEC	DC STRY BUS UNDV DETECT		LOST			LOST			LOST	LOST	
	DC BUS 1 OFF WARNING	LOST				LOST	LOST	LOST			
	DC BUS 2 OFF WARNING			LOST			LOST		LOST		LOST
	AC BUS 1 SPLY	LOST				LOST	LOST	LOST			
	AC BUS 2 SPLY			LOST			LOST		LOST		LOST
	INV 1 FAULT LIGHT	LOST	LOST			LOST	LOST	LOST	LOST	LOST	
	INV 2 FAULT LIGHT			LOST	LOST		LOST	LOST	LOST	LOST	LOST
	EMER BAT CHG Ctl										LOST
	MAIN BAT CHG Ctl										LOST
	BAT DISCHARGE IN FLIGHT										LOST
LEFT PFTS	LOST				LOST	LOST	LOST				
RIGHT PFTS			LOST			LOST		LOST		LOST	
FIL CTL	FLAP						LOST	LOST			
										LOST	
	STALL WARN- ING					LOST					LOST
										LOST	
							LOST				LOST
PITCH TRIM										LOST	
										LOST	
RUD TRIM							LOST				
	TRIPLE TRIM IND					LOST	LOST				



PROCEDURES FOLLOWING FAILURE

2.05.10

P 21

001

MFC

JUL 98

AA

RRRR

		MODULE FAILURE									
ATA	FUNCTION	1A	1B	2A	2B	1A/ 1B	1A/ 2A	1A/ 2B	1B/ 2A	1B/ 2B	2A/ 2B
HYD	BLUE HYD PUMP CTL GREEN PUMP LO PR INDICATION		LOST			LOST		LOST	LOST	LOST	
ICE AND RAIN PROT	PROP 1 ANTI ICING					LOST					
	PROP 1 ANTI ICING FAULT					LOST					
	PROP 2 ANTI ICING										LOST
	PROP 2 ANTI ICING FAULT										LOST
	ENG 1 (DE OR ANTI) ICING							LOST			
	ENG 1 (DE OR ANTI) ICING FAULT								LOST		
	ENG 2 (DE OR ANTI) ICING								LOST		
	ENG 2 (DE OR ANTI) ICING FAULT								LOST		
	AIRFRAME DE ICING FAULT							LOST			
	AIRFRAME DE ICING (BOOTS A)						LOST				
	AIRFRAME DE ICING (BOOTS B)										LOST
	LEFT SIDE WINDOW ANTI ICING and associated FAULT alert						LOST				
	RIGHT SIDE WINDOW ANTI ICING			LOST	LOST			LOST	LOST	LOST	LOST
RIGHT SIDE WINDOW ANTI ICING FAULT				LOST			LOST	LOST	LOST	LOST	
INHIBITION OF HORNS ANTI ICING ON GROUND										LOST	
CCAS	MASTER WARNING									LOST	
	MASTER CAUTION									LOST	
	AURAL ALERTS									LOST	
	AMBER ALERTS ON CAP									LOST	
	WARNING ALERTS (CONFIG. PROP BRK, ENG OIL)									LOST	
WARNING ALERT (FLAPS INLK)							LOST				
LDG GEAR	LDG GEAR CONTROL	LOST					LOST	LOST	LOST	LOST	
	PRIMARY UNLK INDICATIONS					LOST	LOST	LOST			
	PRIMARY GREEN ARROWS					LOST					
	SECONDARY UNLK INDICATIONS			LOST	LOST		LOST	LOST	LOST	LOST	LOST
	SECONDARY GREEN ARROWS			LOST	LOST		LOST	LOST	LOST	LOST	LOST
	BRAKE OVERTEMP ALERT (LH)		LOST			LOST			LOST	LOST	
	BRAKE OVERTEMP ALERT (RH)		LOST		LOST	LOST			LOST	LOST	LOST
	LDG LEVER LOCKED DOWN ON GROUND									LOST	
	NOSE WHEEL STEERING									LOST	
ANTI SKID									LOST		
'LDG GEAR NOT DOWN' WARNING									LOST		
LIGHT	LIGHT TEST						LOST				
BLEED	HP VALVE 1	LOST				LOST	LOST	LOST			
	HP VALVE 2			LOST			LOST		LOST		LOST
	BLEED VALVE 1					LOST					
	BLEED VALVE 1 FAULT IND		LOST			LOST			LOST	LOST	
	BLEED VALVE 2										LOST
BLEED VALVE 2 FAULT IND				LOST			LOST		LOST	LOST	

 ATR 72 F.C.O.M.	PROCEDURES FOLLOWING FAILURE AUTOPILOT	2.05.11		
		P 1	001	
				DEC 96

AILERON MISTRIM MESSAGE, or EXCESSIVE LATERAL TRIM REQUIRED or ABNORMAL FLIGHT CHARACTERISTICS OF THE AIRPLANE

ALERT

Any unusual situations observed such as :

- illumination of the AILERON MISTRIM message on ADU,
- excessive lateral trim required,
- abnormal flight characteristics of the airplane.

PROCEDURE

AILERON MISTRIM MESSAGE, or EXCESSIVE LATERAL TRIM REQUIRED, or ABNORMAL FLIGHT CHARACTERISTICS OF THE AIRPLANE

AP DISCONNECT HOLDING FIRMLY THE CONTROLS
 FLY MANUALLY PRIOR TO ADJUSTING THE LATERAL TRIMS

The autopilot may be reengaged following adjustment of the lateral trims.

COMMENTS

Ailerons forces may be affected by external conditions such as :

- R - Prolonged exposure to severe icing.
- De/anti-icing hold over time exceeded.



AR72
F.C.O.M.

PROCEDURES FOLLOWING FAILURE

AUTOPILOT

2.05.11

P 2

190

DEC 96

AA

PITCH MISTRIM MESSAGE

ALERT

CONDITION	VISUAL	AURAL
R AP TRIM THRESHOLD limit is exceeded	- PITCH MISTRIM message on ADU	NONE

PROCEDURE

PITCH MISTRIM MESSAGE
AP DISCONNECT HOLDING FIRMLY THE CONTROLS FLY MANUALLY UNTIL RESUMING NORMAL CONDITIONS.

COMMENTS

Elevator hinge moments may be affected by external conditions.
From experience, the most likely cause appears to be take off with ice remaining on the tail plane (De or anti-icing hold overtime exceeded).
R Severe icing may also be a factor.

PITCH TRIM FAIL

ALERT

CONDITION	VISUAL	AURAL
Pitch Auto-trim lost	- PITCH TRIM FAIL message on ADU	NONE

PROCEDURE

PITCH TRIM FAIL (MESSAGE)
AP DISCONNECT HOLDING FIRMLY THE CONTROLS FLY MANUALLY UNTIL RESUMING NORMAL CONDITIONS.

	PROCEDURES FOLLOWING FAILURE MISCELLANEOUS	2.05.12		
		P 1	001	
				DEC 94

DOORS UNLK IN FLT

ALERT

CONDITION	VISUAL	AURAL
Door UNLK in flight	<ul style="list-style-type: none"> - MC light flashing amber - DOOR amber light on CAP - associated door amber light on overhead panel 	SC

PROCEDURE

DOORS UNLK IN FLT

R	Any door but FWD compt SIGNS ON DOOR associated VISUALLY CHECK
R	■ If unlocked or check not feasible LDG ELEVATION 9000 ft MAX FL 100/MEA
R	FWD compt NO ACTION

COMMENTS

- As the doors except FWD COMPT open outwards, when one is not locked, the ΔP must be reduced by aircraft descent and landing elevation selection.

	PROCEDURES FOLLOWING FAILURE MISCELLANEOUS	2.05.12		
		P 2	001	
				JUN 97

COCKPIT WINDOW CRACKED

PROCEDURE

COCKPIT WINDOW CRACKED	
WINDOW HEAT AFFECTED	OFF
LDG ELEVATION	9000 ft
MAX FL	100/MEA

	PROCEDURES FOLLOWING FAILURE MISCELLANEOUS	2.05.12		
		P 3	001	
				NOV 93

AUDIO SEL FAULT

ALERT

CONDITION	VISUAL	AURAL
RCAU processing board failure or power loss	<ul style="list-style-type: none"> - MC light flashing amber - AUDIO amber light on CAP - AUDIO SEL FAULT amber light on associated side panel 	SC

PROCEDURE

AUDIO SEL FAULT	
AUDIO SEL affected	ALTN

COMMENTS

In ALTN mode, affected crew station is connected directly and only to :
VHF 1 if CAPT station affected
VHF 2 if F/O station affected

 AR72 F.C.O.M.	PROCEDURES FOLLOWING FAILURE MISCELLANEOUS	2.05.12		
		P 4	001	
				NOV 93

AA

AHRS A/ERECT FAIL

ALERT

CONDITION	VISUAL	AURAL
One AHRS loses TAS input from both ADC	- associated A/ERECT FAIL amber light illuminates on associated side panel	- Nil -

PROCEDURE

AHRS A/ERECT FAIL		
R	ATT/HDG pb on affected side	DEPRESS
	When possible	
	AIRCRAFT	UNACCELERATED LEVEL FLIGHT
R	AHRS affected PUSH TO ERECT pb	DEPRESS FOR 15 s

COMMENTS

When the aircraft is stabilized (unaccelerated level flight), a gyro fast erection is performed by depressing the associated pb for 15 s.

- AHRS A/ERECT FAIL remains illuminated as long as TAS signal is lost.

	PROCEDURES FOLLOWING FAILURE	2.05.12		
		P 5	001	
	MISCELLANEOUS			JUN 97

AA

EFIS COMPARISON

ALERT

CONDITION	VISUAL	AURAL
AHRS disagree	- MC flashing amber - EFIS COMP amber light on CAP - *	SC
if AP engaged	- AP OFF red light on flight deck - AP MSG on both EADI - AHRS DATA INVALID on ADU	Cavalry charge

- (*) When the two AHRS disagree (6 degrees or more) on pitch information amber PIT message is displayed on both EADI'S.
 When the two AHRS disagree (6 degrees or more) on roll information, amber ROL message is displayed on both EADI'S.
 When the two AHRS disagree on both pitch and roll information, amber ATT message is displayed on both EADI'S.
 In these cases, AP (if engaged) disconnects being unable to identify the right AHRS.

*Note : In case of heading AHRS disagree, HDG HOLD should not be used.
 In addition, GO AROUND Mode is not available.*

PROCEDURE

EFIS COMP	
■ If AHRS caution appears on EFIS (ROL, PIT, ATT, HDG) BOTH EADI, STBY HORIZON CROSS CHECK WRONG INSTRUMENT IDENTIFY ATT/HDG pb on affected side DEPRESS WRONG AHRS POWER SUPPLY OFF . If AHRS 1 is WRONG, pull C/B AHRS1 NORM SPLY and AHRS1 AUX SPLY . If AHRS2 is WRONG, pull C/B AHRS2 NORM SPLY and AHRS2 AUX SPLY FLT	
■ If ILS caution appears on EFIS NAV SOURCES CHECK VOR/ILS pb on affected side DEPRESS if necessary	

COMMENTS

- The standby horizon is used as a reference to identify the wrong EADI.
- The pilot on the affected side selects the non affected AHRS to supply its SGU.
- The wrong AHRS is selected OFF to recover AP (pitch or roll AHRS disagree) or HDG

	PROCEDURES FOLLOWING FAILURE MISCELLANEOUS	2.05.12		
		P 6	001	
				NOV 93

AA

AHRS FAIL

ALERT

CONDITION	VISUAL	AURAL
Loss of AHRS	<ul style="list-style-type: none"> - ATT FAIL red message on associated EADI - HDG FAIL red message on associated EHSI - Flag on opposite RMI 	- Nil -

PROCEDURE

AHRS FAIL	
R	ATT/HDG pb on affected side DEPRESS PERIODICALLY COMPARE REMAINING AHRS OUTPUTS TO STBY INST

COMMENTS

- The pilot on the affected side selects the non affected AHRS to supply its SGU.
- Note : AP (If engaged) identifies the valid AHRS and remains engaged.*

	PROCEDURES FOLLOWING FAILURE MISCELLANEOUS	2.05.12		
		P 7	001	
				DEC 96

SGU FAIL

ALERT

Refer to 1.10.30 page 14 for SGU failure alerts.

PROCEDURE

SGU FAIL	
EFIS SG pb on affected side	DEPRESS

- Note : – If AP is engaged and coupled to the wrong SGU, upper modes are lost. When selecting valid SGU, AP recovers upper modes.
- Do not confuse with CRT failure : in case of a SGU failure, both CRTs on one side are affected.



ATR 72
F.C.O.M.

PROCEDURES FOLLOWING FAILURE

MISCELLANEOUS

2.05.12

P 8

001

JUN 97

CRT FAIL

PROCEDURE

CRT FAIL

CRT affected OFF

COMMENTS

- Affected CRT must be switched OFF to obtain composite mode on the non affected one. (In composite mode, the background brightness (brown and blue colors) is controlled by the WX DIM rheostat).

LOSS OF RADIO ALTIMETER INFORMATION

ALERT

CONDITION	VISUAL	AURAL
Loss of radio altimeter	- amber dashes on EADI - GPWS FAULT amber light on CAP	- Nil -

PROCEDURE

LOSS OF RADIO ALTIMETER INFORMATION

GPWS OFF

CAUTION : LDG GEAR NOT DOWN undue warning may be generated when reducing PLs, this alarm may be cancelled by using EMER AUDIO CANCEL

	PROCEDURES FOLLOWING FAILURE MISCELLANEOUS	2.05.12		
		P 9	001	
				JUN 97

ADU FAILURE

PROCEDURE

ADU FAILURE	
ALT SEL mode	LOST
IAS/VS mode	USE TCS
<p>■ If amber "AP MSG" appears on EADI or,</p>	
<p>■ In composite mode</p>	
AP	DISCONNECT, HOLDING FIRMLY THE CONTROLS

COMMENTS

- ADU provides three types of information :

- armed and active mode
- altitude selection
- anomaly message

as crew is no longer informed on anomaly message AP must be disconnected.

	PROCEDURES FOLLOWING FAILURE MISCELLANEOUS	2.05.12		
		P 10	520	
				JUL 01

AA **ADC FAULT
ALERT**

CONDITION	VISUAL	AURAL
Loss of ADC Selected ADC is connected to AP	- Red flag on Vc, Vs indicators - TAT / SAT / TAS information are lost - AP MSG on both EADI - CPL DATA INVALID ON ADU	None

PROCEDURE

ADC FAULT	
VALID ADC	SELECT
PF	NON AFFECTED SIDE
AP COUPLING	NON AFFECTED SIDE
ATC	NON AFFECTED EQUIPMENT
■ If ADC1 are lost	
LANDING ELEVATION (pressure altitude)	MAN MODE
GPWS	OFF
■ If both ADC are lost	
TLU	MAN MODE
STBY INST	USE
MAN RATE knob	9 o'clock
CAB PRESS MODE SEL	MAN
ENGINE PARAMETERS	MONITOR
TCAS (if installed)	STBY
GPWS	OFF

COMMENTS

- When ADC1 is lost, ADC2 is automatically selected to supply the pressurization digital controller. In this case, baro correction is no longer available (reference 1013 mb) and landing field elevation must be set in terms of pressure altitude.
- if both ADC are lost, only standby instruments are available: air data instruments have a red flag and AHRS have lost their TAS inputs.
Pressurization has to be performed manually.
- if the selected ADC is lost, FDAU does not receive inputs ; bugs are not available on TQ indicators.
Each engine uses their own source (if ADC1 is the faulty selected ADC)
- 10 sec. are necessary to recover bugs on TQ indicator after selection of the valid ADC.
- if ADC1 is lost, GPWS is lost.
- if both ADC are lost, De-Anti Icing AUTO Mode Selection is lost.

	PROCEDURES FOLLOWING FAILURE MISCELLANEOUS	2.05.12		
		P 11	020	
				JUL 01

AA

ADC DISAGREEMENT

ALERT

In case of disagreement between both ADC, AP (if engaged) disconnects being unable to identify the valid ADC. AP MSG is displayed on both EADI
“DADC DATA INVALID” message is displayed on ADU.

PROCEDURE

ADC DISAGREEMENT	
- INSTRUMENTS	CROSS CHECK
- FAULTY ADC	IDENTIFIED
- VALID ADC	SELECTED
- FAULTY ADC	OFF
■ If ADC is WRONG, pull C/Bs <ul style="list-style-type: none"> • ADC 1 EMER SPLY and • MFC 1A AUX/ADC 1 HOT SPLY 	
■ If ADC 2 is WRONG, pull C/B ADC 2 Refer to “ADC FAULT” PROCEDURE	

COMMENTS

- Wrong ADC is selected OFF in order to recover AP.

*Note : Drift between both ADC information may occur if pitots are partially obstructed.
Check pitots.*

	PROCEDURES FOLLOWING FAILURE MISCELLANEOUS	2.05.12		
		P 12	001	
				JUN 97

AA

ADC SW FAULT

ALERT

CONDITION	VISUAL	AURAL
incorrect ADC switching	<ul style="list-style-type: none"> - MC amber light on CAP - ENG amber light on CAP - ADC sw FAULT amber light on flight deck panel 	SC

PROCEDURE

ADC SW FAULT	
ADC SW	Set to opposite ADC

COMMENTS

ADC SW FAULT illuminates when ADC sw position does not correspond to ADC actual selection (relays defect).

ADC is set back to the previous selection in order to have an agreement between ADC sw position and ADC selection.

	PROCEDURES FOLLOWING FAILURE MISCELLANEOUS	2.05.12		
		P 13	001	
				JUN 94

FIRE LOOP FAULT

ALERT

CONDITION	VISUAL	AURAL
Fire loop fault signal	<ul style="list-style-type: none"> - MC light flashing amber - LOOP amber light on CAP - associated loop FAULT amber light on overhead panel 	SC

PROCEDURE

FIRE LOOP FAULT	
LOOP affected	OFF

CAUTION : As long as loop affected is not selected to OFF position, the system can not detect an engine fire.



ATR 72
F.C.O.M.

PROCEDURES FOLLOWING FAILURE

2.05.12

P 14

001

MISCELLANEOUS

JUL 99

OXYGEN LO PR

ALERT

CONDITION	VISUAL	AURAL
Low pressure (below 50 PSI) in the LP distribution circuit	- MC light flashing amber - OXY amber light on CAP - MAIN SUPPLY LO PR amber light on overhead panel	SC

PROCEDURE

OXYGEN LO PR	
OXY MAIN SUPPLY	OFF then ON
<p>■ If oxygen LO PR light remains lit</p>	
MAIN SUPPLY	OFF
OXYGEN PORTABLE UNIT	COCKPIT INSTALLED (IF RQRD)

COMMENTS

- The 120 l portable oxygen bottle permits :

R . a continuous diluted flow to one crew member at 13 000 ft for a duration of 30 mn

Oxygen low pressure supply valve position may disagree with actual oxygen MAIN SUPPLY pb position if this pushbutton is activated by very close consecutive actions.

Interval between OFF and ON actions on oxygen MAIN SUPPLY must be greater than one second to be sure that low pressure supply valve position is in accordance with actual pb position.



NR 72
F.C.O.M.

PROCEDURES FOLLOWING FAILURE

2.05.12

P 15

070

MISCELLANEOUS

JUN 97

LEFT INTENTIONALLY BLANK

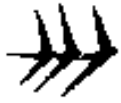

ATR 72
F.C.O.M.

LOADING – FUEL – BALANCE CHART

2.06.00

P 1

001

CONTENTS

OCT 89

- 2.06.00 CONTENTS**

- 2.06.01 DEFINITIONS**

- 2.06.02 CARGO LOADING**

- 2.06.03 FUEL LOADING**

- 2.06.04 WEIGHT AND BALANCE**

 ATR 72 F.C.O.M.	LOADING – FUEL – BALANCE CHART DEFINITIONS	2.06.01		
		P 1	001	
				JUN 96

BASIC WEIGHT

it's the aircraft weight without any load. This means a weight not including crew members, galley load, fuel load but including the commercial arrangement of the corresponding version.

DRY OPERATING WEIGHT

it's the weight of the aircraft in operating configuration. It's obtained by addition of the basic weight, crew members and galley load.

TAKE OFF FUEL

it's the weight of the on board fuel at take off.

OPERATING WEIGHT

it's the weight obtained by addition of the DRY OPERATING WEIGHT and the TAKE OFF FUEL

PAYLOAD

it's the weight of the payload including cargo loads, passengers and passenger baggage.

ZERO FUEL WEIGHT

it's the weight obtained by addition of the DRY OPERATING WEIGHT and the PAYLOAD.

TAKE OFF WEIGHT

it's the weight at take off. It's equal to the addition of the ZERO FUEL WEIGHT and TAKE OFF FUEL.

TRIP FUEL

it's the weight of the fuel necessary to fly the normal leg without reserves.

LANDING WEIGHT

it's the weight at landing. It is equal to TAKE OFF WEIGHT minus TRIP FUEL.

REFERENCE DATA

- Datum line STA0 (2.362 m (7'9") forward of aircraft nose)
- R Leading edge of MAC 13.604 m (44'63")
- R Length of MAC 2.303 m (7'556")



ATR 72
F.C.O.M.

LOADING - FUEL - BALANCE CHART

2.06.02

P 1

001

CARGO LANDING

NOV 90

AA

R FORWARD AND REAR CARGO COMPARTMENTS

R Refer to "Weight and Balance Manual"

R WBM : 1.60.04.

	LOADING - FUEL - BALANCE CHART	2.06.03		
		P 1	001	
	FUEL LOADING			NOV 93

AA

GENERAL INFORMATION

MAXIMUM FUEL CAPACITY

	PER TANK	TOTAL
VOLUME	3 185 L (840 US GAL)	6 370 L (1680 US GAL)
WEIGHT	2 500 kg (5512 Lbs)	5 000 kg (11025 Lbs)

REFUELING PANEL

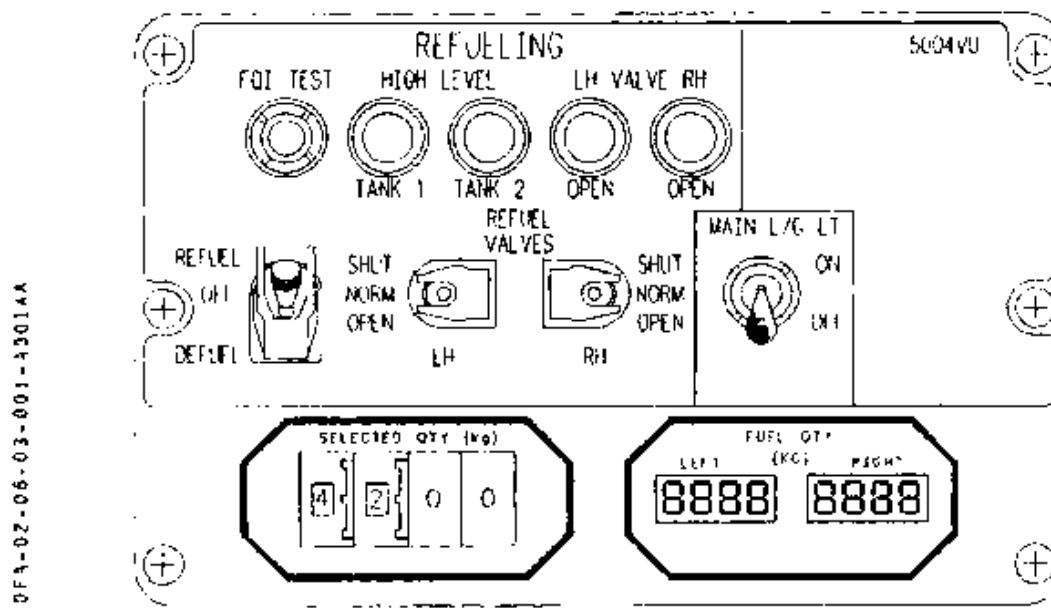

- During automatic refueling, both tanks receive fuel simultaneously.
- With the tanks filled to the maximum nominal total fuel capacity, there is sufficient space in each tank to allow a 2 % thermal expansion of fuel without causing spillage through the vent system.
- The vent tank in each wing has a volume of 100 l (26 US gal).
- If necessary during refueling procedures, close relevant REFUEL VALVE to isolate associated tank as required.

	LOADING – FUEL – BALANCE CHART FUEL LOADING	2.06.03		
		P 2	001	
				JUN 95

AA

REFUELING PROCEDURE

- Observe the safety precautions and make certain that the tanker and the aircraft are properly grounded.

R *Note : Refueling when RH engine is running in Hotel mode is prohibited.*

- Press FQI TEST pb and check :

R · All 8's are displayed on the FUEL QTY ind.

AUTOMATIC REFUELING (when installed)

- Check REFUEL VALVES sws are at NORM position and guarded.
- Set the preselected total fuel quantity on the SELECTED QTY ind.
- Place Mode selector sw in REFUEL position.
- Start refueling.

MANUAL REFUELING

- Raise REFUEL VALVES sw guards and place all switches in SHUT position.
- Place Mode selector sw in REFUEL position.
- Place appropriate REFUEL VALVES sw in OPEN position.
- Start refueling.
- Monitor individual tank content on FUEL QTY indicator and select appropriate tank REFUEL VALVE sw to SHUT as tank content reaches required fuel quantity.

Note : 1. Total time to fill wing tanks is approximately 18 minutes.

2. As tanks become full, fuel flow will be stopped by high level sensors and appropriate tank HIGH LEVEL light will illuminate.

R

	LOADING – FUEL – BALANCE CHART FUEL LOADING	2.06.03		
		P 3	001	
				MAY 91

GRAVITY FILLING

- Position access platform for access to overwing refueling caps and attach refueling hose grounding cable to grounding connection at overwing refueling cap. Remove overwing refueling cap.

Start filing, monitor quantity of fuel delivered on FQI and observe the HIGH LEVEL indicator lights on refueling panel ; stop filing when required fuel level is reached or when HIGH LEVEL indicator light(s) come on.

USE OF MANUAL (MAGNETIC) INDICATORS

Each tank is equipped with 2 indicators

- one in the inner part of the wing (between the engine and the fuselage)
- one in the outer part of the wing

- Read and note roll aircraft attitude on clinometer in the hydraulic bay (LH landing gear fairing)

R Aircraft bank angle is positive for wing up, negative for wing down.

Note : Pitch attitude must be between $- 3^{\circ}$ degrees and $+ 1$ degree. In this range pitch has no influence.

- Position access platform
- Unlock indicator rod with screwdriver and slowly withdraw rod until magnetic attraction between rod and float magnets is felt.
- Check rod freedom by pushing up both rod and float magnet.
- Slowly withdraw rod down to floating level
- Note the graduation on rod which aligns with wing bottom surface
- Replace indicator and lock with screwdriver

R -- If both gauges indications don't indicate extremum values (0 or 30 for inner gauge, 0 or 19 for outer gauge, disregard clinometer indication. Fuel quantity is determined thanks to internal and external indicator reading.

R Note : Clinometer indication is disregarded for accuracy purposes.

R -- If one gauge indicates an extremum value (0 or 30 for inner gauge, 0 or 19 for outer gauge, disregard this extremum value. use clinometer indication and the other gauge value.



AR72
F.C.O.M.

LOADING - FUEL - BALANCE CHART

2.06.03

P 4

001

FUEL LOADING

NOV 92

FUEL QUANTITY
(LITERS)

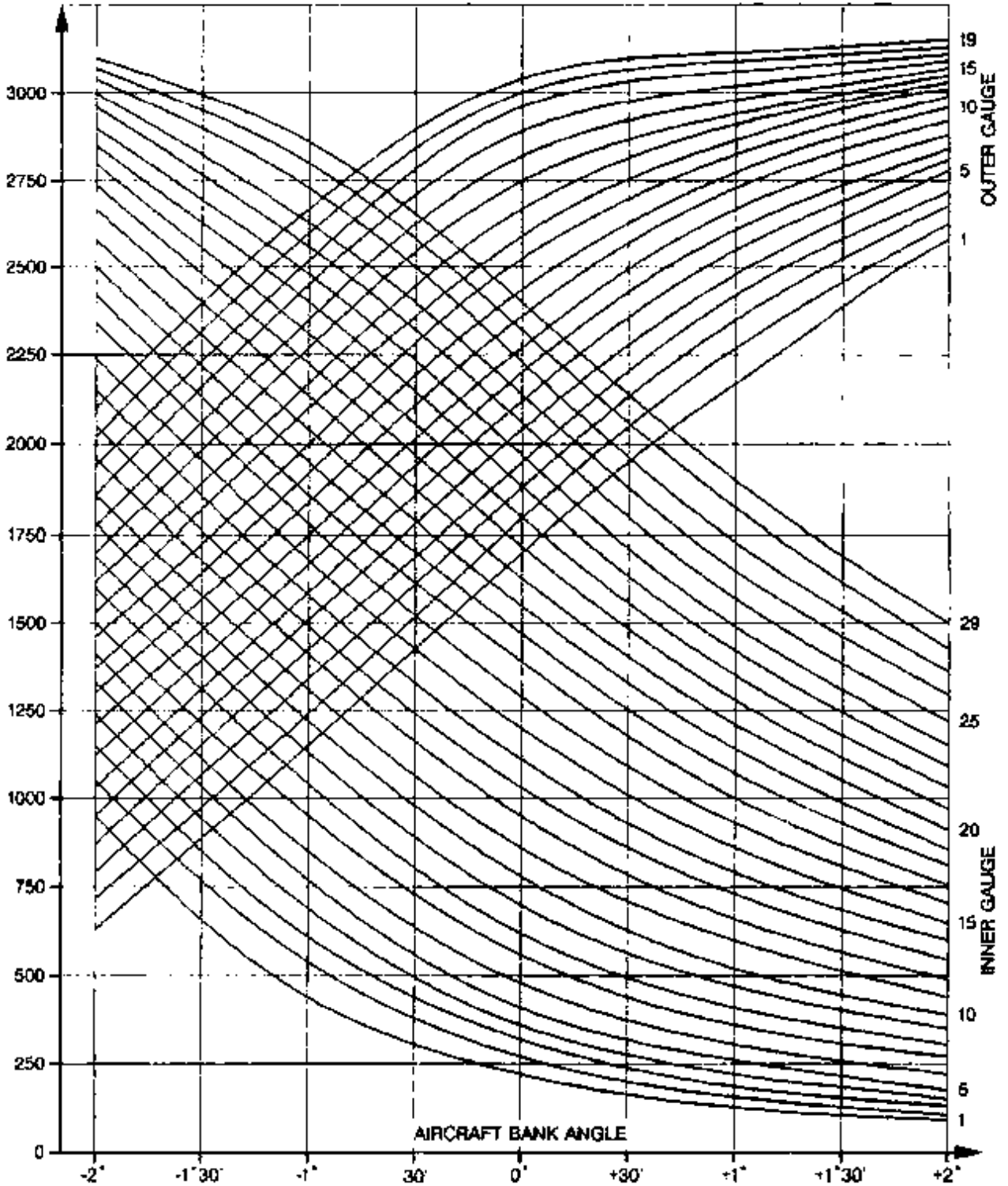

ROFA-02-06-03-004-A001AB



NR72
F.C.O.M.

LOADING - FUEL - BALANCE CHART

2.06.03

P 5

001

FUEL LOADING

NOV 92

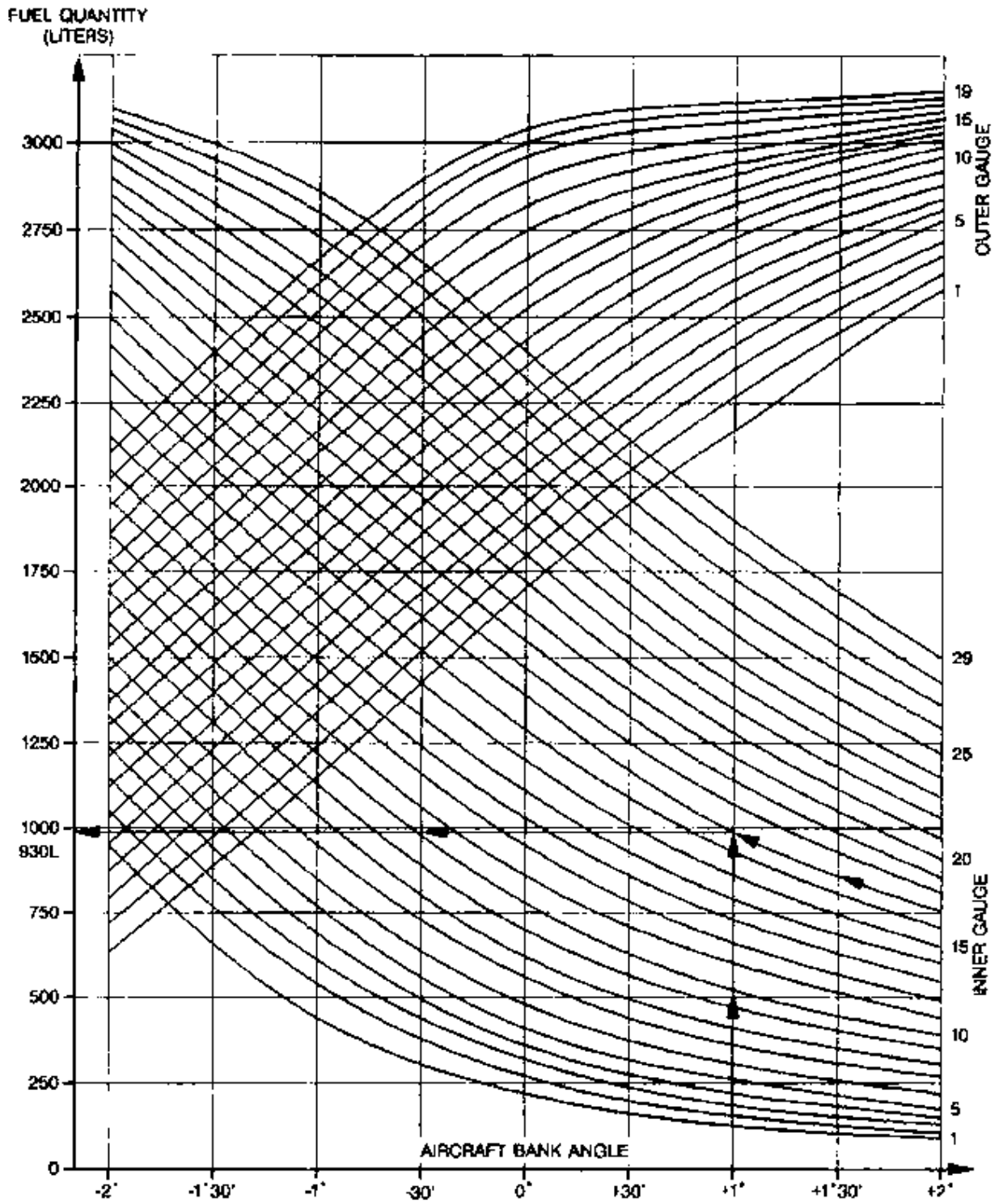

First example internal indicator reading : 17 cm
clinometer reading : 1°



NR72
F.C.O.M.

LOADING - FUEL - BALANCE CHART

FUEL LOADING

2.06.03

P 6

001

NOV 92

FUEL QUANTITY
(LITERS)

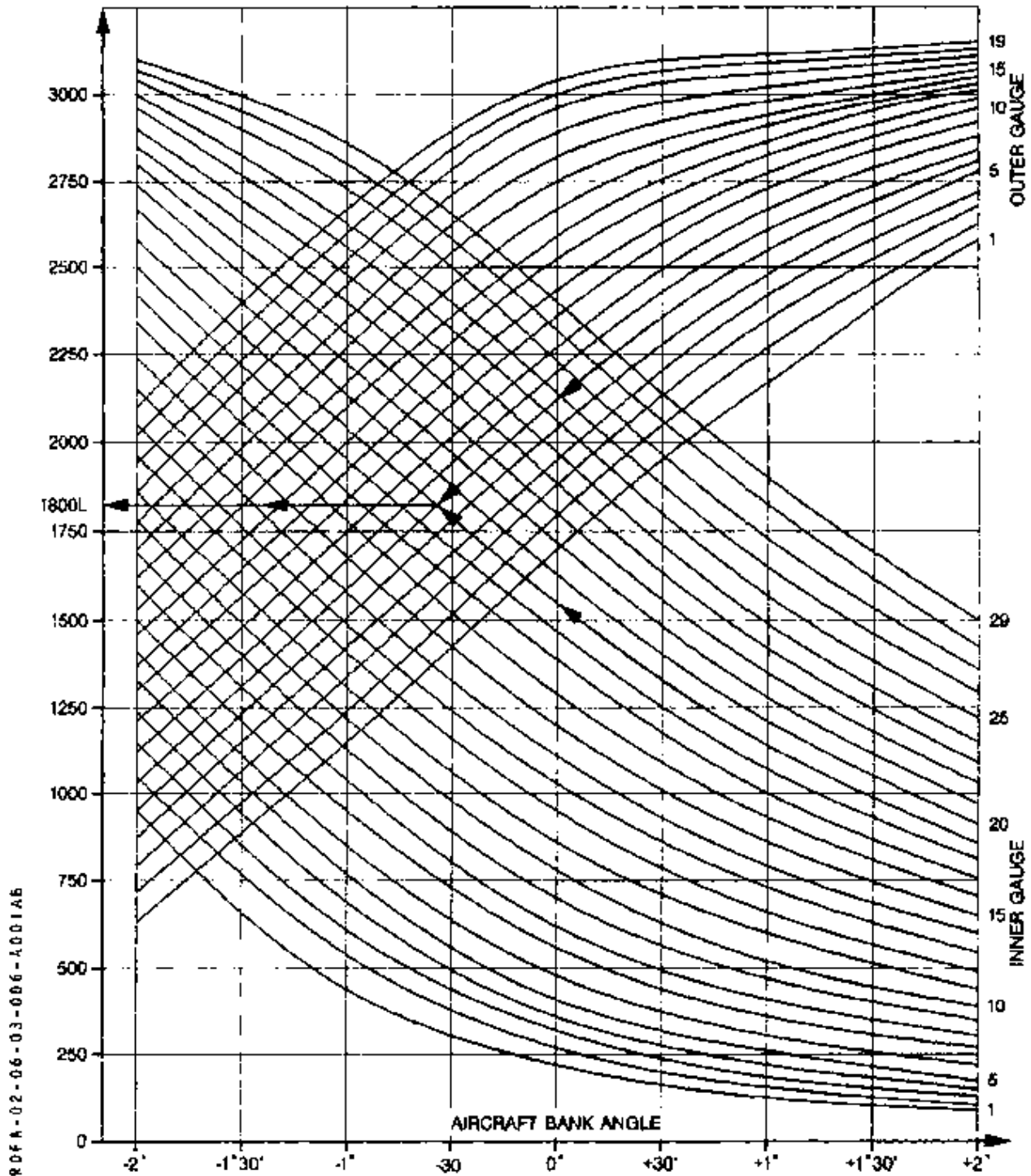

R OF A - 02 - 06 - 03 - 006 - 1001A6

Second example internal indicator reading 19 cm
external indicator reading 6 cm



ATR 72
F.C.O.M.

LOADING FUEL - BALANCE CHART

2.06.03

P 7

001

FUEL LOADING

NOV 92

FUEL QUANTITY
(LITERS)

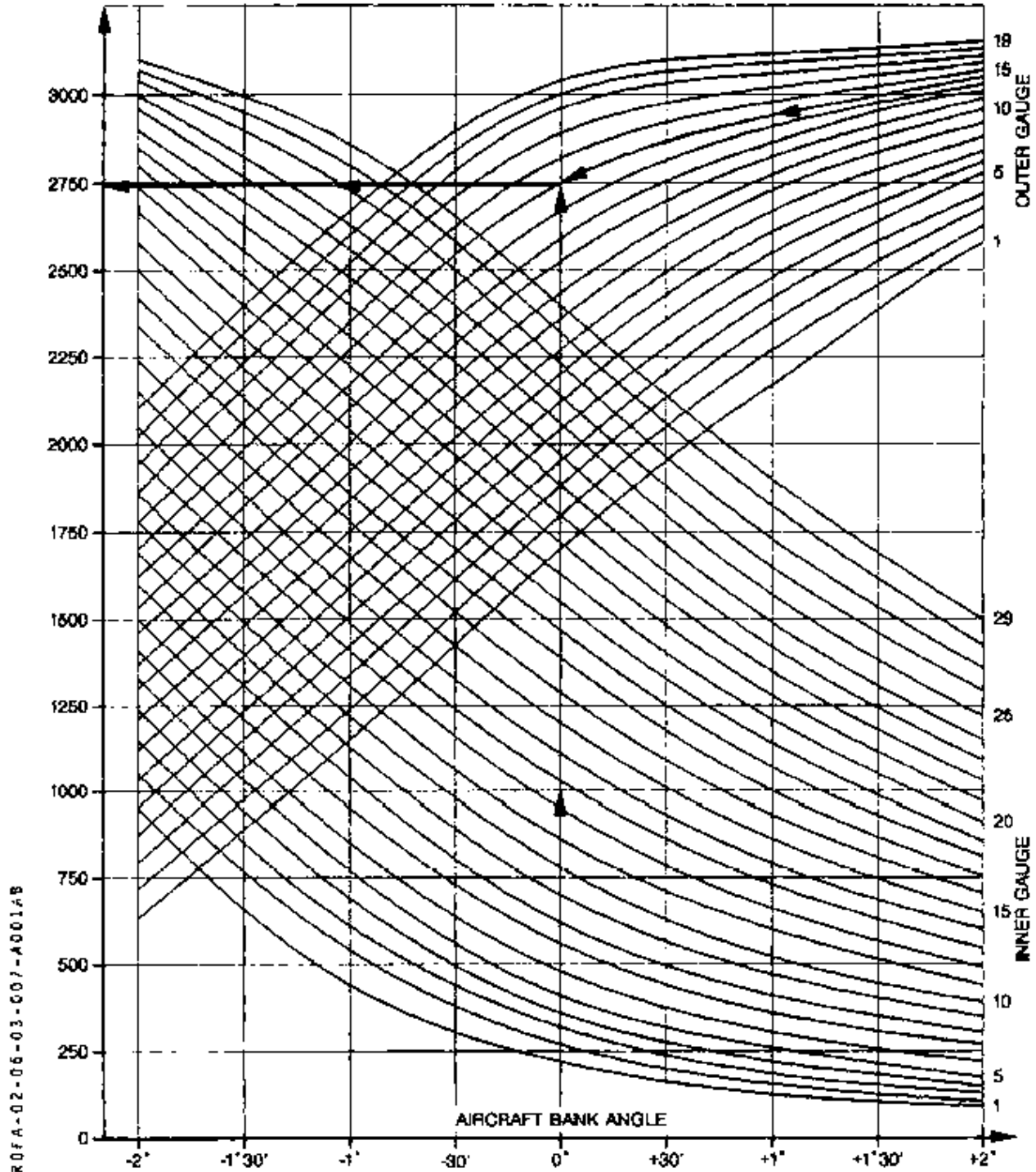

ROFA-02-06-03-C07-A001AB

Third example external indicator reading 14 cm
clinometer reading : 0°



LOADING - FUEL - BALANCE CHART

2.06.03

P 8

001

FUEL LOADING

KG

SEP 89

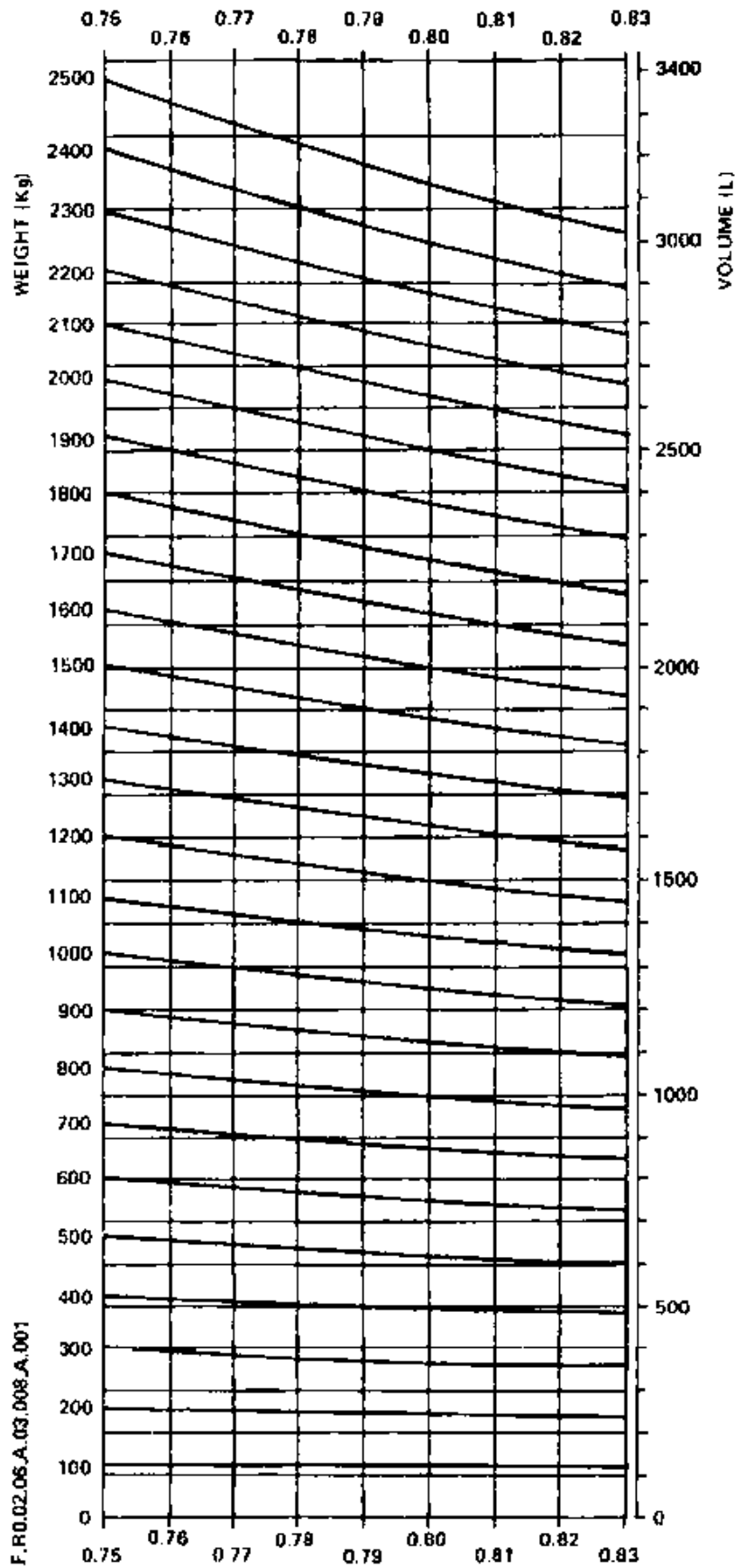

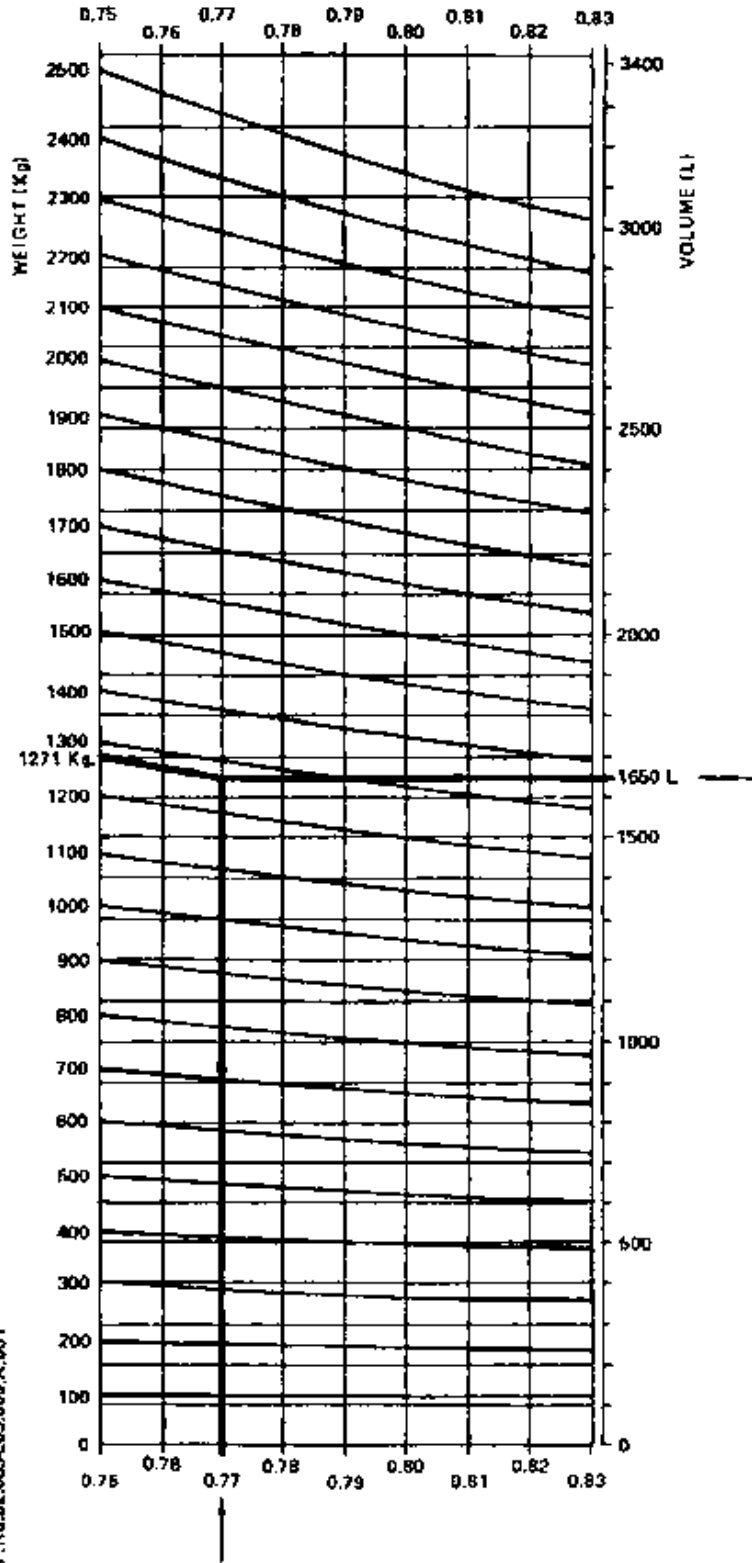

F. R0.02.06.A.03.009 A.001

Example :
Fuel quantity → density → weight
1650 l → 0,77 → 1271 kg



AR72
F.C.O.M.

LOADING FUEL - BALANCE CHART

2.06.03

P 10

001

FUEL LOADING

NOV 92

ACCURACY OF FUEL QUANTITY INDICATORS

① At levelled flight, fuel quantity indicators introduce an error which is function of the indicated fuel quantity. Error is as follows :

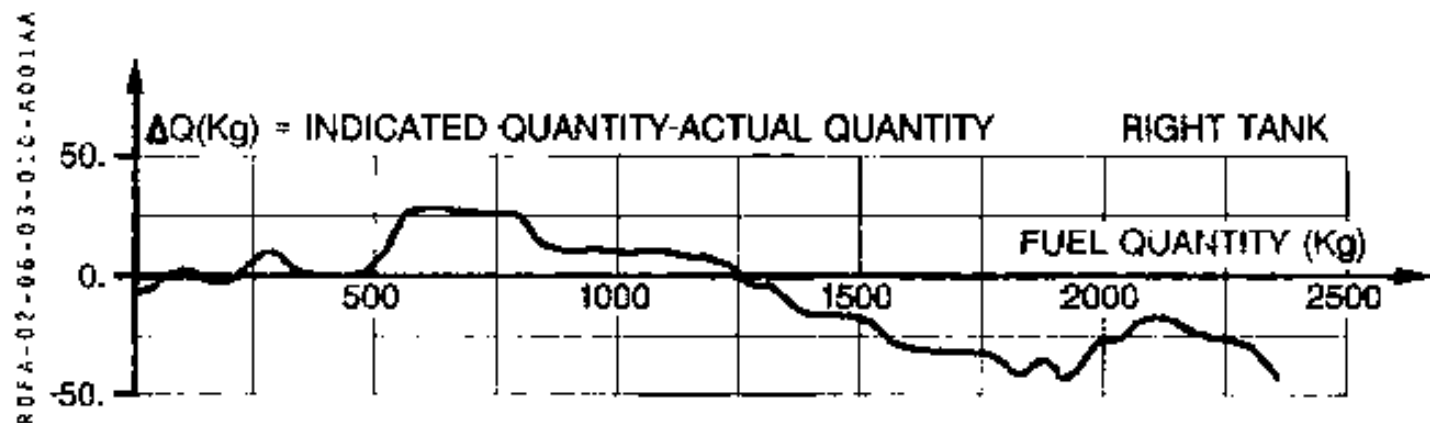
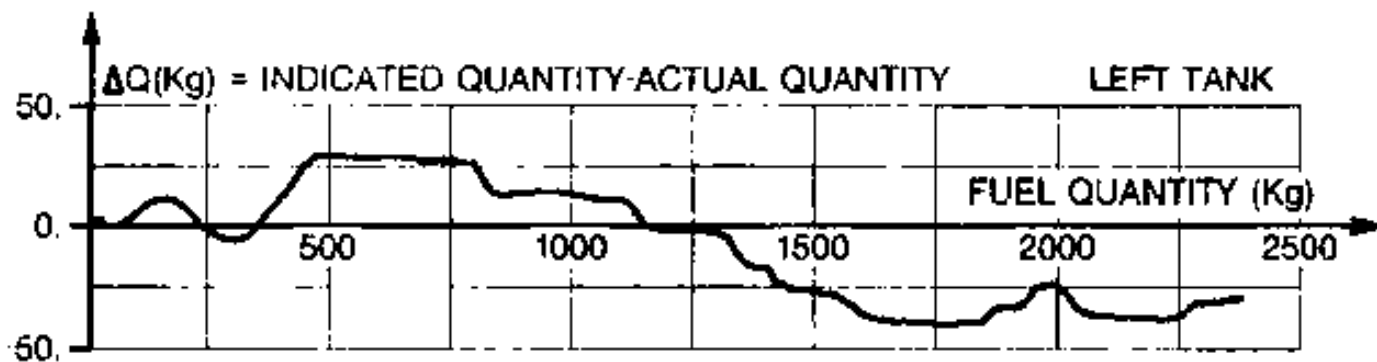

ROFA-02-06-03-01-C-5001AA

 ATR 72 F.C.O.M.	LOADING – FUEL – BALANCE CHART WEIGHT AND BALANCE	2.06.04		
		P 1	001	
				DEC 94

AC

R **GENERAL**

R

R Refer to Weight and Balance Manual, chapters 1.70.00 and 1.90.03 in order to find
 R actual data concerning your aircraft.

R The following pages give the method to fill the load and trim sheet, but must be
 R considered only as a methodology taking into account a fictitious example.

 ATR 72 F.C.O.M.	LOADING – FUEL – BALANCE CHART WEIGHT AND BALANCE	2.06.04		
		P 2	001	
				DEC 94

LOAD AND TRIM SHEET

This chart allows the determination of the weight and the CG location in % MAC of the aircraft in function of :

- Dry operating weight
- Passenger accommodation
- Luggage and freight repartition
- Fuel on board

EXAMPLE BASED ON FICTITIOUS VALUES

The utilization is described by the following example :

Dry operating weight	12 500 kg and CG = 18.7 %
Deviation or adjustments	+ 10 kg in the toilet
Total cargo	680 kg (400 kg in FWD cargo compartment ; 280 kg in AFT cargo compartment).
Total passengers	60 (40 M - 15 F - 5 CH)
Actual zero fuel weight	17 505 kg
Take off fuel	1 500 kg
Actual take off weight	19 005 kg

- a) Carry in ① Dry operating weight and CG : 12 500 kg, 18.7 % MAC
- b) Compute the Dry Operating weight index using the corresponding formula and carry it in ②

$$\frac{(18.7 - 25) \times 12\,500 \times 0.2303}{1\,500} = -12.1$$

- c) Carry in ③ weight deviations relatives to the zones D, E or F. Compute corresponding index corrections :

$$10 \text{ kg in zone F} = +0.61 \times 1 = +0.61$$

Carry this result in ④

- d) Compute corrected index.

$$\text{Corrected index} = -12.1 + 0.61 = -11.49$$

Carry in ⑤ this result.

 A320 F.C.O.M.	LOADING - FUEL - BALANCE CHART WEIGHT AND BALANCE	2.06.04		
		P 3	001	
				DEC 94

AB

e) From this value on index scale (6), draw through each corresponding scale (7) the effect of :

- Passengers in compartments A, B, C,
- Luggage and cargo in forward and afterward cargo.

Note : Take into account the arrows orientation

From the last obtained point (A), draw a vertical line to intercept the horizontal line corresponding to the Actual Zero Fuel Weight defined on table (8) : 17 505 kg.

f) Check that the intersection point (9) is in weight and CG authorized limits for aircraft without fuel (10).

- Weight must be below the Max Zero Fuel Weight.
- Center of gravity must be inside zero fuel operational limits (dotted lines), suggested by the Manufacturer to cover weight/center of gravity incertitude due to loading and in flight movement.

g) From the point (A), draw on the scale (11) the take off fuel quantity effect. From this point (B), draw an other vertical line to intercept the horizontal line corresponding to the Actual Take off Weight defined on table (8) : 19 005 kg.

- Check that this weight is not over the Maximum Take off Weight.
- Check that center of gravity is inside the take off/landing certified limits.

Read on the diagram the Take Off Weight CG in % of MAC. (25.6)

h) In function of obtained CG, determinate on scale (12) the stabilizer tab setting value at Take Off Weight : cockpit indication + 1.25 UP.

j) Following the vertical line associated to the take off condition, go back in the fuel zone and subtract the fuel trip quantity. From this point and using the methodology explained in g) :

- Check that the weight at landing is below the MLW
- Check that center of gravity is inside of the take off/landing certified limits.

 ATR 72 F.C.O.M.	OPERATING DATA CONTENTS	3.01.00		
		P 1	001	
				DEC 94

AA

- 3.01.00 CONTENTS**
- 3.01.01 CONVERSIONS**
- 3.01.02 ISA**
- 3.01.03 MACH – Z – IAS – TAS – SAT – TAT**
- R 3.01.04 QFE/QNH – ZP/ZG/ISA**
- 3.01.05 PRESSURIZATION**

	OPERATING DATA		3.01.01		
			P 1	001	
	CONVERSIONS				JUN 97

CONVERSION METERS → FEET

DATA	RESULT
2,211 m	2,200 m : 7217.8 ft
	11 m : + 36.09 ft
	2,211 m : 7253.89 ft

Multiply	by	to get
m	3.281	ft

m	0	1	2	3	4	5	6	7	8	9
0	0	3.28	6.56	9.84	13.12	16.40	19.68	22.97	26.25	29.53
10	32.81	36.09	39.37	42.65	45.93	49.21	52.49	55.77	59.05	62.34
20	65.62	68.90	72.18	75.46	78.74	82.02	85.30	88.58	91.86	95.14
30	98.42	101.70	104.99	108.27	111.55	114.83	118.11	121.39	124.67	127.95
40	131.23	134.51	137.79	141.07	144.36	147.64	150.92	154.20	157.48	160.76
50	164.04	167.32	170.60	173.88	177.16	180.44	183.72	187.01	190.29	193.57
60	196.85	200.13	203.41	206.69	209.97	213.25	216.53	219.81	223.09	226.38
70	229.66	232.94	236.22	239.50	242.78	246.06	249.34	252.62	255.90	259.18
80	262.46	265.74	269.03	272.31	275.59	278.87	282.15	285.43	288.71	291.99
90	295.27	298.55	301.83	305.11	308.40	311.68	314.96	318.24	321.52	324.80
	0	10	20	30	40	50	60	70	80	90
100	328.08	360.89	393.70	426.50	459.31	492.12	524.93	557.74	590.54	623.35
200	656.16	688.97	721.78	754.58	787.39	820.20	853.01	885.82	918.62	951.43
300	984.24	1017.0	1049.9	1082.7	1115.5	1148.3	1181.1	1213.9	1246.7	1279.5
400	1312.3	1345.1	1377.9	1410.7	1443.6	1476.4	1509.2	1542.0	1574.8	1607.6
500	1640.4	1673.2	1706.0	1738.8	1771.6	1804.4	1837.2	1870.1	1902.9	1935.7
600	1968.5	2001.3	2034.1	2066.9	2099.7	2132.5	2165.3	2198.1	2230.9	2263.8
700	2296.6	2329.4	2362.2	2395.0	2427.8	2460.6	2493.4	2526.2	2559.0	2591.8
800	2624.6	2657.4	2690.3	2723.1	2755.9	2788.7	2821.5	2854.3	2887.1	2919.9
900	2952.7	2985.5	3018.3	3051.1	3084.0	3116.8	3149.6	3182.4	3215.2	3248.0
	0	100	200	300	400	500	600	700	800	900
1000	3280.0	3608.9	3937.0	4265.0	4593.1	4921.2	5249.3	5577.4	5905.4	6233.5
2000	6561.6	6889.7	7217.8	7545.8	7873.9	8202.0	8530.1	8858.2	9186.2	9514.3
3000	9842.4	10170	10499	10827	11155	11483	11811	12139	12467	12795
4000	13123	13451	13779	14107	14436	14764	15092	15420	15748	16076
5000	16404	16732	17060	17388	17716	18044	18372	18701	19029	19357
6000	19685	20013	20341	20669	20997	21325	21653	21981	22309	22638
7000	22966	23294	23622	23950	24278	24606	24934	25262	25590	25918
8000	26246	26574	26903	27231	27559	27887	28215	28543	28871	29199
9000	29527	29855	30183	30511	30840	31168	31496	31824	32152	32480

	OPERATING DATA	3.01.01		
		P 2	001	
	CONVERSIONS			JUN 97

CONVERSION FEET → METERS

DATA	RESULT
403 ft	400 ft : 121.92 m
	3 ft : + 0.91 m
	403 ft : 122.83 m

Multiply	by	to get
ft	0.3048	m

ft	0	1	2	3	4	5	6	7	8	9
0	0	0.30	0.61	0.91	1.22	1.52	1.83	2.13	2.44	2.74
10	3.05	3.35	3.66	3.96	4.27	4.57	4.88	5.18	5.49	5.79
20	6.10	6.40	6.71	7.01	7.32	7.62	7.92	8.23	8.53	8.84
30	9.14	9.45	9.75	10.06	10.36	10.67	10.97	11.28	11.58	11.89
40	12.19	12.50	12.80	13.11	13.41	13.72	14.02	14.33	14.63	14.94
50	15.24	15.54	15.85	16.15	16.46	16.76	17.07	17.37	17.68	17.98
60	18.29	18.59	18.90	19.20	19.51	19.81	20.12	20.42	20.73	21.03
70	21.34	21.64	21.95	22.25	22.56	22.86	23.16	23.47	23.77	24.08
80	24.38	24.69	24.99	25.30	25.60	25.91	26.21	26.52	26.82	27.13
90	27.43	27.74	28.04	28.35	28.65	28.96	29.26	29.57	29.87	30.18
100	30.48	33.53	36.58	39.62	42.67	45.72	48.77	51.82	54.86	57.91
200	60.96	64.01	67.06	70.10	73.15	76.20	79.25	82.30	85.34	88.39
300	91.44	94.49	97.54	100.53	103.63	106.68	109.73	112.78	115.82	118.87
400	121.92	124.97	128.02	131.06	134.11	137.16	140.21	143.26	146.30	149.35
500	152.40	155.45	158.50	161.54	164.59	167.64	170.69	173.74	176.78	179.83
600	182.88	185.93	188.98	192.02	195.07	198.12	201.17	204.22	207.26	210.31
700	213.36	216.41	219.46	222.50	222.55	228.60	231.65	234.70	237.74	240.79
800	243.84	246.89	249.94	252.98	256.03	259.08	262.13	265.18	268.22	271.27
900	274.32	277.37	280.42	283.46	286.51	289.56	292.61	295.66	298.70	301.75
1000	304.80	335.28	365.76	396.24	426.72	457.20	487.68	518.16	548.64	579.12
2000	609.60	640.08	670.56	701.04	731.52	762.00	792.48	822.96	853.44	883.92
3000	914.40	944.88	975.36	1005.8	1036.3	1066.8	1097.3	1127.8	1158.2	1188.7
4000	1219.2	1249.7	1280.2	1310.6	1341.1	1371.6	1402.1	1432.6	1463.0	1493.5
5000	1524.0	1554.5	1585.0	1615.4	1645.9	1676.4	1706.9	1737.4	1767.8	1798.3
6000	1828.8	1859.3	1889.8	1920.2	1950.7	1981.2	2011.7	2042.2	2072.6	2103.1
7000	2133.6	2164.1	2194.6	2225.0	2255.5	2286.0	2316.5	2347.0	2377.6	2407.9
8000	2438.4	2468.9	2499.4	2529.8	2560.3	2590.8	2621.3	2651.8	2682.2	2712.7
9000	2743.2	2773.7	2804.2	2834.6	2865.1	2895.6	2926.1	2956.6	2987.0	3017.5
10000	3048.0	3352.8	3657.6	3962.4	4267.2	4572.0	4876.8	5181.6	5486.4	5791.2
20000	6096.0	6400.8	6705.6	7010.4	7315.2	7620.0	7924.8	8229.6	8534.4	8839.2
30000	9144.0	9448.8	9753.6	10058	10363	10668	10973	11278	11582	11887
40000	12192	12497	12802	13106	13411	13716	14021	14326	14630	14935
50000	15240	15545	15850	16154	16459	16764	17069	17374	17678	17983

	OPERATING DATA						3.01.01		
	CONVERSIONS						P 3	001	
									JUN 97

CONVERSION HPa IN HG - ZP

HPa	in. HG	ZP ft	HPa	in. HG	ZP ft	HPa	in. HG	ZP ft	HPa	in. HG	ZP ft
1050	31.01	-989									
1048	30.95	-936	958	28.29	1543	868	25.63	4219	778	22.97	7131
1046	30.89	-883	956	28.23	1601	866	25.57	4281	776	22.92	7199
1044	30.83	-830	954	28.17	1658	864	25.51	4343	774	22.86	7267
1042	30.77	-776	952	28.11	1715	862	25.45	4405	772	22.80	7335
1040	30.71	-723	950	28.05	1773	860	25.40	4468	770	22.74	7402
1038	30.65	-669	948	27.99	1831	858	25.34	4531	768	22.68	7470
1036	30.59	-615	946	27.94	1889	856	25.28	4593	766	22.62	7538
1034	30.53	-562	944	27.88	1947	854	25.22	4656	764	22.56	7607
1032	30.47	-508	942	27.82	2005	852	25.16	4718	762	22.50	7676
1030	30.42	-454	940	27.76	2062	850	25.10	4781	760	22.44	7745
1028	30.36	-400	938	27.70	2120	848	25.04	4844	758	22.38	7815
1026	30.30	-346	936	27.64	2178	846	24.98	4907	756	22.32	7885
1024	30.24	-292	934	27.58	2236	844	24.92	4970	754	22.27	7955
1022	30.18	-238	932	27.52	2294	842	24.86	5033	772	22.21	8025
1020	30.12	-184	930	27.46	2353	840	24.81	5097	770	22.15	8095
1018	30.06	-129	928	27.40	2412	838	24.75	5161	748	22.09	8161
1016	30.00	-74	926	27.34	2471	836	24.69	5225	746	22.03	8231
1014	29.94	-20	924	27.29	2530	834	24.63	5289	744	21.97	8301
1012	29.88	34	922	27.23	2589	832	24.57	5353	742	21.91	8371
1010	29.83	89	920	27.17	2647	830	24.51	5417	740	21.85	8442
1008	29.77	144	918	27.11	2707	828	24.45	5481	738	21.79	8512
1006	29.71	199	916	27.05	2767	826	24.39	5545	736	21.73	8583
1004	29.65	254	914	26.99	2826	824	24.33	5610	734	21.68	8654
1002	29.59	309	912	26.93	2885	822	24.27	5675	732	21.62	8725
1000	29.53	364	910	26.87	2944	820	24.21	5740	730	21.56	8796
998	29.47	419	908	26.81	3004	818	24.16	5805	728	21.50	8867
996	29.41	475	906	26.75	3064	816	24.10	5870	726	21.44	8939
994	29.35	530	904	26.70	3124	814	24.04	5935	724	21.38	9010
992	29.29	586	902	26.64	3183	812	23.98	6000	722	21.32	9082
990	29.23	641	900	26.58	3243	810	23.92	6065	720	21.26	9154
988	29.18	697	898	26.52	3303	808	23.86	6131	718	21.20	9226
986	29.12	753	896	26.46	3363	806	23.80	6197	716	21.14	9298
984	29.06	809	894	26.40	3424	804	23.74	6263	714	21.08	9371
982	29.00	865	892	26.34	3484	802	23.68	6329	712	21.03	9443
980	28.94	921	890	26.28	3545	800	23.62	6394	710	20.97	9516
978	28.88	977	888	26.22	3606	798	23.56	6461	708	20.91	9589
976	28.82	1033	886	26.16	3667	796	23.51	6528	706	20.85	9662
974	28.76	1089	884	26.10	3728	794	23.45	6595	704	20.79	9735
972	28.70	1145	882	26.05	3789	792	23.39	6661	702	20.73	9809
970	28.64	1202	880	25.99	3850	790	23.33	6727	700	20.67	9882
968	28.64	1259	878	25.93	3911	788	23.27	6794	698	20.61	9956
966	28.53	1316	876	25.87	3973	786	23.21	6861	696	20.55	10030
964	28.47	1373	874	25.81	4034	784	23.15	6928	694	20.49	10104
962	28.41	1430	872	25.75	4096	782	23.09	6995	692	20.43	10179
960	28.35	1486	870	25.69	4157	780	23.03	7063	690	20.38	10253



OPERATING DATA

MACH - Z - IAS - TAS - SAT - TAT

3.01.03		
P 1	001	
		JUL 98

AA

	DATA	RESULTS
R	PRESSURE ALTITUDE 25 000 ft	MACH 0,5
R	IAS 205 Kt	STATIC AIR TEMPERATURE (SAT) ... -42°C
R	TOTAL TEMPERATURE -30°C	TRUE AIRSPEED (TAS) 295 Kt

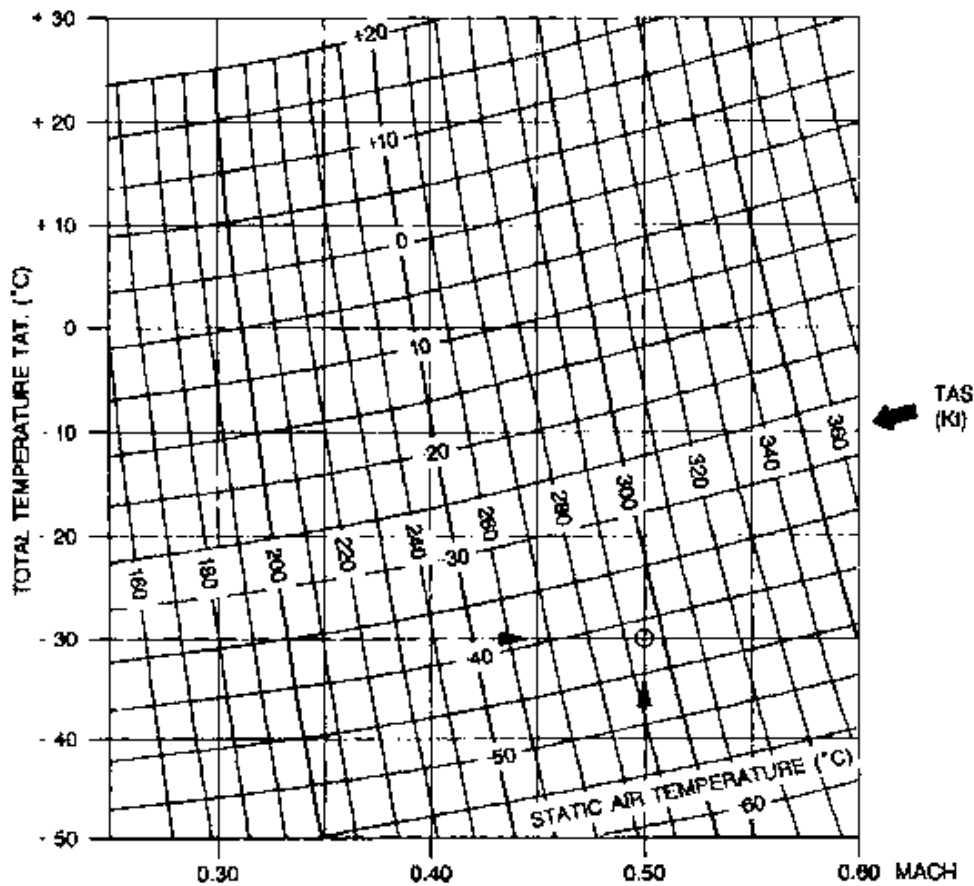
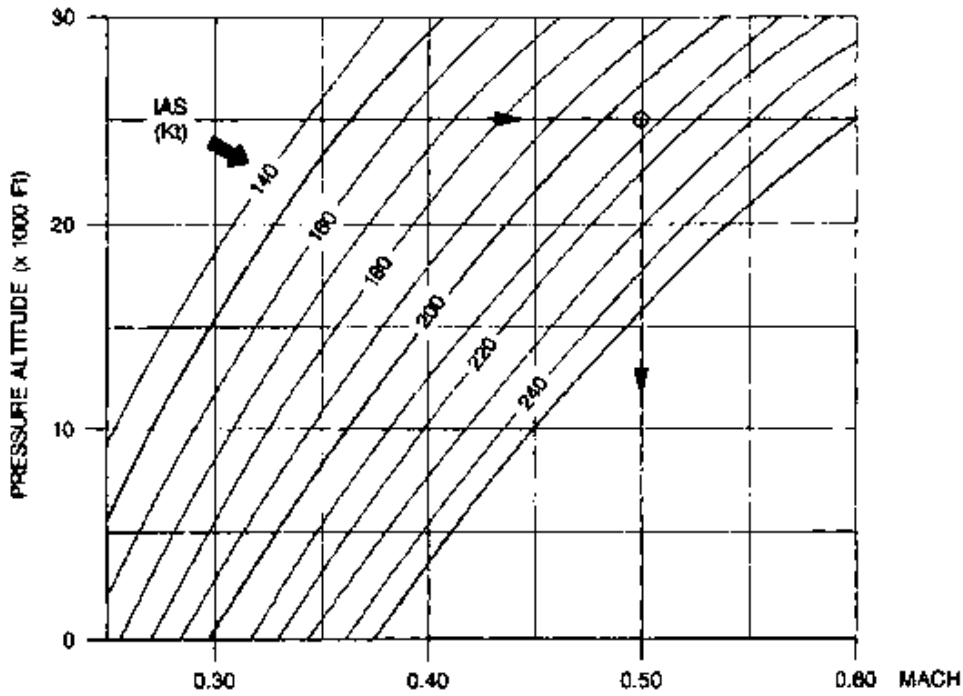

ROFA-03-01-03-001-4001AA



ANR 72
F.C.O.M.

OPERATING DATA

QFE / QNH - ZP/ZG/ISA

3.01.04

P 1

001

DEC 94

AA

EXAMPLE : QNH 1020 HPa. → QFE 914 HPa.
Z 3000 ft ZP 2800 ft

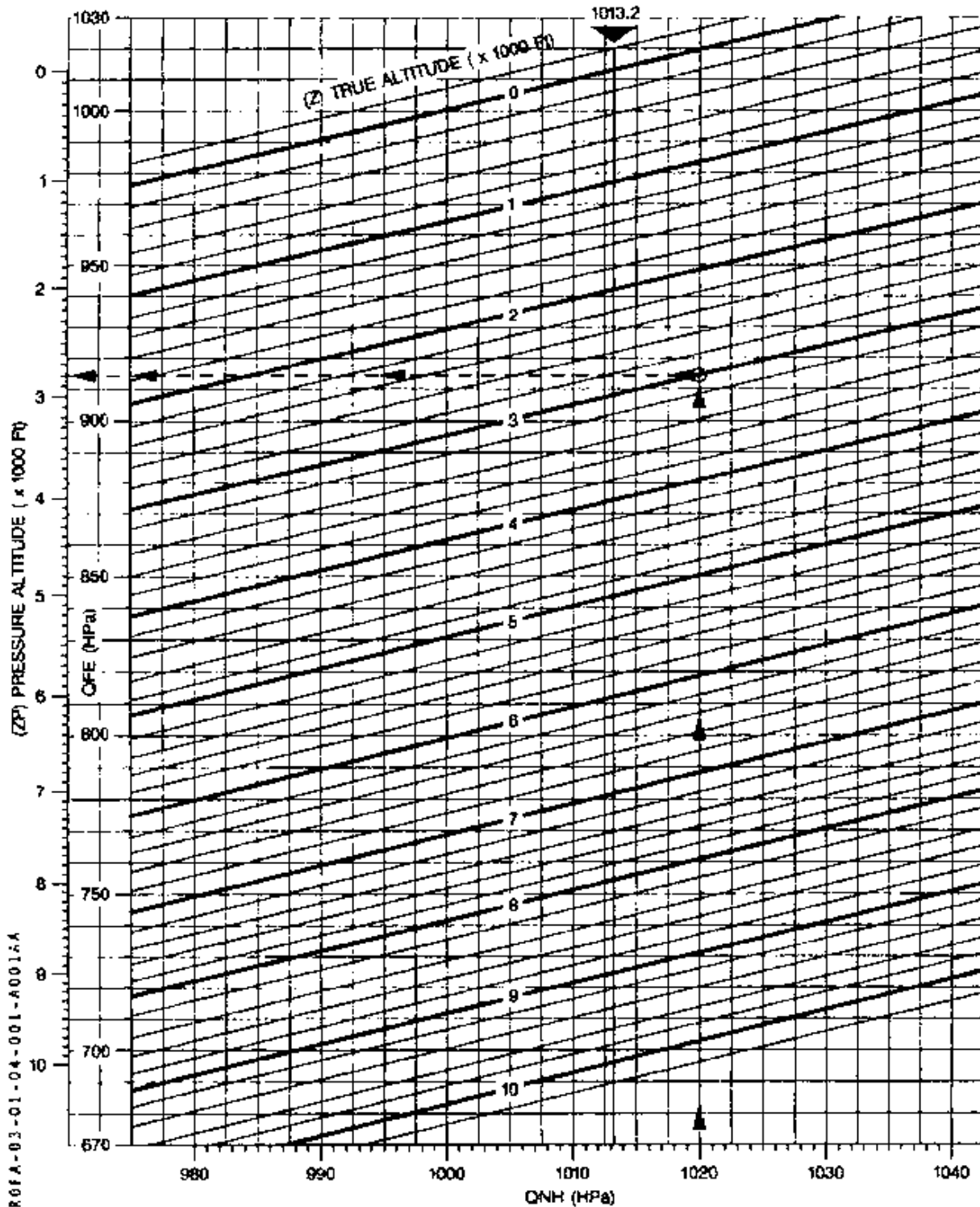

R6FA-03-01-04-001-A001AA



ATR 72
F.C.O.M.

OPERATING DATA

PRESSURIZATION

3.01.05

P 1

001

JUN 97

AA

--- positive differential pressure limitation 6 PSI
- - - safety relief max differential pressure 6.35 PSI

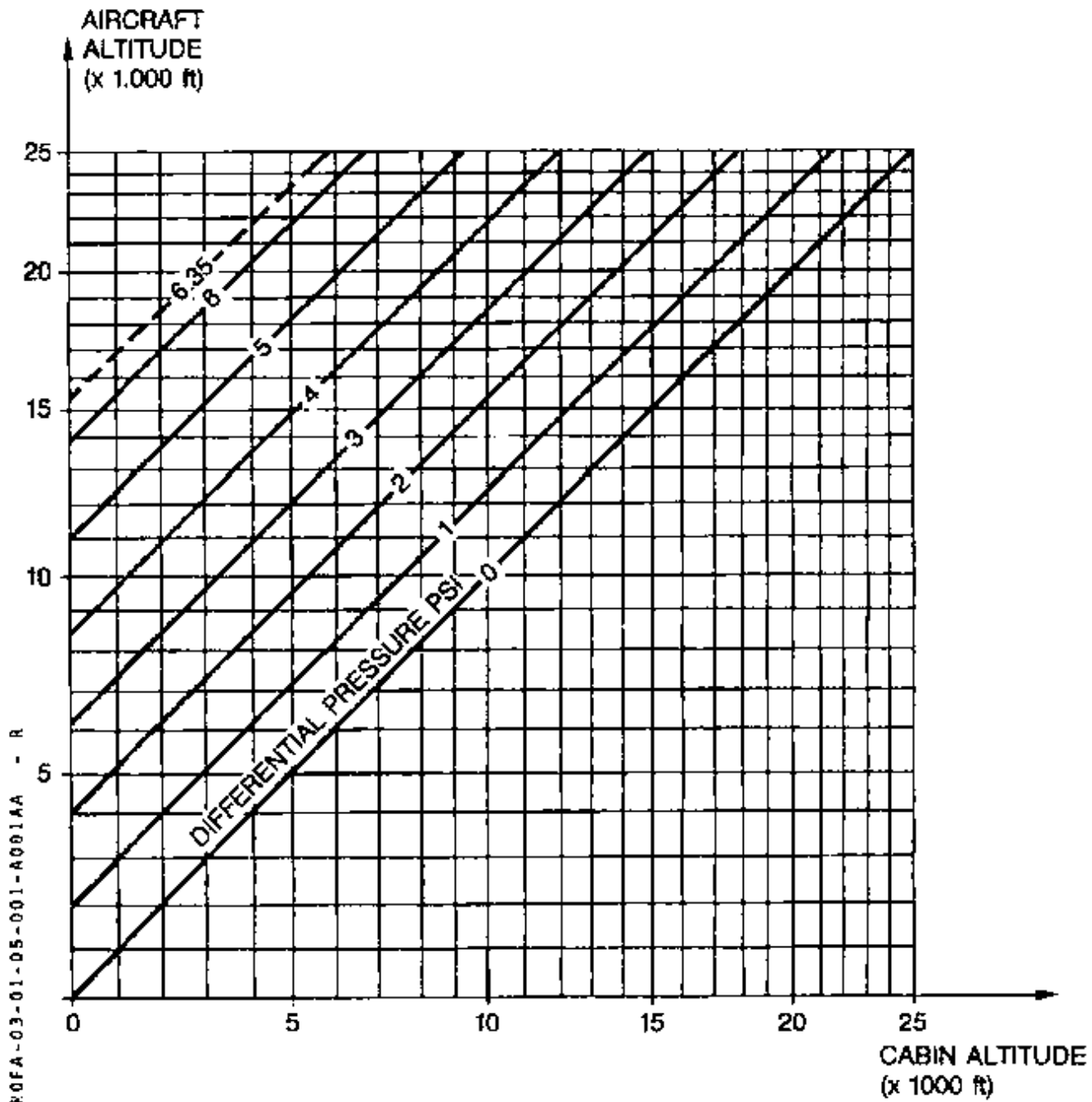

K0FA-03-01-05-001-A001AA - R

	POWER SETTING	3.02.00		
	CONTENTS	P 1	100	
				JUN 97

AA

- 3.02.00 CONTENTS**

- 3.02.01 GENERAL**

- 3.02.02 TORQUE TABLES**
 - TO
 - RTO
 - GA
 - MCT
 - CLB
 - CRZ

	POWER SETTING	3.02.01	
	GENERAL	P 1	500
			JUL 01

AA

INTRODUCTION

The engine power control is achieved by power lever (PL) and condition lever (CL).

These controls act on three main components:

- Propeller Electronic Control or PEC
- Hydromechanical Unit or HMU
- Electronic Control or EEC

The main engine power setting parameter is torque.

The maximum torque value for a given flight phase is defined by the FDAU and displayed by a bug (FDAU target) on torque indicator. The crew has to set the PWR MGT selector to the position corresponding to the flight phase and to set the power lever in the notch or on the ramp in case of GO AROUND or for TO in uptrim inoperative case : in these conditions, the controlled torque matches the maximum target torque displayed by the FDAU (except for TO position : TO power is delivered but RTO power is displayed by the automatic bug).

ENGINE RATINGS

Take-off

This rating corresponds to the normal, derated take-off thrust. It is normally time limited to 5 minutes.

Reserve take-off

This rating corresponds to the maximum thrust certified for take-off. It is automatically selected by the ATPCS system in case of engine failure. Time limit is 10 minutes.

Maximum continuous

The maximum continuous rating corresponds to the maximum thrust certified for continuous use.

IT MUST ONLY BE USED TO ENSURE SAFE FLIGHT IN CASE OF EMERGENCY, PARTICULARLY ENGINE FAILURE.

Maximum climb

The maximum climb rating corresponds to the maximum thrust approved for normal climb operation.

Maximum cruise

The maximum cruise rating corresponds to the maximum thrust approved for normal cruise operation.

Go around

It is the maximum rating authorized for go-around.

 NR72 F.C.O.M.	POWER SETTING GENERAL	3.02.01		
		P 2	150	
				JUN 97

AA

POWER SETTING TABLES

Maximum power setting tables that are provided :

- MUST be used to determine TO torque to be set on the Manual Bugs prior to take-off.
- MUST be used to determine GA torque to be set on the Manual Bugs prior to final.
- Allows crosschecking of MCT / CLB / CRZ maximum torque values normally computed in FDAU as a function of propeller RPM, altitude pressure, Air conditioning status and displayed by the amber FDAU bug.



AR72
F.C.O.M.

POWER SETTING

TORQUE TABLES

3.02.02

P 1

100

JUL 00

AA

R

R

PW127F			TAKE OFF TORQUE											APPLICABLE FOR $0 \leq V_c \leq 60$ kt										
SAT (c)			PROPELLER SPEED 100.0 %																					
AIR COND. OFF	NORMAL AIR COND. ON	HIGH AIR COND. ON	PRESSURE ALTITUDE (FT)																					
			-1000	0	1000	2000	3000	4000	5000	6000	7000	8000	8500											
-40.	-63.		90.0	90.0	90.0	90.0	90.0	90.0	90.0	90.0	90.0	90.0	90.0	90.0	90.0	90.0								
-10.	-27.		90.0	90.0	90.0	90.0	90.0	90.0	90.0	90.0	90.0	90.0	90.0	90.0	90.0	89.7								
-8.	-24.		90.0	90.0	90.0	90.0	90.0	90.0	90.0	90.0	90.0	90.0	90.0	90.0	90.0	88.7								
-6.	-22.		90.0	90.0	90.0	90.0	90.0	90.0	90.0	90.0	90.0	90.0	90.0	89.7	87.8									
-4.	-19.		90.0	90.0	90.0	90.0	90.0	90.0	90.0	90.0	90.0	90.0	90.0	88.7	86.8									
-2.	-17.		90.0	90.0	90.0	90.0	90.0	90.0	90.0	90.0	90.0	90.0	90.0	87.7	85.8									
0.	-14.		90.0	90.0	90.0	90.0	90.0	90.0	90.0	90.0	90.0	90.0	90.0	86.7	84.9									
2.	-12.		90.0	90.0	90.0	90.0	90.0	90.0	90.0	90.0	90.0	90.0	89.3	85.7	83.9									
4.	-10.		90.0	90.0	90.0	90.0	90.0	90.0	90.0	90.0	90.0	90.0	88.3	84.7	82.9									
6.	-7.		90.0	90.0	90.0	90.0	90.0	90.0	90.0	90.0	90.0	90.0	87.2	83.6	81.9									
8.	-5.		90.0	90.0	90.0	90.0	90.0	90.0	90.0	90.0	89.9	86.2	82.6	80.9										
10.	-2.		90.0	90.0	90.0	90.0	90.0	90.0	90.0	90.0	88.8	85.2	81.7	79.9										
12.	0.		90.0	90.0	90.0	90.0	90.0	90.0	90.0	90.0	87.7	84.1	80.7	79.0										
4.	3.		90.0	90.0	90.0	90.0	90.0	90.0	90.0	90.0	86.5	83.0	79.5	77.9										
16.	5.		90.0	90.0	90.0	90.0	90.0	90.0	90.0	88.9	85.2	81.7	78.4	76.7										
18.	8.		90.0	90.0	90.0	90.0	90.0	90.0	90.0	87.5	83.9	80.5	77.1	75.5										
20.	10.		90.0	90.0	90.0	90.0	90.0	90.0	89.6	86.0	82.5	79.1	75.8	74.2										
22.	13.		90.0	90.0	90.0	90.0	90.0	90.0	88.1	84.5	81.0	77.7	74.5	72.9										
24.	15.		90.0	90.0	90.0	90.0	90.0	90.0	86.5	83.0	79.6	76.3	73.2	71.7										
26.	18.		90.0	90.0	90.0	90.0	88.5	85.0	81.5	78.2	75.0	71.9	70.4											
26.	20.		90.0	90.0	90.0	90.0	86.9	83.4	80.0	76.7	73.6	70.5	69.1											
30.	23.		90.0	90.0	90.0	88.8	85.2	81.8	78.5	75.3	72.2	69.2	67.7											
32.	25.		90.0	90.0	90.0	87.1	83.6	80.2	77.0	73.8	70.8	67.9	65.4											
34.	28.		90.0	90.0	88.9	85.4	81.9	78.6	75.4	72.4	69.4	66.5	65.1											
36.	30.		90.0	90.0	87.1	83.7	80.3	77.0	73.9	70.9	68.0	65.2	63.8											
38.	33.		90.0	88.9	85.4	82.0	78.7	75.5	72.4	69.5	66.6	63.8	62.5											
40.	36.		90.0	87.1	83.6	80.3	77.1	73.9	70.9	68.0	65.2													
42.	38.		88.8	85.3	81.9	78.6	75.4	72.4	69.4	66.6														
44.	41.		86.9	83.5	80.1	76.9	73.8	70.8	68.0															
46.	43.		85.0	81.6	78.4	75.3	72.2	69.3																
48.	46.		83.1	79.8	76.6	73.6	70.6																	
50.	48.		81.2	78.0	74.9	71.9																		
52.	51.		79.3	76.2	73.2																			
54.	53.		77.5	74.4																				
55.	54.		76.5	73.5																				

The part above the reinforced line is the flat rated area; engine mechanical limit.

The part below the reinforced line is the area where the thermodynamical limit is reached first.

	POWER SETTING		3.02.02		
			P 2	100	
	TORQUE TABLES				JUN 97

AA

PW127F			RESERVE TAKE OFF TORQUE										VC = 50. KT	
SAT (c)			PROPELLER SPEED 100.0 %											
AIR COND OFF	NORMAL AIR COND ON	HIGH AIR COND ON	PRESSURE ALTITUDE (FT)											
			1000.	0.	1000	2000	3000	4000	5000.	6000.	7000.	8000.	8500.	
-40.	-63	-71.	100.0	100.0	100.0	100.0	100.0	100.0	100.0	100.0	100.0	100.0	100.0	100.0
-10.	-27	-35	100.0	100.0	100.0	100.0	100.0	100.0	100.0	100.0	100.0	100.0	100.0	99.7
-8.	-24	-32	100.0	100.0	100.0	100.0	100.0	100.0	100.0	100.0	100.0	100.0	100.0	98.6
-6.	-22	-30	100.0	100.0	100.0	100.0	100.0	100.0	100.0	100.0	100.0	100.0	99.6	97.5
-4.	-19	-27.	100.0	100.0	100.0	100.0	100.0	100.0	100.0	100.0	100.0	100.0	98.5	96.5
-2.	-17	25.	100.0	100.0	100.0	100.0	100.0	100.0	100.0	100.0	100.0	100.0	97.4	95.4
0.	-14	-22	100.0	100.0	100.0	100.0	100.0	100.0	100.0	100.0	100.0	100.0	96.3	94.3
2.	-12	-19	100.0	100.0	100.0	100.0	100.0	100.0	100.0	100.0	100.0	99.3	95.2	93.2
4.	-10	-17.	100.0	100.0	100.0	100.0	100.0	100.0	100.0	100.0	100.0	98.1	94.1	92.1
6.	-7	-14.	100.0	100.0	100.0	100.0	100.0	100.0	100.0	100.0	100.0	96.9	92.9	91.0
8.	-5.	-12	100.0	100.0	100.0	100.0	100.0	100.0	100.0	100.0	99.9	95.8	91.8	89.9
10.	-2.	-9.	100.0	100.0	100.0	100.0	100.0	100.0	100.0	100.0	98.7	94.6	90.7	88.8
12.	0	-7.	100.0	100.0	100.0	100.0	100.0	100.0	100.0	100.0	97.5	93.5	89.6	87.8
14.	3.	-4.	100.0	100.0	100.0	100.0	100.0	100.0	100.0	100.0	96.1	92.2	88.4	86.5
16.	5	-1.	100.0	100.0	100.0	100.0	100.0	100.0	100.0	98.7	94.7	90.8	87.1	85.3
18.	8.	2.	100.0	100.0	100.0	100.0	100.0	100.0	97.2	93.2	89.4	85.7	83.9	
20.	10	4.	100.0	100.0	100.0	100.0	100.0	99.6	95.5	91.6	87.9	84.3	82.5	
22.	13	7	100.0	100.0	100.0	100.0	100.0	97.9	93.9	90.0	86.4	82.8	81.1	
24.	15	10.	100.0	100.0	100.0	100.0	100.0	96.1	92.2	88.5	84.8	81.3	79.6	
26.	18	13.	100.0	100.0	100.0	100.0	98.4	94.4	90.6	86.9	83.3	79.9	78.2	
28.	20	16	100.0	100.0	100.0	100.0	96.6	92.7	88.9	85.3	81.8	78.4	76.7	
30.	23	18	100.0	100.0	100.0	98.7	94.7	90.9	87.2	83.6	80.2	76.9	75.3	
32.	25	21.	100.0	100.0	100.0	96.8	92.9	89.1	85.5	82.0	78.6	75.4	73.8	
34.	28.	24.	100.0	100.0	98.8	94.9	91.1	87.4	83.8	80.4	77.1	73.9	72.4	
36	30	27	100.0	100.0	96.8	93.0	89.2	85.6	82.1	78.8	75.5	72.4	70.9	
38.	33	30.	100.0	98.8	94.9	91.1	87.4	83.9	80.5	77.2	74.0	70.9	69.5	
40.	36	32	100.0	96.8	92.9	89.2	85.6	82.2	78.8	75.6	72.5			
42.	38	35	98.7	94.8	91.0	87.3	83.8	80.4	77.2	74.0				
44.	41	38	96.6	92.7	89.0	85.5	82.0	78.7	75.5					
46.	43	41	94.4	90.7	87.1	83.6	80.2	77.0						
48.	46	43	92.3	88.7	85.2	81.8	78.5							
50.	48.	46.	90.3	86.7	83.2	79.9								
52.	51.	49.	88.2	84.7	81.3									
54.	53.	52	86.1	82.7										
55.	54.	53.	85.0	81.7										

The part above the reinforced line is the flat rated area; engine mechanical limit.

The part below the reinforced line is the area where the thermodynamical limit is reached first.

	POWER SETTING		3.02.02		
			P 3	100	
	TORQUE TABLES				JUL 00

AA

PW127F			GO AROUND TORQUE											APPLICABLE FOR $V_c \leq 125$ kt	
TAT (c)			PROPELLER SPEED 100.0 %												
AIR COND OFF	NORMAL AIR COND ON	HIGH AIR COND ON	PRESSURE ALTITUDE (FT)												
			-1000.	0	1000	2000	3000	4000.	5000.	6000.	7000	8000.	8500.		
-40.	-63.	-71	100.0	100.0	100.0	100.0	100.0	100.0	100.0	100.0	100.0	100.0	100.0	100.0	100.0
-10.	-27.	-35.	100.0	100.0	100.0	100.0	100.0	100.0	100.0	100.0	100.0	100.0	100.0	100.0	99.9
-8.	-24	-32	100.0	100.0	100.0	100.0	100.0	100.0	100.0	100.0	100.0	100.0	100.0	100.0	98.8
-6.	22.	-30	100.0	100.0	100.0	100.0	100.0	100.0	100.0	100.0	100.0	100.0	100.0	99.8	97.8
-4.	-19	-27	100.0	100.0	100.0	100.0	100.0	100.0	100.0	100.0	100.0	100.0	100.0	98.7	96.7
-2.	17	-25.	100.0	100.0	100.0	100.0	100.0	100.0	100.0	100.0	100.0	100.0	100.0	97.6	95.6
0.	-14.	-22.	100.0	100.0	100.0	100.0	100.0	100.0	100.0	100.0	100.0	100.0	100.0	96.5	94.5
2.	-12.	-19.	100.0	100.0	100.0	100.0	100.0	100.0	100.0	100.0	100.0	100.0	99.5	95.4	93.4
4.	-10.	-17.	100.0	100.0	100.0	100.0	100.0	100.0	100.0	100.0	100.0	100.0	98.3	94.3	92.3
6.	-7.	-14	100.0	100.0	100.0	100.0	100.0	100.0	100.0	100.0	100.0	100.0	97.2	93.2	91.2
8.	-5	-12	100.0	100.0	100.0	100.0	100.0	100.0	100.0	100.0	100.0	96.0	92.1	90.1	
10.	-2	-9.	100.0	100.0	100.0	100.0	100.0	100.0	100.0	100.0	98.9	94.9	91.0	89.1	
12.	0	-7	100.0	100.0	100.0	100.0	100.0	100.0	100.0	100.0	97.7	93.7	89.9	88.0	
14.	3.	-4.	100.0	100.0	100.0	100.0	100.0	100.0	100.0	100.0	96.4	92.5	88.7	86.8	
16.	5.	1.	100.0	100.0	100.0	100.0	100.0	100.0	100.0	99.0	95.0	91.1	87.4	85.5	
18.	8	2.	100.0	100.0	100.0	100.0	100.0	100.0	100.0	97.5	93.6	89.7	86.0	84.3	
20.	10.	4.	100.0	100.0	100.0	100.0	100.0	100.0	99.9	95.9	92.0	88.2	84.6	82.8	
22.	13	7.	100.0	100.0	100.0	100.0	100.0	100.0	98.2	94.2	90.4	86.7	83.1	81.4	
24.	15	10	100.0	100.0	100.0	100.0	100.0	100.0	96.5	92.6	88.8	85.2	81.7	79.9	
26.	18	13	100.0	100.0	100.0	100.0	98.7	94.7	90.9	87.2	83.6	80.2	78.5		
28.	20	16.	100.0	100.0	100.0	100.0	96.9	93.0	89.2	85.6	82.1	78.7	77.1		
30.	23	18.	100.0	100.0	100.0	99.0	95.1	91.2	87.5	84.0	80.5	77.2	75.6		
32.	25	21	100.0	100.0	100.0	97.1	93.2	89.5	85.9	82.4	79.0	75.7	74.2		
34.	28	24.	100.0	100.0	99.2	95.2	91.4	87.7	84.2	80.7	77.4	74.3	72.7		
36.	30	27	100.0	100.0	97.2	93.3	89.6	86.0	82.5	79.1	75.9	72.8	71.2		
38.	33	30.	100.0	99.2	95.2	91.4	87.8	84.2	80.8	77.5	74.3	71.3	69.8		
40.	36	32	100.0	97.1	93.3	89.6	86.0	82.5	79.2	75.9	72.8	69.8	68.4		
42.	38	35	99.0	95.1	91.3	87.7	84.2	80.8	77.5	74.4	71.3				
44.	41	38.	96.9	93.1	89.4	85.8	82.4	79.1	75.9	72.8					
46.	43	41	94.8	91.1	87.5	84.0	80.6	77.4	74.2						
48.	46	43	92.7	89.1	85.5	82.1	78.8	75.7							
50.	48	46	90.6	87.1	83.6	80.3	77.0								
52.	51	49	88.5	85.0	81.7	78.4									
54.	53.	52	86.4	83.0	79.7										
56.	55	54.	84.4	81.0											

The part above the reinforced line is the flat rated area; engine mechanical limit.

The part below the reinforced line is the area where the thermodynamical limit is reached first.

Note : Add 0,8 % for each 10 kt above 125 kt without exceeding 100 % torque.



ATR 72
F.C.O.M.

POWER SETTING

TORQUE TABLES

3.02.02

P 4

500

DEC 97

AA

PW127F			MAXIMUM CONTINUOUS TORQUE													VC = 120. KT	
TAT (c)			PROPELLER SPEED 100.0 %														
AIR COND. OFF	NORMAL AIR COND. ON	HIGH AIR COND. ON	PRESSURE ALTITUDE (FT)														
			0 25000	2000	4000	6000	8000	10000	12000	14000	16000	18000	20000	22000	24000		
-43.	-56.	-67.	90.9	90.9	90.9	90.9	90.9	90.9	90.9	90.9	90.9	86.8	79.9	73.8	67.9	62.3	59.7
-40.	-52.	-63.	90.9	90.9	90.9	90.9	90.9	90.9	90.9	90.9	90.9	85.4	78.6	72.6	66.8	61.3	58.7
-37.	-48.	-59.	90.9	90.9	90.9	90.9	90.9	90.9	90.9	90.9	90.9	84.0	77.3	71.4	65.6	60.3	57.7
-33.	-44.	-55.	90.9	90.9	90.9	90.9	90.9	90.9	90.9	90.9	89.7	82.6	76.0	70.2	64.5	59.2	56.7
-29.	-40.	-50.	90.9	90.9	90.9	90.9	90.9	90.9	90.9	90.9	88.0	81.0	74.6	68.8	63.3	58.1	55.6
-25.	-36.	-46.	90.9	90.9	90.9	90.9	90.9	90.9	90.9	90.9	86.1	79.2	72.9	67.3	61.9	56.8	54.4
-21.	-32.	-42.	90.9	90.9	90.9	90.9	90.9	90.9	90.9	90.9	84.2	77.5	71.3	65.8	60.6	55.6	53.2
-17.	-28.	-38.	90.9	90.9	90.9	90.9	90.9	90.9	90.9	89.7	82.7	76.1	70.0	64.7	59.5	54.6	52.3
-13.	24.	-33.	90.9	90.9	90.9	90.9	90.9	90.9	90.9	88.1	81.2	74.7	68.8	63.5	58.4	53.6	51.3
-10.	20.	-29.	90.9	90.9	90.9	90.9	90.9	90.9	90.9	86.6	79.7	73.3	67.5	62.3	57.3	52.6	50.4
-6.	-16.	-24.	90.9	90.9	90.9	90.9	90.9	90.9	90.9	84.9	78.2	71.9	66.2	61.1	56.2	51.6	49.4
-2.	-12.	-20.	90.9	90.9	90.9	90.9	90.9	90.9	90.3	83.2	76.7	70.6	65.0	60.0	55.2	50.6	48.5
1.	-8.	-16.	90.9	90.9	90.9	90.9	90.9	90.9	88.7	81.8	75.3	69.3	63.8	58.9	54.2	49.7	47.6
4.	4.	11.	90.9	90.9	90.9	90.9	90.9	90.9	86.9	80.1	73.8	67.9	62.5	57.7	53.1	48.7	46.7
8.	0.	-7.	90.9	90.9	90.9	90.9	90.9	90.9	84.5	77.9	71.8	66.1	60.8	56.1	51.6	47.4	45.4
11.	4.	-2.	90.9	90.9	90.9	90.9	89.6	82.8	76.3	70.3	64.7	59.6	55.0	50.6	46.4	44.5	
15.	8.	2.	90.9	90.9	90.9	90.9	87.9	81.2	74.8	68.9	63.4	58.4	53.9	49.6	45.5	43.6	
18.	12.	7.	90.9	90.9	90.9	90.9	86.2	79.5	73.3	67.6	62.2	57.2	52.8	48.6	44.6		
22.	16.	12.	90.9	90.9	90.9	90.9	84.4	77.9	71.9	66.2	60.9	56.1	51.8				
25.	20.	16.	90.9	90.9	90.9	88.2	81.6	75.3	69.5	64.0	58.9	54.2					
29.	24.	21.	90.9	90.9	90.9	84.9	78.6	72.5	66.9	61.6	56.7						
33.	28.	25.	90.9	90.9	86.0	81.6	75.5	69.7	64.3	59.2							
37.	32.	29.	90.9	90.9	84.7	78.6	72.7	67.1	61.9								
41.	36.	33.	90.9	88.5	82.2	76.3	70.6	65.1									
44.	40.	38.	90.9	85.8	79.7	74.0	68.4										
48.	44.	42.	89.5	83.2	77.3	71.7											
52.	48.	46.	86.6	80.5	74.8												
56.	52.	50.	83.7	77.8													
60.	56.	54.	82.1														
64.	60.	58.															

The part above the reinforced line is the flat rated area; engine mechanical limit.

The part below the reinforced line is the area where the thermodynamical limit is reached first.

	POWER SETTING						3.02.02		
	TORQUE TABLES						P 5	500	
									DEC 97

AA

PW127F			MAXIMUM CLIMB TORQUE													VC = 170. KT	
TAT (c)			PROPELLER SPEED 82.0 %														
AIR COND. OFF	NORMAL AIR COND ON	HIGH AIR COND ON	PRESSURE ALTITUDE (FT)														
			0 25000	2000	4000	6000	8000	10000	12000	14000	16000	18000	20000	22000	24000		
-41.	-56	-64.	97.2	97.2	97.2	97.2	97.2	97.2	97.2	97.2	97.2	94.0	87.0	80.3	74.2	68.5	65.8
-38.	-52	-60.	97.2	97.2	97.2	97.2	97.2	97.2	97.2	97.2	97.2	92.5	85.6	79.0	73.0	67.4	64.7
-34.	-48	-56.	97.2	97.2	97.2	97.2	97.2	97.2	97.2	97.2	97.2	90.9	84.1	77.7	71.8	66.2	63.6
-30.	-44	-51.	97.2	97.2	97.2	97.2	97.2	97.2	97.2	97.2	95.9	89.4	82.7	76.4	70.5	65.1	62.5
-26.	40.	-47	97.2	97.2	97.2	97.2	97.2	97.2	97.2	97.2	94.2	87.8	81.2	75.0	69.3	63.9	61.4
-23.	-36	-43.	97.2	97.2	97.2	97.2	97.2	97.2	97.2	92.4	86.2	79.7	73.7	68.0	62.8	60.3	
-19.	-32	-39.	97.2	97.2	97.2	97.2	97.2	97.2	96.8	90.8	84.7	78.3	72.3	66.8	61.7	59.2	
-15.	-28	-35.	97.2	97.2	97.2	97.2	97.2	97.2	95.3	89.3	83.3	77.0	71.2	65.7	60.7	58.3	
-11.	-24	-31.	97.2	97.2	97.2	97.2	97.2	97.2	93.7	87.9	81.9	75.8	70.0	64.6	59.7	57.3	
-7.	-20	-26.	97.2	97.2	97.2	97.2	97.2	97.2	92.0	86.2	80.4	74.4	68.7	63.4	58.6	56.3	
-4.	-16.	-22	97.2	97.2	97.2	97.2	97.2	96.0	90.2	84.6	78.9	73.0	67.4	62.2	57.4	55.2	
-1.	12	-18.	97.2	97.2	97.2	97.2	97.2	94.2	88.5	83.0	77.3	71.5	66.1	61.0	56.3	54.1	
3.	8	-14	97.2	97.2	97.2	97.2	97.2	92.0	86.4	81.0	75.5	69.9	64.6	59.6	55.0	52.9	
6.	-4	-10	97.2	97.2	97.2	97.2	96.6	89.7	84.3	79.1	73.7	68.2	63.0	58.1	53.7	51.6	
9.	0.	5.	97.2	97.2	97.2	97.2	93.9	87.2	81.9	76.8	71.6	66.3	61.2	56.5	52.2	50.1	
12.	4	1	97.2	97.2	97.2	97.2	91.0	84.5	79.4	74.5	69.4	64.2	59.3	54.8	50.6	48.6	
16.	8	3	97.2	97.2	97.2	94.9	88.1	81.9	76.9	72.1	67.2	62.2	57.5	53.1	49.0	47.1	
19.	12	8	97.2	97.2	97.2	91.9	85.3	79.2	74.4	69.8	65.0	60.2	55.6	51.3	47.4	45.5	
22.	16	12.	97.2	97.2	95.6	88.8	82.4	76.5	71.9	67.4	62.9	58.2	53.7	49.6	45.8		
26.	20	17.	97.2	97.2	92.1	85.6	79.4	73.8	69.3	65.0	60.6	56.1	51.8	47.8			
29.	24	21	97.2	95.5	88.6	82.3	76.4	71.0	66.7	62.5	58.3	53.9					
33.	28	25	97.2	91.8	85.2	79.1	73.4	68.2	64.1	60.1	56.0						
36.	32	29	95.3	88.4	82.1	76.2	70.8	65.7	61.8	57.9							
40.	36	33	91.7	85.0	79.0	73.3	68.1	63.2	59.4								
43.	40.	38.	88.2	81.8	75.9	70.5	65.5	60.8									
47.	44	42	84.7	78.6	73.0	67.8	62.9										
50.	48	46.	81.3	75.4	70.0	65.0											
54.	52	50	77.8	72.2	67.0												
58.	56	54.	75.6														
62.	60	58.															

The part above the reinforced line is the flat rated area; engine mechanical limit.

The part below the reinforced line is the area where the thermodynamical limit is reached first.

	POWER SETTING						3.02.02		
	TORQUE TABLES						P 6	500	
									DEC 97

AA

PW127F			MAXIMUM CLIMB TORQUE													VC = 190. KT		
TAT (c)			PROPELLER SPEED 82.0 %															
AIR COND. OFF	NOR-MAL AIR COND. ON	HIGH AIR COND. ON	PRESSURE ALTITUDE (FT)															
			0 25000.	2000	4000	6000	8000	10000	12000	14000	16000	18000	20000	22000	24000			
-41.	-56.	-64.	97.2	97.2	97.2	97.2	97.2	97.2	97.2	97.2	97.2	97.2	97.2	90.2	83.6	77.4	71.7	66.0
-38.	-52.	-60.	97.2	97.2	97.2	97.2	97.2	97.2	97.2	97.2	97.2	95.7	88.8	82.3	76.2	70.6	67.9	
-34.	-48.	-56.	97.2	97.2	97.2	97.2	97.2	97.2	97.2	97.2	97.2	94.1	87.3	80.9	74.9	69.4	66.8	
-30.	-44.	-51.	97.2	97.2	97.2	97.2	97.2	97.2	97.2	97.2	97.2	92.5	85.8	79.5	73.6	68.2	65.6	
-26.	40.	-47.	97.2	97.2	97.2	97.2	97.2	97.2	97.2	97.2	96.9	90.8	84.2	78.1	72.3	67.0	64.5	
-23.	-36.	-43.	97.2	97.2	97.2	97.2	97.2	97.2	97.2	97.2	95.1	89.2	82.7	76.7	71.0	65.8	63.3	
-19.	-32.	-39.	97.2	97.2	97.2	97.2	97.2	97.2	97.2	97.2	93.4	87.6	81.2	75.3	69.7	64.6	62.2	
-15.	-28.	-35.	97.2	97.2	97.2	97.2	97.2	97.2	97.2	97.2	91.9	86.2	79.9	74.1	68.6	63.5	61.2	
-11.	-24.	31	97.2	97.2	97.2	97.2	97.2	97.2	97.2	96.2	90.4	84.7	78.6	72.8	67.5	62.5	60.2	
-7.	-20.	-26.	97.2	97.2	97.2	97.2	97.2	97.2	97.2	94.4	88.7	83.2	77.2	71.5	66.2	61.4	59.0	
-4.	-16.	-22.	97.2	97.2	97.2	97.2	97.2	97.2	97.2	92.6	87.0	81.6	75.7	70.1	65.0	60.2	57.9	
-1.	-12.	-18.	97.2	97.2	97.2	97.2	97.2	97.2	96.6	90.8	85.4	80.0	74.2	68.8	63.7	59.0	56.8	
3.	-8	-14	97.2	97.2	97.2	97.2	97.2	97.2	94.4	88.7	83.4	78.2	72.5	67.2	62.2	57.6	55.5	
6.	-4.	-10.	97.2	97.2	97.2	97.2	97.2	97.2	92.1	86.5	81.3	76.2	70.7	65.5	60.7	56.2	54.1	
9.	0	-5.	97.2	97.2	97.2	97.2	96.3	89.5	84.1	79.0	74.1	68.7	63.7	59.0	54.6	52.6		
12.	4.	1	97.2	97.2	97.2	97.2	93.3	86.7	81.5	76.6	71.8	66.6	61.8	57.2	53.0	51.0		
16.	8.	3	97.2	97.2	97.2	97.2	90.4	84.0	78.9	74.2	69.6	64.5	59.8	55.4	51.3	49.4		
19.	12.	8	97.2	97.2	97.2	94.0	87.4	81.3	76.4	71.8	67.3	62.4	57.9	53.6	49.6	47.8		
22.	16.	12.	97.2	97.2	97.2	90.9	84.5	78.5	73.8	69.4	65.0	60.3	55.9	51.8	48.0	46.2		
26.	20	17	97.2	97.2	94.2	87.6	81.5	75.7	71.2	66.9	62.7	58.2	53.9	49.9				
29.	24.	21	97.2	97.2	90.6	84.3	78.4	72.8	68.5	64.4	60.3	56.0	51.9					
33.	28.	25	97.2	93.7	87.1	81.0	75.3	70.0	65.8	61.8	58.0	53.8						
36.	32	29	97.2	90.3	83.9	78.0	72.6	67.4	63.4	59.6	55.9							
40.	36.	33	93.5	86.8	80.7	75.1	69.8	64.9	61.0									
43.	40.	38	89.9	83.5	77.6	72.2	67.1	62.4										
47.	44.	42	86.4	80.3	74.6	69.4	64.6											
50.	48.	46	82.9	77.0	71.6	66.6												
54.	52.	50	79.3	73.7	68.5													
58.	56.	54	77.1	71.7														
62.	60.	58	77.1															

The part above the reinforced line is the flat rated area; engine mechanical limit.

The part below the reinforced line is the area where the thermodynamical limit is reached first.

	POWER SETTING				3.02.02		
					P 7	500	
	TORQUE TABLES						DEC 97

AN

PW127F			MAXIMUM CRUISE TORQUE										VC = 170. KT	
TAT (c)			PROPELLER SPEED 82.0 %											
AIR COND. OFF	NORMAL AIR COND. ON	HIGH AIR COND. ON	PRESSURE ALTITUDE (FT)											
			0.	5000.	7500.	10000.	12500.	15000.	17500.	20000.	22500.	25000.		
-38.	-56.	-66.	94.5	94.5	94.5	94.5	94.5	94.1	85.6	77.7	70.4	63.8		
-35.	-52.	-62.	94.5	94.5	94.5	94.5	94.5	92.5	84.2	76.4	69.3	62.8		
-32.	-48.	-58.	94.5	94.5	94.5	94.5	94.5	91.1	82.8	75.1	68.1	61.8		
-29.	-44.	-54.	94.5	94.5	94.5	94.5	94.5	89.5	81.4	73.8	67.0	60.7		
-25.	-40.	-49.	94.5	94.5	94.5	94.5	93.9	87.9	80.0	72.5	65.8	59.6		
-22.	-36.	-45.	94.5	94.5	94.5	94.5	92.2	86.3	78.5	71.2	64.6	58.5		
-19.	-32.	-41.	94.5	94.5	94.5	94.5	90.6	84.8	77.1	69.9	63.4	57.5		
-16.	-28.	-37.	94.5	94.5	94.5	94.5	89.1	83.4	75.8	68.8	62.4	56.6		
-13.	-24.	-32.	94.5	94.5	94.5	94.5	87.6	82.0	74.6	67.7	61.3	55.6		
-9.	-20.	-28.	94.5	94.5	94.5	94.5	86.0	80.5	73.2	66.4	60.2	54.6		
-6.	-16.	-23.	94.5	94.5	94.5	92.7	84.4	79.0	71.8	65.2	59.1	53.6		
-3.	-12.	-19.	94.5	94.5	94.5	90.9	82.7	77.4	70.4	63.9	57.9	52.5		
0.	-8.	-14.	94.5	94.5	94.5	88.8	80.8	75.6	68.8	62.4	56.6	51.3		
4.	-4.	-10.	94.5	94.5	94.5	86.6	78.8	73.8	67.1	60.9	55.2	50.0		
7.	0.	-5.	94.5	94.5	92.6	84.2	76.6	71.7	65.2	59.1	53.6	48.6		
10.	4.	-1.	94.5	94.5	89.7	81.6	74.3	69.5	63.2	57.3	52.0	47.1		
13.	8.	4.	94.5	94.5	86.8	79.0	71.9	67.3	61.2	55.5	50.3	45.6		
17.	12.	8.	94.5	91.8	83.6	76.0	69.1	64.7	58.9	53.4	48.4	43.9		
20.	16.	12.	94.5	88.2	80.3	73.0	66.4	62.2	56.5	51.3	46.5			
23.	20.	17.	94.5	84.8	77.2	70.2	63.9	59.8	54.4	49.3				
27.	24.	21.	94.5	81.5	74.2	67.5	61.4	57.5	52.3					
31.	28.	26.	94.3	78.3	71.2	64.8	59.0	55.2						
35.	32.	30.	90.6	75.2	68.5	62.2	56.6	53.0						
38.	36.	34.	86.9	72.2	65.7	59.7	54.3							
42.	40.	38.	83.2	69.1	62.9	57.2								
46.	44.	42.	79.5	66.0	60.1									
50.	48.	47.	75.9	63.0										
54.	52.	51.	72.1											
58.	56.	55.	69.8											
62.	60.	59.												

The part above the reinforced line is the flat rated area; engine mechanical limit.

The part below the reinforced line is the area where the thermodynamical limit is reached first.



POWER SETTING

3.02.02

P 8

500

TORQUE TABLES

DEC 97

AA

PW127F			MAXIMUM CRUISE TORQUE										VC = 190. KT			
TAT (c)			PROPELLER SPEED 82.0 %													
AIR COND. OFF	NORMAL AIR COND. ON	HIGH AIR COND. ON	PRESSURE ALTITUDE (FT)													
			0.	5000.	7500.	10000.	12500.	15000.	17500.	20000.	22500.	25000.				
-38.	-56.	-66.	94.5	94.5	94.5	94.5	94.5	94.5	94.5	88.9	81.0	73.7	67.2			
-35.	-52.	-62.	94.5	94.5	94.5	94.5	94.5	94.5	94.5	87.5	79.7	72.5	66.1			
-32.	-48.	-58.	94.5	94.5	94.5	94.5	94.5	94.5	93.7	86.0	78.3	71.3	65.0			
-29.	-44.	-54.	94.5	94.5	94.5	94.5	94.5	94.5	92.1	84.6	77.0	70.1	63.9			
-25.	-40.	-49.	94.5	94.5	94.5	94.5	94.5	94.5	90.5	83.1	75.6	68.9	62.7			
-22.	-36.	-45.	94.5	94.5	94.5	94.5	94.5	94.5	88.8	81.6	74.2	67.6	61.6			
-19.	-32.	-41.	94.5	94.5	94.5	94.5	94.5	93.3	87.2	80.1	72.9	66.4	60.5			
-16.	-28.	-37.	94.5	94.5	94.5	94.5	94.5	91.8	85.8	78.8	71.7	65.3	59.5			
-13.	-24.	-32.	94.5	94.5	94.5	94.5	94.5	90.3	84.4	77.5	70.6	64.2	58.5			
-9.	-20.	-28.	94.5	94.5	94.5	94.5	94.5	88.6	82.9	76.1	69.3	63.1	57.4			
-6.	-16.	-23.	94.5	94.5	94.5	94.5	94.5	87.0	81.3	74.6	67.9	61.9	56.4			
-3.	-12.	-19.	94.5	94.5	94.5	93.6	85.3	79.7	73.2	66.6	60.7	55.3				
0.	-8.	-14.	94.5	94.5	94.5	91.4	83.3	77.9	71.5	65.1	59.3	54.0				
4.	-4.	-10.	94.5	94.5	94.5	89.2	81.2	75.9	69.7	63.5	57.8	52.6				
7.	0.	-5.	94.5	94.5	94.5	86.6	78.9	73.8	67.7	61.7	56.2	51.2				
10.	4.	-1.	94.5	94.5	92.2	84.0	76.5	71.5	65.7	59.8	54.4	49.6				
13.	8.	4.	94.5	94.5	89.2	81.3	74.1	69.2	63.6	57.9	52.7	48.0				
17.	12.	8.	94.5	94.1	85.8	78.2	71.3	66.6	61.2	55.7	50.7	46.2				
20.	16.	12.	94.5	90.4	82.4	75.1	68.4	64.0	58.7	53.5	48.7	44.4				
23.	20.	17.	94.5	86.9	79.2	72.2	65.8	61.5	56.5	51.4	46.8					
27.	24.	21.	94.5	83.5	76.2	69.4	63.3	59.1	54.3	49.4						
31.	28.	26.	94.5	80.2	73.2	66.7	60.8	56.8	52.1							
35.	32.	30.	92.5	77.1	70.3	64.1	58.4	54.6								
38.	36.	34.	88.7	73.9	67.4	61.5	56.0									
42.	40.	38.	84.9	70.8	64.6	58.8										
46.	44.	42.	81.2	67.7	61.7											
50.	48.	47.	77.4	64.5												
54.	52.	51.	73.6													
58.	56.	55.	71.2													
62.	60.	59.	71.2													

The part above the reinforced line is the flat rated area; engine mechanical limit.

The part below the reinforced line is the area where the thermodynamical limit is reached first.

	POWER SETTING		3.02.02		
			P 9	500	
	TORQUE TABLES				DEC 97

AA

PW127F			MAXIMUM CRUISE TORQUE										VC = 210. KT	
TAT (c)			PROPELLER SPEED 82.0 %											
AIR COND OFF	NORMAL AIR COND ON	HIGH AIR COND ON	PRESSURE ALTITUDE (FT)											
			0.	5000.	7500.	10000.	12500.	15000.	17500.	20000.	22500.	25000.		
-38.	-56.	-66.	94.5	94.5	94.5	94.5	94.5	94.5	94.5	92.8	84.8	77.5	71.0	
-35.	-52.	-62.	94.5	94.5	94.5	94.5	94.5	94.5	94.5	91.3	83.4	76.3	69.8	
-32.	-48.	-58.	94.5	94.5	94.5	94.5	94.5	94.5	94.5	89.7	82.0	75.0	68.7	
-29.	-44.	-54.	94.5	94.5	94.5	94.5	94.5	94.5	94.5	88.2	80.6	73.7	67.5	
-25.	-40.	-49.	94.5	94.5	94.5	94.5	94.5	94.5	93.4	86.6	79.2	72.4	66.3	
-22.	-36.	-45.	94.5	94.5	94.5	94.5	94.5	94.5	91.7	85.0	77.7	71.1	65.1	
-19.	-32.	-41.	94.5	94.5	94.5	94.5	94.5	94.5	90.0	83.5	76.4	69.8	63.9	
-16.	-28.	-37.	94.5	94.5	94.5	94.5	94.5	94.5	88.6	82.2	75.1	68.7	62.9	
-13.	-24.	-32.	94.5	94.5	94.5	94.5	94.5	93.5	87.1	80.8	73.9	67.6	61.8	
-9.	-20.	-28.	94.5	94.5	94.5	94.5	94.5	91.8	85.5	79.3	72.5	66.3	60.7	
-6.	-16.	-23.	94.5	94.5	94.5	94.5	94.5	90.0	83.9	77.8	71.1	65.1	59.5	
-3.	-12.	-19.	94.5	94.5	94.5	94.5	94.5	88.3	82.2	76.3	69.8	63.8	58.4	
0.	-8.	-14.	94.5	94.5	94.5	94.4	86.3	80.3	74.5	68.1	62.3	57.0		
4.	-4.	-10.	94.5	94.5	94.5	92.1	84.1	78.3	72.7	66.4	60.8	55.6		
7.	0.	-5.	94.5	94.5	94.5	89.5	81.7	76.1	70.6	64.6	59.1	54.1		
10.	4.	-1.	94.5	94.5	94.5	86.7	79.2	73.8	68.5	62.6	57.3	52.4		
13.	8.	4.	94.5	94.5	91.8	83.9	76.7	71.4	66.3	60.6	55.4	50.7		
17.	12.	8.	94.5	94.5	88.4	80.7	73.8	68.7	63.8	58.3	53.3	48.8		
20.	16.	12.	94.5	92.8	84.9	77.6	70.9	66.0	61.3	56.0	51.2	46.9		
23.	20.	17.	94.5	89.3	81.6	74.6	68.1	63.5	58.9	53.8	49.2	45.1		
27.	24.	21.	94.5	85.8	78.5	71.7	65.5	61.0	56.6	51.8				
31.	28.	26.	94.5	82.4	75.3	68.9	62.9	58.6	54.4					
35.	32.	30.	94.5	79.2	72.4	66.2	60.4	56.3						
38.	36.	34.	90.7	75.9	69.4	63.5	58.0							
42.	40.	38.	86.9	72.7	66.5	60.8								
46.	44.	42.	83.0	69.5	63.5	58.1								
50.	48.	47.	79.2	66.3	60.6									
54.	52.	51.	75.3	63.0										
58.	56.	55.	72.9											
62.	60.	59.	72.9											

The part above the reinforced line is the flat rated area; engine mechanical limit.

The part below the reinforced line is the area where the thermodynamical limit is reached first.

	POWER SETTING				3.02.02		
					P 10	500	
	TORQUE TABLES						DEC 97

AA

PW127F			MAXIMUM CRUISE TORQUE										VC = 230. KT						
TAT (c)			PROPELLER SPEED 82.0 %																
AIR COND. OFF	NORMAL AIR COND ON	HIGH AIR COND ON	PRESSURE ALTITUDE (FT)																
			0.	5000.	7500.	10000.	12500.	15000.	17500.	20000.	22500.	25000.							
-38.	-56.	-66.	94.5	94.5	94.5	94.5	94.5	94.5	94.5	94.5	89.1	81.9	75.3						
-35.	-52.	-62.	94.5	94.5	94.5	94.5	94.5	94.5	94.5	94.5	87.7	80.5	74.1						
-32.	-48.	-58.	94.5	94.5	94.5	94.5	94.5	94.5	94.5	93.9	86.2	79.2	72.9						
-29.	-44.	-54.	94.5	94.5	94.5	94.5	94.5	94.5	94.5	92.3	84.7	77.8	71.6						
-25.	-40.	-49.	94.5	94.5	94.5	94.5	94.5	94.5	94.5	90.6	83.2	76.4	70.3						
-22.	-36.	-45.	94.5	94.5	94.5	94.5	94.5	94.5	94.5	89.0	81.7	75.1	69.0						
-19.	-32.	-41.	94.5	94.5	94.5	94.5	94.5	94.5	93.1	87.4	80.2	73.7	67.8						
-16.	-28.	-37.	94.5	94.5	94.5	94.5	94.5	94.5	91.6	86.0	78.9	72.5	66.7						
-13.	-24.	-32.	94.5	94.5	94.5	94.5	94.5	94.5	90.1	84.6	77.6	71.3	65.6						
-9.	-20.	-28.	94.5	94.5	94.5	94.5	94.5	94.5	88.4	83.0	76.2	70.0	64.4						
-6.	-16.	-23.	94.5	94.5	94.5	94.5	93.5	86.8	81.4	74.7	68.7	63.2							
-3.	-12.	-19.	94.5	94.5	94.5	94.5	91.7	85.1	79.8	73.3	67.3	62.0							
0.	-8.	-14.	94.5	94.5	94.5	94.5	89.6	83.1	78.0	71.6	65.8	60.5							
4.	-4.	-10.	94.5	94.5	94.5	94.5	87.4	81.1	76.1	69.8	64.2	59.0							
7.	0.	-5.	94.5	94.5	94.5	92.6	84.9	78.8	73.9	67.9	62.3	57.4							
10.	4.	-1.	94.5	94.5	94.5	89.8	82.3	76.4	71.7	65.8	60.4	55.6							
13.	8.	4.	94.5	94.5	94.5	86.9	79.7	73.9	69.3	63.7	58.5	53.8							
17.	12.	8.	94.5	94.5	91.2	83.6	76.6	71.1	66.7	61.3	56.3	51.8							
20.	16.	12.	94.5	94.5	87.6	80.3	73.6	68.3	64.1	58.8	54.1	49.7							
23.	20.	17.	94.5	91.9	84.2	77.2	70.8	65.7	61.6	56.6	52.0	47.8							
27.	24.	21.	94.5	88.4	81.0	74.2	68.1	63.1	59.3	54.4	50.0								
31.	28.	26.	94.5	84.9	77.8	71.3	65.4	60.6	56.9	52.2									
35.	32.	30.	94.5	81.5	74.7	68.5	62.8	58.2	54.7										
38.	36.	34.	93.0	78.2	71.7	65.7	60.2	55.9											
42.	40.	38.	89.1	74.9	68.6	62.9	57.7												
46.	44.	42.	85.1	71.6	65.6	60.1													
50.	48.	47.	81.2	68.2	62.6														
54.	52.	51.	77.2	64.9															
58.	56.	55.	74.7																
62.	60.	59.	74.7																

The part above the reinforced line is the flat rated area; engine mechanical limit.

The part below the reinforced line is the area where the thermodynamical limit is reached first.

	POWER SETTING				3.02.02		
					P 11	500	
	TORQUE TABLES						DEC 97

AA

PW127F			MAXIMUM CRUISE TORQUE										VC = 250. KT	
TAT (c)			PROPELLER SPEED 82.0 %											
AIR COND. OFF	NORMAL AIR COND. ON	HIGH AIR COND. ON	PRESSURE ALTITUDE (FT)											
			0.	5000.	7500.	10000.	12500.	15000.	17500.	20000.	22500.	25000.		
-38.	-56.	-66.	94.5	94.5	94.5	94.5	94.5	94.5	94.5	94.5	94.0	86.7	80.2	
-35.	-52.	-62.	94.5	94.5	94.5	94.5	94.5	94.5	94.5	94.5	92.4	85.3	78.9	
-32.	-48.	-58.	94.5	94.5	94.5	94.5	94.5	94.5	94.5	94.5	90.9	83.9	77.6	
-29.	-44.	-54.	94.5	94.5	94.5	94.5	94.5	94.5	94.5	94.5	89.3	82.5	76.3	
-25.	-40.	-49.	94.5	94.5	94.5	94.5	94.5	94.5	94.5	94.5	87.7	81.0	74.9	
-22.	-36.	-45.	94.5	94.5	94.5	94.5	94.5	94.5	94.5	93.1	86.1	79.5	73.6	
-19.	-32.	-41.	94.5	94.5	94.5	94.5	94.5	94.5	94.5	91.5	84.6	78.1	72.2	
-16.	-28.	-37.	94.5	94.5	94.5	94.5	94.5	94.5	94.5	90.0	83.2	76.8	71.1	
-13.	-24.	-32.	94.5	94.5	94.5	94.5	94.5	94.5	93.4	88.5	81.9	75.6	69.9	
-9.	-20.	-28.	94.5	94.5	94.5	94.5	94.5	94.5	91.7	86.9	80.4	74.2	68.6	
-6.	-16.	-23.	94.5	94.5	94.5	94.5	94.5	94.5	90.0	85.2	78.8	72.8	67.3	
-3.	-12.	-19.	94.5	94.5	94.5	94.5	94.5	94.5	88.2	83.6	77.3	71.4	66.0	
0.	-8.	-14.	94.5	94.5	94.5	94.5	94.5	93.3	86.2	81.6	75.5	69.7	64.5	
4.	-4.	-10.	94.5	94.5	94.5	94.5	94.5	91.0	84.0	79.6	73.6	68.0	62.9	
7.	0.	-5.	94.5	94.5	94.5	94.5	94.5	88.5	81.7	77.3	71.6	66.1	61.1	
10.	4.	-1.	94.5	94.5	94.5	93.2	85.8	79.2	75.0	69.4	64.1	59.2		
13.	8.	4.	94.5	94.5	94.5	90.2	83.0	76.6	72.6	67.1	62.0	57.3		
17.	12.	8.	94.5	94.5	94.4	86.8	79.9	73.7	69.8	64.6	59.6	55.2		
20.	16.	12.	94.5	94.5	90.7	83.4	76.7	70.8	67.1	62.1	57.3	53.0		
23.	20.	17.	94.5	94.5	87.2	80.2	73.7	68.1	64.5	59.7	55.1	50.9		
27.	24.	21.	94.5	91.2	83.9	77.1	70.9	65.5	62.0	57.4	53.0	49.0		
31.	28.	26.	94.5	87.6	80.5	74.0	68.1	62.9	59.5	55.1	50.8			
35.	32.	30.	94.5	84.2	77.4	71.1	65.4	60.4	57.2	52.9				
38.	36.	34.	94.5	80.7	74.2	68.2	62.7	57.9	54.9					
42.	40.	38.	91.5	77.3	71.1	65.3	60.1	55.5						
46.	44.	42.	87.4	73.9	67.9	62.4								
50.	48.	47.	83.4	70.5	64.8									
54.	52.	51.	79.3	67.0										
58.	56.	55.	76.7											
62.	60.	59.	76.7											

The part above the reinforced line is the flat rated area; engine mechanical limit.

The part below the reinforced line is the area where the thermodynamical limit is reached first.

	TAKE-OFF	3.03.00	
		P 1	001
	CONTENTS		JUL 01

AA

3.03.00	CONTENTS
3.03.01	GENERAL TAKE-OFF CONDITIONS TAKE-OFF SPEEDS
3.03.02	METHODOLOGY GENERAL DETERMINATION OF THE TOW NL RUNWAYS
3.03.03	CORRECTIONS AIR CONDITIONING RUNWAY CONTAMINATION RUNWAY SLOPE WIND QNH WAT (WEIGHT - ALTITUDE - TEMPERATURE) OBSTACLES BRAKES ENERGY
3.03.04	QUICK REFERENCE TABLES (QRT)
3.03.05	TAKE-OFF SPEEDS VALUES
R 3.03.06	EXAMPLE OF TAKE OFF CHART COMPUTED WITH THE FOS

	TAKE-OFF	3.03.01.01.01		
		P 1	001	
	GENERAL			JUL 99

AA

The methodology for the determination of the maximum take off weight is described in the chapter 6-03 of the Airplane Flight Manual.

As this way is long and complex, ATR pilots and dispatchers may have two other possibilities to improve efficiency :

- the methodology described in 3-03-02 that gives non optimized results but can be used on board
- the Regulatory Take-Off Weight (RTOW) charts, generated with the Flight Operations Software (FOS), that give very accurate results before the flight.

TAKE-OFF CONDITIONS

Different weather conditions may be encountered at the take-off :

- **NORMAL CONDITIONS**
- **ATMOSPHERIC ICING CONDITIONS**

Atmospheric icing conditions exist when OAT on the ground and for take off is at or below 5° C or when TAT in flight is at or below 7° C and visible moisture in any form is present (clouds, fog with visibility of less than one mile, rain, snow, sleet and ice crystals).

● **GROUND ICING CONDITIONS**

Ground icing conditions exist when OAT on the ground is at or below 5° C and when surface snow, standing water, or slush is present on the ramps, taxiways and runways.

Note : TAKE-OFF IS PROHIBITED when frost, snow or ice is adhering to the wings, control surfaces or propellers.

Different runway conditions may be encountered:

- dry
- wet (less than 1/8 inch or 3 mm of water)
- contaminated by:
 - R - water or slush between 1/8 and 1/2 inch (3 and 12,7 mm)
 - R - loose snow : must be considered as slush. To determine the equivalent slush depth, multiply the loose snow depth by : 1,25 x (actual loose snow density)
 - R - compact snow
 - ice
- damp : a runway is damp when it is not perfectly dry, but when the water does not give it a shiny appearance.
For a damp runway, we do not consider any performance limitation.

R
R

	TAKE-OFF	3.03.01		
		P 2	100	
	GENERAL			JUN 97

AA

TAKE-OFF SPEEDS

The take-off speeds meet the requirements of the applicable regulations :

$$V_1 \geq V_1 \text{ limited by } V_{MCG} \quad V_2 \geq 1.13 \text{ VSR}$$

$$V_R \geq 1.05 V_{MCA} \quad V_2 \geq 1.1 V_{MCA}$$

V2 upper limit is 1.25 VSR to avoid excessive take-off runs or distances.

• NORMAL CONDITIONS

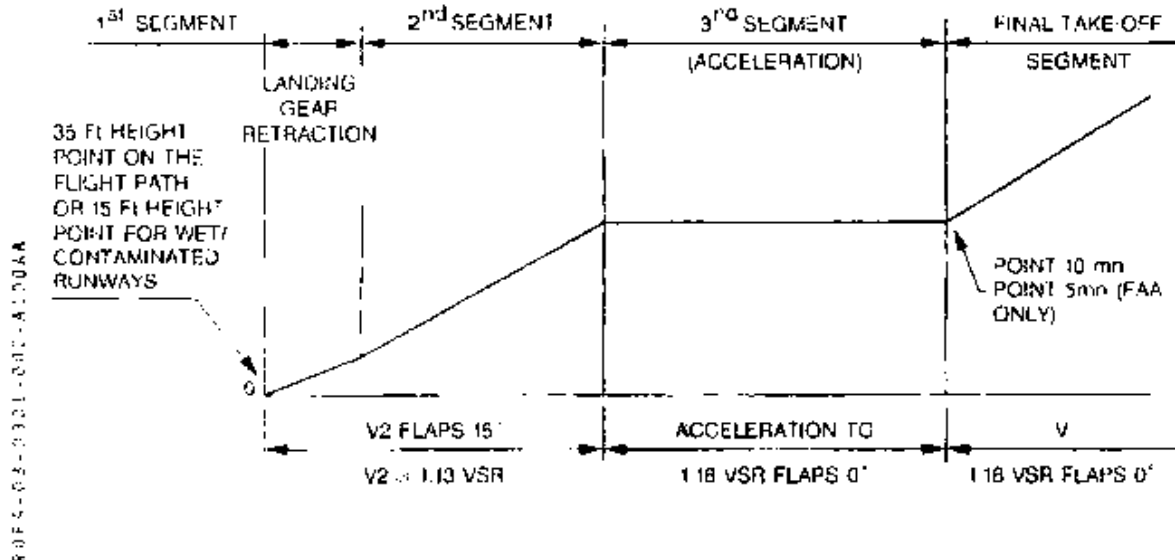

The V2/VSR speed ratio may be optimized between 1.13 and 1.25.

• ICING CONDITIONS

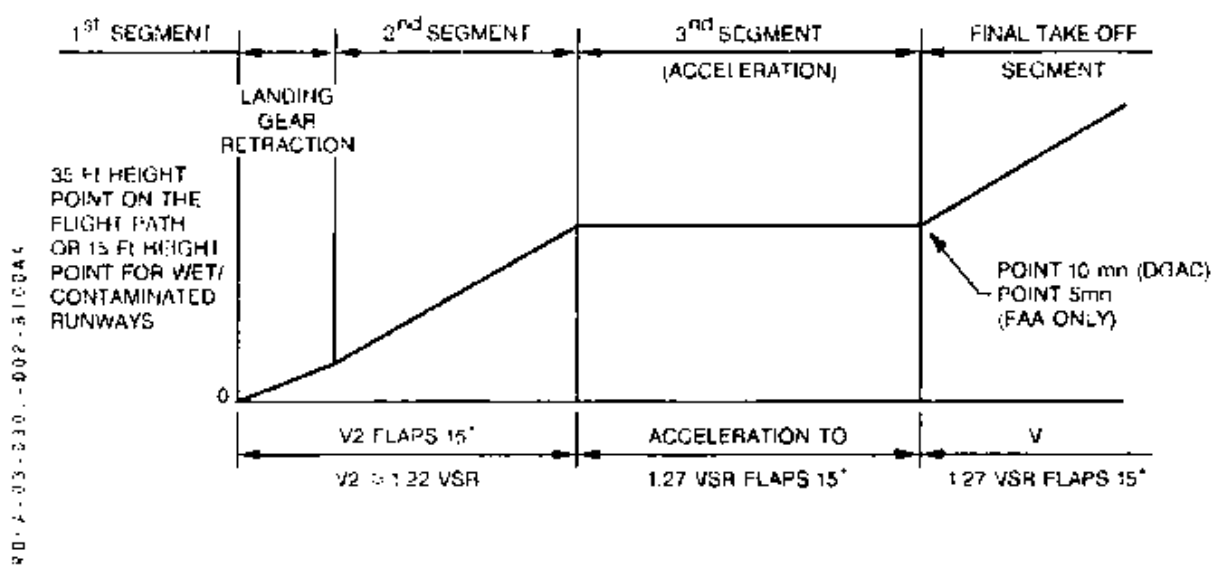

Minimum manoeuvre/operating speeds must be increased to keep a sufficient margin with regard to Vsig. The V2/VSR speed ratio must at least be equal to 1,22.

 ATR 72 F.C.O.M.	TAKE-OFF	3.03.02	
	METHODODOLOGY	P 1	001
			JUN 96

GENERAL

The Flight Operations department generates RTOW charts with the FOS for each airport, with the appropriate weather and runway conditions.

The RTOW charts enable the crew to determine immediately if the runway is limiting or not, or to know what limitation is active.

Each RTOW may be computed at :

- a given wind, for a range of pressures and temperatures
- the standard pressure, for a range of winds and temperatures

The RTOW charts may be computed at optimized take-off speeds ratios in order to obtain the maximum available take-off weights.

RTOW charts can take into consideration different cases of MEL dispatch.

Note : For wet or contaminated runways, the default program assumption is 15 ft for the screen height instead of 35 ft as usually for the dry runway.

It is why sometimes the wet runways may be less restrictive than the dry runways. In that case, you must consider the dry runway weights associated to the wet or contaminated runway speeds.

	TAKE-OFF	3.03.02	
		P 2	001
	METHODOLOGY		JUL 00

AA

The QRT (3.03.04) are to be used in relation with the method described in 3.03.02 page 3 by the airlines that do not have the FOS.

The QRT are RTOW charts computed with the FOS, but not optimized.

- In case of non limiting (NL) runway, the maximum take-off weight is the maximum structural take-off weight and the take-off speeds must be read in the 3-03-05 chapter or in the quick reference handbook, associated with the actual take-off weight.
- In case of limiting runway, a maximum take-off weight and the associated speeds are provided in the chart.
The limitation is indicated under a specific code form :

1 = structure	5 = tyre speed
2 = 2nd segment	6 = brakes energy
3 = runway	7 = runway 2 engines
4 = obstacle	8 = final take-off

The limitation code appears always twice in order to cover optimization taking into account two simultaneous limitations (2-2 means 2nd segment only; 2-4 means both 2nd segment and obstacle limitation).

The actual take-off weight must be less or equal to the computed maximum take-off weight.

- ^R The take-off speeds to be used must be the speeds indicated in the chart, even if the actual weight is lower than the computed weight.

Note : Due to the conservative definition of NL area a gap can be encountered between NL speeds and FOS optimized speeds when the computation case is at the NL border.

DETERMINATION OF THE TOW

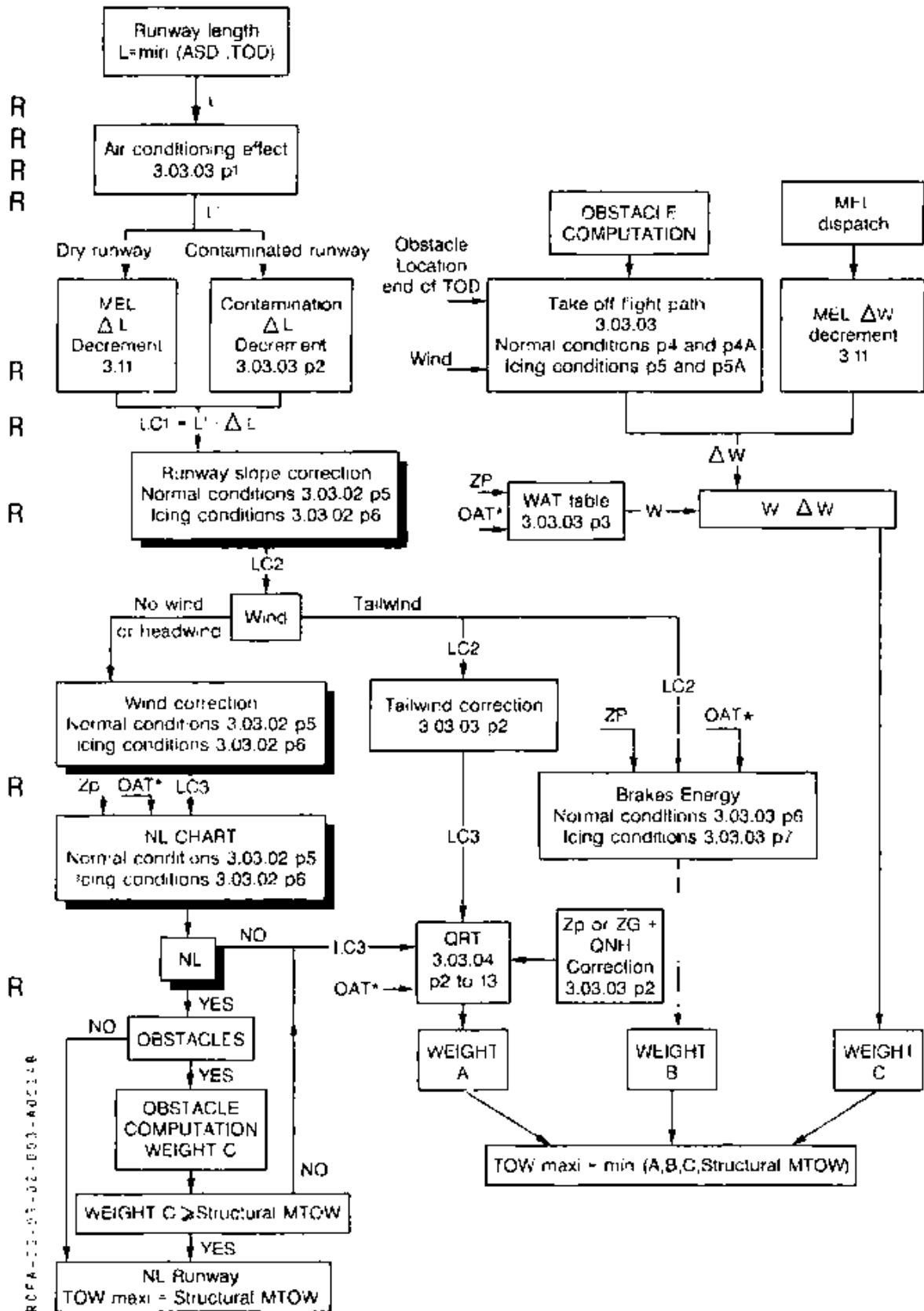

* AIR CONDITIONING EFFECT : refer in 3.03.03 page 1.

	TAKE-OFF	3.03.02	
		P 4	500
	METHODOLOGY		JUL 98

AA

NL DETERMINATION

In order to determine if the runway is limiting or not, use the charts in :

3.03.02 page 5 for normal atmospheric conditions

3.03.02 page 6 for icing atmospheric conditions

according to the examples given hereafter and the method given in page 3.

NORMAL ATMOSPHERIC CONDITIONS 3.03.02 PAGE 5

Wind = + 10 kt (headwind)

Dry runway

- R TORA = 1 800 m Pressure altitude = 3 000 ft
 R TODA = 1 870m (computed from airport elevation and actual QNH)
 R ASDA = 1 950 m Slope = + 0,6 % (uphill)
 R No obstacle

METHOD

- take the shorter length of ASD and TOD, i.e 1 870 m
 - locate this length on the length axis (point A)
 - reaching first the reference fine, correct this length according to the runway slope (0,6) and wind value (10) following the arrows
- R ● in the altitudes/temperatures field select the iso-altitude i.e. 3 000 ft

RESULT

- R ● after corrections, the point A is transferred to A' on the iso-altitude line 3 000 ft and
 R determines the upper temperature limit, i.e.+ 27.5°C.
 R The lower temperature limit is defined by the point C i.e. - 20°C.
 R The runway is NOT LIMITING for temperatures between - 20°C and + 27.5°C.

ICING ATMOSPHERIC CONDITIONS 3.03.02 PAGE 6

- R Same assumptions than in the preceding example but wet runway, and pressure
 R altitude = 1 000 ft.

METHOD

- take the shorter length of ASD and TOD, i.e. 1 870 m
- apply the length decrement due to contamination condition, i.e. 120 m, you obtain an equivalent length of 1 750 m (point B)

RESULT

- R ● proceeding as the preceding in example, the runway is NOT LIMITING for
 R temperatures between - 17°C and + 3.8°C.



TAKE-OFF

3.03.02

P 5

500

METHODOLOGY

JUL 98

NORMAL CONDITIONS

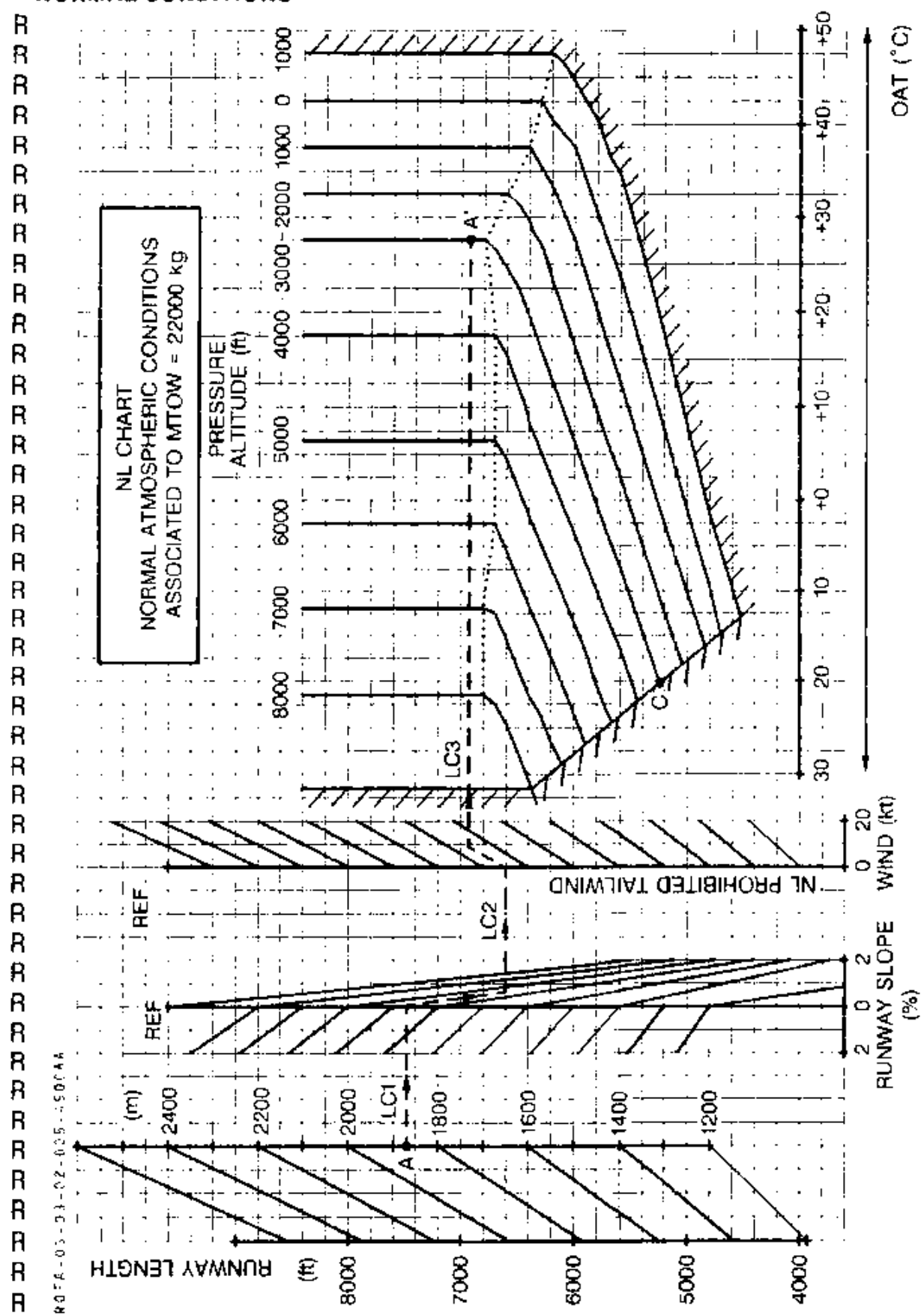



AR72
F.C.O.M.

TAKE-OFF

METHODOLOGY

3.03.02

P 6

500

JUL 98

AA

ICING CONDITIONS

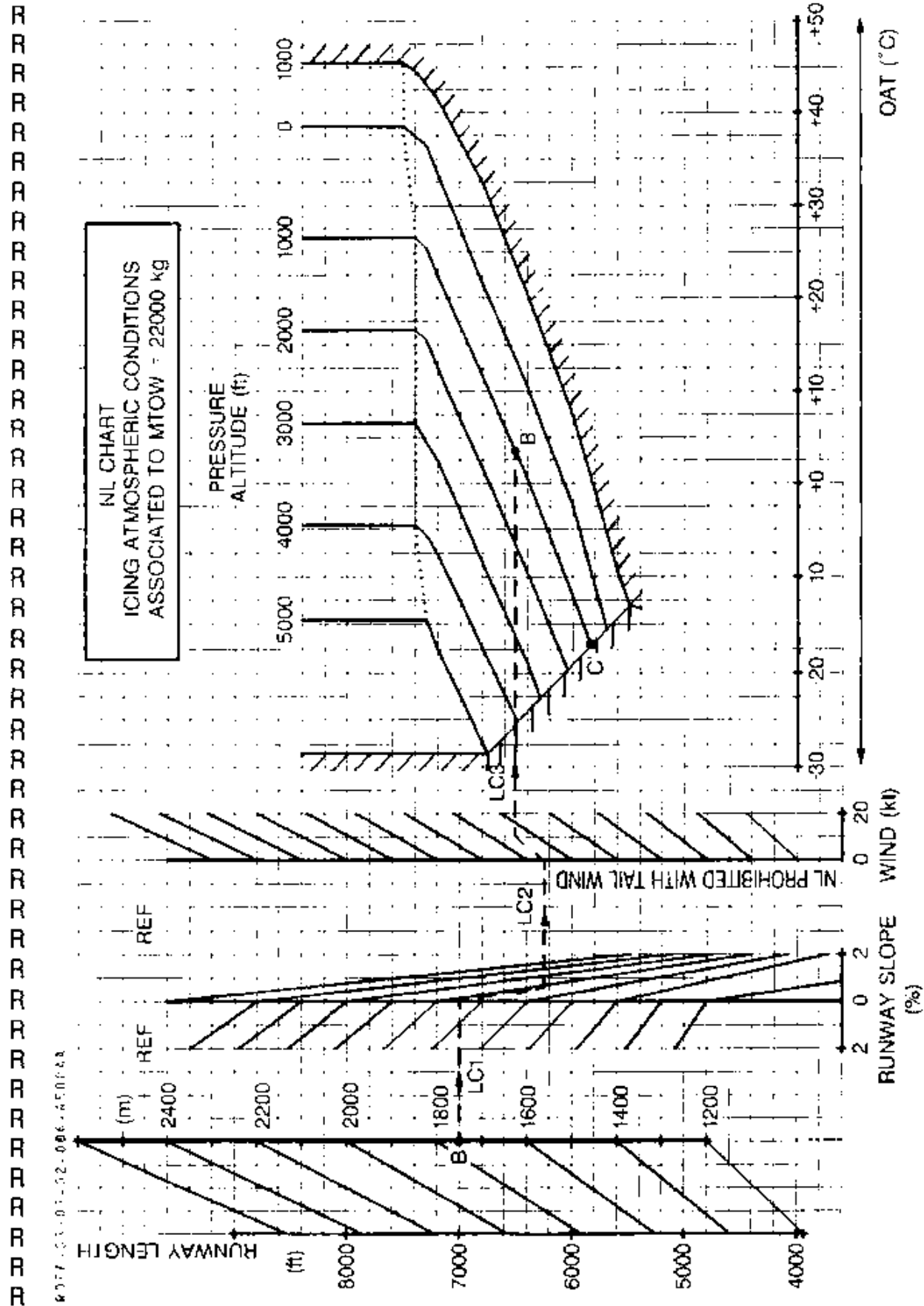



ATR 72
F.C.O.M.

TAKE-OFF

3.03.03

P 1

500

CORRECTIONS

JUL 00

AIR CONDITIONING

R Take-off performances are computed with AIR CONDITIONING ON.

To take into account the effect of AIR CONDITIONING OFF, increase the runway lengths by 3 % and take the actual OAT.

Note : The FOS, in accordance with AFM, takes into account a conservative performance decrement linked to the thermodynamical limitation of the engine. If the day conditions authorize a mechanical limit operation of the engine (i.e. torque bleed ON = 90 % for TO and 100 % for RTO), the take-off may be performed air conditioning ON without performance penalty.

	TAKE-OFF	3.03.03		
		P 2	500	
	CORRECTIONS			JUL 99

AA

R

RUNWAY SLOPE

Decrease the runway length by 400 m (1320 ft) for 1 % uphill slope.
For a better accuracy, use the chart given in 3.03.02 page 5 or 6.

WIND

Decrease the runway length by 400 m (1320 ft) for 10 kt tailwind.

QNH

To use a chart computed at the standard pressure when the actual QNH is not standard, follow the hereafter procedure :

- 1) With the actual wind and temperature, if necessary corrected by air conditioning influence, enter the chart and read the take-off weight and the associated limitation.
- 2) Apply the QNH correction :
 - QNH > 1013.25 HPa or 29.92 in Hg
No credit in case of brakes energy limitation, keep the values of the chart.
For all other limitations, add 80 kg (175 lb) to the TOW for each 10 HPa (0.29 in Hg) above the standard pressure.
For QNH \geq 1050 Hpa, keep the values of 1050 HPa.
 - QNH < 1013.25 HPa or 29.92 in Hg
Substract 240 kg (530 lb) to the TOW for each 10 HPa (0.29 in Hg) below the standard pressure.
- 3) With the new TOW, enter again the chart to interpolate the take-off speeds.

	TAKE-OFF	3.03.03		
		P 2A	500	
	CORRECTIONS			JUL 99

AA

NON DRY RUNWAYS

A non dry runway may be :

- wet,
- contaminated by water or slush, loose snow*, compacted snow, ice.

*Loose snow : must be considered as slush. To determine the equivalent slush depth, multiply the loose snow depth by : 1.25 x (actual loose snow density)

1 - Contaminated runway

At take off, the aircraft lateral controllability depends on :

- the exact contaminant characteristics,
- the cross wind component,
- the runway width and visual references.

Since these factors do not allow sufficient accuracy for predicting the effect of asymmetrical reverse thrust, it is therefore not recommended to use single engine reverse thrust for take-off on contaminated runway.

Performances without reverser only are to be used for flight preparation.

2 - Wet runways

In this particular condition, the single reverser use is perfectly controllable and leads to the minimum stop distance in case of rejected take-off.

3 - Non dry runways corrections for FCOM computation

According to the previous assumptions, decrease the runway length by the following values to take into account the runway contamination :

RUNWAY CONTAMINATION	CORRECTION
Wet	140 m (460 ft)
Water or slush between 3 mm (1/8 in) and 6.3 mm (1/4 in)	550 m (1800 ft)
Water or slush between 6.3 mm (1/4 in) and 12.7 mm (1/2 in)	620 m (2030 ft)
Compact snow	400 m (1310 ft)
Ice	1060 m (3480 ft)

	TAKE-OFF	3.03.03		
		P 3	300	
	CORRECTIONS			JUN 97

AA

WAT (WEIGHT ALTITUDE TEMPERATURE)

Maximum weight to face 2nd segment or final take-off climb requirement.

Apply if necessary the weight decrements due to obstacles or abnormal configurations.

NORMAL CONDITIONS

Temperature (°C)	AIRPORT PRESSURE ALTITUDE (ft)		
	0	1000	2000
0	24255 kg (53470 lb)	23935 kg (52760 lb)	23615 kg (52055 lb)
10	23920 kg (52730 lb)	23605 kg (52040 lb)	23295 kg (51360 lb)
20	23600 kg (52030 lb)	23300 kg (51360 lb)	22995 kg (50690 lb)
25	23450 kg (51695 lb)	23150 kg (51030 lb)	22845 kg (50360 lb)
30	23305 kg (51380 lb)	22990 kg (50685 lb)	22300 kg (49155 lb)
34	23190 kg (51125 lb)	22500 kg (49600 lb)	21635 kg (47695 lb)
38	22680 kg (50000 lb)	21815 kg (48095 lb)	20975 kg (46240 lb)
40	22330 kg (49225 lb)	21475 kg (47345 lb)	20645 kg (45510 lb)
45	21450 kg (47290 lb)	20625 kg (45465 lb)	19825 kg (43705 lb)
50	20565 kg (45335 lb)	19770 kg (43585 lb)	19010 kg (41910 lb)

Temperature (°C)	AIRPORT PRESSURE ALTITUDE (ft)		
	4000	6000	8000
0	22995 kg (50695 lb)	22105 kg (48735 lb)	21090 kg (46490 lb)
10	22680 kg (49995 lb)	21665 kg (47760 lb)	20015 kg (44120 lb)
20	22115 kg (48750 lb)	20405 kg (44985 lb)	18830 kg (41505 lb)
25	21350 kg (47070 lb)	19715 kg (43460 lb)	18190 kg (40100 lb)
30	20590 kg (45395 lb)	19010 kg (41900 lb)	17540 kg (38670 lb)
35	19835 kg (43720 lb)	18305 kg (40350 lb)	16890 kg (37235 lb)
40	19075 kg (42050 lb)	17610 kg (38820 lb)	16245 kg (35815 lb)

ICING CONDITIONS

FLAPS 15°

PRESSURE ALTITUDE (ft)	0	1000	2000	4000	6000	8000
at or below 0°C	24030 kg (52975 lb)	23710 kg (52275 lb)	23125 kg (50980 lb)	21915 kg (48310 lb)	20900 kg (46070 lb)	20125 kg (44365 lb)
at or below 5°C	23860 kg (52560 lb)	23425 kg (51645 lb)	22820 kg (50310 lb)	21635 kg (47695 lb)	20685 kg (45600 lb)	19955 kg (43995 lb)



ATR 72
F.C.O.M.

TAKE-OFF

3.03.03

P 5

500

CORRECTIONS

JUL 00

CLOSE OBSTACLES IN ICING CONDITIONS

Locate the close obstacles on the following graph and determine the decrement to apply to the WAT limiting weight previously computed to define the obstacles limiting weight.

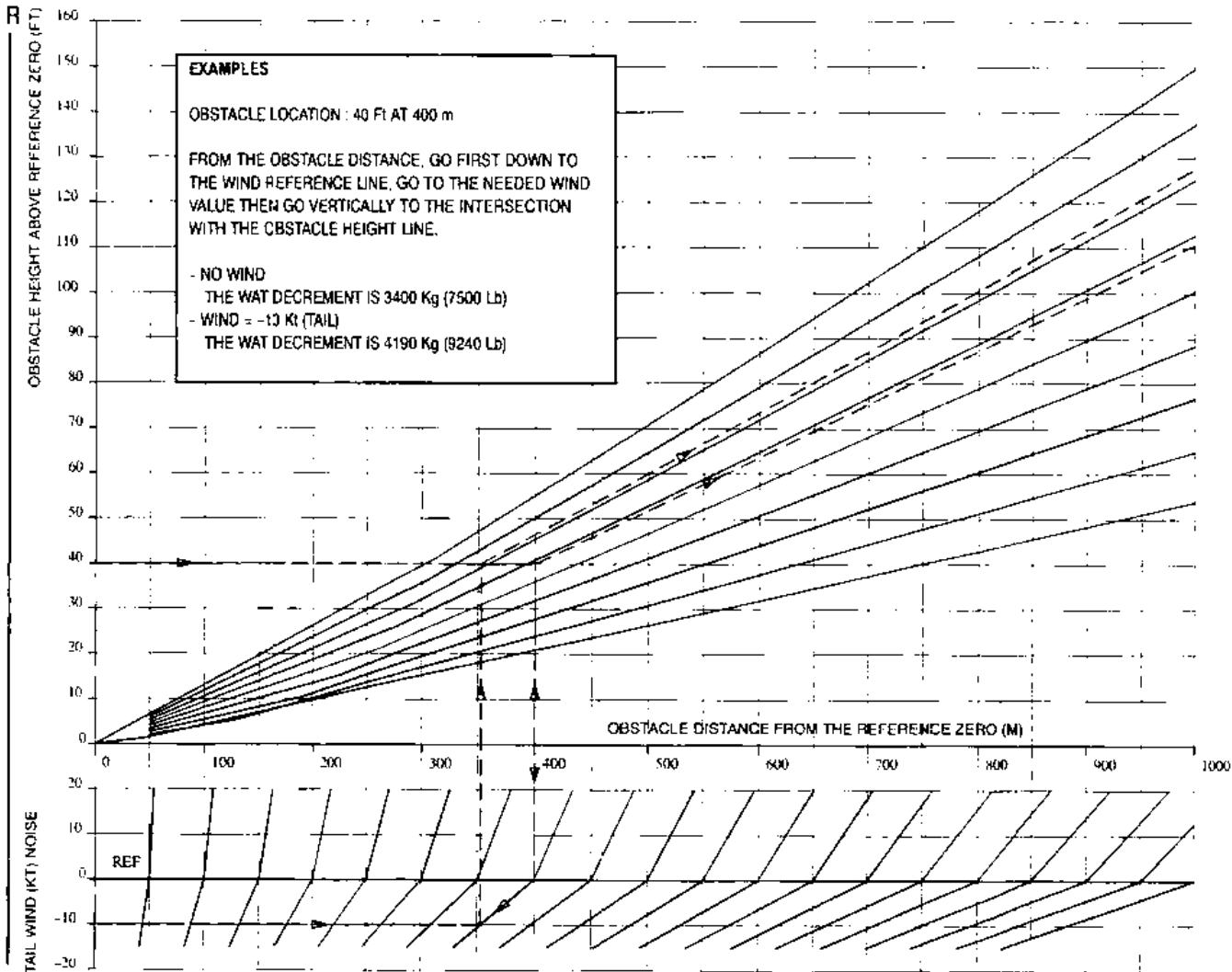

5120	11290
4610	10160
4070	8960
3500	7700
2890	6360
2240	4930
1540	3400
800	1760
0	0
Kg	Lb
WEIGHT DECREMENT	



ATR 72
F.C.O.M.

TAKE-OFF

3.03.03

P 5A

500

CORRECTIONS

JUL 00

REMOTE OBSTACLES IN ICING CONDITIONS

Locate the remote obstacles on the following graph and determine the decrement to apply to the WAT limiting weight previously computed to define the obstacles limiting weight.

R

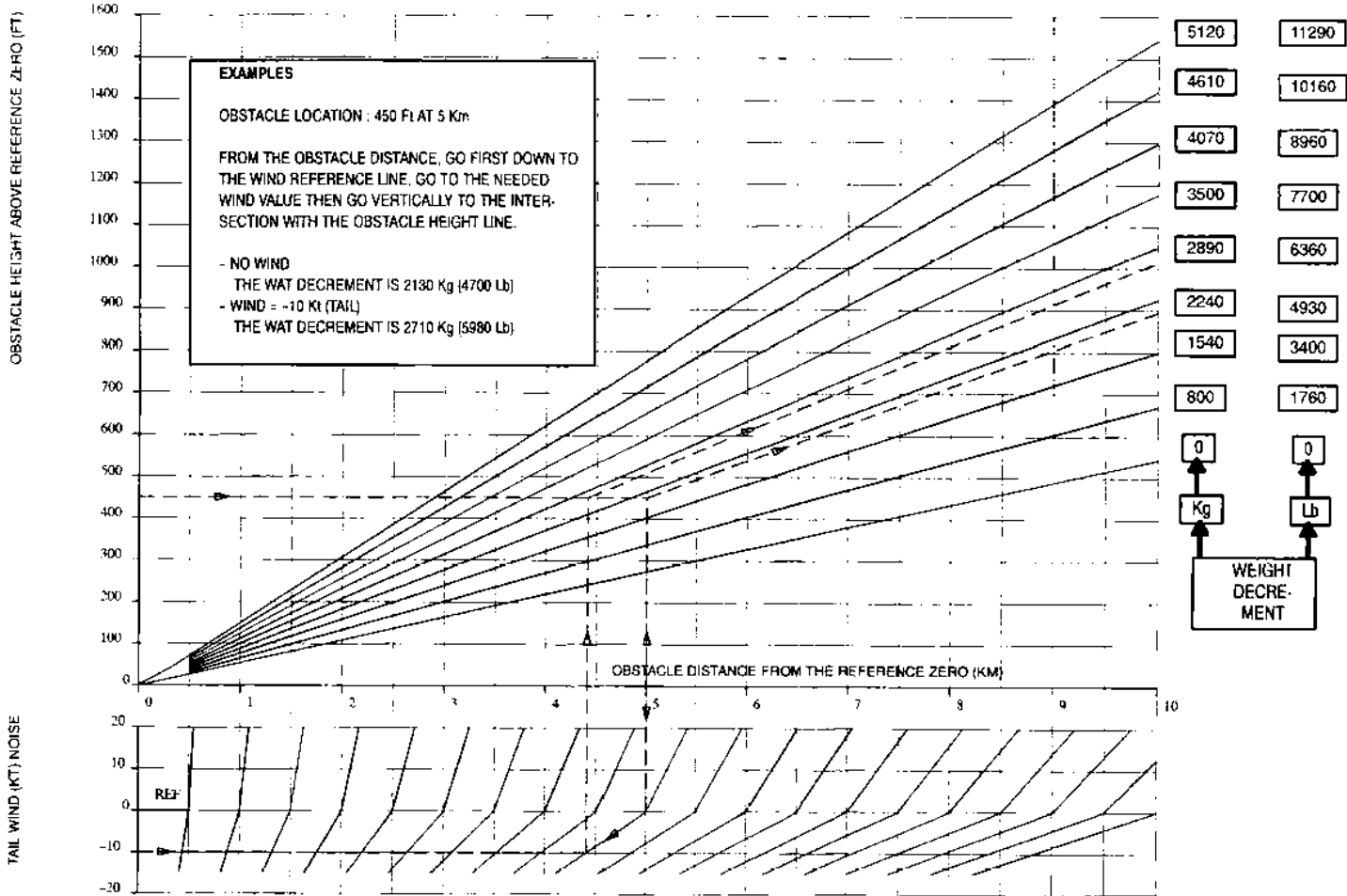

	TAKE-OFF		3.03.03	
			P 6	500
	CORRECTIONS			JUN 97

AA

BRAKES ENERGY LIMITATION**NORMAL CONDITIONS**

USE FOR ANY TAILWIND UP TO 10 KT

		TAKE OFF WEIGHT (KG) – LIMITATIONS V1(IAS.KT)–VR(IAS.KT)–V2(IAS.KT)		
ZP	FT	0	1000	2000
0 °C		22125 6-6	21638 6-6	21160 6-6
		110 110 114	108 108 113	107 107 112
10 °C		21652 6-6	21182 6-6	20742 6-6
		108 108 113	107 107 112	106 106 110
20 °C		21197 6-6	20752 6-6	20331 6-6
		107 107 112	106 106 110	105 105 109
30 °C		20747 6-6	20353 6-6	19989 6-6
		106 106 110	105 105 109	104 104 108
40 °C		20423 6-6	20047 6-6	19672 6-6
		105 105 110	105 105 108	104 104 107
50 °C		20101 6-6	19736 6-6	19009 2-2
		105 105 109	104 104 108	102 102 105

		TAKE OFF WEIGHT (KG) – LIMITATIONS V1(IAS.KT)–VR(IAS.KT)–V2(IAS.KT)		
ZP	FT	3000	4000	5000
-10 °C		21168 6-6	20725 6-6	20300 6-6
		107 107 112	106 106 110	105 105 109
0 °C		20716 6-6	20291 6-6	19873 6-6
		106 106 110	105 105 109	104 104 108
5 °C		20518 6-6	20072 6-6	19655 6-6
		105 105 110	104 104 109	103 103 107
10 °C		20319 6-6	19852 6-6	19453 6-6
		105 105 109	104 104 108	103 103 107
15 °C		20120 6-6	19632 6-6	19322 6-6
		104 104 109	103 103 107	102 102 106
20 °C		19921 6-6	19520 6-6	19189 6-6
		104 104 108	103 103 107	102 102 106
25 °C		19776 6-6	19393 6-6	19057 6-6
		104 104 108	103 103 107	102 102 106
30 °C		19612 6-6	19254 6-6	18926 6-6
		103 103 107	103 103 106	102 102 105
35 °C		19458 6-6	19108 6-6	18795 6-6
		103 103 107	102 102 106	102 102 105
40 °C		19312 6-6	18974 6-6	18329 2-2
		103 103 107	102 102 106	102 102 105

	TAKE-OFF			3.03.03		
	CORRECTIONS			P 7	500	
						JUN 97

AA

BRAKES ENERGY LIMITATION

ICING CONDITIONS

USE FOR ANY TAILWIND UP TO 10 KT

		TAKE OFF WEIGHT (KG) – LIMITATIONS V ₁ (IAS.KT)–VR(IAS.KT)–V ₂ (IAS.KT)			
ZP	FT	0	1000	2000	3000
BELOW 5 °C		20769 6-6	20343 6-6	19936 6-6	19539 6-6
		115 115 120	114 114 119	113 113 117	112 112 116
BELOW 10 °C		20567 6-6	20149 6-6	19747 6-6	19354 6-6
		115 115 119	113 113 118	112 112 117	111 111 115

		TAKE OFF WEIGHT (KG) – LIMITATIONS V ₁ (IAS.KT)–VR(IAS.KT)–V ₂ (IAS.KT)			
ZP	FT	4000	5000	6000	8000
BELOW 5 °C		19122 6-6	18727 6-6	18372 6-6	17752 6-6
		110 110 115	109 109 113	108 108 112	107 107 110
BELOW 10 °C		18913 6-6	18533 6-6	18235 6-6	17605 6-6
		110 110 114	108 108 113	108 108 112	106 106 110

		TAKE OFF WEIGHT (LB) – LIMITATIONS V ₁ (IAS.KT)–VR(IAS.KT)–V ₂ (IAS.KT)			
ZP	FT	0	1000	2000	3000
BELOW 5 °C		45789 6-6	44849 6-6	43951 6-6	43076 6-6
		115 115 120	114 114 119	113 113 117	112 112 116
BELOW 10 °C		45343 6-6	44421 6-6	43536 6-6	42668 6-6
		115 115 119	113 113 118	112 112 117	111 111 115

		TAKE OFF WEIGHT (LB) – LIMITATIONS V ₁ (IAS.KT)–VR(IAS.KT)–V ₂ (IAS.KT)			
ZP	FT	4000	5000	6000	8000
BELOW 5 °C		42156 6-6	41287 6-6	40504 6-6	39136 6-6
		110 110 115	109 109 113	108 108 112	107 107 110
BELOW 10 °C		41697 6-6	40858 6-6	40202 6-6	38813 6-6
		110 110 114	108 108 113	108 108 112	106 106 110

	TAKE-OFF QUICK REFERENCE TABLES	3.03.04		
		P 1	500	
				JUL 00

The QRT are computed on a dry runway at standard pressure, with air conditioning ON, no wind, no obstacle, and no slope.

Entry parameters must be determined as indicated in 3.03.02 P 3.

NORMAL CONDITIONS

The QRT are computed with $V2/VSR = 1,143$ and $V1/VR = 1$.

ICING CONDITIONS

The QRT are computed with $V2/VSR = 1,231$ and $V1/VR = 1$.

In case of ground icing conditions, if atmospheric icing conditions does not exist, the $V2/VSR$ speed ratio may be the same as in normal conditions.

Note : All regulatory limitations are taken into account in the QRT, except the structural limitation.

When the QRT indicates a weight value above the certified structural value, that means that the runway is NL in the conditions of computation of the QRT.

In any cases, the actual TOW must always be less than the certified MTOW associated to the operated ATR version.

 ATR 72 F.C.O.M.	TAKE-OFF	3.03.05		
	TAKE-OFF SPEEDS VALUES	P 1	001	
				JUN 96

The determination of the take-off speeds is done in relation with the TOW determined in 3.03.02 page 3.

- If TOW maxi = A or C speeds are read in QRT (3.03.04) with the day conditions (Zp, OAT, LC3).
- If TOW maxi = B, speeds are read in the brakes energy tables 3.03.03 pages 6 and 7, with the day conditions (Zp, OAT).

Read the speeds corresponding to the take-off weight indicated in the tables, even if the actual TOW is lower.

- If TOW maxi = structural TOW, speeds are given in 3.05.05 page 2 or in QRH.

Read the speeds corresponding to the actual TOW.

	TAKE-OFF	3.03.05	
	TAKE-OFF SPEEDS VALUES	P 2	500
			JUL 00

R NON LIMITING RUNWAYS TAKE-OFF SPEEDS

When a runway has been determined NL, the following speeds may be used associated to the actual TOW.

NEVER EXCEED THE CERTIFIED STRUCTURAL MTOW.

NORMAL CONDITIONS

WEIGHT kg (LB)	SPEEDS (KT IAS)	
	V1 = VR*	V2
22500 (49600)	112	115
22000 (48500)	111	114
21500 (47400)	109	113
21000 (46300)	108	111
20000 (44100)	105	110
19000 (41900) and below	104	110

ICING CONDITIONS

WEIGHT kg (LB)	SPEEDS (KT IAS)	
	V1 = VR*	V2
22500 (49600)	121	125
22000 (48500)	120	123
21500 (47400)	118	122
21000 (46300)	117	121
20000 (44100)	113	118
19000 (41900)	110	114
18000 (39690)	106	111
17000 (37480) and below	104	110

* Because of a longer time between VR and V_{Lof} due to water or slush runway contamination, increase VR by :

- 1 kt between 6.3 mm (1/4 inch) and 12.7 mm (1/2 inch),
- no correction below 6.3 mm (1/4 inch).



AR72
F.C.O.M.

TAKE-OFF

USE OF FOS

FOS TAKE OFF CHART FOR EXAMPLE

3.03.06

P 1

001

JUL 01

Note : The following take off chart is an example and cannot be used in operations.

WIND	TEMPERATURE	QNH	LIMITING WEIGHT		RTOW	V1	V2
			Structural	Runway			
0	15°C	1013.25	21916	21916	21916	109	112
5	15°C	1013.25	21916	21916	21916	109	112
10	15°C	1013.25	21916	21916	21916	109	112
15	15°C	1013.25	21916	21916	21916	109	112
20	15°C	1013.25	21916	21916	21916	109	112
25	15°C	1013.25	21916	21916	21916	109	112
30	15°C	1013.25	21916	21916	21916	109	112
35	15°C	1013.25	21916	21916	21916	109	112
40	15°C	1013.25	21916	21916	21916	109	112
45	15°C	1013.25	21916	21916	21916	109	112
50	15°C	1013.25	21916	21916	21916	109	112
55	15°C	1013.25	21916	21916	21916	109	112
60	15°C	1013.25	21916	21916	21916	109	112
65	15°C	1013.25	21916	21916	21916	109	112
70	15°C	1013.25	21916	21916	21916	109	112
75	15°C	1013.25	21916	21916	21916	109	112
80	15°C	1013.25	21916	21916	21916	109	112
85	15°C	1013.25	21916	21916	21916	109	112
90	15°C	1013.25	21916	21916	21916	109	112
95	15°C	1013.25	21916	21916	21916	109	112
100	15°C	1013.25	21916	21916	21916	109	112

CAUTION

- FOS results must be verified against the Airplane Flight Manual performance data. In case of any discrepancy, the AFM performance data shall prevail.
- It is the Operator's responsibility to update this chart in case of any change in runway or obstacle characteristics or in case of amendment of the AFM performance data.

Example 1 :

- Tail wind : 5 kt
- ATOW : 20,5 t
- Temperature : 15°C
- QNH : 1013.25 hpa

Check ATOW below 21916 kg, which is the maximum weight possible (Regulatory Take Off Weight because of the runway limitation)
The take off speeds associated to the ATOW are :

V1 = 109 kt
Vr = 109 kt
V2 = 112 kt

Example 2 :

Same conditions as in example 1 but with
QNH=1023.25 hpa
The RTOW is equal to 21916+83=21 999 kg
The take off speeds associated to the ATOW are :

V1 = 109 kt
Vr = 109 kt
V2 = 112 + 1 = 113 kt

Example 3 :

- No wind
- ATOW : 20.5 t
- Temperature: 0°C
- QNH : 1003.25 hpa

The runway is NL (Non Limiting)
Therefore, the RTOW is equal to the maximum structural take off weight of 22 000.
Check ATOW below 22000 kg.

Read the speed associated in FCOM 3.03.05 p2

	CLIMB	3.04.00		
	CONTENTS	P 1	001	
				DEC 94

AA

3.04.00 CONTENTS

3.04.01 INTRODUCTION

3.04.02 170 kt
 – Ceiling
 – Tables

3.04.03 190 kt
 – Ceiling
 – Tables

R 3.04.04 ICING CONDITIONS
 – Tables at 170 kt
 – Maximum Twin-engine operational ceiling at VMLB0

	CLIMB	3.04.01		
	INTRODUCTION	P 1	500	
				JUL 98

AA

Climb charts are established for two indicated speeds (170 kt, 190 kt) and for standard temperature (ISA) at Climb Power with Air conditioning in normal mode. Corrections are given to take into account the temperature effect.

All charts are established with a center of gravity location corresponding to 25%.

When using air conditioning in high mode, increase fuel consumption by 10%.

SERVICE CEILING

The operational ceiling is the maximum altitude which can be reached with a minimum rate of climb of 300 ft/mn (see 3.04.02 p 1).

CLIMB IN ICING CONDITIONS

Atmospheric icing conditions exist when TAT in flight is at or below 7°C and visible moisture in any form is present (clouds, fog with visibility of less than one mile, rain, snow, sleet and ice crystals).

Climb charts in icing conditions are established for 170 kt at climb Power with Air conditioning in normal mode.

Performance are computed taking into account a degradation of aircraft aerodynamic at altitudes where icing conditions may be encountered.

That is why tables are given for different temperatures (ISA-20, ISA-10, ISA, ISA + 10, ISA + 20).

The icing operational ceiling is computed for a minimum rate of climb of 100 ft/mn and can be read directly on the tables (3.04.04 pages 1 to 10) just below a blank division.

The maximum operational ceiling (twin engine) which is accessible when flying at $V_{MLBO} = 1.40V_{S1G}$ is given in 3.04.04 p.11.

- R Since computed with a lower residual rate of climb in icing conditions than in normal
- R conditions, the operational ceiling may sometimes be greater in icing conditions.
- R IN THIS CASE DO NOT EXCEED THE CEILING COMPUTED FOR NORMAL CONDITIONS.

Note : All performance data given for ICING CONDITIONS derive from flight tests measurements performed with ICE SHAPES representative of the worst icing cases considered by certification and applicable losses of propeller efficiency. Because of the variability of REAL ICING, climb performance published for icing conditions MUST BE regarded as operational information only.

	CLIMB	3.04.02	
		P 1	300
	170 kt		JUN 97

AA

TWIN-ENGINE CEILING - NORMAL CONDITIONS

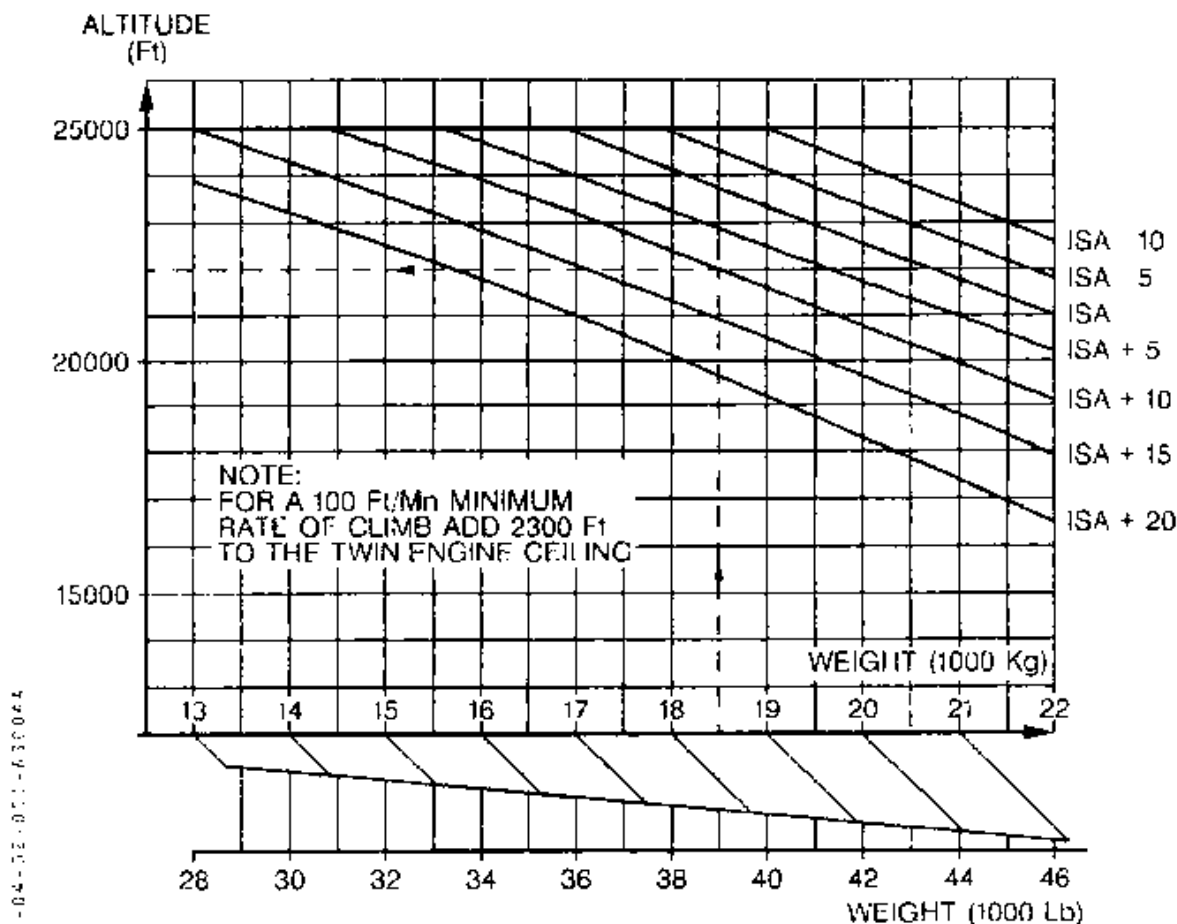

MO 2-01-04-02-01-63044

Example :
18500 kg } TWIN-engine ceiling = 22000 ft
ISA + 10 } (300 ft/mn)

CLIMB AT 170 kt : TEMPERATURE CORRECTION

To be applied on charts given in the next pages
Per 5°C above ISA

- Add 1.3 mn per 10 000 ft for time
- Add 14 kg per 10 000 ft for consumption
- Add 6 Nm per 10 000 ft for distance
- Add 1 kt per 10 000 ft for mean speed

Per 5°C below ISA

- Subtract 1 mn per 10 000 ft for time
- Subtract 7 kg per 10 000 ft for consumption
- Subtract 3 Nm per 10 000 ft for distance
- Subtract 1 kt per 10 000 ft for mean speed

	CLIMB	3.04.02		
		P 2	500	
	170KT			JUN 97

AA

CLIMB 2 ENGINES – NP=82%					
ISA	MINIMUM CLIMB RATE = 300FT/MN				170KT(IAS)
FL	WEIGHT AT START OF CLIMB (1000KG)				
	13	14	15	16	17
250	15 189	17 209	19 231	21 256	23 285
	54 216	61 217	68 217	75 218	85 218
240	14 174	15 192	17 211	18 233	20 258
	48 213	53 213	59 214	66 214	73 215
230	12 161	14 177	15 194	16 214	18 235
	43 210	47 210	52 210	58 211	64 211
220	11 149	12 164	13 179	15 197	16 216
	38 207	42 207	47 207	51 208	56 208
210	10 138	11 152	12 166	13 182	15 198
	34 204	38 204	42 205	46 205	50 205
200	9 128	10 141	11 154	12 168	13 183
	31 201	34 202	37 202	41 202	45 203
180	8 110	8 121	9 132	10 144	11 156
	25 197	28 197	30 197	33 198	36 198
160	6 94	7 103	8 112	8 122	9 132
	20 193	22 193	24 193	27 193	29 193
140	5 80	6 87	6 94	7 103	7 111
	16 189	18 189	20 189	21 189	23 190
120	4 66	5 72	5 78	5 84	6 91
	13 185	14 185	15 186	17 186	18 186
100	3 52	4 57	4 62	4 67	5 73
	10 182	11 182	12 182	13 183	14 183
80	2 40	3 43	3 47	3 51	3 55
	7 179	8 179	9 179	9 179	10 180
60	2 27	2 30	2 32	2 35	2 37
	5 176	5 176	6 176	6 177	7 177
40	1 15	1 16	1 18	1 19	1 21
	3 173	3 173	3 174	3 174	4 174
15	0 0	0 0	0 0	0 0	0 0
	0	0	0	0	0
FROM START OF CLIMB TIME (MIN)				FUEL (KG)	
FROM START OF CLIMB DIST. (NM)				MEAN SPEED TAS.(KT)	

	CLIMB 190 kt	3.04.03		
		P 1	300	
				JUN 97

AA

TWIN-ENGINE CEILING - NORMAL CONDITIONS

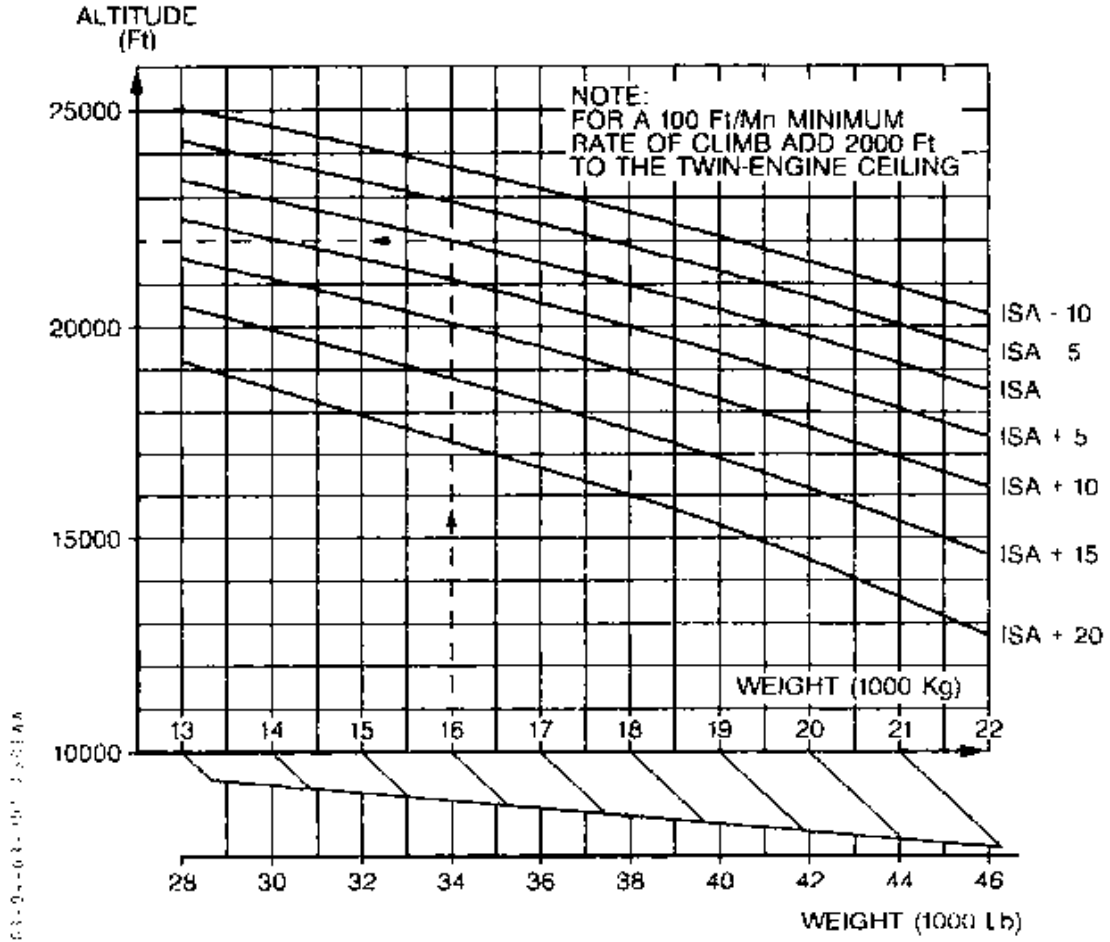

Example :
 16000 kg } TWIN-engine ceiling = 22000 ft
 ISA } (300 ft/mn)

CLIMB AT 190 kt : TEMPERATURE CORRECTION

To be applied on charts given in the next pages

- Per 5°C above ISA
- Add 1.5 mn per 10 000 ft for time
 - Add 17 kg per 10 000 ft for consumption
 - Add 7 Nm per 10 000 ft for distance
 - Add 0.7 kt per 10 000 ft for mean speed
- Per 5°C below ISA
- Subtract 1 mn per 10 000 ft for time
 - Subtract 10 kg per 10 000 ft for consumption
 - Subtract 5 Nm per 10 000 ft for distance
 - Subtract 0.5 kt per 10 000 ft for mean speed.

 ATR 72 F.C.O.M.	CLIMB		3.04.03	
	190KT		P 2	500
			JUN 97	

AA

CLIMB 2 ENGINES – NP=82%					
ISA	MINIMUM CLIMB RATE = 300FT/MN				190KT(IAS)
FL	WEIGHT AT START OF CLIMB (1000KG)				
	13	14	15	16	17
250					
240					
230	17 225 69 238	19 250 77 239			
220	15 200 59 234	17 221 65 234	19 245 73 235	21 271 81 235	
210	13 181 51 230	15 199 56 231	16 219 62 231	18 241 69 231	20 265 76 232
200	12 164 45 227	13 180 49 227	14 198 54 228	16 217 60 228	17 238 65 228
180	10 137 35 221	10 150 39 222	11 164 42 222	12 179 46 222	14 195 50 222
160	8 115 28 216	8 125 31 217	9 137 33 217	10 149 36 217	11 161 39 217
140	6 95 22 212	7 104 24 212	7 113 26 212	8 123 29 213	9 133 31 213
120	5 78 17 208	5 85 19 208	6 92 20 208	6 100 22 208	7 108 24 209
100	4 61 13 204	4 67 14 204	5 72 15 205	5 78 17 205	5 85 18 205
80	3 46 9 201	3 50 10 201	3 54 11 201	4 58 12 201	4 63 13 201
60	2 31 6 197	2 34 7 198	2 37 7 198	2 40 8 198	3 43 9 198
40	1 17 3 194	1 19 4 195	1 20 4 195	1 22 4 195	1 24 5 195
15	0 0 0	0 0 0	0 0 0	0 0 0	0 0 0
FROM START OF CLIMB TIME (MIN)			FUEL (KG)		
FROM START OF CLIMB DIST. (NM)			MEAN SPEED TAS.(KT)		

 ATR 72 F.C.O.M.	CLIMB		3.04.03		
	190KT		P 3	500	
					JUL 98

AA

CLIMB 2 ENGINES – NP=82%					
ISA MINIMUM CLIMB RATE = 300FT/MN 190KT(IAS)					
FL	WEIGHT AT START OF CLIMB (1000KG)				
	18	19	20	21	22.5
250					
240					
230					
220					
210	22 292 84 232				
200	19 260 72 229	21 285 79 229			
180	15 212 55 222	16 231 60 223	18 251 65 223	19 274 71 223	22 315 83 224
160	12 175 43 217	13 190 46 217	14 205 50 218	15 223 55 218	17 253 62 218
140	9 144 34 213	10 155 36 213	11 168 39 213	12 181 42 213	13 204 48 213
120	7 116 26 209	8 125 28 209	9 135 30 209	9 146 33 209	10 163 37 209
100	6 91 19 205	6 98 21 205	7 106 23 205	7 113 24 205	8 127 27 205
80	4 68 14 201	4 73 15 201	5 78 16 202	5 84 17 202	6 94 19 202
60	3 46 9 198	3 50 10 198	3 53 11 198	3 57 11 198	4 64 13 198
40	2 26 5 195	2 27 5 195	2 29 6 195	2 32 6 195	2 35 7 195
15	0 0 0	0 0 0	0 0 0	0 0 0	0 0 0
FROM START OF CLIMB TIME (MIN)			FROM START OF CLIMB DIST. (NM)		FUEL (KG) MEAN SPEED TAS.(KT)



AR72
F.C.O.M.

CLIMB

ICING CONDITIONS

3.04.04

P 1

500

JUN 97

**CLIMB 2 ENGINES – NP=82%
ICING CONDITIONS – 170KT(IAS)
ISA-20(.C) MINIMUM CLIMB RATE = 100FT/MN**

FL	WEIGHT AT START OF CLIMB (1000KG)				
	13	14	15	16	17
250	12 164 41 205	13 181 46 206	15 199 50 206	16 218 56 206	18 241 62 207
240	11 153 37 202	12 168 41 203	13 184 45 203	15 202 50 203	16 222 55 204
230	10 143 34 200	11 156 37 200	12 171 41 200	13 187 44 201	15 205 49 201
220	9 133 30 197	10 146 33 197	11 159 37 198	12 174 40 198	13 190 44 198
210	9 124 28 195	9 136 30 195	10 148 33 195	11 162 36 195	12 176 40 196
200	8 116 25 192	9 127 27 193	9 138 30 193	10 150 33 193	11 164 36 193
180	7 100 21 188	7 110 23 188	8 119 25 189	9 130 27 189	9 141 29 189
160	6 86 17 184	6 94 19 185	7 102 20 185	7 111 22 185	8 120 24 185
140	5 73 14 181	5 80 15 181	5 87 17 181	6 94 18 181	6 102 19 182
120	4 61 11 178	4 66 12 178	4 72 13 178	5 78 14 178	5 84 16 178
100	3 49 9 175	3 53 10 175	4 58 10 175	4 62 11 175	4 68 12 176
80	2 37 7 172	2 41 7 172	3 44 8 172	3 48 8 173	3 51 9 173
60	2 26 4 169	2 28 5 170	2 30 5 170	2 33 6 170	2 36 6 170
40	1 14 2 167	1 16 3 167	1 17 3 167	1 18 3 168	1 20 3 168
15	0 0 0	0 0 0	0 0 0	0 0 0	0 0 0
FROM START OF CLIMB TIME (MIN)			FUEL (KG)		
FROM START OF CLIMB DIST. (NM)			MEAN SPEED TAS.(KT)		

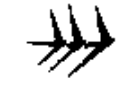
 ATR72 F.C.O.M.	CLIMB		3.04.04	
	ICING CONDITIONS		P 3	500
				JUN 97

AA

CLIMB 2 ENGINES – NP=82% ICING CONDITIONS – 170KT(IAS) MINIMUM CLIMB RATE = 100FT/MN					
ISA-10(.C)					
FL	WEIGHT AT START OF CLIMB (1000KG)				
	13	14	15	16	17
250	14 185	16 204	17 226	19 249	22 278
	50 211	56 212	62 212	69 213	77 213
240	13 171	14 188	16 207	17 228	19 252
	44 208	49 208	54 209	60 209	67 210
230	12 158	13 174	14 191	15 209	17 231
	40 205	44 205	48 206	53 206	59 207
220	11 147	12 161	13 176	14 193	15 212
	36 202	39 203	43 203	47 203	52 204
210	10 136	11 149	12 163	13 178	14 195
	32 200	35 200	39 200	42 200	46 201
200	9 126	10 138	11 151	11 165	13 180
	29 197	32 197	35 198	38 198	41 198
180	7 109	8 119	9 130	10 141	10 154
	23 193	26 193	28 193	31 193	33 194
160	6 93	7 102	7 111	8 120	9 131
	19 189	21 189	23 189	25 189	27 189
140	5 79	5 86	6 93	6 101	7 110
	15 185	17 185	18 185	20 186	22 186
120	4 65	4 71	5 77	5 84	6 91
	12 181	13 182	15 182	16 182	17 182
100	3 52	3 57	4 62	4 67	4 72
	10 178	10 179	11 179	12 179	13 179
80	2 40	3 43	3 47	3 51	3 55
	7 175	8 176	8 176	9 176	10 176
60	2 27	2 30	2 32	2 35	2 38
	5 173	5 173	6 173	6 173	7 174
40	1 15	1 17	1 18	1 19	1 21
	3 170	3 170	3 171	3 171	4 171
15	0 0	0 0	0 0	0 0	0 0
	0	0	0	0	0
FROM START OF CLIMB TIME (MIN)			FUEL (KG)		
FROM START OF CLIMB DIST. (NM)			MEAN SPEED TAS (KT)		



AR72
F.C.O.M.

CLIMB

ICING CONDITIONS

3.04.04

P 7

500

DEC 97

AA

RRRRRRRR

CLIMB 2 ENGINES – NP=82%					
ICING CONDITIONS – 170KT(IAS)					
ISA+10(°C)					
MINIMUM CLIMB RATE = 100FT/MN					
FL	WEIGHT AT START OF CLIMB (1000KG)				
	13	14	15	16	17
250	22 256 83 224	25 289 95 225	29 329 109 226	34 380 128 227	
240	19 226 70 220	22 255 79 220	24 286 90 221	28 323 102 222	32 373 120 223
230	17 206 61 216	19 229 68 217	21 255 76 217	24 285 86 218	27 322 98 219
220	15 187 53 213	17 207 59 213	18 230 66 214	21 255 73 214	23 286 83 215
210	13 171 47 210	15 189 52 210	16 209 57 210	18 231 64 211	20 257 71 211
200	12 157 42 207	13 173 46 207	15 191 51 208	16 210 56 208	18 232 62 208
180	10 133 33 202	11 146 36 202	12 160 40 202	13 175 44 203	14 193 48 203
160	8 111 26 197	9 122 29 198	10 134 32 198	11 146 35 198	12 160 38 198
140	6 92 21 193	7 101 23 194	8 110 25 194	8 120 27 194	9 131 30 194
120	5 75 16 190	6 82 18 190	6 89 19 190	7 97 21 190	7 105 23 190
100	4 58 12 186	4 64 13 186	5 69 14 186	5 75 15 186	5 82 17 187
80	3 44 9 182	3 48 9 183	3 52 10 183	4 56 11 183	4 61 12 183
60	2 30 6 179	2 33 6 180	2 35 7 180	2 38 7 180	3 41 8 180
40	1 16 3 176	1 18 3 177	1 19 3 177	1 21 4 177	1 23 4 177
15	0 0 0	0 0 0	0 0 0	0 0 0	0 0 0
FROM START OF CLIMB TIME (MIN)			FUEL (KG)		
FROM START OF CLIMB DIST. (NM)			MEAN SPEED TAS.(KT)		



ATR 72
F.C.O.M.

CLIMB

ICING CONDITIONS

3.04.04

P 11

500

DEC 97

AA

MAXIMUM OPERATIONAL CEILING (Twin engine)

ICING CONDITIONS - FLAPS 0° - $V_{MLBO} = 1,40 V_{SR}$

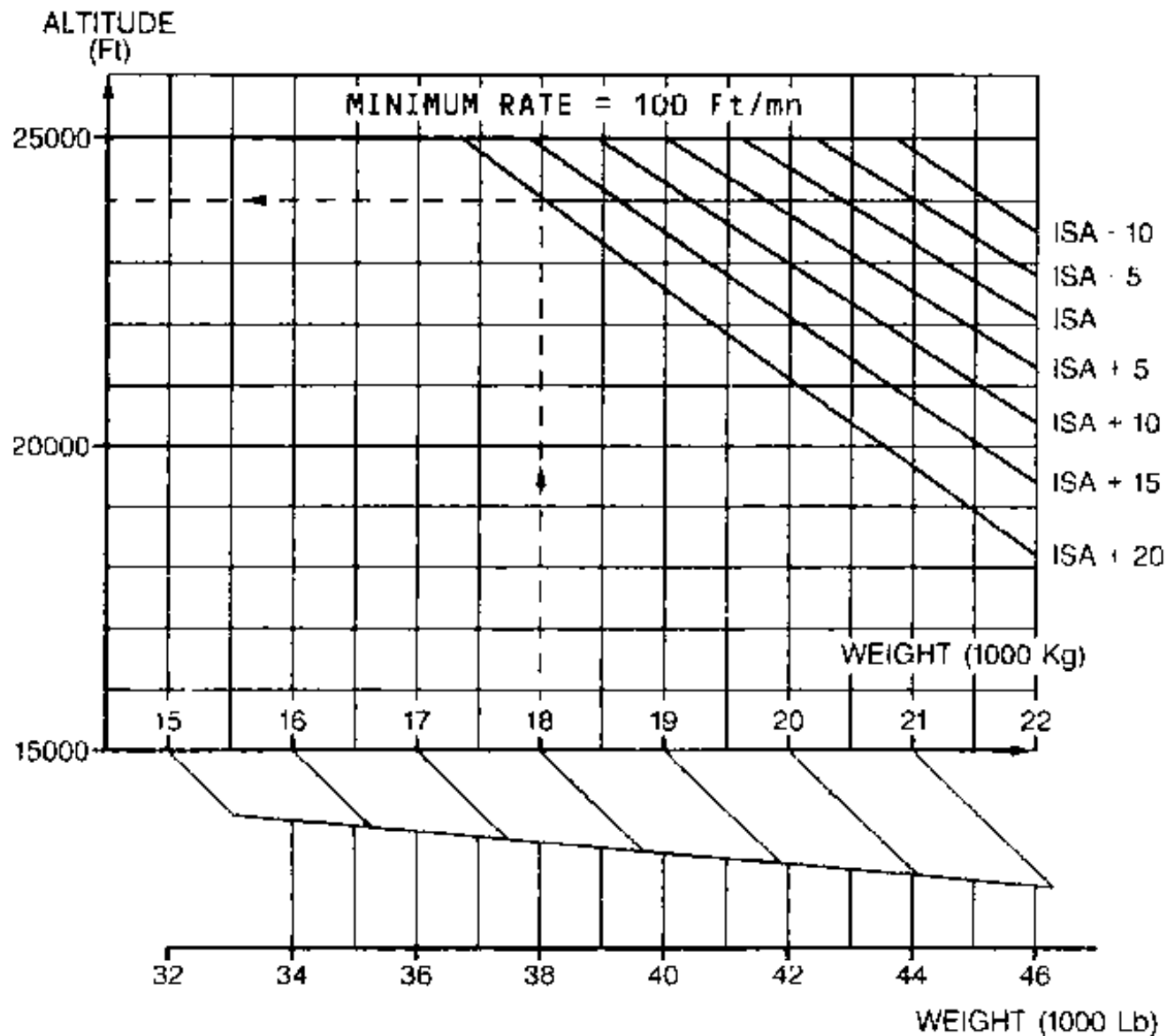

K 614-01-14-24-01-150347

Example :
 18000 kg } Maximum operational ceiling = 24000 ft
 ISA + 20 }

	CRUISE	3.05.00		
	CONTENTS	P 1	001	
				JUN 97

AA

- 3.05.00 CONTENTS**

- 3.05.01 INTRODUCTION**

- 3.05.02 MAX CRUISE**

- 3.05.03 ICING CONDITIONS**

	CRUISE	3.05.01		
	INTRODUCTION	P 1	500	
				DEC 97

AA

Cruise charts are established from FL 60 to FL 250 for different ISA conditions with air conditioning in normal mode.

To reach cruise figures :

- level off
- keep climb torque
- when cruise IAS is obtained :
 - select CRZ on PWR MGT

When using air conditioning in high mode increase fuel consumption by 3%, and subtract 4 kt on True Airspeed.

All charts are established with a center of gravity location corresponding to 25 %.

Max Cruise tables are given with NP = 82 %.

CRUISE IN ICING CONDITIONS

Atmospheric icing conditions exist when TAT in flight is at or below 7°C and visible moisture in any form is present (clouds, fog with visibility of less than one mile, rain, snow, sleet and ice crystals).

Tables are established only for the altitudes where icing conditions may be encountered and for different temperatures (ISA - 20, ISA -10, ISA, ISA + 10, ISA + 20).

When using air conditioning in high mode, increase fuel consumption by 1.5% and subtract 10 kt on True Airspeed.

Note : All performance data given for ICING CONDITIONS derive from flight tests measurements performed with ICE SHAPES representative of the worst icing cases considered by certification and applicable losses of propeller efficiency. Because of the variability of REAL ICING, cruise performance published for icing conditions **MUST BE** regarded as operational information only.

 ATR 72 F.C.O.M.	CRUISE		3.05.02	
			P 1	500
	MAX CRUISE			JUL 98

AA

CRUISE 2 ENGINES						
13 T						
FLIGHT LEVEL	DELTA ISA					MINIMUM TIME
	-10	0	+10	+15	+20	
60	91.9	94.0	88.3	83.4	78.8	
	456	469	451	433	417	
	252	252	245	239	233	
	267	272	269	265	261	
80	94.2	94.5	84.8	80.2	75.7	
	457	463	430	413	397	
	252	250	239	233	228	
	275	279	270	267	262	
100	94.5	90.8	81.4	76.9	72.7	
	452	442	409	393	378	
	250	245	233	227	222	
	281	280	272	268	264	
120	94.2	86.7	78.5	74.2	70.2	
	448	420	391	376	362	
	248	238	228	222	217	
	287	281	274	270	266	
140	90.1	83.5	76.1	72.1	68.1	
	430	403	376	362	347	
	241	233	223	218	212	
	288	284	277	273	269	
160	85.6	79.9	73.2	69.8	66.0	
	409	384	359	347	333	
	235	227	218	213	208	
	289	285	279	276	271	
180	80.6	75.5	69.5	66.3	63.0	
	386	363	340	327	316	
	227	220	212	207	202	
	289	285	280	276	272	
200	75.1	70.5	65.5	62.6	59.7	
	361	340	319	308	298	
	219	212	205	200	195	
	287	284	279	276	272	
220	69.7	65.6	61.3	58.9	56.2	
	336	317	298	289	279	
	211	204	197	193	188	
	286	283	278	275	271	
240	64.6	60.9	57.1	55.0	52.8	
	312	295	278	270	262	
	203	196	189	185	180	
	284	281	276	273	269	
250	62.1	58.6	54.9	53.0	51.0	
	300	284	268	260	253	
	199	192	184	181	176	
	283	279	274	271	268	

R

TQ % NP=82 %
 KG/H/ENG
 IAS
 TAC

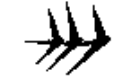
 ATR 72 F.C.O.M.	CRUISE		3.05.02	
			P 2	500
	MAX CRUISE			JUL 98

AA

CRUISE 2 ENGINES					
14 T					
MINIMUM TIME					
FLIGHT LEVEL	DELTA ISA				
	-10	0	+10	+15	+20
60	92.2	94.3	88.3	83.4	78.8
	457	470	451	433	417
	252	252	244	238	233
	267	272	269	265	261
80	94.5	94.5	84.7	80.2	75.7
	458	463	429	413	397
	252	250	238	233	227
	275	278	270	266	262
100	94.5	90.8	81.3	76.8	72.7
	452	442	409	393	378
	250	244	233	227	222
	281	280	272	267	263
120	94.1	86.6	78.5	74.2	70.2
	447	420	391	376	362
	247	238	227	222	217
	286	281	274	269	265
140	90.1	83.5	76.1	72.0	68.1
	429	403	376	361	347
	241	233	223	217	212
	288	283	277	272	268
160	85.6	79.8	73.2	69.7	66.0
	409	384	359	346	333
	234	226	217	212	207
	288	284	278	275	270
180	80.5	75.4	69.4	66.3	63.0
	386	363	339	327	316
	227	220	211	206	201
	288	285	279	275	271
200	75.0	70.4	65.4	62.5	59.6
	361	340	319	308	297
	219	212	204	199	194
	287	283	278	275	270
220	69.6	65.5	61.1	58.7	56.1
	335	317	298	289	279
	210	203	196	191	187
	285	281	277	273	269
240	64.4	60.8	56.9	54.8	52.6
	311	294	278	269	261
	202	195	187	183	179
	282	279	274	270	267
250	62.0	58.4	54.7	52.9	50.8
	300	283	267	260	252
	197	190	183	179	175
	281	277	272	269	265

R

TQ % NP=82 %
 KG/H/ENG
 IAS
 TAS

 ATR 72 F.C.O.M.	CRUISE		3.05.02	
			P 3	500
	MAX CRUISE			JUL 98

AA

CRUISE 2 ENGINES					
15 T					
MINIMUM TIME					
FLIGHT LEVEL	DELTA ISA				
	-10	0	+10	+15	+20
60	92.5	94.6	88.3	83.4	78.8
	458	471	451	433	417
	252	252	244	238	232
	267	272	268	264	260
80	94.5	94.5	84.7	80.1	75.7
	458	463	429	413	397
	252	250	238	232	227
	275	278	270	266	261
100	94.5	90.7	81.3	76.8	72.6
	453	441	409	393	378
	250	244	232	227	221
	281	279	271	267	263
120	94.1	86.6	78.4	74.1	70.1
	447	419	391	376	362
	247	238	227	221	216
	286	281	273	269	265
140	90.0	83.4	76.1	72.0	68.0
	429	402	375	361	347
	241	232	222	217	211
	287	283	276	271	267
160	85.5	79.8	73.1	69.7	65.9
	409	383	358	346	333
	234	226	217	212	206
	288	284	278	274	269
180	80.5	75.3	69.4	66.2	62.9
	386	363	339	327	316
	226	219	210	205	200
	287	284	278	274	269
200	74.9	70.3	65.2	62.4	59.5
	360	339	319	308	297
	218	211	203	198	193
	286	282	277	273	269
220	69.5	65.4	61.0	58.6	56.0
	335	316	297	289	278
	209	202	194	190	185
	283	280	275	271	267
240	64.3	60.6	56.7	54.6	52.5
	310	294	277	269	261
	201	193	186	181	177
	281	277	271	268	264
250	61.8	58.2	54.5	52.7	50.6
	299	282	267	259	252
	196	189	181	177	173
	279	275	269	266	262

R

TQ % NP=82 %
 KG/H/ENG
 IAS
 TAS

	CRUISE		3.05.02	
			P 4	500
	MAX CRUISE			JUL 98

AA

CRUISE 2 ENGINES					
16 T					
MINIMUM TIME					
FLIGHT LEVEL	DELTA ISA				
	-10	0	+10	+15	+20
60	92.8	94.5	88.2	83.3	78.8
	460	471	451	433	417
	252	252	244	238	232
	267	272	268	264	260
80	94.5	94.5	84.7	80.1	75.6
	458	463	429	413	397
	251	249	238	232	226
	275	278	269	265	261
100	94.5	90.7	81.3	76.8	72.6
	453	441	409	393	378
	249	243	232	226	220
	280	279	271	266	262
120	94.1	86.6	78.4	74.1	70.1
	447	419	391	376	362
	247	237	226	221	215
	285	280	272	268	264
140	90.0	83.4	76.0	72.0	68.0
	429	402	375	361	347
	240	232	221	216	210
	287	282	275	270	266
160	85.5	79.7	73.1	69.6	65.9
	409	383	358	346	333
	233	225	216	211	205
	287	283	276	272	268
180	80.3	75.2	69.3	66.1	62.8
	385	363	339	327	315
	226	218	209	204	198
	286	283	276	272	268
200	74.8	70.2	65.1	62.3	59.4
	360	339	318	307	297
	217	210	201	196	191
	285	281	275	271	266
220	69.3	65.2	60.8	58.4	55.9
	334	316	297	288	278
	208	201	193	188	183
	282	278	273	269	264
240	64.1	60.4	56.5	54.5	52.3
	310	293	276	268	260
	199	192	184	180	175
	279	274	269	265	261
250	61.6	58.0	54.3	52.5	50.4
	298	282	266	259	251
	195	187	179	175	170
	277	272	267	263	259

R

TQ % NP=82 %
 KG/H/ENG
 IAS
 TAS

 AJR72 F.C.O.M.	CRUISE		3.05.02	
			P 5	500
	MAX CRUISE			JUL 98

AA

CRUISE 2 ENGINES					
17 T					
MINIMUM TIME					
FLIGHT LEVEL	DELTA ISA				
	-10	0	+10	+15	+20
60	93.1	94.5	88.2	83.3	78.7
	461	471	451	433	417
	252	251	243	237	231
	267	272	267	263	259
80	94.5	94.5	84.6	80.0	75.6
	458	463	429	413	397
	251	249	237	231	225
	274	277	269	264	260
100	94.5	90.7	81.2	76.7	72.5
	453	441	409	393	378
	249	243	231	225	220
	280	279	270	265	261
120	94.0	86.5	78.3	74.0	70.0
	447	419	391	376	362
	246	237	226	220	214
	285	279	272	267	262
140	89.9	83.3	75.9	71.9	67.9
	429	402	375	361	347
	240	231	221	215	209
	286	281	274	269	264
160	85.4	79.6	73.0	69.5	65.8
	408	383	358	346	333
	233	224	215	210	204
	286	282	275	271	266
180	80.2	75.1	69.1	65.9	62.7
	385	362	338	326	315
	225	217	208	203	197
	285	281	275	271	266
200	74.6	70.0	64.9	62.1	59.2
	359	338	318	307	296
	216	208	200	195	190
	283	279	273	269	264
220	69.1	65.0	60.7	58.3	55.7
	333	315	296	288	278
	207	199	191	187	181
	280	276	270	266	262
240	63.8	60.2	56.3	54.2	52.1
	309	292	275	268	260
	197	190	182	177	172
	277	272	266	262	257
250	61.3	57.7	54.1	52.2	50.1
	297	281	265	258	250
	193	185	177	172	167
	275	269	263	259	254

R

TQ % NP=82 %
 KG/H/ENG
 IAS
 TAS

	CRUISE		3.05.02	
			P 6	500
	MAX CRUISE			JUL 98

AA

CRUISE 2 ENGINES					
18 T					
MINIMUM TIME					
FLIGHT LEVEL	DELTA ISA				
	-10	0	+10	+15	+20
60	93.5	94.5	88.2	83.2	78.7
	462	471	451	433	417
	252	251	243	237	231
	267	271	267	262	258
80	94.5	94.5	84.6	80.0	75.5
	458	463	429	413	397
	251	249	236	231	225
	274	277	268	264	259
100	94.5	90.6	81.2	76.6	72.5
	453	441	409	393	378
	249	243	230	224	219
	279	278	269	264	260
120	93.9	86.5	78.3	74.0	70.0
	447	419	391	376	361
	246	236	225	219	213
	284	279	271	266	261
140	89.8	83.2	75.8	71.8	67.8
	429	402	375	361	347
	239	230	220	214	208
	285	280	273	268	263
160	85.3	79.5	72.9	69.4	65.7
	408	383	358	346	333
	232	224	214	208	203
	285	281	274	269	264
180	80.1	74.9	69.0	65.8	62.6
	384	362	338	326	315
	224	216	206	201	196
	284	280	273	269	264
200	74.4	69.8	64.8	62.0	59.1
	358	338	317	307	296
	215	207	198	193	188
	282	277	271	267	262
220	68.9	64.8	60.5	58.1	55.5
	333	314	296	287	277
	205	198	189	184	179
	278	274	268	263	258
240	63.6	59.9	56.0	54.0	51.8
	308	291	275	267	259
	196	188	179	174	169
	274	269	262	258	252
250	61.1	57.4	53.8	51.9	49.8
	296	280	264	257	249
	191	183	174	169	163
	272	266	259	254	248

R

TQ % NP = 82 %
 KG/H/ENG
 IAS
 TAS

 NR72 F.C.O.M.	CRUISE		3.05.02	
			P 7	500
	MAX CRUISE			JUL 98

AA

CRUISE 2 ENGINES					
19 T					
MINIMUM TIME					
FLIGHT LEVEL	DELTA ISA				
	-10	0	+10	+15	+20
60	93.9	94.5	88.1	83.2	78.6
	464	471	450	433	416
	252	251	242	236	230
	267	271	266	262	257
80	94.5	94.5	84.5	79.9	75.5
	458	464	429	413	397
	250	248	236	230	224
	273	276	267	263	258
100	94.5	90.5	81.1	76.6	72.4
	453	441	409	393	377
	248	242	230	224	218
	279	277	268	263	259
120	93.9	86.4	78.2	73.9	69.9
	447	419	391	376	361
	245	235	224	218	212
	284	278	269	265	260
140	89.7	83.1	75.8	71.7	67.8
	428	402	375	361	347
	238	229	219	213	207
	284	279	271	266	261
160	85.1	79.4	72.8	69.4	65.6
	408	382	357	346	333
	231	223	212	207	201
	284	279	272	268	263
180	79.9	74.8	68.8	65.7	62.4
	384	361	338	326	315
	223	214	205	200	194
	283	278	271	267	262
200	74.2	69.6	64.6	61.8	58.9
	358	337	317	306	296
	213	205	196	191	185
	280	275	269	264	259
220	68.7	64.6	60.2	57.8	55.2
	332	313	295	286	276
	204	196	187	182	176
	276	271	265	260	254
240	63.3	59.6	55.7	53.6	51.4
	307	290	273	266	258
	194	186	176	171	165
	271	266	258	253	246
250	60.8	57.1	53.4	51.5	49.4
	295	279	263	256	248
	189	180	170	164	158
	269	262	253	248	240

R

TQ % NP=82 %
 KG/H/ENG
 IAS

 ATR 72 F.C.O.M.	CRUISE		3.05.02		
			P 8	500	
	MAX CRUISE				JUL 98

AA

CRUISE 2 ENGINES					
20 T		MINIMUM TIME			
FLIGHT LEVEL	DELTA ISA				
	-10	0	+10	+15	+20
60	94.4	94.5	88.1	83.1	78.6
	466	471	450	433	416
	252	250	241	235	229
	267	270	265	261	256
80	94.5	94.5	84.4	79.9	75.4
	459	464	429	412	396
	250	248	235	229	223
	273	276	266	262	257
100	94.5	90.4	81.0	76.5	72.3
	453	441	409	392	377
	247	241	229	222	216
	278	276	267	262	257
120	93.8	86.3	78.1	73.9	69.8
	446	419	390	376	361
	244	234	223	217	211
	283	277	268	263	258
140	89.6	83.0	75.7	71.7	67.7
	428	401	374	361	347
	237	228	217	211	205
	283	278	270	265	260
160	85.0	79.2	72.6	69.3	65.5
	407	382	357	345	332
	230	221	211	206	199
	283	278	270	266	261
180	79.7	74.6	68.7	65.5	62.3
	383	361	337	325	314
	221	213	203	198	192
	281	276	269	264	259
200	74.0	69.4	64.4	61.6	58.7
	357	336	316	305	295
	212	204	194	189	183
	278	273	266	261	255
220	68.4	64.3	60.0	57.5	54.9
	331	313	294	285	276
	202	194	185	179	172
	274	268	261	256	249
240	63.0	59.3	55.3	53.2	50.9
	306	289	272	265	256
	191	183	172	166	159
	268	262	252	246	238
250	60.4	56.7	52.9	50.9	48.7
	294	277	261	254	246
	186	176	165	158	149
	265	257	246	238	227

R

TQ % NP = 82 %
 KG/H/ENG
 IAS
 TAS

 A320 F.C.O.M.	CRUISE		3.05.02	
			P 9	500
	MAX CRUISE			JUL 98

AA

CRUISE 2 ENGINES					
21 T					
MINIMUM TIME					
FLIGHT LEVEL	DELTA ISA				
	-10	0	+10	+15	+20
60	94.5	94.5	88.0	83.1	78.5
	467	472	450	432	416
	252	249	241	234	228
	267	269	265	260	255
80	94.5	94.5	84.4	79.8	75.3
	459	464	429	412	396
	249	247	234	228	222
	272	275	265	260	255
100	94.5	90.3	80.9	76.4	72.2
	453	440	408	392	377
	247	240	228	221	215
	277	275	266	261	256
120	93.7	86.2	78.1	73.8	69.8
	446	418	390	376	361
	243	233	222	215	209
	282	276	267	262	257
140	89.5	82.9	75.5	71.6	67.6
	428	401	374	361	347
	237	227	216	210	204
	282	277	268	263	258
160	84.8	79.1	72.5	69.2	65.4
	407	381	357	345	332
	229	220	210	204	198
	282	276	269	264	258
180	79.5	74.4	68.5	65.3	62.1
	382	360	337	325	314
	220	212	202	196	190
	279	274	267	262	256
200	73.8	69.1	64.1	61.4	58.4
	356	336	315	305	294
	210	202	192	186	180
	276	270	263	257	251
220	68.1	64.0	59.6	57.2	54.6
	330	312	293	284	275
	200	191	181	175	167
	271	265	256	250	242
240	62.6	58.8	54.8	52.6	50.1
	304	288	270	263	254
	189	179	167	159	148
	265	257	245	236	222
250	60.0	56.1	52.1	49.8	
	292	275	258	251	
	182	172	157	145	
	260	250	234	219	

R

TO % NP=82 %
 KG/H/ENG
 IAS
 TAS

	CRUISE		3.05.02	
			P 10	500
	MAX CRUISE			JUL 98

AA

CRUISE 2 ENGINES					
22 T					
MINIMUM TIME					
FLIGHT LEVEL	DELTA ISA				
	-10	0	+10	+15	+20
60	94.5	94.5	87.9	83.0	78.4
	467	472	450	432	416
	251	249	240	233	227
	266	269	264	259	254
80	94.5	94.5	84.3	79.7	75.3
	459	464	429	412	396
	248	246	233	227	220
	271	274	264	259	254
100	94.5	90.2	80.9	76.3	72.2
	453	440	408	392	377
	246	239	226	220	214
	277	274	264	259	254
120	93.6	86.1	78.0	73.7	69.7
	446	418	390	375	361
	243	232	220	214	208
	281	274	265	260	255
140	89.3	82.8	75.4	71.5	67.5
	427	401	374	360	346
	235	226	215	208	202
	281	275	267	261	255
160	84.7	78.9	72.4	69.0	65.2
	406	381	357	345	332
	228	219	208	202	195
	280	275	267	262	255
180	79.3	74.2	68.3	65.1	61.9
	381	359	336	324	313
	219	210	200	193	187
	278	272	264	259	252
200	73.5	68.9	63.9	61.1	58.1
	355	335	314	304	293
	208	200	189	183	175
	273	268	259	253	245
220	67.8	63.6	59.2	56.7	54.0
	328	310	292	283	273
	197	188	177	170	160
	268	261	251	243	231
240	62.2	58.3	53.9	51.1	
	303	286	268	258	
	185	174	158	141	
	260	250	232	209	
250	59.5	55.3			
	290	272			
	178	164			
	254	240			

R

TQ % NP=82 %
 KG/H/ENG
 IAS
 TAS

 ATR 72 F.C.O.M.	CRUISE		3.05.02	
			P 11	500
	MAX CRUISE			JUL 98

AA

CRUISE 2 ENGINES					
22.5 T					
MINIMUM TIME					
FLIGHT LEVEL	DELTA ISA				
	-10	0	+10	+15	+20
60	94.5	94.5	87.9	83.0	78.4
	467	472	450	432	416
	251	248	239	233	226
	266	268	263	258	253
80	94.5	94.5	84.2	79.7	75.2
	459	464	428	412	396
	248	246	233	226	220
	271	274	263	258	253
100	94.5	90.2	80.8	76.3	72.1
	453	440	408	392	377
	246	239	226	219	213
	276	274	264	258	253
120	93.5	86.0	77.9	73.7	69.6
	446	418	390	375	361
	242	232	220	213	207
	280	273	265	259	254
140	89.2	82.7	75.4	71.4	67.5
	427	401	374	360	346
	235	225	214	208	201
	280	274	266	260	254
160	84.6	78.8	72.3	68.9	65.1
	406	381	356	345	331
	227	218	207	201	194
	279	274	265	260	254
180	79.2	74.1	68.2	65.0	61.8
	381	359	336	324	313
	218	209	198	192	185
	277	271	263	257	250
200	73.4	68.7	63.7	60.9	57.9
	354	334	314	304	293
	207	199	188	181	173
	272	266	257	250	241
220	67.6	63.4	59.0	56.4	53.6
	328	310	291	282	272
	196	186	174	166	154
	266	258	247	237	223
240	61.9	57.9	53.1		
	302	284	265		
	183	171	149		
	257	246	219		
250	59.2	54.7			
	289	270			
	176	158			
	251	232			

R

TQ % NP=82 %
 KG/H/ENG
 IAS

	CRUISE						3.05.03		
	ICING CONDITIONS						P 1	500	
									JUN 97

AA

CRUISE 2 ENGINES – NP=82%												
ISA-20 (°C)						ICING CONDITIONS – MINI TIME						
WEIGHT (1000KG)	FLIGHT LEVEL											
	60		80		100		120		140		160	
13	94.5		94.5		94.5		94.5		94.5		90.0	
	462	251	454	249	448	246	447	244	450	242	430	235
	28.3	261	29.3	266	30.3	272	31.0	277	31.4	283	33.0	284
14	94.5		94.5		94.5		94.5		94.5		89.9	
	462	251	454	248	449	246	447	244	450	242	430	235
	28.2	261	29.3	266	30.2	271	31.0	277	31.4	282	32.9	283
15	94.5		94.5		94.5		94.5		94.5		89.8	
	462	250	454	248	449	246	447	244	450	241	430	235
	28.2	260	29.3	266	30.2	271	30.9	276	31.3	282	32.9	283
16	94.5		94.5		94.5		94.5		94.5		89.7	
	462	250	454	248	449	245	447	243	450	241	429	234
	28.1	260	29.2	265	30.1	270	30.8	276	31.3	282	32.8	282
17	94.5		94.5		94.5		94.5		94.5		89.6	
	462	250	454	247	449	245	447	243	450	240	429	233
	28.1	260	29.2	265	30.1	270	30.8	276	31.2	281	32.8	281
18	94.5		94.5		94.5		94.5		94.5		89.5	
	462	249	454	247	449	244	448	242	451	240	429	232
	28.1	259	29.1	264	30.0	269	30.7	275	31.1	280	32.7	280
19	94.5		94.5		94.5		94.5		94.4		89.4	
	462	249	454	246	449	244	448	242	450	239	428	231
	28.0	259	29.1	264	29.9	269	30.6	274	31.0	279	32.6	279
20	94.5		94.5		94.5		94.5		94.3		89.2	
	462	248	454	246	449	243	448	241	450	238	428	230
	27.9	258	29.0	263	29.8	268	30.5	273	30.9	278	32.5	278
21	94.5		94.5		94.5		94.5		94.1		89.0	
	462	247	454	245	449	242	448	240	449	237	427	229
	27.8	257	28.9	262	29.7	267	30.4	272	30.8	277	32.4	276
22	94.5		94.5		94.5		94.5		94.0		88.9	
	462	247	454	244	449	242	449	239	449	236	426	228
	27.7	257	28.8	261	29.6	266	30.3	271	30.7	276	32.2	275
TQ %						IAS						
KG/H/ENG						TAS						
NM/100KG												

	CRUISE				3.05.03		
	ICING CONDITIONS				P 2	500	
							JUN 97

AA

CRUISE 2 ENGINES – NP=82%												
ISA-20 (°C)				ICING CONDITIONS – MINI TIME								
WEIGHT (1000KG)	FLIGHT LEVEL											
	160		180		200		220		240		250	
13	90.0		84.4		78.5		73.1		67.8		65.3	
	430	235	405	228	378	220	354	212	330	203	319	199
	33.0	284	34.9	283	37.2	282	39.6	280	42.2	278	43.5	277
14	89.9		84.4		78.4		72.9		67.7		65.1	
	430	235	405	227	378	219	353	211	329	202	318	198
	32.9	283	34.9	283	37.2	281	39.5	279	42.0	277	43.4	276
15	89.8		84.3		78.3		72.8		67.5		64.9	
	430	235	405	227	377	218	353	210	329	201	317	197
	32.9	283	34.8	282	37.1	280	39.4	278	41.9	275	43.2	274
16	89.7		84.1		78.2		72.6		67.3		64.7	
	429	234	404	226	377	217	352	209	328	200	316	195
	32.8	282	34.8	281	37.0	279	39.2	276	41.7	274	43.0	272
17	89.6		84.0		78.0		72.4		67.1		64.5	
	429	233	404	225	376	216	351	207	327	198	315	194
	32.8	281	34.7	280	36.9	277	39.1	275	41.5	272	42.8	270
18	89.5		83.8		77.8		72.2		66.9		64.2	
	429	232	403	224	375	215	350	206	326	197	314	192
	32.7	280	34.6	278	36.7	276	39.0	273	41.4	270	42.6	268
19	89.4		83.6		77.6		72.0		66.6		64.0	
	428	231	402	223	375	214	350	205	325	195	313	190
	32.6	279	34.4	277	36.6	274	38.8	271	41.1	267	42.3	265
20	89.2		83.4		77.4		71.8		66.3		63.6	
	428	230	401	222	374	212	349	203	324	193	312	188
	32.5	278	34.3	276	36.5	273	38.6	269	40.9	265	42.0	262
21	89.0		83.2		77.2		71.5		65.9		63.0	
	427	229	401	220	373	211	347	201	322	190	309	184
	32.4	276	34.2	274	36.3	271	38.4	267	40.5	261	41.4	256
22	88.9		83.0		76.9		71.2		65.3		62.2	
	426	228	400	219	372	209	346	199	320	186	306	178
	32.2	275	34.1	273	36.1	269	38.1	264	39.9	255	40.5	248
TQ % KG/H/ENG NM/100KG												
IAS TAS												

	CRUISE				3.05.03		
					P 3	500	
	ICING CONDITIONS						JUN 97

CRUISE 2 ENGINES – NP=82%												
ISA-10 (°C)			ICING CONDITIONS – MINI TIME									
WEIGHT (1000KG)	FLIGHT LEVEL											
	60		80		100		120		140		160	
13	94.5		94.5		94.5		93.4		89.2		84.8	
	467	249	459	246	454	244	445	241	427	235	407	228
	28.2	264	29.3	269	30.3	275	31.3	279	32.8	280	34.6	281
14	94.5		94.5		94.5		93.3		89.2		84.7	
	467	248	459	246	454	244	445	241	427	235	406	228
	28.2	264	29.3	269	30.2	274	31.3	279	32.8	280	34.5	280
15	94.5		94.5		94.5		93.3		89.1		84.6	
	467	248	459	246	454	244	445	240	427	234	406	227
	28.2	263	29.2	268	30.2	274	31.3	278	32.7	279	34.5	280
16	94.5		94.5		94.5		93.2		89.1		84.5	
	467	248	459	245	454	243	445	240	426	234	406	227
	28.1	263	29.2	268	30.1	274	31.2	278	32.7	279	34.4	279
17	94.5		94.5		94.5		93.2		89.0		84.4	
	467	247	459	245	454	243	445	239	426	233	405	226
	28.1	262	29.1	268	30.1	273	31.2	277	32.6	278	34.3	278
18	94.5		94.5		94.5		93.1		88.9		84.3	
	467	247	459	245	454	242	444	239	426	232	405	225
	28.0	262	29.1	267	30.0	272	31.1	276	32.5	277	34.2	277
19	94.5		94.5		94.5		93.0		88.7		84.2	
	467	246	459	244	454	242	444	238	425	231	405	224
	28.0	261	29.0	266	29.9	272	31.0	275	32.4	276	34.0	275
20	94.5		94.5		94.5		92.9		88.6		84.0	
	468	246	460	243	454	241	444	237	425	230	404	223
	27.9	261	28.9	266	29.8	271	30.9	274	32.3	275	33.9	274
21	94.5		94.5		94.5		92.8		88.5		83.9	
	468	245	460	243	454	240	444	236	425	229	404	221
	27.8	260	28.8	265	29.7	270	30.8	273	32.2	273	33.8	273
22	94.5		94.5		94.5		92.7		88.3		83.7	
	468	244	460	242	455	239	443	235	424	228	403	220
	27.7	259	28.7	264	29.6	269	30.7	272	32.1	272	33.6	271
TQ %						IAS						
KG/H/ENG						TAS						
NM/100KG												

	CRUISE				3.05.03		
					P 4	500	
	ICING CONDITIONS						JUN 97

AA

CRUISE 2 ENGINES – NP=82%												
ISA-10 (°C)				ICING CONDITIONS – MINI TIME								
WEIGHT (1000KG)	FLIGHT LEVEL											
	160		180		200		220		240		250	
13	84.8		79.6		74.2		68.8		63.7		61.3	
	407	228	383	221	357	213	332	205	308	196	297	192
	34.6	281	36.7	281	39.1	279	41.7	277	44.6	275	46.1	274
14	84.7		79.5		74.0		68.7		63.5		61.1	
	406	228	382	220	357	212	332	204	307	195	296	191
	34.5	280	36.6	280	39.0	278	41.6	276	44.4	273	45.9	272
15	84.6		79.4		73.9		68.5		63.3		60.9	
	406	227	382	220	356	211	331	202	307	194	295	189
	34.5	280	36.5	279	38.9	277	41.4	274	44.3	271	45.7	270
16	84.5		79.3		73.7		68.3		63.1		60.7	
	406	227	381	219	356	210	330	201	306	192	295	188
	34.4	279	36.4	278	38.7	275	41.3	273	44.0	270	45.4	268
17	84.4		79.1		73.6		68.1		62.9		60.5	
	405	226	381	218	355	209	330	200	305	191	294	186
	34.3	278	36.3	276	38.6	274	41.1	271	43.8	268	45.2	265
18	84.3		79.0		73.4		67.9		62.7		60.2	
	405	225	380	216	354	208	329	198	304	189	293	184
	34.2	277	36.2	275	38.4	272	40.9	269	43.5	265	44.8	262
19	84.2		78.8		73.2		67.7		62.4		59.8	
	405	224	380	215	354	206	328	197	303	187	291	181
	34.0	275	36.0	273	38.2	271	40.7	267	43.2	262	44.4	258
20	84.0		78.6		73.0		67.4		62.0		59.3	
	404	223	379	214	353	205	327	195	302	184	289	177
	33.9	274	35.9	272	38.1	269	40.4	264	42.7	257	43.6	252
21	83.9		78.4		72.7		67.1		61.4		58.4	
	404	221	378	213	352	203	326	193	300	179	286	169
	33.8	273	35.7	270	37.8	267	40.1	261	41.9	251	42.3	242
22	83.7		78.2		72.5		66.6		60.4			
	403	220	378	211	351	201	324	189	296	170		
	33.6	271	35.5	268	37.6	264	39.5	256	40.4	239		
TQ %						IAS						
KG/H/ENG						TAS						
NM/100KG												

	CRUISE				3.05.03		
	ICING CONDITIONS				P 5	500	
							JUN 97

MA

CRUISE 2 ENGINES – NP=82%												
ISA		ICING CONDITIONS – MINI TIME										
WEIGHT (1000KG)	FLIGHT LEVEL											
	60		80		100		120		140		160	
13	94.5		94.4		90.1		86.1		82.9		79.2	
	472	247	464	244	440	238	418	232	401	227	382	221
	28.2	267	29.3	272	31.0	273	32.8	274	34.4	276	36.3	277
14	94.5		94.4		90.1		86.1		82.8		79.1	
	472	246	464	244	440	238	418	232	401	226	382	220
	28.2	266	29.3	271	31.0	272	32.7	274	34.4	276	36.3	277
15	94.5		94.3		90.0		86.0		82.8		79.0	
	472	246	464	244	440	237	418	231	401	226	381	219
	28.2	266	29.2	271	30.9	272	32.7	273	34.3	275	36.1	276
16	94.5		94.3		90.0		86.0		82.7		78.9	
	472	246	463	243	439	237	418	231	400	225	381	219
	28.1	266	29.2	271	30.9	271	32.6	272	34.2	274	36.0	275
17	94.5		94.3		89.9		85.9		82.6		78.8	
	472	245	463	243	439	236	418	230	400	224	381	218
	28.1	265	29.1	270	30.8	271	32.5	271	34.1	273	35.9	273
18	94.5		94.2		89.8		85.8		82.5		78.7	
	472	245	463	242	439	235	417	229	400	223	380	217
	28.0	265	29.1	269	30.7	270	32.4	270	34.0	272	35.8	272
19	94.5		94.1		89.7		85.7		82.4		78.6	
	472	244	463	241	439	235	417	228	400	222	380	215
	27.9	264	29.0	269	30.6	269	32.3	269	33.8	271	35.6	271
20	94.5		94.1		89.6		85.6		82.3		78.5	
	473	244	463	241	439	234	417	227	399	221	380	214
	27.9	263	28.9	268	30.5	268	32.2	268	33.7	269	35.4	269
21	94.5		94.0		89.6		85.5		82.2		78.3	
	473	243	463	240	438	233	417	226	399	220	379	213
	27.8	262	28.8	267	30.4	267	32.0	267	33.6	268	35.3	268
22	94.5		93.9		89.5		85.4		82.1		78.2	
	473	242	463	239	438	232	417	225	399	219	379	212
	27.7	262	28.7	266	30.3	266	31.9	266	33.4	267	35.1	266
TQ % KG/H/ENG NM/100KG												
IAS TAS												

	CRUISE				3.05.03		
					P 6	500	
	ICING CONDITIONS						JUN 97

AA

CRUISE 2 ENGINES – NP=82%												
ISA		ICING CONDITIONS – MINI TIME										
WEIGHT (1000KG)	FLIGHT LEVEL											
	160	180	200	220	240	250						
13	79.2	74.7	69.7	64.8	60.1	57.8						
	382 221	361 214	337 206	314 198	292 190	281 185						
	36.3 277	38.4 277	40.9 276	43.6 274	46.5 271	48.0 270						
14	79.1	74.6	69.6	64.7	59.9	57.6						
	382 220	361 213	337 205	314 197	291 188	280 184						
	36.3 277	38.3 276	40.8 275	43.4 272	46.3 270	47.8 268						
15	79.0	74.5	69.4	64.5	59.8	57.4						
	381 219	360 212	336 204	313 196	291 187	280 182						
	36.1 276	38.2 275	40.6 273	43.2 271	46.0 268	47.5 266						
16	78.9	74.3	69.3	64.3	59.6	57.2						
	381 219	360 211	336 203	313 194	290 185	279 181						
	36.0 275	38.0 274	40.4 272	43.0 269	45.8 266	47.2 263						
17	78.8	74.2	69.1	64.2	59.4	56.9						
	381 218	359 210	335 201	312 193	289 184	278 178						
	35.9 273	37.9 272	40.2 270	42.8 267	45.4 263	46.8 260						
18	78.7	74.1	68.9	64.0	59.1	56.6						
	380 217	359 209	335 200	311 191	288 181	277 175						
	35.8 272	37.7 271	40.1 268	42.5 265	45.0 260	46.2 256						
19	78.6	73.9	68.8	63.7	58.7	56.0						
	380 215	358 208	334 199	311 189	287 178	275 171						
	35.6 271	37.6 269	39.8 266	42.2 262	44.4 255	45.3 249						
20	78.5	73.7	68.5	63.4	58.1	55.1						
	380 214	358 206	333 197	310 187	285 172	271 162						
	35.4 269	37.4 268	39.6 264	41.8 259	43.4 247	43.5 236						
21	78.3	73.5	68.3	62.9								
	379 213	357 205	333 195	308 182								
	35.3 268	37.2 265	39.3 261	41.1 253								
22	78.2	73.3	67.9	62.2								
	379 212	356 203	331 192	306 176								
	35.1 266	36.9 263	38.8 257	40.0 245								
TQ % KG/H/ENG NM/100KG IAS TAS												

	CRUISE				3.05.03		
					P 7	500	
	ICING CONDITIONS						JUN 97

AA

CRUISE 2 ENGINES – NP=82%												
ISA+10 (°C)			ICING CONDITIONS – MINI TIME									
WEIGHT (1000KG)	FLIGHT LEVEL											
	60		80		100		120		140		160	
13	88.3		84.8		81.4		78.1		75.7		72.7	
	451	245	430	239	409	233	390	222	375	217	357	212
	29.8	269	31.5	270	33.2	272	34.2	267	36.0	270	38.0	272
14	88.3		84.7		81.3		78.1		75.6		72.7	
	451	244	429	238	409	233	390	222	374	217	357	211
	29.8	269	31.4	270	33.2	272	34.2	267	35.9	269	37.9	271
15	88.3		84.7		81.3		78.0		75.5		72.6	
	451	244	429	238	409	232	390	221	374	216	357	210
	29.8	268	31.4	270	33.1	271	34.1	266	35.8	268	37.7	269
16	88.2		84.7		81.3		78.0		75.5		72.5	
	451	244	429	238	409	232	390	220	374	215	357	209
	29.7	268	31.4	269	33.1	271	34.0	265	35.7	267	37.6	268
17	88.2		84.6		81.2		77.9		75.4		72.4	
	451	243	429	237	409	231	390	219	374	214	357	208
	29.7	267	31.3	269	33.0	270	33.8	264	35.5	266	37.4	267
18	88.2		84.6		81.2		77.8		75.3		72.3	
	451	243	429	236	409	230	390	218	374	213	356	207
	29.6	267	31.2	268	32.9	269	33.7	263	35.4	265	37.3	266
19	88.1		84.5		81.1		77.8		75.2		72.2	
	450	242	429	236	409	230	390	217	374	212	356	206
	29.6	266	31.1	267	32.8	268	33.6	262	35.2	263	37.1	264
20	88.1		84.4		81.0		77.7		75.1		72.1	
	450	241	429	235	409	229	390	216	373	211	356	205
	29.5	265	31.0	266	32.7	267	33.4	260	35.1	262	36.9	262
21	88.0		84.4		80.9		77.6		75.0		72.0	
	450	241	429	234	408	228	390	215	373	210	356	203
	29.4	265	30.9	265	32.5	266	33.3	259	34.9	260	36.6	260
22	87.9		84.3		80.9		77.6		74.9		71.8	
	450	240	429	233	408	226	389	214	373	208	355	201
	29.3	264	30.8	264	32.4	264	33.1	258	34.7	259	36.3	258
TQ % KG/H/ENG NM/100KG												
IAS TAS												



AR72
F.C.O.M.

CRUISE

ICING CONDITIONS

3.05.03

P 8

500

JUN 97

AA

CRUISE 2 ENGINES – NP=82%												
ISA+10 (°C)		ICING CONDITIONS – MINI TIME										
WEIGHT (1000KG)	FLIGHT LEVEL											
	160		180		200		220		240		250	
13	72.7		68.9		64.8		60.6		56.4		54.2	
	357	212	338	205	317	198	296	191	276	182	266	178
	38.0	272	40.2	272	42.7	271	45.5	269	48.4	267	49.9	265
14	72.7		68.8		64.7		60.5		56.2		54.1	
	357	211	338	205	317	197	296	189	275	181	265	177
	37.9	271	40.1	271	42.5	269	45.2	268	48.1	265	49.6	263
15	72.6		68.7		64.5		60.3		56.1		53.9	
	357	210	337	203	316	196	295	188	275	180	265	175
	37.7	269	39.9	269	42.4	268	45.0	266	47.8	263	49.3	261
16	72.5		68.6		64.4		60.2		55.9		53.7	
	357	209	337	202	316	195	295	187	274	178	264	173
	37.6	268	39.7	268	42.1	266	44.7	264	47.5	260	48.8	257
17	72.4		68.5		64.3		60.0		55.6		53.3	
	357	208	337	201	316	193	294	185	273	175	263	169
	37.4	267	39.6	266	41.9	265	44.4	262	47.0	257	48.1	252
18	72.3		68.4		64.1		59.8		55.2		52.8	
	356	207	336	200	315	192	294	183	272	171	261	164
	37.3	266	39.4	265	41.6	262	44.0	259	46.2	251	47.0	245
19	72.2		68.2		63.9		59.5		54.6		51.8	
	356	206	336	199	315	190	293	180	270	166	258	154
	37.1	264	39.1	263	41.3	260	43.4	254	45.0	243	44.6	230
20	72.1		68.1		63.7		59.1					
	356	205	336	197	314	188	292	175				
	36.9	262	38.8	261	40.9	257	42.6	248				
21	72.0		67.9		63.3		58.4					
	356	203	335	195	313	184	290	169				
	36.6	260	38.5	258	40.2	252	41.2	239				
22	71.8		67.6		62.8							
	355	201	334	192	311	179						
	36.3	258	38.0	254	39.3	245						
TQ %						IAS						
KG/H/ENG						TAS						
NM/100KG												

 ATR72 F.C.O.M.	CRUISE				3.05.03		
					P 9	500	
	ICING CONDITIONS						JUN 97

AA

CRUISE 2 ENGINES – NP=82%												
ISA+20 (°C)						ICING CONDITIONS – MINI TIME						
WEIGHT (1000KG)	FLIGHT LEVEL											
	160		180		200		220		240		250	
13	65.7		62.6		59.2		55.7		52.3		50.5	
	333	202	315	196	296	189	278	182	260	175	251	171
	39.6	264	42.0	264	44.5	264	47.3	263	50.1	261	51.6	259
14	65.6		62.5		59.1		55.6		52.1		50.3	
	333	201	315	195	296	188	277	181	260	173	251	169
	39.5	263	41.8	263	44.3	262	47.0	261	49.7	258	51.2	257
15	65.5		62.4		59.0		55.5		52.0		50.1	
	332	200	315	194	296	187	277	179	259	171	250	167
	39.3	261	41.6	261	44.0	260	46.7	259	49.3	256	50.7	253
16	65.5		62.3		58.9		55.4		51.7		49.8	
	332	199	314	193	296	185	277	177	259	169	249	163
	39.1	260	41.3	260	43.7	258	46.2	256	48.7	252	49.8	248
17	65.4		62.2		58.7		55.2		51.4		49.4	
	332	198	314	191	295	183	276	175	258	164	248	158
	38.9	258	41.1	258	43.4	256	45.7	253	47.7	246	48.5	240
18	65.3		62.1		58.6		54.9		50.9			
	332	197	314	190	295	181	275	171	256	158		
	38.7	257	40.8	256	42.9	253	44.9	247	46.2	237		
19	65.2		62.0		58.3		54.5					
	332	195	313	188	294	178	274	166				
	38.4	255	40.4	253	42.3	249	43.8	240				
20	65.1		61.8		58.0							
	331	193	313	185	293	174						
	38.1	252	39.9	249	41.4	243						
21	64.9		61.5		57.5							
	331	191	312	181	292	167						
	37.7	249	39.2	244	40.1	234						
22	64.7		61.1									
	330	187	311	176								
	37.1	245	38.1	237								
TQ %						IAS						
KG/H/ENG						TAS						
NM/100KG												

	HOLDING CONTENTS	3.06.00		
		P 1	001	
				MAY 93

AB

3.06.00 CONTENTS

3.06.01 INTRODUCTION

R 3.06.02 NORMAL CONDITIONS

R 3.06.03 ICING CONDITIONS

	HOLDING	3.06.01		
	INTRODUCTION	P 1	500	
				JUL 98

AA

Holding charts are established :

- in clean configuration
- with air conditioning in normal mode.
- with NP = 82 % propeller speed
- at VmHBO of icing conditions.

This minimum manoeuvring speed covers the whole flight envelope in normal conditions and in icing conditions without appreciable increasing of consumption.

When using air conditioning in high mode, fuel consumption is increased by 2%.

All charts are established with a center of gravity location corresponding to 25 %.

The temperature effect is negligible.

R ICING CONDITIONS

- R Atmospheric icing conditions exist when TAT in flight is at or below 7°C and visible
- R moisture in any form is present (clouds, fog with visibility of less than one mile, rain, snow,
- R sleet and ice crystals).

	HOLDING	3.06.02		
		P 1	500	
	NORMAL CONDITIONS			JUL 98

AA

HOLDING 2 ENGINES					
WEIGHT (1000KG)	FLIGHT LEVEL				
	15	50	100	150	200
13	21.8 218 131	22.5 205 131	23.4 186 132	24.6 174 132	26.1 167 132
14	23.8 226 136	24.5 212 136	25.6 194 137	26.9 185 137	28.8 176 137
15	25.8 234 141	26.5 219 141	27.8 203 141	29.3 195 142	31.4 185 142
16	27.8 241 146	28.7 227 146	30.1 213 146	32.0 206 146	34.3 195 146
17	29.9 248 150	30.9 234 151	32.4 223 151	34.7 214 151	37.3 206 151
18	32.1 256 155	33.1 243 155	34.9 234 155	37.3 223 155	40.4 218 155
19	34.3 264 159	35.4 253 159	37.6 246 159	40.1 232 159	43.6 230 160
20	36.6 272 163	37.8 264 163	40.2 255 163	43.0 243 164	46.8 242 164
21	38.9 282 167	40.3 275 167	42.9 264 167	46.2 255 168	50.1 255 168
22	41.3 292 171	43.0 286 171	45.6 272 171	49.5 267 172	53.4 268 172
R	TQ % NP=82 % KG/H/ENG IAS				

	HOLDING		3.06.03		
			P 1	500	
	ICING CONDITIONS				DEC 97

AA

R

R

HOLDING 2 ENGINES					
VMHB0		ICING CONDITIONS			
WEIGHT (1000KG)	FLIGHT LEVEL				
	15	50	100	150	200
13	21.8	22.5	25.1	26.4	28.2
	218	205	193	181	174
	131	131	132	132	132
14	23.8	24.5	27.5	29.0	31.1
	226	212	201	193	184
	136	136	137	137	137
15	25.8	26.5	29.9	31.7	34.1
	234	219	211	204	195
	141	141	141	142	142
16	27.8	28.7	32.4	34.6	37.3
	241	227	222	214	206
	146	146	146	146	146
17	29.9	30.9	35.0	37.5	40.6
	248	234	234	223	219
	150	151	151	151	151
18	32.1	33.1	37.8	40.5	44.0
	256	243	246	234	232
	155	155	155	155	155
19	34.3	35.4	40.7	43.6	47.4
	264	253	256	246	245
	159	159	159	159	160
20	36.6	37.8	43.6	46.9	50.9
	272	264	266	258	259
	163	163	163	164	164
21	38.9	40.3	46.5	50.3	54.6
	282	275	275	271	273
	167	167	167	168	168
22	41.3	43.0	49.6	53.8	58.3
	292	286	286	284	289
	171	171	171	172	172
TQ% KG/H/ENG IAS			NP = 82%		



ATR 72
F.C.O.M.

DESCENT

3.07.00

P 1

001

CONTENTS

DEC 94

3.07.00 CONTENTS

3.07.01 INTRODUCTION

3.07.02 NORMAL CONDITIONS

3.07.03 ICING CONDITIONS

	DESCENT	3.07.01		
		P 1	500	
	INTRODUCTION			JUL 98

AA

R Descent charts are established in clean configuration for one reference weight
R (15000 kg = 33000 lb) and 3 speed laws :

- 200 kt
- 220 kt
- 240 kt

Two kinds of descent are proposed :

- at given rate
from cruise altitude, descent at 1500 ft/mn (or 2000 ft/mn with pressurization in FAST mode)
1) set cruise PLA up to the desired descent speed
2) maintain descent speed and rate of descent
- at given gradient
from cruise altitude, descent at chosen gradient (3° with pressurization in NORMAL mode, 4° or 5° with pressurization in FAST mode)
1) set cruise PLA up to the desired descent speed
2) maintain descent speed and gradient of descent

From 1500 ft to final landing, the tables are calculated with time and fuel allowances of :

- 3 mn for the time
- 30 kg (66 lb) for the consumption

WEIGHT CORRECTION

- on fuel consumption

Increase the fuel consumption by :

- R + 4 % at 1500 ft/mn of rate of descent
 - R + 5 % at 2000 ft/mn of rate of descent
 - + 2 % at 3° descent gradient
 - + 3 % at 4° descent gradient
 - + 4 % at 5° descent gradient
- for a 1000 kg (2200 lb) weight decrease.

- No correction for weight increase.
- No influence on time and distance.

	DESCENT		3.07.02	
			P 1	500
	NORMAL CONDITIONS			JUN 97

DESCENT 2 ENGINES						
NP=82%						
15000KG		NORMAL CONDITIONS				
FL	200 KT IAS		220 KT IAS		240 KT IAS	
	1500 ft/mn	2000 ft/mn	1500 ft/mn	2000 ft/mn	1500 ft/mn	2000 ft/mn
250	19 119 63	15 81 47	19 145 70	15 102 52	19 180 76	15 126 57
240	18 115 60	14 79 45	18 140 66	14 99 49	18 174 72	14 122 54
230	17 112 57	14 77 43	17 136 63	14 96 47	17 167 68	14 118 51
220	17 108 54	13 75 40	17 131 59	13 93 44	17 160 65	13 114 48
210	16 105 51	13 73 38	16 126 56	13 90 42	16 154 61	13 110 46
200	15 101 48	12 71 36	15 121 53	12 87 39	15 147 57	12 105 43
180	14 94 42	11 67 31	14 112 46	11 81 35	14 135 50	11 97 38
160	13 87 36	10 63 27	13 102 40	10 75 30	13 122 44	10 89 33
140	11 79 31	9 59 23	11 92 34	9 69 25	11 110 37	9 81 28
120	10 72 25	8 54 19	10 83 28	8 63 21	10 97 31	8 73 23
100	9 65 20	7 50 15	9 73 22	7 58 17	9 85 24	7 65 18
80	7 57 15	6 45 11	7 63 17	6 52 13	7 72 18	6 57 14
60	6 49 10	5 40 8	6 53 11	5 45 9	6 59 13	5 49 9
40	5 41 6	4 36 4	5 43 6	4 39 5	5 46 7	4 40 5
15	3 30 0	3 30 0	3 30 0	3 30 0	3 30 0	3 30 0
FROM START OF DESCENT TIME (MN)					FUEL (KG)	
FROM START OF DESCENT DIST (NM)						

 A320 F.C.O.M.	DESCENT						3.07.02		
	NORMAL CONDITIONS						P 2	500	
									JUN 97

AA

DESCENT 2 ENGINES									
NP = 82%									
15000KG					NORMAL CONDITIONS				
FL	200 KT IAS			220 KT IAS			240 KT IAS		
	3°	4°	5°	3°	4°	5°	3°	4°	5°
250	21 146 74	17 103 55	14 77 44	20 159 74	16 111 55	13 84 44	18 177 74	15 124 55	12 92 44
240	21 143 71	16 101 53	14 75 42	19 155 71	15 108 53	13 83 42	18 172 71	14 121 53	12 90 42
230	20 139 68	16 99 51	13 74 40	19 151 68	15 106 51	12 81 40	17 166 68	14 118 51	12 88 40
220	19 136 64	15 97 48	13 73 39	18 147 64	14 103 48	12 80 39	17 161 64	13 115 48	11 86 39
210	19 132 61	15 95 46	12 71 37	17 142 61	14 101 46	12 78 37	16 156 61	13 112 46	11 84 37
200	18 128 58	14 93 44	12 70 35	17 138 58	13 98 44	11 76 35	16 151 58	12 108 44	11 82 35
180	17 120 52	13 88 39	11 67 31	15 129 52	12 92 39	10 73 31	14 140 52	12 102 39	10 78 31
160	15 111 46	12 83 34	10 64 27	14 119 46	11 86 34	10 69 27	13 129 46	11 95 34	9 73 27
140	14 102 39	11 77 29	9 61 24	13 109 39	10 80 29	9 65 24	12 117 39	10 87 29	8 68 24
120	12 92 33	10 72 25	8 57 20	11 98 33	9 73 25	8 61 20	11 105 33	9 79 25	8 63 20
100	10 82 27	9 65 20	7 52 16	10 86 27	8 66 20	7 56 16	9 92 27	8 71 20	7 57 16
80	9 71 20	7 58 15	6 48 12	8 74 20	7 58 15	6 51 12	8 79 20	7 62 15	6 52 12
60	7 59 14	6 50 11	5 43 8	7 61 14	6 50 11	5 45 8	6 65 14	6 53 11	5 45 8
40	5 47 8	5 41 6	4 37 5	5 48 8	5 42 6	4 39 5	5 50 8	4 43 6	4 39 5
15	3 30 0	3 30 0	3 30 0	3 30 0	3 30 0	3 30 0	3 30 0	3 30 0	3 30 0
FROM START OF DESCENT TIME (MN)							FUEL (KG)		
FROM START OF DESCENT DIST (NM)									

 ATR 72 F.C.O.M.	APPROACH-LANDING CONTENTS	3.08.00		
		P 1	001	
				JUL 01

AA

- 3.08.00 CONTENTS**
- 3.08.01 APPROACH CLIMB LIMITING WEIGHT**
- 3.08.02 FINAL APPROACH SPEEDS**
- 3.08.03 LANDING DISTANCES**
- R 3.08.04 EXAMPLE OF LANDING CHART COMPUTED WITH THE FOS**

 ATR 72 E.C.O.M.	APPROACH-LANDING APPROACH CLIMB LIMITING WEIGHT	3.08.01		
		P 1	001	
				JUN 97

MA

- R ● **Aircraft configuration** :
 - R - Flaps 15 – Gear up
 - R - Affected propeller feathered
 - R - Remaining engine power set to "GO AROUND"
 - R - Air conditioning : OFF

- R ● **Steady gradient** :
 - R 2,1 %

- R ● **Go around speeds** :
 - R - Refer to "Procedures and Techniques" chapter, in 2.02 or to the QRH.

- R ● **Approach climb limiting weight** :
 - R **Normal Conditions** : Refer to the graph on 3.08.01 page 2.
 - R **Icing Conditions** : determine the approach climb limiting weight in normal conditions, then apply the decrement following the table 3.08.01 page 3.



AR72
F.C.O.M.

APPROACH-LANDING

APPROACH CLIMB LIMITING WEIGHT

3.08.01

P 2

300

JUN 97

NORMAL CONDITIONS FLAPS 15

One propeller feathered - one engine : GO AROUND POWER -
AIR CONDITIONING OFF - ANTI-ICING OFF - GEAR UP

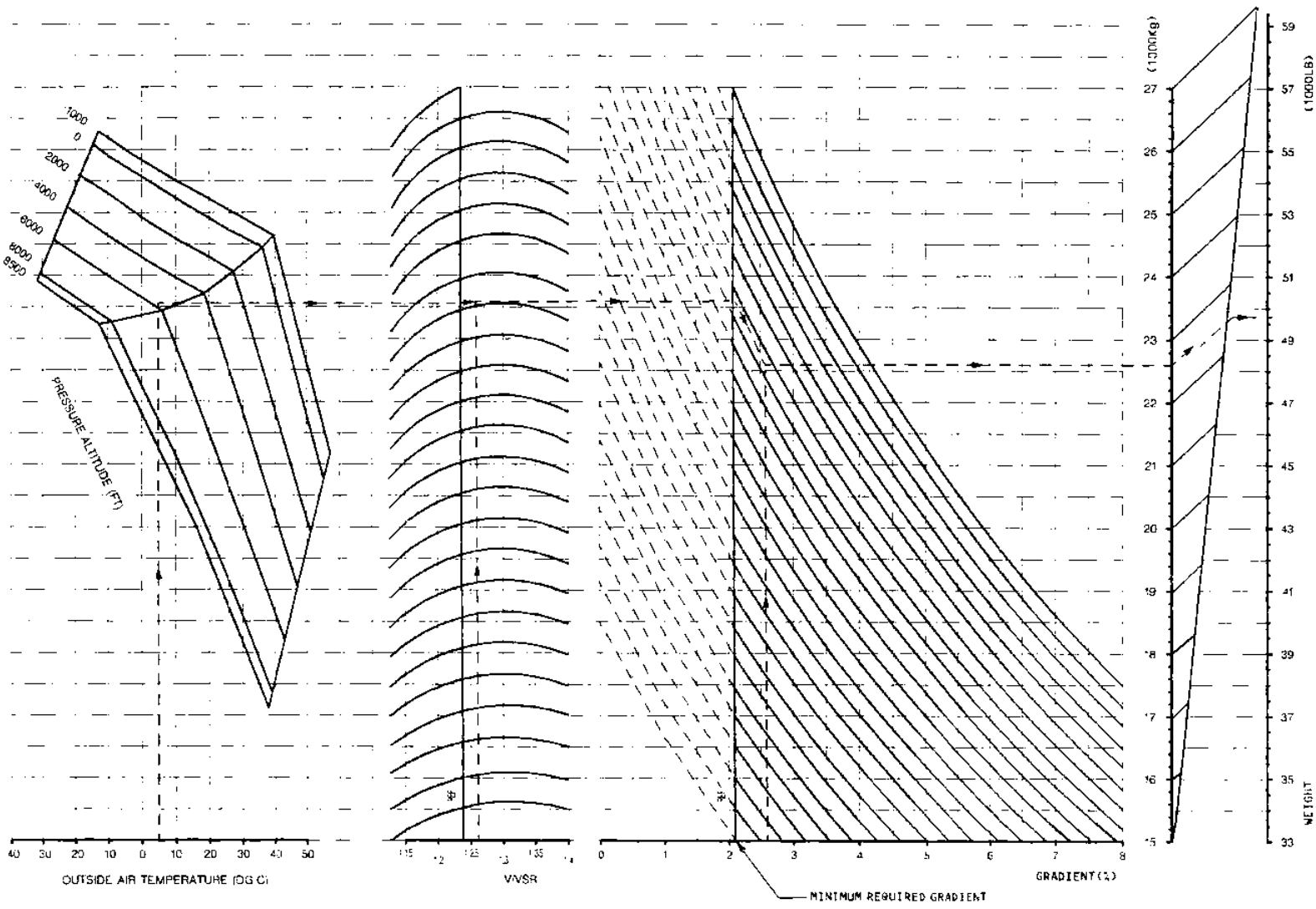

Eng. : PW127F

	APPROACH-LANDING	3.08.01	
	APPROACH CLIMB LIMITING WEIGHT	P 3	200
			JUN 97

AA

ICING CONDITIONS

In icing conditions, decrease the approach climb gradient limiting weight determined on paragraph 3.08.01 P 2 by the following values.

WEIGHT KG / LB	CORRECTION KG / LB
27 000 / 59 500	- 1 650 / - 3 650
25 000 / 55 100	- 1 500 / - 3 300
23 000 / 50 700	- 1 400 / - 3 100
21 000 / 46 300	- 1 300 / - 2 800
20 000 / 44 000	- 1 250 / - 2 750
19 000 / 41 800	- 1 150 / - 2 500
18 000 / 39 600	- 1 100 / - 2 400
17 000 / 37 500	- 1 050 / - 2 350
16 000 / 35 200	- 1 000 / - 2 200
and below	

	APPROACH-LANDING	3.08.02		
		P 1	500	
	FINAL APPROACH SPEEDS			JUL 98

AA

FINAL APPROACH SPEED

$V_{APP} = V_{mHB} + \text{WIND FACTOR}$
--

Wind factor :

The highest of

- 1/3 of the reported head wind velocity

-or-

- the gust in full

with a maximum wind factor of 15 kt.

R Wind factor is added to give extra margin against turbulence, risk of windshear etc...

FLAPS 30°

Weight (1000 kg)	VmHB IAS limited by VMCL	
	Normal conditions	Icing conditions
13	95	95
14	95	95
15	95	97
16	95	100
17	96	104
18	99	107
19	102	110
20	105	114
21	108	117
22	111	120
22.5	113	122

Weight (1000 lb)	VmHB IAS limited by VMCL	
	Normal conditions	Icing conditions
29	95	95
31	95	95
33	95	97
35	95	100
37	95	104
39	98	106
41	101	109
43	103	112
45	106	115
47	109	118
49	112	121

	APPROACH-LANDING		3.08.03		
			P 1	200	
	LANDING DISTANCES				JUN 97

AA

GENERAL

The actual distance to land an aircraft and come to a complete stop, is measured from a point 50 ft above the landing surface. This point is supposed to be above the threshold.

The deceleration mean is the normal braking system, antiskid being operative and both PL at GI (no reverse).

To determine the required runway length for landing, apply national operational regulation.

For information purpose, the actual landing distances are given on contaminated or wet runways.

Different cases may be considered :

- **Normal landing** – No significant failure:
Check before departure that available runway length with forecasted landing weight is at least equal to the required landing length
- **Abnormal landing** – Significant failure known before departure (in accordance with MEL) :
Check before departure that available runway length is at least equal to actual landing distance, taking into account performance abatements due to failures and is increased by operational regulatory coefficients.
- **Abnormal landing** – Significant failure resulting from in-flight events :
Check before landing that available runway length is at least equal to actual landing distance, taking into account performance abatements due to failures.

ACTUAL LANDING DISTANCE (M)

NORMAL CONDITIONS - FLAPS 30°

WEIGHT (x 1000 kg)		13	14	15	16	17	18	19	20	21	22	22.5
R U N W A Y C O N D I T I O N S	DRY	530	530	530	530	540	550	570	590	610	640	650
	WET	690	690	690	690	700	730	760	790	810	840	860
	WATER OR SLUSH 1/2 in	645	680	715	750	790	830	860	900	940	980	1000
	COMPACT SNOW	690	730	760	800	830	870	900	940	970	1000	1020
ICE	1020	1070	1120	1170	1230	1280	1340	1390	1450	1500	1530	

	APPROACH-LANDING					3.08.03		
	LANDING DISTANCES					P 2	200	
								JUL 00

AA ACTUAL LANDING DISTANCE (M)

ICING CONDITIONS - FLAPS 30°

WEIGHT (x 1000 kg)		13	14	15	16	17	18	19	20	21	22	22.5
R U N W A Y C O N D I T I O N B Y	DRY	570	570	570	570	580	600	620	650	670	700	710
	WET	760	760	770	770	770	810	840	870	900	940	960
	WATER OR SLUSH (<1/2 in)	690	730	760	800	840	890	930	970	1020	1060	1090
	COMPACT SNOW	750	790	830	870	910	950	1000	1040	1080	1110	1130
	ICE	1100	1160	1220	1280	1350	1410	1480	1540	1610	1670	1700

CORRECTION ON LANDING DISTANCES

Wind : • dry or wet runway
add 10 % per 5 kt tailwind
subtract 2 % per 5 kt headwind

• contaminated runway
add 16 % per 5 kt tailwind
subtract 2 % per 5 kt headwind

Airport elevation : • dry or wet runway
add 3 % per 1000 ft above sea level

• contaminated runway
add 5 % per 1000 ft above sea level

Effect of reverse: landing distances are decreased by

- 4 % on dry runway
- 7 % on wet runway
- 7 % on runway contaminated by water or slush
- 8 % on runway contaminated by compact snow
- 30 % on runway contaminated by ice

Caution : On contaminated runway, performances without reverser only are to be used for flight preparation.

Note : Landing on damp runway

A runway is damp when it is not perfectly dry, but when the water which is on it does not give a shiny appearance.

For damp runway, we consider no performance limitation.



AR72
F.C.O.M.

APPROACH – LANDING

3.08.03

P 3

001

LANDING DISTANCES

JUN 95

AA

R REQUIRED LANDING DISTANCE

R To determine the required runway length for landing apply national operational regulations.

CORRECTED LENGTHS TABLE

LENGTH	400	450	500	550	600	650	700	750
CORRECTED BY 1/0.6	665	750	835	915	1000	1085	1165	1250
CORRECTED BY 1/0.7	570	640	715	785	860	930	1000	1070

LENGTH	800	850	900	950	1000	1050	1100	1150
CORRECTED BY 1/0.6	1335	1415	1500	1585	1665	1750	1835	1915
CORRECTED BY 1/0.7	1145	1215	1285	1360	1430	1500	1570	1645

LENGTH	1200	1400	1600	1800	2000	2200	2400	2600
CORRECTED BY 1/0.6	2000	2335	2665	3000	3335	3665	4000	4335
CORRECTED BY 1/0.7	1715	2000	2285	2570	2860	3145	3430	3715

LENGTH	2800	3000	3200	3400	3600	3800	4000	4200
CORRECTED BY 1/0.6	4665	5000	5335	5665	6000	6335	6665	7000
CORRECTED BY 1/0.7	4000	4285	4570	4860	5145	5430	5715	6000



APPROACH-LANDING
USE OF FOS
FOS LANDING CHART EXAMPLE

3.08.04

P 1

001

JUL 01

AA

Note : The following landing chart is an example and cannot be used in operations.

Landing Chart Data										
WIND DIR SPEED KTS	FOS APPROACH FLS CAT 1 WET RUNWAY		QNH = 1013.25 (PSIA)					FOS APPROACH FLS CAT 1		
	10	5	0	10	20	30	NET WEIGHT CODE	5	10	20
10.0	20301	21050	21050	21050	21050	21050	18483	21050	21050	21050
0.0	20301	21050	21050	21050	21050	21050	18483	21050	21050	21050
1.0	20301	21050	21050	21050	21050	21050	18483	21050	21050	21050
10.0	20301	21050	21050	21050	21050	21050	18483	21050	21050	21050
15.0	20301	21050	21050	21050	21050	21050	1846	21050	21050	21050
20.0	20301	21050	21050	21050	21050	21050	18483	21050	21050	21050

CAUTION

1. FOS results must be verified against the Airplane Flight Manual performance data. In case of any discrepancy, the AFM performance data shall prevail.
2. It is the Operator's responsibility to update this chart in case of any change in runway or obstacle characteristics or in case of amendment of the AFM performance data.

Example :

- Tail wind : 5 kt
- Wet runway
- Temperature : 15° C

The maximum landing weight (Regulatory Landing Weight) is 18 483 kg because of the runway limitations.

	ONE ENGINE INOPERATIVE CONTENTS	3.09.00		
		P 1	001	
				DEC 95

AA

3.09.00 CONTENTS

3.09.01 GENERAL

3.09.02 FLIGHT PREPARATION
METHOD
NET CEILING
DOWN HILL RULE
200 KT IAS DESCENT

R

3.09.03 IN FLIGHT – PROCEDURE

3.09.10 IN FLIGHT – NORMAL DRIFT DOWN DESCENT

3.09.15 IN FLIGHT – ICING DRIFT DOWN DESCENT

R **3.09.16 IN FLIGHT – 200 KT IAS NORMAL DESENT**

R **3.09.17 IN FLIGHT – 200 KT IAS ICING DESCENT**

3.09.20 IN FLIGHT – NORMAL CONDITIONS CRUISE

3.09.25 IN FLIGHT – ICING CONDITIONS CRUISE

R **3.09.30 IN FLIGHT – NORMAL CONDITIONS HOLDING**

R **3.09.35 IN FLIGHT – ICING CONDITIONS HOLDING**

	ONE ENGINE INOPERATIVE	3.09.01		
		P 1	001	
	GENERAL			DEC 95

AA

En route single engine performance have to be considered at two levels :

• **FLIGHT PREPARATION**

Net performance are used (1.1 % penalty)

R The method, the net ceilings and the down hill rules (DHR and 200 KT IAS) are given in part 3.09.02.

• **IN FLIGHT**

Gross performance are used (real performance without penalties)

R The drift down procedure, with or without obstacles, is given in part 3.09.03

In both cases, operative engine is at MCT power (NP = 100 %). Air conditioning is ON above 10000 ft, OFF below.

Both atmospheric conditions are considered :

• **NORMAL CONDITIONS**

Drift down descent tables : 3.09.10

R 200 KT IAS descent tables : 3.09.16

Cruise 1 engine tables : 3.09.20

R Holding 1 engine tables : 3.09.30

• **ICING CONDITIONS**

R Drift down descent tables : 3.09.15

R 200 KT IAS descent tables : 3.09.17

Cruise 1 engine tables : 3.09.25

R Holding 1 engine tables : 3.09.35

Atmospheric icing conditions exist when TAT in flight is at or below 7°C and visible moisture in any form is present (clouds, fog with visibility of less than one mile, rain, snow, sleet and ice crystals).

Note : All performance data given for ICING CONDITIONS derive from flight tests measurements performed with ICE SHAPES representative of the worst icing cases considered by certification and applicable losses of propeller efficiency.

Because of the variability of REAL ICING, performance published for icing conditions must be regarded as operational information only.

 ATR 72 F.C.O.M.	ONE ENGINE INOPERATIVE FLIGHT PREPARATION	3.09.02		
		P 1	001	
				JUN 96

AA

METHOD

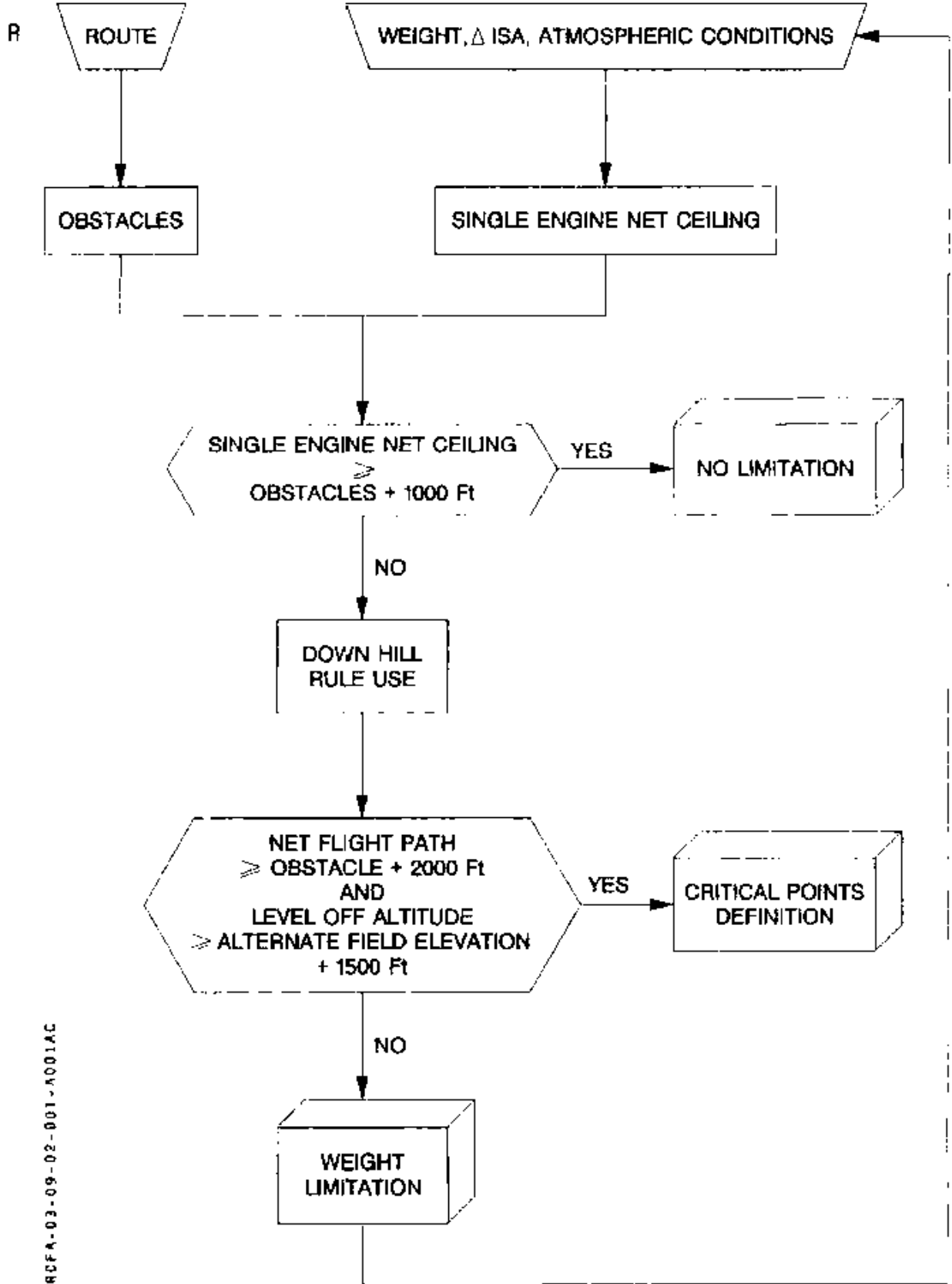

RCFA-03-09-02-001-A001AC

AA

NET CEILING

Considering the atmospheric conditions of the day, read your net ceiling on one of the two following graphs :

● **NORMAL CONDITIONS - FLAPS 0**

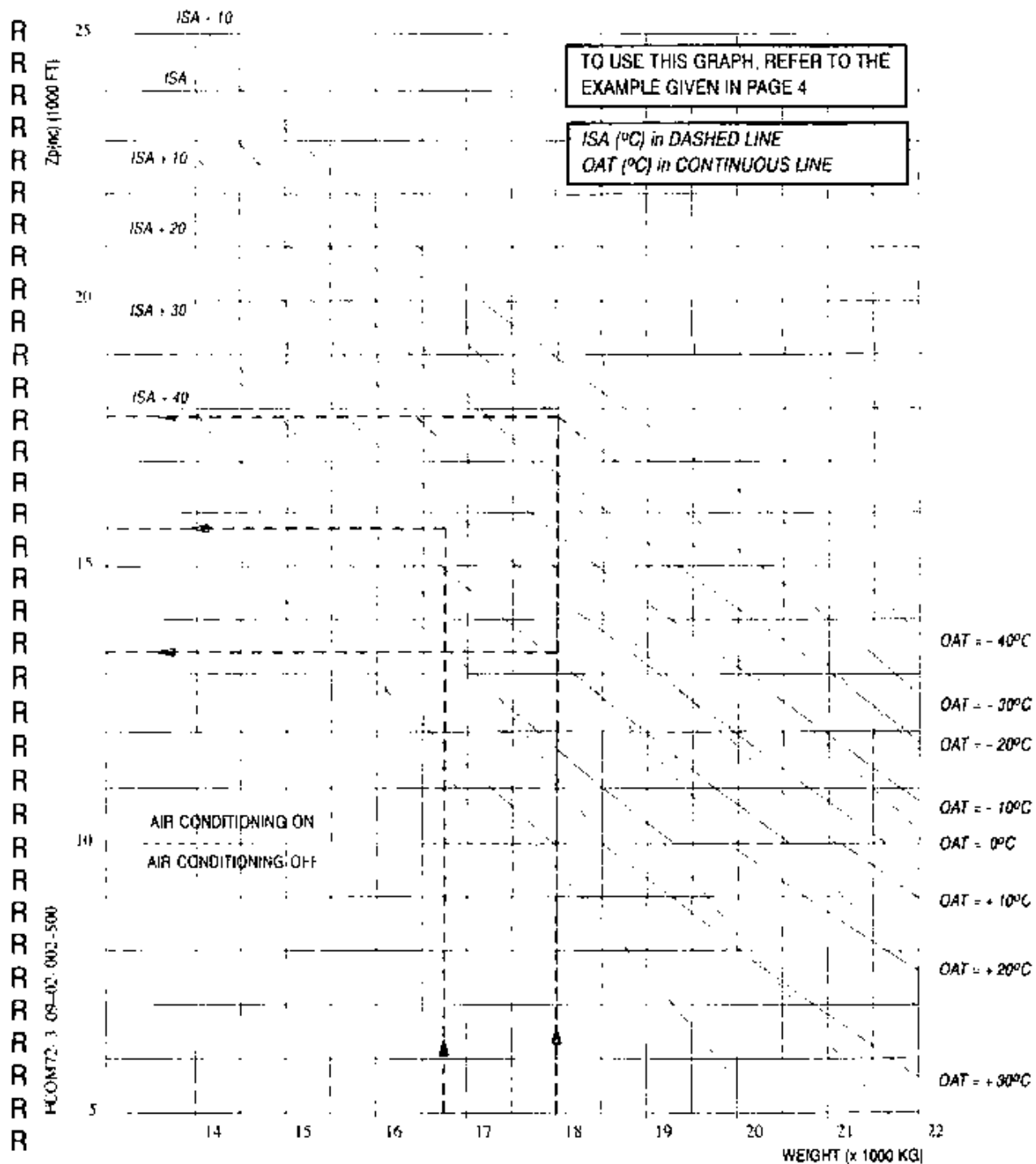

Examples :

1 16750 KG ; ISA +20°C ⇒ Net ceiling : Zp(nc) = 15700 ft

2 18000 KG ; OAT = -30°C ⇒ Net ceiling : Zp(nc) = 17800 ft

● **NET CEILING IN ICING CONDITIONS - FLAPS 15**

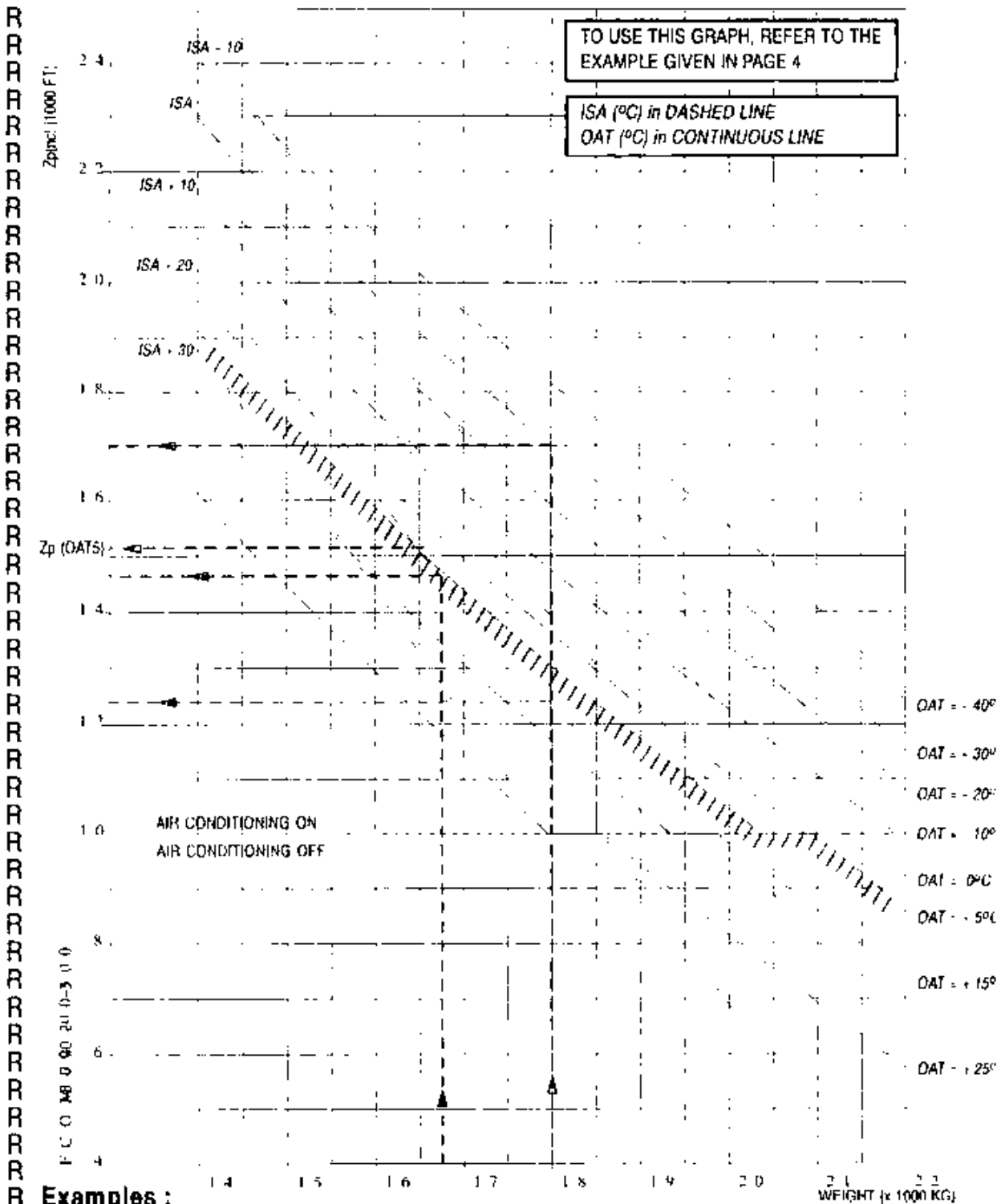

- Examples :**
- ① 18000 KG ; OAT = -30°C ⇒ Net Ceiling : Zp(ic) = 17000 ft.
 - ② 18000 KG ; ISA +20°C ⇒ The corresponding OAT is greater than 5°C, so refer to the Normal Conditions graph (page 2) : for 18000 KG and ISA+20°C, the Net Ceiling is : Zp(nc) = 13400 ft.
- Transition altitude from Icing to Normal Conditions for ISA+20°C (intersection between ISA +20°C and OAT = 5°C) ⇒ Zp(OAT=5) = 15000 ft.

	ONE ENGINE INOPERATIVE	3.09.02		
	FLIGHT PREPARATION	P 4	500	
				JUL 98

AA

R • DHR EXAMPLES IN ICING CONDITIONS

R In Icing Conditions, two kinds of DHR have to be considered :

R - The level off net ceiling corresponds to an OAT less than 5°C : all the descent is performed in Icing Conditions (Example ①)

R - The level off net ceiling corresponds to an OAT greater than 5°C : the descent is performed in Icing Conditions until OAT = 5°C, and in Normal Conditions for OAT greater

R than 5°C (Examples ② and ③)

R ① Initial parameters at engine failure :

R 25000 ft ; Icing Conditions ; 18000 kg ; OAT = -30°C ; No wind

R ∴ Read the net ceiling on the Icing Conditions graph (page 3) : $Z_p(ic) = 17000$ ft.

R The height above the ceiling is : $25000 - 17000 = 8000$ ft.

R ∴ Referring to page 6, the distance to reach the ceiling of 17000 ft is : $200 - 65 = 135$ NM.

R ② Initial parameters at engine failure :

R 25000 ft ; Icing Conditions ; 18000 kg ; ISA + 20°C ; No wind

R ∴ Referring to the Icing Conditions graph (page 3), for 18000 kg and ISA+20°C, the associated OAT is greater than 5°C, so read on this graph :

R - The Icing Conditions fictitious Net Ceiling, i.e. : $Z_p(ic) = 12400$ ft ;

R - The transition altitude from Icing to Normal Conditions for ISA+20°C (intersection between ISA+20°C line and OAT = 5°C line) : $Z_p(OAT 5) = 15200$ ft.

R ∴ The level off net ceiling is read on the Normal Conditions graph (page 2) : $Z_p(nc) = 13400$ ft.

R a) Determine the distance covered in Icing Conditions using the graph page 6 :

R $D(ic) = d(25000-12400) - d(15200-12400) = d(12600) - d(2800) = 113 - 42 = 71$ NM ;

R b) Determine the distance covered in Normal Conditions using the graph page 5 :

R $D(nc) = d(15200-13400) = d(1800) = 230 - 145 = 85$ NM ;

R c) The total distance to reach the ceiling of 13400 ft is :

R $D = D(ic) + D(nc) = 71 + 85 = 156$ NM

R ③ Same example than ②, but with weight = 16750 kg :

R ∴ Referring to the Icing Conditions graph (page 3), for 16750 kg and ISA+20°C, the associated

R OAT is greater than 5°C. So, read on this graph the transition altitude from Icing to Normal Conditions for ISA+20°C : $Z_p(OAT 5) = 15200$ ft.

R ∴ On the Normal Conditions graph (page 2), you read a net ceiling $Z_p(nc) = 15700$ ft that is higher than $Z_p(OAT 5) = 15200$ ft. **So, you must keep as level off net ceiling $Z_p(OAT 5) = 15200$ ft**, the aircraft being set to the Normal Condition configuration (Flaps 0°, Anti/De-icing Off).

R It is prohibited to go up to $Z_p(nc)$.

R ∴ The total distance to reach the ceiling of 15200 ft is determined using the graph page 6 :

R $D = D(ic) + d(25000 - 15200) = d(9800) = 200 - 55 = 145$ NM.

• CORRECTIONS ON GEOMETRICAL ALTITUDE

To take into account the actual atmospheric conditions (pressure, temperature), refer to the operating data 3.01 chapter.



ONE ENGINE INOPERATIVE

FLIGHT PREPARATION

3.09.02		
P 5	300	
		JUL 98

DOWN HILL RULE

Single engine net ceiling being computed, following graphs give net descent flight path down to this ceiling with the LO BANK speed V_{MLB} associated to the day conditions (flaps 0° normal conditions or flaps 15° icing conditions).

NORMAL CONDITIONS

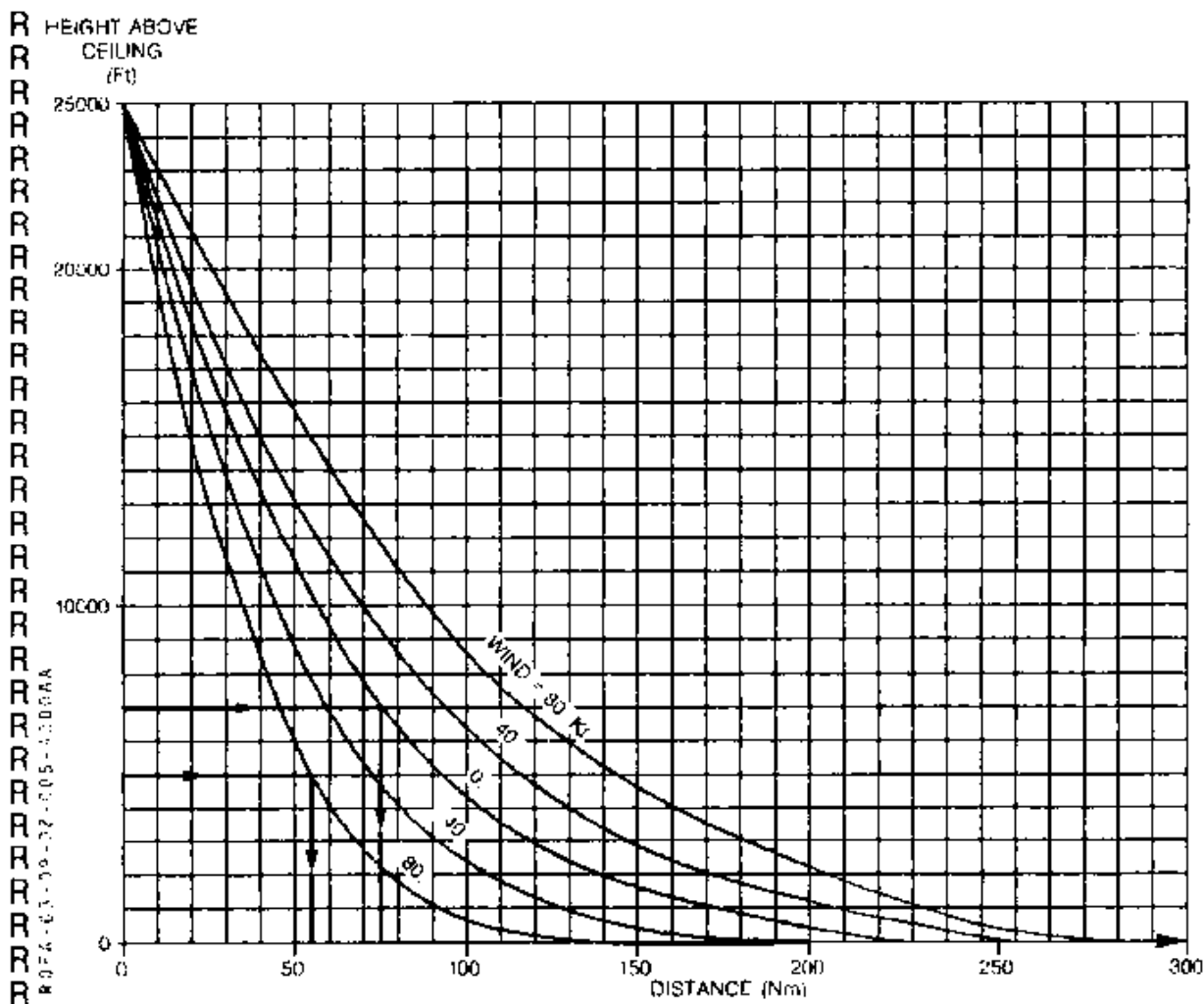

Examples :

Height above ceiling = 7000 ft
 No wind
 Distance to reach the ceiling = 230 - 75 = 155 Nm

- R Height above ceiling = 5000 ft
- R Wind = -80 kt (headwind)
- Distance to reach the ceiling = 130 - 55 = 75 Nm.



NR72
F.C.O.M.

ONE ENGINE INOPERATIVE

FLIGHT PREPARATION

3.09.02

P 6

300

JUL 98

ICING CONDITIONS

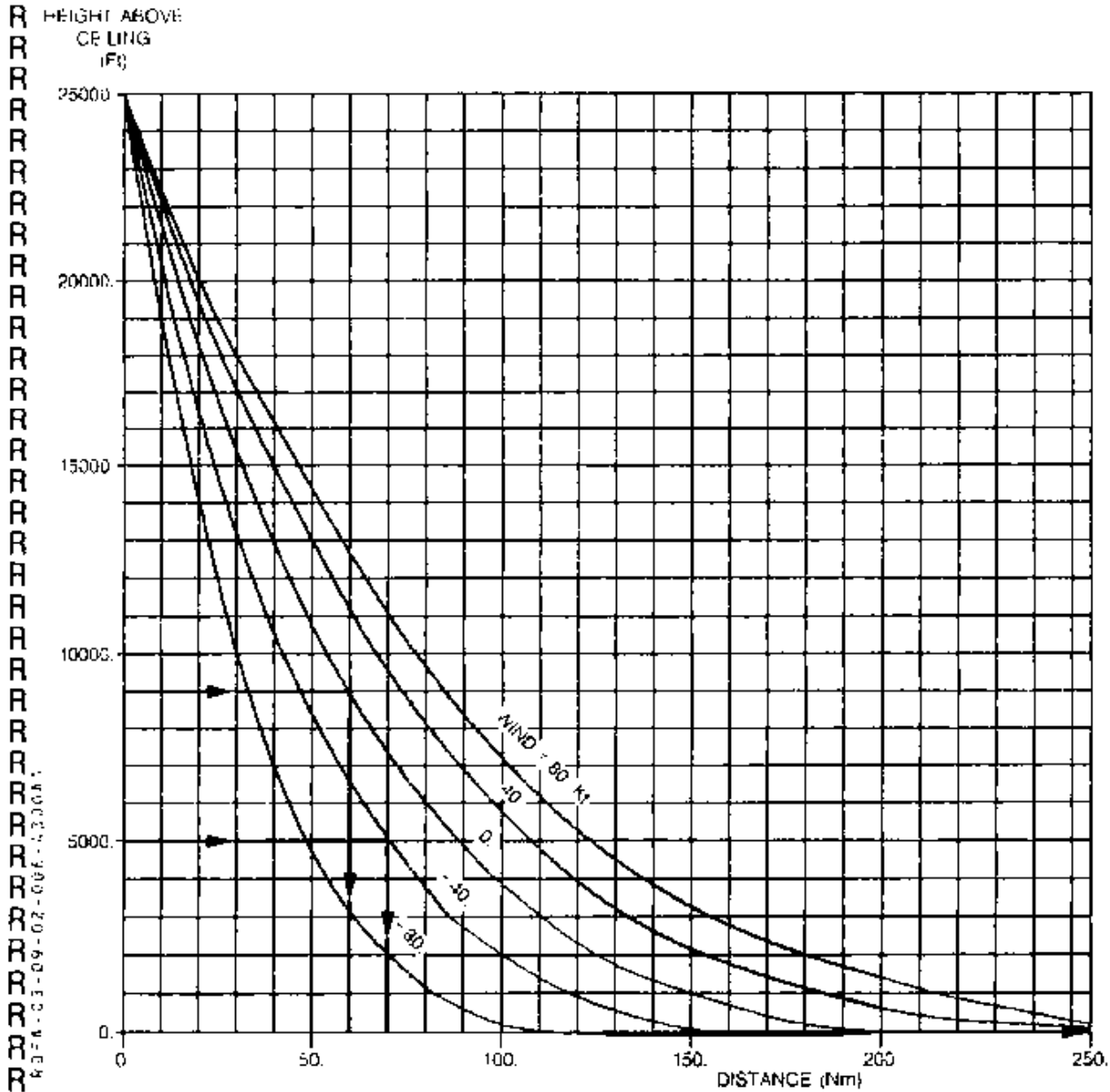

Examples :

Height above ceiling = 9000 ft

No wind

Distance to reach the ceiling = $200 - 60 = 140$ Nm

Height above ceiling = 5000 ft

R Wind = -40 kt (headwind)

Distance to reach the ceiling = $150 - 70 = 80$ Nm.

AA

200 KT IAS DESCENT

It the particular case where no obstacle is limiting, the hereafter graphs give the net descent flight path down to the selected level at 200 kt IAS with flaps 0°.

NET DESCENT FLIGHT PATH - NORMAL CONDITIONS

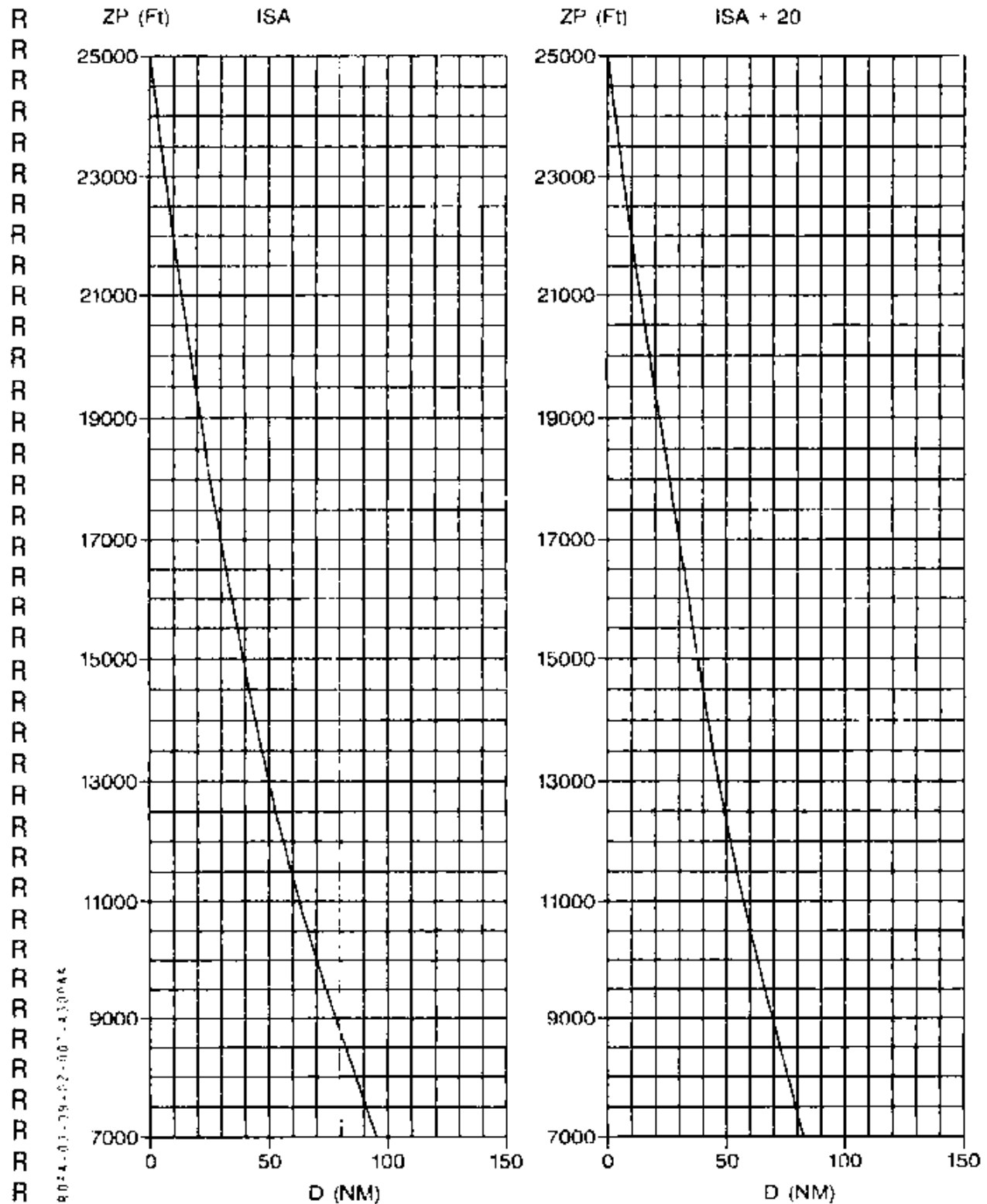



AR72
F.C.O.M.

ONE ENGINE INOPERATIVE

FLIGHT PREPARATION

3.09.02

P 8

300

JUL 98

AA

NET DESCENT FLIGHT PATH - ICING CONDITIONS

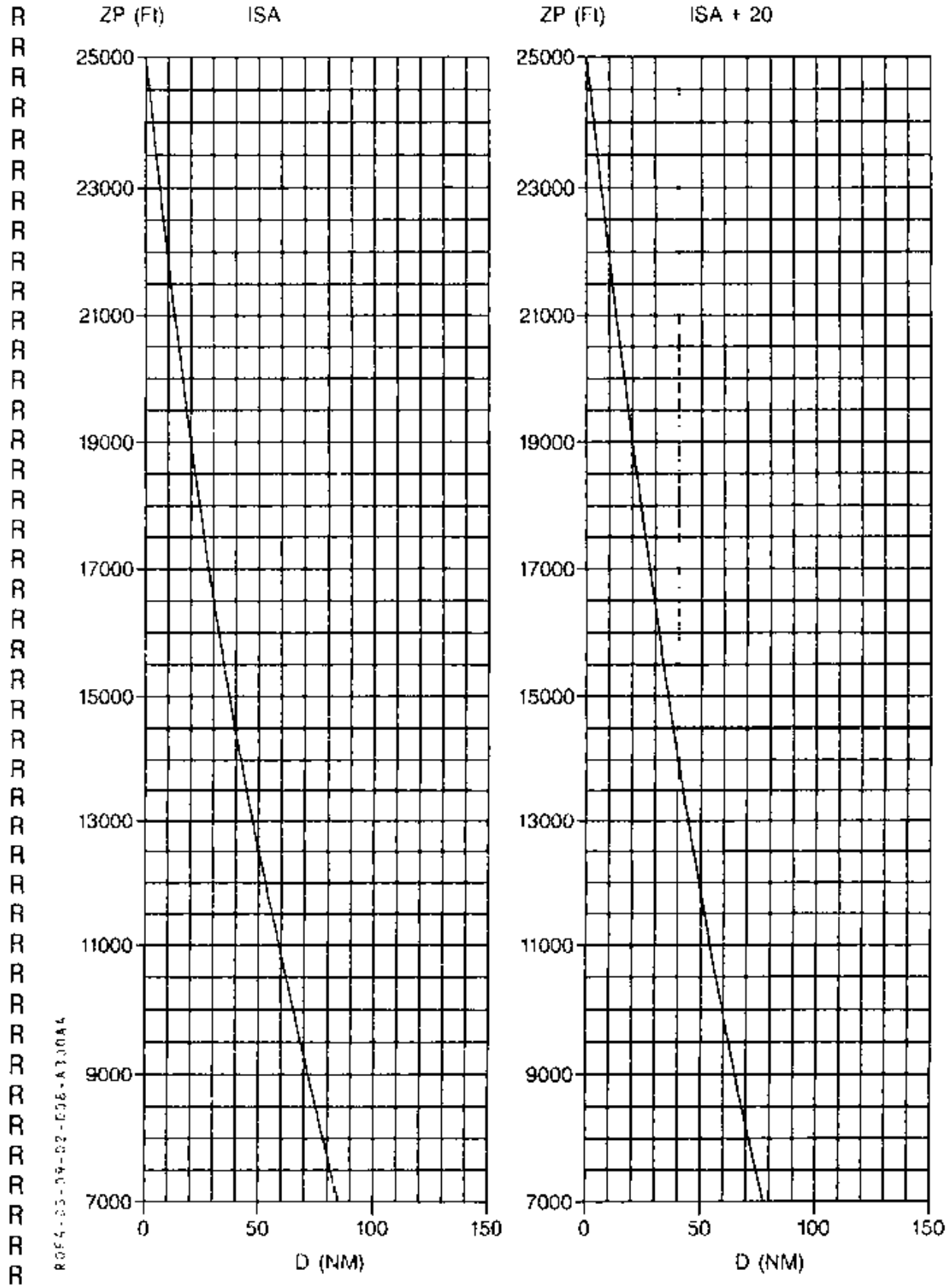

ROF4-05-09-02-E06-A100A4

 AJR72 F.C.O.M.	ONE ENGINE INOPERATIVE PROCEDURE IN FLIGHT	3.09.03		
		P 1	001	
				JUL 98

AA

PROCEDURE

■ **IF OBSTACLE PROBLEM EXISTS**

In order to maintain the highest level possible, the drift down procedure should be used :

- MCT on operative engine
- R ● Decision related to decision points
- R ● Deceleration in flight level down to drift down speed which then will be maintained (IAS mode).
 - In normal conditions V_{MLB0}
 - In icing conditions $V_{MLB 15}$ (flaps 15 will be selected when below VFE)
- LO BANK mode selection
 - If, having reached drift down ceiling altitude, obstacle problem persists, the drift down procedure is continued to make an ascending cruise.
 - If, after drift down, obstacles are cleared, the subsequent cruise will be performed using maximum continuous thrust on the remaining engine and the cruise 1 engine tables.
If possible, the flight levels 70/80 are recommended to optimize the cruise speed.

Note : A particular attention will be payed to the fuel balance. When the dissymetry reaches 100 kg (220 lb), the use of the fuel crossfeed is recommended to balance the wings.

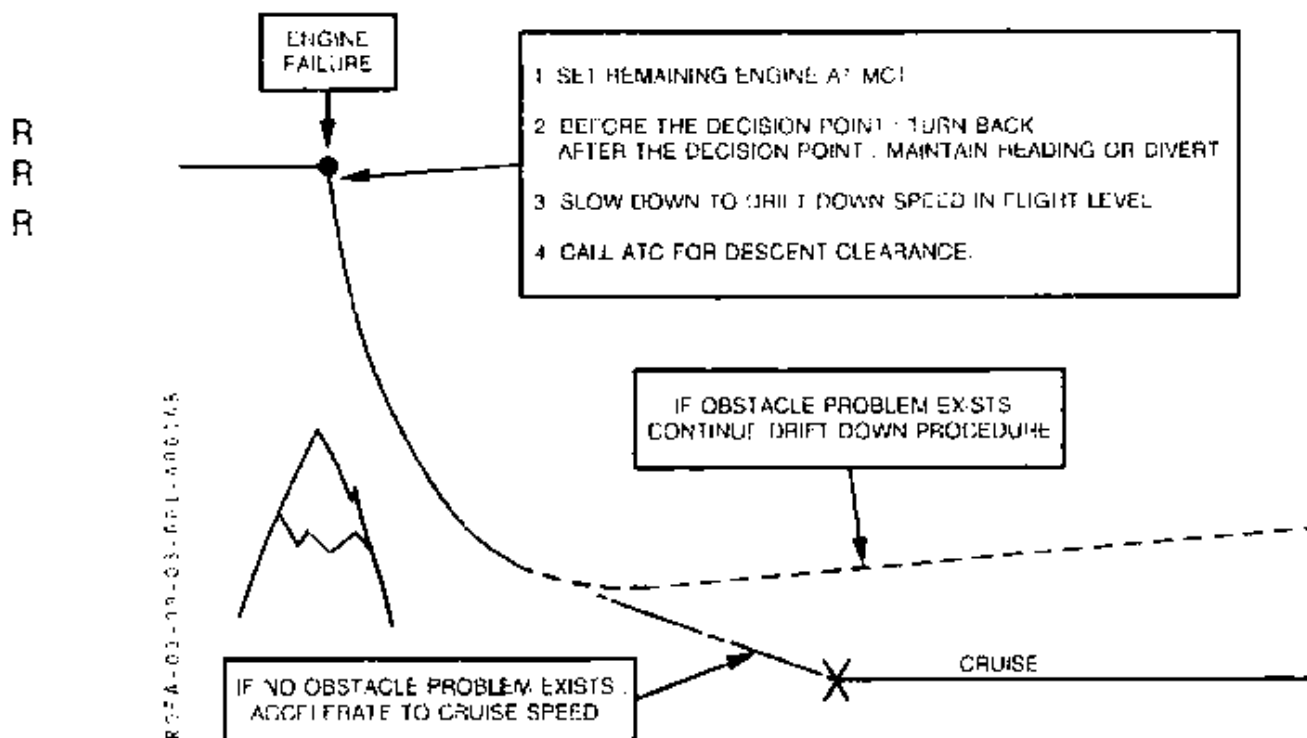

	ONE ENGINE INOPERATIVE PROCEDURE IN FLIGHT	3.09.03		
		P 2	001	
				DEC 97

AA

R ■ If no obstacle problem exists

R Drift down procedure is not necessary. A descent at maximum continuous power will be performed at 200 kt IAS. When the vertical speed slows down to 500ft/mn maintain this value by increasing the speed.

R Aircraft will be levelled when reaching the chosen cruise altitude.

R When possible, FL 70/80 is recommended in order to optimize the speed.

R Use 200 kt IAS descent tables (3.09.16 or 17) and 1 engine cruise tables (3.09.20 or R 25).

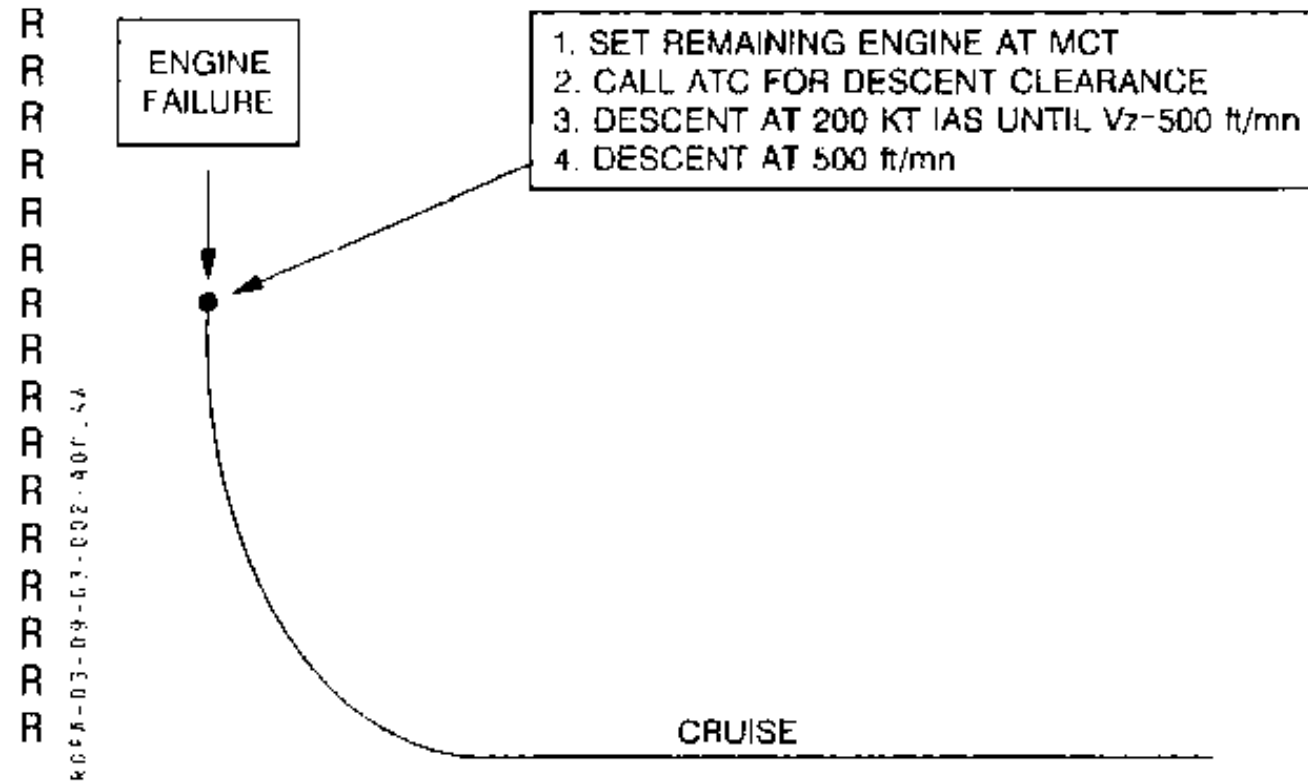

R **Note :** A special attention should be paid to the fuel unbalance.

R It is recommended to balance the tanks using the fuel crossfeed when the dissymmetry reaches 100 kg (or 200 lbs).

	ONE ENGINE INOPERATIVE PROCEDURE IN FLIGHT	3.09.03		
		P 3	001	
				JUL 98

AA

DRIFT DOWN DESCENT TABLES

METHOD OF USE

Choose in the next pages, the table corresponding to atmospheric conditions (normal or icing, Δ ISA).

R Select aircraft weight and flight level when failure occurs.

R Example : 21000 kg, FL 240

INIT. GW (1000 KG)	INITIAL FLIGHT LEVEL					
	160	180	200	220	240	250
21	105 37.4	165 58.1	193 67.2	218 75.5	232 79.8	239 81.9
	138 237	138 360	138 410	138 455	138 475	138 485
	15300	15500	15500	15600	15600	15600

R Values to be used as example only.

R The table gives drift down ceiling (15600 ft) and air distance to cover to reach this altitude (232 Nm).

R It is also possible to determine air distance to cover to reach an intermediate level.
From FL 240 down to FL 200, Air Dist = 232 - 193 = 39 Nm

The ground distance corresponding to the air distance according to the wind value is given in the chart hereafter :

Air Distance Nm	Wind (kt)				
	- 80	- 40	0	40	80
10	5	8	10	12	15
20	11	15	20	25	29
30	16	23	30	37	44
40	21	31	40	49	59
50	26	38	50	62	74
60	32	46	60	74	88
70	37	54	70	86	103
80	42	61	80	99	118
90	48	69	90	111	132
100	53	76	100	124	147

R COMPUTATION ASSUMPTIONS IN ICING CONDITIONS

R The drift down tables are computed with flaps 15° and ice accretion above icing altitude

R (TAT \leq 7°C) and with flaps 0° without ice accretion below icing altitude (TAT $>$ 7°C).

 A320 F.C.D.M.	ONE ENGINE INOPERATIVE NORMAL DRIFT DOWN DESCENT IN FLIGHT	3.09.10		
		P 1	500	
				JUN 97

DRIFT DOWN DESCENT GROSS FLIGHT PATH AT DRIFT DOWN SPEED AIR CONDITIONING ON 1 ENGINE AT MCT (NP=100%) FLAPS 0							NORMAL CONDITIONS ISA-10
INIT. GW (1000KG)	INITIAL FLIGHT LEVEL						
	160	180	200	220	240	250	
22	39 13.7 139 99 15900	141 48.8 139 345 16200	177 60.9 139 423 16300	199 67.9 139 465 16300	217 73.5 139 497 16400	225 76.2 139 512 16400	
21		94 32.8 135 224 17400	155 53.6 136 359 17600	190 65.3 136 430 17700	208 71.0 136 461 17700	215 73.2 136 472 17700	
20			117 40.8 132 264 18900	165 56.9 132 360 19000	194 66.5 132 415 19100	202 69.2 132 429 19100	
19				134 46.7 129 285 20400	173 59.7 129 357 20600	185 63.8 129 378 20600	
18				49 17.3 125 102 21800	138 47.9 125 275 22100	158 54.7 125 311 22100	
17					78 27.2 121 150 23600	120 41.9 122 228 23700	
16							
15							
14							
13							

DISTANCE (NM) INITIAL SPEED (KT) LEVEL OFF (FT)	TIME (MN) FUEL (KG)
---	------------------------



AR72
F.C.O.M.

**ONE ENGINE INOPERATIVE
NORMAL DRIFT DOWN DESCENT**

IN FLIGHT

3.09.10

P 2

500

JUN 97

DRIFT DOWN DESCENT

**GROSS FLIGHT PATH AT DRIFT DOWN SPEED
AIR CONDITIONING ON
1 ENGINE AT MCT (NP=100%)
FLAPS 0**

**NORMAL CONDITIONS
ISA**

INIT. GW (1000KG)	INITIAL FLIGHT LEVEL					
	160	180	200	220	240	250
22	123 42.9	171 59.1	198 68.0	216 73.5	233 78.8	240 80.8
	139 309	139 418	139 473	139 505	139 534	139 544
	14800	14900	15000	15100	15100	15100
21	40 14.0	142 49.5	183 63.2	203 69.4	221 75.0	233 78.9
	135 98	135 338	136 423	136 458	136 488	136 511
	15900	16200	16300	16400	16400	16400
20		92 32.4	157 54.5	191 65.9	212 72.5	222 75.7
		132 213	132 351	132 419	132 454	132 471
		17400	17700	17700	17800	17800
19			116 40.5	165 57.2	192 66.1	204 70.0
			129 252	129 349	129 396	129 416
			19000	19200	19300	19300
18				124 43.3	165 57.1	179 61.8
				125 254	125 328	125 352
				20700	20800	20900
17					131 45.6	155 53.7
					121 251	122 292
					22400	22500
16					38 13.5	110 38.3
					118 72	118 200
					23900	24100
15						
14						
13						

DISTANCE (NM)
INITIAL SPEED (KT)
LEVEL OFF (FT)

TIME (MN)
FUEL (KG)

 ATR 72 F.C.O.M.	ONE ENGINE INOPERATIVE		3.09.10	
	NORMAL DRIFT DOWN DESCENT		P 3	500
	IN FLIGHT			JUN 97

AA

DRIFT DOWN DESCENT						
GROSS FLIGHT PATH AT DRIFT DOWN SPEED						
AIR CONDITIONING ON						
1 ENGINE AT MCT (NP=100%)						
FLAPS 0						
NORMAL CONDITIONS						
ISA+10						
INIT. GW (1000KG)	INITIAL FLIGHT LEVEL					
	160	180	200	220	240	250
22	169 59.0 139 423 13300	202 69.9 139 493 13400	223 76.6 139 533 13500	239 81.4 139 559 13500	259 87.5 139 594 13600	263 88.7 139 598 13600
21	133 46.7 135 324 14700	180 62.6 135 426 14800	211 72.9 136 489 14900	232 79.3 136 525 15000	244 82.9 136 541 15000	252 85.4 136 554 15000
20	41 14.5 132 97 15900	146 51.1 132 336 16300	188 65.3 132 421 16400	211 72.6 132 461 16500	230 78.4 132 491 16500	238 80.9 132 504 16500
19		82 28.7 129 182 17600	157 54.7 129 340 17800	189 65.3 129 398 17900	215 73.7 129 443 18000	223 76.3 129 455 18000
18			102 35.9 125 215 19300	161 56.1 125 328 19500	190 65.4 125 376 19600	203 69.8 125 399 19600
17				111 39.0 121 219 21100	162 56.3 121 310 21200	177 61.3 122 335 21300
16					119 41.7 118 220 22900	146 50.8 118 265 22900
15						71 24.7 114 124 24600
14						
13						
DISTANCE (NM)			TIME (MN)			
INITIAL SPEED (KT)			FUEL (KG)			
LEVEL OFF (FT)						

 AR72 F.C.O.M.	ONE ENGINE INOPERATIVE NORMAL DRIFT DOWN DESCENT IN FLIGHT	3.09.10		
		P 4	500	
				JUN 97

AA

DRIFT DOWN DESCENT						
GROSS FLIGHT PATH AT DRIFT DOWN SPEED AIR CONDITIONING ON 1 ENGINE AT MCT (NP=100%)						
				NORMAL CONDITIONS		
				ISA +20		
INIT. GW (1000KG)	INITIAL FLIGHT LEVEL					
	160	180	200	220	240	250
22	196 68.2	222 76.6	239 82.0	255 86.8	271 91.6	274 92.5
	139 489	139 541	139 571	139 597	139 623	139 625
	12000	12100	12100	12200	12200	12200
21	174 60.8	201 69.9	227 78.4	243 83.2	259 88.0	263 89.0
	135 421	135 475	136 526	136 550	136 575	136 577
	13300	13400	13500	13500	13600	13600
20	134 47.2	179 62.7	207 72.0	230 79.3	247 84.3	254 86.4
	132 315	132 410	132 463	132 503	132 528	132 538
	14700	14800	14900	15000	15000	15000
19	41 14.6	148 52.0	189 65.9	214 74.1	236 81.3	245 84.0
	129 94	129 327	129 407	129 451	129 488	129 501
	15900	16200	16400	16400	16500	16500
18		71 25.3	156 54.9	193 67.1	219 75.7	227 78.1
		125 153	125 325	125 391	125 435	125 445
		17600	17900	18000	18100	18100
17			92 32.4	165 57.7	196 67.9	209 72.2
			121 185	121 323	121 373	122 394
			19500	19700	19900	19900
16				92 32.5	161 56.0	178 61.9
				118 175	118 295	118 323
				21500	21700	21800
15					96 33.7	134 46.7
					114 170	114 233
					23400	23500
14						
13						
DISTANCE (NM)			TIME (MN)			
INITIAL SPEED (KT)			FUEL (KG)			
LEVEL OFF (FT)						



**ONE ENGINE INOPERATIVE
ICING DRIFT DOWN DESCENT**

IN FLIGHT

3.09.15

P 1

500

JUN 97

DRIFT DOWN DESCENT

**GROSS FLIGHT PATH AT DRIFT DOWN SPEED
AIR CONDITIONING ON
1 ENGINE AT MCT (NP=100%)
FLAPS 15**

**ICING CONDITIONS
ISA-10**

INIT. GW (1000KG)	INITIAL FLIGHT LEVEL					
	160	180	200	220	240	250
22	103 38.4	151 56.2	173 63.7	193 70.6	207 75.0	213 77.0
	131 284	131 406	131 453	131 494	131 519	131 529
	15000	15200	15300	15300	15300	15400
21		122 45.5	157 58.2	182 67.0	198 72.4	205 74.7
		127 317	127 398	128 452	128 481	128 493
		16400	16600	16600	16700	16700
20		56 21.1	133 49.8	163 60.4	185 67.8	192 70.2
		124 142	124 328	124 391	124 433	124 445
		17700	18000	18100	18100	18200
19			85 31.8	141 52.5	167 61.7	181 66.6
			121 203	121 328	121 378	121 406
			19400	19600	19700	19700
18				97 36.5	143 53.0	157 58.0
				117 219	117 312	117 339
				21100	21300	21300
17					105 39.3	130 48.4
					114 222	114 271
					22900	23000
16						71 26.8
						110 144
						24600
15						
14						
13						

DISTANCE (NM)
INITIAL SPEED (KT)
LEVEL OFF (FT)

TIME (MN)
FUEL (KG)



AR72
F.C.O.M.

**ONE ENGINE INOPERATIVE
ICING DRIFT DOWN DESCENT**

IN FLIGHT

3.09.15

P 2

500

DEC 97

AA

DRIFT DOWN DESCENT

**GROSS FLIGHT PATH AT DRIFT DOWN SPEED
AIR CONDITIONING ON
1 ENGINE AT MCT (NP=100%)
FLAPS 15**

**ICING CONDITIONS
ISA**

INIT. GW (1000KG)	INITIAL FLIGHT LEVEL						
	160	180	200	220	240	250	
22	140 52.3 131 385 13800	172 63.5 131 459 13900	192 70.7 131 503 14000	208 75.7 131 532 14000	220 79.8 131 553 14000	231 83.4 131 575 14100	
	21	104 38.9 127 277 15000	152 56.6 127 394 15200	178 65.8 127 451 15300	197 72.2 128 488 15300	213 77.6 128 517 15400	219 79.6 128 527 15400
		20		121 45.4 124 305 16600	158 58.6 124 387 16700	183 67.5 124 438 16800	200 73.0 124 468 16800
19				39 14.7 121 96 17800	130 48.5 121 308 18200	163 60.5 121 378 18300	187 69.0 121 424 18400
	18				60 22.4 117 138 19600	137 51.0 117 307 19900	167 61.8 117 365 20000
		17				83 31.1 114 180 21400	138 51.3 114 290 21600
16							94 35.1 110 190 23200
	15						
		14					
13							

DISTANCE (NM)
INITIAL SPEED (KT)
LEVEL OFF (FT)

TIME (MN)
FUEL (KG)

 ATR 72 F.C.O.M.	ONE ENGINE INOPERATIVE ICING DRIFT DOWN DESCENT IN FLIGHT	3.09.15		
		P 3	500	
				JUN 97

AA

DRIFT DOWN DESCENT						
GROSS FLIGHT PATH AT DRIFT DOWN SPEED AIR CONDITIONING ON 1 ENGINE AT MCT (NP=100%) FLAPS 15						
ICING CONDITIONS						
ISA+10						
INIT. GW (1000KG)	INITIAL FLIGHT LEVEL					
	160	180	200	220	240	250
22	170 63.4 131 465 12300	196 72.4 131 522 12400	216 79.6 131 566 12500	231 84.4 131 593 12500	241 87.4 131 606 12500	247 89.1 131 615 12500
21	150 56.5 127 399 13700	184 68.4 127 476 13800	204 75.5 127 517 13800	221 81.2 128 549 13900	235 85.7 128 572 13900	243 88.4 128 587 13900
20	105 39.5 124 270 15100	157 58.6 124 393 15300	183 67.8 124 447 15400	206 75.7 124 493 15400	218 79.6 124 511 15500	227 82.7 124 527 15500
19		113 42.5 121 275 16800	157 58.4 121 371 17000	184 68.1 121 426 17000	202 74.1 121 456 17100	211 77.2 121 472 17100
18			124 46.4 117 284 18500	162 60.3 117 362 18600	187 69.1 117 408 18700	197 72.3 117 423 18700
17			30 11.2 114 66 19900	129 48.4 114 279 20300	164 60.9 114 345 20400	178 65.6 114 368 20400
16				46 17.5 110 97 21800	132 49.2 110 266 22100	150 55.9 110 299 22200
15					55 20.8 106 108 23700	108 40.4 106 207 23900
14						
13						
DISTANCE (NM)			TIME (MN)			
INITIAL SPEED (KT)			FUEL (KG)			
LEVEL OFF (FT)						



AR72
F.C.O.M.

ONE ENGINE INOPERATIVE
200KT IAS NORMAL DESCENT
IN FLIGHT

3.09.16

P 1

500

JUN 97

AA

DESCENT 1 ENGINE

200KT(IAS) and VZ NOT LESS THAN 500 FT/MN

ISA-10 (.C)

CLEAN CONFIGURATION

AIR COND FLOW:NORM

ANTI/DE ICING:OFF

FL	WEIGHT (1000KG)							
	14	15	16	17	18	19	20	21
250	28 223	29 226	29 228	29 229	29 230	29 230	29 230	29 230
	117 63	119 63	120 63	121 63	121 63	122 63	122 63	122 63
230	27 213	27 216	27 218	27 218	27 219	27 219	27 219	27 218
	109 67	111 67	112 67	113 67	113 67	113 67	113 67	113 67
210	25 201	25 203	25 204	25 205	25 205	25 205	25 205	25 204
	101 71	102 71	103 71	103 71	103 71	103 71	103 71	103 71
190	22 186	23 187	23 188	23 188	23 188	23 188	23 188	23 187
	91 75	92 75	92 75	93 75	93 75	93 75	92 75	92 75
170	20 166	20 166	20 167	20 166	20 166	20 166	20 166	20 165
	79 79	80 79	80 79	80 79	80 79	80 79	80 79	79 79
150	16 137	16 137	16 137	16 137	16 137	16 137	16 137	16 137
	64 84	64 84	64 84	65 84	65 84	65 84	65 84	64 84
130	12 104	12 104	12 104	12 104	12 104	12 104	12 104	12 104
	48 90	48 90	48 90	48 90	48 90	48 90	48 90	48 90
110	8 69	8 69	8 69	8 69	8 69	8 69	8 69	8 69
	32 91	32 91	32 91	32 91	32 91	32 91	32 91	32 91
90	4 35	4 35	4 35	4 35	4 35	4 35	4 35	4 35
	16 91	16 91	16 91	16 91	16 91	16 91	16 91	16 91
80	2 17	2 17	2 17	2 17	2 17	2 17	2 17	2 17
	8 91	8 91	8 91	8 91	8 91	8 91	8 91	8 91
70	0 0	0 0	0 0	0 0	0 0	0 0	0 0	0 0
	0 91	0 91	0 91	0 91	0 91	0 91	0 91	0 91
FROM 200 KT TIME						FUEL		
(MIN)						(KG)		
DIST						TORQUE		
(NM)						(%)		



AR72
F.C.O.M.

ONE ENGINE INOPERATIVE
200KT IAS NORMAL DESCENT
IN FLIGHT

3.09.16

P 2

500

JUN 97

AA

DESCENT 1 ENGINE

200KT(IAS) and VZ NOT LESS THAN 500 FT/MN

ISA

CLEAN CONFIGURATION

AIR COND FLOW:NORM

ANTI/DE ICING:OFF

FL	WEIGHT (1000KG)							
	14	15	16	17	18	19	20	21
250	27 207	27 210	27 213	28 214	28 215	28 216	28 216	28 216
	111 60	113 60	115 60	116 60	117 60	117 60	117 60	118 60
230	25 198	25 201	26 203	26 204	26 205	26 205	26 205	26 205
	104 64	106 64	107 64	108 64	109 64	109 64	109 64	109 64
210	23 187	24 190	24 191	24 192	24 193	24 193	24 193	24 193
	96 67	97 67	99 67	99 67	100 67	100 67	100 67	99 67
190	21 174	22 176	22 177	22 177	22 178	22 178	22 177	22 177
	87 71	88 71	89 71	89 71	89 71	89 71	89 71	89 71
170	19 157	19 158	19 159	19 159	19 159	19 159	19 159	19 158
	77 76	77 76	78 76	78 76	78 76	78 76	78 76	77 76
150	16 135	16 135	16 135	16 135	16 135	16 135	16 134	16 134
	64 80	64 80	64 80	64 80	64 80	64 80	64 80	64 80
130	12 104	12 104	12 104	12 104	12 104	12 104	12 104	12 104
	48 85	48 85	48 85	48 85	48 85	48 85	48 85	48 85
110	8 70	8 70	8 70	8 70	8 70	8 70	8 70	8 70
	32 90	32 90	32 90	32 90	32 90	32 90	32 90	32 90
90	4 35	4 35	4 35	4 35	4 35	4 35	4 35	4 35
	16 91	16 91	16 91	16 91	16 91	16 91	16 91	16 91
80	2 18	2 18	2 18	2 18	2 18	2 18	2 18	2 18
	8 91	8 91	8 91	8 91	8 91	8 91	8 91	8 91
70	0 0	0 0	0 0	0 0	0 0	0 0	0 0	0 0
	0 91	0 91	0 91	0 91	0 91	0 91	0 91	0 91
FROM 200 KT TIME						FUEL		
(MIN)						(KG)		
DIST						TORQUE		
(NM)						(%)		

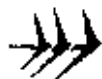

NR72
F.C.O.M.

ONE ENGINE INOPERATIVE
200KT IAS NORMAL DESCENT
IN FLIGHT

3.09.16

P 3

500

JUN 97

AA

DESCENT 1 ENGINE

200KT(IAS) and VZ NOT LESS THAN 500 FT/MN

ISA+10 (.C)

CLEAN CONFIGURATION

AIR COND FLOW:NORM

ANTI/DE ICING:OFF

FL	WEIGHT (1000KG)							
	14	15	16	17	18	19	20	21
250	25 188	25 191	26 195	26 196	26 197	26 198	27 199	27 199
	105 57	107 57	109 57	111 57	111 57	112 57	112 57	113 57
230	23 180	24 183	24 186	24 187	25 188	25 189	25 189	25 189
	98 61	100 61	102 61	103 61	103 61	104 61	104 61	104 61
210	22 170	22 173	22 175	23 176	23 177	23 177	23 178	23 178
	90 64	92 64	93 64	94 64	95 64	95 64	95 64	95 64
190	20 158	20 161	20 163	21 163	21 164	21 164	21 164	21 164
	82 68	83 68	84 68	85 68	85 68	85 68	85 68	85 68
170	18 144	18 146	18 147	18 148	18 148	18 148	18 148	18 148
	72 71	73 71	74 71	74 71	74 71	74 71	74 71	74 71
150	15 126	15 127	15 128	15 128	15 128	15 128	15 128	15 127
	61 75	62 75	62 75	62 75	62 75	62 75	62 75	62 75
130	12 102	12 102	12 102	12 102	12 102	12 102	12 102	12 102
	48 80	48 80	48 80	48 80	48 80	48 80	48 80	48 80
110	8 70	8 70	8 70	8 70	8 70	8 70	8 70	8 70
	32 85	32 85	32 85	32 85	32 85	32 85	32 85	32 85
90	4 36	4 36	4 36	4 36	4 36	4 36	4 36	4 36
	16 90	16 90	16 90	16 90	16 90	16 90	16 90	16 90
80	2 18	2 18	2 18	2 18	2 18	2 18	2 18	2 18
	8 91	8 91	8 91	8 91	8 91	8 91	8 91	8 91
70	0 0	0 0	0 0	0 0	0 0	0 0	0 0	0 0
	0 91	0 91	0 91	0 91	0 91	0 91	0 91	0 91
FROM 200 KT TIME						FUEL		
(MIN)						(KG)		
DIST						TORQUE		
(NM)						(%)		



AR72
F.C.O.M.

ONE ENGINE INOPERATIVE
200KT IAS NORMAL DESCENT
IN FLIGHT

3.09.16

P 4

500

JUN 97

AA

DESCENT 1 ENGINE

200KT(IAS) and VZ NOT LESS THAN 500 FT/MN

ISA+20 (.C)

CLEAN CONFIGURATION

AIR COND FLOW:NORM

ANTI/DE ICING:OFF

FL	WEIGHT (1000KG)							
	14	15	16	17	18	19	20	21
250	23 166	24 170	24 174	25 176	25 178	25 179	25 179	25 180
	98 54	101 54	103 54	105 54	106 54	107 54	107 54	108 54
230	22 159	22 163	23 166	23 168	23 169	23 170	23 171	23 171
	91 57	93 57	96 57	97 57	98 57	98 57	99 57	99 57
210	20 150	21 154	21 157	21 158	21 159	22 160	22 160	22 160
	84 60	86 60	88 60	89 60	89 60	90 60	90 60	90 60
190	18 140	19 143	19 145	19 147	19 147	20 148	20 148	20 148
	76 64	78 64	79 64	80 64	80 64	81 64	81 64	81 64
170	16 128	17 130	17 132	17 133	17 133	17 133	17 133	17 133
	67 68	68 68	70 68	70 68	70 68	71 68	70 68	70 68
150	14 112	14 114	15 115	15 116	15 116	15 116	15 116	15 116
	57 72	58 72	59 72	59 72	59 72	59 72	59 72	59 72
130	11 92	12 93	12 94	12 94	12 94	12 94	12 94	12 93
	45 76	46 76	46 76	47 76	46 76	46 76	46 76	46 76
110	8 66	8 66	8 66	8 66	8 66	8 66	8 66	8 66
	31 79	31 79	32 79	32 79	32 79	31 79	31 79	31 79
90	4 34	4 34	4 34	4 34	4 34	4 34	4 34	4 34
	16 82	16 82	16 82	16 82	16 82	16 82	16 82	16 82
80	2 17	2 17	2 17	2 17	2 17	2 17	2 17	2 17
	8 84	8 84	8 84	8 84	8 84	8 84	8 84	8 84
70	0 0	0 0	0 0	0 0	0 0	0 0	0 0	0 0
	0 86	0 86	0 86	0 86	0 86	0 86	0 86	0 85
FROM 200 KT TIME						FUEL		
(MIN)						(KG)		
DIST						TORQUE		
(NM)						(%)		



NR72
F.C.O.M.

ONE ENGINE INOPERATIVE
200KT IAS ICING DESCENT
IN FLIGHT

3.09.17

P 1

500

DEC 97

AA

DESCENT 1 ENGINE

200KT(IAS) and VZ NOT LESS THAN 500 FT/MN
ISA-10 (.C)
CLEAN CONFIGURATION
AIR COND FLOW:NORM
ANTI/DE ICING:ON

FL	WEIGHT (1000KG)							
	14	15	16	17	18	19	20	22
250	27 212	27 216	27 218	28 219	28 220	28 220	28 220	28 220
	109 63	111 63	113 63	113 63	114 63	114 63	115 63	114 63
230	25 203	26 206	26 208	26 209	26 209	26 209	26 210	26 209
	102 67	104 67	105 67	106 67	106 67	106 67	106 67	106 67
210	23 192	24 194	24 196	24 196	24 197	24 197	24 197	24 196
	94 71	96 71	97 71	97 71	97 71	97 71	97 71	97 71
190	21 178	22 180	22 181	22 181	22 181	22 181	22 181	22 180
	86 75	87 75	87 75	88 75	88 75	88 75	87 75	87 75
170	19 161	19 162	19 162	19 162	19 162	19 162	19 162	19 161
	75 79	76 79	77 79	77 79	77 79	76 79	76 79	76 79
150	16 136	16 137	16 137	16 137	16 137	16 137	16 136	16 136
	63 84	63 84	63 84	63 84	63 84	63 84	63 84	62 84
130	12 104	12 104	12 104	12 104	12 104	12 104	12 104	12 104
	47 90	47 90	47 90	47 90	47 90	47 90	47 90	47 89
110	8 69	8 69	8 69	8 69	8 69	8 69	8 69	8 69
	31 91	31 91	31 91	31 91	31 91	31 91	31 91	31 91
90	4 35	4 35	4 35	4 35	4 35	4 35	4 35	4 35
	15 91	15 91	15 91	15 91	15 91	15 91	15 91	15 91
80	2 17	2 17	2 17	2 17	2 17	2 17	2 17	2 17
	8 91	8 91	8 91	8 91	8 91	8 91	8 91	8 91
70	0 0	0 0	0 0	0 0	0 0	0 0	0 0	0 0
	0 91	0 91	0 91	0 91	0 91	0 91	0 91	0 91
FROM 200 KT TIME						FUEL		
(MIN)						(KG)		
DIST						TORQUE		
(NM)						(%)		



ATR72
F.C.O.M.

ONE ENGINE INOPERATIVE

200KT IAS ICING DESCENT

IN FLIGHT

3.09.17

P 2

500

DEC 97

AA

DESCENT 1 ENGINE

200KT(IAS) and VZ NOT LESS THAN 500 FT/MN

ISA

CLEAN CONFIGURATION

AIR COND FLOW:NORM

ANTI/DE ICING:ON

FL	WEIGHT (1000KG)							
	14	15	16	17	18	19	20	22
250	25 195	26 199	26 202	26 203	26 204	26 205	27 206	27 206
	103 60	106 60	108 60	109 60	109 60	110 60	110 60	110 60
230	24 187	24 191	24 193	25 194	25 195	25 195	25 196	25 196
	97 64	99 64	100 64	101 64	102 64	102 64	102 64	102 64
210	22 177	22 180	23 182	23 183	23 184	23 184	23 184	23 184
	89 67	91 67	92 67	93 67	93 67	94 67	94 67	93 67
190	20 165	21 168	21 169	21 170	21 170	21 170	21 170	21 169
	81 71	83 71	84 71	84 71	84 71	84 71	84 71	84 71
170	18 150	18 152	18 153	18 153	18 153	18 153	18 153	18 152
	72 76	73 76	74 76	74 76	74 76	74 76	74 76	73 76
150	15 131	16 132	16 132	16 132	16 132	16 132	16 132	15 131
	61 80	62 80	62 80	62 80	62 80	62 80	62 80	61 80
130	12 104	12 104	12 104	12 104	12 104	12 104	12 104	12 103
	47 85	47 85	47 85	47 85	47 85	47 85	47 85	47 85
110	8 70	8 70	8 70	8 70	8 70	8 70	8 70	8 70
	31 89	31 89	31 89	31 89	31 89	31 89	31 89	31 89
90	4 35	4 35	4 35	4 35	4 35	4 35	4 35	4 35
	15 91	16 91	16 91	16 91	16 91	16 91	16 91	16 91
80	2 18	2 18	2 18	2 18	2 18	2 18	2 18	2 18
	8 91	8 91	8 91	8 91	8 91	8 91	8 91	8 91
70	0 0	0 0	0 0	0 0	0 0	0 0	0 0	0 0
	0 91	0 91	0 91	0 91	0 91	0 91	0 91	0 91
FROM 200 KT TIME (MIN) DIST (NM)						FUEL (KG) TORQUE (%)		



ONE ENGINE INOPERATIVE
200KT IAS ICING DESCENT
IN FLIGHT

3.09.17

P 3

500

DEC 97

AA

DESCENT 1 ENGINE

200KT(IAS) and VZ NOT LESS THAN 500 FT/MN
ISA+10 (.C)
CLEAN CONFIGURATION
AIR COND FLOW:NORM
ANTI/DE ICING:ON

FL	WEIGHT (1000KG)							
	14	15	16	17	18	19	20	22
250	21 153	21 159	22 163	23 172	23 174	24 176	24 178	24 180
	88 57	91 57	94 57	99 57	100 57	101 57	102 57	103 57
230	19 145	20 151	20 155	21 164	22 166	22 167	22 169	22 170
	81 61	84 61	87 61	91 61	92 61	93 61	94 61	95 61
210	18 136	18 142	19 145	20 153	20 155	20 157	20 158	21 159
	74 64	77 64	79 64	83 64	84 64	85 64	86 64	86 64
190	16 126	17 130	17 134	18 142	18 143	18 144	18 145	18 146
	66 68	69 68	71 68	75 68	75 68	76 68	77 68	77 68
170	14 113	15 117	15 120	16 127	16 128	16 129	16 130	16 131
	58 71	60 71	61 71	65 71	66 71	66 71	67 71	67 71
150	12 97	12 100	12 102	13 110	13 111	13 111	14 112	14 112
	48 75	50 75	51 75	55 75	55 75	55 75	56 75	56 75
130	9 76	9 78	9 80	10 87	10 88	10 88	11 89	11 90
	37 80	38 80	39 80	42 80	42 80	43 80	43 80	43 80
110	5 47	6 48	6 50	7 57	7 58	7 58	7 59	7 60
	22 84	23 85	24 84	27 84	27 84	28 84	28 84	29 85
90	3 24	3 25	3 26	4 32	4 33	4 33	4 33	4 34
	11 91	11 91	12 91	15 91	15 91	15 91	15 91	16 91
80	2 15	2 16	2 17	2 18	2 18	2 18	2 18	2 18
	7 91	7 91	7 91	8 91	8 91	8 91	8 91	8 91
70	0 0	0 0	0 0	0 0	0 0	0 0	0 0	0 0
	0 91	0 91	0 91	0 91	0 91	0 91	0 91	0 91
FROM 200 KT TIME (MIN) DIST (NM)						FUEL (KG) TORQUE (%)		



ATR 72
F.C.O.M.

ONE ENGINE INOPERATIVE

200KT IAS ICING DESCENT

IN FLIGHT

3.09.17

P 4

500

DEC 97

AA

DESCENT 1 ENGINE

200KT(IAS) and VZ NOT LESS THAN 500 FT/MN

ISA+20 (.C)

CLEAN CONFIGURATION

AIR COND FLOW:NORM

ANTI/DE ICING:ON

FL	WEIGHT (1000KG)							
	14	15	16	17	18	19	20	22
250	22 162	23 166	23 170	24 172	24 173	24 174	24 175	25 176
	94 54	97 54	100 54	101 54	102 54	103 54	104 54	105 54
230	21 155	22 159	22 162	22 164	23 165	23 166	23 167	23 167
	88 57	91 57	93 57	94 57	95 57	96 57	96 57	96 57
210	20 147	20 150	21 153	21 155	21 156	21 157	21 157	21 157
	81 60	84 60	85 60	86 60	87 60	87 60	88 60	88 60
190	18 138	18 140	19 143	19 144	19 145	19 145	19 146	19 146
	74 64	76 64	77 64	78 64	78 64	79 64	79 64	79 64
170	16 126	17 128	17 130	17 131	17 132	17 132	17 132	17 132
	66 68	67 68	69 68	69 68	69 68	69 68	70 68	69 68
150	14 112	14 114	15 115	15 115	15 116	15 116	15 116	15 115
	57 72	58 72	59 72	59 72	59 72	59 72	59 72	59 72
130	11 92	12 93	12 94	12 94	12 94	12 94	12 94	12 93
	45 76	46 76	46 76	46 76	46 76	46 76	46 76	46 76
110	8 66	8 66	8 66	8 66	8 66	8 66	8 66	8 66
	31 79	31 79	31 79	31 79	31 79	31 79	31 79	31 79
90	4 34	4 34	4 34	4 34	4 34	4 34	4 34	4 34
	16 82	16 82	16 82	16 82	16 82	16 82	16 82	16 82
80	2 17	2 17	2 17	2 17	2 17	2 17	2 17	2 17
	8 84	8 84	8 84	8 84	8 84	8 84	8 84	8 84
70	0 0	0 0	0 0	0 0	0 0	0 0	0 0	0 0
	0 85	0 86	0 86	0 86	0 86	0 86	0 85	0 85
FROM 200 KT TIME (MIN) DIST (NM)						FUEL (KG) TORQUE (%)		



ATR 72
F.C.O.M.

**ONE ENGINE INOPERATIVE
NORMAL CONDITIONS CRUISE**

IN FLIGHT

3.09.20

P 1

500

JUN 97

**CRUISE 1 ENGINE
NORMAL CONDITIONS
ISA-10 (.C) 1 ENG AT MAX CONTINUOUS (NP=100%)**

WEIGHT (1000KG)	FLIGHT LEVEL					
	40	60	80	100	120	140
13	90.9	90.9	90.9	90.9	90.9	85.2
	539 203	530 201	524 199	520 197	521 195	489 188
	38.8 209	40.2 213	41.5 217	42.6 221	43.4 226	46.1 225
14	90.9	90.9	90.9	90.9	90.9	85.1
	539 202	530 200	524 198	521 196	521 194	488 187
	38.7 208	40.1 213	41.3 217	42.4 221	43.2 225	45.9 224
15	90.9	90.9	90.9	90.9	90.9	84.9
	539 202	530 200	524 198	521 195	521 193	487 186
	38.6 208	40.0 212	41.2 216	42.2 220	43.0 224	45.6 222
16	90.9	90.9	90.9	90.9	90.7	84.7
	539 201	530 199	524 197	521 194	520 192	486 184
	38.4 207	39.8 211	41.0 215	42.0 219	42.7 222	45.2 220
17	90.9	90.9	90.9	90.9	90.6	84.5
	539 200	530 198	524 195	521 193	520 190	485 182
	38.2 206	39.5 210	40.7 213	41.6 217	42.4 220	44.9 218
18	90.9	90.9	90.9	90.9	90.3	84.3
	539 198	530 196	524 194	521 191	519 188	484 180
	37.9 204	39.2 208	40.4 212	41.3 215	42.1 218	44.4 215
19	90.9	90.9	90.9	90.9	90.1	84.0
	539 197	530 195	525 192	521 189	517 186	483 177
	37.6 203	38.9 206	40.0 210	40.9 213	41.7 216	43.9 212
20	90.9	90.9	90.9	90.9	89.9	83.6
	539 195	530 193	525 190	522 188	516 184	480 174
	37.3 201	38.6 205	39.6 208	40.5 211	41.3 213	43.2 208
21	90.9	90.9	90.9	90.9	89.5	83.2
	540 193	530 191	525 188	522 185	514 181	478 169
	36.9 199	38.2 202	39.2 206	40.0 209	40.7 209	42.4 203
22	90.9	90.9	90.9	90.9	89.1	82.6
	540 191	531 189	525 185	522 182	512 177	475 163
	36.5 197	37.7 200	38.6 203	39.3 205	40.0 205	41.2 196

TQ %
KG/H/ENG
NM/100KG

IAS
TAS



AR72
F.C.O.M.

ONE ENGINE INOPERATIVE
NORMAL CONDITIONS CRUISE

IN FLIGHT

3.09.20

P 2

500

JUN 97

CRUISE 1 ENGINE
NORMAL CONDITIONS
ISA-10 (.C) **1 ENG AT MAX CONTINUOUS (NP=100%)**

WEIGHT (1000KG)	FLIGHT LEVEL					
	160	180	200	220	240	250
13	79.5	74.0	69.0	64.3	59.7	57.5
	456 181	424 174	396 167	369 159	342 152	329 147
	49.1 224	52.2 222	55.5 220	58.8 217	62.3 213	64.1 211
14	79.3	73.8	68.8	64.0	59.4	57.0
	455 180	423 172	395 164	367 157	340 148	327 143
	48.7 222	51.8 219	54.9 217	58.1 213	61.1 208	62.6 205
15	79.2	73.6	68.5	63.7	58.9	56.5
	454 178	422 170	393 162	365 153	337 142	322 136
	48.4 220	51.3 217	54.2 213	57.0 208	59.6 201	60.5 195
16	78.9	73.3	68.2	63.2	58.2	55.8
	453 176	421 167	392 158	362 148	332 134	317 121
	47.9 217	50.7 214	53.3 209	55.7 202	56.9 189	55.2 175
17	78.7	73.0	67.8	62.6		
	452 174	419 164	389 154	358 140		
	47.4 214	50.0 209	52.2 203	53.5 191		
18	78.4	72.6	67.2			
	450 171	416 160	385 147			
	46.8 211	49.0 204	50.4 194			
19	78.0	72.0	65.9			
	448 167	413 154	377 131			
	46.0 206	47.7 197	46.1 174			
20	77.5	71.2				
	445 162	407 144				
	44.9 200	45.2 184				
21	76.8					
	440 154					
	43.2 190					
22						

TQ %
KG/H/ENG
NM/100KG

IAS
TAS



**ONE ENGINE INOPERATIVE
NORMAL CONDITIONS CRUISE**

3.09.20

P 3

500

IN FLIGHT

JUN 97

**CRUISE 1 ENGINE
NORMAL CONDITIONS
ISA
1 ENG AT MAX CONTINUOUS (NP=100%)**

WEIGHT (1000KG)	FLIGHT LEVEL					
	40	60	80	100	120	140
13	90.9	90.9	90.9	90.9	85.8	80.7
	545 202	537 200	530 198	527 195	497 189	467 183
	38.8 212	40.2 216	41.4 220	42.5 224	45.1 224	47.9 223
14	90.9	90.9	90.9	90.9	85.7	80.6
	545 201	537 199	531 197	527 195	496 188	466 182
	38.7 211	40.1 215	41.3 219	42.4 223	44.9 223	47.6 222
15	90.9	90.9	90.9	90.8	85.6	80.4
	545 200	537 198	531 196	527 194	496 187	465 180
	38.6 210	39.9 214	41.2 218	42.2 222	44.6 221	47.2 220
16	90.9	90.9	90.9	90.7	85.5	80.2
	545 200	537 197	531 195	526 192	495 185	464 178
	38.4 209	39.7 213	40.9 217	42.0 221	44.3 219	46.8 217
17	90.9	90.9	90.9	90.5	85.3	80.0
	545 198	537 196	531 194	525 191	494 184	463 176
	38.2 208	39.4 212	40.6 216	41.7 219	43.9 217	46.3 215
18	90.9	90.9	90.9	90.3	85.1	79.7
	545 197	537 195	531 192	524 189	494 181	462 173
	37.9 207	39.1 210	40.3 214	41.3 217	43.5 215	45.8 212
19	90.9	90.9	90.9	90.2	84.9	79.4
	546 195	537 193	531 190	524 187	493 179	461 170
	37.6 205	38.8 208	39.9 212	41.0 215	43.0 212	45.0 207
20	90.9	90.9	90.9	89.9	84.6	79.0
	546 194	537 191	531 189	523 185	492 176	459 165
	37.2 203	38.4 207	39.5 210	40.6 212	42.4 208	44.0 202
21	90.9	90.9	90.9	89.6	84.3	78.5
	546 192	537 189	532 186	521 182	490 172	456 159
	36.9 201	38.0 204	39.0 207	40.0 209	41.5 204	42.6 195
22	90.9	90.9	90.9	89.3	83.9	77.6
	546 190	538 187	532 183	520 178	489 167	453 149
	36.4 199	37.5 202	38.4 204	39.3 204	40.5 198	40.2 182

TQ %
KG/H/ENG
NM/100KG

IAS
TAS



AR72
F.C.O.M.

**ONE ENGINE INOPERATIVE
NORMAL CONDITIONS CRUISE**

IN FLIGHT

3.09.20

P 4

500

JUN 97

AA

CRUISE 1 ENGINE						
NORMAL CONDITIONS ISA						
1 ENG AT MAX CONTINUOUS (NP=100%)						
WEIGHT (1000KG)	FLIGHT LEVEL					
	160	180	200	220	240	250
13	75.2	70.0	65.3	60.7	56.1	53.9
	435 176	405 168	378 161	352 154	325 145	312 140
	50.9 222	54.1 219	57.3 217	60.7 214	64.2 209	65.9 205
14	75.0	69.8	65.1	60.4	55.7	53.4
	434 174	404 166	377 159	350 150	323 140	309 134
	50.5 219	53.6 217	56.6 214	59.7 209	62.6 202	63.8 197
15	74.8	69.5	64.8	60.0	55.1	52.8
	433 172	403 164	375 156	348 146	319 132	305 123
	50.0 217	53.0 213	55.7 209	58.3 203	59.9 191	59.4 181
16	74.6	69.3	64.4	59.5		
	432 170	401 161	373 151	344 139		
	49.5 214	52.2 209	54.5 203	56.1 193		
17	74.4	68.9	63.9	58.6		
	431 167	399 157	371 145	341 122		
	48.8 210	51.1 204	52.7 195	50.0 170		
18	74.0	68.4	63.0			
	429 163	397 151	366 133			
	47.9 206	49.6 197	49.1 180			
19	73.5	67.7				
	427 158	393 142				
	46.7 199	47.0 185				
20	72.9					
	424 151					
	44.8 190					
21						
22						

TQ %
KG/H/ENG
NM/100KG

IAS
TAS



**ONE ENGINE INOPERATIVE
NORMAL CONDITIONS CRUISE**

3.09.20

P 5

500

IN FLIGHT

JUN 97

**CRUISE 1 ENGINE
NORMAL CONDITIONS
ISA+10 (.C) 1 ENG AT MAX CONTINUOUS (NP=100%)**

WEIGHT (1000KG)	FLIGHT LEVEL					
	40	60	80	100	120	140
13	90.9	90.9	90.9	86.0	80.6	75.4
	552 200	543 198	537 196	506 190	474 184	442 177
	38.8 214	40.2 218	41.4 222	43.9 222	46.7 221	49.8 220
14	90.9	90.9	90.9	85.9	80.5	75.2
	552 200	543 198	537 195	506 189	473 182	441 175
	38.6 213	40.0 217	41.3 222	43.7 221	46.5 220	49.4 218
15	90.9	90.9	90.9	85.8	80.3	75.0
	552 199	543 197	537 195	506 188	473 181	441 173
	38.5 212	39.9 217	41.1 221	43.5 220	46.1 218	48.9 216
16	90.9	90.9	90.9	85.7	80.2	74.9
	552 198	543 196	537 194	505 187	472 179	440 171
	38.3 212	39.7 215	40.9 219	43.2 218	45.7 216	48.4 213
17	90.9	90.9	90.9	85.5	80.0	74.6
	552 197	543 195	537 192	504 185	471 177	439 169
	38.1 210	39.4 214	40.5 218	42.8 216	45.3 213	47.8 210
18	90.9	90.9	90.9	85.3	79.8	74.3
	552 195	543 193	537 191	504 183	470 174	437 165
	37.8 209	39.1 212	40.2 216	42.4 214	44.7 210	46.9 205
19	90.9	90.9	90.8	85.1	79.5	73.9
	552 194	544 191	537 189	503 181	469 171	436 160
	37.5 207	38.7 211	39.8 214	42.0 211	44.0 206	45.8 200
20	90.9	90.9	90.6	84.9	79.1	73.4
	552 192	544 190	536 187	502 178	468 167	434 154
	37.1 205	38.3 208	39.4 212	41.4 207	43.1 201	44.2 192
21	90.9	90.9	90.4	84.6	78.7	72.6
	552 190	544 188	535 184	500 174	466 162	432 142
	36.8 203	37.9 206	39.0 209	40.6 203	41.9 195	41.0 177
22	90.9	90.9	90.1	84.2	78.1	
	552 188	544 185	534 181	499 169	464 153	
	36.3 200	37.3 203	38.3 205	39.7 198	39.8 185	

TQ %
KG/H/ENG
NM/100KG

IAS
TAS



**ONE ENGINE INOPERATIVE
NORMAL CONDITIONS CRUISE**

3.09.20

P 6

500

IN FLIGHT

JUN 97

**CRUISE 1 ENGINE
NORMAL CONDITIONS
ISA+10 (.C) 1 ENG AT MAX CONTINUOUS (NP=100%)**

WEIGHT (1000KG)	FLIGHT LEVEL					
	160	180	200	220	240	250
13	70.5	66.2	61.8	57.4	53.0	50.8
	413 170	388 163	361 156	336 148	310 139	298 133
	52.8 218	55.9 216	59.1 214	62.6 210	65.7 204	67.1 200
14	70.3	66.0	61.6	57.1	52.5	50.4
	413 168	387 161	360 153	334 144	308 132	295 124
	52.3 216	55.2 213	58.3 210	61.1 204	63.2 195	63.4 187
15	70.2	65.8	61.2	56.6	52.2	
	412 166	386 158	359 149	332 138	307 120	
	51.7 213	54.4 210	56.9 204	58.9 196	57.9 178	
16	70.0	65.5	60.8	55.8		
	411 163	385 154	357 143	329 126		
	51.0 209	53.2 205	55.1 197	54.5 179		
17	69.7	65.1	60.1			
	410 159	383 149	354 133			
	49.9 205	51.7 198	51.8 183			
18	69.3	64.5				
	408 154	380 140				
	48.6 198	49.1 187				
19	68.8					
	406 147					
	46.5 189					
20						
21						
22						

TQ %
KG/H/ENG
NM/100KG

IAS
TAS



**ONE ENGINE INOPERATIVE
NORMAL CONDITIONS CRUISE**

3.09.20

P 7

500

IN FLIGHT

JUN 97

**CRUISE 1 ENGINE
NORMAL CONDITIONS
ISA+20 (.C) 1 ENG AT MAX CONTINUOUS (NP=100%)**

WEIGHT (1000KG)	FLIGHT LEVEL					
	40	60	80	100	120	140
13	90.0	86.4	83.0	79.5	75.8	71.2
	554 198	527 193	503 189	478 184	454 178	425 172
	38.9 215	41.1 216	43.3 218	45.7 218	48.2 219	51.1 217
14	90.0	86.3	83.0	79.4	75.7	71.0
	554 198	526 193	503 188	478 182	453 177	425 170
	38.8 215	41.0 216	43.1 217	45.4 217	47.8 217	50.6 215
15	89.9	86.3	82.9	79.3	75.6	70.9
	554 197	526 192	502 186	478 181	453 175	424 167
	38.6 214	40.8 215	42.8 215	45.0 215	47.4 215	50.1 212
16	89.8	86.2	82.8	79.2	75.5	70.7
	553 196	526 190	502 185	477 179	452 173	423 165
	38.4 213	40.5 213	42.5 213	44.6 213	46.9 212	49.4 209
17	89.8	86.1	82.7	79.1	75.4	70.4
	553 194	526 189	502 183	477 177	452 170	422 162
	38.2 211	40.2 211	42.1 211	44.2 211	46.3 209	48.5 205
18	89.7	86.0	82.6	79.0	75.2	70.1
	553 193	525 187	501 181	476 175	451 167	420 157
	37.9 209	39.8 209	41.7 209	43.6 208	45.5 205	47.3 199
19	89.5	85.9	82.5	78.8	74.9	69.6
	552 191	525 185	501 179	476 172	450 163	419 151
	37.6 207	39.4 207	41.2 206	42.9 204	44.5 200	45.6 191
20	89.4	85.8	82.3	78.6	74.5	68.9
	552 189	525 183	500 176	475 168	449 158	417 139
	37.2 205	39.0 205	40.5 203	42.0 200	43.2 194	42.4 177
21	89.3	85.7	82.2	78.3	73.9	
	551 187	524 180	500 172	475 163	448 149	
	36.8 203	38.4 201	39.7 198	40.8 194	41.0 183	
22	89.1	85.5	81.9	78.0		
	551 184	524 176	499 167	474 156		
	36.2 200	37.6 197	38.7 193	39.1 185		

TQ %
KG/H/ENG
NM/100KG

IAS
TAS



**ONE ENGINE INOPERATIVE
NORMAL CONDITIONS CRUISE**

IN FLIGHT

3.09.20		
P 8	500	
		JUN 97

AA

CRUISE 1 ENGINE						
NORMAL CONDITIONS ISA+20 (.C)			1 ENG AT MAX CONTINUOUS (NP=100%)			
WEIGHT (1000KG)	FLIGHT LEVEL					
	160	180	200	220	240	250
13	66.4	61.8	57.7	54.1	50.1	48.0
	396 164	368 157	343 150	321 142	297 132	285 125
	54.3 215	57.6 212	61.0 209	63.9 205	66.5 198	67.3 192
14	66.3	61.6	57.4	53.7	49.7	48.2
	396 162	367 154	342 146	320 136	296 122	288 111
	53.7 212	56.8 209	59.6 204	61.8 197	62.3 185	59.8 172
15	66.1	61.3	57.1	53.2		
	395 160	366 150	341 140	318 127		
	52.9 209	55.5 203	57.7 196	58.1 184		
16	65.8	61.0	56.6			
	393 156	365 145	339 131			
	51.9 204	53.9 197	54.3 184			
17	65.4	60.5				
	392 151	363 137				
	50.4 198	51.1 186				
18	64.9					
	391 144					
	48.2 188					
19						
20						
21						
22						

TO %
KG/H/ENG
NM/100KG

IAS
TAS

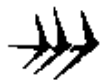

AJ72
F.C.O.M.

**ONE ENGINE INOPERATIVE
ICING CONDITIONS CRUISE**

IN FLIGHT

3.09.25

P 1

500

JUN 97

CRUISE 1 ENGINE

**ICING CONDITIONS
ISA-10 (.C)**

1 ENG AT MAX CONTINUOUS (NP=100%)

WEIGHT (1000KG)	FLIGHT LEVEL					
	40	60	80	100	120	140
13	90.9	90.9	90.9	90.9	90.7	84.8
	539 199	530 197	524 195	521 193	520 191	487 184
	38.1 205	39.5 209	40.7 213	41.8 218	42.6 222	45.4 221
14	90.9	90.9	90.9	90.9	90.6	84.6
	539 199	530 197	524 195	521 193	520 190	486 183
	38.0 205	39.4 209	40.6 213	41.6 217	42.5 221	45.1 219
15	90.9	90.9	90.9	90.9	90.4	84.5
	539 198	530 196	524 194	521 192	519 189	485 181
	37.9 204	39.2 208	40.4 212	41.4 216	42.2 219	44.7 217
16	90.9	90.9	90.9	90.9	90.2	84.3
	539 197	530 195	524 193	521 190	518 187	484 179
	37.6 203	39.0 207	40.1 210	41.1 214	41.9 217	44.4 215
17	90.9	90.9	90.9	90.9	90.1	84.0
	539 196	530 193	525 191	521 189	517 185	483 177
	37.4 202	38.7 205	39.8 209	40.7 212	41.6 215	44.0 212
18	90.9	90.9	90.9	90.9	89.8	83.7
	540 194	530 192	525 190	522 187	516 183	481 174
	37.1 200	38.4 204	39.5 207	40.4 210	41.3 213	43.4 209
19	90.9	90.9	90.9	90.9	89.6	83.3
	540 193	531 190	525 188	522 185	514 181	478 170
	36.8 198	38.0 202	39.1 205	39.9 208	40.8 210	42.6 204
20	90.9	90.9	90.9	90.9	89.2	82.7
	540 191	531 188	525 185	522 182	512 177	475 164
	36.4 196	37.6 200	38.6 203	39.3 205	40.1 206	41.3 196
21	90.9	90.9	90.9	90.9	88.7	
	540 188	531 185	525 182	523 179	510 172	
	35.9 194	37.1 197	37.9 199	38.5 201	39.2 200	
22	90.9	90.9	90.9	90.9		
	540 185	531 182	526 178	523 174		
	35.3 191	36.3 193	37.0 195	37.5 196		

TQ %
KG/H/ENG
NM/100KG

IAS
TAS



AR72
F.C.O.M.

**ONE ENGINE INOPERATIVE
ICING CONDITIONS CRUISE**

IN FLIGHT

3.09.25

P 2

500

JUN 97

CRUISE 1 ENGINE
ICING CONDITIONS
ISA-10 (.C) **1 ENG AT MAX CONTINUOUS (NP=100%)**

WEIGHT (1000KG)	FLIGHT LEVEL					
	160	180	200	220	240	250
13	79.1	73.6	68.6	63.9	59.2	56.9
	454 177	422 170	394 163	367 155	340 146	326 141
	48.2 219	51.3 217	54.4 214	57.6 211	60.8 206	62.2 203
14	78.9	73.4	68.4	63.5	58.7	
	453 176	421 168	393 160	364 151	336 140	
	47.9 217	50.8 214	53.8 211	56.6 206	58.9 198	
15	78.7	73.1	68.0	63.0		
	452 174	420 166	390 157	361 145		
	47.4 214	50.3 211	52.9 206	54.9 198		
16	78.5	72.8	67.5			
	451 171	418 162	387 151			
	47.0 212	49.5 207	51.4 199			
17	78.1	72.3				
	449 168	414 157				
	46.3 208	48.2 200				
18	77.7					
	446 163					
	45.3 202					
19	76.8					
	441 155					
	43.3 191					
20						
21						
22						

TQ %
KG/H/ENG
NM/100KG

IAS
TAS

	ONE ENGINE INOPERATIVE	3.09.25	
	ICING CONDITIONS CRUISE	P 3	500
	IN FLIGHT		JUN 97

AA

CRUISE 1 ENGINE						
ICING CONDITIONS		1 ENG AT MAX CONTINUOUS (NP=100%)				
WEIGHT (1000KG)	FLIGHT LEVEL					
	40	60	80	100	120	140
13	90.9	90.9	90.9	90.6	85.5	80.3
	545 202	537 196	531 194	526 192	495 186	465 179
	38.8 212	39.5 212	40.7 216	41.8 220	44.4 220	47.0 219
14	90.9	90.9	90.9	90.5	85.4	80.2
	545 201	537 195	531 193	525 191	495 184	464 178
	38.7 211	39.3 211	40.6 215	41.7 219	44.1 218	46.7 217
15	90.9	90.9	90.9	90.4	85.2	80.0
	545 200	537 195	531 192	525 190	494 183	463 176
	38.6 210	39.2 210	40.3 214	41.5 218	43.8 216	46.3 214
16	90.9	90.9	90.9	90.3	85.1	79.8
	545 200	537 193	531 191	524 188	494 181	462 174
	38.4 209	38.9 209	40.0 213	41.2 216	43.4 214	45.8 212
17	90.9	90.9	90.9	90.1	84.9	79.5
	545 198	537 192	531 190	523 186	493 179	461 171
	38.2 208	38.6 207	39.7 211	40.9 214	43.0 212	45.2 209
18	90.9	90.9	90.9	89.9	84.7	79.1
	545 197	537 190	531 188	522 184	492 177	460 167
	37.9 207	38.3 206	39.4 209	40.5 212	42.5 209	44.3 204
19	90.9	90.9	90.9	89.7	84.4	78.6
	546 195	537 189	532 186	522 182	491 173	457 161
	37.6 205	37.9 204	39.0 207	40.1 209	41.7 205	42.9 196
20	90.9	90.9	90.9	89.4	84.0	
	546 194	538 187	532 184	520 179	489 168	
	37.2 203	37.5 202	38.4 204	39.4 205	40.6 199	
21	90.9	90.9	90.9	89.0		
	546 192	538 183	532 180	519 174		
	36.9 201	36.9 198	37.7 201	38.5 200		
22	90.9	90.9	90.9	88.4		
	546 190	538 180	533 176	516 166		
	36.4 199	36.0 194	36.7 196	36.8 190		

TQ %
KG/H/ENG
NM/100KG

IAS
TAS

	ONE ENGINE INOPERATIVE ICING CONDITIONS CRUISE IN FLIGHT	3.09.25		
		P 4	500	
				JUN 97

AA

CRUISE 1 ENGINE ICING CONDITIONS ISA						
1 ENG AT MAX CONTINUOUS (NP=100%)						
WEIGHT (1000KG)	FLIGHT LEVEL					
	160	180	200	220	240	250
13	74.8	69.6	64.9	60.3	55.6	53.2
	433 172	403 164	376 157	350 149	322 139	308 132
	50.0 217	53.1 214	56.2 211	59.3 207	62.1 200	62.9 194
14	74.6	69.4	64.7	59.9		
	432 170	402 162	375 154	347 144		
	49.6 214	52.5 211	55.3 207	57.7 200		
15	74.4	69.1	64.2			
	431 168	400 159	372 149			
	49.0 211	51.7 207	53.8 200			
16	74.1	68.7				
	430 165	398 154				
	48.3 208	50.4 201				
17	73.7					
	428 160					
	47.2 202					
18	73.1					
	425 152					
	45.3 192					
19						
20						
21						
22						
TQ % KG/H/ENG NM/100KG						
IAS TAS						



ONE ENGINE INOPERATIVE
ICING CONDITIONS CRUISE

3.09.25

P 5

500

IN FLIGHT

JUN 97

CRUISE 1 ENGINE
ICING CONDITIONS
ISA+10 (.C) 1 ENG AT MAX CONTINUOUS (NP=100%)

WEIGHT (1000KG)	FLIGHT LEVEL					
	120	140	160	180	200	220
13	80.3	75.0	70.2	65.9	61.5	57.0
	472 180	440 173	412 166	386 159	360 152	334 142
	45.9 217	48.8 215	51.8 213	54.7 211	57.8 208	60.7 202
14	80.1	74.9	70.0	65.7	61.1	56.3
	472 178	440 171	411 164	385 157	358 147	331 134
	45.6 215	48.4 213	51.2 211	53.9 208	56.4 202	57.6 190
15	80.0	74.7	69.8	65.3	60.5	
	471 177	439 169	410 161	384 152	356 139	
	45.2 213	47.9 210	50.5 207	52.6 202	53.7 191	
16	79.8	74.5	69.5	64.8		
	470 175	438 166	409 157	381 144		
	44.8 211	47.3 207	49.3 202	50.3 192		
17	79.6	74.1	69.0			
	469 172	437 162	407 150			
	44.2 208	46.3 202	47.4 193			
18	79.3	73.6				
	468 168	435 156				
	43.4 203	44.7 194				
19	78.8					
	466 163					
	42.2 197					
20						
21						
22						

TQ %
KG/H/ENG
M/MIN/KG

IAS
TAS

 ATR 72 F.C.O.M.	ONE ENGINE INOPERATIVE ICING CONDITIONS CRUISE IN FLIGHT	3.09.25		
		P 6	500	
				JUN 97

AA

CRUISE 1 ENGINE ICING CONDITIONS ISA+20 (.C) 1 ENG AT MAX CONTINUOUS (NP=100%)						
WEIGHT (1000KG)	FLIGHT LEVEL					
	120	140	160	180	200	220
13	75.8	71.2	66.1	61.5	57.4	53.6
	454 178	425 172	395 160	367 153	342 144	319 135
	48.2 219	51.1 217	53.2 210	56.4 207	59.2 202	61.2 195
14	75.7	71.0	65.9	61.2	57.0	
	453 177	425 170	394 158	366 149	340 138	
	47.8 217	50.6 215	52.5 207	55.1 201	56.8 193	
15	75.6	70.9	65.6	60.8		
	453 175	424 167	393 154	364 142		
	47.4 215	50.1 212	51.3 202	52.9 192		
16	75.5	70.7	65.2			
	452 173	423 165	391 148			
	46.9 212	49.4 209	49.4 193			
17	75.4	70.4				
	452 170	422 162				
	46.3 209	48.5 205				
18	75.2	70.1				
	451 167	420 157				
	45.5 205	47.3 199				
19	74.9	69.6				
	450 163	419 151				
	44.5 200	45.6 191				
20	74.5	68.9				
	449 158	417 139				
	43.2 194	42.4 177				
21	73.9					
	448 149					
	41.0 183					
22						

TO %
 KG/H/ENG
 NM/100KG

IAS
 TAS



**ONE ENGINE INOPERATIVE
NORMAL HOLDING
IN FLIGHT**

3.09.30

P 1

500

JUN 97

AA

HOLDING 1 ENGINE

VMHB0 ICING
ISA-10 (.C)
CLEAN CONFIGURATION
AIR COND FLOW:NORM
ANTI/DE ICING:OFF

WEIGHT (1000KG)	FLIGHT LEVEL							
	15	20	30	40	50	60	70	80
13	37.7	37.9	38.2	38.4	38.6	38.9	39.2	39.6
	323	320	316	311	306	302	297	293
	131	131	131	131	131	131	131	131
14	41.3	41.4	41.7	42.0	42.4	42.8	43.2	43.6
	338	336	331	326	321	317	313	310
	136	136	136	136	136	136	136	136
15	44.9	45.1	45.5	46.0	46.4	46.8	47.2	47.7
	353	350	346	341	337	334	331	328
	141	141	141	141	141	141	141	141
16	48.9	49.1	49.5	50.0	50.4	50.9	51.4	51.8
	368	366	361	358	355	352	349	346
	146	146	146	146	146	146	146	146
17	52.9	53.1	53.6	54.1	54.6	55.0	55.5	56.0
	384	382	379	376	373	370	368	366
	150	150	150	150	150	151	151	151
18	57.0	57.2	57.7	58.2	58.7	59.3	59.9	60.5
	402	400	397	394	391	389	387	385
	155	155	155	155	155	155	155	155
19	61.1	61.4	61.9	62.4	63.1	63.7	64.4	65.0
	420	418	415	413	411	409	407	406
	159	159	159	159	159	159	159	159
20	65.3	65.6	66.2	66.9	67.6	68.2	69.0	69.7
	439	437	435	433	431	430	428	426
	163	163	163	163	163	163	163	163
21	69.7	70.0	70.7	71.4	72.1	72.9	73.7	74.6
	459	458	456	454	452	450	449	447
	167	167	167	167	167	167	167	167
22	74.2	74.5	75.3	76.0	76.8	77.7	78.8	80.0
	479	478	476	474	473	471	471	472
	171	171	171	171	171	171	171	171

TQ
KG/H/ENG
IAS



AR72
F.C.O.M.

ONE ENGINE INOPERATIVE

NORMAL HOLDING

IN FLIGHT

3.09.30

P 2

500

JUN 97

AA

HOLDING 1 ENGINE

VMHB0 ICING
ISA
CLEAN CONFIGURATION
AIR COND FLOW:NORM
ANTI/DE ICING:OFF

WEIGHT (1000KG)	FLIGHT LEVEL							
	15	20	30	40	50	60	70	80
13	38.1	38.2	38.4	38.7	39.0	39.3	39.7	40.1
	326	324	319	315	310	306	302	298
	131	131	131	131	131	131	131	131
14	41.6	41.8	42.1	42.5	42.9	43.3	43.7	44.1
	342	339	335	330	326	322	318	315
	136	136	136	136	136	136	136	136
15	45.4	45.6	46.1	46.5	46.9	47.4	47.8	48.2
	357	355	350	346	342	339	336	333
	141	141	141	141	141	141	141	141
16	49.4	49.6	50.1	50.6	51.0	51.5	51.9	52.4
	373	371	367	363	360	357	354	352
	146	146	146	146	146	146	146	146
17	53.5	53.7	54.2	54.7	55.2	55.7	56.2	56.8
	390	388	385	381	379	376	374	373
	150	150	150	150	150	151	151	151
18	57.6	57.9	58.4	58.9	59.5	60.1	60.7	61.3
	408	406	403	400	398	397	395	393
	155	155	155	155	155	155	155	155
19	61.8	62.1	62.7	63.3	63.9	64.6	65.2	65.9
	426	425	422	421	419	417	416	414
	159	159	159	159	159	159	159	159
20	66.1	66.4	67.1	67.8	68.5	69.2	69.9	70.7
	446	445	443	442	440	439	437	436
	163	163	163	163	163	163	163	163
21	70.6	70.9	71.6	72.4	73.1	73.9	74.9	76.0
	467	466	464	463	461	460	459	459
	167	167	167	167	167	167	167	167
22	75.1	75.5	76.3	77.1	77.9	79.1	80.3	81.5
	488	487	486	484	483	483	484	486
	171	171	171	171	171	171	171	171

TQ
KG/H/ENG
IAS



ONE ENGINE INOPERATIVE
NORMAL HOLDING
IN FLIGHT

3.09.30		
P 3	500	
		JUN 97

AA

HOLDING 1 ENGINE								
VMHB0 ICING								
ISA+10 (.C)								
CLEAN CONFIGURATION								
AIR COND FLOW:NORM								
ANTI/DE ICING:OFF								
WEIGHT (1000KG)	FLIGHT LEVEL							
	15	20	30	40	50	60	70	80
13	38.4 329 131	38.5 327 131	38.7 322 131	39.0 318 131	39.4 314 131	39.8 310 131	40.1 306 131	40.5 302 131
14	42.0 345 136	42.1 343 136	42.5 339 136	43.0 334 136	43.4 330 136	43.8 326 136	44.2 322 136	44.6 320 136
15	45.9 362 141	46.1 360 141	46.6 355 141	47.0 351 141	47.4 347 141	47.9 344 141	48.3 341 141	48.8 339 141
16	50.0 378 146	50.2 376 146	50.7 372 146	51.1 368 146	51.6 365 146	52.1 363 146	52.5 360 146	53.1 358 146
17	54.1 395 150	54.3 393 150	54.8 390 150	55.3 387 150	55.8 385 150	56.4 382 151	56.9 381 151	57.5 380 151
18	58.2 414 155	58.5 412 155	59.0 409 155	59.6 407 155	60.2 405 155	60.8 404 155	61.5 402 155	62.1 401 155
19	62.5 433 159	62.8 432 159	63.4 429 159	64.1 428 159	64.8 427 159	65.4 425 159	66.1 424 159	66.8 423 159
20	66.9 453 163	67.3 453 163	68.0 451 163	68.7 450 163	69.4 448 163	70.1 447 163	70.9 446 163	72.0 447 163
21	71.5 475 167	71.8 474 167	72.6 473 167	73.3 472 167	74.1 471 167	75.1 471 167	76.3 471 167	77.4 471 167
22	76.1 497 171	76.5 496 171	77.3 495 171	78.2 494 171	79.4 495 171	80.5 495 171	81.8 496 171	83.1 499 171
TO KG/H/ENG								

 ATR 72 F.C.O.M.	ONE ENGINE INOPERATIVE	3.09.30	
	NORMAL HOLDING	P 4	500
	IN FLIGHT		JUN 97

AA

HOLDING 1 ENGINE								
VMHB0 ICING ISA+20 (.C) CLEAN CONFIGURATION AIR COND FLOW:NORM ANTI/DE ICING:OFF								
WEIGHT (1000KG)	FLIGHT LEVEL							
	15	20	30	40	50	60	70	80
13	38.6	38.8	39.0	39.4	39.8	40.2	40.6	41.0
	332	329	325	322	318	314	310	306
	131	131	131	131	131	131	131	131
14	42.4	42.6	43.0	43.4	43.8	44.2	44.7	45.1
	349	347	343	339	335	331	327	324
	136	136	136	136	136	136	136	136
15	46.4	46.6	47.1	47.5	47.9	48.4	48.8	49.3
	366	364	360	356	352	349	346	344
	141	141	141	141	141	141	141	141
16	50.5	50.7	51.2	51.7	52.1	52.6	53.2	53.7
	383	381	377	373	371	368	366	365
	146	146	146	146	146	146	146	146
17	54.6	54.9	55.4	55.9	56.5	57.1	57.7	58.3
	401	398	396	393	391	389	388	386
	150	150	150	150	150	151	151	151
18	58.8	59.1	59.7	60.4	61.0	61.6	62.3	63.0
	419	418	416	413	412	411	410	409
	155	155	155	155	155	155	155	155
19	63.2	63.6	64.2	64.9	65.6	66.3	67.0	67.9
	440	438	436	435	434	433	432	432
	159	159	159	159	159	159	159	159
20	67.8	68.1	68.8	69.6	70.3	71.1	72.2	73.3
	461	460	459	458	457	456	457	458
	163	163	163	163	163	163	163	163
21	72.4	72.8	73.5	74.3	75.4	76.5	77.6	78.9
	483	483	481	481	481	482	483	484
	167	167	167	167	167	167	167	167
22	77.1	77.5	78.4	79.6	80.8	82.0	83.3	
	506	505	505	506	507	508	509	
	171	171	171	171	171	171	171	

TQ
 KG/H/ENG
 IAS



AR72
F.C.O.M.

ONE ENGINE INOPERATIVE

ICING HOLDING

IN FLIGHT

3.09.35

P 1

500

JUN 97

AA

HOLDING 1 ENGINE

VMHB0 ICING
ISA-10 (.C)
CLEAN CONFIGURATION
AIR COND FLOW:NORM
ANTI/DE ICING:ON

WEIGHT (1000KG)	FLIGHT LEVEL							
	15	20	30	40	50	60	70	80
13	40.1	40.3	40.6	40.9	41.2	41.6	42.0	42.3
	333	331	326	321	316	312	308	305
	131	131	131	131	131	131	131	131
14	44.0	44.1	44.5	44.9	45.3	45.8	46.2	46.6
	349	346	341	337	332	329	326	323
	136	136	136	136	136	136	136	136
15	48.0	48.3	48.7	49.1	49.6	50.0	50.5	50.9
	365	362	358	354	351	348	345	342
	141	141	141	141	141	141	141	141
16	52.3	52.5	53.0	53.4	53.9	54.4	54.8	55.3
	381	379	376	373	370	367	364	362
	146	146	146	146	146	146	146	146
17	56.5	56.8	57.3	57.8	58.3	58.8	59.4	60.1
	400	398	395	392	389	386	385	383
	150	150	150	150	150	151	151	151
18	60.9	61.1	61.7	62.2	62.9	63.6	64.2	64.9
	419	417	414	411	410	408	406	405
	155	155	155	155	155	155	155	155
19	65.3	65.5	66.2	67.0	67.7	68.3	69.0	69.7
	438	437	434	433	431	430	428	426
	159	159	159	159	159	159	159	159
20	69.9	70.3	71.1	71.8	72.5	73.2	74.0	74.9
	459	458	456	455	453	451	450	449
	163	163	163	163	163	163	163	163
21	74.8	75.1	75.8	76.6	77.4	78.2	79.3	80.5
	481	480	478	476	475	473	474	476
	167	167	167	167	167	167	167	167
22	79.5	79.9	80.7	81.5	82.6	83.8	85.0	86.4
	503	502	500	499	498	499	501	504
	171	171	171	171	171	171	171	171

TQ
KG/H/ENG
IAS

**ATR72**

F.C.O.M.

ONE ENGINE INOPERATIVE**ICING HOLDING****IN FLIGHT**

3.09.35

P 2

500

JUN 97

A4

HOLDING 1 ENGINE

VMHB0 ICING

ISA

CLEAN CONFIGURATION

AIR COND FLOW:NORM

ANTI/DE ICING:ON

WEIGHT (1000KG)	FLIGHT LEVEL							
	15	20	30	40	50	60	70	80
13	38.1	38.2	38.4	38.7	39.0	42.0	42.4	42.8
	326	324	319	315	310	316	312	309
	131	131	131	131	131	131	131	131
14	41.6	41.8	42.1	42.5	42.9	46.3	46.7	47.1
	342	339	335	330	326	334	331	328
	136	136	136	136	136	136	136	136
15	45.4	45.6	46.1	46.5	46.9	50.6	51.0	51.5
	357	355	350	346	342	353	350	348
	141	141	141	141	141	141	141	141
16	49.4	49.6	50.1	50.6	51.0	55.0	55.5	56.2
	373	371	367	363	360	373	370	369
	146	146	146	146	146	146	146	146
17	53.5	53.7	54.2	54.7	55.2	59.7	60.3	60.9
	390	388	385	381	379	394	393	391
	150	150	150	150	150	151	151	151
18	57.6	57.9	58.4	58.9	59.5	64.4	65.1	65.8
	408	406	403	400	398	416	415	413
	155	155	155	155	155	155	155	155
19	61.8	62.1	62.7	63.3	63.9	69.3	70.0	70.7
	426	425	422	421	419	438	437	436
	159	159	159	159	159	159	159	159
20	66.1	66.4	67.1	67.8	68.5	74.2	75.2	76.3
	446	445	443	442	440	461	461	461
	163	163	163	163	163	163	163	163
21	70.6	70.9	71.6	72.4	73.1	79.6	80.8	82.1
	467	466	464	463	461	486	487	489
	167	167	167	167	167	167	167	167
22	75.1	75.5	76.3	77.1	77.9	85.3	86.7	88.1
	488	487	486	484	483	512	515	519
	171	171	171	171	171	171	171	171

TQ
KG/H/ENG
IAS



AR72
F.C.O.M.

ONE ENGINE INOPERATIVE

ICING HOLDING

IN FLIGHT

3.09.35

P 3

500

JUN 97

HOLDING 1 ENGINE

VMH80 ICING
ISA +10 (.C)
CLEAN CONFIGURATION
AIR COND FLOW:NORM
ANTI/DE ICING:ON

WEIGHT (1000KG)	FLIGHT LEVEL							
	15	20	30	40	50	60	70	80
13	38.4	38.5	38.7	39.0	39.4	39.8	40.1	40.5
	329	327	322	318	314	310	306	302
	131	131	131	131	131	131	131	131
14	42.0	42.1	42.5	43.0	43.4	43.8	44.2	44.6
	345	343	339	334	330	326	322	320
	136	136	136	136	136	136	136	136
15	45.9	46.1	46.6	47.0	47.4	47.9	48.3	48.8
	362	360	355	351	347	344	341	339
	141	141	141	141	141	141	141	141
16	50.0	50.2	50.7	51.1	51.6	52.1	52.5	53.1
	378	376	372	368	365	363	360	358
	146	146	146	146	146	146	146	146
17	54.1	54.3	54.8	55.3	55.8	56.4	56.9	57.5
	395	393	390	387	385	382	381	380
	150	150	150	150	150	151	151	151
18	58.2	58.5	59.0	59.6	60.2	60.8	61.5	62.1
	414	412	409	407	405	404	402	401
	155	155	155	155	155	155	155	155
19	62.5	62.8	63.4	64.1	64.8	65.4	66.1	66.8
	433	432	429	428	427	425	424	423
	159	159	159	159	159	159	159	159
20	66.9	67.3	68.0	68.7	69.4	70.1	70.9	72.0
	453	453	451	450	448	447	446	447
	163	163	163	163	163	163	163	163
21	71.5	71.8	72.6	73.3	74.1	75.1	76.3	77.4
	475	474	473	472	471	471	471	471
	167	167	167	167	167	167	167	167
22	76.1	76.5	77.3	78.2	79.4	80.5	81.8	83.1
	497	496	495	494	495	495	496	499
	171	171	171	171	171	171	171	171

TQ
KG/H/ENG
IAS



AR72
F.C.O.M.

ONE ENGINE INOPERATIVE

ICING HOLDING

IN FLIGHT

3.09.35

P 4

500

JUN 97

HOLDING 1 ENGINE

VMHB0 ICING
ISA+20 (.C)
CLEAN CONFIGURATION
AIR COND FLOW:NORM
ANTI/DE ICING:ON

WEIGHT (1000KG)	FLIGHT LEVEL							
	15	20	30	40	50	60	70	80
13	38.6	38.8	39.0	39.4	39.8	40.2	40.6	41.0
	332	329	325	322	318	314	310	306
	131	131	131	131	131	131	131	131
14	42.4	42.6	43.0	43.4	43.8	44.2	44.7	45.1
	349	347	343	339	335	331	327	324
	136	136	136	136	136	136	136	136
15	46.4	46.6	47.1	47.5	47.9	48.4	48.8	49.3
	366	364	360	356	352	349	346	344
	141	141	141	141	141	141	141	141
16	50.5	50.7	51.2	51.7	52.1	52.6	53.2	53.7
	383	381	377	373	371	368	366	365
	146	146	146	146	146	146	146	146
17	54.6	54.9	55.4	55.9	56.5	57.1	57.7	58.3
	401	398	396	393	391	389	388	386
	150	150	150	150	150	151	151	151
18	58.8	59.1	59.7	60.4	61.0	61.6	62.3	63.0
	419	418	416	413	412	411	410	409
	155	155	155	155	155	155	155	155
19	63.2	63.6	64.2	64.9	65.6	66.3	67.0	67.9
	440	438	436	435	434	433	432	432
	159	159	159	159	159	159	159	159
20	67.8	68.1	68.8	69.6	70.3	71.1	72.2	73.3
	461	460	459	458	457	456	457	458
	163	163	163	163	163	163	163	163
21	72.4	72.8	73.5	74.3	75.4	76.5	77.6	78.9
	483	483	481	481	481	482	483	484
	167	167	167	167	167	167	167	167
22	77.1	77.5	78.4	79.6	80.8	82.0	83.3	
	506	505	505	506	507	508	509	
	171	171	171	171	171	171	171	

TQ
KG/H/ENG
IAS



ATR 72
F.C.O.M.

FLIGHT PLANNING

CONTENTS

3.10.00

P 1

001

MAY 90

- 3.10.00 CONTENTS**
- 3.10.01 FUEL POLICY**
- 3.10.02 FUEL AND TIME TO DESTINATION**
- 3.10.03 ALTERNATE**
- 3.10.04 FERRY FLIGHTS**

AA

 AFR 72 F.C.O.M.	FLIGHT PLANNING	3.10.01		
		P 1	500	
	FUEL POLICY			JUL 99

AA

RECOMMENDED FUEL REQUIREMENTS

The total fuel quantity required to fly a given sector is the sum of the following quantities :

A. TAXI FUEL

Quantity required for start up and TAXI (average quantity 2 mn/14 kg - 30 lb)

B. TRIP FUEL

Fuel required from departure to destination includes the following quantities :

- Take-off and initial climb (average quantity 1 mn/24 kg - 53 lb)
- Climb at selected speed
- Cruise
- Descent from cruising level to 1.500 ft above destination airport
- Approach and landing (average quantity 3 mn/30 kg - 66 lb)

C. "EN ROUTE" RESERVE FUEL

According to national regulations and company policy (generally based on a percentage of TRIP FUEL).

D. ALTERNATE FUEL

Fuel required to fly from destination to alternate airport. It includes go-around climb to cruising level, cruise at long range speed, descent and approach procedure.

E. HOLDING FUEL

Fuel required for holding, calculated at minimum drag speed with the estimated mass or arrival at the alternate or the destination aerodrome, when no alternate is required.

FLIGHT PLAN

When no FOS precalculated flight plan is available, flight planning can be determined by using the graph given in 3.10.02 with a good approximation.

Computations include the average quantities for taxi in and out, take-off initial climb, approach and landing.

5 % of trip fuel is included in the computation.



FLIGHT PLANNING

FUEL POLICY

3.10.07

P 2

001

JUN 94

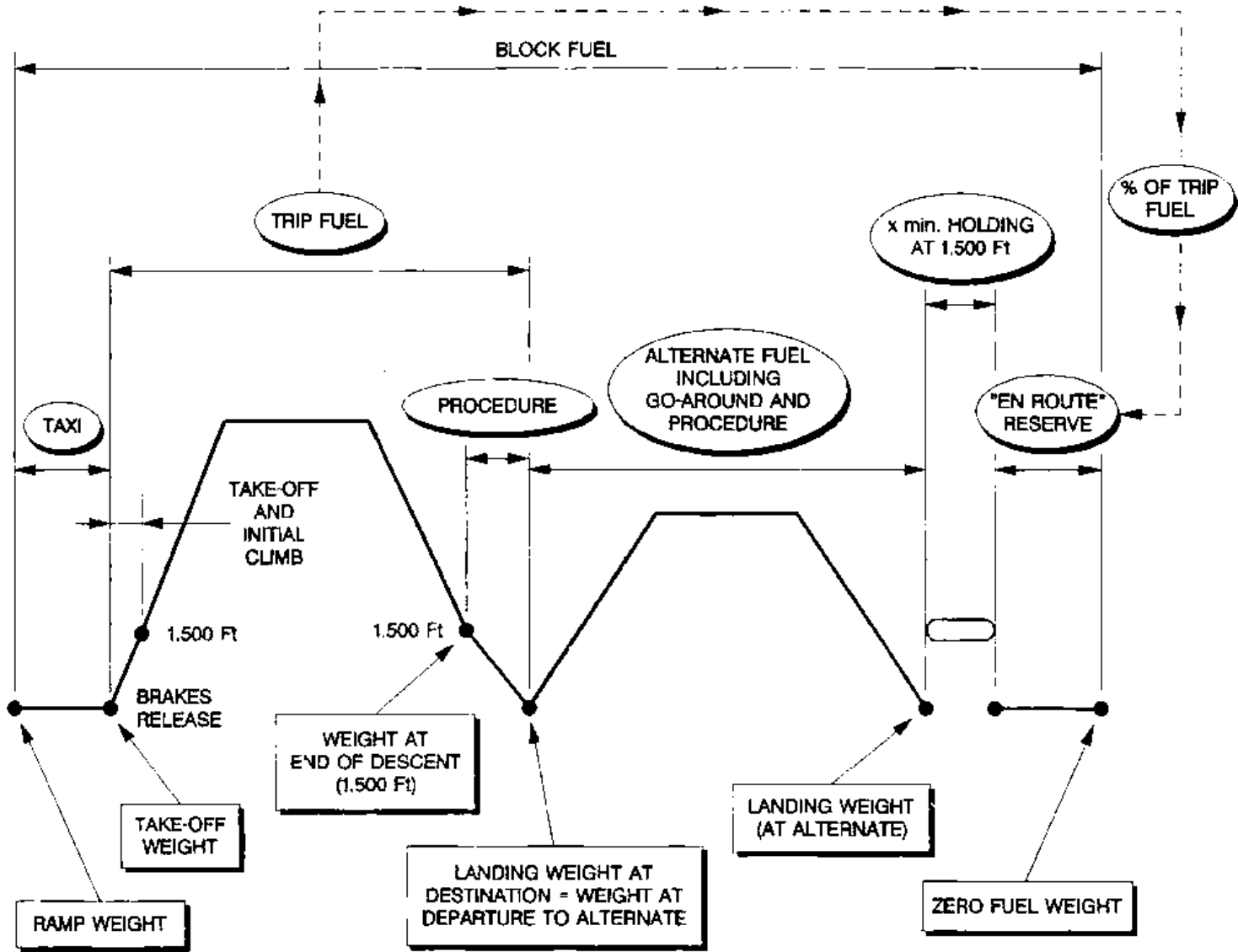

R
R



FLIGHT PLANNING

FUEL TO DESTINATION CALCULATION

3.10.02

P 1

300

JUN 97

REFERENCE TAKE OFF WEIGHT = 20500Kg(45200Lb)
ISA
CLIMB 170kt MAX CRUISE DESCENT 220kt

CORRECTIONS
 Δ WEIGHT = ± 1000Kg(± 2200Lb)
 Δ FUEL = ± 1.3Kg(± 2.8Lb)/100Nm
 Δ ISA = ± 10°C
 Δ FUEL = ± 11Kg(± 24Lb)/100Nm

EXAMPLE :
 600Nm
 FL220
 20500Kg
 50kt TAIL WIND
 1400Kg(3100Lb)

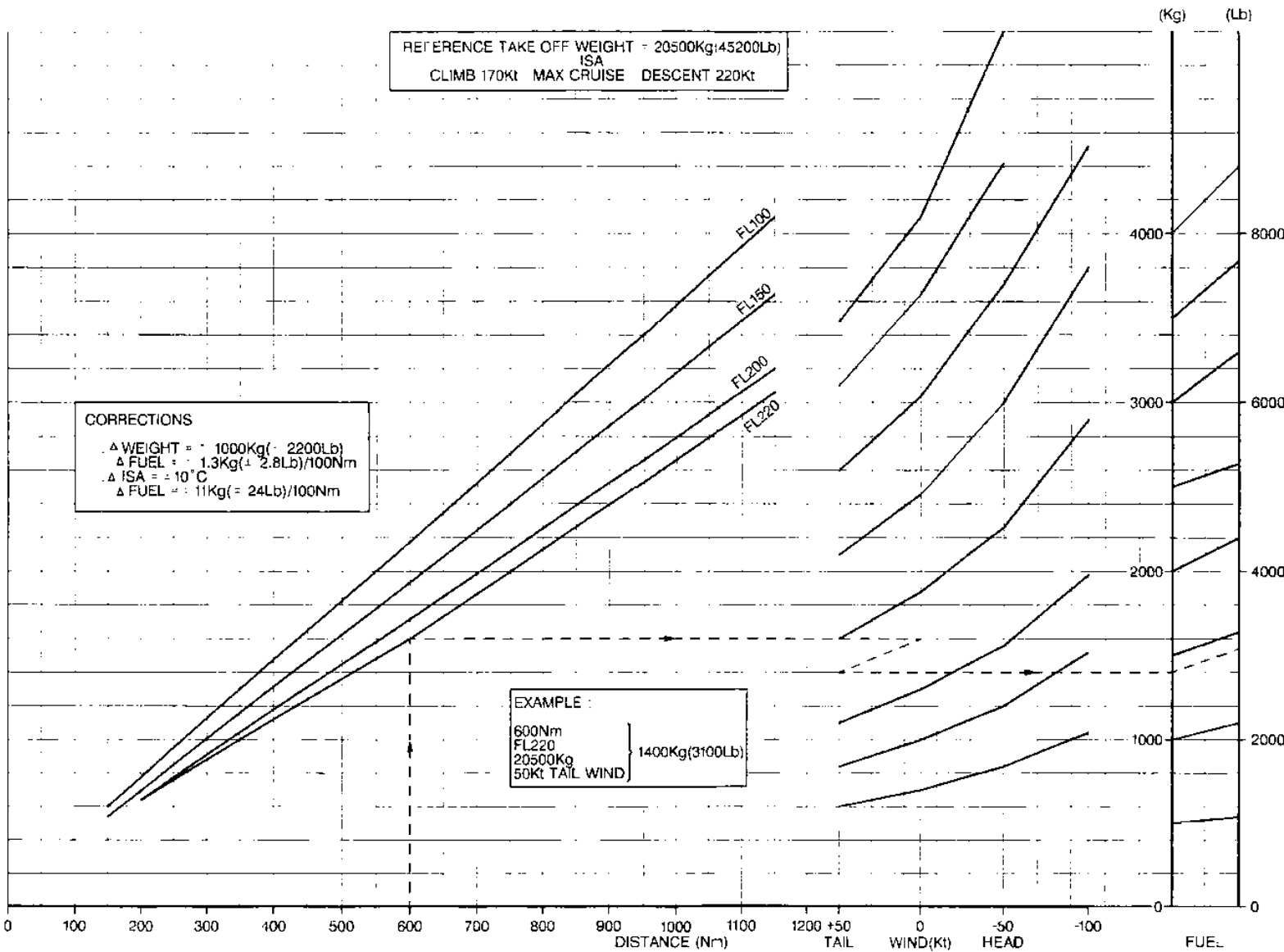



A320
F.C.O.M.

FLIGHT PLANNING

TIME TO DESTINATION CALCULATION

3.10.02

P 2

300

JUN 97

REFERENCE TAKE-OFF WEIGHT = 20500Kg(45200Lb)
ISA
CLIMB 170kt MAX CRUISE - DESCENT 220kt

CORRECTIONS

- Δ WEIGHT = ± 1000 Kg (± 2200Lb)
- Δ TIME = ± 0.1 mn/100Nm
- Δ ISA = ± 10°C
- Δ TIME = ± 0.5 mn/100Nm

EXAMPLE :

650Nm
FL100
20500Kg
50kt TAIL WIND } 130mn
(2h10)

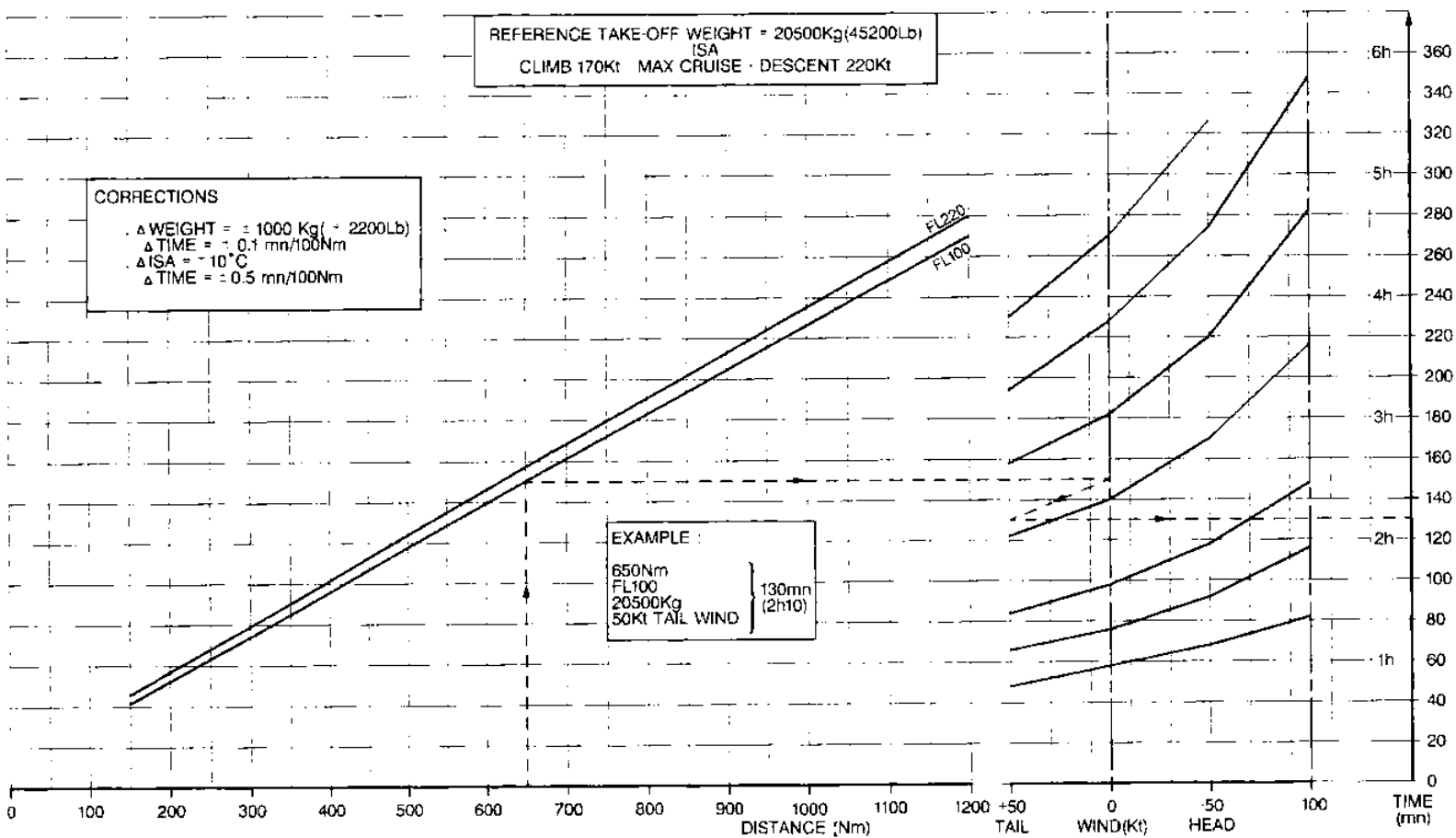



ATR 72
F.C.O.M.

FLIGHT PLANNING

3.10.03

P 1

500

ALTERNATE CALCULATION

JUL 98

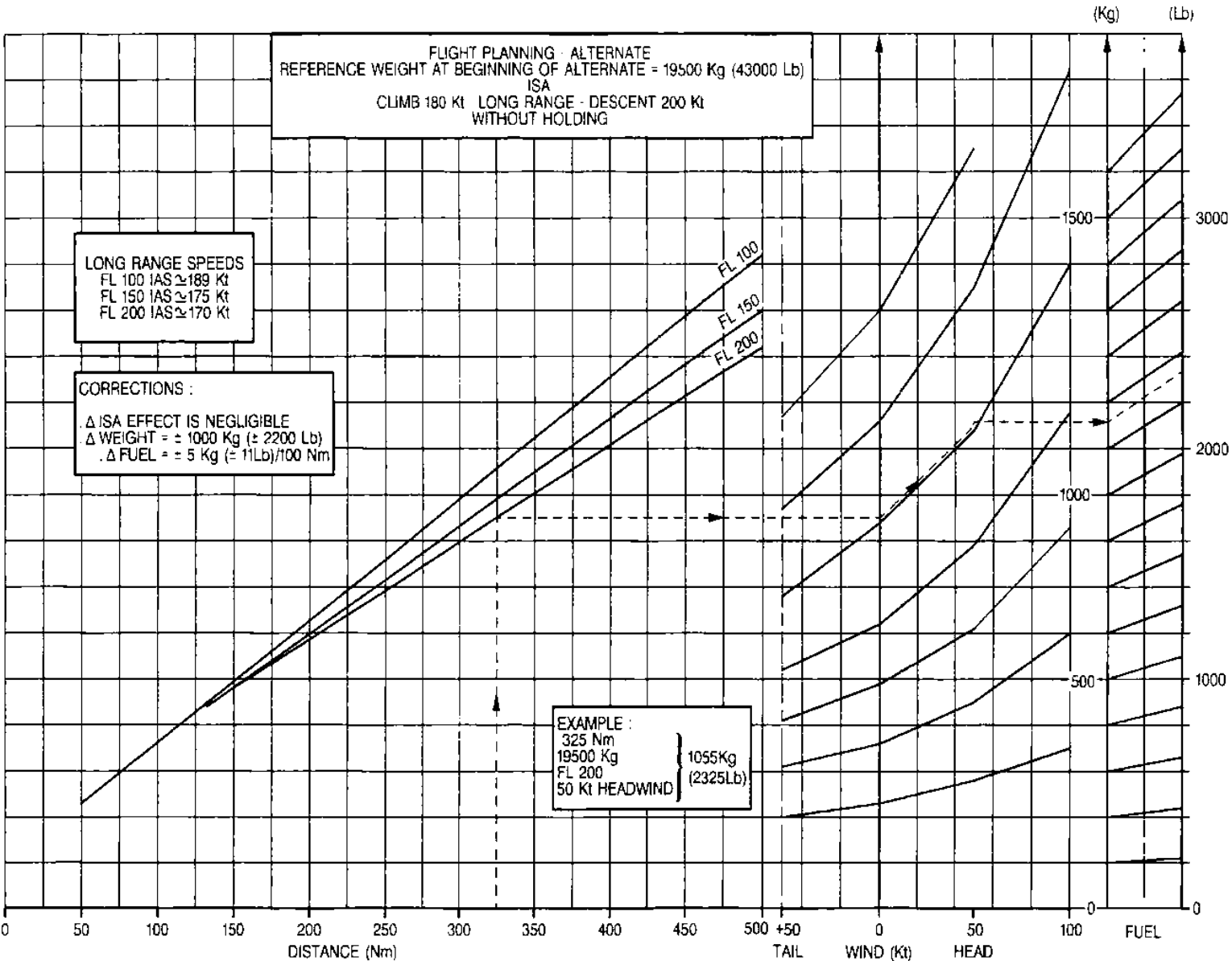

R
R



ATR72
F.C.O.M.

FLIGHT PLANNING

FERRY FLIGHTS

3.10.04

P 1

300

JUN 97

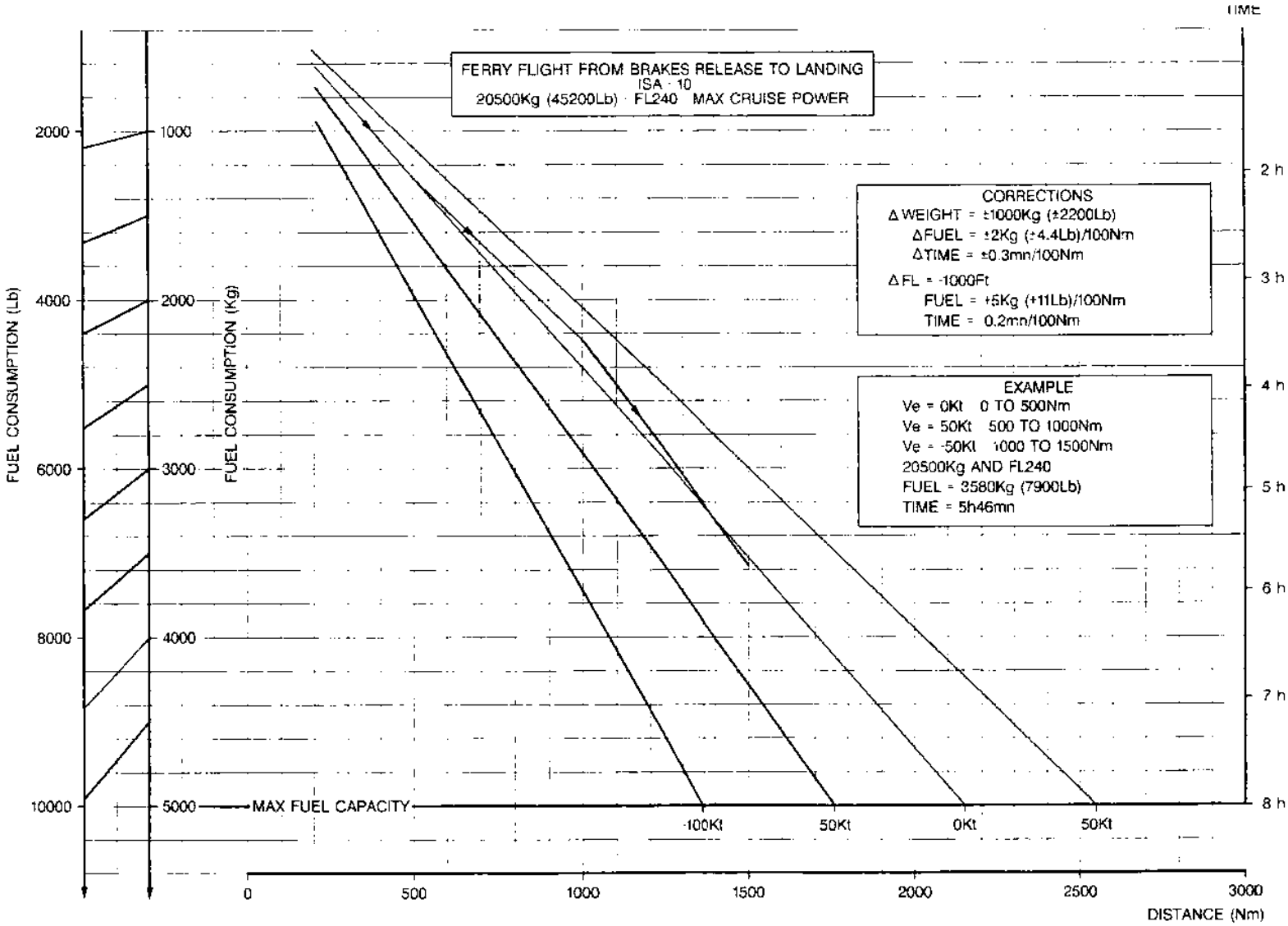

A-03-10-00-109-1-A30034



ATR 72
F.C.O.M.

FLIGHT PLANNING

FERRY FLIGHTS

3.10.04

P 2 300

JUN 97

AA

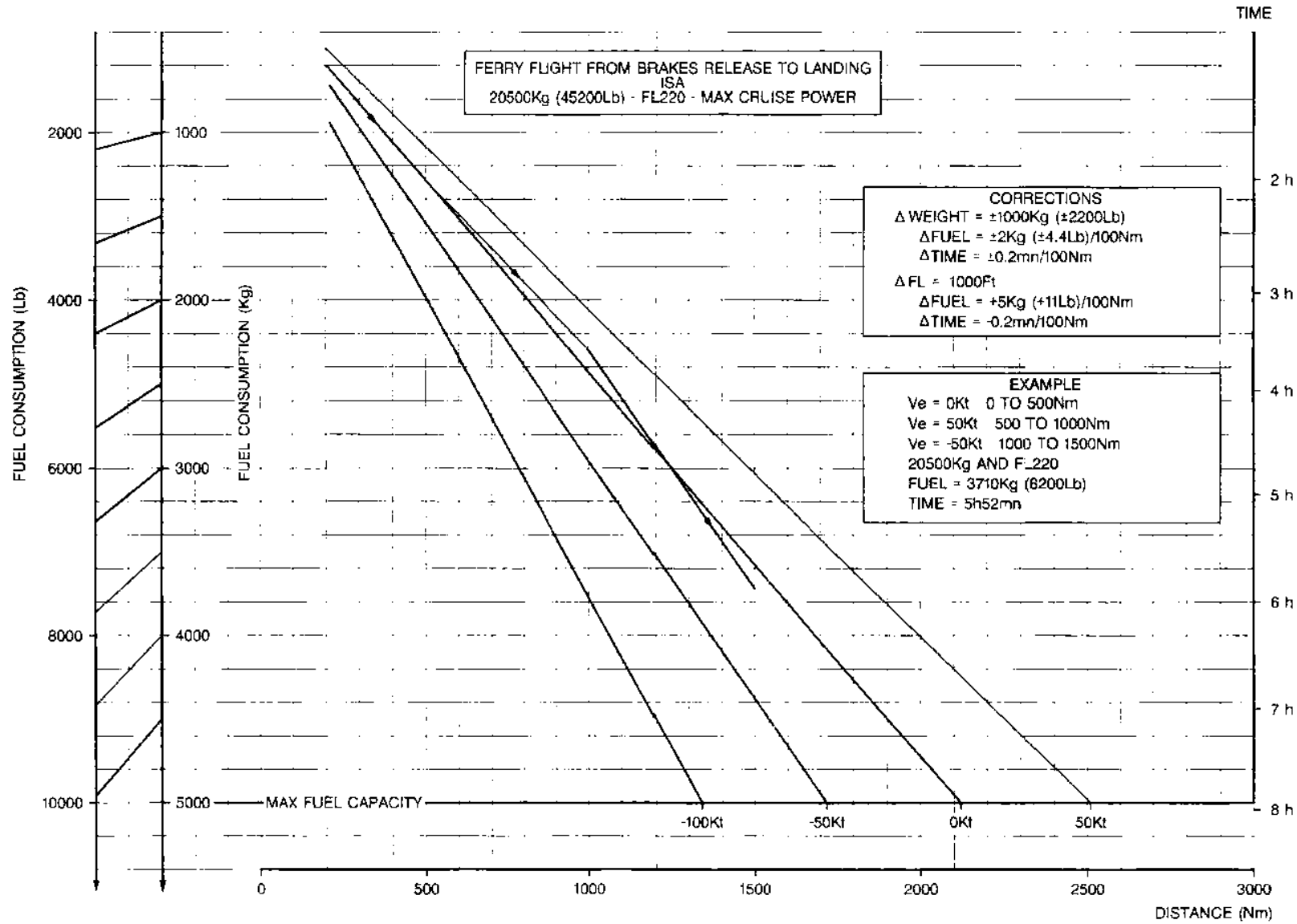



ATR 72
F.C.O.M.

FLIGHT PLANNING

FERRY FLIGHTS

3.10.04

P 3

300

JUN 97

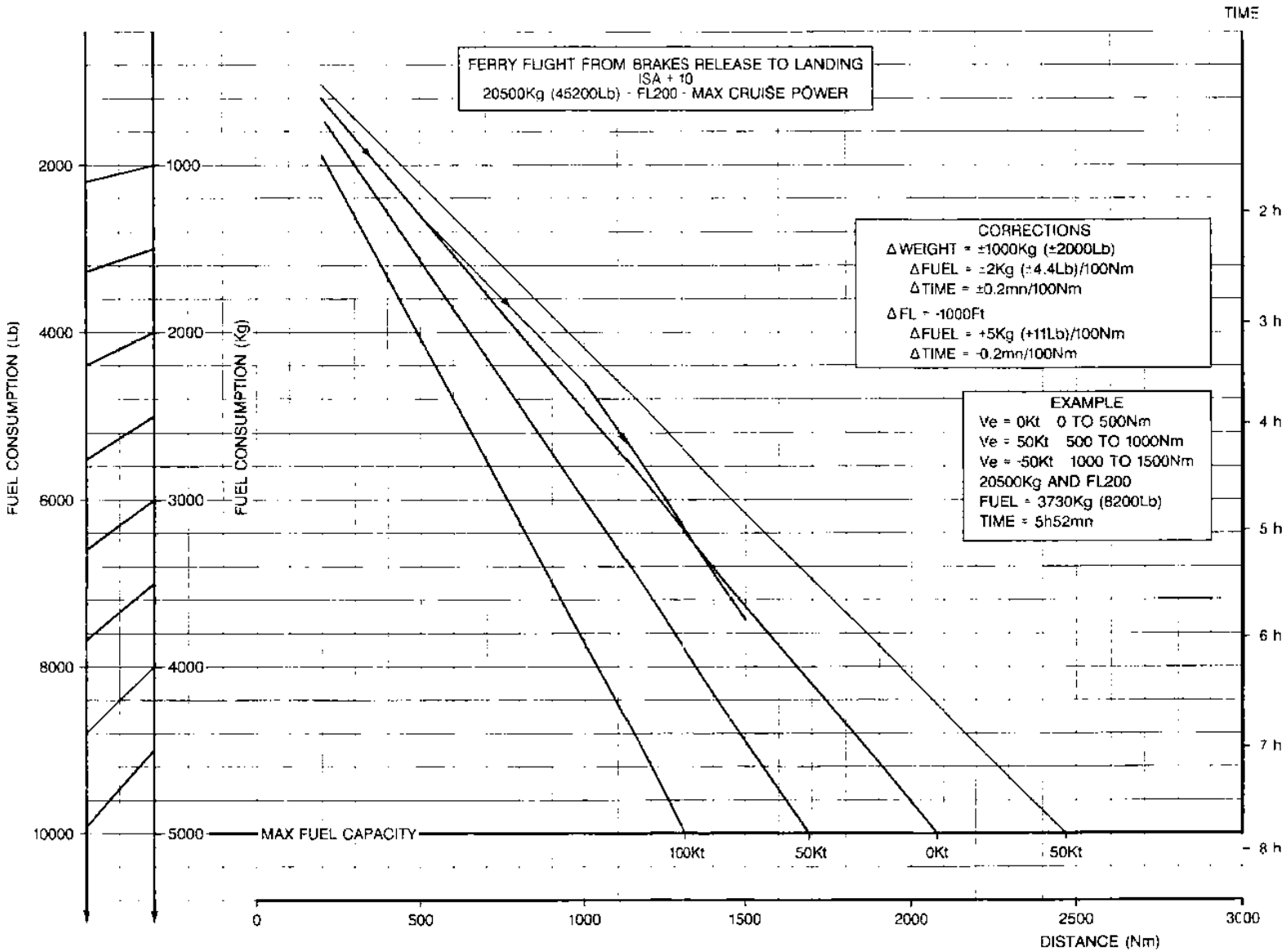



FLIGHT PLANNING

FERRY FLIGHTS

3.10.04

P 4

300

JUN 97

AA

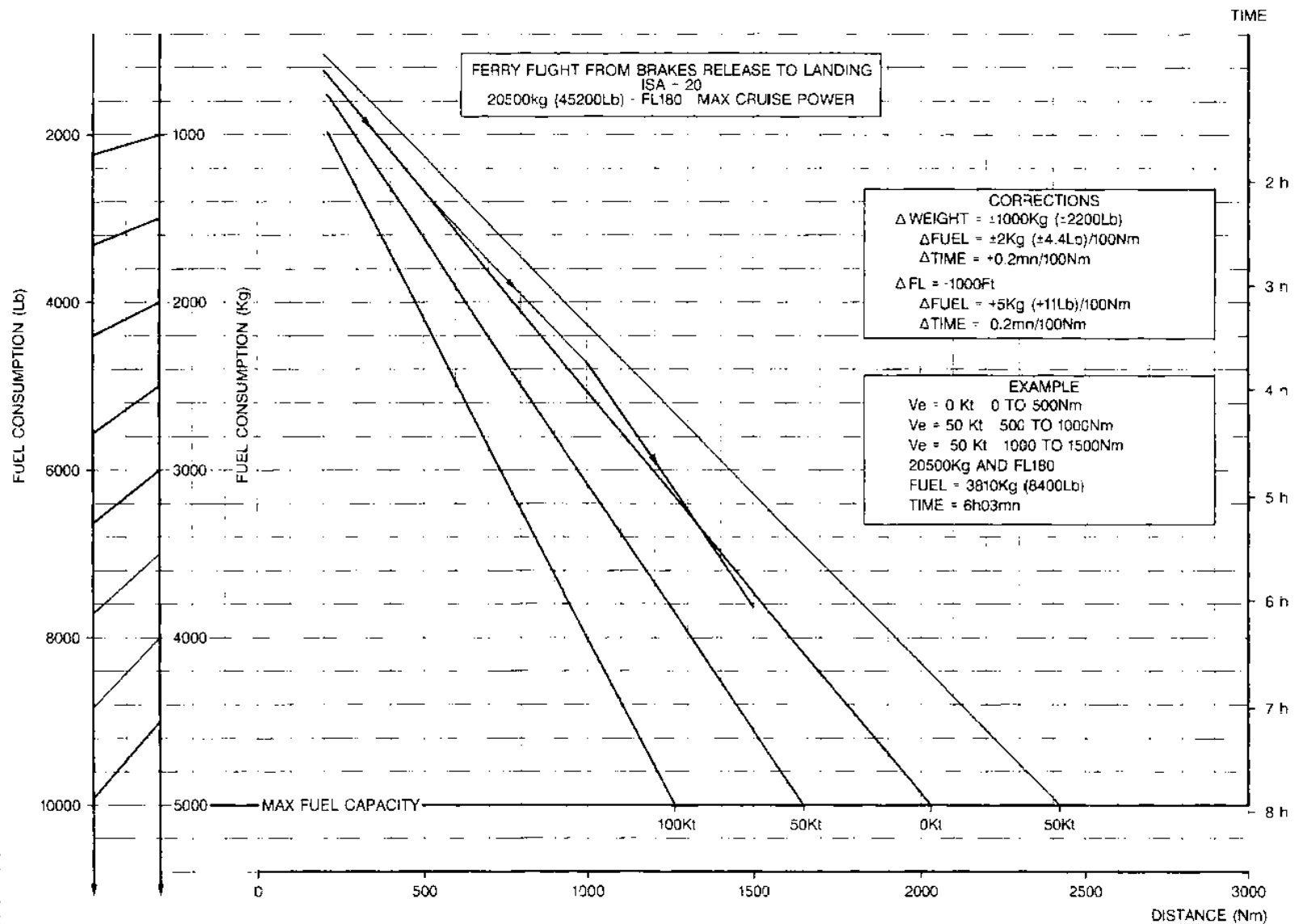

	SPECIAL OPERATIONS CONTENTS	3.11.00		
		P 1	001	
				DEC 96

AA

- 3.11.00 **CONTENTS**
- 3.11.01 **FLIGHT WITH LANDING GEAR DOWN**
- 3.11.02 **DISPATCH WITH FLAPS RETRACTED**
- 3.11.03 **DISPATCH WITH ANTI SKID INOPERATIVE**
- 3.11.04 **DISPATCH WITH AUTOFEATHER SYSTEM INOPERATIVE**
- 3.11.05 **DISPATCH WITH EEC OFF**
- 3.11.06 **DISPATCH WITH ONE AFU INOPERATIVE**
- R 3.11.07 **DISPATCH WITH ONE TQ INDICATOR INOPERATIVE**
- 3.11.08 **DISPATCH WITH ATPCS OFF**
- 3.11.09 **ETOPS**
- 3.11.10 **OPERATION ON NARROW RUNWAYS**
- R 3.11.11 **DRY UNPAVED RUNWAYS**

	SPECIAL OPERATIONS DISPATCH INTRODUCTION	3.11.00		
		P 2	001	
				JUL 01

AA

All dispatch cases are described in the AFM, part 7-02.

Many dispatches may be taken into account using the FOS software that given accurate computation.

Nevertheless, no combination of dispatches is allowed.

	SPECIAL OPERATIONS		3.11.01	
	FLIGHT WITH LANDING GEAR DOWN		P 1	500
			JUL 98	

AA

GENERAL

Extended overwater flight is not allowed. It is necessary to take into account the increased drag to determine the take off weight and fuel consumption.

Flight in icing conditions is prohibited with gear down.

R Refer to the MEL for the operating procedures.

DETERMINATION OF MAX TAKE OFF WEIGHT

R Penalties on performance affect the WAT; Decrease the weight determined with the WAT

R table (3.03.03 P 1) by 23 %.

APPROACH CLIMB PERFORMANCE

Decrease the basic limiting weight by 13 %.

FLIGHT PLANNING

Climb

Climb at 160 kt with both engines at maximum climb power setting. The tables in 3.11.01 p 2 to 9 give the time, distance and fuel consumption according to take-off weight.

Cruise

R The maximum speed with landing gear down is 185 kt.

The maximum recommended altitude is 16000 ft.

The recommended cruise speed is 160 kt.

Pages 3.11.01 p 10 to 13 give cruise tables at this speed.

Obviously, the ceiling on one engine may be a limiting factor, and the choice of the route should reflect this concern.

Engine failure

The weight penalty on single engine ceiling computation is 21%, consequently decrease the single engine ceiling by :

ACTUAL WEIGHT KG (lb)	ISA - 10	ISA	ISA + 10	ISA + 20
22 000 (48 500)	- 34 %	- 38 %	- 42 %	- 57 %
21 000 (46 300)	- 30 %	- 34 %	- 38 %	- 47 %
20 000 (44 100)	- 28 %	- 30 %	- 35 %	- 40 %
19 000 (41 900) and below	- 27 %	- 28 %	- 32 %	- 34 %

HOLDING

Page 3.11.01 p. 14 gives the holding parameters.



ATR 72
F.C.O.M.

SPECIAL OPERATIONS

FLIGHT WITH LANDING GEAR DOWN

3.11.01

P 2

500

JUN 97

AA

CLIMB 2 ENGINES

ISA-10 (.C)

160KT(IAS)

FL	WEIGHT AT START OF CLIMB (1000KG)					
	13	14	15	16	17	18
160	8 123	9 136	10 149	11 163	12 180	13 197
	24 179	27 179	29 179	32 179	35 180	39 180
140	7 102	7 112	8 122	9 134	9 146	10 160
	19 175	21 175	23 175	25 176	27 176	30 176
120	5 83	6 90	6 99	7 108	7 118	8 128
	15 172	16 172	18 172	19 172	21 172	23 172
100	4 65	4 71	5 78	5 85	6 92	6 100
	11 168	12 169	13 169	15 169	16 169	17 169
80	3 49	3 54	4 58	4 64	4 69	5 75
	8 166	9 166	10 166	11 166	12 166	13 166
60	2 34	2 37	2 40	3 44	3 47	3 51
	6 163	6 163	7 163	7 164	8 164	8 164
40	1 19	1 20	1 22	1 24	2 26	2 28
	3 160	3 161	4 161	4 161	4 161	5 161
15	0 0	0 0	0 0	0 0	0 0	0 0
	0	0	0	0	0	0

FROM START OF CLIMB TIME
(MIN)
FROM START OF CLIMB DIST.
(NM)

FUEL
(KG)
MEAN SPEED
TAS.(KT)



AR72
F.C.O.M.

SPECIAL OPERATIONS

FLIGHT WITH LANDING GEAR DOWN

3.11.01

P 3

500

JUN 97

CLIMB 2 ENGINES

ISA-10 (.C)

160KT(IAS)

WEIGHT AT START OF CLIMB (1000KG)

FL	WEIGHT AT START OF CLIMB (1000KG)					
	18	19	20	21	22	22.5
160	13 197	14 217	16 240	18 265	20 296	21 314
	39 180	43 180	48 180	53 181	59 181	63 181
140	10 160	11 175	12 192	14 210	15 232	16 245
	30 176	33 176	36 176	40 176	44 176	46 177
120	8 128	9 140	10 153	10 167	11 183	12 192
	23 172	25 172	27 173	30 173	33 173	35 173
100	6 100	7 109	7 119	8 129	9 141	9 148
	17 169	19 169	21 169	22 169	24 169	26 170
80	5 75	5 82	5 89	6 96	6 105	7 110
	13 166	14 166	15 166	16 167	18 167	18 167
60	3 51	3 56	4 61	4 66	4 72	5 75
	8 164	9 164	10 164	11 164	12 164	12 164
40	2 28	2 31	2 33	2 36	2 39	2 41
	5 161	5 161	5 161	6 162	6 162	7 162
15	0 0	0 0	0 0	0 0	0 0	0 0
	0	0	0	0	0	0

FROM START OF CLIMB TIME
(MIN)
FROM START OF CLIMB DIST.
(NM)

FUEL
(KG)
MEAN SPEED
TAS.(KT)

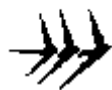

ATR 72
F.C.O.M.

SPECIAL OPERATIONS

FLIGHT WITH LANDING GEAR DOWN

3.11.01

P 4

500

JUN 97

AA

CLIMB 2 ENGINES

ISA

160KT(IAS)

WEIGHT AT START OF CLIMB (1000KG)

FL	WEIGHT AT START OF CLIMB (1000KG)					
	13	14	15	16	17	18
160	10 142	11 156	12 173	13 190	14 211	16 234
	30 183	33 183	36 184	40 184	44 184	49 184
140	8 115	8 127	9 139	10 153	11 168	12 185
	23 179	25 179	28 179	30 180	34 180	37 180
120	6 92	7 102	7 111	8 122	9 134	9 146
	17 175	19 176	21 176	23 176	25 176	28 176
100	5 72	5 79	5 86	6 94	6 103	7 113
	13 172	14 172	16 172	17 173	19 173	20 173
80	3 53	4 58	4 64	4 70	5 76	5 83
	9 169	10 169	11 169	12 169	13 170	14 170
60	2 36	2 40	3 43	3 47	3 51	3 56
	6 166	7 166	7 166	8 167	9 167	9 167
40	1 20	1 22	1 24	2 26	2 28	2 30
	3 163	4 164	4 164	4 164	5 164	5 164
15	0 0	0 0	0 0	0 0	0 0	0 0
	0	0	0	0	0	0
FROM START OF CLIMB TIME (MIN)				FUEL (KG)		
FROM START OF CLIMB DIST. (NM)				MEAN SPEED TAS.(KT)		

 ATR 72 F.C.O.M.	SPECIAL OPERATIONS	3.11.01		
	FLIGHT WITH LANDING GEAR DOWN	P 5	500	
				JUN 97

AA

CLIMB 2 ENGINES						
ISA	160KT(IAS)					
FL	WEIGHT AT START OF CLIMB (1000KG)					
	18	19	20	21	22	22.5
160	16 234	18 260	20 291	23 328	26 375	
	49 184	55 185	62 185	70 185	81 186	
140	12 185	14 204	15 226	17 251	19 281	20 299
	37 180	41 180	45 180	50 181	57 181	60 181
120	9 146	10 161	11 176	13 194	14 215	15 227
	28 176	30 176	34 176	37 177	41 177	43 177
100	7 113	8 123	8 135	9 147	10 162	11 170
	20 173	22 173	24 173	27 173	29 173	31 173
80	5 83	6 90	6 98	7 107	7 117	8 123
	14 170	16 170	17 170	19 170	20 170	21 170
60	3 56	4 60	4 66	4 71	5 78	5 81
	9 167	10 167	11 167	12 167	13 167	14 167
40	2 30	2 33	2 36	2 39	3 42	3 44
	5 164	5 164	6 164	6 164	7 165	7 165
15	0 0	0 0	0 0	0 0	0 0	0 0
	0	0	0	0	0	0
FROM START OF CLIMB TIME (MIN)					FUEL (KG)	
FROM START OF CLIMB DIST. (NM)					MEAN SPEED TAS.(KT)	



AR72
F.C.O.M.

SPECIAL OPERATIONS

FLIGHT WITH LANDING GEAR DOWN

3.11.01

P 6

500

JUN 97

CLIMB 2 ENGINES

ISA+10 (.C)

160KT(IAS)

WEIGHT AT START OF CLIMB (1000KG)

FL	WEIGHT AT START OF CLIMB (1000KG)					
	13	14	15	16	17	18
160	13 175	14 195	16 217	18 243	20 273	23 310
	40 188	44 188	50 188	56 188	63 189	72 189
140	10 139	11 155	12 171	13 190	15 211	17 236
	30 183	33 183	37 184	41 184	46 184	51 184
120	8 110	8 122	9 134	10 148	11 164	12 182
	23 179	25 179	28 180	30 180	34 180	37 180
100	6 85	6 93	7 103	7 113	8 124	9 137
	16 176	18 176	20 176	22 176	24 176	27 176
80	4 62	4 68	5 75	5 82	6 90	6 98
	11 173	13 173	14 173	15 173	17 173	18 173
60	3 41	3 45	3 50	3 54	4 59	4 65
	7 170	8 170	9 170	10 170	11 170	12 170
40	1 22	1 24	2 27	2 29	2 32	2 35
	4 167	4 167	5 167	5 167	5 167	6 167
15	0 0	0 0	0 0	0 0	0 0	0 0
	0	0	0	0	0	0

FROM START OF CLIMB TIME
(MIN)
FROM START OF CLIMB DIST.
(NM)

FUEL
(KG)
MEAN SPEED
TAS.(KT)



A320
F.C.O.M.

SPECIAL OPERATIONS

FLIGHT WITH LANDING GEAR DOWN

3.11.01

P 7

500

JUN 97

CLIMB 2 ENGINES

ISA+10 (.C)

160KT(IAS)

FL	WEIGHT AT START OF CLIMB (1000KG)					
	18	19	20	21	22	22.5
160	23 310	26 354				
	72 189	82 190				
140	17 236	19 265	21 299	24 341		
	51 184	58 184	65 185	75 185		
120	12 182	14 202	15 225	17 252	20 286	21 306
	37 180	42 180	46 180	52 181	59 181	64 181
100	9 137	10 151	11 167	12 185	14 207	15 220
	27 176	30 177	33 177	36 177	41 177	43 177
80	6 98	7 108	8 119	8 131	9 145	10 153
	18 173	20 173	22 173	24 173	27 173	29 173
60	4 65	4 71	5 78	5 85	6 94	6 98
	12 170	13 170	14 170	15 170	17 170	18 170
40	2 35	2 38	3 41	3 45	3 49	3 52
	6 167	6 167	7 167	8 168	8 168	9 168
15	0 0	0 0	0 0	0 0	0 0	0 0
	0	0	0	0	0	0
FROM START OF CLIMB TIME (MIN)				FUEL (KG)		
FROM START OF CLIMB DIST. (NM)				MEAN SPEED TAS.(KT)		



AR72
F.C.O.M.

SPECIAL OPERATIONS

FLIGHT WITH LANDING GEAR DOWN

3.11.01

P 8

500

JUN 97

AA

CLIMB 2 ENGINES

ISA+20 (.C)

160KT(IAS)

WEIGHT AT START OF CLIMB (1000KG)

FL	WEIGHT AT START OF CLIMB (1000KG)					
	13	14	15	16	17	18
160	19 242	22 275				
	61 192	69 193				
140	14 184	16 206	18 232	20 263	23 300	
	43 187	49 188	55 188	62 188	72 188	
120	10 142	12 158	13 176	14 197	16 222	19 251
	32 183	35 183	39 183	44 184	50 184	57 184
100	8 107	8 118	9 131	10 146	12 163	13 182
	23 179	25 180	28 180	31 180	35 180	39 180
80	5 77	6 85	6 94	7 103	8 115	9 127
	16 176	17 176	19 176	21 176	23 176	26 176
60	3 50	4 55	4 61	5 67	5 74	6 82
	10 173	11 173	12 173	13 173	14 173	16 173
40	2 27	2 29	2 32	2 35	3 39	3 43
	5 170	5 170	6 170	7 170	7 170	8 170
15	0 0	0 0	0 0	0 0	0 0	0 0
	0	0	0	0	0	0

FROM START OF CLIMB TIME
(MIN)
FROM START OF CLIMB DIST.
(NM)

FUEL
(KG)
MEAN SPEED
TAS.(KT)

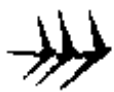

AJR72
F.C.O.M.

SPECIAL OPERATIONS

FLIGHT WITH LANDING GEAR DOWN

3.11.01

P 9

500

JUN 97

AA

CLIMB 2 ENGINES

ISA+20 (.C)

160KT(IAS)

WEIGHT AT START OF CLIMB (1000KG)

FL	WEIGHT AT START OF CLIMB (1000KG)					
	18	19	20	21	22	22.5
160						
140						
120	19 251 57 184	21 287 65 184	25 332 75 185			
100	13 182 39 180	15 205 44 180	17 233 50 180	19 266 57 180	22 309 67 181	
80	9 127 26 176	10 142 29 177	11 159 32 177	12 179 37 177	14 204 42 177	15 219 45 177
60	6 82 16 173	6 91 18 173	7 101 20 173	8 112 22 173	9 126 25 173	9 134 26 174
40	3 43 8 170	3 47 9 170	3 52 10 170	4 58 11 170	4 64 12 171	4 68 13 171
15	0 0 0	0 0 0	0 0 0	0 0 0	0 0 0	0 0 0

FROM START OF CLIMB TIME
(MIN)
FROM START OF CLIMB DIST.
(NM)

FUEL
(KG)
MEAN SPEED
TAS.(KT)

	SPECIAL OPERATIONS				3.11.01		
					P 10	500	
	FLIGHT WITH LANDING GEAR DOWN						JUN 97

AA

CRUISE 2 ENGINES												
ISA-10 (°C)						160KT(IAS)						
WEIGHT (1000KG)	FLIGHT LEVEL											
	60		80		100		120		140		160	
13	46.8		47.9		49.3		50.8		52.2		53.7	
	292	160	286	160	283	160	281	160	279	160	279	160
	29.1	170	30.5	175	31.8	180	33.0	186	34.3	192	35.5	198
14	47.6		48.7		50.1		51.7		53.1		54.6	
	294	160	289	160	286	160	284	160	283	160	282	160
	28.9	170	30.3	175	31.5	180	32.7	186	33.9	192	35.1	198
15	48.4		49.5		51.0		52.6		54.1		55.6	
	297	160	291	160	289	160	288	160	286	160	286	160
	28.6	170	30.0	175	31.1	180	32.3	186	33.5	192	34.6	198
16	49.3		50.5		52.0		53.7		55.1		56.7	
	300	160	295	160	293	160	292	160	290	160	290	160
	28.3	170	29.7	175	30.7	180	31.8	186	33.0	192	34.1	198
17	50.3		51.6		53.2		54.9		56.4		58.0	
	303	160	299	160	298	160	297	160	295	160	295	160
	28.0	170	29.2	175	30.3	180	31.3	186	32.5	192	33.5	198
18	51.4		52.8		54.4		56.2		57.7		59.4	
	307	160	304	160	302	160	302	160	301	160	301	160
	27.6	170	28.8	175	29.8	180	30.8	186	31.9	192	32.9	198
19	52.6		54.1		55.8		57.6		59.1		60.8	
	311	160	309	160	308	160	307	160	306	160	307	160
	27.3	170	28.3	175	29.3	180	30.3	186	31.3	192	32.2	198
20	53.9		55.5		57.2		59.1		60.7		62.4	
	315	160	314	160	313	160	313	160	312	160	313	160
	26.9	170	27.9	175	28.8	180	29.7	186	30.7	192	31.6	198
21	55.3		57.0		58.7		60.6		62.3		64.1	
	321	160	320	160	319	160	319	160	319	160	320	160
	26.5	170	27.4	175	28.2	180	29.2	186	30.1	192	30.9	198
22	56.9		58.6		60.5		62.4		64.1		66.1	
	327	160	326	160	326	160	326	160	326	160	328	160
	26.0	170	26.8	175	27.7	180	28.5	186	29.4	192	30.1	198
22.5	57.8		59.5		61.4		63.4		65.1		67.1	
	330	160	330	160	329	160	329	160	330	160	333	160
	25.7	170	26.5	175	27.3	180	28.2	186	29.1	192	29.7	198
TQ %						IAS						
KG/H/ENG						TAS						
NM/100KG												



AJR72
F.C.O.M.

SPECIAL OPERATIONS

FLIGHT WITH LANDING GEAR DOWN

3.11.01

P 11

500

JUN 97

AA

CRUISE 2 ENGINES												
ISA						160KT(IAS)						
WEIGHT (1000KG)	FLIGHT LEVEL											
	60		80		100		120		140		160	
13	47.7		48.9		50.4		52.0		53.5		55.1	
	297	160	292	160	290	160	288	160	287	160	287	160
	29.1	173	30.5	178	31.7	184	32.9	189	34.1	195	35.2	202
14	48.4		49.7		51.3		52.8		54.4		56.0	
	299	160	295	160	293	160	291	160	290	160	291	160
	28.9	173	30.2	178	31.4	184	32.5	189	33.7	195	34.7	202
15	49.2		50.6		52.2		53.8		55.4		57.0	
	302	160	298	160	296	160	295	160	294	160	295	160
	28.6	173	29.9	178	31.0	184	32.1	189	33.2	195	34.2	202
16	50.1		51.6		53.3		54.9		56.5		58.2	
	305	160	301	160	300	160	299	160	298	160	299	160
	28.3	173	29.6	178	30.6	184	31.7	189	32.8	195	33.7	202
17	51.2		52.8		54.5		56.1		57.7		59.5	
	309	160	306	160	305	160	304	160	303	160	305	160
	28.0	173	29.1	178	30.1	184	31.2	189	32.2	195	33.1	202
18	52.4		54.0		55.8		57.4		59.1		60.9	
	313	160	310	160	310	160	309	160	309	160	310	160
	27.6	173	28.7	178	29.6	184	30.6	189	31.6	195	32.5	202
19	53.7		55.3		57.1		58.8		60.6		62.4	
	317	160	316	160	315	160	315	160	315	160	317	160
	27.3	173	28.2	178	29.1	184	30.1	189	31.0	195	31.9	202
20	55.1		56.8		58.6		60.4		62.1		64.1	
	322	160	321	160	321	160	321	160	321	160	323	160
	26.8	173	27.7	178	28.6	184	29.5	189	30.4	195	31.2	202
21	56.5		58.3		60.2		62.0		63.8		65.8	
	327	160	327	160	328	160	327	160	328	160	331	160
	26.4	173	27.2	178	28.0	184	29.0	189	29.8	195	30.5	202
22	58.2		60.0		62.0		63.8		65.7		67.8	
	334	160	334	160	334	160	334	160	336	160	340	160
	25.9	173	26.7	178	27.5	184	28.3	189	29.1	195	29.7	202
22.5	59.1		60.9		62.9		64.8		66.7		68.9	
	337	160	338	160	338	160	338	160	340	160	345	160
	25.6	173	26.4	178	27.1	184	28.0	189	28.7	195	29.3	202
TQ %												
KG/H/ENG						IAS						
NM/100KG						TAS						

 AR72 F.C.O.M.	SPECIAL OPERATIONS				3.11.01		
	FLIGHT WITH LANDING GEAR DOWN				P 12	500	
							JUN 97

AA

CRUISE 2 ENGINES												
ISA+10 (°C)							160KT(IAS)					
WEIGHT (1000KG)	FLIGHT LEVEL											
	60		80		100		120		140		160	
13	48.5		50.0		51.6		53.2		54.8		56.5	
	302	160	298	160	296	160	295	160	295	160	295	160
	29.2	176	30.4	181	31.6	187	32.7	193	33.8	199	34.8	206
14	49.3		50.8		52.5		54.1		55.7		57.4	
	304	160	301	160	300	160	298	160	298	160	299	160
	28.9	176	30.1	181	31.2	187	32.3	193	33.4	199	34.4	206
15	50.2		51.7		53.4		55.0		56.7		58.5	
	307	160	304	160	303	160	302	160	302	160	303	160
	28.6	176	29.8	181	30.8	187	31.9	193	33.0	199	33.9	206
16	51.2		52.8		54.5		56.1		57.8		59.6	
	311	160	308	160	308	160	307	160	306	160	308	160
	28.3	176	29.5	181	30.4	187	31.5	193	32.5	199	33.3	206
17	52.3		54.0		55.7		57.4		59.1		61.0	
	315	160	313	160	312	160	312	160	312	160	314	160
	28.0	176	29.0	181	29.9	187	31.0	193	31.9	199	32.7	206
18	53.5		55.3		57.1		58.8		60.5		62.5	
	319	160	318	160	318	160	317	160	318	160	320	160
	27.6	176	28.6	181	29.4	187	30.4	193	31.3	199	32.1	206
19	54.8		56.6		58.5		60.2		62.0		64.0	
	324	160	323	160	323	160	323	160	324	160	327	160
	27.2	176	28.1	181	28.9	187	29.9	193	30.8	199	31.5	206
20	56.2		58.1		60.0		61.8		63.7		65.7	
	329	160	329	160	329	160	329	160	331	160	334	160
	26.8	176	27.6	181	28.4	187	29.3	193	30.1	199	30.8	206
21	57.8		59.7		61.6		63.4		65.4		67.6	
	334	160	335	160	336	160	336	160	338	160	342	160
	26.3	176	27.1	181	27.9	187	28.7	193	29.5	199	30.1	206
22	59.4		61.4		63.4		65.3		67.3			
	341	160	342	160	343	160	343	160	346	160		
	25.8	176	26.5	181	27.3	187	28.1	193	28.8	199		
22.5	60.3		62.3		64.4		66.3		68.4			
	345	160	346	160	347	160	348	160	350	160		
	25.5	176	26.2	181	27.0	187	27.8	193	28.4	199		
TQ % KG/H/ENG NM/100KG												
IAS TAS												

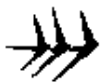

ATR 72
F.C.O.M.

SPECIAL OPERATIONS

FLIGHT WITH LANDING GEAR DOWN

3.11.01

P 13

500

JUN 97

AA

CRUISE 2 ENGINES												
ISA+20 (°C)						160KT(IAS)						
WEIGHT (1000KG)	FLIGHT LEVEL											
	60		80		100		120		140		160	
13	49.6		51.2		52.7		54.4		56.1		58.0	
	307	160	304	160	303	160	302	160	302	160	304	160
	29.1	179	30.3	185	31.5	190	32.5	196	33.5	203	34.4	209
14	50.4		52.0		53.6		55.3		57.0		58.9	
	310	160	307	160	306	160	306	160	306	160	308	160
	28.9	179	30.0	185	31.1	190	32.2	196	33.1	203	34.0	209
15	51.3		53.0		54.6		56.3		58.1		60.0	
	313	160	311	160	310	160	310	160	310	160	313	160
	28.6	179	29.7	185	30.7	190	31.7	196	32.7	203	33.5	209
16	52.3		54.0		55.7		57.4		59.2		61.2	
	317	160	315	160	314	160	314	160	315	160	318	160
	28.3	179	29.3	185	30.3	190	31.3	196	32.2	203	33.0	209
17	53.4		55.2		56.9		58.7		60.5		62.6	
	321	160	320	160	319	160	319	160	320	160	324	160
	27.9	179	28.9	185	29.8	190	30.8	196	31.6	203	32.3	209
18	54.7		56.6		58.3		60.1		62.0			
	325	160	325	160	325	160	325	160	327	160		
	27.5	179	28.4	185	29.3	190	30.2	196	31.0	203		
19	56.0		58.0		59.7		61.5		63.5			
	330	160	331	160	331	160	331	160	333	160		
	27.1	179	27.9	185	28.8	190	29.7	196	30.4	203		
20	57.5		59.5		61.3		63.1		65.2			
	336	160	337	160	337	160	337	160	340	160		
	26.7	179	27.4	185	28.3	190	29.1	196	29.8	203		
21	59.0		61.1		62.9		64.8					
	342	160	343	160	344	160	344	160				
	26.2	179	26.9	185	27.7	190	28.5	196				
22	60.8		62.8		64.7		66.7					
	349	160	350	160	351	160	353	160				
	25.7	179	26.4	185	27.1	190	27.9	196				
22.5	61.7		63.8		65.8							
	353	160	354	160	355	160						
	25.4	179	26.1	185	26.8	190						
TQ %						IAS						
KG/H/ENG						TAS						
NM/100KG												

	SPECIAL OPERATIONS FLIGHT WITH LANDING GEAR DOWN	3.11.01		
		P 14	500	
				JUN 97

AA

HOLDING 2 ENGINES					
ISA					VMHB0
WEIGHT (1000KG)	FLIGHT LEVEL				
	15	50	100	150	
13	31.2	32.1	33.5	35.7	
	253	239	224	216	
	131	131	132	132	
14	34.1	35.0	37.0	39.5	
	264	250	238	230	
	136	136	137	137	
15	37.0	38.2	40.6	43.5	
	274	261	251	246	
	141	141	141	142	
16	40.1	41.6	44.2	47.8	
	285	274	265	262	
	146	146	146	146	
17	43.2	45.1	48.1	52.2	
	296	288	280	279	
	150	151	151	151	
18	46.7	48.7	52.2	56.5	
	310	302	296	296	
	155	155	155	155	
19	50.3	52.3	56.6	61.0	
	324	317	313	314	
	159	159	159	159	
20	53.9	56.4	61.0	65.7	
	338	332	330	333	
	163	163	163	164	
21	57.6	60.6	65.4	70.6	
	353	348	347	353	
	167	167	167	168	
22	61.6	65.0	69.9	75.7	
	368	365	365	376	
	171	171	171	172	
22.5	63.7	67.2	72.2		
	375	374	374		
	173	173	173		
TQ KG/H/ENG IAS					

 ATR 72 F.C.O.M.	SPECIAL OPERATIONS		3.11.01		
	FLIGHT WITH LANDING GEAR DOWN		P 15	500	
					JUN 97

AA

DESCENT 2 ENGINES								
ISA		160KT (IAS)						
FL	WEIGHT (1000KG)							
	14	15	16	17	18	19	20	21
160	6 19 18	7 21 19	7 22 20	7 22 21	7 23 22	8 24 23	8 25 24	8 25 24
140	5 17 16	6 18 17	6 19 17	6 20 18	6 20 19	7 21 19	7 22 20	7 22 21
120	4 14 13	5 15 14	5 16 14	5 17 15	5 17 16	6 18 16	6 18 17	6 19 17
100	4 12 10	4 12 11	4 13 11	4 14 12	4 14 12	4 15 13	5 15 13	5 15 14
80	3 9 8	3 10 8	3 10 8	3 11 9	3 11 9	3 11 10	4 12 10	4 12 10
60	2 6 5	2 7 5	2 7 6	2 7 6	2 8 6	2 8 6	2 8 7	2 8 7
40	1 4 3	1 4 3	1 4 3	1 4 3	1 4 3	1 4 4	1 5 4	1 5 4
15	0 0 0	0 0 0	0 0 0	0 0 0	0 0 0	0 0 0	0 0 0	0 0 0
FROM START OF DESCENT TIME (MIN)						FUEL (KG)		
FROM START OF DESCENT DIST (NM)								



ATR 72
F.C.O.M.

SPECIAL OPERATIONS

DISPATCH WITH FLAPS RETRACTED

3.11.02

P 1

001

JUN 97

AA

R • Refer to the AFM supplements (7.02.03), or use the FOS.



ATR 72
F.C.O.M.

SPECIAL OPERATIONS

3.11.03

P 1

100

DISPATCH WITH ANTISKID INOPERATIVE

JUN 97

- Refer to the MMEL for the operating procedures.

TAKE-OFF

- Enter the quick reference tables with a corrected runway length reduced by 400 m.

LANDING

- Multiply landing distance by 1.4.

R

 ATR 72 F.C.O.M.	SPECIAL OPERATIONS DISPATCH WITH AUTOFEATHER SYSTEM INOPERATIVE	3.11.04		
		P 1	200	
				JUL 99

AA

- Refer to the MMEL for the operating procedures.

TAKE-OFF

- Increase V_1 limited by VMCG by 5 kt.
- Increase V_R by 2 kt.
- Increase VMCA by 3 kt.
- Enter the quick reference tables with a runway length reduced by 60%.
- Decrease the maximum second segment weight by :

MAXIMUM 2nd SEGMENT WEIGHT	CORRECTIONS
27 000 kg (59 520 lb)	4 000 kg (8 800 lb)
23 000 kg (50 700 lb)	3 400 kg (7 500 lb)
19 000 kg (41 900 lb)	2 800 kg (6 200 lb)

LANDING

- Increase VMCL by 3 kt.

	SPECIAL OPERATIONS DISPATCH WITH EEC OFF	3.11.05		
		P 1	200	
				JUN 97

AA

TAKE-OFF

- Refer to the MMEL for the operating procedures.
- Take-off must be performed with BLEED VALVES OFF and ATPCS OFF.
- Increase V_1 limited by VMCG by 5 kt.
- Increase V_R by 2 kt.
- Increase VMCA by 3 kt.
- Enter the quick reference tables with a runway length reduced by 65%.
- Decrease the maximum second segment weight by the following values, taking into account the ATPCS OFF effect :

MAXIMUM 2nd SEGMENT WEIGHT	CORRECTIONS
27 000 kg (59 520 lb)	5 300 kg (11 700 lb)
23 000 kg (50 700 lb)	4 500 kg (9 900 lb)
19 000 kg (41 900 lb)	3 600 kg (7 950 lb)

	SPECIAL OPERATIONS DISPATCH WITH ONE AFU INOPERATIVE	3.11.06		
		P 1	001	
				JUN 97

AA

- Refer to the Dispatch with ATPCS OFF (3.11.08)



ATR 72
F.C.O.M.

SPECIAL OPERATIONS
DISPATCH WITH ONE TO
INDICATOR INOPERATIVE

3.11.07

P 1

001

JUL 98

AA

R • Refer to the MEL.

	SPECIAL OPERATIONS DISPATCH WITH ATPCS OFF	3.11.08		
		P 1	200	
				JUN 97

AA

- Refer to the MMEL for the operating procedures.

TAKE-OFF

- Select ATPCS OFF and BLEED VALVES OFF
- Increase V_1 limited by VMCG by 5 kt.
- Increase V_R by 2 kt.
- Increase VMCA by 3 kt.
- Enter the quick reference tables with a runway length reduced by 60%.
- Decrease the maximum 2nd segment weight by :

MAXIMUM 2nd SEGMENT WEIGHT	CORRECTIONS
27 000 kg (59 520 lb)	4 000 kg (8 800 lb)
23 000 kg (50 700 lb)	3 400 kg (7 500 lb)
19 000 kg (41 900 lb)	2 800 kg (6 200 lb)

LANDING

- Decrease VMCL by 3 kt.



ATR 72
F.C.O.M.

SPECIAL OPERATIONS

ETOPS

3.11.09

P 1

001

DEC 97

NOT ALLOWED

 ATR 72 F.C.O.M.	SPECIAL OPERATIONS OPERATIONS ON NARROW RUNWAYS	3.11.10		
		P 1	001	
				DEC 95

NOT ALLOWED

	SPECIAL OPERATIONS DRY UNPAVED RUNWAYS	3.11.11		
		P 1	001	
				DEC 96

NOT ALLOWED

 ATR 72 F.C.O.M.	OPERATIONS ENGINEERING BULLETINS CONTENTS	3.12.00		
		P 1	001	
				DEC 89

AA

- 3.12.00 CONTENTS**
- 3.12.10 GENERAL DESCRIPTION**
- 3.12.20 LIST OF EFFECTIVE O.E.B**

	OPERATIONS ENGINEERING BULLETINS	3.12.10		
		P 1	001	
	GENERAL DESCRIPTION			JUN 97

AA

R Operations Engineering Bulletins (O.E.B.) are issued as the need arises to transmit in advance technical and procedural information before the next normal revision of the Flight Crew Operating Manual. They are distributed to all FCOM holders and to others who need early advice of changes to operational information.

R Information in these bulletins is responsibility of Aerospatiale Flight Test Department.

In case of conflict with the certified Flight Manual, the latter will supersede.

	OPERATIONS ENGINEERING BULLETINS	3.12.20		
		P 1	001	
	LIST OF EFFECTIVE PAGES (O.E.B)			

AA

O.E.B. No/ISSUE	DATE	SUBJECT	VALIDITY
01/02	15 NOV 89	MFC : Loss of 2d B module	CANCELLED BY MOD 2450
02/01	18 MAR 91	AP / YD operation	CANCELLED
03/01	16 NOV 93	UNDUE GPWS WARNING	CANCELLED BY MOD 3876
04/01	09 JAN 95	KLN 90 A GPS operation	
05/01	NOV 95	(on ground) propeller brake and engine shut off procedure	CANCELLED BY : - Mod 4571 for models 211-212 - Mod 4599 for models 201-202
06/01	DEC 95	Mechanical failure of the elevators connecting axle	CANCELLED by mod 4495
07/01	JUL 97	PEC OFF operations	CANCELLED by mod 4883
08/01	OCT 97	GNSS HT 1000 operation	CANCELLED by mod 4885
09/01	OCT 97	VHF INTERFERENCES ON GNSS HT 1000	CANCELLED by mod 4885
R 10/02	DEC 98	KLN 90 B GPS operation	All aircraft fitted with MOD 4890 or 5022

AA

SUBJECT : MFC - LOSS OF A SECOND B MODULE**1 - Reason for issue**

Warning to crews before applying a modification.

2 - Background information

The centralizing function of warning, particularly the "MASTER CAUTION" light flashing is performed by modules 1B and 2B of MFC.

The loss of a B module therefore is normally indicated by

- the local MFC Fault amber light,
- the MFC amber light on CAP,
- single chime (SC),
- and the MC light flashing, (a function done by the second B module),

Before applying a modification, in case of loss of this second B module, the MC light no longer flashes.

3 - ATR action

A modification is already defined by the necessary equipment was not available at the time of aircraft delivery. Planned date : December 89.

4 - Procedure (Pending application of modification 2450)

After the loss of a MFC B module, crewmembers must be told that whenever the MC illuminates without flashing, it means they have lost their second B module.



AA

SUBJECT : AP/YD OPERATION**1 - Reason for Issue**

Sustained lateral oscillations (shudder) have been encountered on the ATR 72 aircraft when flying in heavy turbulence, with the YAW DAMPER engaged.

2 - Background information

The oscillation appears to be induced by coupling in the yaw damper overall control loop. The amplitude of the oscillation may be uncomfortable to passengers but associated rudder deflections remain limited to values acceptable from a structural point of view.

The oscillations have only been reported at low altitude, low airspeed, flaps extended.

The oscillations stop as soon as the yaw damper is disengaged.

3 - ATR action

HONEYWELL has been advised of this problem. An auto pilot modification has been identified to eliminate the oscillation. This modification will be available no later than Autumn 1991.

4 - Procedure

- Whenever sustained oscillations occur in the yaw axis, disengage the yaw damper.
- The yaw damper may be reengaged when clear of turbulence or above 180 kts
- This procedure will remain in effect until the modified auto pilot is installed on the aircraft.



AA

SUBJECT : MECHANICAL FAILURE OF THE ELEVATORS CONNECTING AXLE**1 - Reason for issue**

Four cases of mechanical failure of the elevators connecting axle have been encountered.

2 - Background information

This failure causes an actual elevators disconnection, similar in its consequences, to the disconnection through the pitch disconnect clutch mechanism, although not monitored by the "PITCH DISCONNECT" red alert.

This event is identified by dissimilar control columns positions and/or movements.

3 - ATR action

A modification of the mentioned axle is in progress and will be retrofitted current year 1996.

4 - Procedure

If an inadvertent elevators disconnection is identified in the absence of any corresponding warning :

- on ground : cancel the revenue flight (apply ferry flight procedure if necessary as described in AFM supplement chapter 7-02)
- in flight : reduce speed to 180 kt and apply "PITCH DISCONNECT " procedure.

	OPERATIONS ENGINEERING BULLETINS O.E.B. N°7 DESCRIPTION	3.12.27		
		P 1	001	
				JUL 97

AA

SUBJECT : PEC OFF operations

1. REASON FOR ISSUE

In the PEC OFF condition, if the NP becomes inferior to 77% at idle power, the engine eventually will not spool up when advancing the power lever.

2. BACKGROUND

$N_p < 77\%$ at idle power is never reached at normal operating speeds, therefore this problem could only be met in training flights during stall exercises or touch and go maneuvers.

3. ATR ACTION

A system modification will be implemented no later than january 98.

4. PROCEDURES

- Flight at airspeeds inferior to 90kt is prohibited in the PEC OFF condition
- Training : In the PEC OFF condition touch and go and stall maneuvers are prohibited.

Validity : For model 212A
